

# HP StorageWorks

## Command View XP User Guide for XP Disk Arrays

## Legal and notice information

© Copyright 1995–2005 Hewlett-Packard Development Company, L.P.

Hewlett-Packard Company makes no warranty of any kind with regard to this material, including, but not limited to, the implied warranties of merchantability and fitness for a particular purpose. Hewlett-Packard shall not be liable for errors contained herein or for incidental or consequential damages in connection with the furnishing, performance, or use of this material.

This document contains proprietary information, which is protected by copyright. No part of this document may be photocopied, reproduced, or translated into another language without the prior written consent of Hewlett-Packard. The information is provided "as is" without warranty of any kind and is subject to change without notice. The only warranties for HP products and services are set forth in the express warranty statements accompanying such products and services. Nothing herein should be construed as constituting an additional warranty. HP shall not be liable for technical or editorial errors or omissions contained herein.

Java™ is a U.S. trademark of Sun Microsystems, Inc.

Microsoft®, MS-DOS®, MS Windows®, and Windows® are U.S. registered trademarks of Microsoft Corporation.

Oracle® is a registered U.S. trademark of Oracle Corporation, Redwood City, California.

UNIX® is a registered trademark of The Open Group.

Printed in the U.S.A.

Command View XP for XP Disk Arrays User Guide

# Contents

About this guide . . . . .	35
Intended audience . . . . .	35
Prerequisites . . . . .	35
Related documentation . . . . .	35
Document conventions and symbols . . . . .	36
HP technical support . . . . .	37
HP-authorized reseller . . . . .	37
Helpful web sites . . . . .	37
1 Getting started . . . . .	39
Host agents . . . . .	39
Host operating systems . . . . .	39
Integrating with other applications . . . . .	39
Features . . . . .	40
Communicating with the disk arrays . . . . .	42
XP128/XP1024/XP12000 . . . . .	42
XP48/XP512 . . . . .	42
Starting Command View from a browser . . . . .	42
Default user names and passwords . . . . .	43
Default administrator . . . . .	43
Default user . . . . .	43
Default storage administrator . . . . .	43
Specifications and restrictions for logon operations . . . . .	44
Starting Command View from Storage Area Manager . . . . .	44
Command View main window . . . . .	45
Using the backup utility . . . . .	45
Saving data . . . . .	45
Restoring data . . . . .	46
Saving or restoring data from the Windows command line . . . . .	46
2 Array manager . . . . .	47
Device Launcher . . . . .	47
Launching a disk array . . . . .	48
Device Administration . . . . .	48
Accessing Device Administration . . . . .	49
Display . . . . .	49
Adding or registering a disk array . . . . .	50
To add or register a disk array: . . . . .	50
Deleting or unregistering a disk array . . . . .	51
To delete or unregister a disk array: . . . . .	51
Changing disk array parameters . . . . .	51
To change the disk array parameters: . . . . .	51
Viewing device history . . . . .	51
To view recent device administration events: . . . . .	51
Setting SNMP IP Security (XP48/XP512 only) . . . . .	52
Use SNMP IP Security to perform the following tasks: . . . . .	52
Disabling SNMP IP Security . . . . .	52
Accessing SNMP IP Security . . . . .	53
To access SNMP IP Security: . . . . .	53
Adding SNMP IP Security . . . . .	53
To add SNMP IP Security: . . . . .	53

Removing SNMP IP Security . . . . .	53
To remove SNMP IP Security: . . . . .	53
Session Administration . . . . .	53
Accessing Session Administration . . . . .	54
Display . . . . .	54
GUI and CLI sessions . . . . .	54
Viewing GUI sessions (XP128/XP1024/XP12000) . . . . .	55
Ending a session (XP48/XP512) . . . . .	55
Ending a session (XP128/XP1024/XP12000) . . . . .	55
To end a GUI session: . . . . .	55
Changing the session timeout value. . . . .	56
To change the session timeout value. . . . .	56
<b>3 Security system . . . . .</b>	<b>57</b>
Accessing security . . . . .	57
CV security system . . . . .	58
Default users . . . . .	58
User groups . . . . .	58
Rules for user names and passwords . . . . .	61
Viewing and modifying users . . . . .	62
Adding a user . . . . .	63
To add a new user: . . . . .	63
Changing a user's password. . . . .	64
To change a user's password: . . . . .	64
Deleting a user . . . . .	65
To delete a user: . . . . .	65
Determining or modifying array/partition membership . . . . .	65
To view or change array/partition membership: . . . . .	66
Viewing and modifying groups . . . . .	67
Groups tab . . . . .	67
To view group properties . . . . .	67
<b>4 Application Administration . . . . .</b>	<b>69</b>
Accessing Application Administration . . . . .	69
Display . . . . .	69
Installed Command View Software section: . . . . .	69
User-Defined Applications section: . . . . .	70
Adding Applications . . . . .	70
Deleting Applications . . . . .	71
Editing Application Information . . . . .	71
<b>5 Support . . . . .</b>	<b>73</b>
Accessing the Support pane. . . . .	73
Using the Support pane. . . . .	73
<b>6 Licenses . . . . .</b>	<b>75</b>
Managing license keys . . . . .	75
Types of license keys . . . . .	75
Accessing License Key Management. . . . .	76
Installing a license key . . . . .	77
Uninstalling a license key . . . . .	79
<b>7 Array event history . . . . .</b>	<b>81</b>
Using Array Event History . . . . .	81
Display. . . . .	81
<b>8 Event notification. . . . .</b>	<b>83</b>
Accessing Event Notification . . . . .	83



Configuring event history settings . . . . .	84
Specifying the e-mail server for e-mail notifications . . . . .	84
Configuring e-mail notifications . . . . .	85
Adding an e-mail notification . . . . .	86
Editing or deleting an e-mail notification . . . . .	86
Configuring script notifications . . . . .	86
Adding a script notification . . . . .	87
Editing or deleting a script notification . . . . .	87
Configuring SNMP notifications . . . . .	87
Adding an SNMP notification . . . . .	89
Editing or deleting an SNMP notification . . . . .	89
Managing the notification schedule. . . . .	89
Creating a notification schedule . . . . .	90
Editing or deleting a notification schedule. . . . .	90
Viewing a list of configured notifications . . . . .	90
Viewing event history . . . . .	91
Viewing notification history . . . . .	92
Deleting history events. . . . .	93
Deleting individual events . . . . .	93
Clearing the history log file . . . . .	93
Testing event notification . . . . .	93
Testing array event notification . . . . .	94
Testing Path Connectivity event notification . . . . .	94
<b>9 Identity . . . . .</b>	<b>97</b>
Accessing identity information . . . . .	97
Display for XP48/XP512 . . . . .	97
Display for XP128/XP1024/XP12000 . . . . .	98
Using the Identity pane (XP128/XP1024/XP12000). . . . .	100
Audit Log file (XP12000 only) . . . . .	101
To download the audit log file: . . . . .	102
Basic information . . . . .	115
Port pane . . . . .	116
LUN pane . . . . .	117
LDEV pane . . . . .	118
Displaying the detailed information on the LUSE volume . . . . .	119
Control Panel (XP128/XP1024/XP12000) . . . . .	120
User Entry tab. . . . .	120
Set Env tab. . . . .	121
Setting the Command View environment parameters . . . . .	123
Log tab (XP128/XP1024 only) . . . . .	123
To view Log Information: . . . . .	124
Download Tab (XP128/XP1024 only) . . . . .	124
To download Log Information: . . . . .	125
<b>10 Status monitoring XP48/XP512 . . . . .</b>	<b>127</b>
Accessing the Status pane . . . . .	127
Status Overview pane . . . . .	127
LDevs column . . . . .	128
Luns column . . . . .	128
Tables . . . . .	128
Port/LUN Map pane . . . . .	128
Ldev/Port Map pane . . . . .	129
ACP/Ldev Map pane . . . . .	130
Ports pane . . . . .	131
Device Health pane . . . . .	132
Device status . . . . .	132
LUN Security pane . . . . .	133
Cache LUN pane . . . . .	134

VSC pane . . . . .	135
Parity Group pane . . . . .	136
<b>11 Status monitoring for the XP128/XP1024/XP12000 . . . . .</b>	<b>139</b>
Accessing the Status pane . . . . .	139
Viewing status details . . . . .	140
<b>12 System for the XP12000 . . . . .</b>	<b>141</b>
Viewing the equipment information of the system . . . . .	141
Base information . . . . .	141
Port status . . . . .	141
<b>13 Disk/Cache Partition for the XP12000 . . . . .</b>	<b>143</b>
Disk/Cache Partition features . . . . .	143
Storage management logical partitions (SLPRs) . . . . .	143
Cache logical partitions (CLPRs) . . . . .	144
Partition administration and administrator rights . . . . .	145
Accessing Disk/Cache Partition . . . . .	147
Working with SLPRs . . . . .	149
Administering SLPRs . . . . .	150
Creating SLPRs . . . . .	151
Deleting SLPRs . . . . .	151
Migrating SLPR resources . . . . .	151
Displaying error messages . . . . .	152
Working with CLPRs . . . . .	152
Creating CLPRs . . . . .	153
Deleting CLPRs . . . . .	154
Migrating parity groups across CLPRs . . . . .	154
Notes, restrictions, and requirements . . . . .	154
SLPRs . . . . .	154
CLPRs . . . . .	155
<b>14 LUN Management for the XP48/XP512 . . . . .</b>	<b>157</b>
Starting LUN Management . . . . .	157
View/Delete LUNs: Viewing FC path information . . . . .	157
Accessing FC path information . . . . .	157
Viewing path information for a port . . . . .	158
Viewing path information for a volume . . . . .	158
View/Delete LUNs: Deleting FC paths . . . . .	158
Add Path: FC paths . . . . .	158
Adding FC paths . . . . .	159
LUN Size Expansion (LUSE) . . . . .	160
LUN expansion functions . . . . .	160
LUN size limitations . . . . .	160
Starting LUN size expansion . . . . .	161
Details . . . . .	161
Viewing expanded LUN information: Detail pane . . . . .	162
Creating expanded LUNs (continuous) . . . . .	163
Details . . . . .	163
Procedure . . . . .	163
Creating expanded LUNs (dispersed) . . . . .	164
Details . . . . .	164
Procedure . . . . .	164
Host modes . . . . .	165
Viewing the host mode configuration . . . . .	165
Setting or changing the host mode . . . . .	166
Configuring Fibre Channel ports . . . . .	167
Viewing the Fibre Channel port configuration . . . . .	167

Setting or changing Fibre Channel port addresses . . . . .	167
Setting or changing Fibre Channel port topology . . . . .	168
Volume size configuration . . . . .	169
VSC functions . . . . .	169
VSC limitations . . . . .	170
VSC specifications . . . . .	170
Starting VSC . . . . .	172
Details . . . . .	172
Converting volumes to space (volume to space) . . . . .	172
Details . . . . .	172
Procedure . . . . .	173
Installing custom volumes . . . . .	173
Setting the LDEV ID . . . . .	174
Deinstalling custom volumes . . . . .	175
Converting a VSC volume to a normal volume (volume initialize) . . . . .	175
Operational restrictions . . . . .	176

## 15 LUN Management for the XP128/XP1024/XP12000 . . . . . 179

LU configuration overview . . . . .	179
Fibre Channel environment . . . . .	179
iSCSI environment . . . . .	179
NAS environment . . . . .	179
Supported emulation types . . . . .	179
LU paths . . . . .	179
Configuring LU paths in a Fibre Channel environment . . . . .	180
Host storage domains . . . . .	180
Configuring LU paths in a NAS environment (XP128/XP1024 only) . . . . .	182
16-Port FC/CA CHIP product . . . . .	183
Host groups . . . . .	184
Host modes . . . . .	186
LUN Security . . . . .	187
RAID Manager command devices . . . . .	188
Restrictions . . . . .	188
Fibre Channel port attributes . . . . .	188
Fibre Channel topologies . . . . .	188
Arbitrated loop physical addresses . . . . .	189
Data transfer speed for Fibre Channel ports . . . . .	190
Standard, high-speed, and high-speed (2 port) modes . . . . .	190
iSCSI environments (XP128/XP1024 only) . . . . .	191
Configuring an iSCSI environment . . . . .	191
iSCSI port settings and iSNS server settings . . . . .	191
Checking the status of the connection between hosts and the disk subsystem . . . . .	193
User authentication (iSCSI environments only) . . . . .	193
User authentication operations and settings . . . . .	193
Host authentication . . . . .	194
Port authentication (performing mutual authentication) . . . . .	197
LUN Management operations . . . . .	197
Starting LUN Management . . . . .	197
LUN Management main pane . . . . .	197
LU Path tree . . . . .	198
Fibre Channel folder . . . . .	198
NAS folder (XP128/XP1024 only) . . . . .	198
iSCSI folder . . . . .	199
LU Path table . . . . .	200
WWN or iSCSI name table . . . . .	201
LDEV table . . . . .	201
Buttons . . . . .	202
Defining LU paths . . . . .	202
Creating host groups . . . . .	203

Registering hosts in host groups . . . . .	204
To register hosts in a host group: . . . . .	205
Associating host groups to logical volumes. . . . .	207
Changing or viewing LU path settings . . . . .	207
Deleting LU paths . . . . .	207
Changing the name and host mode of a host group . . . . .	208
Deleting host groups . . . . .	209
Initializing the host group 0 (zero) . . . . .	209
Changing WWNs, iSCSI names, and nicknames . . . . .	209
Deleting HBAs from host groups . . . . .	211
Deleting unneeded WWNs from the WWN table . . . . .	211
Viewing a list of concatenated parity groups . . . . .	212
Defining alternate paths . . . . .	212
Copying paths from one Fibre Channel or iSCSI port to another. . . . .	212
Copying paths from one NAS port to another (XP128/XP1024 only) . . . . .	213
Copying paths from a Fibre Channel or iSCSI port to a NAS port. . . . .	213
Copying paths from a NAS port to a Fibre Channel or iSCSI port. . . . .	214
Viewing alternate paths . . . . .	214
Deleting WWNs . . . . .	215
Applying and removing LUN security . . . . .	215
Creating RAID Manager Command Devices . . . . .	216
Setting an LU as a command device . . . . .	216
Stopping the use of an LU as a command device . . . . .	216
Applying command device security . . . . .	216
Removing command device security . . . . .	216
Port Operations . . . . .	216
Starting Port Operations . . . . .	216
Port tab . . . . .	217
Package tree . . . . .	217
Port table . . . . .	218
iSCSI Function box . . . . .	218
Change Port Mode box . . . . .	219
Setting the Fibre Channel Topology . . . . .	219
Setting Fibre Channel Port Addresses . . . . .	219
Setting the Data Transfer Speed. . . . .	219
Switching to standard, high-speed, or high-speed (2 port) mode . . . . .	219
Configuring iSCSI Ports . . . . .	220
Making settings on iSCSI ports and iSNS servers . . . . .	220
Removing information about an iSCSI port from an iSNS server . . . . .	221
Checking the status of connection between hosts and the disk array (iSCSI environment only) . . . . .	221
Issuing a ping command from an iSCSI port to a host . . . . .	221
Setting user authentication (iSCSI environments only) . . . . .	222
Starting User Authentication Operations . . . . .	222
User Authentication tab . . . . .	222
Port tree. . . . .	222
User Information (Host) table . . . . .	223
User Information (Port) table . . . . .	223
Buttons . . . . .	224
Specifying whether to enable or disable host authentication on a port . . . . .	224
Registering user information of hosts on a port . . . . .	224
Changing user information of hosts . . . . .	226
Deleting user information of hosts . . . . .	226
Specifying user information of ports (when performing mutual authentication) . . . . .	227
Clearing user information of ports (when performing mutual authentication) . . . . .	228
Relationship between port settings and connection results . . . . .	228
Operational restrictions . . . . .	229
Restrictions on LUN Management operations . . . . .	229
Restrictions on port operations. . . . .	230

<b>16LUN Security for the XP48/XP512</b> .....	<b>231</b>
Starting LUN Security .....	231
Enabling and disabling LUN Security .....	232
Defining LUN Security .....	233
Changing LUN Security parameters .....	233
Changing WWN access to a LUN .....	234
Creating a LUN group .....	234
Changing LUN Group Information .....	234
Creating or changing a LUN group nickname .....	235
Adding a new WWN .....	235
Creating a WWN Group .....	236
Deleting a WWN or WWN Group .....	237
Updating WWNs and Nicknames .....	237
Changing WWN group members .....	238
<b>17Volume Management for the XP128/XP1024/XP12000</b> .....	<b>241</b>
Volume Management (LU Size Expansion) .....	241
Drawbacks .....	241
LUSE rules .....	241
LUSE operations that handle a path-defined LDEV .....	242
Volume Size Configuration (VSC) .....	243
VSC operations .....	243
Parity group configuration .....	244
Volume to Space operation .....	245
Restrictions .....	246
Install Custom Volume (CV) operation .....	246
Volume Initialize and Make Volume operations .....	248
Restrictions .....	249
LUSE operations .....	249
Starting LUSE operations .....	249
Volume Management pane .....	250
LDEV Information tree .....	250
LDEV Information table .....	250
Select an LDEV list .....	251
Volume Count list .....	251
Free LDEVs table .....	252
Expanded LDEVs list .....	252
Buttons .....	252
Viewing LUSE Configuration Information .....	252
Viewing Concatenated Parity Groups .....	253
Creating a LUSE volume using the Volume Count list .....	253
Creating a LUSE volume using the Select an LDEV list .....	254
Creating a LUSE volume using the LDEV information table .....	254
Releasing a LUSE volume .....	255
Changing LUSE capacities .....	256
Resetting an unregistered LUSE volume .....	256
VSC Operations .....	257
Starting VSC operations .....	257
Customized volume screen .....	257
Parity Group - LDEV tree .....	257
Parity Group - LDEV table .....	258
Capacity unit list .....	259
Buttons .....	259
Viewing VSC configuration information .....	259
Viewing concatenated parity groups .....	259
Converting volumes to space (Volume to Space) .....	260
Creating custom volumes (Install CV) .....	261
Deleting custom volumes (Volume to Space) .....	268

Creating initial custom volumes for OPEN-V (Make Volume) . . . . .	268
Initializing custom volumes for other than OPEN-V (Volume Initialize) . . . . .	273
Formatting LDEVs . . . . .	277
Formatting all blocked volumes . . . . .	277
Operational restrictions . . . . .	278
Restrictions on VSC and LUSE operations . . . . .	278
Data Shredder . . . . .	278
Overview of Shredding operations . . . . .	279
Target volumes for Shredding operations . . . . .	279
Preparing to use Data Shredder . . . . .	280
Starting Data Shredder . . . . .	280
Shredding Param pane . . . . .	280
Confirmation pane for completing Shredding operations . . . . .	281
Shredding operations . . . . .	282
Preparing for Shredding operations . . . . .	282
Defining Shredding operation settings . . . . .	282
Deleting data on volumes (Shredding) . . . . .	283
Canceling Shredding operations . . . . .	284

## 18 LUN Security Extension for the XP128/XP1024/XP12000 . . . . . 285

Assigning access attributes to logical volumes . . . . .	285
Restricting read and write operations . . . . .	285
Using LUN Security Extension with other products . . . . .	287
Starting LUN Security Extension . . . . .	288
LUN Security Extension pane . . . . .	289
Term Setting dialog box . . . . .	291
Volume Detail dialog box . . . . .	291
Error Detail pane . . . . .	292
Using LUN Security Extension . . . . .	292
Changing access attributes of logical volumes . . . . .	292
Modifying the retention term . . . . .	293
Prohibiting changes to Read/Write volumes after the retention term ends . . . . .	293
Protecting logical volumes against CA and BC . . . . .	294
Protecting a Read/Write logical volume against CA and BC operations . . . . .	294
Preventing Command View users from configuring LU paths and command devices . . . . .	295
Viewing a list of logical volumes combined into a LUSE volume . . . . .	295
Troubleshooting LUN Security Extension XP . . . . .	296

## 19 Configuration File Loader for the XP128/XP1024/XP12000 . . . . . 299

Working with Configuration File Loader . . . . .	299
Requirements for Configuration File Loader . . . . .	299
Configuration File Loader components . . . . .	299
Using the Configuration File Loader pane . . . . .	300
Using the spreadsheet file . . . . .	300
Configuration File Loader tasks . . . . .	301
Spreadsheet type and available function . . . . .	301
Spreadsheet software requirements . . . . .	302
Opening the spreadsheet file . . . . .	302
To open the spreadsheet file in Microsoft Excel 2000: . . . . .	302
Closing the spreadsheet file . . . . .	303
Starting Configuration File Loader . . . . .	303
To access Configuration File Loader: . . . . .	303
Configuration File Loader pane . . . . .	304
Spreadsheet rules and formats . . . . .	305
Spreadsheet file rules . . . . .	306
Spreadsheet components . . . . .	307
Spreadsheet declaration . . . . .	307
Function tag . . . . .	307
Configuration definition (settings) . . . . .	308

Comments . . . . .	309
Writing the configuration definition . . . . .	309
Configuration definition types . . . . .	310
Configuration definition format . . . . .	310
Influences of new settings on other settings . . . . .	310
LUN Manager spreadsheet . . . . .	311
Port settings . . . . .	312
CHA mode settings . . . . .	313
Host group settings . . . . .	314
WWN settings . . . . .	315
Path settings . . . . .	316
Command device settings . . . . .	316
Using Configuration File Loader . . . . .	317
To use Configuration File Loader: . . . . .	317
Exporting a spreadsheet file . . . . .	317
To export the spreadsheet file: . . . . .	317
Editing a spreadsheet file . . . . .	318
To edit the spreadsheet file: . . . . .	318
Importing a spreadsheet file . . . . .	319
To import the spreadsheet file: . . . . .	320
Spreadsheet error checking . . . . .	320
First check . . . . .	320
Second check . . . . .	321
Third check . . . . .	321

## 20Cache LUN for the XP48/XP512 . . . . . 323

Supported volumes . . . . .	323
Cache LUN tasks . . . . .	323
Supported emulation types and other parameters . . . . .	323
Supported emulation types . . . . .	323
Modified volume types . . . . .	324
Unit of cache area allocation . . . . .	324
Restrictions . . . . .	324
Configuration Restrictions . . . . .	324
Usage Restrictions . . . . .	324
VSC Automatic Resets . . . . .	324
Cache LUN modes . . . . .	325
Priority mode . . . . .	325
Priority mode details . . . . .	325
General cache capacity . . . . .	325
Bind mode . . . . .	325
Bind mode details . . . . .	325
Bind mode and RAID groups . . . . .	325
Starting Cache LUN . . . . .	326
Cache LUN pane . . . . .	326
Setting (creating) a cache extent . . . . .	326
To place data in cache . . . . .	326
Releasing (removing) a cache extent . . . . .	328
To remove data from cache . . . . .	328
Changing an extent's mode . . . . .	328

## 21Cache LUN for the XP128/XP1024/XP12000 . . . . . 329

Supported volumes . . . . .	329
Cache LUN tasks . . . . .	329
Supported Emulation Types and Other Parameters . . . . .	330
Supported emulation types . . . . .	330
Modified volume types . . . . .	330
Unit of cache area allocation . . . . .	330
Number of cache areas allowed . . . . .	330

Restrictions . . . . .	330
Configuration Restrictions . . . . .	330
Usage Restrictions . . . . .	331
VSC Automatic Resets . . . . .	331
Cache LUN modes . . . . .	331
Priority mode . . . . .	331
Priority mode details. . . . .	331
General cache capacity . . . . .	331
Bind mode . . . . .	332
Bind mode details . . . . .	332
Bind mode and RAID groups. . . . .	332
Pre-staging. . . . .	332
Starting Cache LUN . . . . .	332
Cache LUN pane. . . . .	333
Prestaging check box . . . . .	333
LDEV tree . . . . .	333
LDEV table . . . . .	334
Cache LUN pie chart . . . . .	334
Cache settings section . . . . .	334
Buttons . . . . .	335
Setting (Creating) a Cache Extent. . . . .	335
To place data in cache. . . . .	335
Releasing (Removing) a Cache Extent. . . . .	338
To remove data from cache. . . . .	338
Changing an Extent's Mode and Pre-staging. . . . .	339
Partial Cache Residence (PCR) Operations . . . . .	339
Overview of the PCR Function . . . . .	339
PCR Operations. . . . .	339
PCR Pane . . . . .	340
Viewing the current PCR settings. . . . .	341
Setting the PCR cache . . . . .	341
To set PCR cache for management information (i-node) and log information . . . . .	341
<b>22 Auto LUN for the XP128/XP1024/XP12000 . . . . .</b>	<b>345</b>
Auto LUN features . . . . .	345
Auto LUN statistics . . . . .	345
Auto LUN tasks . . . . .	347
Reserve volumes . . . . .	348
Volume migration . . . . .	348
Estimating usage rates. . . . .	349
Automatic migration . . . . .	349
Storage management by maximum disk usage . . . . .	350
Keep reserved volumes in high HDD classes . . . . .	350
Auto migration sequence of events. . . . .	351
Manual migration. . . . .	351
Performance Control . . . . .	352
Optimal performance of high-priority hosts . . . . .	352
Automatically disable upper limit control . . . . .	352
Overview of Performance Control procedures . . . . .	352
Procedure for one-to-one connections between HBAs and ports . . . . .	353
Procedure for many-to-many connections between HBAs and ports . . . . .	355
Notes on using Performance Control . . . . .	358
Requirements and restrictions . . . . .	360
Logical volumes . . . . .	360
Source volumes . . . . .	360
LUSE source volumes . . . . .	361
Target volumes . . . . .	361
Number of volumes . . . . .	362
Auto migration planning. . . . .	362



Auto migration execution . . . . .	362
Manual migration execution . . . . .	362
Maintenance . . . . .	363
Auto migration parameters . . . . .	363
Powering off disk arrays . . . . .	363
Performance Control restrictions . . . . .	363
iSCSI support . . . . .	363
Starting Auto LUN . . . . .	363
Auto LUN pane . . . . .	365
Tabs and selection trees . . . . .	365
Monitoring Term section . . . . .	365
Monitoring Data section . . . . .	365
Table section . . . . .	366
Graph section . . . . .	366
WWN, Port-LUN, LDEV, and Physical tabs . . . . .	367
WWN tab . . . . .	368
Port-LUN tab . . . . .	368
LDEV tab . . . . .	369
Physical tab . . . . .	369
Auto LUN Monitoring Options pane . . . . .	370
XP12000 disk arrays . . . . .	370
XP128/XP1024 disk arrays . . . . .	371
Usage statistics . . . . .	372
Collecting usage statistics about disk array resources . . . . .	372
Viewing parity group usage statistics . . . . .	373
Viewing logical volume usage statistics . . . . .	373
Viewing channel adapter (CHA) usage statistics . . . . .	375
Viewing channel processor (CHP) usage statistics . . . . .	375
Viewing disk adapter (DKA) usage statistics . . . . .	376
Viewing disk processor (DKP) usage statistics . . . . .	376
Viewing data recovery and reconstruction processor (DRR) usage statistics . . . . .	377
Viewing write pending rates . . . . .	378
Viewing access path usage statistics . . . . .	378
Workload and traffic statistics . . . . .	379
Collecting workload and traffic statistics about disk drives, ports, and LU paths . . . . .	379
Viewing disk drive workload statistics . . . . .	380
Viewing disk array port traffic statistics . . . . .	382
Viewing HBA/port traffic statistics . . . . .	383
Creating and executing migration plans . . . . .	385
Manual Migration tab . . . . .	385
Pane contents . . . . .	385
Tree view . . . . .	386
Table view . . . . .	386
Buttons . . . . .	386
Migrating volumes manually . . . . .	387
Deleting manual migration plans . . . . .	388
Auto Migration tab . . . . .	388
Pane contents . . . . .	389
Auto Migration Plans section . . . . .	389
Auto Plan Parameter section . . . . .	389
Setting auto migration parameters . . . . .	390
Deleting auto migration plans . . . . .	390
Remaking auto migration plans . . . . .	391
Attribute tab . . . . .	391
Pane contents . . . . .	391
Reserving target volumes . . . . .	393
Setting (“fixing”) parity groups . . . . .	393
Releasing (“unfixing”) parity groups . . . . .	394
Changing maximum disk usage rates for HDD classes . . . . .	394

History tab . . . . .	395
Pane contents . . . . .	395
Viewing migration history logs . . . . .	396
Using Performance Control . . . . .	399
Starting Performance Control . . . . .	399
Performance Control pane . . . . .	399
Pane contents . . . . .	401
Top section . . . . .	401
Tree section (WWN tab only) . . . . .	402
Table section . . . . .	402
Bottom section . . . . .	403
Buttons . . . . .	403
Managing traffic between HBAs and ports . . . . .	404
Measuring traffic between host bus adapters and ports for one-to-one connections . . . . .	404
Measuring traffic between host bus adapters and ports for many-to-many connections . . . . .	404
Analyzing traffic statistics . . . . .	405
Setting upper limit values for traffic at non-prioritized ports or WWNs . . . . .	406
Setting thresholds . . . . .	407
Changing PFC names of host bus adapters (many-to-many connections only) . . . . .	407
Replacing host bus adapters (many-to-many connections only) . . . . .	408
Grouping host bus adapters . . . . .	408
Adding multiple HBAs to a PFC group . . . . .	409
Switching the priority of PFC groups . . . . .	409
Setting upper limit values for HBAs in a PFC group . . . . .	409
Renaming PFC groups . . . . .	410
Deleting PFC groups . . . . .	411
Troubleshooting . . . . .	411
Performance Monitor and Performance Control . . . . .	411
Auto LUN XP . . . . .	411

## 23 Business Copy (BC) for the XP128/XP1024/XP12000 . . . . . 413

Overview of BC operations . . . . .	413
BC components . . . . .	413
BC volume pairs (P-VOLs and S-VOLs) . . . . .	414
Cascade pairs . . . . .	415
BC software on Command View management station . . . . .	415
BC requirements for XP128/1024 . . . . .	416
Maximum number of pairs for XP128/1024 . . . . .	417
BC requirements for XP12000 . . . . .	419
Maximum number of pairs for XP12000 . . . . .	420
BC operations . . . . .	424
Set reserve attribute operation . . . . .	424
Reset reserve attribute operation . . . . .	425
Paircreate operation . . . . .	425
Initial copy operation . . . . .	425
Update copy operation . . . . .	426
Cascade function . . . . .	427
Pairsplit operation . . . . .	427
Pairresync operations . . . . .	428
Forward pairresync operation . . . . .	428
Backward pairresync operation . . . . .	429
To avoid any performance impact due to the quick restore operation . . . . .	430
Pair status and time required for pairresync . . . . .	433
Pairsplit-E operation (suspend) . . . . .	434
Pairsplit-S operation (delete) . . . . .	434
BC options . . . . .	435
Swap&Freeze option . . . . .	435
Host I/O Performance option . . . . .	436
Cascade function . . . . .	436

At-Time Split function . . . . .	440
Enabling the At-Time Split function using RAID Manager . . . . .	441
Pair status . . . . .	442
Cautions on switching off the power supply . . . . .	444
Preparing for BC operations. . . . .	444
System requirements. . . . .	444
Preparing for BC operations . . . . .	445
Combining BC with other data management operations . . . . .	446
Combining BC and CA Journaling operations . . . . .	446
Combining BC and CA operations. . . . .	448
Starting BC . . . . .	450
BC main screen . . . . .	451
Volume list . . . . .	453
Detail window . . . . .	455
S-Vol Path window . . . . .	456
Display Filter window . . . . .	456
Preset Volume list . . . . .	457
Performing BC operations . . . . .	459
Setting reserve attributes . . . . .	459
Reserving one or more volumes for use as BC S-VOLs . . . . .	459
Resetting reserve attributes . . . . .	460
Unreserving one or more volumes . . . . .	460
Creating BC pairs (Paircreate). . . . .	461
Paircreate Volume List . . . . .	461
Copy Pace list . . . . .	462
Select MU list . . . . .	462
Select S-Vol box . . . . .	463
Buttons . . . . .	463
Creating L1 pairs . . . . .	464
Creating L2 pairs . . . . .	465
Splitting BC pairs (Pairsplit). . . . .	465
Pairsplit Volume List. . . . .	466
Window options. . . . .	467
Copy Pace list . . . . .	467
Select MU list . . . . .	467
Select Split Type list . . . . .	467
Select S-Vol box . . . . .	467
Buttons . . . . .	468
Splitting pairs . . . . .	468
Creating and splitting pairs . . . . .	469
Resynchronizing BC pairs (Pairresync) . . . . .	470
Pairresync Volume List . . . . .	471
Window options. . . . .	471
Resynchronizing one or more BC pairs . . . . .	471
Suspending BC pairs (Pairsplit-E) . . . . .	473
Suspending one or more BC pairs. . . . .	473
Deleting BC pairs (Pairsplit-S) . . . . .	474
Deleting one or more BC pairs . . . . .	474
Viewing BC pair status and history. . . . .	475
Setting BC options . . . . .	477
Setting a BC option (Swap&Freeze option). . . . .	478
BC error codes. . . . .	478

## 24 Continuous Access (CA) for the XP128/XP1024/XP12000 . . . . . 485

Overview of CA operations . . . . .	485
Components . . . . .	486
XP128/XP1024/XP12000 . . . . .	487
Main and remote control units (MCUs and RCUs) . . . . .	488
Volume pairs (P-VOLs and S-VOLs) . . . . .	488

CA Asynchronous consistency groups . . . . .	489
Remote copy connections. . . . .	489
Initiator ports and RCU target ports . . . . .	490
Remote control ports (RCPs) and local control ports (LCPs) . . . . .	490
Command View management station . . . . .	490
Host failover software . . . . .	491
Remote copy operations . . . . .	491
Initial copy operations . . . . .	491
Update copy operations . . . . .	492
Read and write I/O operations for CA volumes . . . . .	492
S-VOL write option . . . . .	493
CA Asynchronous recordset operations . . . . .	493
Creating and storing recordsets at the MCU. . . . .	493
Sending recordsets to the RCU . . . . .	494
Storing recordsets at the RCU. . . . .	494
Selecting and settling recordsets at the RCU. . . . .	494
Types of recordsets . . . . .	495
Inflow control of recordsets . . . . .	495
Inflow control by MCU . . . . .	495
Inflow control by RCU. . . . .	495
CA Asynchronous consistency group operations . . . . .	496
Group options . . . . .	496
Copy pending timeout . . . . .	496
RCU ready timeout. . . . .	497
Group operations . . . . .	497
CA volume pair status . . . . .	497
CA LUSE pair status . . . . .	498
CA Asynchronous pair status . . . . .	498
CA split types (PSUS) . . . . .	500
CA suspend types. . . . .	501
CA Asynchronous suspension conditions . . . . .	503
Preparing for CA operations . . . . .	504
System requirements . . . . .	504
Requirements and restrictions . . . . .	504
One-to-one volume copy operations . . . . .	505
Logical unit (LU) types . . . . .	505
Consistency groups. . . . .	505
Accessing CA P-VOLs and S-VOLs. . . . .	506
Cache and nonvolatile storage (NVS) . . . . .	506
Host failover software . . . . .	506
Duplicate volumes. . . . .	506
Host system crash . . . . .	506
Installing hardware . . . . .	506
Fibre Channel remote copy connections . . . . .	507
Serial remote copy connections . . . . .	509
Configuring MCUs and RCUs for CA operations . . . . .	511
Fibre Channel and serial interface configuration. . . . .	511
Combining CA with other BC data management operations. . . . .	512
Combining CA and BC . . . . .	513
Starting CA . . . . .	515
CA panes . . . . .	515
CA main pane (Pair Operation pane) . . . . .	517
Volume list . . . . .	518
Display Filter pane . . . . .	520
TrueCopy Snapshot function. . . . .	521
Creating and exporting (downloading) TrueCopy snapshot files . . . . .	522
RCU Operation pane . . . . .	522
CU Number tree and MCU/RCU list. . . . .	523
Port tree and Port list . . . . .	525

Asynchronous Operation pane . . . . .	525
Usage Monitor pane . . . . .	527
History Operations pane. . . . .	527
Other Operation pane . . . . .	529
Changing subsystem settings . . . . .	530
Viewing subsystem settings . . . . .	530
Changing subsystem settings . . . . .	531
Performing CA configuration operations . . . . .	531
MCU operations . . . . .	532
Configuring MCU ports . . . . .	532
RCU operations . . . . .	533
Viewing RCU Status (RCU Status) . . . . .	534
Registering RCUs (Add RCU) . . . . .	536
Registering RCUs to the connected MCU . . . . .	539
Modifying RCU options (Change RCU Option) . . . . .	540
Deleting RCUs (Delete RCU) . . . . .	541
RCU path parameters . . . . .	541
Adding and deleting logical paths for RCUs (Add Path/Delete Path) . . . . .	543
Adding new logical paths from the connected MCU to an existing RCU: . . . . .	543
Deleting paths from the connected MCU to an existing RCU: . . . . .	544
Adding and deleting SSIDs for RCUs (Add SSID/Delete SSID) . . . . .	544
Port change operation . . . . .	546
Modifying parameters and deleting settings . . . . .	547
Modifying parameters . . . . .	547
Deleting RCUs, Paths, or SSIDs . . . . .	547
CA Asynchronous operations . . . . .	547
Viewing consistency group status (CT Group Status) . . . . .	548
Adding consistency groups (Add CT Group). . . . .	550
Modifying consistency group options (CT Group Option) . . . . .	551
Deleting consistency groups (Delete CT Group). . . . .	552
Asynchronous copy option . . . . .	553
Modifying parameters and deleting consistency groups . . . . .	554
Modifying parameters . . . . .	555
Deleting consistency groups . . . . .	555
Usage Monitor operations . . . . .	555
Starting and stopping monitoring . . . . .	555
Starting remote copy usage monitoring . . . . .	555
Stopping remote copy usage monitoring . . . . .	556
Displaying usage monitor graph . . . . .	556
Optimizing CA operations and disk array performance . . . . .	558
Discontinuing CA operations. . . . .	560
Performing CA pair operations. . . . .	560
Preparing for CA volume pair operations . . . . .	560
Common procedure for CA pair operations . . . . .	561
List after command selection . . . . .	562
Modifying parameters and deleting LUs. . . . .	562
Modifying LU parameters . . . . .	563
Deleting LUs . . . . .	563
Viewing CA pair status for LUs and LDEVs (Pairdisplay) . . . . .	563
Creating CA volume pairs (Paircreate) . . . . .	565
CA initial copy and pair options of the Paircreate pane . . . . .	568
Fence Level (CA Synchronous only) . . . . .	568
Initial Copy parameters. . . . .	568
Asynchronous parameters . . . . .	569
Splitting CA pairs (Pairsplit-r). . . . .	569
Resuming CA volume pairs (Pairresync) . . . . .	572
Deleting CA volume pairs (Pairsplit-S) . . . . .	575
Changing pair options (Change Pair Option) . . . . .	578
Using CA for data migration and duplication . . . . .	579

Data migration using CA Synchronous . . . . .	579
Point-in-Time data duplication using CA Asynchronous . . . . .	580
Powering off and on CA components . . . . .	580
Planned outage of MCUs . . . . .	581
Planned outage of RCUs or remote copy connections . . . . .	581
Planned outage of MCUs and RCUs . . . . .	581
CA disaster recovery operations . . . . .	582
Preparing for disaster recovery . . . . .	582
Considering the P-VOL fence-level setting . . . . .	583
Setting the fence level . . . . .	583
Transferring sense information between sites . . . . .	584
File and database recovery procedures . . . . .	584
Switching operations to remote sites . . . . .	585
Analyzing currency of CA Synchronous S-VOLs . . . . .	585
Analyzing consistency of CA Asynchronous S-VOLs . . . . .	586
Transferring operations back to primary sites . . . . .	587
Resuming normal operations at primary sites . . . . .	588
Error codes and messages . . . . .	588
CA error codes . . . . .	588
Service Information Messages (SIMs) . . . . .	588
Pinned track recovery for CA volumes . . . . .	589

## 25 Continuous Access XP Journal . . . . . 591

Overview of copy solutions . . . . .	591
Continuous Access XP Journal (CA Journaling) . . . . .	591
Business Copy XP and ShadowImage for z/OS . . . . .	592
Continuous Access XP and TrueCopy for z/OS . . . . .	592
Overview of CA Journaling . . . . .	592
Functionality . . . . .	593
Journal obtain function . . . . .	594
Journal copy function . . . . .	594
Journal restore function . . . . .	594
Components . . . . .	595
Local disk arrays . . . . .	596
Main and remote control units (primary and secondary disk arrays) . . . . .	596
Journal groups . . . . .	597
Data volume pairs . . . . .	597
Journal volumes . . . . .	597
Number of journal volumes . . . . .	598
Journal volume specifications . . . . .	598
Journal volume restrictions on . . . . .	599
Journal volume areas . . . . .	599
Consistency groups . . . . .	600
Remote copy connections . . . . .	600
Initiator ports and RCU target ports . . . . .	601
CA Journaling Graphical User Interface . . . . .	601
Host failover software . . . . .	602
Remote copy operations . . . . .	602
Initial copy operations . . . . .	602
Update copy operation . . . . .	603
Read and write I/O operations during CA Journaling operations . . . . .	603
Secondary data volume write option . . . . .	604
Difference management . . . . .	604
Journal processing . . . . .	604
Creating and storing journals at primary disk arrays . . . . .	604
Copying journals to secondary disk arrays . . . . .	605
Storing journals at secondary disk arrays . . . . .	605
Selecting and restoring journals at secondary disk arrays . . . . .	606
Journal types . . . . .	607

Inflow control for journal cache. . . . .	607
Journal group operations . . . . .	607
CA Journaling data volume pair status . . . . .	608
CA Journaling split types (PSUS) . . . . .	611
CA Journaling suspend types . . . . .	612
CA Journaling suspension condition . . . . .	613
CA Journaling operations requirements and restrictions . . . . .	614
System requirements. . . . .	614
One-to-one volume copy operations . . . . .	615
Logical unit (LU) types. . . . .	616
Maximum number of pairs . . . . .	617
Journal groups. . . . .	618
Accessing CA Journaling primary and secondary data volumes. . . . .	619
Cache and nonvolatile storage (NVS). . . . .	620
Duplicate volumes . . . . .	620
Installing hardware . . . . .	620
Remote copy connections. . . . .	621
Enabling CA Journaling options. . . . .	622
Planning for journal volumes . . . . .	622
Considerations . . . . .	623
Planning process. . . . .	623
Data transfer speed required for journal volumes . . . . .	623
RAID group configuration and journal group configuration . . . . .	624
Arranging journal volumes . . . . .	624
Journal volume capacity . . . . .	624
Journal volumes in restore journal groups . . . . .	625
Factors that determine the data transfer speed between the primary and Secondary disk arrays . . . . .	625
Bandwidth of data transfer paths . . . . .	626
Journal transfer speed of DKCs . . . . .	626
Configuring primary and secondary disk arrays for CA Journaling operations. . . . .	626
Combining CA Journaling with other data management operations . . . . .	627
Combining CA Journaling and Business Copy XP . . . . .	628
Combining CA Journaling with Continuous Access XP (3DC configuration) . . . . .	630
Basic behavior. . . . .	631
Hardware configuration . . . . .	632
Setup procedure . . . . .	633
Disaster recovery . . . . .	633
Configuring disk arrays and logical paths . . . . .	634
Displaying the DKC Operation pane . . . . .	634
CA Journaling has not been started. . . . .	635
CA Journaling has already been started . . . . .	635
DKC Operation pane components . . . . .	635
Displaying information about remote disk arrays. . . . .	636
Displaying information about logical paths. . . . .	637
Displaying information about ports on local disk arrays . . . . .	638
Configuring port attributes . . . . .	638
Associating primary and remote disk arrays and configuring logical paths (Add DKC) . . . . .	640
Changing options for logical paths and disk arrays . . . . .	641
Adding logical paths . . . . .	643
Deleting logical paths. . . . .	644
Viewing the status of logical paths . . . . .	644
Removing the relationship between primary and secondary disk arrays . . . . .	646
Using journal groups. . . . .	647
Displaying the Journal Operation pane. . . . .	647
CA Journaling has not been started. . . . .	647
CA Journaling has already been started . . . . .	648
Journal Operation pane components . . . . .	648
Registering journal volumes in journal groups . . . . .	651
Deleting journal volumes from journal groups . . . . .	653

Displaying detailed information about journal groups . . . . .	654
Changing options for journal groups . . . . .	657
Deleting journal groups . . . . .	658
Splitting mirrors (Pairsplit-r: suspending copy operations) . . . . .	659
Restoring mirrors (Pairsync: resuming copy operations) . . . . .	660
Deleting data volumes from mirrors (Pairsplit-S: ending copy operations) . . . . .	661
Performing CA Journaling pair operations . . . . .	662
Displaying the Pair Operation pane . . . . .	662
CA Journaling has not been started . . . . .	662
CA Journaling has already been started . . . . .	662
Pair Operation pane components . . . . .	662
Filtering information in the list in the Pair Operation pane . . . . .	666
Saving pair status information to a text file . . . . .	666
Creating a pair of data volumes (Paircreate) . . . . .	667
Displaying detailed information about a pair of data volumes . . . . .	672
Splitting a pair of data volumes . . . . .	673
Restoring a pair of data volumes . . . . .	675
Deleting a pair of data volumes . . . . .	676
Creating a Point-in-Time copy of data volumes . . . . .	678
Monitoring remote copy operations . . . . .	678
Displaying the Usage Monitor pane . . . . .	679
CA Journaling has not been started . . . . .	679
CA Journaling has already been started . . . . .	679
Starting and stopping usage monitoring . . . . .	679
Starting usage monitoring . . . . .	680
Stopping usage monitoring . . . . .	680
Displaying the usage monitor graph . . . . .	680
Saving monitoring data in text files . . . . .	682
Viewing history of data volume pair operations . . . . .	682
Displaying the History Operation pane . . . . .	682
CA Journaling has not been started . . . . .	683
CA Journaling has already been started . . . . .	683
History Operation pane components . . . . .	683
Saving operation history in a text file . . . . .	685
Performing optional operations . . . . .	686
Displaying the Optional Operation pane . . . . .	686
CA Journaling has not been started . . . . .	686
CA Journaling has already been started . . . . .	687
Optional Operation pane components . . . . .	687
Changing disk array options . . . . .	687
Displaying CLPR options . . . . .	688
Disaster recovery operations . . . . .	689
Preparing for disaster recovery . . . . .	689
File and database recovery procedures . . . . .	689
Switching operations to the secondary site . . . . .	689
Transferring operations back to the primary site . . . . .	690
Resuming normal operations at the primary site . . . . .	690
Troubleshooting . . . . .	691
Troubleshooting Command View XP operations . . . . .	691
CA Journaling error codes . . . . .	697
Service Information Messages (SIMs) . . . . .	698
Calling the Support Center . . . . .	698
Power management for disk arrays and network relay devices . . . . .	698
When power is removed due to an unexpected reason . . . . .	698
When power is removed from primary disk arrays . . . . .	699
When power is removed from secondary disk arrays . . . . .	699
When power is removed from network relay devices . . . . .	699
When you turn power off intentionally . . . . .	699
When you power off primary disk arrays . . . . .	699



When you power off secondary disk arrays . . . . .	700
When you power off primary and secondary disk arrays at the same time . . . . .	700
When you power off network relay devices . . . . .	700
Pinned track recovery for CA Journaling volumes . . . . .	701
<b>26Flex Copy for the XP128/XP1024/XP12000 . . . . .</b>	<b>703</b>
Flex Copy features . . . . .	703
Flex Copy pairs . . . . .	704
Mapping . . . . .	704
Comparison of Flex Copy with External Storage XP . . . . .	706
Combining Flex Copy with other HP StorageWorks products . . . . .	707
Requirements and restrictions . . . . .	707
System requirements . . . . .	707
Storage devices that can be connected as external disk arrays . . . . .	708
Flex Copy capacities . . . . .	708
Requirements for LUs used for copy pairs . . . . .	709
Adjusting LU capacity when setting copy pairs . . . . .	710
Copying data from external disk arrays to local disk arrays . . . . .	710
To adjust the capacity of the local disk array LU (C) . . . . .	710
Copying data from local disk arrays to external disk arrays . . . . .	711
To adjust the capacity of the external LU (A) . . . . .	711
Maximum number of copy pairs . . . . .	711
Precautions for copy operations . . . . .	716
General precautions and tips for more efficient copy operations . . . . .	716
Precautions concerning Flex Copy pair volumes . . . . .	717
Starting Flex Copy operations . . . . .	718
During flex copy processing . . . . .	720
Status of copy pairs . . . . .	722
Copy operations using Command View . . . . .	725
Copy operations using RAID Manager XP . . . . .	725
Requirements for Flex Copy and Business Copy XP operations from RAID Manager XP . . . . .	726
Preparing for RAID Manager XP operations . . . . .	730
Examples of RAID Manager XP commands . . . . .	733
Example of system backup operations . . . . .	735
Preparing for Flex Copy operations . . . . .	739
Configuring external disk arrays . . . . .	739
Installing Flex Copy . . . . .	739
Uninstalling Flex Copy . . . . .	739
Preparing Flex Copy settings . . . . .	739
Flex Copy operations panes . . . . .	740
Starting Flex Copy operations . . . . .	740
LU Operation pane . . . . .	740
Port Operation pane . . . . .	740
Setting external LUs . . . . .	740
Copying data . . . . .	741
Flex Copy pane . . . . .	741
Pair List . . . . .	742
Preset List (Flex Copy pane) . . . . .	744
Panels for setting copy pairs . . . . .	745
Pair Volume Setting pane . . . . .	746
Copy Type Setting pane . . . . .	747
Copying data from external LUs to local disk array LUs . . . . .	747
Copying data from local disk array LUs to external LUs . . . . .	749
Displaying history of Flex Copy operations . . . . .	750
Canceling copy pairs (Delete Pair) . . . . .	752
Troubleshooting Flex Copy . . . . .	753
Relationship between LU capacity and copy range . . . . .	755

27 External storage for the XP12000 . . . . .	757
Mapping . . . . .	757
Alternate paths . . . . .	758
External Storage XP uses . . . . .	760
Writing new data to mapped external LUs . . . . .	760
Using existing data in mapped external LUs . . . . .	761
Using external LUs for Volume Migration under Auto LUN XP . . . . .	762
Using external LUs for Business Copy operations . . . . .	763
Combining External Storage XP with other HP StorageWorks products . . . . .	764
Requirements and restrictions . . . . .	765
System requirements . . . . .	765
Storage devices that can be connected as external disk arrays . . . . .	765
Fibre Channel switches supported . . . . .	765
External Storage XP requirements . . . . .	766
Limitations concerning External Storage XP operations . . . . .	766
General limitations . . . . .	766
LU mapping compared to emulation type . . . . .	767
IO Suppression mode and Cache Mode . . . . .	768
Attributes . . . . .	768
Cache LUN XP . . . . .	768
LUSE and External Storage XP . . . . .	768
LUN management . . . . .	769
Hitachi Parallel Access Volume (HPAV) . . . . .	769
Hitachi SANtinel - S/390® . . . . .	769
LUN Security XP Extension . . . . .	769
Configuration File Loader function . . . . .	769
Preparing for External Storage XP operations . . . . .	769
Configuring MSA1000/1500 as external disk arrays . . . . .	769
Connecting MSA1000/1500 . . . . .	769
Setting up the MSA . . . . .	770
Defining MSA array objects . . . . .	771
Calculating MSA LU size and defining LUs . . . . .	771
Selective Storage Presentation . . . . .	771
Installing External Storage XP . . . . .	772
Uninstalling External Storage XP . . . . .	772
Preparations for External Storage XP settings . . . . .	772
External port attributes . . . . .	773
Mapping external LU information . . . . .	773
Using external LU groups . . . . .	773
External LU attributes set by mapping . . . . .	773
Powering on and off disk arrays . . . . .	774
Powering off the local disk arrays . . . . .	776
Powering off external disk arrays . . . . .	776
Powering on local disk arrays or external disk arrays . . . . .	776
External Storage XP operations . . . . .	776
Starting External Storage XP operations . . . . .	776
LU Operation pane . . . . .	777
Device Tree . . . . .	778
Device List . . . . .	779
Filter button . . . . .	781
Preset List (LU Operation pane) . . . . .	782
Port Operation pane . . . . .	784
Port Tree . . . . .	785
Port List . . . . .	786
Preset List (Port Operation pane) . . . . .	787
Configuring external LUs . . . . .	788
Overview of steps required to define external LUs . . . . .	789
Configuring external disk array LUs, host mode, and ports . . . . .	790

Setting port attributes on the local disk arrays . . . . .	790
Mapping external LUs . . . . .	791
Add LU window . . . . .	792
Auto Map Setting window . . . . .	794
Select LDEV window . . . . .	796
Manually mapping external LDEVs (Add LU). . . . .	797
Setting alternate paths . . . . .	800
Path Setting window . . . . .	801
Defining alternate paths. . . . .	803
Changing the priority of alternate paths. . . . .	804
Canceling defined alternate paths. . . . .	805
Changing alternate paths. . . . .	806
Checking External Storage XP volume status (LDEV Information). . . . .	806
Obtaining information about external LUs . . . . .	807
Restoring external LUs (Restore). . . . .	808
Displaying configuration information for external LUs (Volume Detail) . . . . .	809
Disconnecting external disk arrays or external LUs . . . . .	810
Disconnecting all external LUs in external disk arrays (Disconnect Subsystem). . . . .	810
Disconnecting single external LUs (Disconnect Volume) . . . . .	811
Checking connection status and resuming external LU operations (Check Paths & Restore Vol.) . . . . .	812
Restoring single external LUs (Check Paths & Restore Vol.) . . . . .	812
Restoring all external LUs in an external disk array (Check Paths & Restore Vol.) . . . . .	813
Deleting external LU mappings (Delete LU) . . . . .	813
Troubleshooting External Storage XP . . . . .	814
Required volume capacity for each emulation type . . . . .	819

## 28 Direct Backup Engine for the XP128/XP1024/XP12000 . . . . . 823

Direct Backup Engine commands . . . . .	823
System requirements . . . . .	823
Host server requirements. . . . .	823
Supported backup devices . . . . .	823
Disk array requirements . . . . .	824
Starting Direct Backup Engine . . . . .	824
Direct Backup Engine pane . . . . .	824
Port Group Information box . . . . .	824
Port Group tree . . . . .	824
Port Group Information table . . . . .	825
Port Operation tree . . . . .	825
Preset table . . . . .	826
Using Direct Backup Engine . . . . .	826
Viewing detailed port information . . . . .	827
Adding ports to port groups . . . . .	828
Moving ports from port groups . . . . .	830
Setting timeout periods . . . . .	831
Changing target ports, RCU target ports, or external ports to initiator ports . . . . .	833
Changing initiator ports, RCU target ports, or external ports to target ports . . . . .	833

## A Troubleshooting . . . . . 835

Browser displays “Data Retrieval in Progress” message for a long time (XP48/XP512 only) . . . . .	835
Browser displays “The storage capacity of an audit log remains and is slight” message . . . . .	835
Mozilla browser is incorrectly displaying some features on HP-UX . . . . .	836
To remove all the cookies and select “Enable cookies for the originating Web site only” in Mozilla: . . . . .	836
To clear history in Mozilla: . . . . .	836
To Clear Cache in Mozilla: . . . . .	836
Device Health pane displays red or yellow disk array components. . . . .	836
Session Administration pane reports the incorrect host address . . . . .	837
To disable the proxy service in Internet Explorer: . . . . .	837
To add IP addresses in Internet Explorer: . . . . .	837

To add IP addresses in Netscape: . . . . .	837
The disk array license key installation fails . . . . .	837
Identity and Status panes contain outdated information (XP48/XP512 only) . . . . .	837
Problems occur when removing LUSE volumes from Volume Management. . . . .	838
The refresh fails with an SNMP timeout error (XP48/XP512 only) . . . . .	838
Command View reports "possible Auto LUN initialization problem" . . . . .	838
Error occurs when entering the IP Address in the Device Administration pane . . . . .	838
Configuration File Loader fails to start or the spreadsheet file cannot be uploaded. . . . .	839
Business Copy fails or does not function properly . . . . .	839
Continuous Access fails or does not function properly . . . . .	840
Troubleshooting RCU path status problems. . . . .	840
Troubleshooting suspended CA pairs . . . . .	842
Resolving CA Async suspension conditions . . . . .	842

## Index . . . . . 845

### Figures

1 Command View integrated with other management platforms and application modules . . . . .	40
2 Command View initial window . . . . .	43
3 Command View main window . . . . .	45
4 Device Launcher pane . . . . .	47
5 Device Administration pane . . . . .	49
6 Device History pane. . . . .	52
7 Session Management pane. . . . .	54
8 Security pane . . . . .	57
9 Users pane . . . . .	62
10 New user box . . . . .	63
11 Group Membership tab . . . . .	64
12 User Name box. . . . .	65
13 Array/Partition Membership box. . . . .	66
14 Groups tab . . . . .	67
15 Properties box: General tab . . . . .	68
16 Properties box: Members tab . . . . .	68
17 Application Administration pane . . . . .	69
18 Add New Applications pane. . . . .	70
19 Edit Applications pane . . . . .	71
20 Download page . . . . .	73
21 Accessing licenses . . . . .	76
22 License Key Management pane. . . . .	76
23 License Key Management (Install) pane . . . . .	78
24 License Key Management (Uninstall) pane . . . . .	79
25 Array Event History pane . . . . .	81
26 Notification pane . . . . .	83
27 History Log Configuration pane. . . . .	84
28 Email Server Configuration pane. . . . .	85
29 Email Notification pane . . . . .	86
30 Script Notification pane . . . . .	87
31 SNMP Notification pane . . . . .	89
32 Schedule pane for creating a new schedule . . . . .	90
33 Event History pane. . . . .	91
34 Notification History pane . . . . .	92
35 Clear History pane . . . . .	93
36 Array Test Event pane . . . . .	94
37 Path Connectivity Test Event pane . . . . .	94
38 Identity pane (XP512). . . . .	97
39 Identity pane (XP12000). . . . .	98
40 Example of audit log file. . . . .	101
41 Port pane (Basic Information display) . . . . .	116
42 LUN pane (Basic Information display). . . . .	117

43	LDEV pane (Basic Information display)	118
44	Detail Information Pane	119
45	Control Panel for the XP12000	120
46	Write permissions window	121
47	Set Environment tab	121
48	Log tab (XP128/XP1024 only)	124
49	Download tab (XP128/XP1024 only)	125
50	Status Overview Pane	127
51	Port/LUN Map pane	128
52	Ldev/Port Map pane	129
53	ACP/Ldev Map pane	130
54	Ports pane	131
55	Device Health pane	132
56	LUN Security pane	134
57	Cache LUN pane	135
58	VSC pane	136
59	Parity Group pane	137
60	Status pane	139
61	Detail window	140
62	The System pane	141
63	Example of an SLPR	144
64	Example of a CLPR	145
65	Partition Definition pane	148
66	Partition Definition pane (SLPR selected)	149
67	Partition Definition pane (CLPR selected)	152
68	LUN Management pane	157
69	Delete Path Confirmation pane (LUN Management pane)	158
70	Add Path pane	159
71	LUN Expansion Main pane	161
72	LUN Expansion Detail pane	162
73	LUN Expansion Continuous pane	163
74	LUN Expansion Disperse pane	164
75	View Host Mode Configuration pane	166
76	Host Mode Configuration pane	166
77	View Fibre Port Configuration pane	167
78	Setting a Fibre Channel port address (Set Fibre Port Configuration pane)	168
79	Setting a Fibre Channel topology	169
80	VSC functions	170
81	Volume Size Configuration (Main Screen) pane	172
82	Volume Size Configuration (Install CV) pane	174
83	LDEV ID Configuration pane	175
84	LU paths configuration in a Fibre Channel environment	181
85	LU paths configuration in a NAS environment (XP128/XP1024 only)	183
86	16-Port CHIP pair labeling	184
87	Host group example 1	185
88	Host group example 2	185
89	Host group example 3 (LUN security)	187
90	Differences between high-speed and high-speed (2 port) modes	191
91	Flow of port authentication	194
92	Overview of user authentication	196
93	LUN Management main pane	197
94	NAS folder in LU path tree	198
95	iSCSI folder in LU path tree	199
96	WWN and iSCSI name tables	201
97	Add New Host Group dialog box	203
98	Add New WWN dialog box (Fibre Channel)	205
99	Add New iSCSI Name dialog box (iSCSI)	205
100	Add New WWN dialog box (when registering a host that has previously been connected to the disk array)	

101 Add New iSCSI Name dialog box (when registering a host that has previously been connected to the disk array).	206
102 Check paths dialog box	207
103 Confirm path deletion	208
104 Change Host Group dialog box	208
105 Change WWN & Nickname dialog box	210
106 Change WWN & Nickname dialog box	210
107 Check WWNs / Check iSCSI names	211
108 Alternate Paths dialog box	215
109 Port pane	217
110 User Authentication tab (LUN Management pane)	222
111 iSCSI folder in the Port tree	223
112 Add New User Information dialog box	225
113 Change User Information (Host) dialog box	226
114 Specify User Information (Port) dialog box	227
115 LUN Security main pane	231
116 LUN Security main pane with WWN/WWN Group list displayed	232
117 LUN/LUN Group Security pane	233
118 LUN Group pane	234
119 LUN Security main pane with Nickname box displayed	235
120 New WWN pane	236
121 WwnGroup pane	237
122 LUN Security main pane with Update WWN/WWN group boxes displayed	238
123 WwnGroup pane	239
124 LUSE configuration	241
125 VSC process (all supported emulation types except for OPEN-V)	244
126 VSC process (OPEN-V)	244
127 Parity group configuration for other than OPEN-V	245
128 Virtual VSC volume configuration for other than OPEN-V	245
129 Volume Management pane	250
130 LUSE creation confirmation message	255
131 LUSE release confirmation message	255
132 LUSE reset confirmation message	256
133 Customized Volume pane (Volume Management screen)	257
134 Volume to space confirmation	260
135 Install CV pane (1) for OPEN-V (when two or more free spaces are available)	261
136 Install CV pane (1) for other than OPEN-V	262
137 Install CV pane (1) for OPEN-V after clicking Set	263
138 Install CV pane (1) for other than OPEN-V after clicking Set	264
139 Install CV pane (2)	265
140 Select an LDEV number	266
141 Setting the SSID	267
142 Install CV confirmation dialog box	268
143 Customized volume screen	268
144 Make Volume pane (1)	269
145 Make Volume pane (1) after clicking Set	270
146 Make Volume pane (2)	271
147 Select an LDEV number	272
148 Make Volume confirmation message	273
149 Volume Initialize pane	274
150 Select an LDEV number	275
151 Volume Initialize confirmation pane	276
152 Overview of Shredding operations	279
153 Customized Volume pane	280
154 Example of access attributes	286
155 LUN Security XP Extension pane	288
156 Term Setting dialog box	291
157 Volume Detail dialog box	291
158 Error Detail pane	292

159	Access attribute before applying the changes . . . . .	293
160	Disabling an S-Vol . . . . .	294
161	Volume Detail dialog box . . . . .	296
162	Outline of the Configuration File Loader tasks. . . . .	301
163	Text Import Wizard - Step 1 of 3 . . . . .	302
164	Text Import Wizard - Step 2 of 3 . . . . .	303
165	Text Import Wizard - Step 3 of 3 . . . . .	303
166	Configuration File Loader pane . . . . .	304
167	Sample Spreadsheet . . . . .	305
168	Format of configuration definition (settings) . . . . .	308
169	Index and parameter parts of a spreadsheet (example) . . . . .	310
170	Export dialog box. . . . .	317
171	Specifying where to save the spreadsheet . . . . .	318
172	Import dialog box. . . . .	320
173	Specifying from where to import the spreadsheet . . . . .	320
174	Cache LUN operations . . . . .	323
175	Cache LUN pane . . . . .	326
176	LUN/VOL Caching Define pane. . . . .	327
177	LUN/VOL Caching Define pane after clicking Set. . . . .	327
178	Cache LUN operations . . . . .	329
179	Cache LUN pane . . . . .	333
180	PCR Cache Area (Cache Extent). . . . .	339
181	PCR Pane . . . . .	340
182	Moving volumes to another class based on usage. . . . .	350
183	Auto migration function example 1 . . . . .	351
184	Auto migration function example 2 . . . . .	351
185	Network A (one-to-one connections between HBAs and ports) . . . . .	353
186	Priority specified in the Performance Control pane . . . . .	353
187	Traffic at ports on network A . . . . .	354
188	Network B (many-to-many connections between HBAs and ports) . . . . .	355
189	Specifying host bus adapters to be monitored . . . . .	355
190	Priority specified in the Performance Control pane . . . . .	356
191	Traffic at ports on network B . . . . .	357
192	Setting upper limits . . . . .	357
193	Graphs indicating changes in port traffic. . . . .	359
194	Auto LUN pane for an XP12000 . . . . .	364
195	Auto LUN pane for an XP128/XP1024 . . . . .	364
196	WWN, Port-LUN, LDEV, and Physical tabs . . . . .	367
197	Auto LUN Monitoring Options pane (XP12000). . . . .	371
198	Auto LUN Monitoring Options pane (XP128/XP1024) . . . . .	371
199	Parity group usage statistics . . . . .	373
200	Logical volume usage statistics . . . . .	374
201	CHA usage statistics . . . . .	375
202	CHP usage statistics . . . . .	376
203	DKA usage statistics . . . . .	376
204	DKP usage statistics. . . . .	377
205	DRR usage statistics. . . . .	377
206	Write pending rates . . . . .	378
207	Usage statistics about paths between adapters and the cache switch . . . . .	378
208	Usage statistics about paths between adapters and shared memory . . . . .	379
209	Usage statistics about paths between cache switches and cache memory . . . . .	379
210	Workload statistics for all parity groups. . . . .	380
211	Workload statistics for a specific parity group . . . . .	380
212	Workload statistics for logical volumes in a parity group . . . . .	381
213	Traffic statistics about ports in a disk array. . . . .	382
214	Traffic statistics about host ports to which a disk array port is connected . . . . .	382
215	Traffic statistics about host ports in a host group . . . . .	382
216	Traffic statistics about LU paths . . . . .	382
217	Traffic statistics for host bus adapters. . . . .	384

218	Traffic statistics for each PFC group . . . . .	384
219	Traffic statistics for each port connected to a specified HBA . . . . .	384
220	Manual Migration tab . . . . .	385
221	Auto Migration tab . . . . .	388
222	Attribute pane . . . . .	391
223	Class table boxes . . . . .	392
224	Parity group table boxes . . . . .	392
225	Change Threshold pane . . . . .	394
226	History tab . . . . .	395
227	Port tab in the Performance Control pane . . . . .	400
228	WWN tab in the Performance Control pane . . . . .	401
229	Add WWN dialog box . . . . .	405
230	Change WWN and PFC Name dialog box . . . . .	408
231	Add New PFC Group dialog box . . . . .	409
232	Change Upper Limit dialog box . . . . .	410
233	Change PFC Group Name dialog box . . . . .	411
234	BC overview . . . . .	414
235	Adding a pair in BC . . . . .	426
236	Update copy operation . . . . .	427
237	Normal and quick pairresync operations . . . . .	429
238	Reverse and quick restore pair operations . . . . .	430
239	BC P-VOL forming pair with CA S-VOL and external S-VOL, respectively . . . . .	432
240	BC P-VOL forming pair with external S-VOL and shared as CA S-VOL . . . . .	433
241	BC S-VOL forming pair with external P-VOL and shared as CA P-VOL . . . . .	433
242	BC P-VOL forming pair with CA Journaling S-VOL and External S-VOL, respectively . . . . .	433
243	BC P-VOL forming pair with external S-VOL and shared as CA Journaling S-VOL . . . . .	433
244	Quick Restore operation with or without Swap&Freeze option . . . . .	435
245	Cascade pairs . . . . .	437
246	Overview of At-Time Split function . . . . .	440
247	BC pair status transitions . . . . .	442
248	BC and CA Journaling: Shared P-VOL and P-VOL . . . . .	447
249	BC and CA Journaling: Shared P-VOL and S-VOL . . . . .	447
250	BC and CA Journaling: Shared P-VOL and P-VOL and P-VOL and S-VOL . . . . .	448
251	BC and CA: shared P-VOL/P-VOL . . . . .	448
252	BC and CA: shared P-VOL/S-VOL . . . . .	449
253	BC and CA: shared P-VOL/P-VOL and P-VOL/S-VOL . . . . .	449
254	BC and CA: shared S-VOL/P-VOL . . . . .	450
255	BC main screen . . . . .	450
256	Volume list . . . . .	453
257	Detail window . . . . .	455
258	S-Vol Path window . . . . .	456
259	Display Filter window . . . . .	456
260	Preset Volume list . . . . .	457
261	Set Reserve Attribute window . . . . .	459
262	Reset Reserve Attribute window . . . . .	460
263	Paircreate window . . . . .	461
264	Pairsplit window . . . . .	466
265	Pairresync window . . . . .	470
266	Pairsplit-E window . . . . .	473
267	Pairsplit-S window . . . . .	474
268	History pane . . . . .	475
269	Option screen . . . . .	477
270	CA components for Fibre Channel connections . . . . .	487
271	CA components for Serial (ESCON) connections . . . . .	487
272	Remote copy operations . . . . .	491
273	Selecting and settling CA Async recordsets at the RCU . . . . .	495
274	Fibre Channel remote copy connections . . . . .	507
275	Direct connection . . . . .	508
276	Switch connection . . . . .	508



277 Extender connection . . . . .	508
278 Serial remote copy connections . . . . .	509
279 N pairs of remote copy connections . . . . .	509
280 N-to-1 and 1-to-n remote copy connections (n£4) . . . . .	510
281 Remote copy connections shared with channel-to-RCU connections . . . . .	510
282 Add RCU and RCU Option panes. . . . .	511
283 Async Option and Add CT Group panes. . . . .	512
284 Shared CA P-VOL and shared BC P-VOL . . . . .	514
285 Shared CA S-VOL and shared BC P-VOL . . . . .	514
286 Shared CA/BC P-VOL and shared CA S-VOL/BC P-VOL . . . . .	514
287 Shared BC S-VOL/CA P-VOL . . . . .	514
288 CA main pane . . . . .	515
289 CA main pane (Pair Operation pane) . . . . .	518
290 Volume list (partial view) . . . . .	519
291 Display Filter pane . . . . .	521
292 RCU Operation pane . . . . .	523
293 RCU Operation pane with the MCU&RCU option button selected . . . . .	524
294 RCU Operation pane with the Port option button selected . . . . .	525
295 Asynchronous Operation pane (XP128). . . . .	526
296 Usage Monitor pane . . . . .	527
297 History Operations pane . . . . .	528
298 Other Operation pane . . . . .	529
299 Other Operation pane with subsystem settings . . . . .	530
300 System Option pane . . . . .	531
301 Preset List pane. . . . .	531
302 Configuring MCU ports . . . . .	533
303 RCU Status pane . . . . .	535
304 Add RCU pane. . . . .	537
305 RCU Option pane. . . . .	538
306 RCU Settings Parameter list . . . . .	539
307 RCU Option pane. . . . .	540
308 RCU Settings Parameter list (RCU Option) . . . . .	541
309 Fibre Channel interface connections going through switches . . . . .	542
310 Add RCU pane used for configuration in <a href="#">Figure 309</a> . . . . .	542
311 Add Path pane . . . . .	543
312 Add SSID pane . . . . .	544
313 Adding/deleting SSIDs for existing RCUs. . . . .	545
314 Changing port types . . . . .	546
315 Performing asynchronous operations. . . . .	548
316 CT Group Status pane. . . . .	549
317 Add CT Group pane. . . . .	550
318 CT Group Option pane. . . . .	551
319 Consistency Group Settings Parameter list . . . . .	552
320 Async Option pane. . . . .	553
321 Asynchronous Option Settings Parameter list . . . . .	554
322 Display Item pane. . . . .	556
323 Performing pair settings operations . . . . .	562
324 Pairedisplay pane . . . . .	563
325 Paircreate pane . . . . .	565
326 Pair Settings Parameter list (Paircreate) . . . . .	567
327 Pairsplit-r pane . . . . .	570
328 Pair Settings Parameter list (Pairsplit-r) . . . . .	572
329 Pairresync pane . . . . .	573
330 Pair Settings Parameter list (Pairresync) . . . . .	575
331 Pairsplit-S pane . . . . .	576
332 Pair Settings Parameter list (Pairsplit-S). . . . .	577
333 Change Pair Option pane . . . . .	578
334 Pair Settings Parameter list (Pair Option) . . . . .	579
335 Relationship between log file and data file in PAIR status. . . . .	584

336	CA Journaling components for fibre-channel connections . . . . .	594
337	CA Journaling components . . . . .	595
338	Connection configuration for multiple secondary disk arrays . . . . .	596
339	Corresponding consistency group and journal group numbers . . . . .	600
340	Remote copy operations . . . . .	602
341	Selecting and settling journal at secondary disk array . . . . .	606
342	CA Journaling remote copy connection configuration . . . . .	622
343	Direct remote copy connections . . . . .	622
344	Switch remote copy connections . . . . .	623
345	Extender remote copy connections . . . . .	623
346	Data transfer speed of journal volumes . . . . .	624
347	Influence of data transfer speed on journal volume capacity . . . . .	625
348	Data transfer speed between primary and secondary disk arrays . . . . .	626
349	Shared CA Journaling secondary data volume and Business Copy XP P-VOL . . . . .	629
350	Shared CA Journaling secondary data volume and Business Copy XP P-VOL . . . . .	630
351	Shared CA Journaling primary data volume and Business Copy XP P-VOL, and CA Journaling secondary data volume and Business Copy XP P-VOL . . . . .	630
352	Shared Business Copy XP S-VOL and CA Journaling primary data volume . . . . .	631
353	3DC cascading configuration (combining CA Journaling with Continuous Access XP Synchronous). . . . .	631
354	Basic behavior in 3DC cascading configuration . . . . .	632
355	Information in <b>Port-G-ID-LUN</b> column in Pair Operation pane . . . . .	663
356	Information in pair Port-G-ID-LUN column in Pair Operation pane . . . . .	664
357	Flex Copy concept . . . . .	703
358	Copying data from an external LU to the local disk array LU . . . . .	703
359	Copying data from a local disk array to an external LU . . . . .	704
360	Examples of LUs that cannot be shared by Flex Copy pairs . . . . .	707
361	Copying data from an external disk array to a local disk array . . . . .	708
362	Copying data from a local disk array to an external disk array . . . . .	709
363	Configuration pattern example 1 . . . . .	716
364	Configuration pattern example 2 . . . . .	716
365	Configuration pattern example 3 . . . . .	717
366	Configuration pattern example 4 . . . . .	717
367	Configuration pattern example 1 (during processing) . . . . .	718
368	Configuration pattern example 2 (during processing) . . . . .	718
369	Configuration pattern example 3 (during processing) . . . . .	719
370	Configuration pattern example 4 (during processing) . . . . .	719
371	Transitions of Flex Copy pair status . . . . .	720
372	Connection configuration using Flex Copy . . . . .	726
373	Connection configuration using Business Copy XP . . . . .	727
374	Procedure required before performing Flex Copy operations using RAID Manager XP . . . . .	728
375	Sample configuration using RAID Manager XP . . . . .	728
376	Backing up data from a Branch Office to the Head Office . . . . .	733
377	Flex Copy pane . . . . .	739
378	Sample Pair List . . . . .	741
379	Preset Status of Flex Copy pane . . . . .	742
380	Sample Preset Detail pane (Copy Pair is Set) . . . . .	743
381	Pair Volume Setting pane . . . . .	744
382	Copy Type Setting pane . . . . .	745
383	Flex Copy pane (Create Pair command) . . . . .	746
384	Flex Copy History pane . . . . .	748
385	Preset Status of Canceling Copy Pair Operation . . . . .	751
386	Data copy range of copy processing for Flex Copy . . . . .	754
387	Example of a complete copy . . . . .	754
388	Example of an incomplete copy . . . . .	754
389	External Storage XP concept . . . . .	756
390	Example of alternate path settings . . . . .	757
391	Example of alternate path configuration using two switches . . . . .	757
392	Incorrect example of alternate path configurations . . . . .	758
393	Writing new data to mapped external LUs . . . . .	758

394	Using existing data in mapped external LUs (without formatting)	759
395	Volume Migration using external LUs	760
396	Business Copy operations using an external LU	761
397	Example of external LUs <= 2 TB	765
398	External LU capacity is larger than capacity of specified emulation type	765
399	External LU capacity is smaller than basic capacity of specified emulation type	766
400	Example: Connecting an MSA disk array	768
401	Defining MSA array objects with the ACU	769
402	Defining MSA LUs with ACU	769
403	Configuring SSP with ACU	770
404	LU Operation pane	775
405	Device Tree	776
406	Sample Device List (WWNs of external array ports selected in the Device Tree)	777
407	Filter window	779
408	Preset status of the LU Operation pane	780
409	Preset Detail window (Mapping Operation)	781
410	Port Operation pane	782
411	Port Tree	783
412	Port List	784
413	Preset status of the Port Operation pane	785
414	Preset Detail window (changing port attribute)	786
415	Tasks required before using external LUs	787
416	Change to External Operation	788
417	Error when changing port attribute	789
418	Add LU window	790
419	Auto Map Setting window	792
420	Select LDEV window	794
421	Add LU (LDEV) command in the LU Operation pane	795
422	Mapping all external LUs to internal LDEVs at once	796
423	Mapping one external LU in a series to a different (non-sequential) internal XP LDEV	796
424	SSID window	797
425	Preset Status of the Add LU Operation	797
426	Set SSID window	798
427	Path Setting window	799
428	Defining alternate paths in the LU Operation pane	801
429	Using Priority Up to raise defined alternate paths in the LU Operation pane	803
430	LDEV Information window	805
431	Shortcut menu of the LDEV Information window	807
432	Volume Detail window	808
433	Disconnect Subsystem and Check Paths & Restore Vol. Commands	809
434	Calculating LU capacity (OPEN-3 example)	817
435	Direct Backup Engine overview	821
436	Direct Backup Engine pane	822
437	Detail window	825
438	Construct Port Group pane (adding ports)	827
439	Construct Port Group pane (moving ports)	829
440	Set Timeout dialog box	830

## Tables

1	Document conventions	36
2	Command View features	40
3	Specifications and restrictions for logon operations	44
4	Predefined User Properties	58
5	Group name properties	59
6	Support pane links	73
7	License key code length	78
8	Information for configuring SNMP notifications (NetCitizen2.mib)	88
9	Identity pane buttons and icons	98
10	Abbreviation displayed in audit log file and corresponding program product or operation	102

11	Operation and Terms Displayed in Audit Log File . . . . .	103
12	LUNM Operation and Priority of Log Information Output . . . . .	113
13	Attribute values . . . . .	129
14	Status conditions . . . . .	132
15	Device Status List. . . . .	133
16	Error levels . . . . .	140
17	Port icons . . . . .	142
18	Tasks and functions available to administration groups. . . . .	145
19	LUN size limitations for OPEN-3, OPEN-8, and OPEN-9 . . . . .	160
20	LUN size limitations for OPEN-3 VSC, OPEN-8 VSC, and OPEN-9 VSC. . . . .	160
21	Host modes. . . . .	165
22	VSC specifications. . . . .	171
23	Volume types, logical blocks, and capacities . . . . .	171
24	LUN Management operation restrictions. . . . .	176
25	VSC and LUSE operation restrictions . . . . .	177
26	Port operation restrictions . . . . .	177
27	Host modes for host operating systems (XP128/XP1024) . . . . .	186
28	AL-PA and loop IDs (XP128/XP1024) . . . . .	189
29	LUN Management tabs . . . . .	197
30	Fibre Channel port icons for LUN Management operations . . . . .	198
31	NAS port icons for LUN Management operations . . . . .	199
32	iSCSI port icons for LUN Management operations . . . . .	200
33	LUN icons for LUN Manager operations. . . . .	200
34	LDEV icons for LUN Management operations . . . . .	202
35	Host mode options. . . . .	204
36	Copying LU paths . . . . .	212
37	Channel adapter package icons for Port operations. . . . .	217
38	iSCSI port icons for User Authentication operations . . . . .	223
39	Combinations of iSCSI port settings and connection results . . . . .	228
40	LUN Management operation restrictions (XP128/XP1024) . . . . .	229
41	Port operation restrictions (XP128/XP1024) . . . . .	230
42	Creating VSC volumes by Install CV (for OPEN-V) . . . . .	246
43	VSC supported emulations . . . . .	247
44	Install Custom Volume operation parameters for mainframe and open system volumes . . . . .	247
45	Capacities of open system custom volume sizes. . . . .	248
46	Settings for the Make Volume operation (OPEN-V only) . . . . .	248
47	LDEV status icons for LUSE operations . . . . .	250
48	Parity group status icons. . . . .	258
49	VDEV status icons . . . . .	258
50	LDEV status icons for VSC operations. . . . .	258
51	Volume status . . . . .	259
52	VSC and LUSE operation restrictions (XP128/XP1024/XP12000) . . . . .	278
53	LUN Security Extension icons . . . . .	289
54	Troubleshooting LUN Security Extension XP. . . . .	296
55	Requirements and rules for the spreadsheet file . . . . .	306
56	Components of the spreadsheet declaration line . . . . .	307
57	Format of LUN Manager spreadsheet (XP128/1024) . . . . .	311
58	Format of LUN Manager spreadsheet (XP12000) . . . . .	311
59	Available values of configuration definitions for the [Port] tag . . . . .	312
60	Status of security switch and restriction on setting operation . . . . .	313
61	Available values of configuration definitions for the [Cha] tag. . . . .	313
62	Available values of configuration definitions for the [HostGroup] tag . . . . .	314
63	Available values of configuration definitions for the [WWN] tag. . . . .	315
64	Available values of configuration definitions for the [LUN] tag. . . . .	316
65	Available values of configuration definitions for the [LDEV] tag . . . . .	316
66	Cache LUN supported emulation types and parameters . . . . .	324
67	Restrictions . . . . .	324
68	Restrictions . . . . .	330
69	Cache LUN icons (XP128/XP1024). . . . .	333

70	Movability of volumes in pairs consisting of CV and normal values . . . . .	360
71	Non-cascaded volumes that can be used as source volumes (XP128/XP1024/XP12000). . . . .	361
72	Cascaded volumes that can be used as source volumes (XP128/XP1024/XP12000). . . . .	361
73	Graph contents based on list selection (Port-LUN tab) . . . . .	366
74	Auto LUN pane, Port-LUN tab icons (XP128/XP1024/XP12000) . . . . .	368
75	Auto LUN pane, Physical tab icons (XP128/XP1024/XP12000) . . . . .	369
76	Migration log messages (XP128/XP1024/XP12000) . . . . .	399
77	BC operational requirements for XP128/1024 . . . . .	416
78	Number of pairs that can be created with volumes of each emulation type and capacity . . . . .	418
79	BC operational requirements for XP12000 . . . . .	419
80	Relationship between emulation type, capacity, and differential tables . . . . .	421
81	Number of differential tables used in OPEN-V . . . . .	421
82	BC pairresync parameter requirements . . . . .	431
83	BC options types and requirements . . . . .	435
84	Relationship between L1 pair status and L2 pair operations. . . . .	438
85	Relationship between L2 pair status and L1 pair operations. . . . .	438
86	Read/write operation (host to the node volume) and L1/L2 pair status . . . . .	439
87	Read/write operation (host to the leaf volume) and L2 pair status . . . . .	439
88	BC pair status conditions . . . . .	443
89	Identifying the volumes for BC operations . . . . .	445
90	BC tree icons. . . . .	451
91	Status icons for BC. . . . .	451
92	BC operations shortcut menu commands . . . . .	455
93	BC pair activity codes, messages, and descriptions . . . . .	476
94	BC error codes . . . . .	478
95	CA supported RAID level configurations . . . . .	489
96	Sidefile threshold values for CA Asynchronous operations and write pending operations . . . . .	496
97	CA Asynchronous pair status descriptions. . . . .	498
98	CA split types (PSUS) . . . . .	500
99	Consistency status descriptions for split/suspended CA Async S-VOLs . . . . .	501
100	CA suspend types. . . . .	502
101	CA Asynchronous suspension conditions . . . . .	503
102	Host pair status reporting for CA, BC, and CA/BC shared volumes . . . . .	513
103	Data Currency of a shared CA/BC volume . . . . .	513
104	CA functions . . . . .	516
105	Volume icons for CA operations . . . . .	519
106	Status icons for CA operations . . . . .	519
107	Snapshot functions . . . . .	522
108	Logical path status . . . . .	536
109	Remote copy I/O statistics . . . . .	557
110	Disk array performance conditions and recommendations . . . . .	559
111	Fence-level settings on CA Sync P-VOLs . . . . .	583
112	Determining CA Synchronous S-VOL currency based on its pair status and P-VOL fence-level setting . . . . .	586
113	Determining CA Async S-VOL consistency based on its pair status and consistency status . . . . .	587
114	Metadata information . . . . .	604
115	CA Journaling data volume pair status . . . . .	609
116	CA Journaling split types (PSUS). . . . .	611
117	Consistency status for split/suspended CA Journaling secondary data volumes. . . . .	611
118	Suspend types (PSUE) . . . . .	613
119	CA Journaling suspension conditions. . . . .	614
120	Supported emulation types. . . . .	616
121	Supported Data Volume and Journal Volume . . . . .	616
122	Specifications for logical volumes that can form pairs . . . . .	617
123	Journal volume specifications . . . . .	617
124	RAID-level configuration of CA Journaling . . . . .	617
125	Journal group specifications. . . . .	619
126	Volume Specifications in Journal Group. . . . .	619
127	Host pair status reporting for CA Journaling/Business Copy XP shared volumes . . . . .	629
128	Data currency of a shared CA Journaling/Business Copy XP volume. . . . .	629

129	Logical path status . . . . .	645
130	Remote Copy I/O Statistics . . . . .	680
131	General troubleshooting information for CA Journaling . . . . .	690
132	Troubleshooting problems with status of logical paths . . . . .	691
133	Troubleshooting Suspended CA Journaling pairs . . . . .	694
134	Resolving CA Journaling pair suspension . . . . .	695
135	Comparison of Flex Copy with External Storage XP . . . . .	704
136	Flex Copy capacities. . . . .	706
137	Relationship between emulation type, capacity, and differential tables . . . . .	711
138	Number of differential tables used in OPEN-V . . . . .	712
139	Transitions of Flex Copy pair status. . . . .	721
140	Pair status displayed by RAID Manager XP . . . . .	722
141	Requirements for Flex Copy and Business Copy XP operations . . . . .	724
142	Examples of RAID Manager XP command . . . . .	731
143	Flex Copy reference codes . . . . .	749
144	General Flex Copy troubleshooting. . . . .	751
145	External Storage XP requirements . . . . .	764
146	Items appearing in the Device List. . . . .	778
147	Possible values of LU status . . . . .	779
148	General External Storage XP troubleshooting . . . . .	812
149	Volume capacity information for each emulation type . . . . .	818
150	Fibre Channel port icons for Direct Backup Engine operations . . . . .	823
151	RCU path status troubleshooting . . . . .	838
152	Suspended CA pairs troubleshooting . . . . .	840
153	CA Async Suspension Conditions . . . . .	841

---

# About this guide

This guide provides information about:

- Using administration features to manage:
  - User profiles and disk array sessions
  - Applications installed on Command View management station
  - Disk arrays added to Command View
- Viewing recent disk array events and error conditions
- Displaying identity and status information about disk arrays
- Accessing additional help and support information
- Managing the HP StorageWorks XP Disk Array XP48, XP128, XP512, XP1024, and XP12000

---

## Intended audience

This guide is intended for customers and HP authorized service providers experienced with the following:

- Disk array hardware and software
- Storage systems

---

## Prerequisites

Prerequisites for using this product include:

- Install or upgrade to most recent version of Command View XP
- Set up the HP StorageWorks XP disk arrays
- Install Path Connectivity
- See the `readme.txt` file on the CD for last-minute announcements

---

## Related documentation

In addition to this guide, please refer to other documents for this product:

- *HP StorageWorks Command View XP Installation Guide*
- *HP StorageWorks Command View XP Path Connectivity User Guide*
- *HP StorageWorks Command View XP Path Connectivity Command Line Interface (CLI) Reference Guide*
- *HP StorageWorks Command View XP Command Line Interface (CLI) Reference Guide*

These and other HP documents can be found on an HP web site: <http://www.hp.com/support/>. Online help is also available for this product by clicking on the help icon located on the Command View management station.

## Document conventions and symbols

**Table 1** Document conventions

Convention	Element
Medium blue text: <a href="#">Figure 1</a>	Cross-reference links and e-mail addresses
Medium blue, underlined text ( <a href="http://www.hp.com">http://www.hp.com</a> )	Web site addresses
<b>Bold font</b>	<ul style="list-style-type: none"><li>• Key names</li><li>• Text typed into a GUI element, such as into a box</li><li>• GUI elements that are clicked or selected, such as menu and list items, buttons, and check boxes</li></ul>
<i>Italics font</i>	Text emphasis
Monospace font	<ul style="list-style-type: none"><li>• File and directory names</li><li>• System output</li><li>• Code</li><li>• Text typed at the command-line</li></ul>
<i>Monospace, italic font</i>	<ul style="list-style-type: none"><li>• Code variables</li><li>• Command-line variables</li></ul>
<b>Monospace, bold font</b>	Emphasis of file and directory names, system output, code, and text typed at the command-line



**CAUTION:** Indicates that failure to follow directions could result in damage to equipment or data.



**IMPORTANT:** Provides clarifying information or specific instructions.



**NOTE:** Provides additional information.



**TIP:** Provides helpful hints and shortcuts.



---

# HP technical support

Telephone numbers for worldwide technical support are listed on the HP web site:  
<http://www.hp.com/support/>.

Collect the following information before calling:

- Technical support registration number (if applicable)
- Product serial numbers
- Product model names and numbers
- Applicable error messages
- Operating system type and revision level
- Detailed, specific questions

For continuous quality improvement, calls may be recorded or monitored.

HP strongly recommends that customers sign-up online using the Subscriber's choice web site at  
<http://www.hp.com/go/e-updates>.

- Subscribing to this service provides you with email updates on the latest product enhancements, newest versions of drivers, and firmware documentation updates as well as instant access to numerous other product resources.
- After signing-up, you can quickly locate your products by selecting **Business support** and then **Storage** under Product Category.

## HP-authorized reseller

For the name of your nearest HP-authorized reseller:

- In the United States, call 1-800-345-1518
- Elsewhere, visit <http://www.hp.com> and click **Contact HP** to find locations and telephone numbers

## Helpful web sites

For third-party product information, see the following vendor web sites:

- <http://www.hp.com>
- <http://www.hp.com/go/storage>
- <http://www.hp.com/support>



# 1 Getting started

HP StorageWorks Command View XP is a Web-based storage management platform that monitors and configures the HP StorageWorks Disk Array XP family of products. You can access Command View from remote locations using the Internet and a Web browser, which allows you to manage the disk arrays from any location worldwide.

Command View is part of a total Storage Area Network (SAN) solution and runs on a Windows-based workstation, which is called the Command View management station. Disk array control from the management station is accomplished over the corporate LAN.



**NOTE:** HP StorageWorks XP256 is not supported by Command View 2.1 except as external storage.

## Host agents

Command View is distributed with Path Connectivity. If you are using the Path Connectivity module, you can install small portions of the Command View software (host agents) on host systems in the SAN that consume disk storage space.

Command View host agents use the network to send statistics about disk array consumption to the Command View management station. Because of this, Command View provides reports that describe disk consumption per host system. To access this information, click the **Path Connectivity** icon on the Command View main window.

## Host operating systems

Command View host agents run on the following host operating systems:

- Windows Server 2003, Enterprise Edition (32- and 64-bit)
- Windows Server 2003, Enterprise/Datacenter Edition (64-bit)
- Windows 2000 Service Pack 4
- HP-UX 11.00, 11.11, 11.23, and 11.23 PI
- Solaris 8 and 9
- Red Hat Enterprise Linux Advanced Server 2.1, kernel 2.4.9 (32-bit)
- Red Hat Enterprise Linux 3.0, kernel 2.4.21 (32-bit)
- UnitedLinux 1.0 (SLES8), kernel 2.4.19/2.4.21 (32-bit)
- IBM AIX 5.1 or 5.2

## Integrating with other applications

Command View can be integrated with any management platform that supports Web applications. For example, Command View integrates with the HP OpenView Network Management platform and HP OpenView Storage Area Manager.

You can also integrate optional “snap-in” application modules. As shown in [Figure 1](#), HP StorageWorks Application Policy Manager and HP StorageWorks Performance Advisor XP are integrated with Command View.



**NOTE:** Application Policy Manager is not supported for the XP12000. For similar functionality, refer to HP Performance Control XP on page 399.

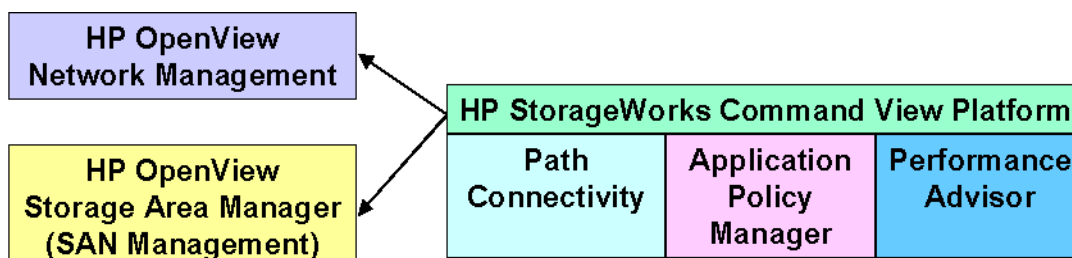

**Figure 1** Command View integrated with other management platforms and application modules

## Features

**Table 2** Command View features

Feature/module	Description
<b>Array Manager</b>	Controls access to the Command View management station and the disk arrays and provides device and session administration.
<b>Event management and history</b>	Archives and distributes traps to configured SAN management stations. Trap messages are converted into readable error messages and are stored in log files for viewing.
<b>Systems management and history (XP12000 only)</b>	Provides information about the equipment and the port status of the connected arrays.
<b>Disk array status monitoring</b>	Monitors every aspect of disk array operation.
<b>Path Connectivity</b>	Monitors and reports the connection paths between the disk array and hosts consuming disk space. Diagnoses the “health” of connections. Path Connectivity is included with Command View.
<b>Performance Control (XP1024/XP12000 only)</b>	Allows you to set the priority of disk arrays, monitor I/O rates and transfer rates, and limit the performance of less-critical arrays. Requires the purchase and installation of HP StorageWorks Performance Control XP.
<b>LUN configuration</b>	Provides LUN configuration and management. Requires the purchase and installation of HP StorageWorks LUN Configuration Manager XP (XP48/XP512) or HP StorageWorks LUN Configuration and Security Manager XP - LUN Manager (XP128/XP1024/XP12000).
<b>Disk array security at the disk array controller and LUN level</b>	Manages disk array security at the disk array controller level and the port/LUN level. Requires the purchase and installation of HP StorageWorks Secure Manager XP (XP48/XP512) or HP StorageWorks LUN Configuration and Security Manager XP - Volume Manager (XP128/XP1024/XP12000).

**Table 2** Command View features (continued)

Feature/module	Description
<b>Advanced LUN management</b> (XP128/XP1024/ XP12000 only)	Protects data in your disk arrays from I/O operations performed on open system hosts. Requires the purchase and installation of HP StorageWorks LUN Security XP Extension.
<b>Configuration File Loader</b> (XP128/XP1024/ XP12000 only)	Sets the disk arrays to have the same configuration by applying a configuration definition file that can be edited. Is available preloaded from the factory, and requires the purchase and installation of HP StorageWorks LUN Configuration and Security Manager XP to manage LUN configuration files.
<b>Cache LUN configuration</b>	Manages the placing of data from LUNs into cache memory to improve data access speeds. Requires the purchase and installation of HP StorageWorks Cache LUN XP.
<b>Auto LUN configuration</b> (XP128/XP1024/ XP12000 only)	Manages and optimizes the disk array's storage by performing manual and automatic migration operations. Requires the purchase and installation of HP StorageWorks Auto LUN XP.
<b>Business Copy</b> (XP128/XP1024/ XP12000 only)	Maintains internal copies of user data on the disk array for purposes such as data backup or duplication. Business Copy is used for open system data. Requires the purchase and installation of HP StorageWorks Business Copy XP.
<b>Continuous Access and Continuous Access Extension</b> (XP128/XP1024/ XP12000 only)	Creates and maintains duplicate copies of user data from a local disk array on a remote disk array. These copies are useful for data duplication, backup, and disaster recovery. Continuous Access is used for open system data. Requires the purchase and installation of HP StorageWorks Continuous Access XP and XP Extension.
<b>Direct Backup Engine</b> (XP128/XP1024/ XP12000 only)	Combined with a backup application installed on a host server, provides server-free backup between the disk array and the backup devices connected to the host server. Requires the purchase and installation of HP StorageWorks Direct Backup Engine XP.
<b>External Storage XP (XP12000 only)</b>	Connect different types of HP or non-HP external storage devices to an HP StorageWorks XP12000 disk array, and map and access Logical Units (LUs) on external devices as if they were part of the XP12000 array.
<b>Hitachi ShadowImage for z/OS® and Hitachi FlashCopy</b> (XP128/XP1024/ XP12000 only) <sup>1</sup>	Hitachi ShadowImage for z/OS® provides local copy for mainframe volumes. Requires the purchase and installation of Hitachi ShadowImage for z/OS (included with HP StorageWorks Business Copy XP). Hitachi FlashCopy requires the purchase and installation of both ShadowImage XP and Hitachi FlashCopy.
<b>Hitachi TrueCopy and TrueCopy Asynchronous for z/OS®</b> (XP128/XP1024/ XP12000 only) <sup>1</sup>	Provides remote copy for mainframe volumes. Requires the purchase and installation of Hitachi TrueCopy and TrueCopy Asynchronous for z/OS (included with HP Continuous Access XP and HP Continuous Access XP Extension).
<b>Hitachi Parallel Access Volumes for z/OS® (XP128/XP1024/ XP12000 only)<sup>1</sup></b>	Allows a mainframe host system to issue multiple I/O requests in parallel to logical devices on the disk array. When Hitachi Parallel Access Volumes is used, the mainframe host has substantially faster access to the data stored on the disk array. Requires the separate purchase and installation of Hitachi Parallel Access Volumes.

**Table 2** Command View features (continued)

Feature/module	Description
<b>Hitachi LDEV Guard for z/OS® (XP128/XP1024/XP12000 only)<sup>1</sup></b>	Protects data in your disk arrays from I/O operations performed on mainframe hosts. Requires the purchase and installation of Hitachi LDEV Guard for z/OS.
<b>Hitachi SANtinel for z/OS® and SANtinel Port Security Option (XP128/XP1024/XP12000 only)<sup>1</sup></b>	Applies security to logical volumes to prevent specified mainframe hosts from reading and writing to the specified logical volumes. Requires the purchase and installation of Hitachi SANtinel for z/OS. The Port Security Option provides port-level security. SANtinel Port Security Option requires the purchase and installation of both Hitachi SANtinel for z/OS and Hitachi SANtinel Port Security Option.

<sup>1</sup>Mainframe features are addressed in the *HP StorageWorks Command View XP for Mainframes User Guide*, which can be found on the product CD.

---

## Communicating with the disk arrays

The Command View platform uses Remote Method Invocation (RMI) and Simple Network Management Protocol (SNMP) to communicate with the disk arrays and host agents.

SNMP operation varies slightly when working with different members of the XP disk array family.

### XP128/XP1024/XP12000

Communication with the disk array is through the RMI interface. The RMI server resides on the disk array.

### XP48/XP512

Communication with the disk array is through FTP/SNMP. The SNMP agent resides on the disk array. The disk array sends SNMP traps to the Command View management station. The license key for the SNMP agent must be installed on the disk array.

---

## Starting Command View from a browser

1. Start the browser and enter the Command View management station's host name or IP address as the URL.  
or  
Point your browser directly at the array public IP address (for example, <http://123.45.67.890>).

The Command View initial window appears.

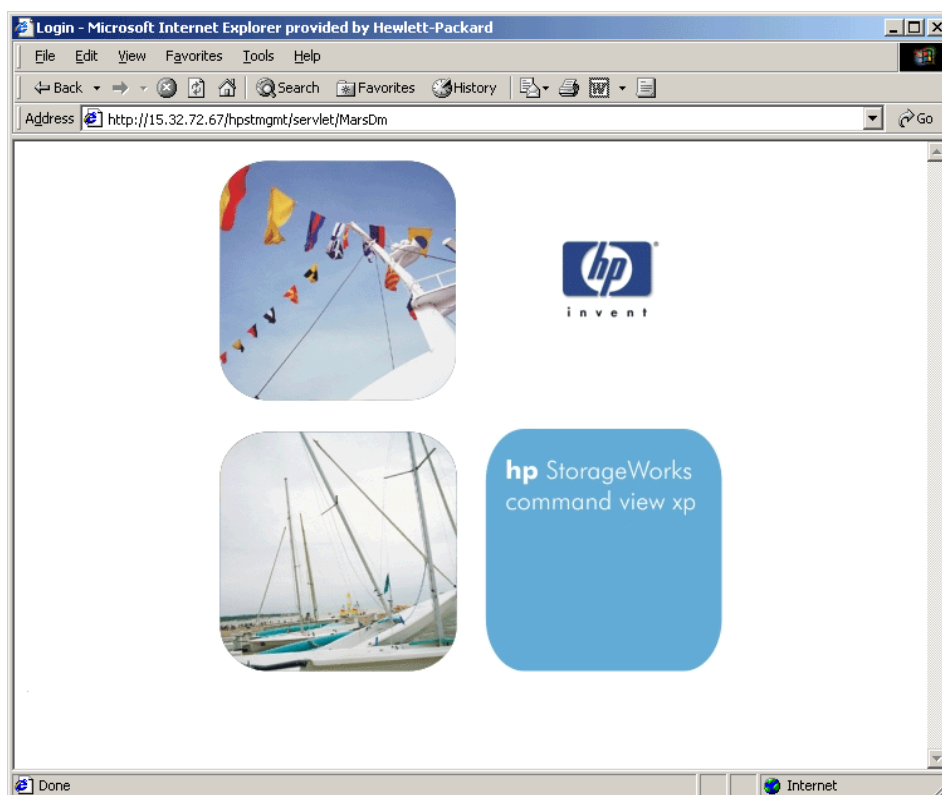

**Figure 2** Command View initial window

A login dialog box appears.

2. Enter the user name and password, and click **OK**. See “[Default user names and passwords](#)” on page 43 for additional information.
3. After the user name and password are verified, the Command View main window appears ([Figure 3](#)).

## Default user names and passwords

When you start Command View for the first time, log in with one of the default user names. Use the Security functions to add new users and set their access privileges (see “[Security system](#)” on page 57).

### Default administrator

- User name: administrator
- Password: administrator

This login provides both modify and view-only access.

### Default user

- User name: user
- Password: user

This login provides view-only access for the default user. A user with view-only access cannot make configuration changes.

### Default storage administrator

- User name: storageadmin

- Password: storageadmin

This login provides modify access for the default storage administrator for array configuration operations and view-only access for framework operations.

## Specifications and restrictions for logon operations

The specifications and restrictions shown in [Table 3](#) apply to the XP128/XP1024/XP12000 unless otherwise stated.

**Table 3** Specifications and restrictions for logon operations

Item	Specification
Maximum number of concurrent users	<p>The XP12000 supports up to 32 concurrent users, but only one user can be in Modify mode at a time.</p> <hr/> <p><b>NOTE:</b> The maximum number of concurrent users for accessing Auto LUN and executing the Export Tool is two.</p> <hr/>
Logging in to the same array management server more than once concurrently	The same user (ID) may not have multiple concurrent sessions with the same array management server.
Login history	All login information, including user IDs and login and logoff times, is recorded in the login history, which can be viewed by a user belonging to the Administrators group. This information is accessed from the Control Panel.
Automatic logoff operation	Any user who cannot perform Command View operations for a specific period of time because of a network error will be automatically logged off from the array. The default is 60 minutes; however, a user belonging to the Administrators group can specify a different amount of time. To change the time, edit the SESSION_TIMEOUT_PLAN value in the CommandView.properties file (see <a href="#">"Changing the session timeout value"</a> on page 56 for more information).

## Starting Command View from Storage Area Manager

HP OpenView Storage Area Manager discovers Command View and formulates the required disk array management URL for each disk array managed by Command View. Refer to the HP OpenView Storage Area Manager documentation for information about Storage Area Manager operations.



# Command View main window

The Command View main window is the first window that appears when you log into Command View.

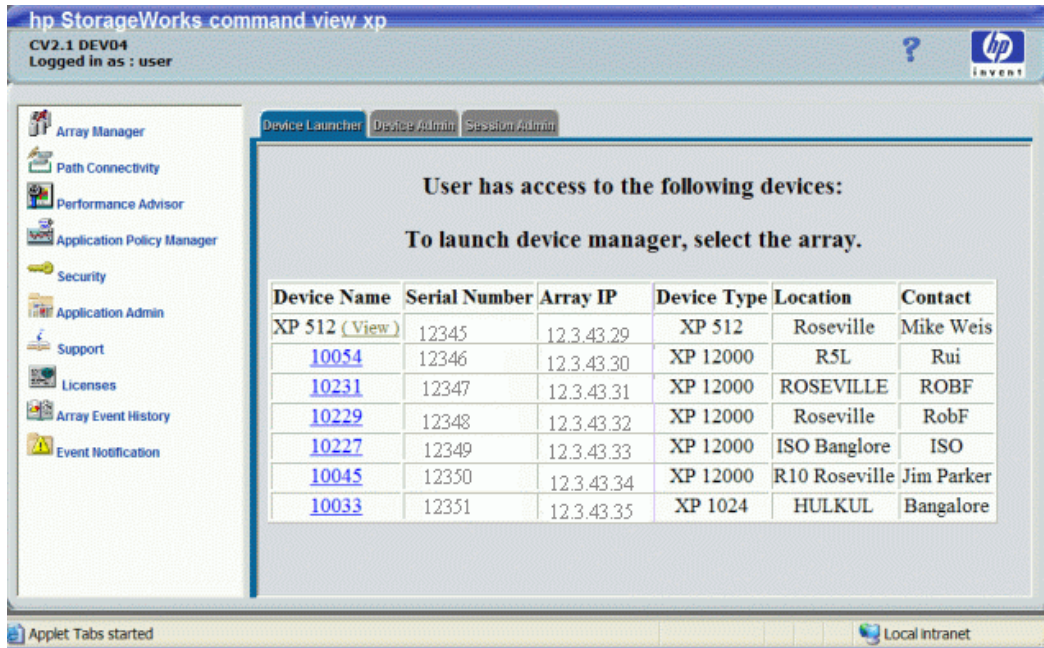

**Figure 3** Command View main window

The left pane provides a list of Command View features, including optional installations. For example, Path Connectivity is an optional installation and will only be available if it was installed with Command View. Performance Advisor and Application Policy Manager will only be available if these products were purchased separately and installed.

The right pane, associated with the Array Manager feature, includes three tabs: Device Launcher, Device Administration, and Session Administration.

To launch an XP array, select the array you want to manage from the list in the Device Launcher pane.

See “[Array manager](#)” on page 47 for more information about Array Manager, including guidelines on setting up and managing arrays.

## Using the backup utility

Use the Backup Utility to back up Command View data, settings, and preferences. You can also use this tool to migrate data from an existing management station to a new management station. This tool preserves your data and configuration preferences by saving your existing settings. If needed, you can restore the backup on an existing management station or a new management station.

To use the Backup Utility, both management stations must have Command View 2.0 or later installed. This tool is not compatible with earlier versions of Command View.

## Saving data

1. Click **Start > Programs > HP StorageWorks Command View XP > Backup Utility**. The Backup Utility window appears.
2. Click **Backup**. The Open File dialog box appears.

3. Choose a location, such as a network drive or shared file system, to save the backup file and click **Open**. A confirmation dialog box appears.
4. Click **Yes**. The Backup Progress status window appears.
5. When the backup process is done, the **Finished** button becomes available. Click **Finished**. A confirmation message appears.
6. Click **OK**.

## Restoring data

1. Click **Start > Programs > HP StorageWorks Command View XP > Backup Utility**. The Backup Utility window appears.
2. Click **Restore**. The Open File dialog box appears.
3. Navigate to the location of the backup file and click **Open**. A confirmation dialog box appears.
4. Click **Yes**. The Restore Progress status window appears.
5. When the restore process is done, the **Finished** button becomes available. Click **Finished**. A confirmation message appears.
6. Click **OK**.

## Saving or restoring data from the Windows command line

- To save your files, enter `%HPSS_HOME%\bin\backup target-path`. The *target-path* is the location, such as a network drive or shared file system, to where you want to save the backup file.
- To restore your files, enter `%HPSS_HOME%\bin\restore target-path`. The *target-path* is the location of the backup file.

## 2 Array manager

Array Manager is the default feature that is displayed when you log on to Command View. Array Manager provides the following operations:

- “Device Launcher” on page 47
- “Device Administration” on page 48
- “Session Administration” on page 53



**NOTE:** The figures in this chapter do not necessarily reflect the array you are managing. Slight differences are displayed in Command View, depending on the type of array being managed. Differences are noted in the text.

## Device Launcher

The Device Launcher pane appears when you initially log on to Command View. This pane provides a list of disk arrays that Command View is set up to manage (disk arrays that are added using the *Device Administration Add Array* function [page 50]).

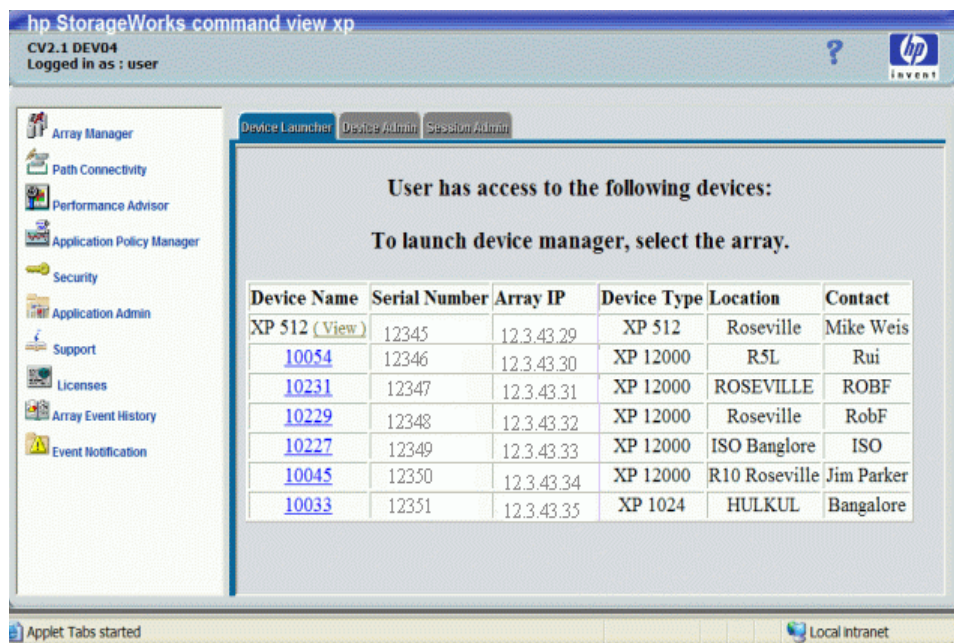

**Figure 4** Device Launcher pane

This pane lists the following items:

- **Device Name:** User-defined nickname that identifies a disk array. It also serves as a link to manage disk arrays. You can create or change this name using the Device Administration functions.
- **Modify link:** (XP48/XP512 only) (*Administrators only*) Click this link to make changes to a disk array’s configuration. For example, when you are in Modify mode, you can delete a LUN from the disk array.

- **View link:** (XP48/XP512 only) Click this link to access the disk array without modification permissions. While in View-only mode, you cannot make changes to the disk array.
- **Serial Number:** Serial number of the disk array. It is filled in automatically when you enter the IP address of the disk array in the Add Array operation under Device Administration.
- **Array IP:** Disk array's IP address
- **Device Type:** Disk array's product name, such as XP12000
- **Location:** Physical location of the disk array. Change this value at any time using the Device Administration pane.
- **Contact:** Person to contact regarding issues with the disk array. You can change this value using the Device Administration pane.

## Launching a disk array

Two methods are provided for launching a disk array, depending on the type of array(s) you want to manage:

- For an XP48/XP512, click the **Modify** or **View** link. Click the **Modify** link if you want to make changes to the selected disk array or view additional features. Click the **View** link to view information about the selected disk array.
- For an XP128/XP1024/XP1200, click the serial number of the disk array. This will launch the Identity pane, where you can modify or view the selected disk array, depending on the user group you belong to. For more information, see "[Security system](#)" on page 57.



**NOTE:** For an XP128/XP1024/XP12000, the Web console GUI can be launched directly (without Command View XP) by using the following URL: `http://<SVP IP Address>`. Please note that online help is not available in the Web console GUI.



**NOTE:** Only users belonging to the Administrators and StorageAdmins groups are permitted to make modifications to arrays. For more information about the security features and different user groups in Command View, see "[Security system](#)" on page 57.

---

---

## Device Administration

Use the Device Administration functions to perform the following operations:

- Add a disk array (page 50)
- Delete a disk array (page 51)
- Modify disk array parameters (page 51)
- Set SNMP IP security (page 52)



**NOTE:** Only a user belonging to the Administrators group can perform these operations.

---

# Accessing Device Administration

To access Device Administration, click **Array Manager** in the left pane and then the **Device Administration** tab. The Device Administration pane appears.

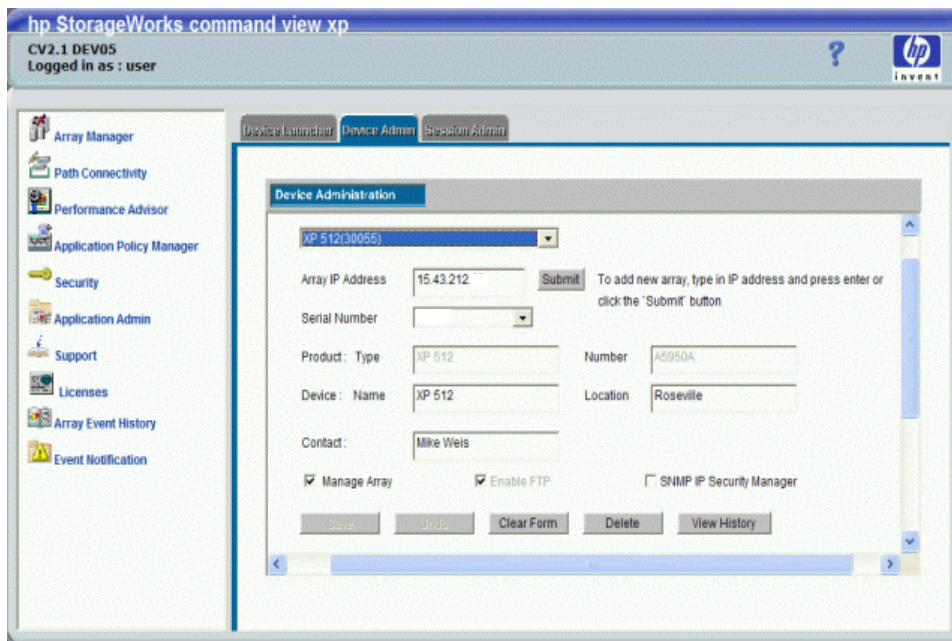

**Figure 5** Device Administration pane

## Display

This pane lists the following items:

- **Device list:** Disk arrays known to Command View. The disk array information is a combination of the serial number and user-assigned name. If you are adding a new disk array, ignore this box. It will display the new disk array after you enter its IP address and name. This is described in [“Adding or registering a disk array”](#) on page 50.
- **Left DKU Type** (XP1024 only): Type of DKUs to the left of the disk controller unit (DKC). An XP1024 may have an XP512 DKU installed in this position.
- **Right DKU Type** (XP1024 only): Type of DKUs to the right of the disk controller unit (DKC). An XP1024 may have an XP512 DKU installed in this position.
- **Array IP Address:** Disk array’s IP address
- **Serial Number:** Serial number of the disk array. It is filled in automatically when you enter the IP address of the disk array in the Add Array operation under Device Administration.
- **Product Type** and **Number:** Product type will be XP48, XP128, XP512, XP1024 or XP12000. Product number is the HP product designation. When you are adding a new disk array, these boxes are automatically updated when you type the IP address.
- **Device Name:** User-defined nickname that identifies a disk array
- **Location:** Physical location of the disk array
- **Contact:** Person to contact regarding issues with the disk array



**NOTE:** You can enter a device name, location, or contact person using up to 180 alphanumeric characters (ASCII codes), except for some symbols, such as “;”, “:”, and “~”.

- **Enable FTP** check box (XP48/XP512 only): Check box is selected by default. Clear this check box to disable the FTP option. By default, FTP will be used for data retrieval.
- **Manage Array** check box: Check box is selected by default. Select this check box to indicate whether or not the disk array will be managed by Command View. If it is not selected, the device will be added to a Command View list of disk arrays, but it will not be managed by Command View. No configuration data will be retrieved. Information about managed disk arrays can be used by other storage management platforms such as Path Connectivity.
- **SNMP IP Security Manager** check box (XP48/XP512 only): When selected, displays the IP Security Manager pane
- **Buttons:**
  - **Save:** Saves disk array information
  - **Undo:** Removes any changes made to the device information displayed, but only those made before you click Save
  - **Clear Form:** Clears data from all the boxes
  - **Delete:** Removes the disk array from the list of devices
  - **View History:** Displays the Device History pane which lists recent device administration events
  - **RMI Server Status** (XP128/XP1024/XP12000 only): Provides a message indicating whether the RMI server on the array is operational or not

## Adding or registering a disk array

When adding an XP128/XP1024/XP12000, all users belonging to the Administrators group and the default user belonging to the User group are automatically added to the array. For this procedure to be successful, a lock on the array is required. If the addition of all users is successful, then the **Save** button is enabled and the device is created after clicking **Save**. If another user is holding a lock on the array (making any modifications to the array), an error message will appear, and the operation will need to be repeated after obtaining the lock.

### To add or register a disk array:

1. From the Device Administration pane, enter the disk array’s IP address in the **Agent IP Address** box.
2. Press **Enter** or click **Submit**.  
The **Serial Number**, **Product Type**, and **Product Number** boxes are filled in automatically.
3. If the **Device Name** box is blank, enter a name for the disk array.
4. For the XP1024 only, select the left DKU type and right DKU type from the lists.
5. If the **Contact** and **Location** boxes are blank, enter a contact name and a location.
6. Select the **Manage Array** check box. This check box is selected by default. If it is not selected, the disk array is added to Command View’s list, but it will not be managed by Command View. No configuration data will be retrieved.
7. For the XP128/XP1024/XP12000 only, click **Save**. A box will appear with two text fields of which one is non-editable and has the value “administrator.” The other field will ask for a password. The password needed is the one that corresponds to the “administrator” account when launching the Web GUI directly from the array. It will be the same as that for the “administrator” account of the last Command View management station used to actively manage the array. If the array has never been



managed by Command View, the password will be the same as the Command View default password. If adding device is successful, Command View administrator's password will replace the password that was used to add the device.

8. Click **OK** after providing the password.

## Deleting or unregistering a disk array

You cannot delete or unregister a device that is in use. If the device is in use, go to the Session Administration pane, select the disk array, and click **End Session**. When the device is no longer in use, return to the Device Administration pane.

### To delete or unregister a disk array:

1. From the Device Administration pane, select the disk array you want to delete from the **Device** list.
2. Clear the **Manage Array** check box. A managed disk array cannot be deleted.
3. Click **Save**.
4. Select the disk array again.
5. Click **Delete**.
6. A dialog box will display a confirmation message. Click **OK** to delete the device or click **Cancel** to return to the Device Administration pane.



**NOTE:** When an array is deleted, the users who were assigned to that array will be unassigned and the database will be updated; however, users registered in the SVP for the XP128/XP1024/XP12000 will not be deleted.

---

## Changing disk array parameters

### To change the disk array parameters:

1. From the Device Administration pane, select the disk array that has information you want to modify from the **Device** list.
2. Modify the parameters (name, location, contact name, and so on). To clear all the boxes, click **Clear Form**. To cancel all your changes, click **Undo**.
3. To save all changes, click **Save**.

## Viewing device history

### To view recent device administration events:

1. From the Device Administration pane, select the disk array whose history you want to view from the **Device** list.

2. Click **View History**. The Device History pane appears.

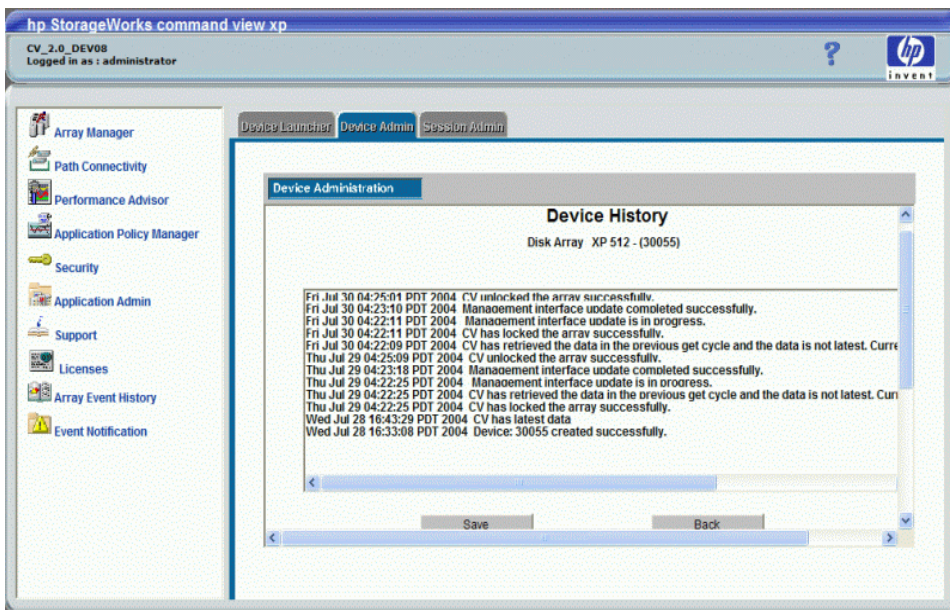

**Figure 6** Device History pane

3. To save the device history to a text file, click **Save** and complete the required steps to save the file to your computer.
4. When you finish viewing events, return to Device Administration pane by clicking **Exit**.

## Setting SNMP IP Security (XP48/XP512 only)

SNMP IP Security is a facility for managing SNMP IP Security from Command View. It is a tool for controlling which SNMP managers can access a disk array.

Limiting disk array access to specified SNMP managers reduces the possibility that unauthorized persons can access the disk arrays. It makes SNMP communication safer over the network.

Using SNMP IP Security, only registered IP addresses can access the disk array via SNMP. Otherwise (the default condition), the SNMP interface is open to all management stations that “speak” SNMP. The registered IP addresses are stored on the disk array. The disk array keeps a list of up to 32 IP addresses to which it can send SNMP messages.

### Use SNMP IP Security to perform the following tasks:

- Display a list of SNMP manager IP addresses registered in the disk array (page 53)
- Add SNMP managers to the disk array’s list (page 53)
- Delete SNMP managers from the disk array’s list (page 53)

## Disabling SNMP IP Security

Disabling SNMP IP Security gives all SNMP Managers access to the MIB database on the disk array. To do this, first delete all the other SNMP Managers. Then, delete the Command View SNMP Manager’s IP address.

Note that if at least one SNMP manager is registered, then the IP Security function is ON and does not allow any other SNMP manager to access the MIB.



## Accessing SNMP IP Security

To access **SNMP IP Security**:

1. From the Device Administration pane, click an existing disk array or add a new disk array.
2. Select the **SNMP IP Security Manager** check box. The IP Security Manager pane appears.

The list box on this pane will display all IP addresses registered in the disk array.

Note that IP security applies only to the disk array selected. Perform this operation for each disk array requiring IP security.

## Adding SNMP IP Security

To add **SNMP IP Security**:

1. From the IP Security Manager pane, enter the IP Address in the **SNMP Manager's IP Address** box. The IP address of the Command View management station always needs to be included when security is being enabled.
2. Click **Add**. The IP address is added to the list in the list box.
3. Click **OK** to add the address to the list. A confirmation dialog box appears.
4. Click **OK** to confirm and return to the Device Administration pane.
5. After the operation has been completed, a confirmation dialog box appears.
6. Click **OK** to continue.

## Removing SNMP IP Security

To remove **SNMP IP Security**:

1. From the IP Security Manager pane, click an address in the list box.
2. Click **Delete**. A confirmation dialog box appears.
3. Click **OK**.
4. To return to the Device Administration pane, click **OK**. A confirmation dialog box appears.
5. Click **OK** to confirm and return to the Device Administration pane.
6. After the operation has been completed, a confirmation dialog box appears.
7. Click **OK** to continue.

---

# Session Administration

Use Session Administration to view information about disk array CLI and GUI sessions and to end user sessions.

Multiple users can access a disk array simultaneously. Only one user is allowed to be in Modify mode, but there can be many view-only users.

Modify or view-only status is determined by user permissions (set using the Security feature). Only users belonging to the StorageAdmins and Administrators groups can make modifications. To make modifications, these users will need to obtain a lock on the array and be in modify mode (using the Identity pane).

If a session is inactive after a certain period of time because a user has not used the system, Command View automatically terminates the session. The default is 60 minutes, which can be changed. To change the value, edit the `SESSION_TIMEOUT_PLAN` value in the `CommandView.properties` file (see ["Changing the session timeout value"](#) on page 56 for more information).

# Accessing Session Administration

To access Session Administration, click **Array Manager** in the left pane and then the **Session Administration** tab. The Session Management pane appears.

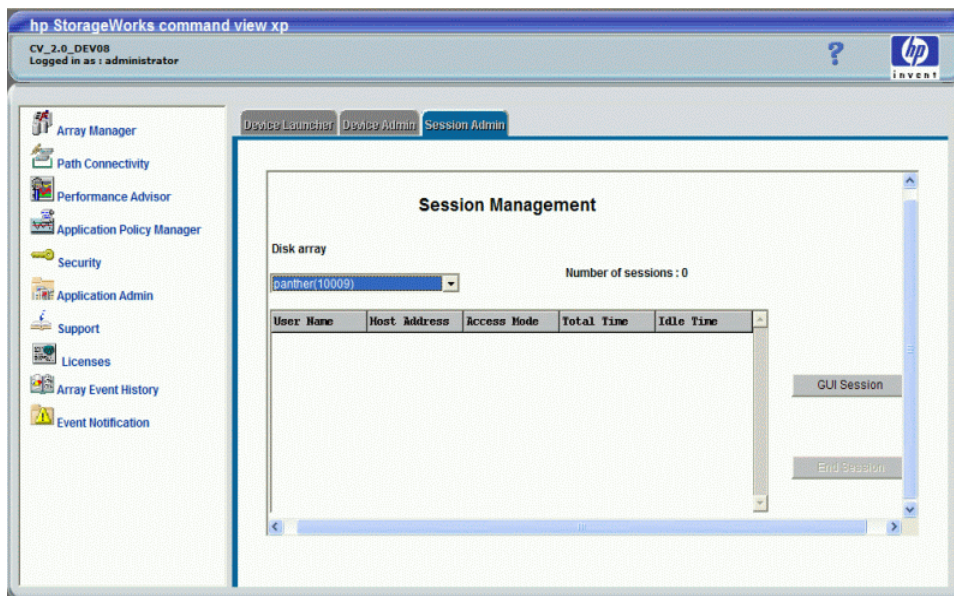

Figure 7 Session Management pane

## Display

This pane lists the following items:

- **Disk Array:** List of disk array names
- **Number of Sessions:** Number of GUI or CLI sessions in progress for the selected disk array
- **User Name:** Names of users who are in session with the disk array
- **Host Address:** IP address of the user's workstation
- **Access Mode:** "Modify mode" or "View mode"
- **Total Time:** Time the user has been in session with the disk array
- **Idle Time:** Time that has elapsed since the user has executed a command
- Buttons:
  - **GUI Session** (XP128/XP1024/XP12000 only): View GUI sessions for the selected disk array
  - **End Session:** Ends the session for a selected user

## GUI and CLI sessions

When you first open the Session Management pane, both CLI and GUI sessions will be shown for the XP48/XP512. Only CLI sessions will be displayed for the XP128/XP1024/XP12000. To access GUI sessions for these arrays, click the GUI Session button, which will display after an XP128/XP1024/XP12000 array has been selected. A new window will display, listing GUI sessions.

The GUI Session pane consists of the following items:

- **User Name:** Names of users who are in session with the disk array
- **SLPR #:** SLPR number of the user's session. Please see note, below.

- **Host Address:** IP address of the user's workstation
- **Access Mode:** "Modify Mode" or "View Mode"
- **Time:** Time the user has been in session with the disk array



**NOTE:** The SLPR# column in the GUI Session pane provides the SLPR number of the user's session. Because users belonging to different partitions can concurrently lock their portion of XP12000 arrays, the partition number will be displayed for each session. If the session is for users having full array access, the SLPR column will have the value "All." The SLPR# column will also appear for XP128/XP1024 arrays; however, because partitioning is not currently supported for these arrays, the value of that column will always appear as "All."

---

## Viewing GUI sessions (XP128/XP1024/XP12000)

1. From the Session Administration pane, click a disk array from the list. Both **GUI Session** and **End Session** buttons will display.
2. Click **GUI Session**.
3. A message appears, asking if you want to display all GUI sessions for the array. Click **OK** to access a new pane showing all GUI sessions or Click **Cancel** to return to the Session Administration pane.

## Ending a session (XP48/XP512)



**NOTE:** Only users belonging to the Administrators group can end CLI and GUI sessions.

1. From the Session Administration pane, click a disk array from the list. All sessions for that disk array are displayed.
2. Click the session you want to end.
3. Click **End Session**. A confirmation message appears.
4. Click **OK** to end the session.

When you end a user's session, the user must log in again to access Command View.

## Ending a session (XP128/XP1024/XP12000)



**NOTE:** Only users belonging to the Administrators group can end CLI and GUI sessions.

1. From the Session Administration pane, click a disk array from the list. All sessions for that disk array are displayed.
2. Click the session you want to end.
3. Click **End Session**. A confirmation message appears.
4. Click **OK** to end the session.

When you end a user's session, the user must log in again to access Command View.

### To end a GUI session:

1. From the Session Administration pane, click a disk array from the list. Both GUI Session and End Session buttons will display.
2. Click **GUI Session**. A message appears, asking if you want to display all GUI sessions for the array. Click **OK** to access the GUI Session pane.

3. Select the session you want to end.
4. Click **End Session**. A confirmation message appears.
5. Click **OK** to end the session.

## Changing the session timeout value

The session timeout value determines how long a session lasts after a user in Modify mode has not used the browser. The default is set to 60 minutes. You cannot change the session timeout value using the Session Administration pane, but you can change the value by editing the `CommandView.properties` file. To do so, follow these instructions:

### To change the session timeout value

1. Locate the `CommandView.properties` file in the `C:\hpss\dm\tomcat\webapps\hpstmgmt\webroot\Stormgmt` directory.
2. Use a word processor or text editor to open the file. Look for the `SESSION_TIMEOUT_PLAN` setting by locating the following line:

```
SESSION_TIMEOUT_PLAN=ONCE:60
```

3. Replace `60` with the number of minutes you want a session to last before it times out due to inactivity (the minimum number of minutes is `10`). This setting is applicable to all XP disk arrays.
4. If you are managing an XP128/XP1024/XP12000, also consider changing `ONCE` to `ALWAYS`. The default is `ONCE:60`.

Most users will want to choose the `ONCE` setting. Using this setting means that Command View checks the `CommandView.properties` file only once, when someone adds a device or restarts the server, and then sets the session timeout value at that time.

Certain users may find they need the flexibility of the `ALWAYS` setting, which ensures that Command View always determines the timeout value. Using this setting means that Command View checks the `CommandView.properties` file every time a user in Modify mode connects to an XP128/XP1024/XP12000 array through the CLI. (This setting is not available when launching the array management screen in the GUI.) You may want to consider using this setting if you or someone else needs to change the timeout value on the array, but you want to override that when using Command View. This setting will add an additional delay of approximately 45 seconds when loading a new window.

If you are managing an XP48/XP512, Command View ignores the `ONCE` or `ALWAYS` setting because the `ALWAYS` setting is not available.

5. Save and close the file.
6. Restart Command View XP Services by clicking **Start > Programs > HP StorageWorks Command View XP > Restart Services**.

# 3 Security system

Command View's integrated security system provides the capability to authenticate and authorize Command View users. Each user is provided with a user name and assigned to a user group, which determines the tasks the user can perform.

Depending on the user group you are assigned to, you will be able to perform some or all of the following tasks using the security feature:

- "Viewing and modifying users" on page 62
- "Changing a user's password" on page 64
- "Determining or modifying array/partition membership" on page 65
- "Viewing and modifying groups" on page 67



**NOTE:** Only users belonging to the Administrators group can add or delete users and change the passwords of others.

## Accessing security

To access the Security functions, click **Security** in the left pane. The Security pane appears.

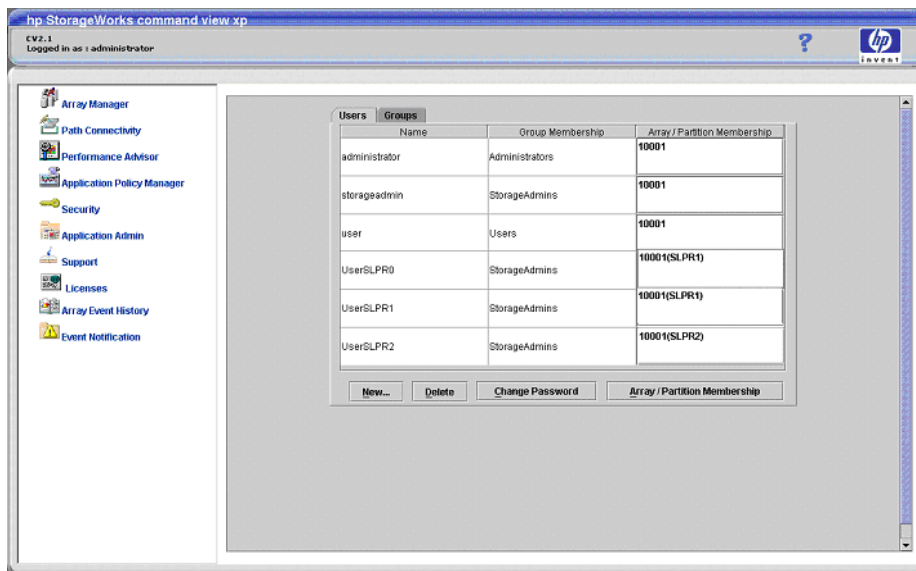

**Figure 8** Security pane

The pane consists of two tabs. Users belonging to the Administrators group can select the **Users** and **Groups** tabs to view and modify security information. Other users can view security information but cannot make modifications.

# CV security system

## Default users

Command View is installed with three default users:

- user
- administrator
- storageadmin

Each of these users belongs to a specific user group, as specified in [Table 4](#). The group membership of these users cannot be changed, and these users cannot be deleted. Only a user belonging to the Administrators group can create additional users in any group.

[Table 4](#) shows the predefined users and their default properties.

**Table 4** Predefined User Properties

User Name	Default Password	User Group
user	user	Users
administrator	administrator	Administrators
storageadmin	storageadmin	StorageAdmins

## User groups

All users of Command View belong to one of the three user groups that have been established in the Command View security system:

- *Users*: Members of this group have read-only access to array management for the arrays assigned to them. They also have read-only access to the Command View framework.
- *Administrators*: Members of this group are administrators of the Command View management station and can perform all tasks related to Command View and the arrays.
- *StorageAdmins*: Members of the group have read/write access to array management for the arrays assigned to them and to snap-in applications. They also have read-only access to the Command View framework.

Users can access the arrays through the GUI or CLI after they have been assigned access by an administrator.

When a user belonging to the *Administrators* group has logged in, all buttons will be enabled, whereas, when a user belonging to the *StorageAdmins* or *Users* group has logged in, only the **Change Password** and **Array/Partition Membership** buttons are enabled.

When a user is created in the *Administrators* group, a lock on the HP StorageWorks XP128/XP1024/XP12000 array is required. If an array is offline or if another user is making modifications to an array, thereby holding a lock on the array, then an error message is displayed and this operation needs to be repeated after making sure that no other user is making modifications.



**NOTE:** If a lock with a red background is displayed in the upper right corner of the Command View window, this signifies that either you or another user has a lock on the array.

When users are created in the *StorageAdmins* or *Users* group, a lock on the arrays is not required because no device is assigned to the users by default. For a detailed description of the roles and responsibilities assigned to each user group, see [Table 5](#).

**Table 5** Group name properties

Group name/Role	Properties
Users Read-only users	<p>This group represents all users who have read-only permissions. Only administrators from the Administrator group can add or delete users from this group. This group and its members are governed by the following rules:</p> <ul style="list-style-type: none"><li>• Only the default user with the user ID of “user” is a permanent member of this group. All other users belonging to this group can be deleted.</li><li>• Read-only access is provided by default to the Command View platform, including user administration, device administration, session administration, and administration of any snap-in applications (Performance Advisor XP and Application Policy Manager XP).</li><li>• Members of this group do not have access to the arrays by default; however, read-only access can be assigned.</li><li>• The default user with a user ID of “user” will have access to all the arrays and full array access in the case of a partitioned XP12000, by default.</li><li>• Read-only access to the arrays is assigned to members of this group by users belonging to the Administrators group.</li><li>• No group-level permission assignments to the arrays are permitted; therefore, access to the arrays must be assigned to each individual user.</li><li>• Users belonging to this group can change their own passwords.</li></ul>

**Table 5** Group name properties (continued)

<b>Group name/Role</b>	<b>Properties</b>
Administrators  Command View management station administrators (a local group)	<p>This group represents all users who are Command View administrators. This group and its members are governed by the following rules:</p> <ul style="list-style-type: none"><li>• Only the default user with the user ID of “administrator” is a permanent member of this group. All other users belonging to this group can be deleted.</li><li>• Modify access is provided to the Command View platform, including device administration, session administration, user administration, license administration, and the administration of any snap-in applications (Performance Advisor XP and Application Policy Manager XP).</li><li>• Modification privileges are provided for all arrays (and, by default, to all partitions in the case of partitioned XP12000 arrays) added to Command View.</li><li>• Modification privileges are provided for assigning or unassigning array membership and partitions.</li><li>• Privileges cannot be modified for individual administrators; in other words, the privileges of the members of this group are fixed and cannot be changed.</li><li>• Users belonging to this group can change the passwords of all users in any group except the password of the default “administrator” user.</li></ul>



**Table 5** Group name properties (continued)

Group name/Role	Properties
<p>StorageAdmins</p> <p>Storage Administrators (users of the storage system)</p>	<p>This group represents all users who are storage-only administrators. This group and its members are governed by the following rules:</p> <ul style="list-style-type: none"> <li>• Only the default user with a user ID of “storageadmin” is a permanent member of this group. All other users belonging to this group can be deleted.</li> <li>• Read-only access is provided by default to the Command View platform, including user administration, device administration, and session administration. For snap-in applications (Performance Advisor XP and Application Policy Manager XP), users belonging to this group have read/write access.</li> <li>• Modification privileges to Command View cannot be assigned to members of this group.</li> <li>• Members of this group do not have access to the arrays by default.</li> <li>• Access to particular arrays (including partitions of XP12000 arrays), allowing modification privileges, can only be assigned to individual users in this group by users belonging to the Administrators group.</li> <li>• No group-level permission assignments to the arrays are permitted; therefore, access to the arrays must be assigned to each individual user.</li> <li>• Whenever a user in this group is given access to an array, his/her user name and password are added to the web console of the array.</li> <li>• Users belonging to this group can only change their own password.</li> </ul>

## Rules for user names and passwords

User accounts and passwords are governed by the following rules:

- User name and password boxes cannot be empty
- User name cannot have more than 16 characters
- Password cannot have more than 32 characters
- User name and password cannot contain any special characters, colons, semicolons, or spaces
- When changing your own password, the new password cannot be the same as the old password.
- User name or password cannot contain any spaces or the following special characters: “, \, ;, :, ,, \$, \_ , \* , ? , < , > , | , ~ , / , ^ , & , and %.



**NOTE:** Only a user belonging to the Administrators group can create user accounts.

# Viewing and modifying users

Click the **Users** tab to access the Users pane and view or make modifications to individual users.



**NOTE:** Only users belonging to the Administrators group can make modifications to individual users; however, all users can change their own passwords.

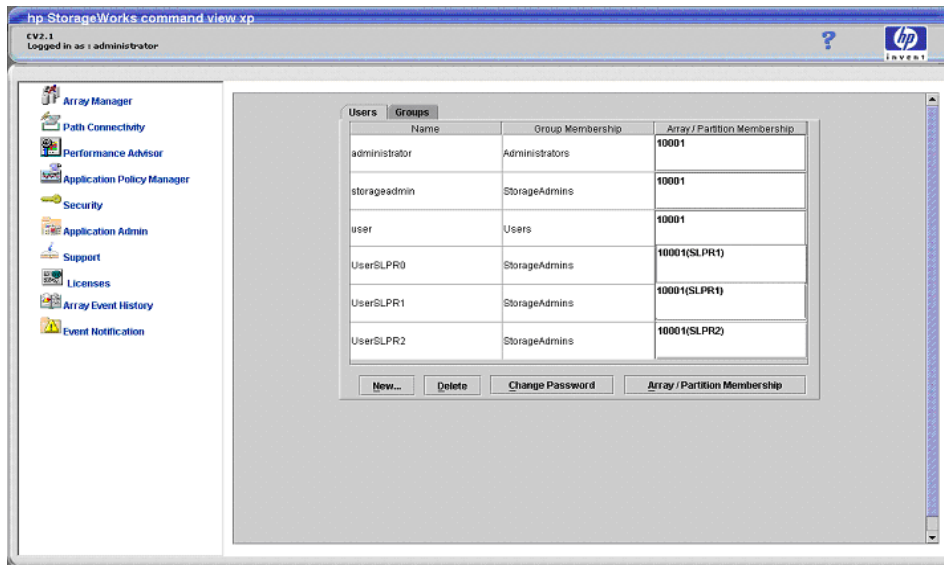

**Figure 9** Users pane

This pane lists the following items:

- **Name:** User name assigned to the user (administrator, storageadmin, or user)
- **Group Membership:** Group the user has been assigned to (Administrators, StorageAdmins, or Users)
- **Array/Partition Membership:** Serial number of the array[s] assigned to the user
- **Buttons:**
  - **New...:** Add a new user
  - **Delete:** Delete a user
  - **Change Password:** Change the password of the selected user
  - **Array/Partition Membership:** View the array and partition membership of the selected user

When a user is assigned to more than three arrays, the **Array/Partition Membership** column appears as a scrollable list for that row.

If no arrays are added to the Command View management station, the **Array/Partition Membership** column appears as a blank non-editable text field and the button is disabled.

All buttons are enabled for users belonging to the Administrators group. Only the **Change Password** and **Array/Partition Membership** buttons are enabled for users belonging to the StorageAdmins and Users groups. For a detailed description of the roles and responsibilities assigned to each user group, see [Table 5](#) on page 59.



**NOTE:** An error message appears if you attempt to make modifications to an array when the array is off-line or in modify mode. Make sure the array is online and that no other user is making modifications to the array whenever you are adding or deleting a user, changing a password, or making modifications to array and partition membership.

## Adding a user

Only a member of the Administrators group can add users. Other users can only view this pane.

To add a new user:

1. Click **Security** in the left pane.
2. Click the **Users** tab.
3. Click **New...** The New User box appears.

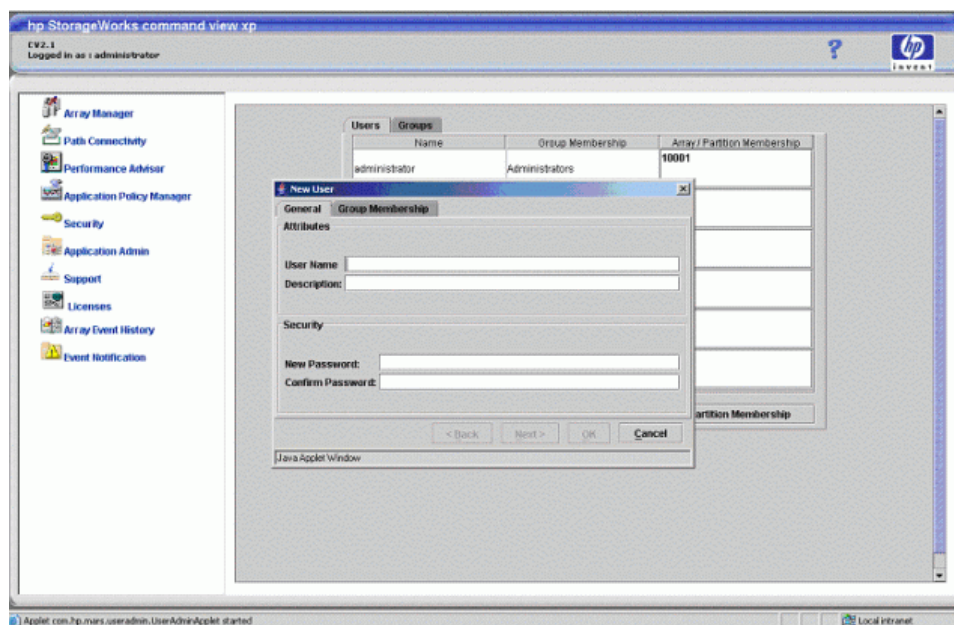

**Figure 10** New user box

4. In the User Name box, enter the name of the user.
5. In the Description box, enter a description of the user's privileges or any other information you would like to retain for the user. For example, a description for a user with administrative privileges could be "Privileged account with read/write access to everything." This box can be left blank.
6. In the New Password box, enter a new password for the user.
7. In the Confirm Password box, enter the password again.
8. Click **Next**. A new box appears.
9. Click to highlight the user group that you want to assign the user to.
10. Click the right-facing arrow to enter the user group name in the right pane.

11. Click **OK**. The **Group Membership** tab appears. The list in the left pane of the box shows the groups the user does not belong to.

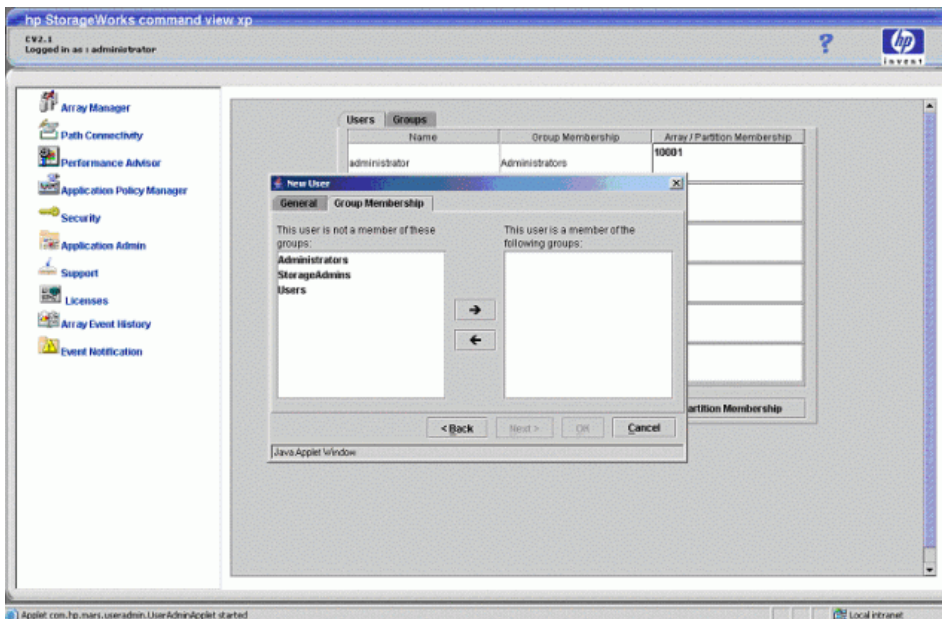

**Figure 11** Group Membership tab

12. Select a group in the list to assign to the new user.
13. Click the right-facing arrow to add the user to the group membership list that appears in the right pane. Please note that a user can only be assigned to one group.
14. Click **OK**. The box will close and the details of the added user are reflected in the Users' list.

## Changing a user's password

Users can change their own passwords. Only members of the Administrators group can change another user's password, with the exception of the password for the default user "administrator", which cannot be changed.



**NOTE:** Password inconsistencies can arise as a result of one or more arrays being offline or being modified by another user. Make sure that the array(s) assigned to the user is online and that no modifications to the array(s) are being made prior to changing a password.

### To change a user's password:

1. Click **Security** in the left pane.
2. Click the **Users** tab.
3. Click to highlight the user whose password you want to change.

4. Click **Change Password**. The Change Password box appears.

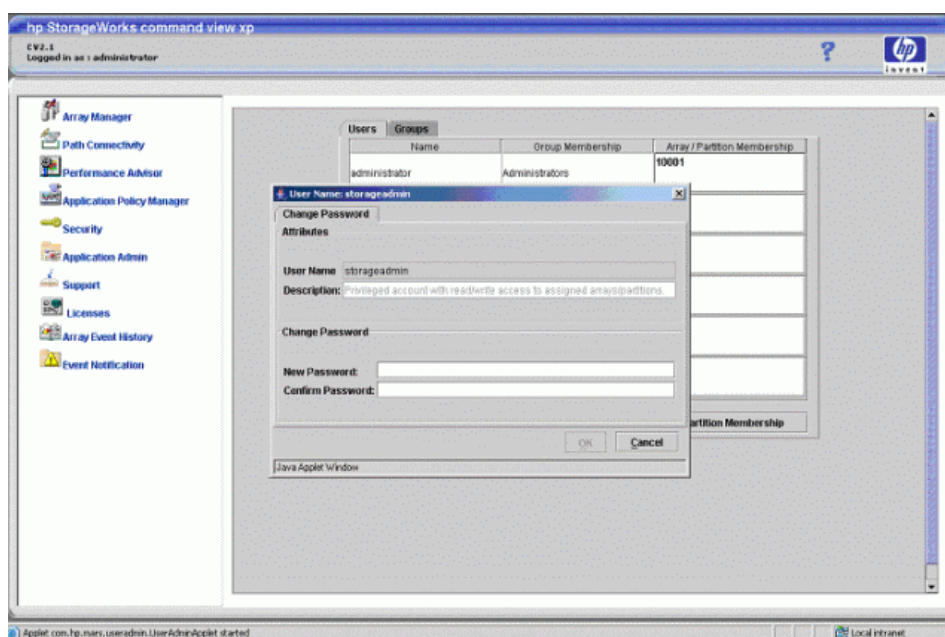

**Figure 12** User Name box

5. In the Old Password box, enter the password previous assigned to the user.
6. In the New Password box, enter the new password. (See the rules for user names and passwords on page 61.)
7. In in the Confirm Password box, enter the password again.
8. Click **OK**.

## Deleting a user

Only a member of the Administrators group can delete users. Other users can only view this pane.

To delete a user:

1. Click **Security** in the left pane.
2. Click the **Users** tab.
3. Click to highlight the user you want to delete.



**NOTE:** Default users cannot be deleted.

4. Click **Delete** and the Confirm Delete User box appears.
5. Click **Yes** to delete the user or click **No** to cancel the operation.

## Determining or modifying array/partition membership

The Array/Partition Membership pane is used to view or change the arrays assigned to specified users. Only a member of the Administrators group can modify array and partition membership.



**NOTE:** Partitioning is only supported for the XP12000. Also the HP XP Disk/Cache Partition license needs to be installed to enable this feature.

### To view or change array/partition membership:

1. Click **Security** in the left pane.
2. Click the **Users** tab.
3. In the Users pane, click to highlight the row containing the name of the user you want to view array access for.
4. Click **Array/Partition Membership**. The Array/Partition Membership box appears.

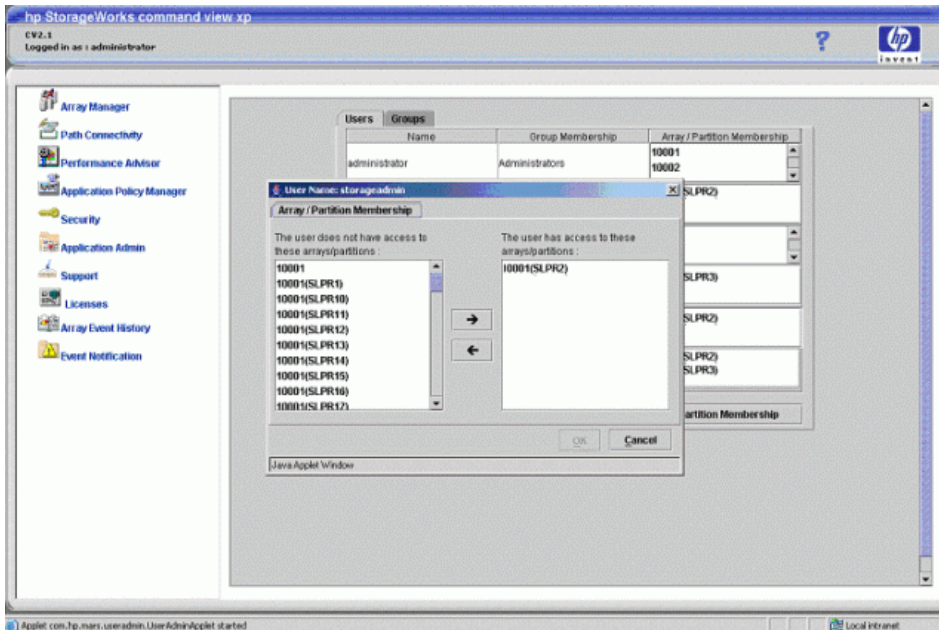

**Figure 13** Array/Partition Membership box

The left pane of the Array/Partition box shows a list of arrays and partitions that are inaccessible, while the right pane lists arrays and partitions that are accessible to the user.



**NOTE:** The partitions shown are not the partitions already created in the arrays, but represent all possible SLPRs (SLPR1 to SLPR31).

To change array/partition membership, continue with the following steps:

5. Click to highlight the array(s) or partition(s) you want to change access to.
6. Use either the right-facing or left-facing arrow to move the arrays or partitions to the appropriate pane.



**NOTE:** A user can be assigned to only one partition in an array.

7. Click **OK** when you are satisfied with your changes. The new array or partition assignments are reflected in the **Array/Partition Membership** column in the Users pane.



# Viewing and modifying groups

## Groups tab

Click the **Groups** tab to access the Groups pane and view or make modifications to user groups.

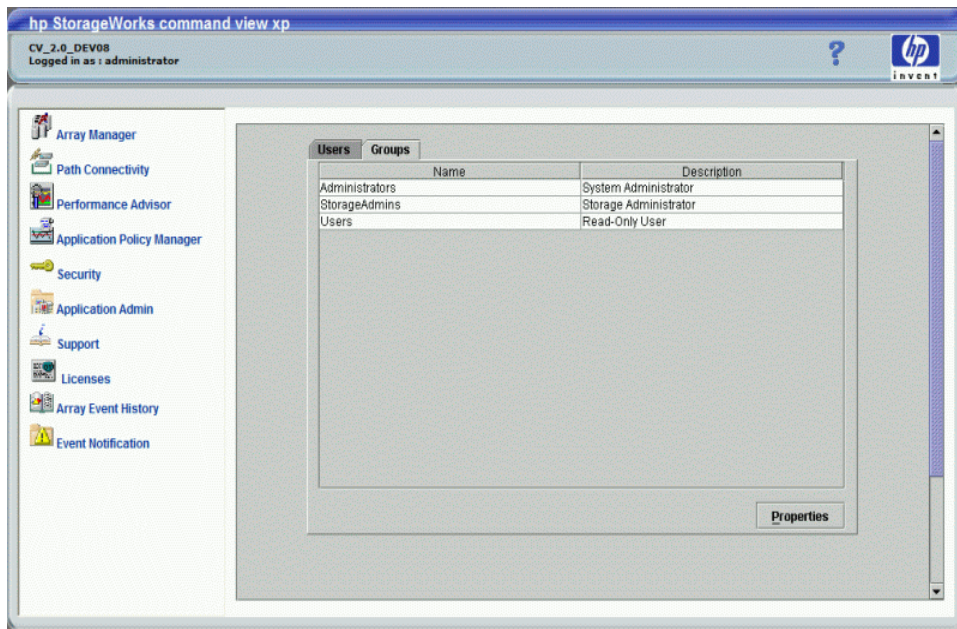

**Figure 14** Groups tab

This pane lists the following items:

- **Name:** List of group names
- **Description:** Shows group's capabilities, such as System Administrator
- **Properties button:** Click to display properties for selected groups.

For a detailed description of the roles and responsibilities assigned to each user group, see [Table 5](#) on page 59.

### To view group properties

1. Click **Security** in the left pane.
2. Click the **Groups** tab.
3. Click to highlight the row of the group you want to view properties for.
4. Click **Properties**.

5. The Properties box appears. It provides the group name and a description of the group you selected in step 3.

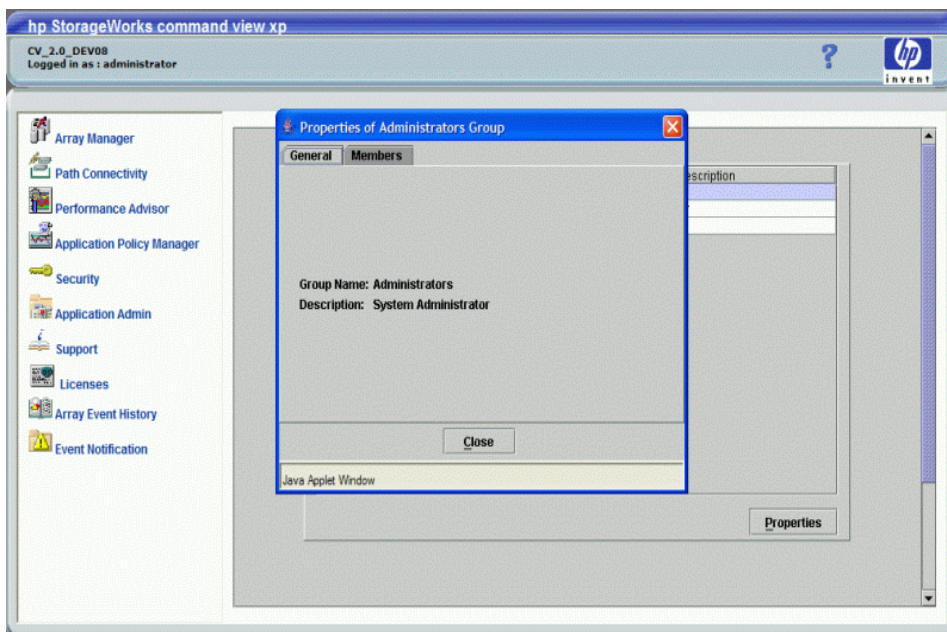

Figure 15 Properties box: General tab

6. Click the **Members** tab to display the users who are members of the group you selected in step 3.

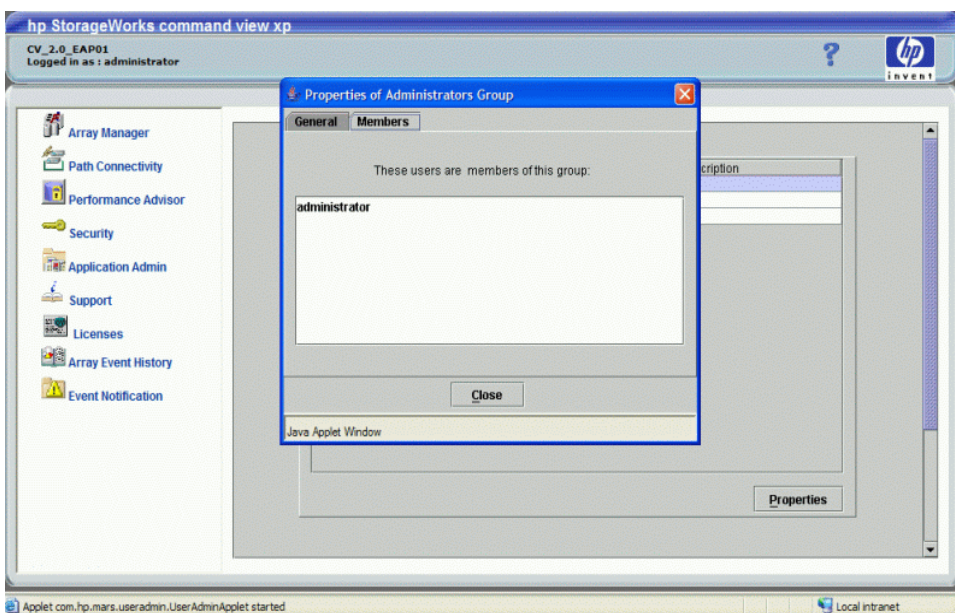

Figure 16 Properties box: Members tab

7. Click **Close** to return to the Groups pane.



# 4 Application Administration

The Application Administration pane shows you the applications that are installed on the Command View management station. You can also use this pane to perform the following operations:

- "Adding Applications" on page 70
- "Deleting Applications" on page 71
- "Editing Application Information" on page 71



**NOTE:** Only users belonging to the Administrators group can add or delete an application or edit information about an application.

## Accessing Application Administration

To access Application Administration, click **Application Admin** in the left pane. The Application Administration pane appears.

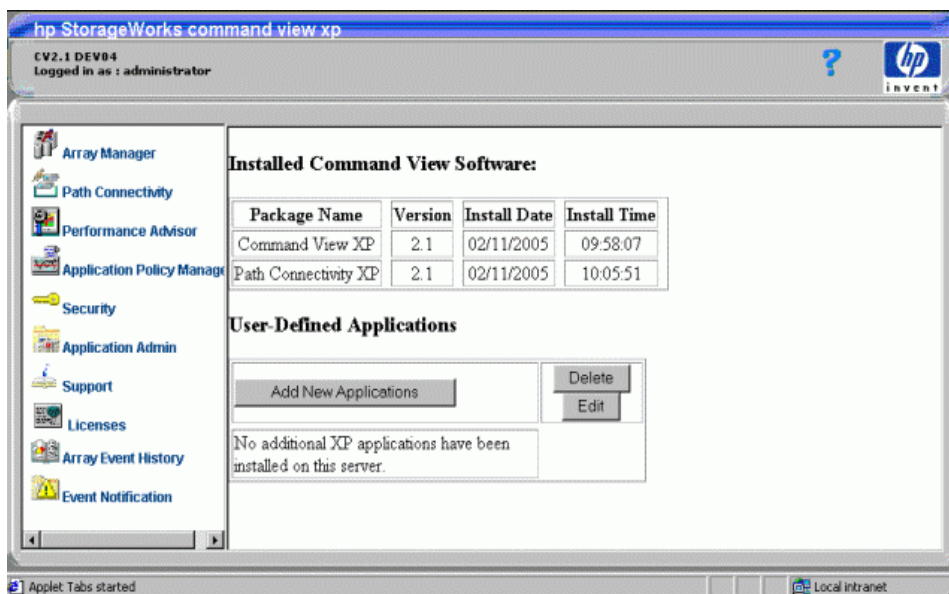

**Figure 17** Application Administration pane

### Display

#### Installed Command View Software section:

This section contains the following items:

- **Package Name:** Names of applications that are already installed on the Command View management station.
- **Version:** Version number of the installed software package.

- **Install Date:** Date the software package was installed. The date format is mm/dd/yyyy.
- **Install Time:** Time the software package was installed.

### User-Defined Applications section:

This section lists details of user-added external applications to which links are provided on the Command View management station.

This section contains the following items:

- **Add New Applications:** Click to add one or more applications.
- **Delete:** Click to delete a user-added application.
- **Edit:** Click to modify a user-added application.

## Adding Applications

1. Click **Add New Applications** in the Application Administration pane. The Add New Application pane appears.



**NOTE:** Only users belonging to the Administrators group can add new applications.

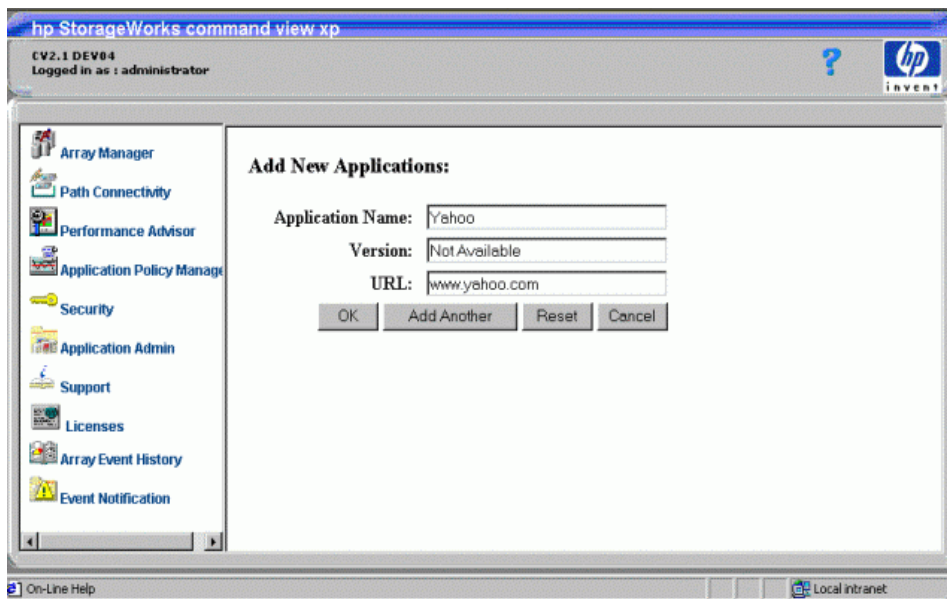

**Figure 18** Add New Applications pane

2. Enter the name of the application you want to add.
3. Enter the version number of the application.
4. Enter the URL where the application is located.
5. To add the application and return to the main Application Administration pane, click **OK**. To add another application click **Add Another**.

Clicking **Reset** will reset the fields to blanks. Clicking **Cancel** will return you to the main Application Administration pane.

When you return to the main Application Administration pane, the display will confirm that the application has been added.

# Deleting Applications

1. From the Application Administration pane (Figure 17), select the check box beside the application you want to delete.
2. Click **Delete**. A message asks, Delete Application Information?
3. Click **OK** to confirm the deletion.

When you return to the main Application Administration pane, the display will confirm that the application has been deleted.

# Editing Application Information

1. Select the check box beside the application you want to edit.
2. Click **Edit**. The Edit Applications pane appears.

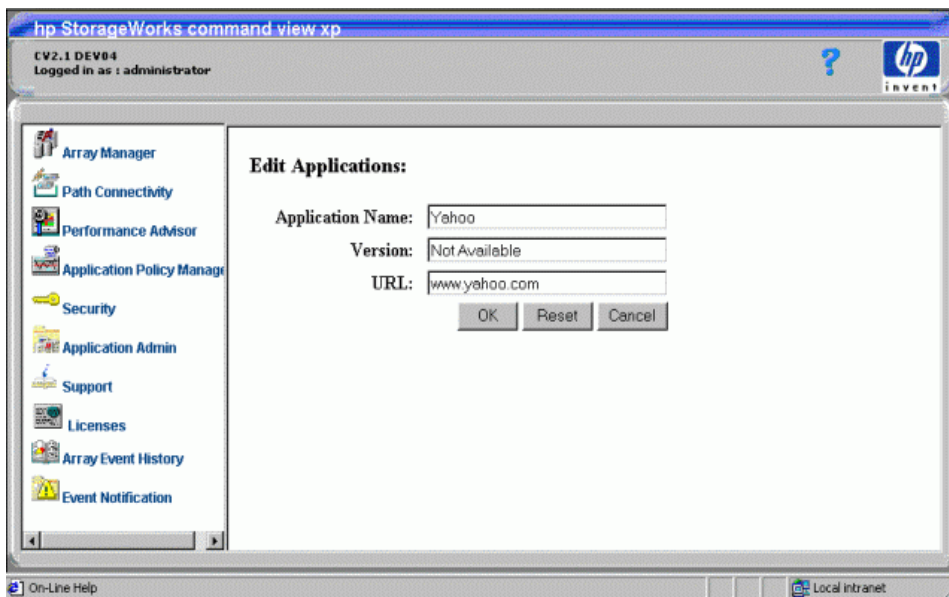

Figure 19 Edit Applications pane

3. Modify the name or version of the application.
4. Click **OK** to confirm the changes. Click **Reset** to remove your changes without canceling the operation.

When you return to the main Application Administration pane, the display will confirm that the application information has been changed.



# 5 Support

The Support panes provide access to help information.

- "Accessing the Support pane" on page 73
- "Using the Support pane" on page 73

## Accessing the Support pane

When you log on to Command View, the Main window opens by default.

Click **Support** to view the Contents and Support panes. By default, the Download Page appears in the Support pane.

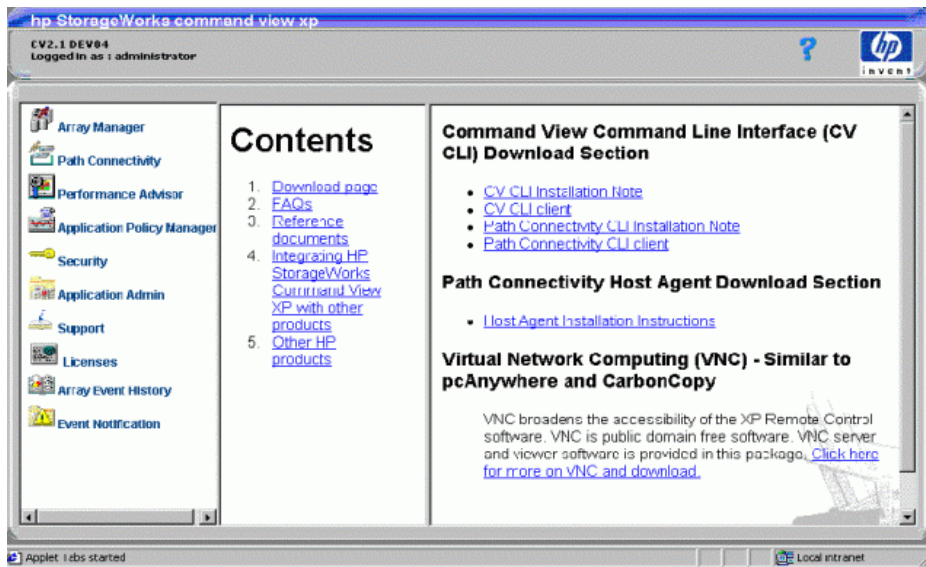

Figure 20 Download page

## Using the Support pane

Use the links in the Contents pane to access support information.

Table 6 Support pane links

Click:	To:
Download page	Access Command View and Path Connectivity CLI information and downloads, and Path Connectivity Host Agent downloads
FAQs	View frequently asked questions and answers about Command View operations
Reference documents	View additional Command View documentation

**Table 6** Support pane links (continued)

<b>Click:</b>	<b>To:</b>
<b>Integrating HP StorageWorks Command View XP with other products</b>	Learn how to use Command View with HP OpenView Storage Area Manager and other products
<b>Other HP Products</b>	View information about other HP products and services

## 6 Licenses

Use the License Key Management pane to view, install, and uninstall license keys.

- ["Managing license keys"](#) on page 75
- ["Accessing License Key Management"](#) on page 76
- ["Installing a license key"](#) on page 77
- ["Uninstalling a license key"](#) on page 79

---

### Managing license keys

Use the License Key Management pane to install license keys that enable disk array product features such as Business Copy and Continuous Access. License keys are e-mailed to you by the HP license server.

The License Key Management pane:

- Displays a list of software, showing which options do or do not have license keys installed
- Installs licenses
- Uninstalls licenses

### Types of license keys

Three types of license keys are available:

- A *temporary key* is a 120-day trial key. When this key expires, it cannot be re-installed for 180 days.
- An *emergency key* is a 30-day key, used to continue operating a function until you obtain a permanent key, or to release a changed configuration after a temporary key expires. This key can be reinstalled.
- A *permanent key* does not expire. Permanent keys are purchased based on the capacity of your disk array.

Your HP account support representative can help determine which keys you need to purchase.

# Accessing License Key Management

1. Click **Licenses** in the main window.

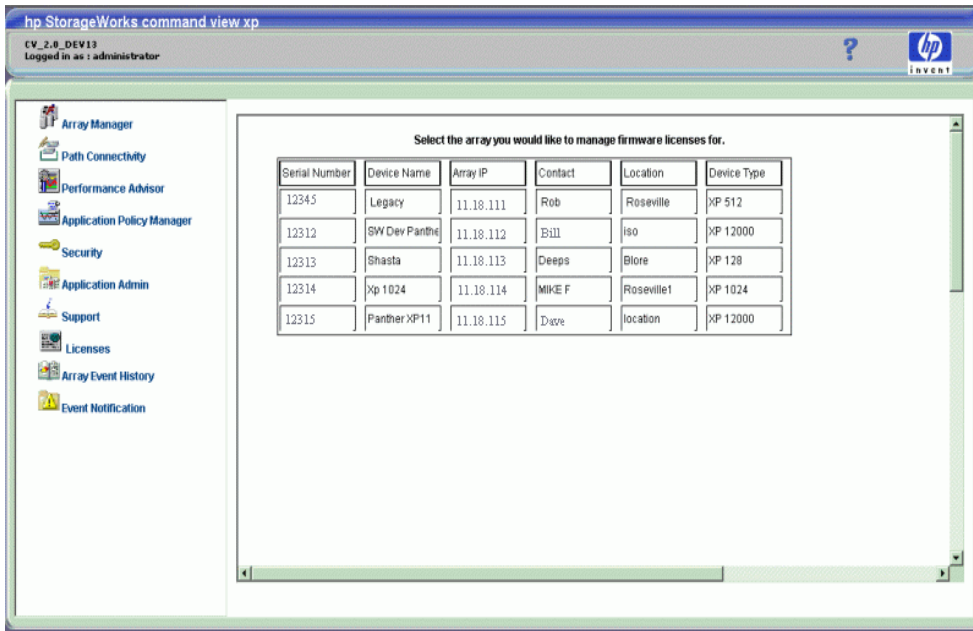

Figure 21 Accessing licenses



**NOTE:** This pane displays only those arrays for which the currently logged-in user has full array access permissions.

2. In the **Serial Number** column, click the disk array you want to access. The License Key Management pane appears.

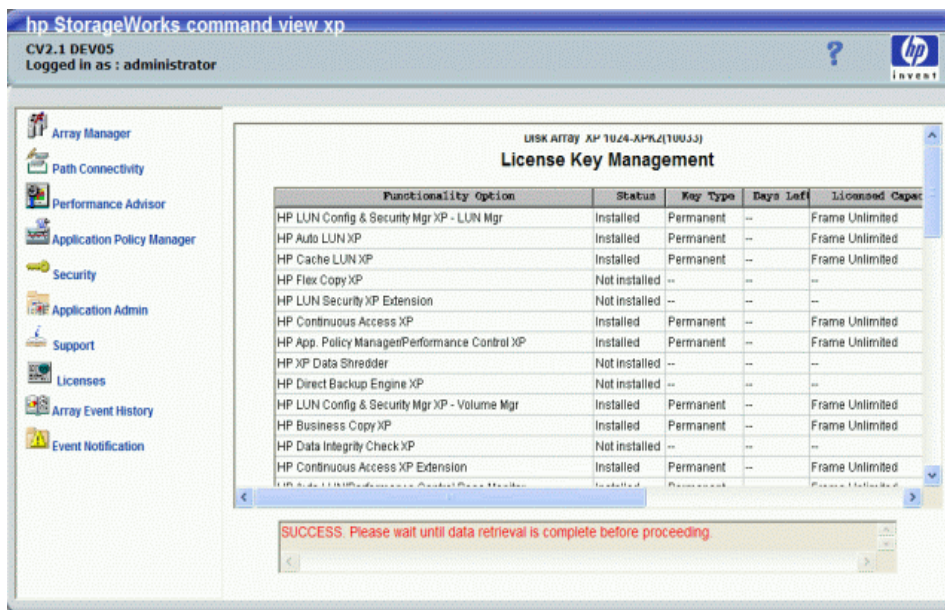

Figure 22 License Key Management pane



This pane lists the following items:

- **Functionality Option:** List of software options. Note that not all options are supported.
- **Status:** Installation status of the option (Installed or Not Installed).
- **Key Type:** Type of key installed (Temporary, Emergency or Permanent). If no key is installed, the column displays --.
- **Days Left:** Number of days before the key expires (Temporary and Emergency keys only).
- **Licensed Capacity:** Capacity of the license (for Permanent keys) in terabytes (TB).
- **Used Capacity:** Used Capacity (TB) is valid for applications like Continuous Access (CA), Business Copy (BC), Continuous Access XP - Journal, and Open LDEV Guard. When the license key for CA, BC, Continuous Access XP - Journal, or Open LDEV Guard is installed, the Used Capacity column shows actual used capacity.



**NOTE:** With some features, this will display as 0. For XP48 and XP512 arrays, used capacity information is not available and Used Capacity (TB) is displayed as 0.

---

- **Buttons:**
  - **Install:** Displays the License Key Management (Install) pane
  - **Uninstall:** Displays the License Key Management (Uninstall) pane
  - **Cancel:** Returns to the previous pane

---

## Installing a license key

Use the License Key Management pane to install license keys. If an application is licensed with full capacity, its check box is disabled. Also, if "frame unlimited" appears for a feature in the "Licensed Capacity" column, the check box will be disabled in the License Key Management (Install) pane for that feature. If a feature is capacity-based and the permanent key installed is not frame unlimited, then the check box in the install screen will be enabled for that feature, allowing you to increment the licensed capacity further.

1. From the License Key Management pane, click **Install**. The License Key Management (Install) pane appears.

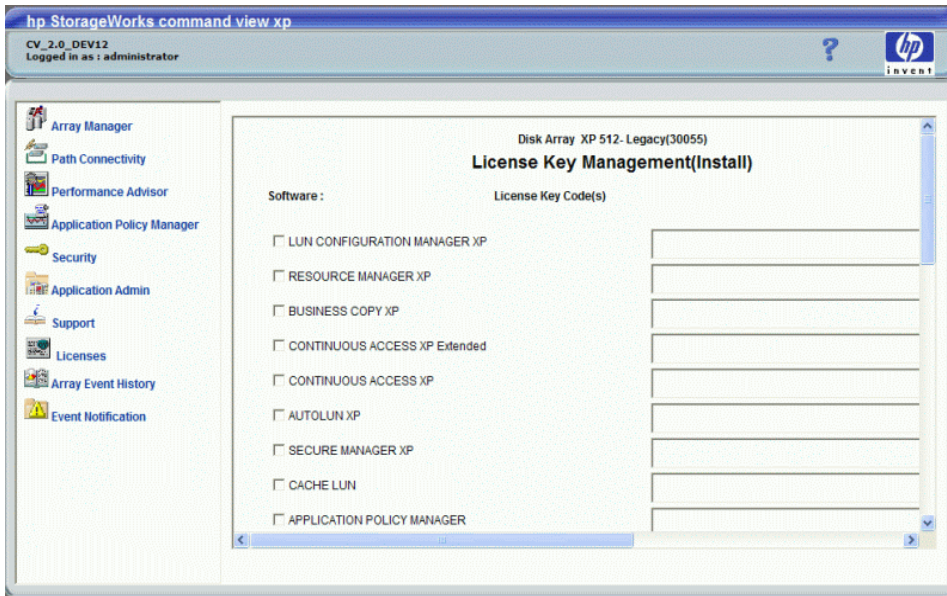

**Figure 23** License Key Management (Install) pane

2. Select the check box for each license key you want to install.
3. Enter the license key code(s). The length of the license key code(s) will vary, depending on the array. See [Table 7](#).

**Table 7** License key code length

Array Type	Key Length
XP12000	48
XP1024/128/512/48	20

4. Click **OK** to install the license key and return to the License Key Management pane.

# Uninstalling a license key

1. From the License Key Management pane, click **Uninstall**. The License Key Management (Uninstall) pane appears.

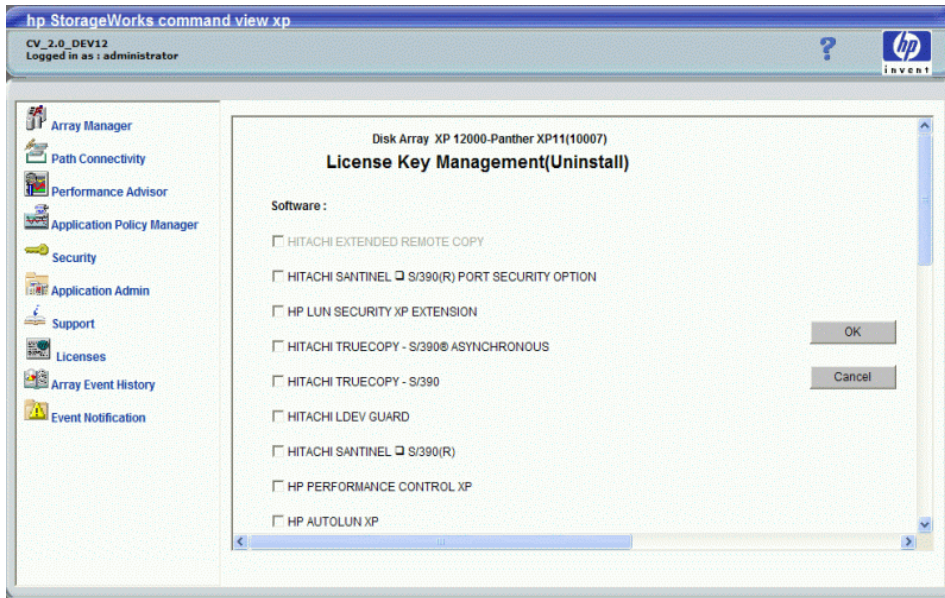

**Figure 24** License Key Management (Uninstall) pane

2. Select a check box for each license you want to uninstall. If an option is not licensed, its check box is disabled.
3. Click **OK** to uninstall the license key and return to the License Key Management pane.



# 7 Array event history

Use the Array Event History pane to view recent disk array events and error conditions. To use this feature, configure one or more XP disk arrays to forward traps to Command View's Trap Distributor, and then you can choose to set up Trap Distributor to forward SNMP traps. Only SNMP traps received by Trap Distributor are recorded in the Array Event History pane.



**NOTE:** For instructions on configuring an XP disk array to forward traps, refer to *Integrating HP StorageWorks Command View XP with Other Platforms* in the Support pane (page 73).

Array Event History is similar to Event Notification (page 83). The significant difference between Array Event History and Event Notification is that Array Event History events are asynchronous or live events, whereas Event Notification traps are synchronous. Event Notification automatically records events and generates notifications for any managed disk array and Path Connectivity without additional configuration steps. Use Trap Distributor to record events from managed and unmanaged disk arrays.

For information about integrating with other software products, click **Support** in Command View's main window, then click **Integrating HP StorageWorks Command View XP with other products**.

## Using Array Event History

1. Click **Array Event History** in the Main window. The Array Event History pane appears.

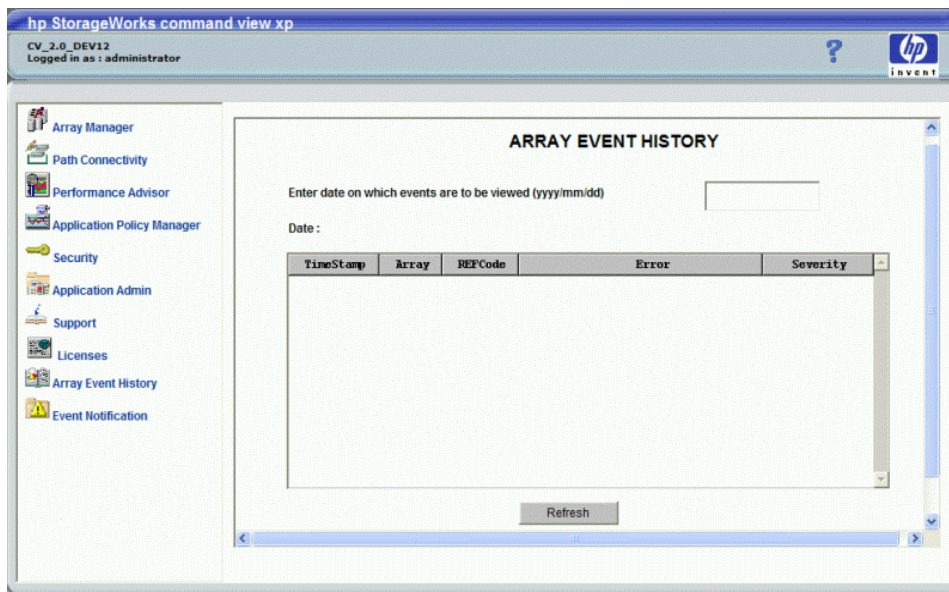

**Figure 25** Array Event History pane

2. Enter the date for which you want to view array events (yyyy/mm/dd), and click **Refresh**.

## Display

The Array Event History pane includes the following items:

- **Date:** Date the information is requested

- **Time Stamp:** Date and time the event occurred
- **Array:** Serial number of the disk array that generated the error
- **Ref code:** Reference code provided for a Remote Service Information Message (R-SIM) to identify the error
- **Error:** An explanation of the error
- **Severity:** Error's severity level
- **Refresh button:** Click this button to receive updated information for the selected date or to refresh the display after entering a new date.

## 8 Event notification

Use Event Notification for the following tasks:

- Configure and dispatch notifications
- Configure the history log file
- View events and notification history
- Test notification dispatching

Event Notification also includes a history log of disk array events.

Event Notification is similar to Array Event History. The significant difference between Array Event History and Event Notification is that Array Event History events are asynchronous or live events, whereas Event Notification traps are synchronous.

Event Notification automatically records events and generates notifications for any managed disk array and Path Connectivity without additional configuration. Trap Distributor can be used to record events from managed and unmanaged disk arrays.

For information about integrating with other software products, click **Support** in Command View's main window, then click **Integrating HP StorageWorks Command View XP with other products**.



**NOTE:** Only users in the Administrators group can configure event notifications and log files.

## Accessing Event Notification

To access Event Notification, click **Event Notification** in the main window.

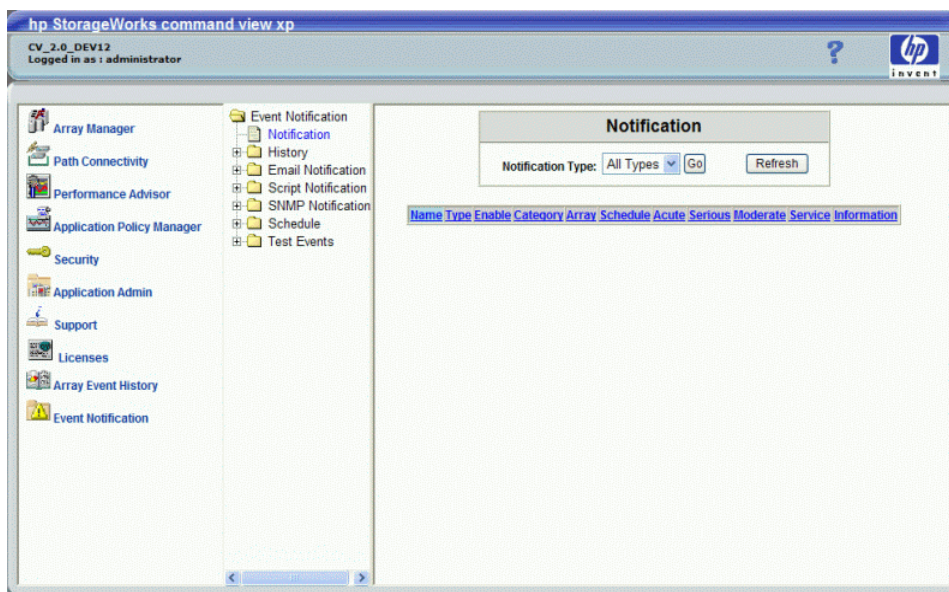

**Figure 26** Notification pane



To display the other Event Notification panes, use the navigation tree on the left. To display the most current event notification data, click **Refresh**.

## Configuring event history settings

Event history data is saved in the history log file. Use the History Log Configuration pane to change event history settings such as file size and number of days events are saved. File size takes priority over the number of days, so the history log file will never exceed the maximum file size regardless of the number of days you set.

1. In the navigation tree, click **History** and then **Configuration**. The History Log Configuration pane appears.

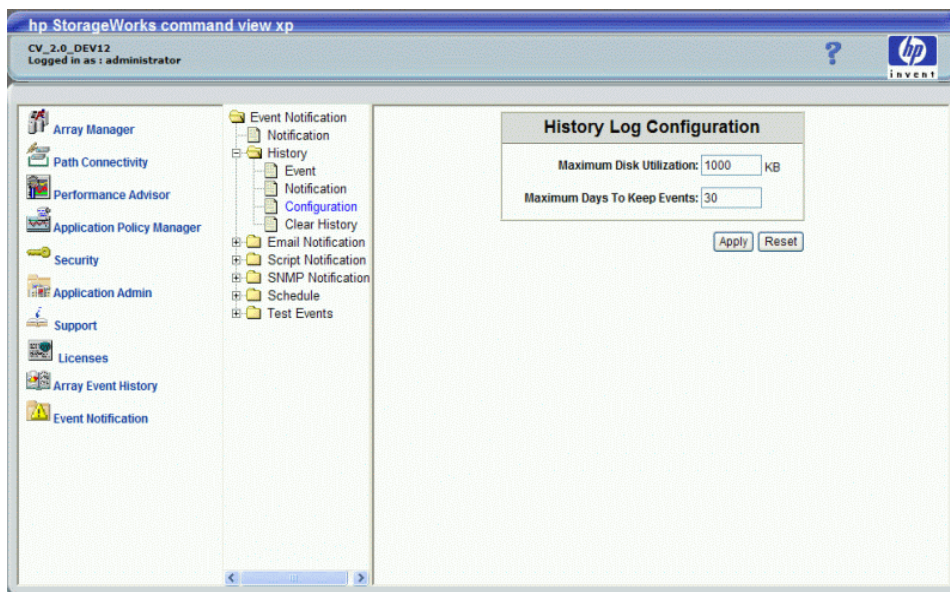

**Figure 27** History Log Configuration pane

2. Enter the maximum file size for the history log file (KB) in the Maximum Disk Utilization box.
3. Enter the maximum number of days to save events in the history log file in the Maximum Days To Keep Events box.
4. Click **Apply**.

## Specifying the e-mail server for e-mail notifications

Before sending any e-mail notifications, you must specify the e-mail SMTP server that is used to send an e-mail notification.



1. In the navigation tree, click **Email Notification** and then **Configuration**. The Email Server Configuration pane appears.

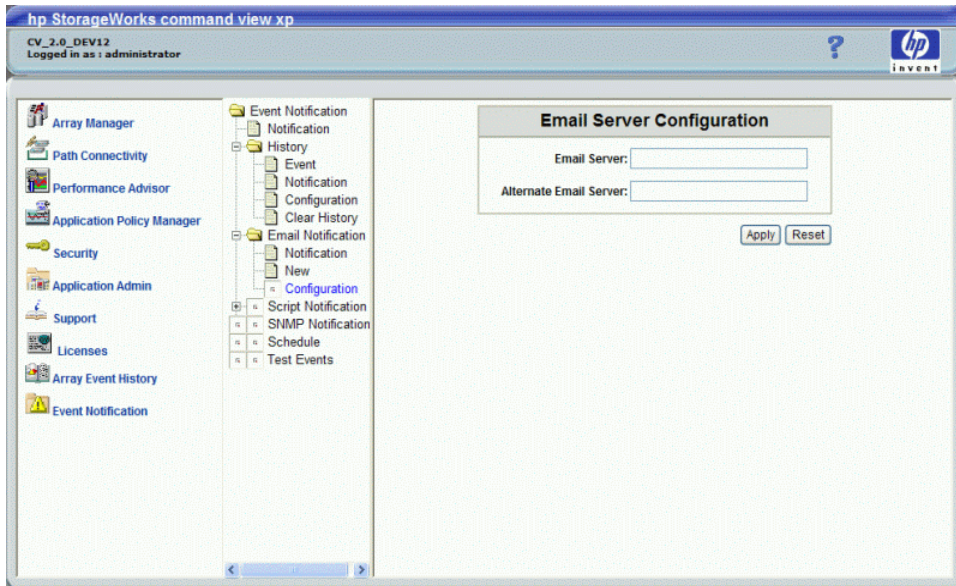

**Figure 28** Email Server Configuration pane

2. Enter the server name or address in the Email Server box.
3. To specify an alternate server if the first one is not available, enter the server name or address in the Alternate Email Server box.
4. Click **Apply**.

---

## Configuring e-mail notifications

Use the Email Notification pane to add, edit, or delete existing e-mail notifications. Event information is provided in the e-mail message body. The following is an example of an e-mail notification message:

```
Notification_Dispatch_Notice: Notification dispatch.  
Notification_Name: My Email  
Category: Array  
Severity: Serious  
Timestamp: 2003-10-21T10:00:56  
Array_Serial_Number: 10033  
Reference_Code: 54321  
Message: Test Message
```

## Adding an e-mail notification

1. In the navigation tree, click **Email Notification** and then **New**. The Email Notification pane appears.

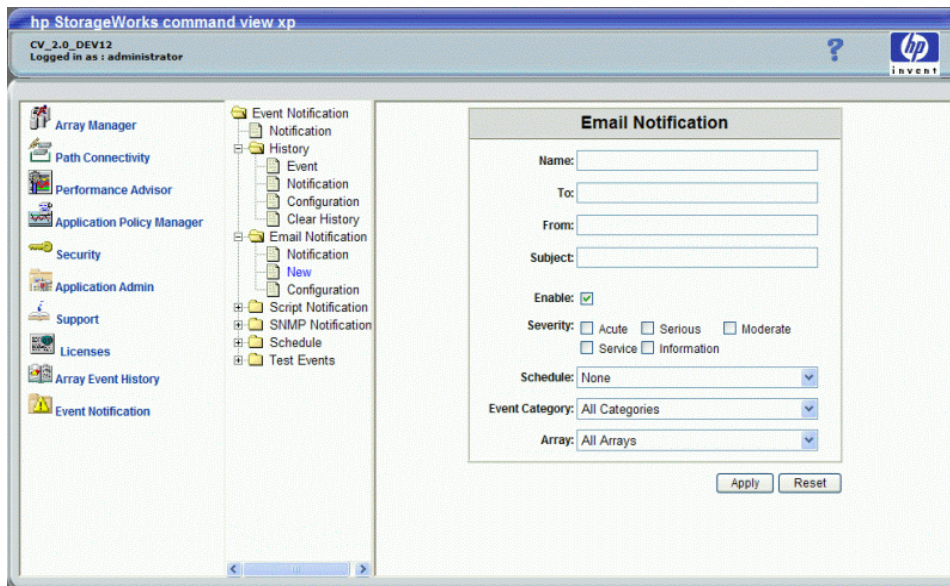

**Figure 29** Email Notification pane

2. In the Name box, enter the name of the notification for identification purposes.
3. Enter the e-mail addresses of the notification recipient and sender in the To and From boxes.
4. Enter the subject of the e-mail notification in the Subject box,
5. By default, the Enable check box is selected. If you want to create an inactive notification, clear the check box. Notifications will not be sent until this check box is selected.
6. Choose one or more severity levels by selecting the appropriate Severity check box(es). A notification will be sent only when it meets the severity level criteria.
7. In the Schedule list, select a previously created schedule or **None** if there are no schedule restrictions. If you select a schedule, a notification will be sent only for events that occurred during the set schedule. For more information, see "[Managing the notification schedule](#)" on page 89.
8. In the Event Category list, select **All Categories**, **Array**, or **Path Connectivity**. The default is All Categories. Only events that fall into the specified category will trigger a notification.
9. In the Array list, select a disk array or **All Arrays**. The default is All Arrays. Only events that occurred on the specified disk array will trigger a notification.
10. Click **Apply**.

## Editing or deleting an e-mail notification

1. In the navigation tree, click **Email Notification** and then **Notification**. The Notification pane appears.
2. Click the name of the notification you want to edit or delete. The Email Notification pane appears.
3. Edit the notification and click **Apply**. To delete the notification, click **Delete**.

## Configuring script notifications

Use the Script Notification pane to add, edit, or delete script notifications. Event information to the script is provided by the standard input stream.

## Adding a script notification

1. In the navigation tree, click **Script Notification** and then **New**. The Script Notification pane appears.

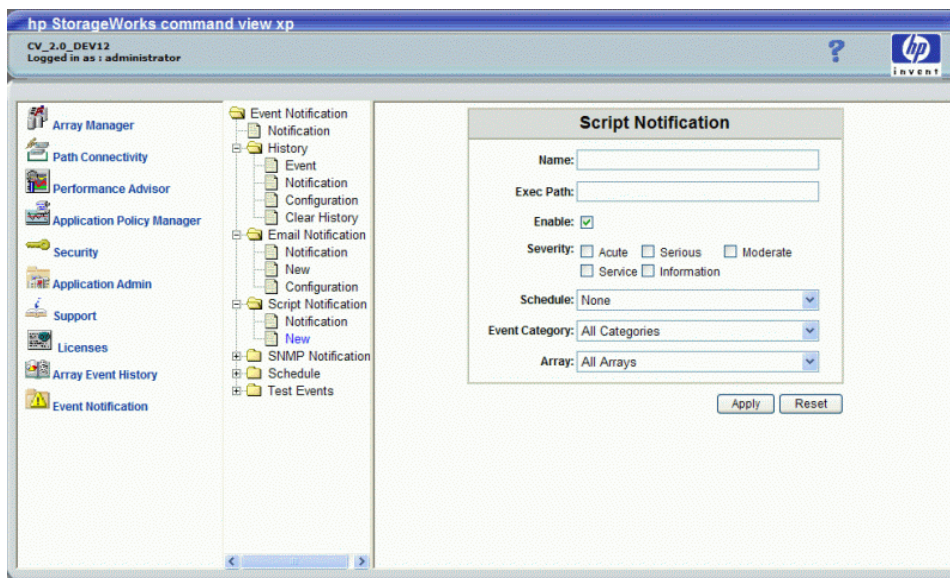

**Figure 30** Script Notification pane

2. In the Name box, enter the name of the notification for identification purposes (for example, MyScript).
3. In the Exec Path box, enter the absolute path of the script you want to run. Make certain the script file is placed on the machine running the Command View management station.
4. By default, the Enable check box is selected. If you want to create an inactive notification, clear the check box. Notifications will not be executed until this check box is selected.
5. Choose one or more severity levels by selecting the appropriate Severity check box(es). A notification will be executed only when it meets the severity level criteria.
6. In the Schedule list, select a previously created schedule or **None** if there are no schedule restrictions. If you select a schedule, a notification will be executed for events that occurred during the set schedule. For more information, see "[Managing the notification schedule](#)" on page 89.
7. In the Event Category list, select **All Categories**, **Array**, or **Path Connectivity**. The default is All Categories. Only events that fall into the specified category will trigger a notification.
8. In the Array list, select a disk array or **All Arrays**. The default is All Arrays. Only events that occurred on the specified disk array will trigger a notification.
9. Click **Apply**.

## Editing or deleting a script notification

1. In the navigation tree, click **Script Notification** and then **Notification**. The Notification pane appears.
2. Click the name of the notification you want to edit or delete. The Script Notification pane appears.
3. Edit the notification and click **Apply**. To delete the notification, click **Delete**.

---

## Configuring SNMP notifications

Use the SNMP Notification pane to add, edit, or delete SNMP notifications. A SNMP notification sends SNMP traps to other applications. The trap format is based on the NetCitizen MIB. The NetCitizen2.mib file is located in the \hps\subagent directory.

The trap's description contains the following information:

**Table 8** Information for configuring SNMP notifications (NetCitizen2.mib)

Event severity	Trap type
Acute	hpHttpMgNonRecoverableHealthTrap
Serious	hpHttpMgCriticalHealthTrap
Moderate or Service	hpHttpMgWarningHealthTrap
Information	hpHttpMgOKHealthHealthTrap

	Information included in the description
Trap Info:	<p>community: public</p> <p>enterpriseOid: .1.3.6.1.4.1.11.2.36.1</p> <p>trapType: 6</p> <p>specificTrapType: hpHttpMgNonRecoverableHealthTrap (7), hpHttpMgCriticalHealthTrap (6), hpHttpMgWarningHealthTrap(5), or hpHttpMgOKHealthTrap (4)</p> <p>upTime: event time</p>
Trap Variables:	<p>hpHttpMgDeviceIndex: Always 0 (zero)</p> <p>hpHttpMgDeviceSysObjID: 1.3.6.1.4.1.11.10.2.1.14</p> <p>hpHttpMgDeviceGlobalUniqueID: hostIpAddress_arraySn or hostIpAddress_PCApplication</p> <p>hpHttpMgDeviceManagementURL: http://hostIpAddress/hpstmgmt/servlet/MarsDm</p> <p>hpHttpMgDeviceManagementURLLabel: ArrayMgmt or PC</p> <p>hpHttpMgDeviceSpecificEventCode: Event Message</p> <p>hpHttpMgDeviceSpecificFRU: RefCode or FRU</p>

## Adding an SNMP notification

1. In the navigation tree, click **SNMP Notification** and then **New**. The SNMP Notification pane appears.

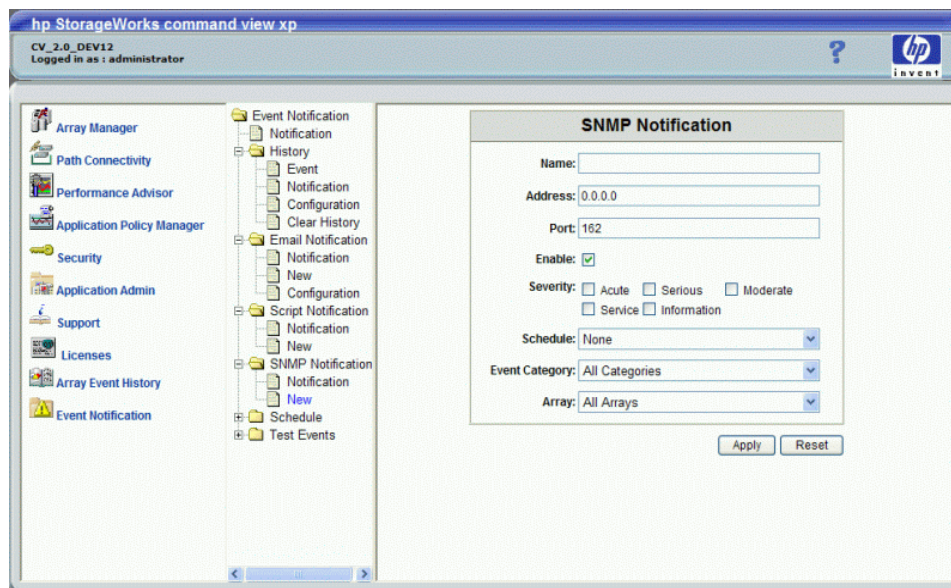

**Figure 31** SNMP Notification pane

2. In the Name box, enter the name of the notification for identification purposes.
3. In the Address box, enter the target IP address for the SNMP trap.
4. In the Port box, enter the IP port number for SNMP. The recommended port number is 162.
5. By default, the Enable check box is selected. If you want to create an inactive notification, clear the check box. Notifications will not be sent until this check box is selected.
6. Choose one or more severity levels by selecting the appropriate Severity check box(es). A notification will be sent only when it meets the severity level criteria.
7. In the Schedule list, select a previously created schedule or **None**, which means there will be no schedule restrictions. If you select a schedule, a notification will be sent for events that occurred during the set schedule. For more information, see "[Managing the notification schedule](#)" on page 89.
8. In the Event Category list, select **All Categories**, **Array**, or **Path Connectivity**. The default is All Categories. Only events that fall into the specified category will trigger a notification.
9. In the Array list, select a disk array or **All Arrays**. The default is All Arrays. Only events that occurred on the specified disk array will trigger a notification.
10. Click **Apply**.

## Editing or deleting an SNMP notification

1. In the navigation tree, click **SNMP Notification** and then **Notification**. The Notification pane appears.
2. Click the name of the notification you want to edit or delete. The SNMP Notification pane appears.
3. Edit the notification and click **Apply**. To delete the notification, click **Delete**.

## Managing the notification schedule

You can create one or more schedules to restrict event notification to a specific day and time on a weekly basis. After creating a schedule, you can apply the schedule when creating or editing e-mail, script, and SNMP notifications.



You can also create schedules that span over two days. For example, if you set the start time to 10:00 p.m. and the duration to 5 hours, notification monitoring will end at 3 a.m. the following day.

You also edit or delete schedules. If you rename or delete a schedule currently in use, go to the notification and reselect the schedule or chose a new schedule, or the notification will not follow a schedule.

To update the Schedule pane, click **Refresh**.

## Creating a notification schedule

1. In the navigation tree, click **Schedule** and then **New**. The Schedule pane displays a form.

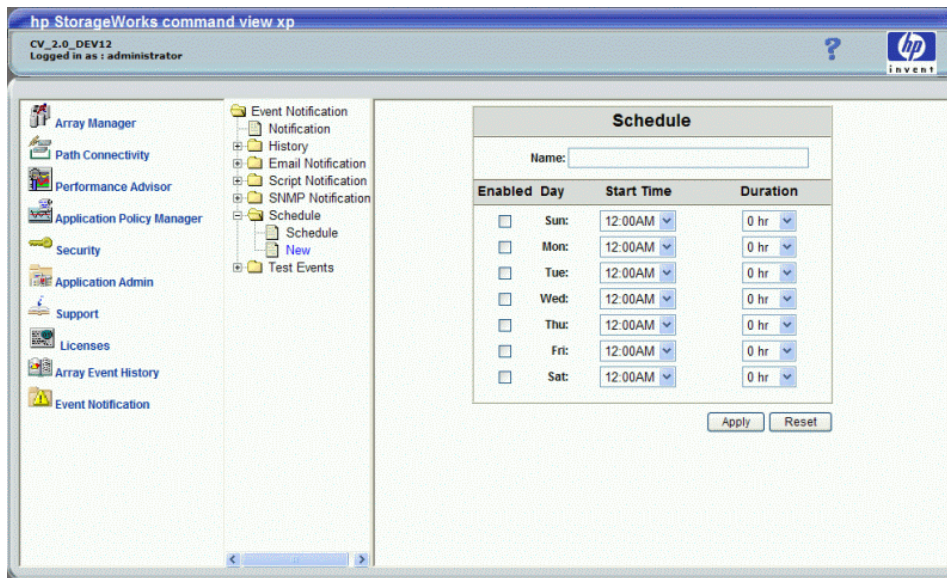

**Figure 32** Schedule pane for creating a new schedule

2. Set the schedule by selecting the Enabled check box next to the day you want, selecting a start time in the Start Time list, and selecting the number of hours in the Duration list.
3. Click **Apply**.

## Editing or deleting a notification schedule

1. In the navigation tree, click **Schedule** and then **Schedule**. The Schedule pane displays a list of existing schedules.
2. Click the name of the schedule you want to edit or delete. The Schedule pane displays the existing schedule.
3. Edit the schedule and click **Apply**. To delete the schedule, click **Delete**.

---

## Viewing a list of configured notifications

Use the Notification pane to display the e-mail, script, and SNMP notifications that have been set. In this pane, you can sort the list or access additional panes to edit or delete a notification.

1. To display a list of configured notifications, do one of the following:
  - Click **Event Notification** to display the default pane, which is the Notification pane. The default pane shows all notifications.
  - From any other Event Notification pane, click **Notification** in the navigation tree to display the default pane.

- To view a specific type of notification from the default pane, select **Email**, **Script**, or **SNMP** in the Notification Type list and click **Go**.
  - To view a specific type of notification from any other Event Notification pane, click **Email Notification**, **Script Notification**, or **SNMP Notification** in the navigation tree. Then click Notification to display that type of notification.
2. To sort by column, click the column heading link.
  3. To edit a notification, click the name of the notification.
  4. To delete a notification, click the name of the notification and then click **Delete**.
  5. To edit the schedule of a notification, click the name of the schedule.
  6. To update the Notification pane, click **Refresh**.

## Viewing event history

Use the Event History pane to view event messages with information about severity, when the event occurred, and whether a notification was sent. You can filter events by category and date, and sort by column.

You can also view the event notification history from the Notification History pane (see “[Viewing notification history](#)” on page 92).

1. In the navigation tree, click **History** and then **Event**. The Event History pane displays all the events that have occurred according to the settings specified in the History Log Configuration pane (see “[Configuring event history settings](#)” on page 84).

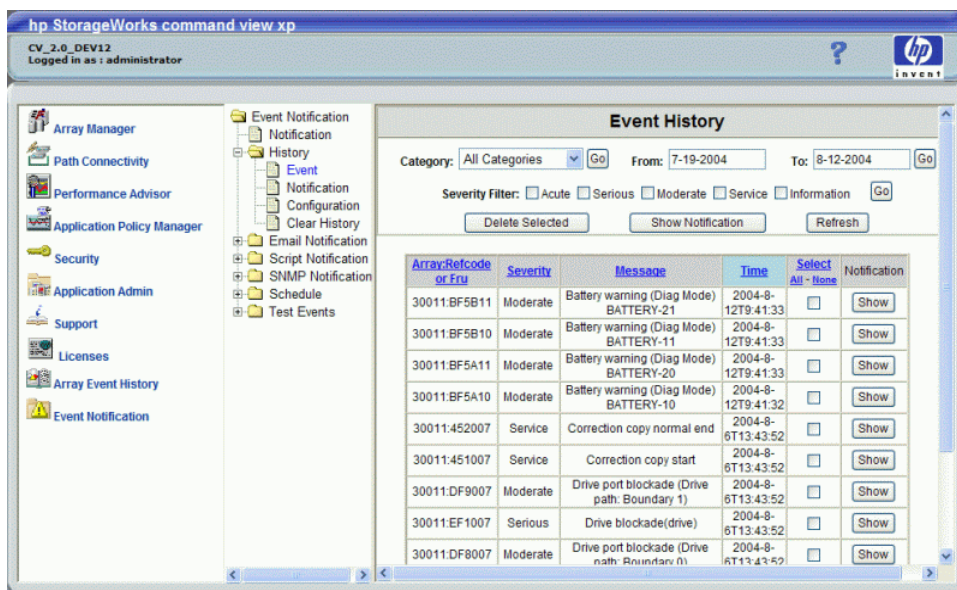

**Figure 33** Event History pane

2. To create a more selective listing, apply any of the following filters:
  - To display disk array events only, select **Array** in the Category list and click **Go**. To narrow the list to a specific disk array, select the disk array in the Array list.
  - To display Path Connectivity events only, select **Path Connectivity** in the Category list and click **Go**.
  - To display events from a specific date range, enter the dates (mm-dd-yyyy) in the From and To boxes and click **Go**.

- To display events of a specific severity level, select one or more Severity Filter check box(es) and click **Go**.
3. To sort by column, click the column heading link.
  4. To show or hide notifications associated with an event:
    - To display notifications for a specific event, click **Show** next to the event you want to view.
    - To display notifications for all events, go the Notification History pane by clicking **History** and then **Notification** in the navigation tree (see “[Viewing notification history](#)” on page 92).
    - Click **Hide Notification** when you are done viewing the event notifications.
  5. Click **Refresh** to update the Event History pane.

## Viewing notification history

Use the Notification History pane to view a history of event notifications. The list shows who was notified, the type of notification, where and when it was sent, and the status. In addition, you can filter notifications by date and sort by column.

**NOTE:** Time stamp displayed for XP48/XP512 array events will not be accurate as it is not supported in the firmware.

You can also display the event notification history for a specific event from the Event History pane (see “[Viewing event history](#)” on page 91).

1. In the navigation tree, click **History** and then click **Notification**. The Notification History pane displays all the notifications that have occurred.

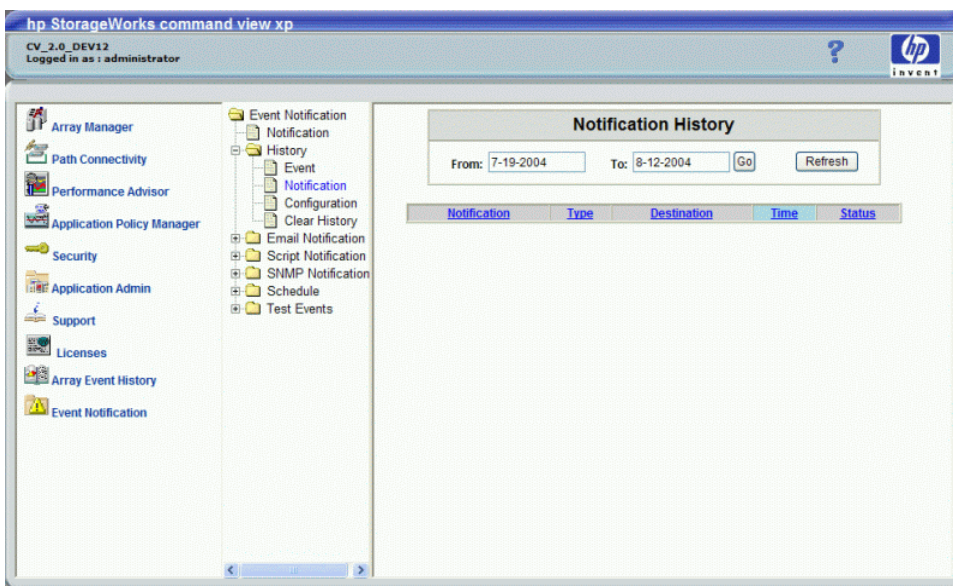

**Figure 34** Notification History pane

2. To display notifications during a specific date range, enter the dates in the **From** and **To** boxes (mm-dd-yyyy) and click **Go**.
3. To sort by column, click the column heading link.
4. To update the Notification History pane, click **Refresh**.



---

## Deleting history events

In addition to deleting individual event entries, you can delete all events by clearing the event history log file. Deleting events deletes the notification history associated with those events.

### Deleting individual events

1. In the navigation tree, click **History** and then **Event**. The Event History pane displays all the notifications that have occurred.
2. In the Select column, select the check box(es) next to the events you want to delete. To select all the check boxes, click the **All** link in the Select column heading. Clicking the **None** link clears all the check boxes.
3. Click **Delete Selected**. The Event History pane is updated and no longer shows the events you selected to delete.

### Clearing the history log file

1. In the navigation tree, click **History** and then click **Clear History**. The Clear History pane appears.

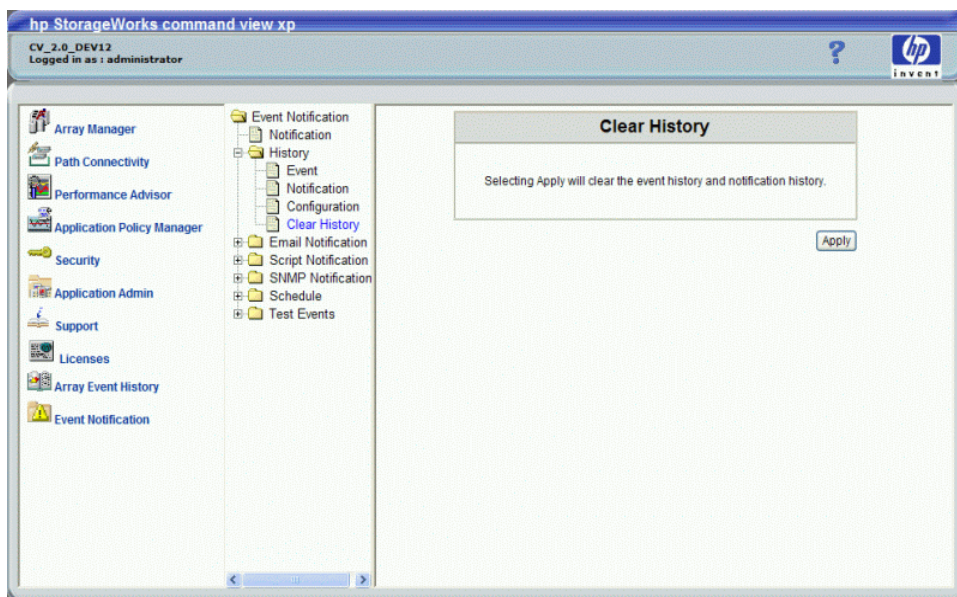

**Figure 35** Clear History pane

2. Click **Apply** to clear the history log file. A confirmation message appears.
3. Click **OK** to confirm.

---

## Testing event notification

The Array Test Event and Path Connectivity Test Event panes provide a diagnostic tool that administrators can use to test event notifications. To use the tool, create a test event to trigger a notification that is displayed in the Event History pane.

## Testing array event notification

1. In the navigation tree, click **Test Events** and then **Array Event**. The Array Test Event pane displays a form.

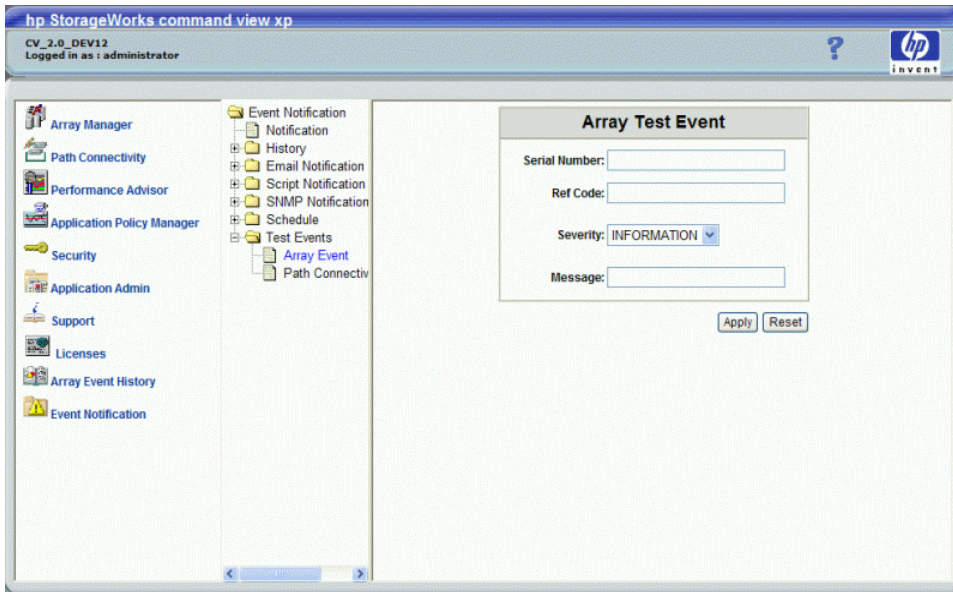

Figure 36 Array Test Event pane

2. Complete the form that triggers an event notification.
3. Click **Apply**.
4. Go to the Event History pane by clicking **History** and then **Event**.
5. Locate the event that you created.
6. Verify that a notification occurred by clicking **Show** next to the event.

## Testing Path Connectivity event notification

1. In the navigation tree, click **Test Events** and then **Path Connectivity Event**. The Path Connectivity Test Event pane displays a form.

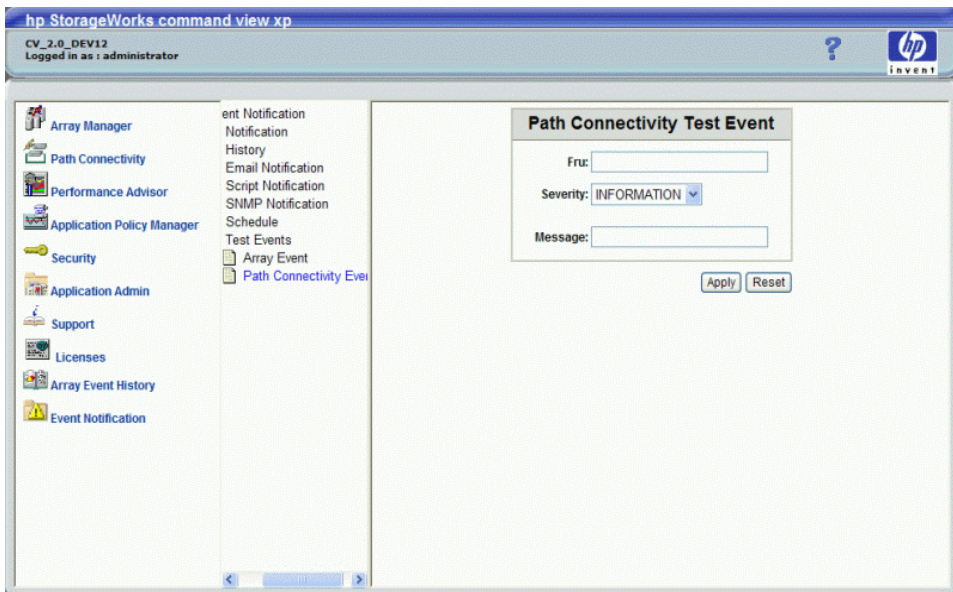

Figure 37 Path Connectivity Test Event pane

2. Complete the form that triggers an event notification.
3. Click **Apply**.
4. Go to the Event History pane by clicking **History** and then **Event**.
5. Locate the event that you created.
6. Verify that a notification occurred by clicking **Show** next to the event.



# 9 Identity

The Identity pane is an array-dependent feature and is the default pane that is shown after a disk array is selected in the Device Launcher pane.



**NOTE:** Values displayed in the Identity pane can be changed in the Device Administration pane. See “Device Administration” on page 48.

## Accessing identity information

1. Click **Array Manager** in the left pane.
2. From the Device Launcher pane, click **Modify** or **View** for an XP48/XP512 or click an XP128/XP1024/XP12000 link.

## Display for XP48/XP512



**Figure 38** Identity pane (XP512)

This pane lists the following items:

- **Product:** HP product number for the disk array
- **Firmware Version:** Version of the firmware currently loaded on the disk array
- **Console Address:** IP address of the disk array
- **Device Name:** User-defined nickname that identifies a disk array
- **Device Location:** Physical location of the disk array
- **Contact:** Person to contact regarding issues with the disk array



**NOTE:** You can add or modify the Device Name, Device Location, and Contact by updating the information in the Device Administration pane (page 48).

- **Update** button (view mode only): Click this button to display the latest data from the disk array.

## Display for XP128/XP1024/XP12000

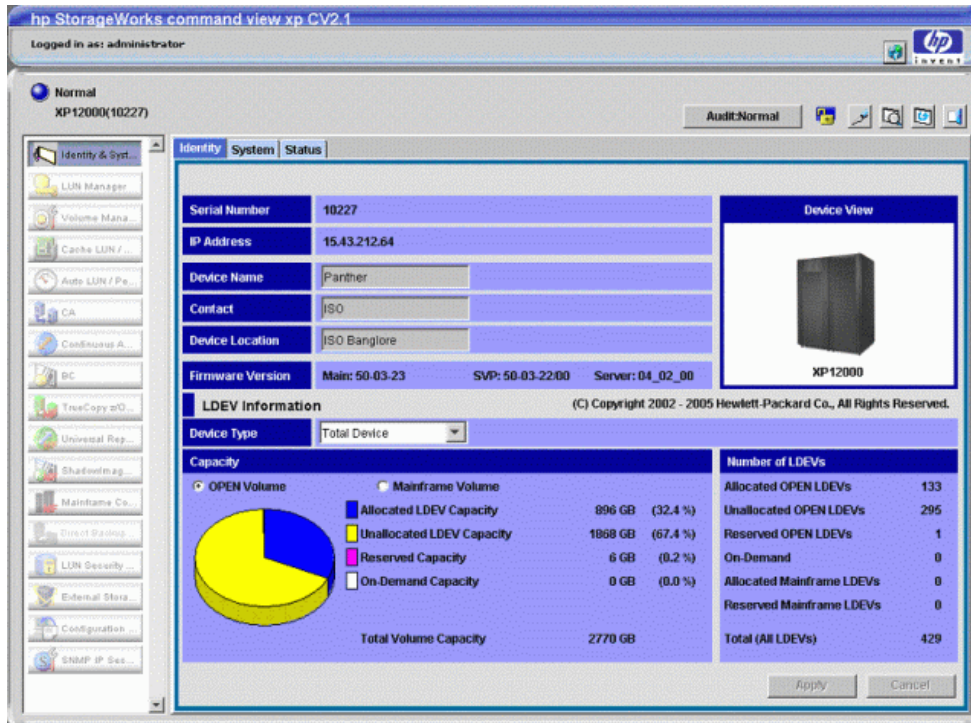



**Figure 39** Identity pane (XP12000)

The Identity pane for the XP128/XP1024/XP12000 includes the following items:







- **User:** The user ID of the current user
- Buttons and icons, shown above the Identity pane in the main window, provide several functions as described in the following table:

**Table 9** Identity pane buttons and icons

Button or Icon	Description
	The <b>Audit:Normal</b> button or the <b>Audit:Warning</b> button allows you to download the audit log file. When the amount of the data in the audit log file is under the threshold, the <b>Audit:Normal</b> button is displayed. When the amount of the data in the audit log file exceeds the threshold, the <b>Audit:Warning</b> button is displayed. For detailed information, see <a href="#">Audit Log file (XP12000 only)</a> , page 101.
	
	The <b>Option</b> icon opens the User Control Panel, allowing the Administrator to edit user account lists, set Command View environment parameters, and download files containing log or configuration information. See <a href="#">Control Panel (XP128/XP1024/XP12000)</a> , page 120 for additional information.

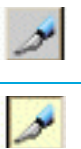

**Table 9** Identity pane buttons and icons (continued)

Button or Icon	Description
	<p>The <b>Status Lamp</b> icon in the upper left corner of the main window indicates the error status of the array. Blue indicates normal; yellow indicates warning; and red indicates abnormal, according to the host SIM status. For details, check the Status pane.</p>
	<p>The <b>Reset</b> button (Modify mode only) is at the top of the Identity pane. This feature provides a default time for the currently logged-in session. Click <b>Reset</b> to reset the time.</p>
	<p>The <b>Lock</b> icon indicates the operation mode for all currently logged-in users. If all users are operating in View mode, the unlocked icon with the blue background is displayed. If a user is operating in Modify mode, the locked icon with the red background is displayed.</p>
	<p>The <b>Mode-Switching</b> icon shows the current mode (View or Modify). Click this icon to change the mode of operation. The pen icon with the gray background represents View mode and the pen icon with the yellow background represents Modify mode. When you click the icon to change the mode of operation, a confirmation message asks: Do you want to change the mode. Click <b>Yes</b> to confirm or <b>Cancel</b> the operation. This feature is available to all users; however, read-only users will not be able to make any modifications.</p> <p><b>NOTE:</b> You cannot switch to Modify mode while another user is operating in Modify mode. Check the status of the Lock icon before switching to Modify mode. You can switch to Modify mode if the unlocked icon with the blue background is displayed.</p>
	<p>The <b>Basic Information</b> icon (XP12000 only) provides port, LUN, and LDEV information. See <a href="#">Basic information, page 115</a>, for additional information on this feature.</p>
	<p>The <b>Refresh</b> icon displays the latest information in the main window.</p> <p><b>NOTE:</b> The information might not be displayed correctly when the array is locked, array maintenance is in progress, or SNMP operations in Modify mode are being performed.</p>
	<p>The <b>Exit</b> icon closes the main window.</p>

- **Serial Number:** Disk array's serial number
- **IP Address:** Disk array's IP address
- **Device Name:** User-defined nickname that identifies a disk array. The characters ":" and "~" are not allowed in the Device Name box.
- **Contact:** Person to contact regarding issues with the disk array. The characters ":" and "~" are not allowed in the Contact box.

- **Device Location:** Physical location of the disk array. The characters ":" and "~" are not allowed in the Device Location box.



**NOTE:** You can add or modify the Device Name, Contact, and Device Location by updating the information in the Device Administration pane (page 48).

- **Firmware Version:** The version of the firmware currently loaded on the disk array
- **Device Type:** The type of the device you want to gather LDEV information on. One of three devices will be shown in the list:
  - Total Device
  - Internal Device Only
  - External Device Only (XP12000 only)
- **Capacity:**
  - **OPEN Volume:** Volumes that can be accessed by the hosts having non-mainframe operating systems. Supported open volume emulation types are OPEN-3, OPEN-8, OPEN-9, OPEN-E, OPEN-L, and OPEN-V.
  - **Mainframe Volume:** Volumes that can be accessed by mainframe hosts. Supported mainframe volume emulation types are 3380-E,-F,-J,-KA/KB/KC; 3390-1,-2,-3,-3R,-3A/3B/3C,-9.
  - **Allocated LDEV Capacity:** Sum of the capacities of all allocated LDEVs. An LDEV is considered allocated when at least one LUN path is associated with it. If two LUN paths point to the same LDEV, the space on that LDEV is counted once.
  - **Unallocated LDEV Capacity:** Sum of the capacities of all of unallocated LDEVs
  - **Reserved Capacity:** Sum of the capacities of all of reserved LDEVs
  - **Total Volume Capacity:** Sum of the storage capacity of all LDEVs on the system
- **Number of LDEVs:**
  - **Allocated OPEN LDEVs:** Number of LDEVs that are associated with LUNs
  - **Unallocated OPEN LDEVs:** Number of LDEVs that do not have assigned LUN paths
  - **Reserved OPEN LDEVs:** Number of LDEVs reserved as Auto LUN reserved volumes for use in LUN migration. This item is displayed only if HP Auto LUN XP is installed.
  - **Allocated Mainframe LDEVs:** Number of mainframe LDEVs having a path defined for one or more ports
  - **Reserved Mainframe LDEVs:** Mainframe LDEVs that are reserved for Auto LUN, BC, or CA operations
  - **Total LDEVs:** Total number of LDEVs on the disk array

---

## Using the Identity pane (XP128/XP1024/XP12000)

To view additional features or make modifications in the Identity pane:

1. Verify that the **lock** icon is unlocked with a blue background and no other user is holding a lock on the array. If necessary, click to change to the unlocked lock. If the lock remains locked, another user is in Modify mode. Only one user can be in Modify mode at a given time.



2. Check the **Mode-Switching** icon. If the icon is red, you are in Modify mode. If the icon is blue, click the icon to switch to Modify mode.



**NOTE:** Not all information can be viewed without obtaining a lock on the array (for example, you cannot change to Modify mode without obtaining a lock on the array). All users can obtain a lock on an array and access Modify mode. For users with read-only privileges, this will only provide a view to additional features. Only users in the Administrators and StorageAdmins groups can modify the array.

## Audit Log file (XP12000 only)

When you click **Audit:Normal** or **Audit:Warning** (the button is located above the Identity pane), the pane used to specify the destination for saving the audit log file appears.

The audit log file is used for security measures for the XP12000. In the audit log file, the history information of the operation performed from Command View to the array is saved. The audit log file records who performed what operation as well as when the operation was performed; therefore, it can be used to investigate problems that occur with the XP12000.

Audit log file conventions are as follows:

- **File type:** The audit log file is a generic term for the login information file (login.log) and the setting information file (audit.log). These files are compressed to the tgz file when they are downloaded. The default file name is “Audityyyymmdd.tgz” where “yyymmdd” indicates the date of the day the file is downloaded. You can specify the destination to save the file and the file name when you download it.
- **Maximum number of data that can be saved:** 10,000 data can be saved in each login information file and setting information file.
- **Maximum number of characters in a line:** 150 bytes of characters can be saved in a line.
- **File size:** 1.5 MB for each login information file and setting information file.
- **Threshold and the operation when the threshold is exceeded:** When the number of the saved data in the audit log file reaches the maximum number, the file starts to be overwritten from the starting line with the new data, and the old data is deleted (wrap around). To prevent the old data from being overwritten before the data is downloaded, the threshold is set. The preset threshold is 70% of the whole file. When the amount of the saved data reaches the threshold, a warning message urges you to download the audit log file. At this point, the **Audit:Warning** button appears. Once you have downloaded the audit log file, the counter of the saved data is reset, and monitoring of the amount of the saved data for the threshold is restarted from 0%.
- **Control information:** The first line of the audit log file is the control information (for example, file name and the last time the file is written).

Figure 40 shows an example of the audit log file.

```
Example of Login Information File
user-00,,04/08/20,16:59:00:000,00:00,[Base],Login,126.255.255.0,Normal end
 1 2 3 4 5 6 7 8 9
user-00,,04/08/20,17:00:00:000,00:00,[Base],Logout,,Normal end

Example of Setting Information File
user-00,,04/08/20.16:59:00:000,00:00,[Base],ChangeMode,,Normal end
user-00,,04/08/20,17:00:00:000,00:00,[TC],paircreate,,Normal end
```

Figure 40 Example of audit log file

The output items in the audit log file are described below according to the numbers shown in [Figure 40](#).

1. Login user ID
2. This area is not used for the XP12000
3. Date (YY/MM/DD): The day the file was downloaded
4. Time (HH:MM:SS:xxx): The time the file was downloaded
5. Time zone: The time difference between GMT (Greenwich Mean Time) and the local time is displayed in the form of "hh:mm" (for example, "01:00", "02:00", "00:00").
6. The abbreviation indicating the function: the abbreviation indicating the function or program product option which has been used to perform the setting operation is output. The abbreviation and the function names are listed in [Table 10](#).
7. Name of the operation: "Login" or "Logout" is output in the login information file. In the setting information file, the specific operation name to each function or program product option is output. For details on each output operation name and operation, see [Table 11](#).
8. Parameters: the IP address of the Storage Navigator (web client) computer used for login is output in the Login information file (login.log). No information is output for logout or other setting information.
9. Result of the operation: The following terms are output as a result of the operation:
  - **Normal end:** indicates that the operation has ended normally.
  - **Error (xxxx-yyyyy):** indicates that the operation has ended abnormally. Where "xxxx-yyyyy" displays the error code.
  - **Warning (xxxx-yyyyy):** Indicates that the operation has partly ended abnormally. Where "xxxx-yyyyy" displays the error code.

**To download the audit log file:**

1. Log on to an XP12000 to open the Identity pane.
2. Click **Audit:Normal** or **Audit:Warning** above the Identity pane. A new window will appear.
3. Specify the destination to save the audit log file and the file name, and click **Save**.

**Table 10** Abbreviation displayed in audit log file and corresponding program product or operation

Output Abbreviation in Audit Log File	Program Product or Operation
Base	Login, Logout Changing between View Mode and Modify Mode Changing information on the Information panel
LUNM	LUN Manager
ENAS	PCR of FlashAccess
LUSE	Volume Management (LUSE)
VLL	Volume Management (VLL)
SHRED	Data Shredder
Cache	FlashAccess, FlashAccess - S/390®
PFM	Performance Monitor

**Table 10** Abbreviation displayed in audit log file and corresponding program product or operation (continued)

Output Abbreviation in Audit Log File	Program Product or Operation
CC	Auto LUN XP
PPC	Priority Access
TC	Continuous Access XP
TC s/390	Hitachi TrueCopy - S/390®
SI	Business Copy XP
SI s/390	ShadowImage - S/390®
HPAV	Parallel Access Volume
SANtinel	Hitachi SANtinel - S/390®
LDG	LDEV Guard
OLG	LUN Security XP Extension
HC	Flex Copy XP
CFL	Configuration File Loader
PP KEY	License Key
SNMP	SNMP Information, SNMP
PORT	Changing port attribute operation from Continuous Access, Hitachi TrueCopy - S/390®, Extended Copy Manager, or Flex Copy XP
RCU	RCU operation from Continuous Access XP or Hitachi TrueCopy - S/390®
LDEV	LDEV operation such as blocking, restoring, and formatting

**Table 11** Operation and Terms Displayed in Audit Log File

Panel	Tab	Operation	Output of Audit Log File	
			Function	Operation
LUNM	LUNM (Note 3)	Command Device: OFF ON	LUNM	Set CommandDev
LUN Sec		Command Device: ON OFF		Set CommandDev (Note 1)
		Cmd Dev.Security: OFF ON		Set CommandDevSec (Note 1)
		Cmd Dev.Security: ON OFF		Set CommandDevSec (Note 1)
		Add LU Path		Add LU Path (Note 1)

**Table 11** Operation and Terms Displayed in Audit Log File (continued)

Panel	Tab	Operation	Output of Audit Log File	
			Function	Operation
		Release LU Path		Delete LU Path (Note 1)
		Set Host Mode		Set Host Mode (Note 1)
		LUN Security: OFF ON		Set Security Switch
		LUN Security: ON OFF		Set Security Switch
		Add New WWN		Add WWN (Note 1)
		Delete WWN		Delete WWN (Note 1)
		Change WWN & Name		Change WWN (Note 1)
		Add New Host Group		Add Host Group (Note 1)
				Set Host Mode (Note 1)
		Delete Host Group		Delete Host Group (Note 1)
		Change Host Group		Change Host Group (Note 1)
		Clear Host Group		Delete Host Group (Note 1)
		Paste		Add Host Group (Note 1)
				Set Host Mode (Note 1)
				Add WWN (Note 1)
				Add iSCSI Name (Note 1)
				Add LU Path (Note 1)
		Erase WWN		Delete DKC WWN (Note 1)
		"Drag & Drop" WWN node		Add WWN (Note 1)
				Delete WWN (Note 1)
		"Drag & Drop" iSCSI name node		Add iSCSI Name (Note 1)
				Del iSCSI Name (Note 1)
		Paste Path		Add LU Path (Note 1)
		Add new iSCSI name		Add iSCSI Name (Note 1)
		Delete iSCSI name		Del iSCSI Name (Note 1)
		Change iSCSI name & Name		Change iSCSI Name (Note 1)

**Table 11** Operation and Terms Displayed in Audit Log File (continued)

Panel	Tab	Operation	Output of Audit Log File	
			Function	Operation
		Erase iSCSI name		Del DKC iSCSI Name (Note 1)
	Port (Note 4)	Standard Mode		Set Speed Mode (Note 1)
		High Speed Mode		Set Speed Mode (Note 1)
		High Speed (2Port) Mode		Set Speed Mode (Note 1)
		Fibre Addr.		Set Fibre Address (Note 1)
		Fabric		Set Fibre Topology (Note 1)
		Connection		Set Fibre Topology (Note 1)
		Host Speed		Set Channel Speed (Note 1)
		IP Address		Set IP address
		Subnet Mask		Set IP address
		Gateway		Set IP address
		iSCSI Name		Set iSCSI name
		iSCSI Alias		Set iSCSI name
		Port Number		Set TCP/IP port
		Keep Alive Timer		Set KAT
		iSNS Server		Set iSNS
		iSNS IP Address		Set iSNS
		iSNS Port No.		Set iSNS
	UserAuth	Set AuthSwitch		Set AuthSwitch (Note 1) (Note 2)
		Set AuthInfo		Set AuthInfo (Note 1) (Note 2)
		Set AuthTargetInfo		Set AuthTargetInfo (Note 1) (Note 2)
LUSE	LUSE (Note 5)	Make LUSE	LUSE	Make LUSE (Note 1)
VLL		Release LUSE		Release LUSE (Note 1)
	VLL	Set Shredding	SHRED	Set Shredding (Note 1)
		Suspend Shredding		Suspend Shredding (Note 1)
		Install CV	VLL	Install CV (Note 1)

**Table 11** Operation and Terms Displayed in Audit Log File (continued)

Panel	Tab	Operation	Output of Audit Log File	
			Function	Operation
		Volume to Space		Volume to Space (Note 1)
		Volume Initialize		Volume Initialize (Note 1)
		Make Volume		Make Volume (Note 1)
		Blockade	LDEV	Volume-Blockade (Note 1)
		Restore		Volume-Restore(N) (Note 1)
FlashAccess / PCR	FlashAccess	Set FlashAccess (Open Volume)	Cache	Set Open DCR (Note 1) (Note 2)
		Set FlashAccess (M/F Volume)		Set M/F DCR (Note 1) (Note 2)
		Release FlashAccess (Open Volume)		Delete Open DCR (Note 1) (Note 2)
		Release FlashAccess (M/F Volume)		Delete M/F DCR (Note 1) (Note 2)
		Prestaging ON		DCR Prestaging (Note 1) (Note 6)
	PCR	PCR Set / Clear	ENAS	Set Cache Color (Note 1)
Performance Monitor	Performance Monitor [Physical]	Get Latest Data	PFM	Get Latest Data
	Monitoring	LongRange Monitoring S/W On		S/W LongRange (Note 1)
LUN Configuration Manager XP	Options	LongRange Monitoring S/W Off		S/W LongRange (Note 1)
		ShortRange Monitoring S/W On		S/W ShortRange (Note 1)
Prioritized Port Control		ShortRange Monitoring S/W Off		S/W ShortRange (Note 1)
	Manual Plan	Set	CC	Set Migration Vol (Note 1) (Note 2)
		Delete		Set Migration Vol (Note 1) (Note 2)
	Auto Plan	Auto Migration Function		Set Auto Plan Param (Note 1)
		Make New Plan		Create Auto Plan (Note 1)

**Table 11** Operation and Terms Displayed in Audit Log File (continued)

Panel	Tab	Operation	Output of Audit Log File	
			Function	Operation
		Delete		Create Auto Plan (Note 1)
	Attribute	Change Class Threshold		Set Class Threshold (Note 1)
		Fixed PG		Set Fixed PG (Note 1) (Note 2)
		Normal PG		Set Fixed PG (Note 1) (Note 2)
		Reserved LDEV		Set Reserved Vol (Note 1) (Note 2)
		Normal LDEV		Set Reserved Vol (Note 1) (Note 2)
	History	Erase Auto Migration History		Del Auto Plan Log
		Erase Migration History		Del Migration Log
	Port	All Thresholds	PPC	Set All Prio Port (Note 1) (Note 2) Set Ctrl Kind
		Set Prio Port		Set Prio Port (Note 1) (Note 2) Set All Prio Port
		Initialize		Default Set (Note 1) (Note 2)
		Delete ports if CHA is removed		Clear PPC Info
		Set Ctrl Kind (Port Control)		Set Ctrl Kind
	WWN	All Thresholds		Set All Prio WWN (Note 1) (Note 2)
		Set Prio WWN		Set Prio WWN (Note 1) (Note 2) Set All Prio WWN
		Update WWN		Update WWN (Note 1) (Note 2) Set All Prio WWN
		Add WWN (WWN is added to a PPC Group.)		Update PPCGrp (Note 1) (Note 2)
		Delete WWN (WWN is deleted to a PPC Group.)		Update PPCGrp (Note 1) (Note 2)
		PPC Group Add & WWN Add		Update PPCGrp (Note 1) (Note 2) Set All Prio WWN

**Table 11** Operation and Terms Displayed in Audit Log File (continued)

Panel	Tab	Operation	Output of Audit Log File	
			Function	Operation
		PPCGroup Delete		Update PPCGrp (Note 1) (Note 2) PPCGrp Del/Chg Set All Prio WWN
		Change PPCGroup (Attribute/Upper)		Change PPCGrp (Note 1) (Note 2) Set All Prio WWN
		PPCGroup Change (ReName)		PPCGrp Del/Chg (Note 1) (Note 2) Set All Prio WWN
		Set Ctrl Kind (WWN Control)		Set Ctrl Kind (Note 1) (Note 2)
		Port-WWN Add		Update Port WWN (Note 1) (Note 2)
		Port-WWN Delete		Update Port WWN (Note 1) (Note 2)
		Initialize		Default Set (Note 2)
		Delete ports if CHA is removed		Clear PPC Info (Note 2)
TrueCopy	Pair Operations	Paircreate	TC	Paircreate (Note 1) (Note 2)
		Pairsplit-S		Pairsplit-S (Note 1) (Note 2)
		Pairsplit-r		Pairsplit-r (Note 1) (Note 2)
		Pairresync		Pairresync (Note 1) (Note 2)
		Change Pair Option		Change Pair Option (Note 1) (Note 2)
	RCU Operations	Add RCU	RCU	Add RCU
		Change RCU Option		Change RCU Option
		Delete RCU		Delete RCU
		Add Path		Add Path (Note 1) (Note 2)
		Delete Path		Delete Path (Note 1) (Note 2)
		Add SSID		Add RCU
		Delete SSID		Delete RCU
		PortChange	PORT	Check Port
				Change Port



**Table 11** Operation and Terms Displayed in Audit Log File (continued)

Panel	Tab	Operation	Output of Audit Log File	
			Function	Operation
				Restart Port
	Asynchronous	Add CT Group	TC	Add CTG
	Operations	CT Group Option		Change CTG Option
		Delete CT Group	TC S/390(R)	Delete CTG
		Async Option	TC	Change Async Option
Business Copy XP	Main	Paircreate	SI	Paircreate (Note 1)
		Pairsplit		Pairsplit (Note 1)
		Pairresync		Pairresync (Note 1)
		Pairsplit-E		Pairsplit-E (Note 1)
		Pairsplit-S		Pairsplit-S (Note 1)
		Change Reserve		ChangeReserve (Note 1)
	Option	Option		Option (Note 1)
TrueCopy -	Pair Operations	Add Pair	TC S/390(R)	Add Pair (Note 1) (Note 2)
S/390(R)		Delete Pair		Delete Pair (Note 1) (Note 2)
		Suspend Pair		Suspend Pair (Note 1) (Note 2)
		Resume Pair		Resume Pair (Note 1) (Note 2)
		Change Pair Option		Change Pair Option (Note 1) (Note 2)
	RCU Operations	Add RCU	RCU	Add RCU
		Change RCU Option		Change RCU Option
		Delete RCU		Delete RCU
		Add Path		Add Path (Note 1) (Note 2)
		Delete Path		Delete Path (Note 1) (Note 2)
		Add SSID		Add RCU
		Delete SSID		Delete RCU
		PortChange	PORT	Check Port

**Table 11** Operation and Terms Displayed in Audit Log File (continued)

Panel	Tab	Operation	Output of Audit Log File	
			Function	Operation
				Change Port
				Restart Port
	Asynchronous	Add CT Group	TC S/390(R)	Add CTG
	Operations	CT Group Option		Change CTG Option
		Delete CT Group		Delete CTG
		Async Option		Change Async Option
	Script Operations	Run		Script Operation
		Stop		
	Other Operations	Clear SIM		Complete SIM
Business Copy XP	Main	Add Pair	SI S/390(R)	AddPair (Note 1)
- S/390(R)		Split Pair		SplitPair (Note 1)
		Resync Pair		ResyncPair (Note 1)
		Suspend Pair		SuspendPair (Note 1)
		Delete Pair		DeletePair (Note 1)
		Change Reserve		ChangeReserve (Note 1)
	Option	Option		Option (Note 1)
	CTG	Add CTG		CTG (Note 1)
		Delete CTG		CTG (Note 1)
Mainframe	HPAV	Add	HPAV	Add Alias (Note 1)
		Delete		Delete Alias (Note 1)
	SANTinel	Set Group	SANTinel	Set Group (Note 1)
	LDEV Guard	Attribute	LDG	Attribute (Note 1)
		VTOC		VTOC (Note 1)
OpenLdev	OpenLdev	Attribute / S-VOL / Reserved	OLG	Attribute (Note 1)
Guard	Guard	Retention-Term		Retention-Term (Note 1)

**Table 11** Operation and Terms Displayed in Audit Log File (continued)

Panel	Tab	Operation	Output of Audit Log File	
			Function	Operation
		Expiration Lock		Audit Lock (Note 1)
Flex Copy XP	LU Operation	Add LU	HC	Add-Wwn / Add Lu (Note 1)  <b>NOTE:</b> Add Wwn is output only when the WWN has not been registered.
		Delete LU		Delete-Lu (Note 1)
		Alternate Path (ADD / Delete / Priority UP / Priority Down)		Alternate Path (Note 1)
		Restore	LDEV	Volume-Restore(F) (Note 1)
	Port Operation	Change to Target/ Change to	PORT	Check Port
		External		Change Port
	Hi-Copy	Create Pair	HC	Paircreate (Note 1)
		Delete Pair		Pairsplit-S (Note 1)
CFL	Configuration File Loader	Upload	CFL	LUNM Operation  <b>NOTE:</b> The log information is not output for the format violation and inconsistency of configuration.
LicenseKey	LicenseKey	Install	PPKey	PP Install (Note 1) (Note 2)
SNMP		Uninstall		PP Uninstall (Note 1) (Note 2)
Just in Time		File		PP Install from File
	SNMP	Set SNMP Agent	SNMP	Set SNMP Agent
	Just in Time	On-Demand: ON -> OFF	JIT	Release LUN (Note 1)
		Extend		Release Cache (Note 1)
Information / Status	Information	Set System Info	BASE	Set System Info

**Table 11** Operation and Terms Displayed in Audit Log File (continued)

Panel	Tab	Operation	Output of Audit Log File	
			Function	Operation
All	Common to all tabs	Login	BASE	LOGIN ( <i>Note 7</i> )  <b>NOTE:</b> The IP address of the web client is output as the parameter.  <b>NOTE:</b> When "*" is output at the end of the IP address, the IP address may be that of the proxy server.
		Logout		LOGOUT ( <i>Note 7</i> )
				UNLOCK_LOGOUT  <b>NOTE:</b> This log information indicates the processing of the release of the Modify authority by the system during logout.
		Modify		LOCK
		View		UNLOCK  <b>NOTE:</b> This information is output regardless of the status of the Modify mode.
		Closing with the × button of the web browser without any processing.		UNLOCK_LOGOUT  <b>NOTE:</b> If the session is cut off while the processing is in progress, this information is output as the processing has finished.

**Table 11** Operation and Terms Displayed in Audit Log File (continued)

Panel	Tab	Operation	Output of Audit Log File	
			Function	Operation
		Timeout of Modify		UNLOCK_TIMEOUT
		Network failure, termination of the web browser processing from the task manager, and so on.		UNLOCK_TIMEOUT  <b>NOTE:</b> As the connection from the client is disconnected and the processing is ended without the demand of logout, the timeout occurs in the server side and the log information is output.



**NOTE:** This information is output regardless of the status of the Modify mode.

**Note 1:** When two or more settings of the same kind are applied to the disk array at one time, the log information is output as one entry.

**Note 2:** When one or more settings that are applied at one time end abnormally, the output log information will be "Error", not "Warning."

**Note 3:** The notes on the log information that is output, when two or more LUNM settings are set, is as follows:

- When two or more operations are performed for one target, the log information is output as one entry. For example, if you have performed the changing operation twice for one LU consecutively, and then clicked **Apply**, the log information is output just as "change."
- When two or more settings are applied at one time, the log information is output according to the priority shown in [Table 12](#). If the priority is the same, the log information is output in the order of the operations performed.

**Table 12** LUNM Operation and Priority of Log Information Output

Operation	Target of Operation		Priority
Delete	LU		2
	Host Group		1
	WWN (iSCSI name)		
Add	DKC connection WWN (iSCSI name)		2
	LU		4
	Host Group		3
	WWN (iSCSI name)		

**Table 12** LUNM Operation and Priority of Log Information Output (continued)

Operation	Target of Operation		Priority
Change	Host Group		3
	WWN (iSCSI name)		
	Changing Host Mode		
	Command Device		4
	Command Dev. Security		
	LUN Security	OFF	3
		ON	1

- The examples of the combination of multiple operations that are performed for one target at one time and the output log information are as follows:
  - **Add →Delete**: The operations cancel each other; therefore, the log information is not output.
  - **Change →Delete**: Only the log information on the Delete operation is output.
  - **Change 1 →Change 2**: Only the log information on the Change 2 operation is output.
  - **Add →Change**: The log information is output as the Add operation; however, the contents of the setting are output according to the setting of the Change operation.
- When deletion of a Host Group is set, the following operations that have been performed for that Host Group are not output as the log information:
  - Changing host mode
  - Changing Host Group
  - Adding or deleting paths
  - Adding, changing, or deleting WWN

**Note 4:** The notes on the log information that is output, when two or more Port settings are set, are as follows:

- When two or more operations are performed for one target, the log information is output as one entry.
- The log information is output in the order of the operations performed.
- An example of the combination of multiple operations that are performed for one target at one time and the output log information is as follows:

Change 1 →Change 2: The log information only on the Change 2 operation is output.

**Note 5:** The notes on the log information that are output when two or more LUSE settings are set are as follows:

- When two or more operations are performed for one target, the log information is output as one entry. For example, if you have created one LUSE volume and then created another LUSE volume using the previously-created LUSE volume, the log information is output just as "create."
- The log information is output in the order of the operations performed.

- The examples of the combination of multiple operations that are performed for one target at one time and the output log information are as follows:

Create LUSE volume →Delete LUSE volume: The operations cancel each other, therefore the log information is not output.

Create LUSE volume 1 →Create LUSE volume 2 →Create LUSE volume 3 using LUSE volume 1 and LUSE volume 2 →Delete LUSE volume 3: Only the log information for the Create LUSE volume 1 operation and Create LUSE volume 2 operation is output.

**Note 6:** The log information is output at the end, no matter when the Cache LUN operation is performed.

**Note 7:** The log information is output in the Login information file (login.log).

---

## Basic information

When you click the **Basic Information** icon in the Command View main window, the Basic Information Display pane appears. The Basic Information Display pane displays the basic configuration information of the XP12000 and consists of the Port pane, LUN pane, and LDEV pane. When you log on as a storage partition administrator, the information on the allocated SLPR is displayed. The Basic Information Display pane is another pane that is displayed apart from the Command View main window; therefore, it can be displayed regardless of the operation of the Command View options. For example, when you perform the setting operation of one of the Command View options, you may need to check the existing setting information on the ports or LUNs. In such a situation, you can display the Basic Information Display pane and look at the basic configuration information, at the same time you can perform the operation.

Following is the description on the Basic Information Display pane:

- The information displayed on the Basic Information Display pane is updated:
  - When the tab is selected on the Basic Information Display pane and the displayed pane is changed.
  - When the **Refresh** icon in the Command View main window is selected.
  - When the tab is selected in the Command View window during the operation of the product option and the displayed pane is changed.
  - When the **Apply** button is clicked in the Command View main window.
  - When the operation mode is changed from View mode to Modify mode in the Command View main window.
- If the volume is a LUSE volume, you can display the detailed information of the LUSE volume. If you select an LUSE volume in the list of the LUN pane or the LDEV pane and right-click, the Detail Information command is displayed. As you select the Detail Information command, the detailed information of the LUSE volume is displayed.
- You can export the information displayed on the Basic Information Display panel as the comma-separated format (CSV) file by clicking the **Export** button at the lower left of the Basic Information Display pane. To export the information displayed on the Basic Information Display pane as a CSV file, follow these instructions:
  1. Click **Export** at the lower left of the Basic Information Display pane. The pane for selecting the file is displayed.
  2. Specify the file name and location to save the file on the displayed pane.
  3. Click **Save**.

When the saving processing finishes, the procedure is complete. Click **Close** to close the Basic Information Display pane. The **Close** button is located on the lower right of the Basic Information Display pane.

## Port pane

SLPR	Port Name	Type	Host Speed	Addr.(LoopID)	Fabric	Connection	Attribute	500E
00:SLPR-00-D...	CL1-A	Fibre	Auto	EF (0)	Enable	P-to-P	External	500E
00:SLPR-00-D...	CL3-A	Fibre	Auto	E8 (1)	Enable	P-to-P	Target	500E
00:SLPR-00-D...	CL5-A	Fibre	Auto	E4 (2)	Enable	P-to-P	External	500E
03:SLPR-03-P...	CL7-A	Fibre	Auto	E2 (3)	Enable	P-to-P	Target	500E
02:SLPR-02-KS	CL1-B	Fibre	Auto	E1 (4)	Enable	P-to-P	Target	500E
00:SLPR-00-D...	CL3-B	Fibre	Auto	E0 (5)	Enable	P-to-P	Target	500E
00:SLPR-00-D...	CL5-B	Fibre	Auto	DC (6)	Enable	P-to-P	Target	500E
00:SLPR-00-D...	CL7-B	Fibre	Auto	DA (7)	Disable	FC-AL	Target	500E
01:SLPR-00-k...	CL1-C	Fibre	Auto	D9 (8)	Enable	P-to-P	Target	500E
00:SLPR-00-D...	CL3-C	Fibre	Auto	D6 (9)	Enable	FC-AL	Target	500E
00:SLPR-00-D...	CL5-C	Fibre	Auto	73 (63)	Enable	FC-AL	Target	500E
00:SLPR-00-D...	CL7-C	Fibre	Auto	D4 (11)	Enable	P-to-P	Target	500E
00:SLPR-00-D...	CL1-D	Fibre	Auto	D3 (12)	Disable	FC-AL	Target	500E
00:SLPR-00-D...	CL3-D	Fibre	Auto	D2 (13)	Disable	FC-AL	Target	500E
00:SLPR-00-D...	CL5-D	Fibre	Auto	D1 (14)	Disable	FC-AL	Target	500E
00:SLPR-00-D...	CL7-D	Fibre	Auto	CE (15)	Enable	P-to-P	Target	500E
00:SLPR-00-D...	CL2-A	Fibre	Auto	CD (16)	Enable	P-to-P	External	500E
00:SLPR-00-D...	CL4-A	Fibre	Auto	CC (17)	Enable	P-to-P	Target	500E
00:SLPR-00-D...	CL6-A	Fibre	Auto	CB (18)	Enable	P-to-P	External	500E
00:SLPR-00-D...	CL8-A	Fibre	Auto	CA (19)	Disable	FC-AL	Target	500E
00:SLPR-00-D...	CL2-B	Fibre	Auto	C9 (20)	Disable	FC-AL	Target	500E
00:SLPR-00-D...	CL4-B	Fibre	Auto	C7 (21)	Disable	FC-AL	Target	500E
00:SLPR-00-D...	CL6-B	Fibre	Auto	C6 (22)	Disable	FC-AL	Target	500E
00:SLPR-00-D...	CL8-B	Fibre	Auto	C5 (23)	Disable	FC-AL	Target	500E
00:SLPR-00-D...	CL2-C	Fibre	Auto	C3 (24)	Enable	P-to-P	Target	500E

**Figure 41** Port pane (Basic Information display)

This pane displays the following items:

- **SLPR drop-down list:**

You can display the information on a particular SLPR as you select the SLPR in the SLPR list. If you have logged on as a storage partition administrator, the information only on the allocated SLPR is displayed, and you cannot select other SLPRs in this drop-down list.

- **Port list:** The following items are displayed in the Port list:

- **SLPR:** SLPR number and SLPR name
- **Port Name:** Port name
- **Type:** Type of port. Fibre, NAS, or Serial is displayed.
- **Host Speed:** Data transfer speed for Fibre Channel ports. The unit is Gbps (Gigabits per second).
- **Addr. (Loop ID):** Address and Loop ID of port
- **Fabric:** Indicates whether a Fabric switch is used. **Enable** or **Disable** is displayed
- **Connection:** Topology. FC-AL or P-to-P is displayed
- **Attribute:** Port attribute. Initiator, Target, RCU Target, External, LCP, or RCP is displayed
- **WWN:** WWN of host bus adapter



# LUN pane

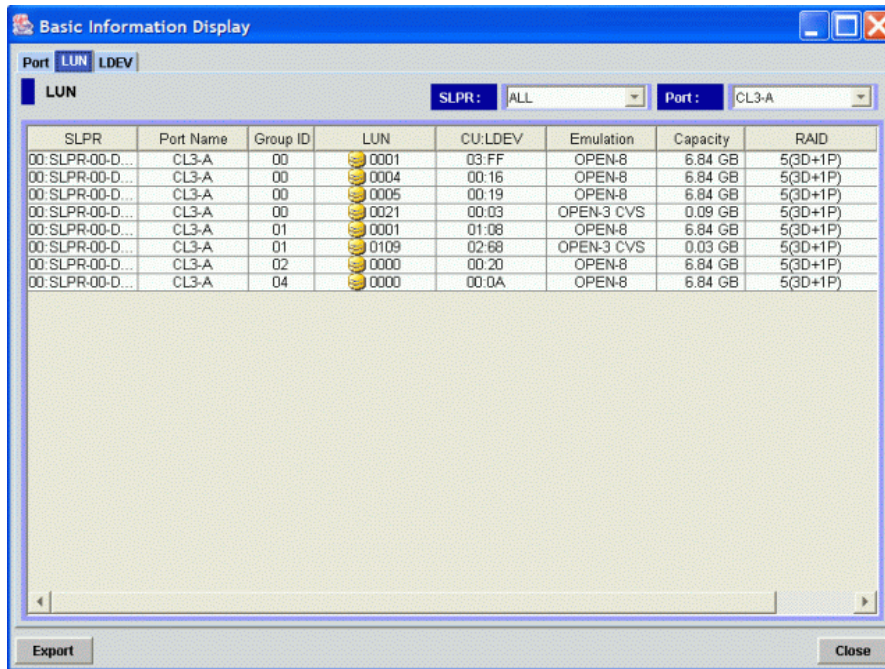

**Figure 42** LUN pane (Basic Information display)

This pane displays the following items:

- **SLPR** drop-down list:

You can display the information on a particular SLPR as you select the SLPR in the SLPR list. If you have logged on as a storage partition administrator, the information only on the allocated SLPR is displayed, and you cannot select other SLPRs in this drop-down list.

- **Port** list: Select from the list the port for which information is to be shown

- **LUN** list: Following items are displayed in the LUN list:

- **SLPR:** SLPR number and SLPR name

- **Port Name:** Port name

- **Group ID:** Host group ID

- **LUN:** LUNs (logical unit numbers) assigned to logical volumes

The  icon indicates a logical volume to which an LU path is defined.

The  icon indicates an expanded LU.

The  icon indicates a command device

The  icon indicates command device security

- **CU:LDEV:** The CU image number appears to the left of the colon. To the right of the colon displays the LDEV number.

- **Emulation:** Emulation type

- **Capacity:** Volume capacity

- **RAID:** RAID level

- **Paths:** Number of paths

# LDEV pane

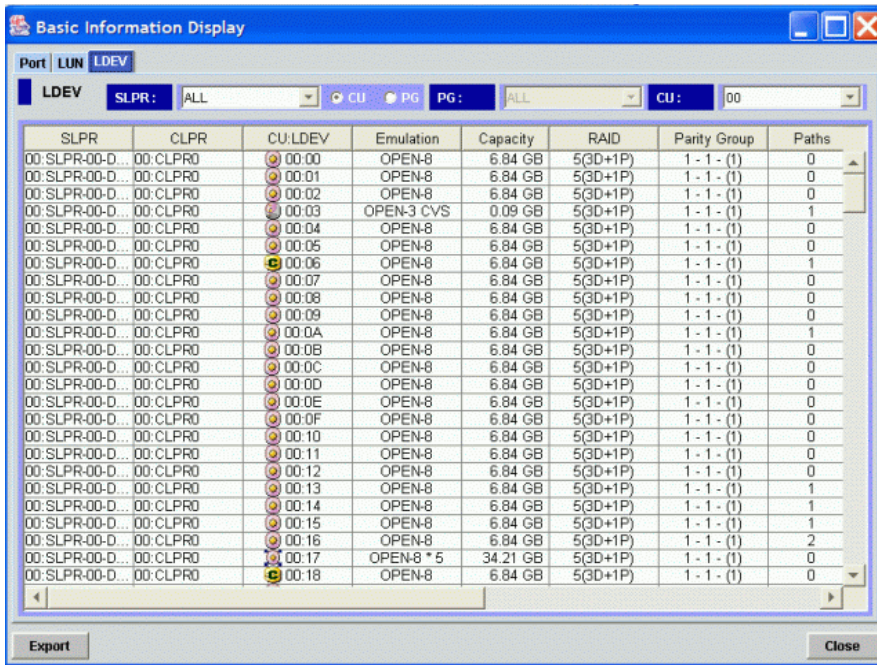

Figure 43 LDEV pane (Basic Information display)

This pane displays the following items:

- **SLPR** drop-down list:

You can display the information on a particular SLPR as you select the SLPR in the SLPR list. If you have logged on as a storage partition administrator, the information only on the allocated SLPR is displayed, and you cannot select other SLPRs in this drop-down list.

- The buttons for selecting drop-down list:

- If you click **CU**, the **PG** list becomes unavailable and **ALL** is automatically selected. You can select a CU from the **CU** list.
- If you click **PG**, you can select a parity group from the **PG** list. The **CU** list becomes unavailable and **ALL** is automatically selected.

- **PG** list: You can select the parity group for which the information to be listed from the list.

- **CU** list: You can select the CU for which the information to be listed from the list.

- **LDEV** list: The following items are displayed in the LDEV list:

- **SLPR**: SLPR number and SLPR name.
- **CLPR**: CLPR number and CLPR name
- **CU:LDEV**: The CU image number displays to the left of the colon. The LDEV number is shown on the right of the colon.

The (🟢) icon indicates a normal LDEV

The (🟡) icon indicates an expanded (LUSE) volume

The (🔒) icon indicates a reserved volume

The (📏) icon indicates a variable sized volume (CV)

The (🔒) icon indicates that the security is set for the volume

The (📁) icon indicates a command device

The (🔒) icon indicates command device security

- **Emulation:** Emulation type
- **Capacity:** Volume capacity
- **RAID:** RAID level
- **Parity Group:** Parity Group
- **Paths:** Number of paths
- **External Device Information:** Information on the external volume is displayed in the format of vendor/product name/serial number.
- **External Paths:** Number of paths that are set for the external volume
- **IO Suppression Mode:** IO Suppression mode set for the external volume when it was mapped
- **Cache Mode:** Cache Mode set for the external volume when it was mapped

## Displaying the detailed information on the LUSE volume

If you select an LUSE volume in the list of the LUN pane (see [Figure 42](#)) or the LDEV pane (see [Figure 43](#)) and right-click, the Detail Information command is displayed. When you select the Detail Information command, the detailed information of the LUSE volume is displayed in the Detail Information pane.

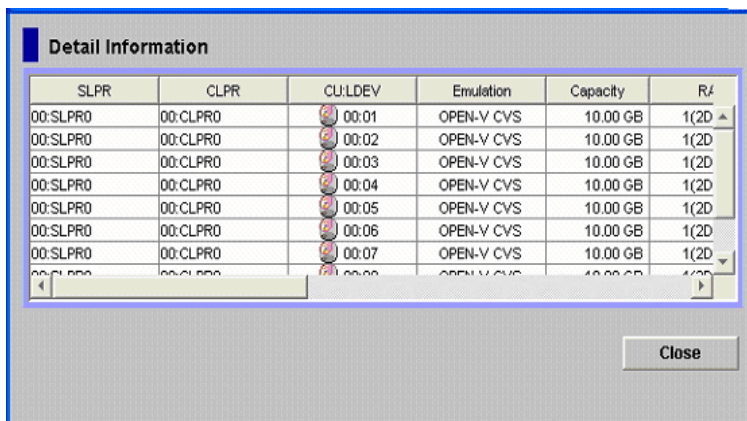

The screenshot shows a window titled "Detail Information" with a table containing the following data:

SLPR	CLPR	CU:LDEV	Emulation	Capacity	R/
00:SLPRO	00:CLPRO	📁 00:01	OPEN-V CVS	10.00 GB	1(2D) ▲
00:SLPRO	00:CLPRO	📁 00:02	OPEN-V CVS	10.00 GB	1(2D)
00:SLPRO	00:CLPRO	📁 00:03	OPEN-V CVS	10.00 GB	1(2D)
00:SLPRO	00:CLPRO	📁 00:04	OPEN-V CVS	10.00 GB	1(2D)
00:SLPRO	00:CLPRO	📁 00:05	OPEN-V CVS	10.00 GB	1(2D)
00:SLPRO	00:CLPRO	📁 00:06	OPEN-V CVS	10.00 GB	1(2D)
00:SLPRO	00:CLPRO	📁 00:07	OPEN-V CVS	10.00 GB	1(2D) ▼
00:SLPRO	00:CLPRO	📁 00:08	OPEN-V CVS	10.00 GB	1(2D)

A "Close" button is located at the bottom right of the pane.

**Figure 44** Detail Information Pane

# Control Panel (XP128/XP1024/XP12000)

Use the Control Panel to view user accounts and set environment parameters. To access the Control Panel, click **Option** (  ) in the Command View window.

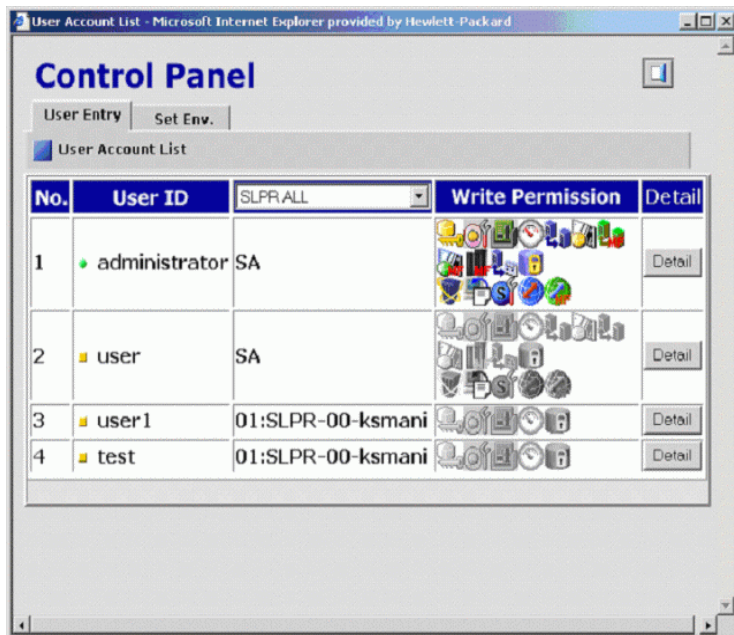

**Figure 45** Control Panel for the XP12000

## User Entry tab

User Entry is the default tab for the Control Panel. This tab is read-only and includes the following items:

- **No.:** Displays the order of user entries. The default user (administrator) is displayed at the top of the list. The administrator can register up to 500 users including the root.
- **User ID:** ID of the listed Command View user account
- **SLPR:** (XP12000 only) SLPR number and its nickname assigned to the Command View user account. (See note below.)



**NOTE:** For users having full array access, the SLPR column will have the value "SA". For users having partition level access, the SLPR column will have the SLPR number and its nickname separated by ":".



- **Write Permission:** Displays icons that show the options each user is permitted to use with Modify mode.
- **Detail:** Click to access details about Write Permissions (see [Figure 46](#)).

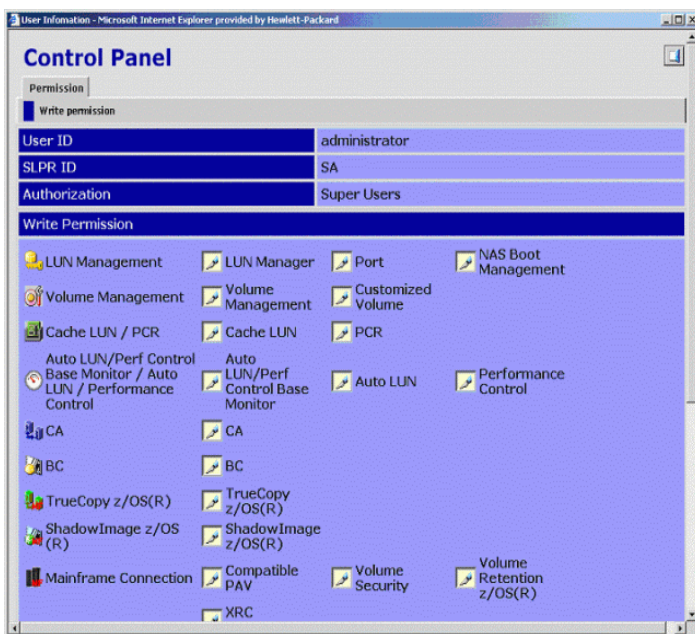
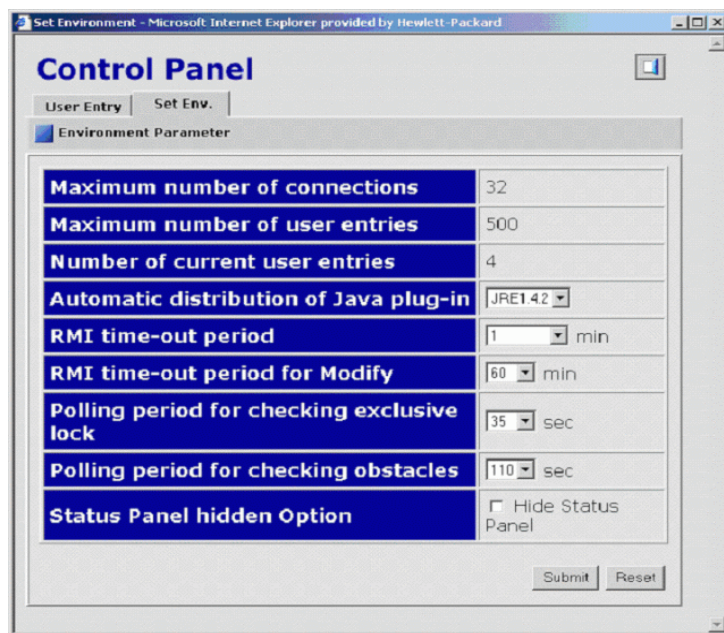

**Figure 46** Write permissions window

- **Exit** button: Click (  ) to close the Control Panel.

## Set Env tab

The Set Environment tab lets Administrators view and set the Command View environment parameters.



**Figure 47** Set Environment tab

The following parameters are view-only in the Set Environment tab:

- **Maximum number of connections:** Sets the maximum number of Command View users that can concurrently connect to the same subsystem.

- **Maximum number of user entries:** Sets the maximum number of user entries that can be registered in the user account list of a subsystem.



**NOTE:** You cannot change these values from the Command View user interface. Contact your HP Account Support Representative if you want to change the default values.

- **Number of current user entries:** The number of user entries currently registered in the user account list.
- **Automatic distribution of Java plug-in:** The Java Runtime Environment (JRE) is required to use Command View; however, if the Command View web client does not have the JRE, the SVP can automatically distribute and install the appropriate JRE into the Command View computer when the user logs on to the array.

The default is JRE1.4.2. You can select JRE1.4.1 or JRE1.4.2 from the list for the Automatic distribution of the Java plug-in parameter. See the minimum requirements for Command View in the *HP StorageWorks Command View Installation Guide*.



**NOTE:** This parameter cannot be disabled.

- **RMI™ time-out period:** If the user cannot access the array for a certain period of time because of a network error, the RMI™ time-out logs the user off of the array. This feature has the following parameters:
  - The default is 1 minute. You can specify 1 minute, 5 - 60 minutes in 5-minute increments, 70 to 120 minutes in 10-minute increments, or one day (24 hours).
  - The value of the RMI™ time-out period must be greater than the value set for the smallest polling period, either for checking exclusive lock or for checking obstacles (see below for those parameters).

For example, specify a value of the RMI™ time-out period parameter to satisfy the following condition: RMI™ time-out period min [A, B], where A = Polling period for checking exclusive lock, B = Polling period for checking obstacles, and min [A, B] indicates the minimum value selected from A and B.



**NOTE:** This parameter cannot be disabled.

- **RMI™ time-out for Modify:** If a user is in Modify mode but does not make any changes that access the RMI™ server for a specified period of time, Modify mode is released and View mode is displayed.
  - The default time period is 60 minutes. You can specify between 10 and 60 minutes in 10-minute increments or between 120 and 360 minutes in 60-minute increments.
  - Select **No** to disable this parameter.
- **Polling period for checking exclusive lock:** If multiple users are accessing the array in View mode while one user is changing the array in Modify mode, the array can monitor the user who is changing the array. The Locked and Unlocked icons are updated when the array is polled or when the user who is in Modify mode logs out of Command View.



**NOTE:** The shorter the time period you specify, the more frequently the Lock/Unlock status is updated, but this increases network traffic.

- The default time period is 35 seconds. You can specify 5 to 60 seconds in 5-second increments or 70 to 120 seconds in 10-second increments.
- Select **No** to disable this parameter.
- **Polling period for checking obstacles:** Specify a time interval to monitor the Disk Controller and Disk Array Unit status, which is displayed by the status lamp icon in the Status panel of the main window.
  - The default is 110 seconds. You can specify 5 to 60 seconds in 5-second increments, 110, or 120 for this parameter.
  - Select **No** to disable this parameter.
- **Status Panel hidden Option:** Check the **Hide Status Panel** box to display the Status pane. If the **Hide Status Panel** box is selected, the Status tab and Status pane disappear from the Command View main window. By default, the box is cleared.



---

**NOTE:** It is recommend that you select **NO** for the Polling period for checking obstacles when the **Hide Status Panel** box is selected.

---

- **Submit:** Applies the Command View settings.
- **Reset:** Resets the Command View settings to the defaults.

### Setting the Command View environment parameters

1. Click **Option** () in the main window to open the Control Panel.
2. Click the **Set Env.** tab.
3. Specify the Command View parameters as required.
4. Click **Submit**.
5. When a confirmation message is displayed, click **OK**.
6. Click **Exit** () to close the Control Panel.

### Log tab (XP128/XP1024 only)

Use the Log tab to view Command View log information, such as access log, error log, and operation log.

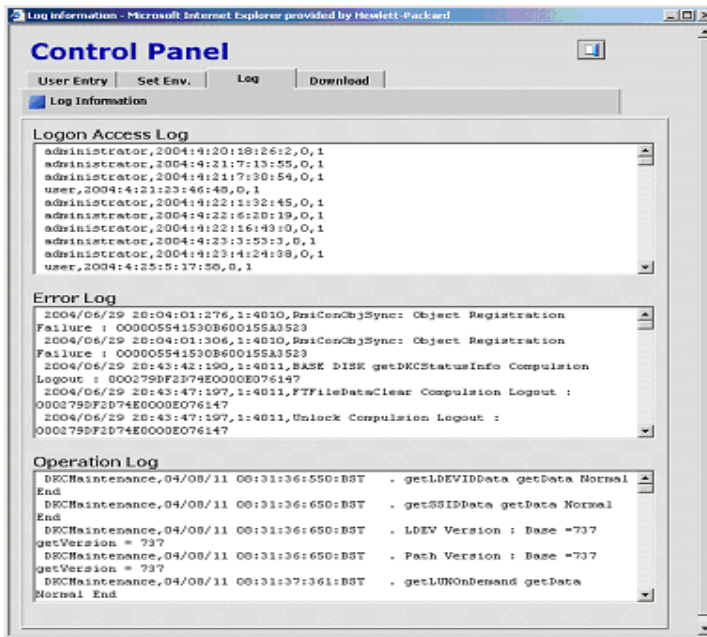



**Figure 48** Log tab (XP128/XP1024 only)

The Log Information pane has the following features:

- **Logon Access Log:** The access log of the users who logged on to the array. The logon access log includes the user ID, logon and logoff date and time, and flag.
- **Error Log:** The error information of the RMI objects. The error log includes the date and time of error, error code, error type, and description.
- **Operation Log:** Information regarding Command View user operations. The operation log includes the user ID, date and time of operation, and operation type.

To view Log Information:

1. Click **Option** (  ) in the Command View window to open the Control Panel.
2. Click the **Log** tab.
3. Click **Exit** (  ) to close the Control Panel.

## Download Tab (XP128/XP1024 only)

Use the Download pane to download files containing Command View log information (such as error, access, and operation logs).



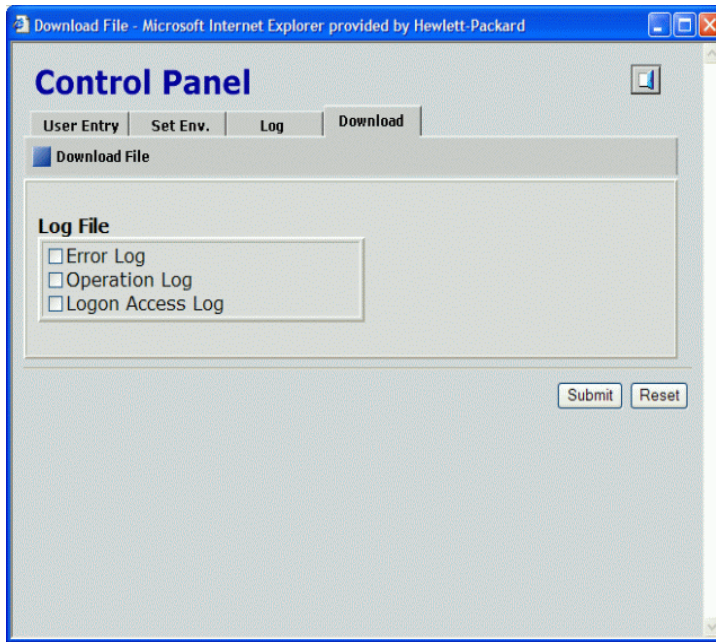

**Figure 49** Download tab (XP128/XP1024 only)

The Log File box displays the following check boxes:

- **Error Log**
- **Operation Log**
- **Logon Access Log**

#### To download Log Information:

1. Click **Option** (  ) in the Command View window to open the Control Panel.
2. Click the **Download** tab to open the Download File pane.
3. Check the check boxes of the desired files.
4. Click **Submit**. The Download pane opens.
5. Confirm that the selected files are marked with a colored icon, and then click **Download**. The File Download pane opens.
6. Select **Save this file to disk**.
7. Click **OK**. The Save As pane opens.



---

**NOTE:** The compressed file to be downloaded is automatically named; however, you can change the name.

---

8. Specify the name of a folder where you want to save the compressed file, and click **Save**. When download is complete, the Download Complete panel is displayed.
9. Click **Close** to close the Download Complete pane
10. Decompress the downloaded file (\*.tgz) as required.



**NOTE:** To create the \*.tgz file, the directory tree is archived using the tar command and then compressed using the gzip command. To decompress the \*.tgz file, please use the tool that supports tar and gzip commands. For instructions on decompressing the file, refer to the manual or online help of the tool you use.

---

11. Click **Exit** () to close the Control Panel.

# 10 Status monitoring XP48/XP512

The Status panes display a comprehensive overview of a selected disk array's configuration and condition.

## Accessing the Status pane

The Status panes summarize the hardware and storage configuration status for the selected disk array.

To access the **Status** panes, click **Modify** or **View** to an XP48/XP512 in the Device Launcher pane, and then click **Status**. The Status Overview pane appears.

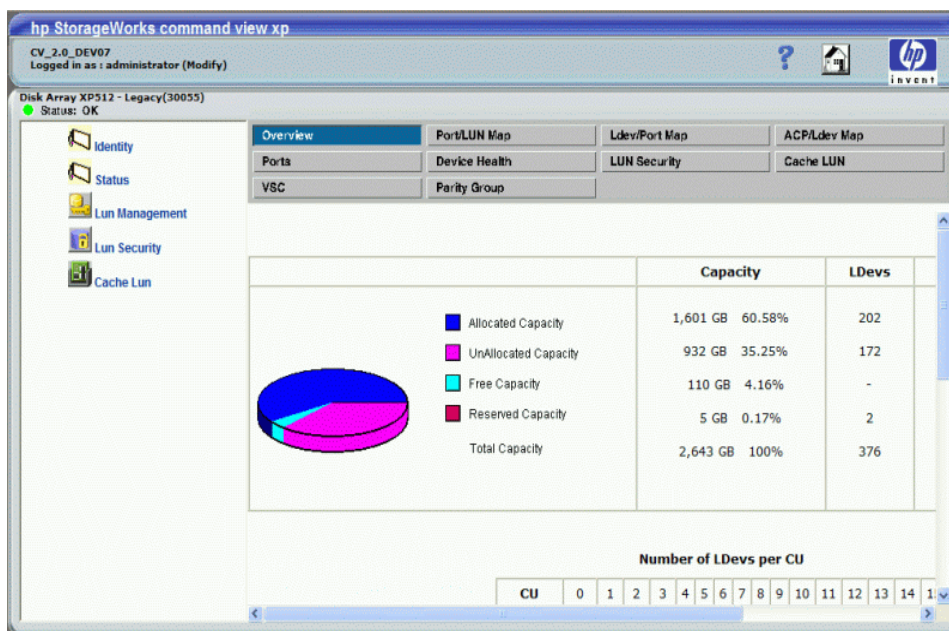

Figure 50 Status Overview Pane

To access this pane from another Status pane, click **Overview**.

## Status Overview pane

The capacity pie chart shows the current storage allocation: the allocated, unallocated, free, and reserved capacities. This table also lists capacity in GB and percentage, the number of LDEVs and LUNs, and the amount of cache memory.

- **Allocated Capacity:** Sum of the capacities of all allocated LDEVs. An LDEV is considered allocated when at least one LUN path is associated with it. If two LUN paths point to the same LDEV, the space on that LDEV is only counted once.
- **Unallocated Capacity:** Sum of the capacities of all unallocated LDEVs
- **Free Capacity:** Sum of all free space in the disk array
- **Reserved Capacity:** Sum of the capacities of all reserved LDEVs
- **Total Capacity:** Sum of the storage capacity of all LDEVs on the system

## LDevs column

- **Allocated LDEVs:** Number of LDEVs that are associated with LUNs
- **Unallocated LDEVs:** Number of LDEVs that do not have assigned LUN paths
- **Reserved LDEVs:** Number of LDEVs reserved as Auto LUN reserved volumes for use in LUN migration. This item is displayed only if HP StorageWorks Auto LUN XP is installed.
- **Total LDEVs:** Total number of LDEVs on the disk array

## Luns column

- **Total LUNs:** Number of created LUN paths.

## Tables

- **LDev/CU table:** Number of LDEVs associated with each CU
- **LDev/ACP table:** Number of LDEVs associated with each ACP pair
- **Hardware configuration table:** Quantity and names for the Channel Host Interface Processor (CHIP), Channel Processor (CHP), Array Control Processor (ACP), and Disaster Recovery and Regeneration Processor (DRR).

# Port/LUN Map pane

The Port/LUN Map pane shows a map of LUNs configured on each physical disk array port. A LUN is a path to a logical device (LDEV).

To access this pane, click **Status**, and then click **Port/LUN Map**.

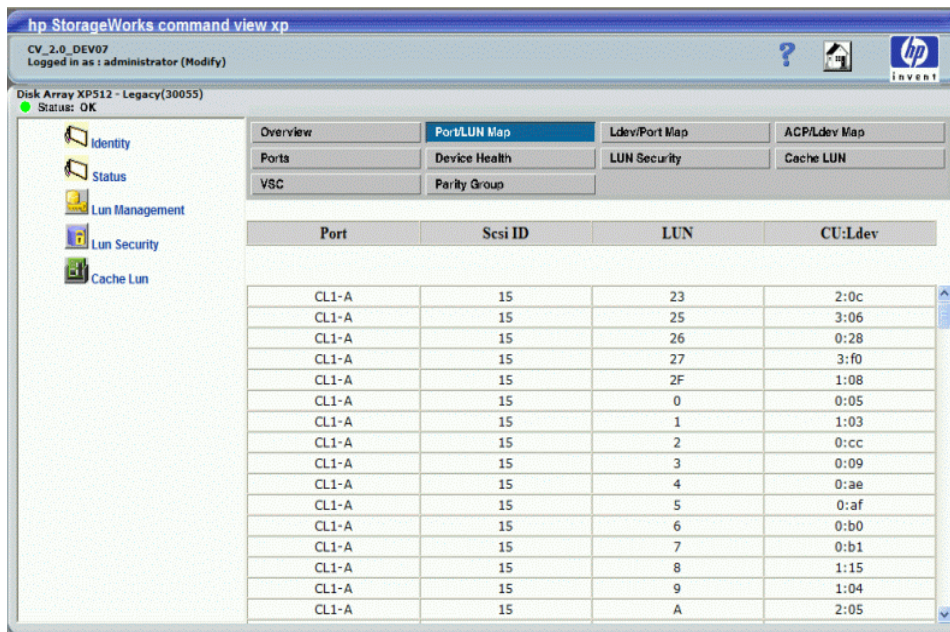

Port	Scsi ID	LUN	CU:Ldev
CL1-A	15	23	2:0c
CL1-A	15	25	3:06
CL1-A	15	26	0:28
CL1-A	15	27	3:f0
CL1-A	15	2F	1:08
CL1-A	15	0	0:05
CL1-A	15	1	1:03
CL1-A	15	2	0:cc
CL1-A	15	3	0:09
CL1-A	15	4	0:ae
CL1-A	15	5	0:af
CL1-A	15	6	0:b0
CL1-A	15	7	0:b1
CL1-A	15	8	1:15
CL1-A	15	9	1:04
CL1-A	15	A	2:05

**Figure 51** Port/LUN Map pane

This pane lists the following items:

- **Port:** Physical disk array port associated with this LUN
- **Scsi ID:** The ID, defined using LUN Management, associated with a LUN and LDEV
- **LUN:** LUN ID for the LUN

- **CU:LDev**: Control unit (CU) and the first logical device associated with the LUN
- **Save** button: Downloads the information from this pane to a text file

## Ldev/Port Map pane

The Ldev/Port Map pane shows a map of the LDEVs configured on each physical array port. LDEV configuration details are displayed.

It is possible to configure multiple physical disk array ports to access a single LDEV (by means of a LUN). Depending on your disk array configuration, the Ldev/Port Map pane may reference redundant physical ports associated with a single LDEV and LUN.

To access this pane, click **Status**, and then click **Ldev/Port Map**.

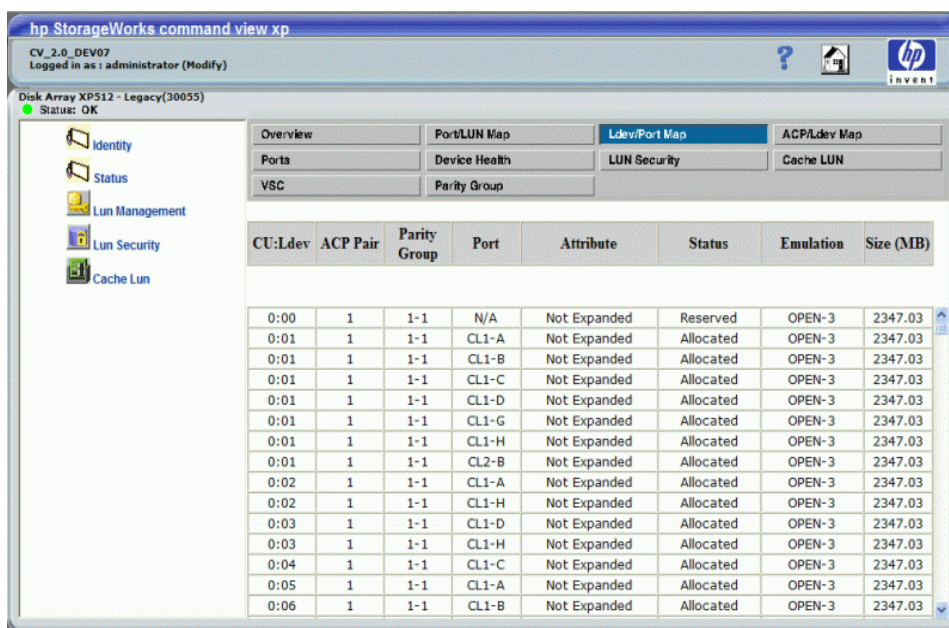

**Figure 52** Ldev/Port Map pane

This pane lists the following items:

- **CU:Ldev**: Control Unit (CU) and name of the logical device (LDEV).
- **ACP Pair**: The ACP pair associated with this LDEV. If the parity group spans across two ACP pairs, the table lists both pairs. For example: 1,2.
- **Parity Group**: Parity group associated with this LDEV
- **Port**: Physical disk array port associated with this LDEV
- **Attribute**: Indicates whether the LDEV is part of an expanded (LUSE) volume. LUSE functionality is available when the optional Volume Management software is installed.

**Table 13** Attribute values

Attribute	The LDEV is...
Not Expanded	Not part of an expanded volume



**Table 13** Attribute values (continued)

Attribute	The LDEV is...
Expanded - first	The top element in an expanded volume
Expanded - not first	Part of an expanded volume and is not the first element of the expansion

- **Status:** Free indicates that the LDEV is not allocated. **Allocated** indicates that a LUN has been assigned to the LDEV. **Reserved** indicates that a LUN has not been assigned. The LDEV is reserved for use by the Auto LUN migration function. Reserved status occurs only when HP StorageWorks Auto LUN XP is installed.
- **Emulation:** The open system emulation mode. This determines the size of the logical device.
- **Size (MB):** Size of the LDEV in megabytes
- **Save** button: Downloads the information from this pane to a text file

## ACP/Ldev Map pane

The ACP/Ldev Map pane displays a list of ACP pairs and their associated LDEVs.

To access this pane, click **Status**, and then click **ACP/Ldev Map**.

ACP Pair	CU:LDEV	Parity Group	Disk Group	Disk Type	Port
1	0:00	1-1	R100 R110 R120 R130	DKR1B-J047FC	N/A
1	0:01	1-1	R100 R110 R120 R130	DKR1B-J047FC	CL1-A
1	0:01	1-1	R100 R110 R120 R130	DKR1B-J047FC	CL1-B
1	0:01	1-1	R100 R110 R120 R130	DKR1B-J047FC	CL1-C
1	0:01	1-1	R100 R110 R120 R130	DKR1B-J047FC	CL1-D
1	0:01	1-1	R100 R110 R120 R130	DKR1B-J047FC	CL1-G
1	0:01	1-1	R100 R110 R120 R130	DKR1B-J047FC	CL1-H
1	0:01	1-1	R100 R110 R120 R130	DKR1B-J047FC	CL2-B
1	0:02	1-1	R100 R110 R120 R130	DKR1B-J047FC	CL1-A

**Figure 53** ACP/Ldev Map pane

This pane lists the following items:

- **ACP Pair:** Displays ACP pair number. If the parity group spans across two ACP pairs, the table displays both pairs. For example: 1,2.
- **CU:Ldev:** Control unit (CU) and name of the logical device (LDEV)
- **Parity Group:** Parity group to which the LDEV belongs
- **Disk Group:** Physical locations within the disk array that the RAID group occupies
- **Disk Type:** Physical disk type

- **Port:** Port associated with the LDEV
- **Save** button: Downloads the information from this pane to a text file

## Ports pane

The Ports pane shows port configuration details. The number of configured ports depends on the number of installed I/O boards. The first table lists all the CL1 ports and the second table lists all the CL2 ports. Ports that are not configured are listed with empty data fields and port speeds are not listed in this pane.

To access this pane, click **Status**, and then click **Ports**.

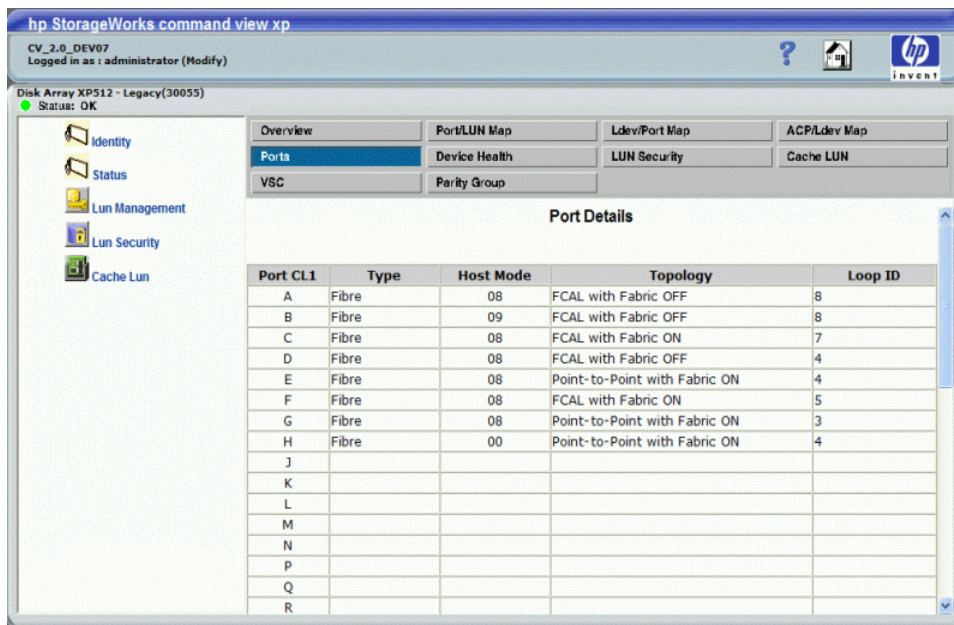

**Figure 54** Ports pane

This pane lists the following items:

- **Port:** Port name
- **Type:** The port type is determined by the I/O card associated with the port. Possible values are:
  - **Fibre:** Fibre Channel port
  - **SCSI:** Direct connected or bridge-connected SCSI port
- **Host Mode:** List of host groups set up for a port, with the corresponding host mode
- **Topology (Fibre Channel ports only):** For HP-UX systems only, the *FCAL with Fabric Off* configuration is supported. Possible values are:
  - **FCAL with Fabric ON:** Fibre Channel Arbitrated Loop with Fabric on
  - **FCAL with Fabric OFF:** Fibre Channel Arbitrated Loop with Fabric off
  - **Point-to-Point with Fabric ON:** Fibre Channel Point-to-Point with Fabric on
  - **Point-to-Point with Fabric OFF:** Fibre Channel Point-to-Point with Fabric off
- **Loop ID (AL-PA):** For Fibre Channel ports only, the FC-AL loop number and the loop physical address. Loop ID is a value from 0-125 corresponding to the last 8 bits of the node ID for the port.
- **Save** button: Downloads the information from this pane to a text file

# Device Health pane

The Device Health pane shows the state of major components in a selected disk array. There is a graphic representation of the disk array hardware and a list of health status conditions. You can quickly monitor the overall status of the disk array, with red or yellow indicating problems and green indicating normal operation.

Configuration and health information are dynamically updated as long as the Device Health pane remains active in the Command View session.

To access this pane, click **Status**, and then click **Device Health**.

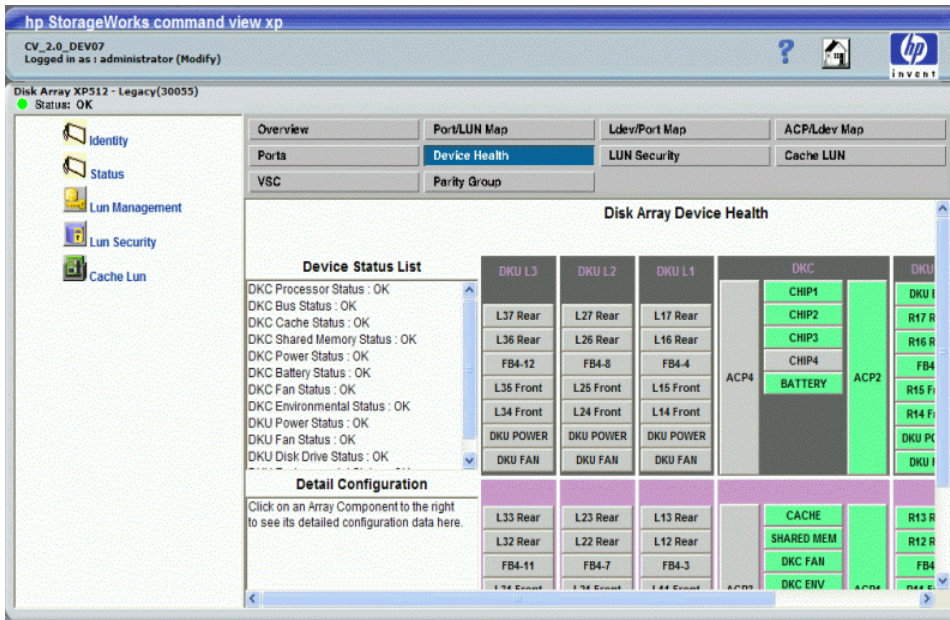

**Figure 55** Device Health pane

Clicking a component in this pane displays detailed information in the **Detail Configuration** box.

## Device status

**Table 14** Status conditions

Color	Status
Gray	This component is not present or active on this disk array.
Green	Normal operation status.
Yellow	A warning or minor problem condition was detected.
Red	A serious problem was detected.



Status health is reported in the Device Status list for the components listed in [Table 15](#).

**Table 15** Device Status List

Component	Details
DKC Processor	The DKC processors include both the ACP Processor pairs and Channel Host Interface Processor (CHIP)
DKC Bus	The bus components are either the set of FBUS-Low, FBUS-High, MBUS-Low, and MBUS-High; or the set of C-HSN and S-HSN
DKC Cache	Cache memory
DKC Shared Memory	Shared memory
DKC Power	AC power
DKC Battery	DC backup battery power
DKC Fan	Fans in the controller cabinet
DKC Environmental	The Environmental Monitor in the controller cabinet
DKU Power	AC power in one or more disk cabinets
DKU Fan	Fans in one or more disk cabinets
DKU Disk Drive	One or more disk drives in one or more hard disk unit (HDU) groups in one or more disk Unit cabinets
DKU Environmental	The Environmental Monitor in the R1 disk cabinet (to the right of the DKC)

---

## LUN Security pane

The LUN Security pane displays the security status of the Fibre Channel ports, and shows associated host groups and host WWNs.

To access this pane, click **Status**, and then click **LUN Security**.

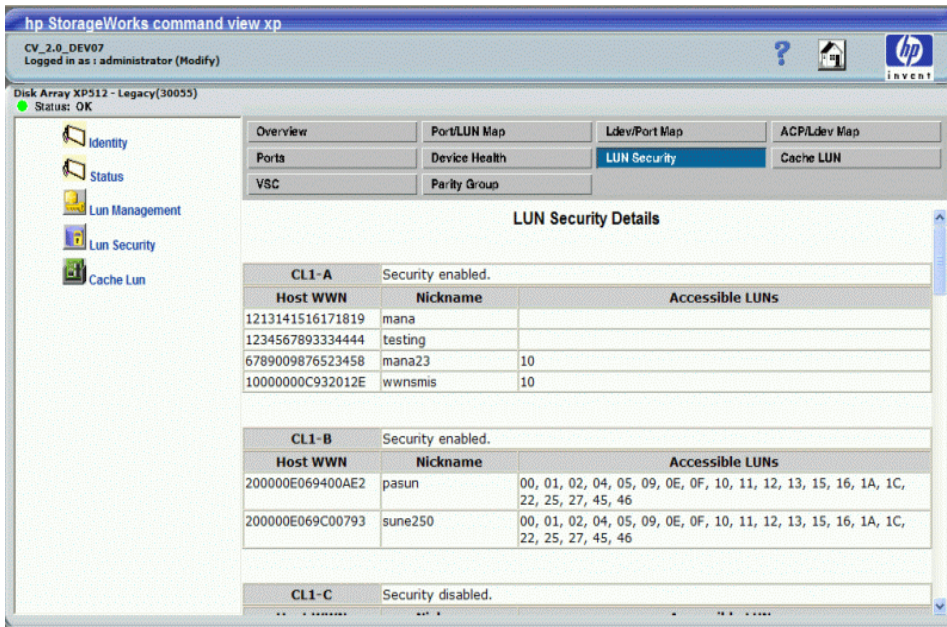

**Figure 56** LUN Security pane

This pane lists the following items:

- **Port Name:** Port name
- **Security Status:** Port security status (enabled or disabled)
- **Host WWN:** Registered host worldwide names (WWNs) in the host group
- **Nickname:** Nickname assigned to the host WWN (empty if no nickname is assigned)
- **Accessible LUNs:** The LUN IDs for LUNs accessible to the host group
- **Save** button: Downloads the information from this pane to a text file

---

## Cache LUN pane

The Cache LUN pane displays the LDEVs that have been set up in cache memory as cache LUNs.

To access this pane, click **Status**, and then click **Cache LUN**.

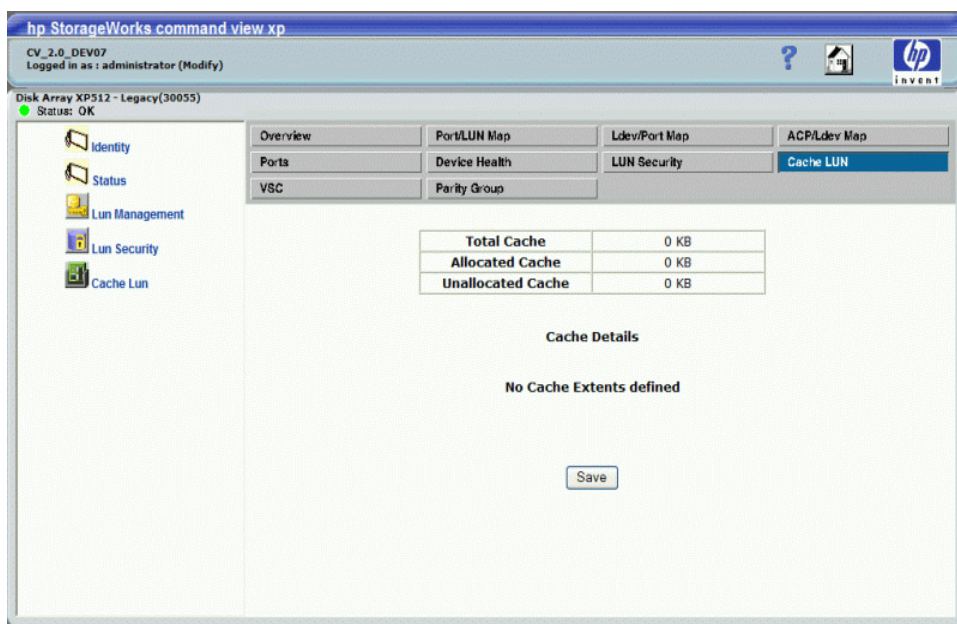

**Figure 57** Cache LUN pane

This pane lists the following items:

- **Total Cache:** Total amount of system cache allocated for use by Cache LUN, that may or may not be fully consumed by cache extents
- **Allocated Cache:** Amount of Cache LUN cache allocated to hold any cache extents
- **Unallocated Cache:** Amount of Cache LUN cache not currently allocated to any cache extents
- **CU:Ldev:** LDEV for which cache LUN extents have been set up
- **Mode:** Bind mode or Priority mode
- **Start LBA:** The start logical block address (LBA) for the cache extent
- **End LBA:** The end LBA for the cache extent
- **LBA Size:** Size in LBAs of the cache extent. An LBA is 48 KB
- **Save** button: Downloads the information from this pane to a text file

---

## VSC pane

The VSC pane displays VSC information for each parity group.

To access this pane, click **Status**, and then click **VSC**.

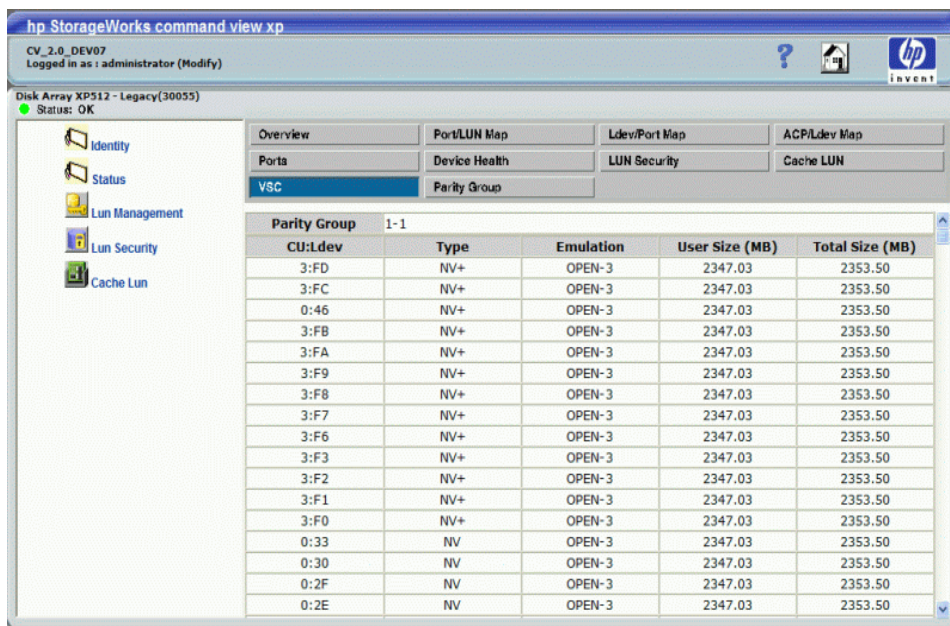

**Figure 58** VSC pane

This pane lists the following items:

- **Parity Group:** Parity group name
- **CU:Ldev:** Control unit (CU) and logical device (LDEV) associated with the parity group
- **Type:** If an attribute value shows a plus sign (+), the LDEV is part of a path or LU expansion. Other possible values are CV (custom volume), NV (normal volume) and free space.
- **Emulation:** Emulation type of the parity group
- **User Size:** Space on the LDEV available for storing user data
- **Total Size:** Total space on the LDEV
- **Save** button: Downloads the information from this pane to a text file

## Parity Group pane

The Parity Group pane displays details about disk array parity groups.

To access this pane, click **Status**, and then click **Parity Group**.

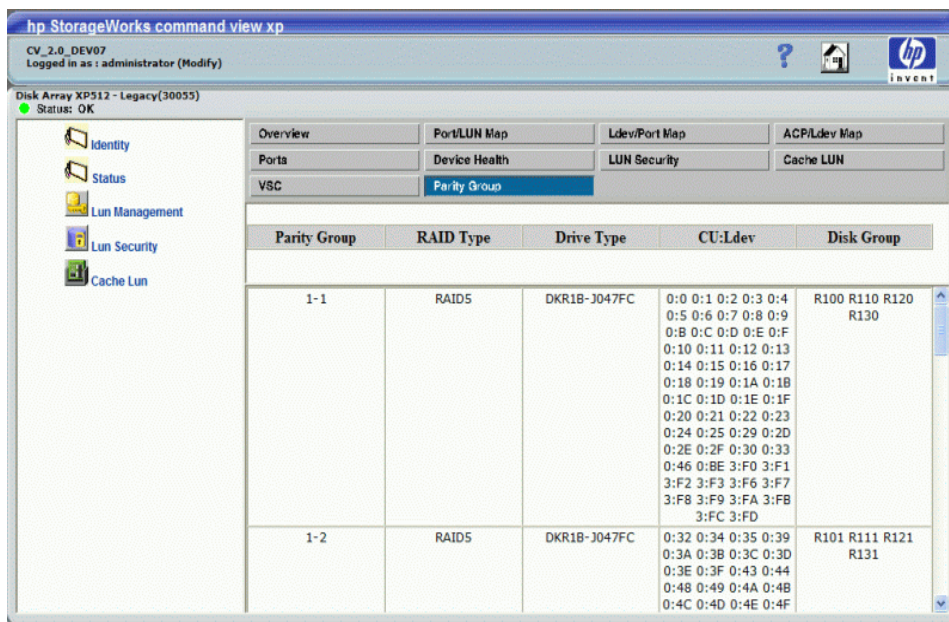

**Figure 59** Parity Group pane

This pane lists the following items:

- **Parity Group:** Parity group name
- **RAID Type:** Parity group's RAID configuration (2D+2D, 3D+1P, 4D+4D, 7D+1P)
- **Drive Type:** Type of physical drives making up the parity group
- **Cu:Ldev:** Control unit (CU) and logical devices (LDEVs) associated with the parity group
- **Disk Group:** Physical locations within the disk array that the parity group occupies
- **Save** button: Downloads the information from this pane to a text file





# 1.1 Status monitoring for the XP128/XP1024/XP12000

The Status pane provides a comprehensive overview of the configuration and condition of a selected disk array.

## Accessing the Status pane

The Status pane summarizes the hardware and storage configuration status for the selected disk array.

1. Click **Array Manager** in the main window.
2. In the Device Launcher pane, click an XP128/XP1024/XP12000 link for the array you want to view.
3. Click the **Status** tab.

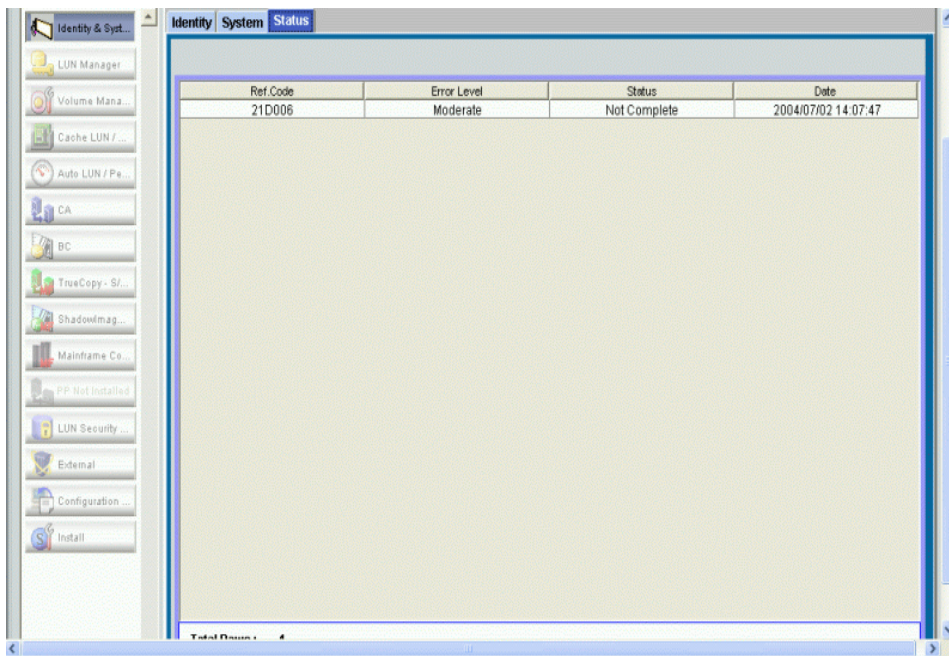

**Figure 60** Status pane

The Status pane provides information about the internal statuses of the connected subsystem. The XP128/XP1024/XP12000 generates a service information message (SIM) whenever it detects an error or service requirement.

This pane lists the following items:

- **Ref. Code:** The Service Information Message (SIM) Reference Code for identifying an error
- **Error Level:** The error levels: Good, Service, Moderate, Serious, and Acute (see [Table 16](#))
- **Status:** Complete (if the SIM has been deleted from the SVP) or Not Complete (if the error has not been deleted)

- **Date:** The date that the SIM occurred

**Table 16** Error levels

Error Level	Description
Good	No error
Service, Moderate	Immediate attention is not required. These errors are addressed during routine maintenance.
Serious, Acute	Contact your HP account support representative



**NOTE:** If the status changes from Good to another status, all SIMs must be completed (resolved) from the SVP to restore the status to Good.



**NOTE:** The icon displayed in the upper left corner of the Status pane indicates the error level of the controller (DKC) status or the disk array unit (DKU) status.

## Viewing status details

1. Select a row in the Status pane.
2. Right-click and select **Detail**.

Detailed information about the error appears in the **Detail** window (Figure 61).

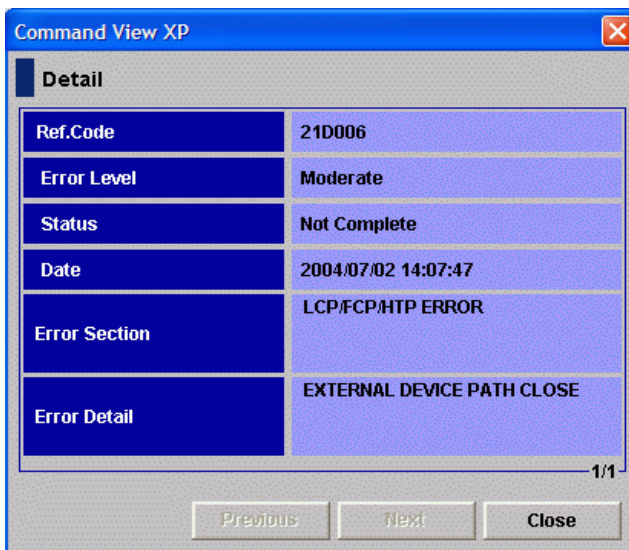

**Figure 61** Detail window

**Error Section** refers to the name of the component which is in error condition, and **Error Detail** provides a detailed description of the error.



# 12 System for the XP12000

The System pane is an array-dependent feature specific to the XP12000.

## Viewing the equipment information of the system

The System pane provides information about the equipment and port status of the connected subsystem.

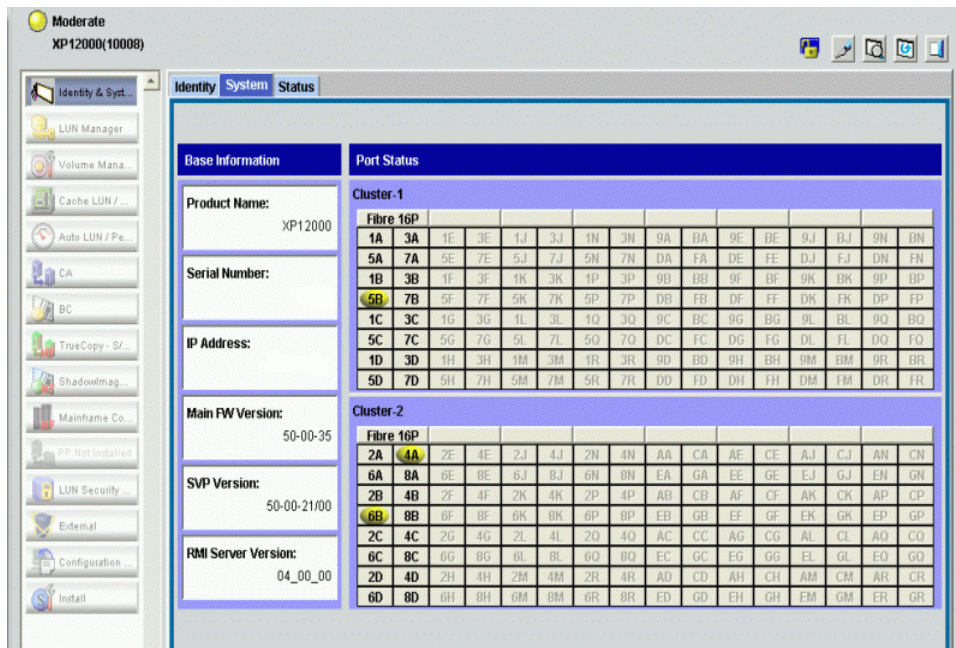

Figure 62 The System pane

## Base information

This **Base Information** section lists the following items:



- **Product name:** Name of the device of the connected subsystem
- **Serial Number:** Serial number of the connected subsystem
- **IP Address:** IP address of the connected subsystem (SVP)
- **Main FW Version:** Version of the microprogram installed on the connected subsystem
- **SVP Version:** Version of the Java applet program installed on the SVP of the connected subsystem
- **RMI Server Version:** Version of the RMI server installed on the SVP of the connected subsystem

## Port status

The **Port Status** section shows the port information using the image of the ports mounted on the subsystem.

Cluster 1 and Cluster 2 indicate the clusters. Each cluster has eight Printed Circuit Boards (PCBs), and the name of each PCB is displayed on the header of the port list. The icons show the port name, port status, and equipment information for the port.

**Table 17** Port icons

Icon	Status
	This port is equipped and the cable is set. This port is available for the operation.
	The port is equipped, but the cable is not set
	(Numbers are grey) This port is not equipped, or it is blocked

---

# 13 Disk/Cache Partition for the XP12000

The Disk/Cache Partition feature prevents performance degradation and data loss that occur when connecting multiple hosts and sharing disk arrays among multiple departments and multiple companies.

Disk/Cache Partition provides a mechanism to safeguard the disk array configuration by isolating operational areas. There is a possibility of changing or deleting a configuration created for a specific customer by mistake. The configuration should be protected from unrelated tasks, such as a path through which a host is connected and performing I/O, that could interrupt work in progress.

Use Disk/Cache Partition to partition a disk array into multiple virtual disk arrays. This helps protect data because virtual disk array's administrator cannot access the other virtual disk arrays for which the administrator is responsible.

---

## Disk/Cache Partition features

Disk/Cache Partition has two components:

- "Storage management logical partitions (SLPRs)" on page 143
- "Cache logical partitions (CLPRs)" on page 144

### Storage management logical partitions (SLPRs)

A disk array can be shared with the multiple organizations and with multiple departments within an enterprise. Therefore, multiple administrators might manage a single disk array. This circumstance creates the potential for an administrator to destroy volumes of other organizations, and it can complicate and increase the difficulty of managing the disk array.

Use Disk/Cache Partition to allocate all resources of one disk array (all ports and CLPRs) to virtual disk arrays called SLPRs. You can create up to 31 SLPRs in one disk array. Each virtual disk array can be accessed only by its administrator. This approach eliminates the risk of an administrator destroying volumes from other organizations and of data leaks among organizations.

In a non-partitioned environment, a full array is considered one single partition SLPRO. After the disk array is partitioned, SLPRO becomes the unpartitioned portion of the disk array. Similarly, CLPRO contains all

parity groups (PGs) and cache in the non-partitioned environment. After the disk array is partitioned, CLPRO contains the remaining PGs and cache that are not allocated to other CLPRs.

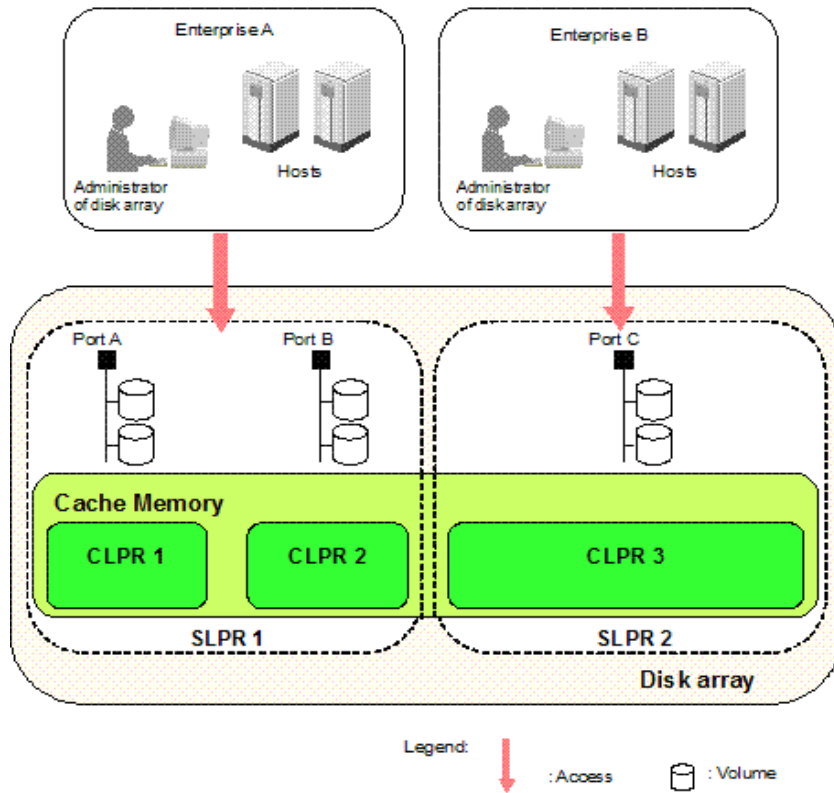

**Figure 63** Example of an SLPR

Figure 63 shows an example of one disk array partitioned into two virtual disk arrays. Each virtual disk array is allocated to one enterprise. Enterprise A's disk array administrator can manage enterprise A's virtual disk array, but cannot manage enterprise B's disk array. Similarly, enterprise B's disk array administrator can manage enterprise B's virtual disk array, but cannot manage enterprise A's disk array.

## Cache logical partitions (CLPRs)

When one disk array is shared with multiple hosts, and one host reads or writes a large amount of data, the host's read and write data occupies a large area in the disk array's cache memory. In this situation, the I/O performance of other hosts decreases because the hosts must wait to write to cache memory. To prevent this situation, CLPR partitions the disk array's cache memory. Partitioned cache memories are used as virtual cache memories, and each is allocated to each host. This approach minimizes the effects of one administrator's operations on the volumes of other administrators.

Virtual cache memory that is partitioned by the cache logical partition function is referred to as CLPR.

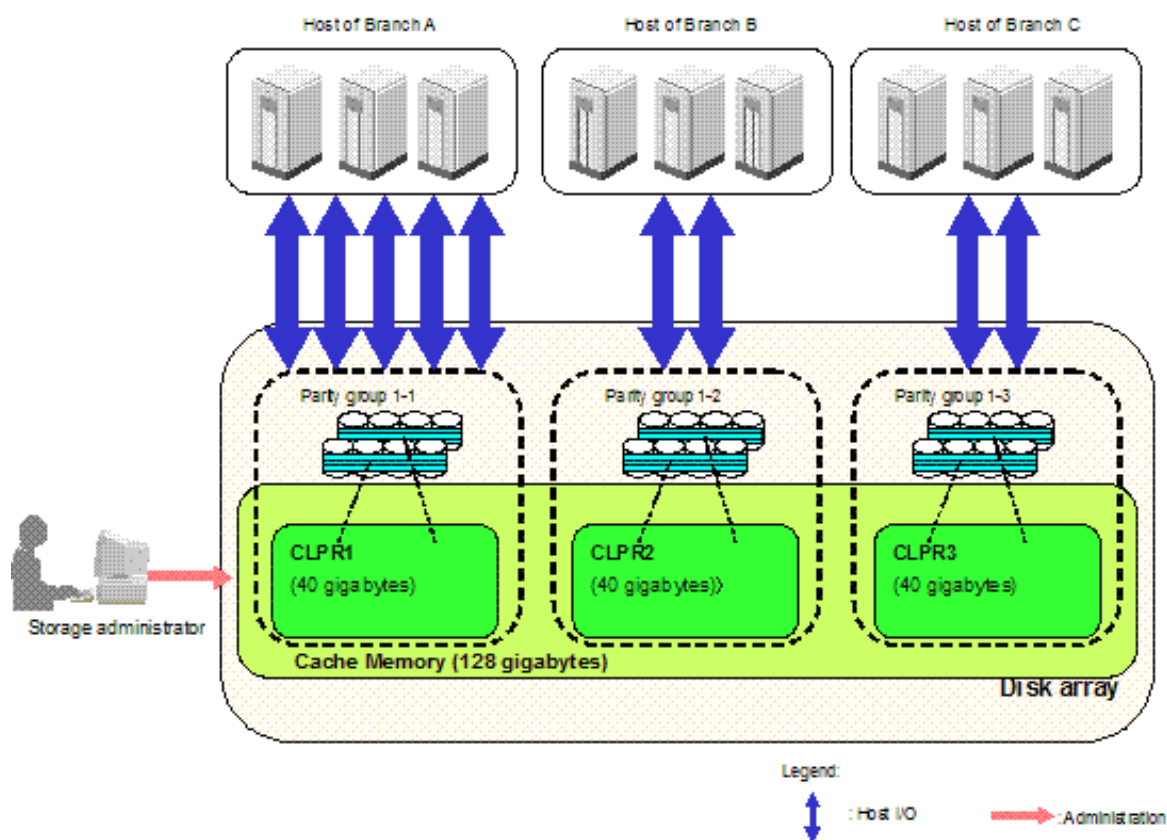

**Figure 64** Example of a CLPR

Figure 64 shows how a corporation's cache memory is partitioned to three virtual cache memories. Although the Branch A host is inputting and outputting a large amount of data, the Branch B and Branch C hosts are unaffected because each branch is allocated 40 GB CLPR.

## Partition administration and administrator rights

There are three groups of users who can access Disk/Cache Partition.

- Administrators who have modify access to the full array.
- StorageAdmins who have modify access. This group consists of users who have full array access and users who have partition-level access.
- Users who have read-only access. This group consists of users who have full array access and users who have partition-level access

**Table 18** Tasks and functions available to administration groups

Task/function	Groups for which task is available
Manage specified SLPRs	All
Manage entire disk array	Administrators and StorageAdmins with full array access Users with full array access

**Table 18** Tasks and functions available to administration groups (continued)

<b>Task/function</b>	<b>Groups for which task is available</b>
Display and operate SLPRs they do not administer	Administrators and StorageAdmins with full array access Users with full array access
Make settings on multiple SLPRs	Administrators and StorageAdmins with full array access
Information	All
System	Administrators and StorageAdmins with full array access Users with full array access
Status	Administrators and StorageAdmins with full array access Users with full array access
LUN Management	All
Port	All
NAS Boot Management	All
LUSE	All
Customized Volume	All
Cache residency	All
PCR	All
Auto LUN	All
Volume Migration	Administrators and StorageAdmins with full array access Users with full array access
SPM	Administrators and StorageAdmins with full array access Users with full array access
Continuous Access XP	Administrators and StorageAdmins with full array access Users with full array access
Continuous Access XP Journal	Administrators and StorageAdmins with full array access Users with full array access
Business Copy XP	Administrators and StorageAdmins with full array access Users with full array access
TrueCopy for z/OS	Administrators and StorageAdmins with full array access Users with full array access
Universal Replicator for z/OS	Administrators and StorageAdmins with full array access Users with full array access

**Table 18** Tasks and functions available to administration groups (continued)

Task/function	Groups for which task is available
ShadowImage for z/OS	Administrators and StorageAdmins with full array access Users with full array access
Compatible PAV	Administrators and StorageAdmins with full array access Users with full array access
Volume Security	Administrators and StorageAdmins with full array access Users with full array access
Volume Retention for z/OS	Administrators and StorageAdmins with full array access Users with full array access
XRC Replication	Administrators and StorageAdmins with full array access Users with full array access
Serverless backup	Administrators and StorageAdmins with full array access Users with full array access
Data retention	All
External Storage XP	Administrators and StorageAdmins with full array access Users with full array access
Flex Copy XP	Administrators and StorageAdmins with full array access Users with full array access
Configuration file loader	Administrators and StorageAdmins with full array access Users with full array access
License key	Administrators and StorageAdmins with full array access Users with full array access
SNMP information	Administrators
Just in Time	Administrators and StorageAdmins with full array access Users with full array access
Partition definition	Administrators
License key partition definition	Administrators

## Accessing Disk/Cache Partition

1. From the Device Launcher pane, click an XP12000 link.
2. Click the **Install** button (  ). The Install pane appears.



3. Click the **Partition Definition** tab.

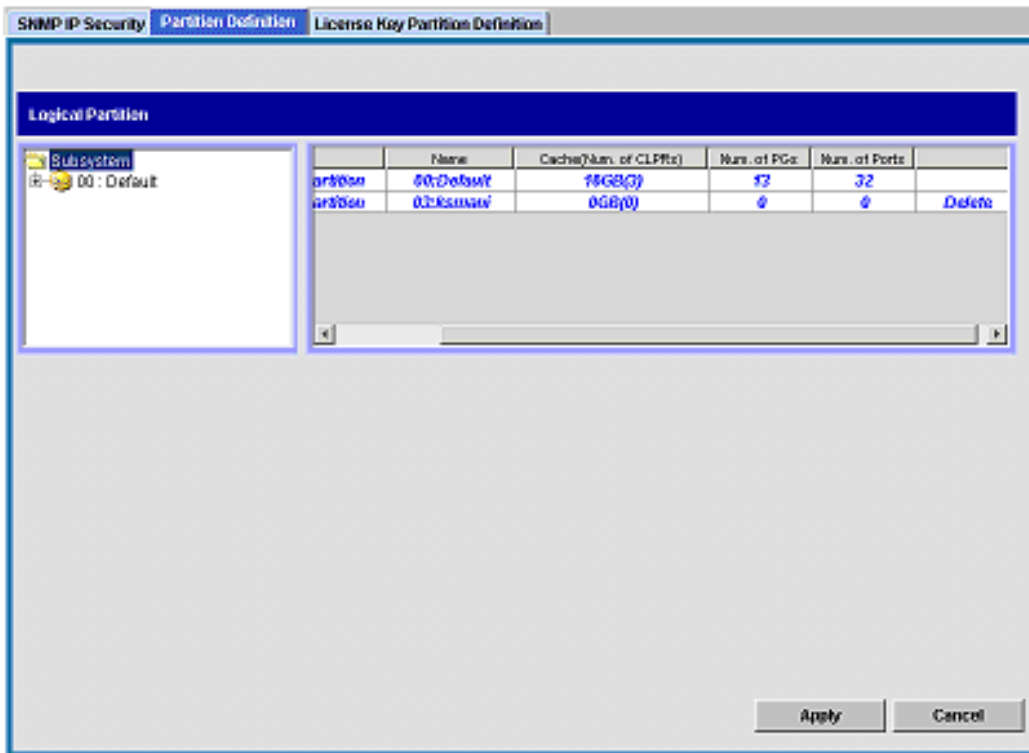
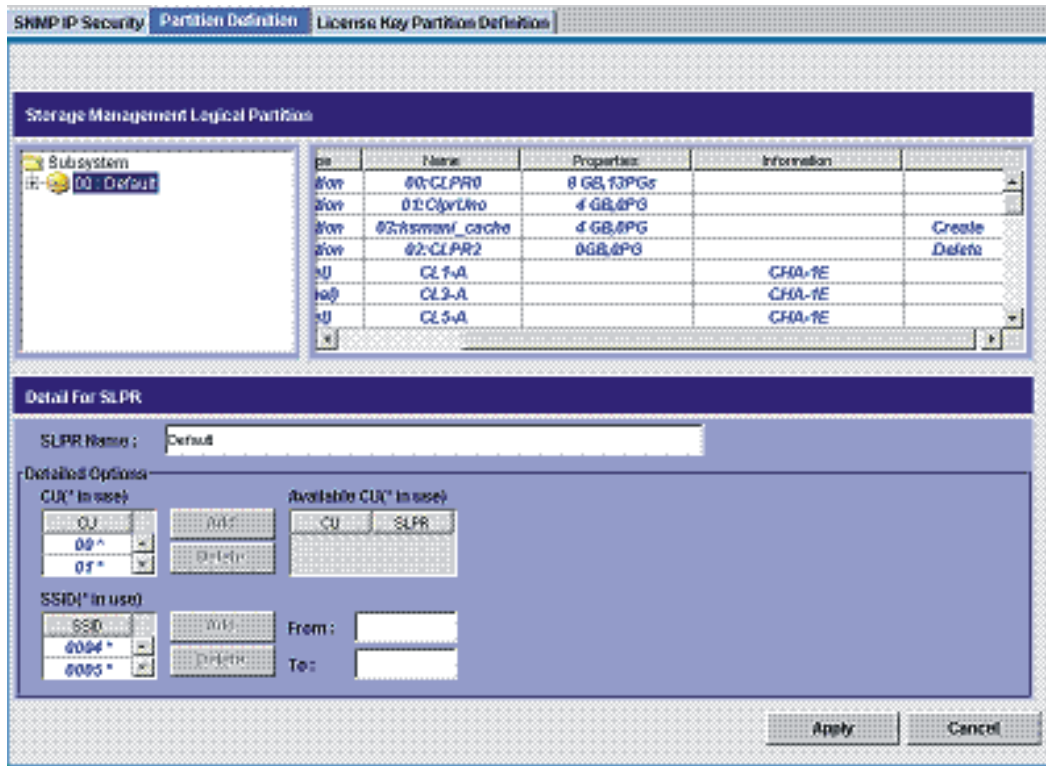

**Figure 65** Partition Definition pane

This pane contains the following:

- **Tree:** Displays SLPRs in the disk array. The SLPR number and name are displayed to the right of the SLPR icon.
- **Subsystem resource list:** Displays information about SLPRs.
  - **No.:** Line number.
  - **Item:** Type of resources.
  - **Name:** SLPR number and name.
  - **Cache (Num. of CLPRs):** Cache capacity and number of CLPRs in the SLPR.
  - **Num of PGs:** Number of parity groups in the CLPR of each SLPR.
  - **Num of Ports:** Number of ports in each SLPR.
  - **Status:** SLPR status. When you change an SLPR, a description of the change appears in this column. When you click **Apply** or **Cancel**, the description is removed.
- **Apply:** Applies settings.
- **Cancel:** Cancels settings that were entered or selected, and restores settings to initial values.

# Working with SLPRs



**Figure 66** Partition Definition pane (SLPR selected)

When an SLPR is selected on the Partition Definition pane, the pane displays the following:

- **Tree:** Displays SLPRs and CLPRs in the disk array.
- **SLPR resource list:** Displays information about the selected SLPR's resources (CLPRs and ports). If SLPRO is selected, all resources that have not yet been allocated to SLPRs are displayed.
  - **No.:** Line number.
  - **Resource Type:** Type of SLPR resources: **Cache Partition** or **Port**.
  - **Name:** CLPR or port name.
  - **Properties:** CLPR's capacity and number of parity groups allocated to the specified CLPR.
  - **Information:** Channel adapter name, if the resource type is **Port**. If the port is available with Just-in-Time, **Just in Time** is displayed on the right of the channel adapter name.
  - **Status:** SLPR status. When you change an SLPR, a description of the change appears in this column. When you click **Apply** or **Cancel**, the description is removed.
- **Detail for SLPR:** SLPR's settings. You can change the SLPR's settings.
  - **SLPR Name:** Up to 32 alphanumeric characters.
  - **CU(\* in use):** CU number in the specified SLPR (00 - 3F). An asterisk (\*) indicates the SSID is registered to the CU. To delete a CU from the specified SLPR and return it to the **Available CU** list, select the CU, and click **Delete**.
  - **Available CU(\* in use):** CUs that are not in the specified SLPR. To add a CU to the specified SLPR, select the CU, and click **Add**. An asterisk (\*) indicates the SSID is registered to the CU. Up to 64 CUs into which the SSIDs are registered or cannot be selected.



---

**NOTE:** If users in the StorageAdmins group who have partition-level access want to use the Customized Volume function, first specify the CU for each SLPR to prevent overlapping the newly allocated CU numbers and the existing CU numbers in other SLPRs. If CU numbers are not specified first, users in the StorageAdmins group who partition-level access cannot use the Customized volume function.

---

- **SSID (\* in use):** SSID in the selected SLPR (0004 to FFFE). An asterisk (\*) indicates the SSID is registered to the CU. SSIDs registered to the CU are displayed for SLPRO. If a customized volume (CV) is set using the Customized Volume function, and the CU number and SSID are registered to different SLPRs, a dash (-) is displayed to the right of the SSID. To delete an SSID from the **SSID(\* in use)** box, select the SSID, and click **Delete**.
  - **From:** Starting number of the SSID added to the specified SLPR (0004 to FFFE). You can enter an SSID that is in SLPRO.
  - **To:** Last number of the SSID added to the specified SLPR (0004 to FFFE). There can be up to 256 SSIDs in SLPRO. If you add multiple SSIDs to a specified SLPR, the **To** number must be smaller than the **From** number.
- 



**NOTE:** If users in the StorageAdmins group who have partition-level access use the Customized Volume function, first specify the SSID number for the SLPR to prevent overlapping newly allocated SSID numbers and existing SSID numbers in another SLPR.

---

- **Apply:** Applies settings.
  - **Cancel:** Cancels settings entered or selected, and restores settings to initial values.
- 

## Administering SLPRs

The following is the general procedure required for preparing and administering the disk array with SLPRs. Only Administrators can perform this procedure.

1. Create an SLPR (see "[Creating SLPRs](#)" on page 151).
  2. On the License Key Partition Definition pane, allocate licenses for software products to the SLPR (see "[Licenses](#)" on page 75).
- 



**NOTE:** If software product licenses have not been allocated to an SLPR, the user assigned to the SLPR cannot use the software products. For Performance Monitor, if the licensed capacity for the entire storage is sufficient, the Administrator can use Performance Monitor to monitor the entire storage, even if Performance Monitor's license has not been allocated to the SLPR.

---

3. For instructions on adding users, see "[Adding a user](#)" on page 63.
  4. To delete an SLPR, delete all users and set the license capacity to 0 GB, or click **Disable** for all software products assigned to the SLPR on the License Key Partition Definition pane. See "[Deleting SLPRs](#)" on page 151.
- 



**NOTE:** You can assign a user to an SLPR that has not yet been created. However, if the SLPR does not exist, an error occurs when the user launches Device Manager through Command View or logs in using a direct launch of Device Manager.

---

## Creating SLPRs

If you have not yet created an SLPR in the disk array, all of the disk array's resources are in SLPRO. To divide the resources, create a new SLPR. Only Administrators can create SLPRs.

1. Right-click **Subsystem**, and select **Create SLPR**.
2. Select an SLPR.
3. Change SLPR settings as needed.
4. Click **Apply**.
5. Allocate resources (CLPRs and ports) to an SLPR. To do so, create a CLPR in an SLPR (see "Creating CLPRs" on page 153) or migrate a port from another SLPR (see "Migrating SLPR resources" on page 151).



**NOTE:** To change an existing SLPR's settings, repeat [step 1](#) through [step 4](#).

## Deleting SLPRs



**NOTE:** You cannot delete SLPRO.

When you delete an SLPR, partitioned resources are automatically returned to SLPRO. Only Administrators can delete SLPRs.

1. Right-click the SLPR, and select **Delete SLPR**.
2. Click **Apply**.

## Migrating SLPR resources

You can migrate CLPRs and ports that are managed in an SLPR to another SLPR.

- Only Target ports can be migrated to another SLPR. Initiator ports, RCU Target ports, and External ports cannot be migrated.
- A NAS port belonging to the same channel adapter must belong to the same SLPR.

1. Select an SLPR from the tree. The SLPR resource list appears.
2. Select the CLPR or port you want to migrate, right-click, and select **Cut**. You can select multiple CLPRs or ports.



**NOTE:** To migrate NAS ports, select all ports in the same CHN (channel adapter for the NAS) and the CLPRs containing LUN0000 and LUN0001 that belong to the NAS-Sys host group, and migrate them at the same time.

3. Select the SLPR to which you want to migrate the CLPR or port, right-click, and select **Paste CLPRs, Ports**. If you migrated CLPRs, they are added to the tree and SLPR resource list. If you migrated ports, they are added only to the SLPR resource list.



**NOTE:** The LUN0000 and LUN0001 belonging to the NAS-Sys host group must belong to the same SLPR as the NAS port. LUNs from LUN0005 to LUN000A in the NAS system LU must belong to SLPRO.

- Click **Apply** to apply the settings.

## Displaying error messages

If settings contain a discrepancy, an error message appears when you click **Apply**. To display the error message again, right-click the SLPR, and select **Error Detail**.

## Working with CLPRs

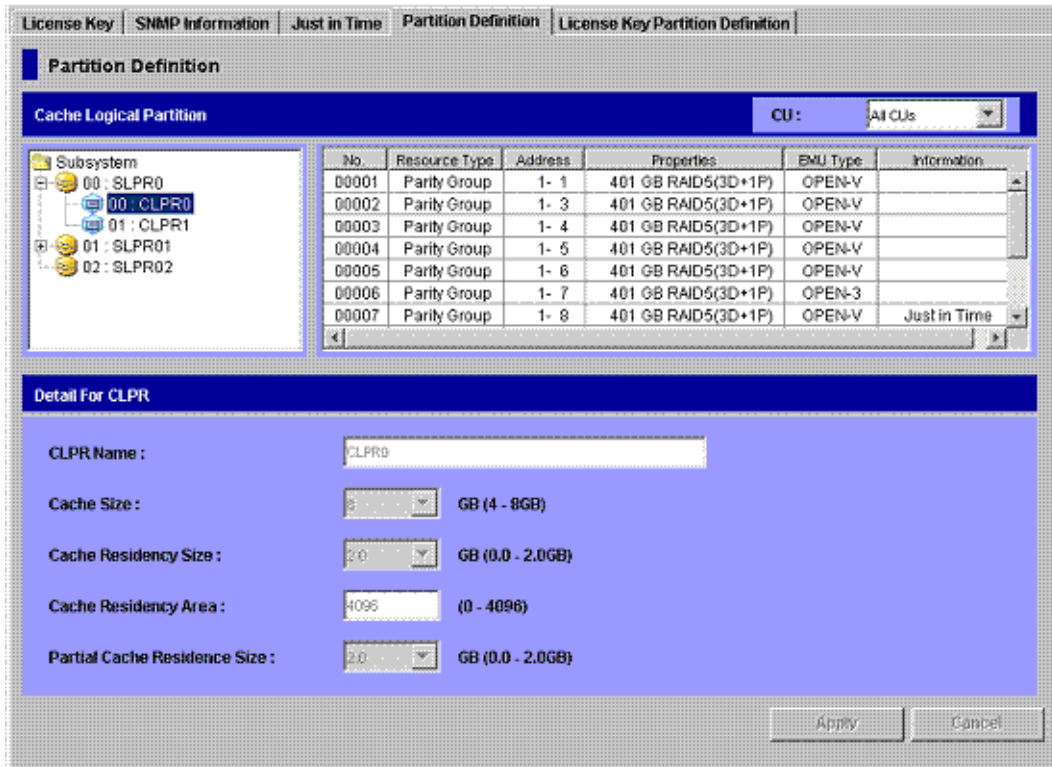

**Figure 67** Partition Definition pane (CLPR selected)

When a CLPR is selected, the pane displays the following:

- **CU:** Displays the selected CU's parity groups in the CLPR resource list.
- **Tree:** Lists the disk array's SLPRs and CLPRs.
- **CLPR resource list:** Displays information about the selected CLPR.
  - **No.:** Line numbers.
  - **Resource Type:** Type of CLPR resources: **Parity Group**, **DCR Cache**, or **PCR Cache**.
  - **Address:** Parity group's address.
  - **Properties:** Parity group's capacity and RAID configuration.
  - **EMU Type:** Parity group's emulation type.
  - **Information:** If an LU is available with Just-in-Time, **Just in Time** is displayed.
- **Detail for CLPR:** Selected CLPR's settings. You can change the CLPR's settings.
  - **CLPR Name:** Up to 16 alphanumeric characters.

- **Cache Size:** CLPR's cache capacity. Must be between 6 GB and 252 GB in 2 GB increments. The default is 4 GB.
- **Cache Residency Size:** Cache Residency cache's capacity. Must be between 0 and 252 GB in 0.5 GB increments. The default is 0 GB. If the total amount of the defined Cache Residency Size in the selected CLPR is larger than the amount of Cache Residency Size, an error occurs. If the total number of the defined Cache Residency Area in the selected CLPR is more than the number of Cache Residency Areas, an error occurs.
- **Cache Residency Area:**
- **Partial Cache Residence Size:** Partial Cache Residence (PCR) cache's capacity. Must be between 0 and 252 GB in 0.5 GB increments. The default is 0 GB. If the total amount of the defined Partial Cache Residence Size is more than the amount of Partial Cache Residence Size, an error occurs.



**NOTE:** You cannot change the capacity value of CLPRO directly. If you change another CLPR's capacity, the difference is reflected in CLPRO's capacity.



**NOTE:** The maximum available cache capacity (capacity of mounted cache minus total amount of usage for other CLPRs) is displayed for each upper limit of **Cache Size**, **Cache Residency Size**, and **Partial Cache Residence Size**.

The remaining capacity, which is calculated by subtracting **Cache Residency Size** and **Partial Cache Residence Size** from **Cache Size**, must be 4 GB or more in CLPRO.

- **Apply:** Applies settings.
- **Cancel:** Cancels settings that were entered or selected, and restores settings to initial values.

## Creating CLPRs

If you have not yet created a CLPR, the entire cache appears in CLPRO in the Partition Definition pane. To partition the cache, create a CLPR. The created CLPR can be allocated to each SLPR, and CLPRs can be created in a selected SLPR. Only the Administrators can create CLPRs.



**NOTE:** When you create a CLPR, the default cache size is 4 GB. To create a CLPR, the desired cache size is allocated from CLPRO (entire cache). The remaining cache size, which is calculated by subtracting **Cache Residency Size** and **Partial Cache Residence** size from the **Cache Size** of CLPRO, must be 8 GB or more.

1. Select an SLPR, right-click, and select **Create CLPR**. The CLPR is added to the tree.
2. Select a CLPR. Information about the selected CLPR is displayed in the **Detail For CLPR** section.
3. Change CLPR settings as needed.
4. Click **Apply** to apply the settings.
5. To allocate parity groups to a CLPR, migrate the parity groups from another CLPR (see "[Migrating parity groups across CLPRs](#)" on page 154).



**NOTE:** To change an existing CLPR's settings, repeat [step 3](#) through [step 4](#).

## Deleting CLPRs

When you delete a CLPR, the parity groups in the CLPR are automatically returned to CLPRO. You cannot delete CLPRO.

1. Right-click the CLPR, and select **Delete CLPR**.
2. Click **Apply** to apply the settings. A progress bar appears.

## Migrating parity groups across CLPRs

You can migrate parity groups in a CLPR to another CLPR.



**NOTE:** Multiple parity groups in a concatenated parity group must belong to the same CLPR.

1. Double-click the SLPR in the tree.
2. Select a CLPR from the tree. The selected CLPR's resource list appears.
3. Select the parity groups you want to migrate, right-click, and select **Cut**. You can select the multiple parity groups.
4. Select the CLPR to which you want to migrate the parity groups, right-click, and select **Paste Parity Group**. The selected parity groups are added to the CLPR's resource list.
5. Click **Apply** to apply the settings.

## Notes, restrictions, and requirements

This section provides additional information about using SLPRs and CLPRs.

### SLPRs

- Ports being assigned to an SLPR should not have existing host groups and LUNs assigned to them. Assign LUNs and define host groups after the partition is created.
- Assign LUNs for an SLPR from array groups that are assigned to control units (CUs) that have been assigned to that SLPR. The StorageAdmin user's ability to manage is if Assigning LUNs are assigned to ports in an SLPR when the ports are not in a CU assigned to the same SLPR.
- HP does not recommend making settings on multiple SLPRs in one single operations because it results in more complex and difficult SLPR administration.
- If an administrator forces the following functions for multiple SLPRs and contradictions occur as a result, the StorageAdmin user's ability to use the SLPR is affected:
  - Manual migration of Volume Migration
  - Business Copy XP Quick Restore
  - LU path settings
  - High-speed mode settings
  - Creating a LUSE volume
- Mainframe volumes must be allocated to SLPRO.
- Target ports must be allocated to SLPRs other than SLPRO; allocation cannot be done to SLPRO.



- Before a customized volume (CV) is created, the StorageAdmins user must allocate CU numbers to the SLPR. Allocated CU numbers are required only for defining the CU number to be allocated to the LDEV when the StorageAdmin user creates a CV.

## CLPRs

- When you create a partition, the license keys are disabled by default. Before you launch devicemanager for the partition, you must enable at least the basic license keys. Use the License Key Partition Definition tab on the Install pane to enable license keys. Basic license keys include Web Console and Java API.
- Adding or changing a CLPR definition can take several hours. To minimize the amount of time required when moving cache from one CLPR to another, create partitions when the array workload is light.
- The following operations are *not* recommended with CLPRs:
  - Creating a LUSE volume that extends over multiple CLPRs. If performed, volumes belonging to the CLPRs to which the LUSE is set cannot be used as a Continuous Copy XP or TrueCopy for z/OS pair volume.
  - Business Copy XP Quick Restore operation that affects multiple CLPRs.
  - Manual Migration of Volume Migration that affects multiple CLPRs.
- If Continuous Access XP Asynchronous or TrueCopy for z/OS Asynchronous operations are performed, and the volumes that are extended over multiple CLPRs are allocated to the same consistency group, a pair cannot be created.
- If Continuous Access XP Asynchronous or TrueCopy for z/OS Asynchronous operations are performed, only Continuous Access XP Asynchronous pairs or TrueCopy for z/OS Asynchronous pairs belonging to the same CLPR can be allocated to one consistency group. The parity groups allocated to the CLPR that these Continuous Access XP Asynchronous pairs or TrueCopy for z/OS Asynchronous pairs belong to cannot migrate to another CLPR.



# 14 LUN Management for the XP48/XP512

You can use the LUN Management panes to add and delete Fibre Channel (FC) LUN paths for the disk array. Each LUN can be mapped for access from multiple ports and multiple target IDs to provide alternate paths to promote continuous data availability.

Use LUN Management to reconfigure the Fibre Channel paths to accommodate system configuration changes (for example, adding a host) and optimize disk array performance.

Logical unit size expansion (LUSE) creates virtual logical units that are larger than standard LUNs. Volume Size Customization (VSC) creates virtual logical units that are smaller than standard LUNs.

## Starting LUN Management

1. In the Device Launcher pane, click **Modify** or **View** for an XP48 or XP512.
2. Click **LUN Management**.

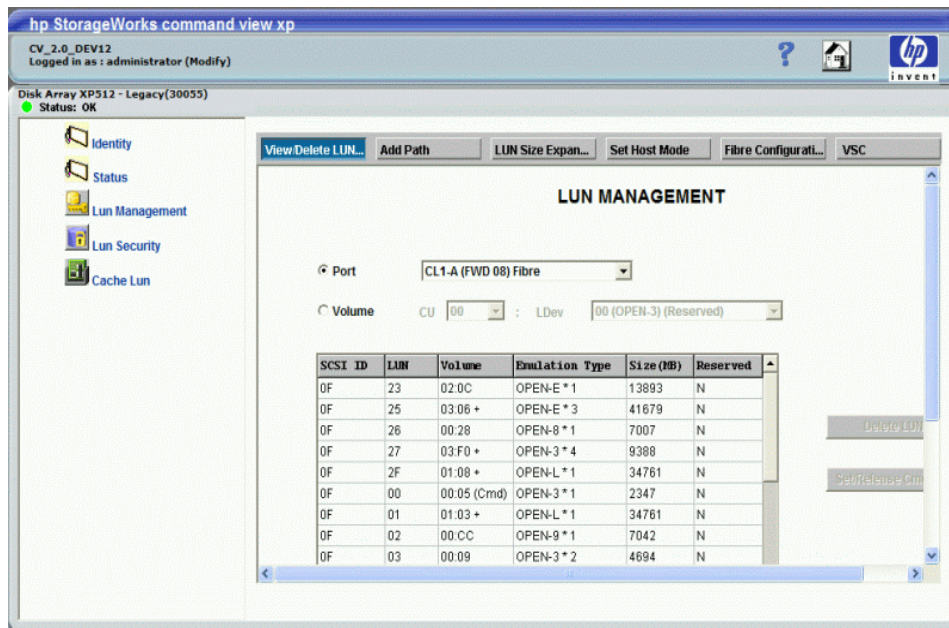

Figure 68 LUN Management pane

## View/Delete LUNs: Viewing FC path information

The FC path configuration for a selected port or volume is displayed in the LUN Management pane. The display shows the FC target ID, LUN number, volume (LDEV ID), emulation type, size, and an indication of whether the path is reserved.

## Accessing FC path information

After selecting a disk array, click **LUN Management**. The LUN Management pane appears. By default, the View/Delete LUNs pane is displayed.

## Viewing path information for a port

1. In the LUN Management pane, click **Port**. The **Port** list is activated.
2. Select a port in the **Port** list. The table displays path information for the selected port.

## Viewing path information for a volume

1. In the LUN Management pane, click **Volume**. The **CU** and **LDEV** lists are activated.
2. Select a CU in the **CU** list.
3. Select an LDEV in the **LDEV** list. The table displays the path information for the selected volume.

---

## View/Delete LUNs: Deleting FC paths

Use LUN Management to delete FC paths to LDEVs in a disk array. Each LDEV can have multiple paths to support high availability.

1. In the LUN Management pane, select the LDEVs that have the FC paths you want to delete. Press **Control** or **Shift** to select multiple items.
2. Click **Delete LUN**. The Delete Path Confirmation pane displays the path(s) you selected in [step 1](#).

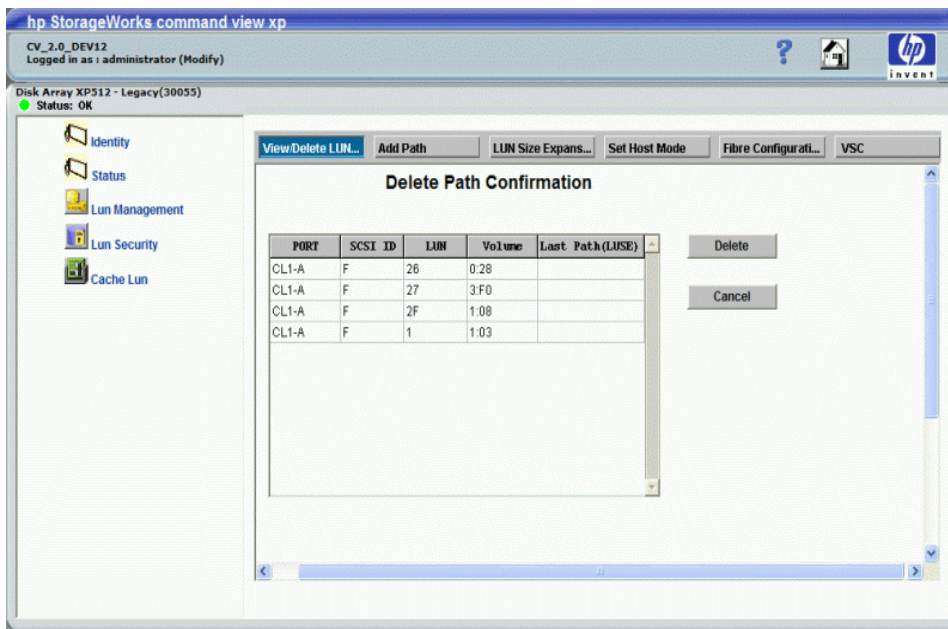

**Figure 69** Delete Path Confirmation pane (LUN Management pane)

3. Click **Delete**. A confirmation window appears.
4. Click **OK**. The selected paths are deleted.

---

## Add Path: FC paths

The Add Path function adds FC paths to LDEVs in the disk array.

Before assigning a path to an LDEV, ensure that the LDEV is not an Auto LUN reserved device. The Add Path pane does not list reserved volumes. You must use Auto LUN to verify the reserve status of LDEVs. If a volume is reserved, it is write-protected and any writes to that volume will fail.

To access this pane, click **LUN Management**, and then click **Add Path**.

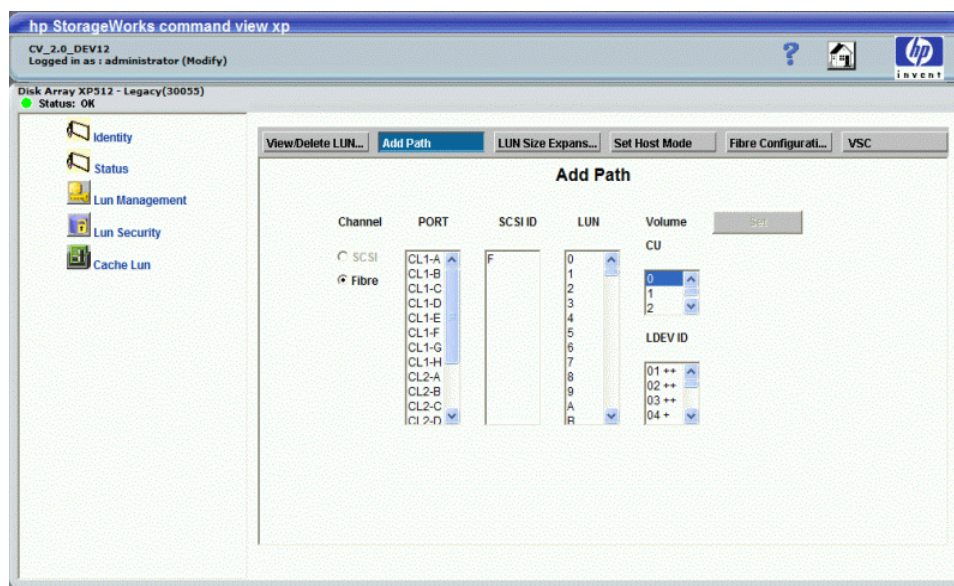

**Figure 70** Add Path pane

This pane lists the following items:

- **Channel:** Option buttons for selecting the type of path you are adding: **Fibre**.



**NOTE:** The **SCSI** option is disabled for XP 48/XP512 disk arrays.

- **PORT:** The assigned Fibre Channel ports.
- **SCSI ID:** Depending on the Channel selection, SCSI ID (F) for Fibre.
- **LUN:** Selecting **Fibre** displays LUN values from 0 through 119 (0 to 77 in hexadecimal).
- **CU:** All of the CU numbers available in the disk array. The first CU number is selected by default.
- **LDEV ID:** All of the LDEVs for the selected CU. A single plus sign (+) means one path is defined for that LDEV. Two plus signs (++) indicate that multiple paths are defined for that LDEV.
- **Set** button: Confirms and saves the selected path.

## Adding FC paths

1. In the LUN Management pane, click **Add Path**. The Add Path pane shows the currently assigned FC paths.
2. Select **Fibre** in the pane's Channel section.
3. Select the ports and LUN IDs you want to assign, and then select the corresponding CU and LDEV IDs.

To calculate the number of LDEVs to select, multiply the number of selected SCSI IDs by the number of selected LUN IDs. For example, if you select four SCSI IDs and two LUN IDs, you must select eight LUNs ( $4 \times 2 = 8$ ).

You can define paths in the following modes:

**Individual:** Select PORT, SCSI ID, and LUN one by one for each LDEV ID.

**Bulk:** Select the first LDEV ID. LUN Manager assigns the remaining paths sequentially. You can also select the number of LDEV IDs you want to assign. A bulk mode operation fails if the number of defined LUNs exceeds the number of available LDEVs.

**Random:** Select the LDEV IDs randomly and the items will be assigned in numerical order. For example, if you select LDEV IDs 07, 00, 0F, 01, and 0A, the LDEVs are assigned in the following order: 00, 01, 07, 0A, and 0F.

4. Click **Set**. The Add Path Confirmation pane lists the paths you are adding.
5. Click **Add**. A confirmation window appears.
6. Click **OK**. The selected paths are added.

## LUN Size Expansion (LUSE)

The LUN Size Expansion process creates virtual LDEVs that are larger than standard OPEN-3/8/9 LDEVs. This allows hosts to use fewer logical units to access the data on the disk array.

### LUN expansion functions

You can perform these LUN expansion functions:

- ["Viewing expanded LUN information: Detail pane"](#) on page 162
- ["Creating expanded LUNs \(continuous\)"](#) on page 163
- ["Creating expanded LUNs \(dispersed\)"](#) on page 164

### LUN size limitations

The following tables list LUN size limitations.

**Table 19** LUN size limitations for OPEN-3, OPEN-8, and OPEN-9

Parameter	OPEN-3	OPEN-8	OPEN-9
LUN size	2.4 GB	7.3 GB	7.3 GB
Possible number of LDEVs in expanded volume	2 to 36 LDEVs	2 to 36 LDEVs	2 to 36 LDEVs
Volume of expanded LUNs	4.8 GB to 86.4 GB	14.6 GB to 262.8 GB	14.6 GB to 262.8 GB
Display designation ( <i>n</i> = number of LUs in the expanded LUN)	OPEN-3* <i>n</i>	OPEN-8* <i>n</i>	OPEN-9* <i>n</i>

**Table 20** LUN size limitations for OPEN-3 VSC, OPEN-8 VSC, and OPEN-9 VSC

Parameter	OPEN-3 VSC	OPEN-8 VSC	OPEN-9 VSC
LUN size	35 MB to 2.3 GB	35 MB to 6.9 GB	35 MB to 7.0 GB
Possible number of LDEVs in expanded volume	2 to 36 LDEVs	2 to 36 LDEVs	2 to 36 LDEVs



**Table 20** LUN size limitations for OPEN-3 VSC, OPEN-8 VSC, and OPEN-9 VSC (continued)

Parameter	OPEN-3 VSC	OPEN-8 VSC	OPEN-9 VSC
Volume of expanded LUNs	70 MB to 84.2 GB	70 MB to 250.2 GB	70 MB to 252.6 GB
Display designation ( <i>n</i> = number of LUs in the expanded LUN)	OPEN-3* <i>n</i> VSC	OPEN-8* <i>n</i> VSC	OPEN-9* <i>n</i> VSC

Note the following limitations:

- You cannot join LDEVs on different control units into an expanded LUN.
- The LDEVs you join must be in sequential order.
- Some operating systems may experience slow disk access times with large logical units.

## Starting LUN size expansion

From the LUN Management pane, click **LUN Size Expansion**. The LUN Expansion Main pane displays the LUNs defined in the disk array.

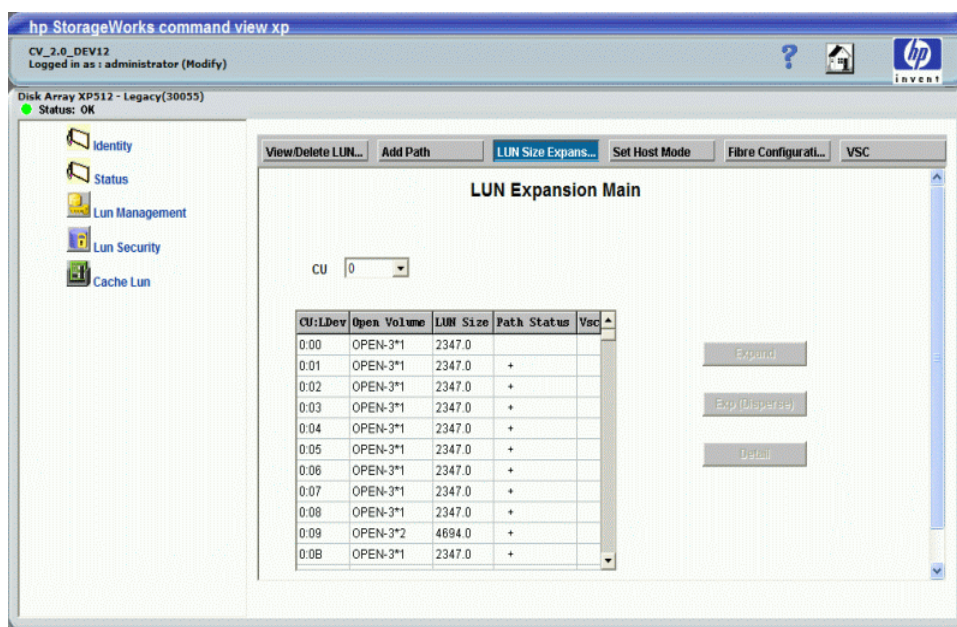

**Figure 71** LUN Expansion Main pane

## Details

This pane lists the following items:

- **CU:** Used to select a CU. The table lists the volumes corresponding to the selected CU.
- **CU:LDEV:** The LUNs in the selected CU.
- **Open Volume:** The emulation type of the LUN followed by the number of LDEVs that are part of any expanded LUN. If the LUN is not expanded, the number of LDEVs displayed is 1.
- **LUN Size:** The size of the LUN.
- **Path Status:** A plus sign (+) indicates that there is at least one defined path to the LUN.
- **VSC:** A plus sign (+) indicates that the LUN is a custom volume.



- **Expand** button: Click **Expand** to view the LUN Expansion Continuous pane. This button is enabled only when a LUN is selected for expansion. The selected LUN must have continuous LDEVs available for expansion and there should be no path defined for the LUN.
- **Exp (Disperse)** button: Click **Exp (Disperse)** to view the LUN Expansion Disperse pane. This button is available only when a LUN is selected for expansion. The selected LUN must not have continuous LDEVs available for expansion and there should be no path defined for the LUN.
- **Detail** button: Click **Detail** to display the LUN Expansion Detail pane, which displays the LDEVs that are part of the expanded LUN. This button is available when a LUN is selected.

## Viewing expanded LUN information: Detail pane

1. Click **LUN Size Expansion** in the LUN Management pane. The LUN Expansion Main pane appears.
2. In the **CU** list, select a CU.
3. In the table, select a LUN.
4. Click **Detail**. The LUN Expansion Detail pane appears.

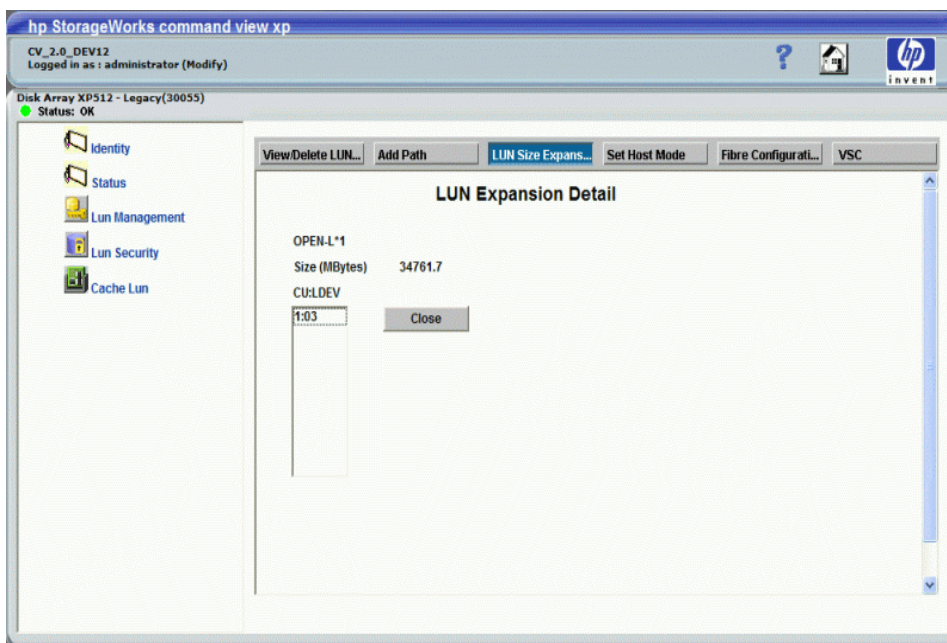

**Figure 72** LUN Expansion Detail pane

5. Click **Close** to return to the LUN Expansion Main pane.

# Creating expanded LUNs (continuous)

Use the LUN Expansion Continuous pane to create expanded LUNs (continuous mode).

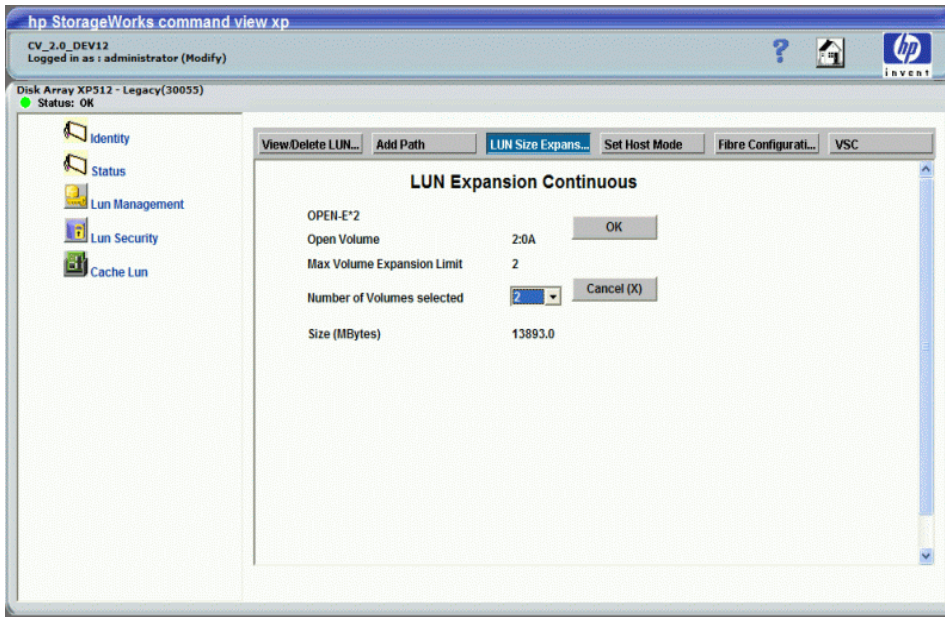

Figure 73 LUN Expansion Continuous pane

## Details

This pane lists the following items:

- **OPEN- $X*n$** : The emulation type. Available LUNs are displayed as OPEN- $X*1$ , indicating that only one LUN is present. Expanded volumes are displayed as OPEN- $X*n$ , where  $n$  is the number of LUNs present.
- **Open Volume**: The CU/LDEV that will be the first (top) LUN after expansion.
- **Max Volume Expansion Limit**: The number of available LUNs to combine.
- **Number of Volumes selected**: The number of volumes to combine.
- **Size (MBytes)**: The capacity of the expanded volume to be created.

## Procedure

1. Click **LUN Size Expansion** in the LUN Management pane. The LUN Expansion Main pane appears.
2. In the **CU** list, select the CU for the LDEVs you want to expand.

The table lists the LDEVs for the selected CU. A plus sign (+) in the **Path Status** column indicates that the path is already set. If a LUN has a path assigned, it cannot be expanded. Delete paths before expanding ("[View/Delete LUNs: Deleting FC paths](#)" on page 158).

3. In the table, select the LDEVs you want to expand.
4. Click **Expand**. The LUN Expansion Continuous pane appears.
5. In the **Number of Volumes selected** list, select the size of the expanded LUN.
6. Click **OK** to expand the LUN. The LUN Expansion Confirmation pane appears.
7. Click **Confirm**. The Add Path pane appears.

In the Add Path pane, you can associate a path with the expanded LUN. If you do not add a path for the expanded LUN, the expansion does not occur.

# Creating expanded LUNs (dispersed)

Use the LUN Expansion Disperse pane to create expanded LUNs (disperse mode).

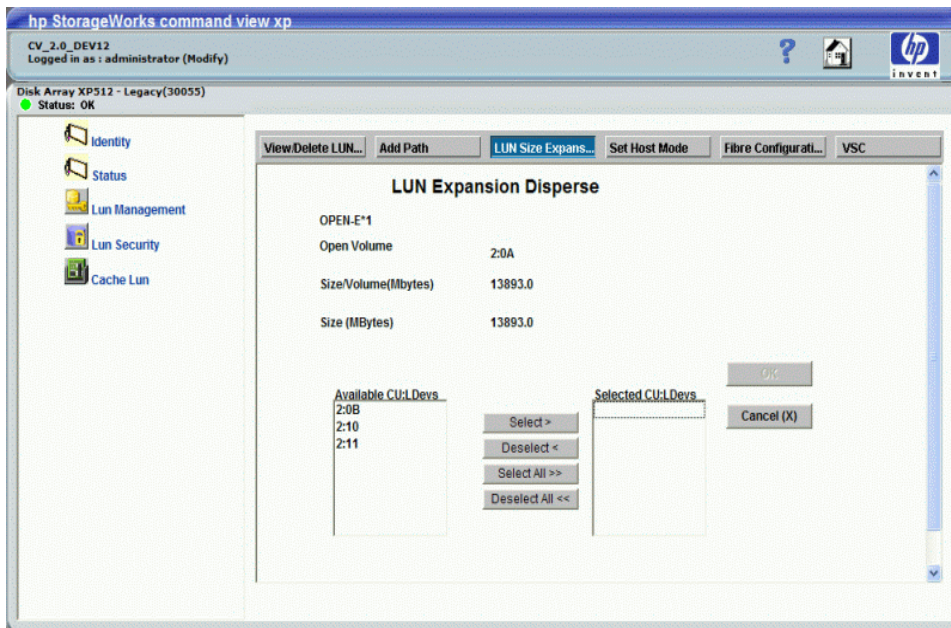

Figure 74 LUN Expansion Disperse pane

## Details

This pane lists the following items:

- **OPEN- $X*n$** : The emulation type. Available LUNs are displayed as OPEN- $X*1$ , indicating that only one LUN is present. Expanded volumes are displayed as OPEN- $X*n$ , where  $n$  is the number of LUNs present.
- **Open Volume**: The selected volume.
- **Size/Volume (Mbytes)**: The size per volume of the emulation type.
- **Size (MBytes)**: The size of the expanded LUN.
- **Available CU:LDEvs**: List of available volumes.
- **Selected CU:LDEvs**: List of the selected volumes.

## Procedure

1. Click **LUN Size Expansion** in the LUN Management pane. The LUN Expansion Main pane appears.
2. In the **CU** list, select the CU for the LDEVs you want to expand.

The table lists the LDEVs for the selected CU. A plus sign (+) in the Path Status column indicates that the path is already set. If a LUN has a path assigned, it cannot be expanded. Delete paths before expanding ("View/Delete LUNs: Deleting FC paths" on page 158).

3. In the list box, click the first LDEV in the series of LUNs you want to expand.
4. Click **Exp (Disperse)**. The LUN Expansion Disperse pane appears.
5. In the **Available CU:LDEvs** list, select a volume and click **Select**. To select all of the volumes, click **Select All**. The **Selected CU:LDEvs** list displays the selected volumes.
6. Click **OK** to expand the LUN. The LUN Expansion Confirmation pane appears.
7. Click **Confirm**. The Add Path pane appears.

8. Associate a path with the expanded LUN.

## Host modes

Use LUN Management to manage the host modes for Fibre Channel ports on the disk array. This feature can display and set the host mode. Host modes are specified by number.

**Table 21** Host modes

Host Mode	Fibre Channel Support
00	Standard
01	Reserved
02	Reserved
03	Reserved
04	Sequent
05	OPEN-VMS
06	Reserved
07	Tru64
08	HP-UX
09	Solaris
0A	NetWare
0B	Reserve
0C	PC Server
0D	IO Trace
0E	HP-UX
0F	AIX

## Viewing the host mode configuration

The View Host Mode Configuration pane displays the ports and their host modes in a scrollable list, sorted by host mode.



- From the LUN Management pane, click **Set Host Mode**. The View Host Mode Configuration pane appears.

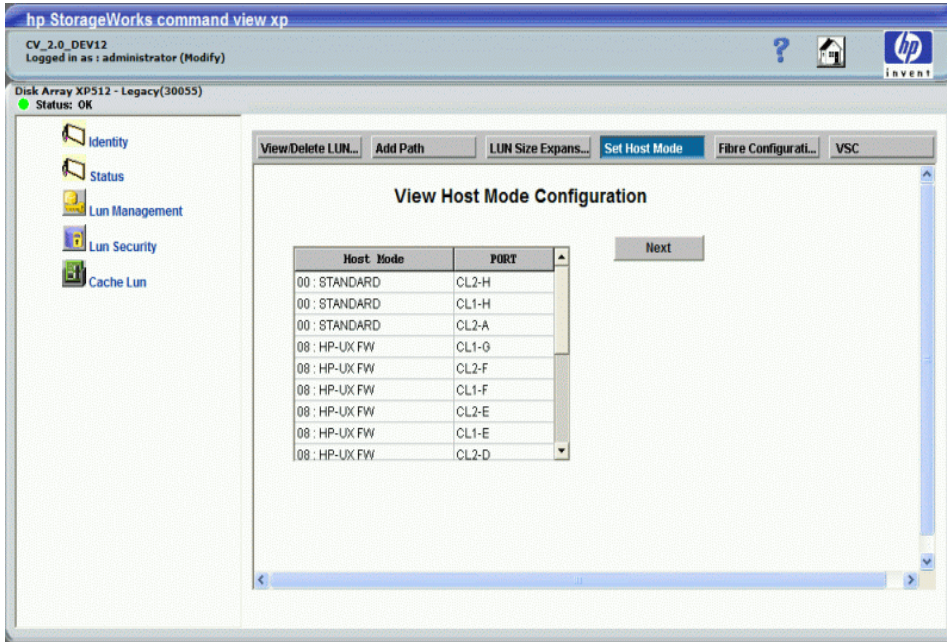

**Figure 75** View Host Mode Configuration pane

In addition to **Host Mode** and **PORT** columns, the View Host Mode Configuration pane has a **Next** button. Click **Next** to open the Host Mode Configuration pane.

## Setting or changing the host mode

Use the Host Mode Configuration pane to set or change host mode and port configurations.

- Click **Set Host Mode** in the LUN Management pane. The View Host Mode Configuration pane appears.
- Click **Next**. The Host Mode Configuration pane appears.

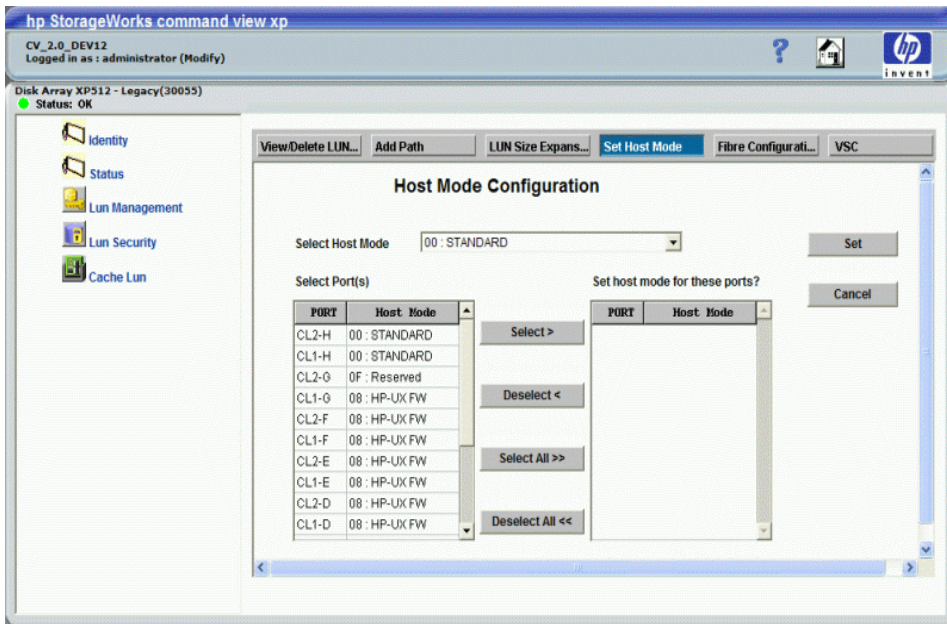

**Figure 76** Host Mode Configuration pane

3. Select a host mode in the **Select Host Mode** list. Each host mode is represented by its host mode number and a descriptive name.
4. In the **Select Port(s)** list, select the ports and click **Select**. To select all the ports, click **Select All**.  
All available ports with the selected host mode are listed in the **Select Port(s)** list. The **Set host mode for these ports?** list shows the selected ports for the selected host mode.  
If you want to reverse a selected host mode and port combination, select the combination in the **Set host mode for these ports?** list and click **Deselect**. To reverse all of the selected host mode and port combinations, click **Deselect All**.
5. Click **Set**. A confirmation window appears.
6. Click **OK**. The selected values are set and the data in the pane is updated.

## Configuring Fibre Channel ports

Fibre Channel configuration includes viewing and setting the port address and topology for Fibre Channel ports.

### Viewing the Fibre Channel port configuration

1. Click **Fibre Configuration** in the LUN Management pane. The View Fibre Port Configuration pane displays the port address or topology for Fibre Channel ports.

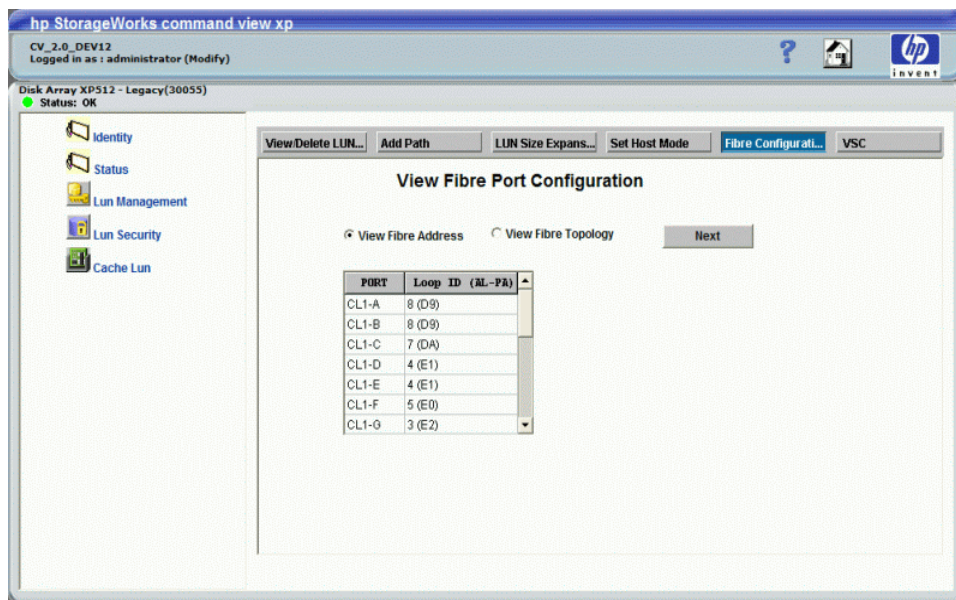

**Figure 77** View Fibre Port Configuration pane

2. To view the port names and their addresses (Loop ID [AL-PA]), click **View Fibre Address**.  
To view the port names and their topology information (Fabric and Connection), click **View Fibre Topology**. The possible values for Fabric and Connection are ON/OFF and FC-AL/Point-to-Point.
3. Click **Next** to set or modify the address and topology information for a Fibre Channel port.

### Setting or changing Fibre Channel port addresses

1. Click **Fibre Configuration** in the LUN Management pane. The View Fibre Port Configuration pane appears.

2. Click **Next**. The Set Fibre Port Configuration pane appears.

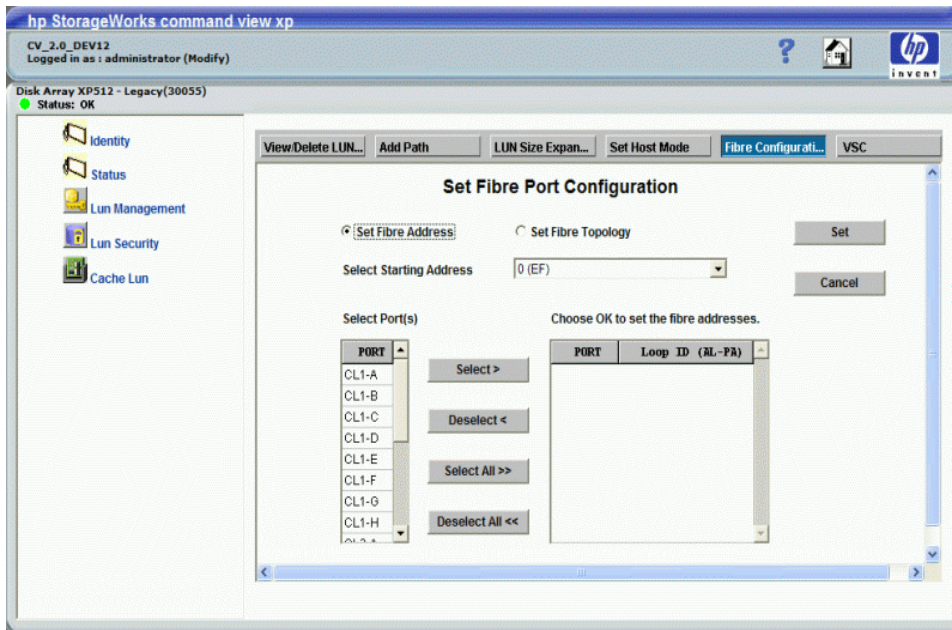

**Figure 78** Setting a Fibre Channel port address (Set Fibre Port Configuration pane)

3. Click **Set Fibre Address**, if it is not already selected.
4. In the **Select Starting Address** list, select the starting address (0 to 125).
5. In the **Select Port(s)** list, select the port. You can select multiple ports.
6. Click **Select**. To select all available ports, click **Select All**.

The **Choose OK to set the fibre addresses** list shows the selected ports. Addresses starting with the selected address in the **Select Starting Address** list will be assigned to the selected ports.

If you want to reverse the selection of Fibre Channel port addresses, select the ports in the **Choose OK to set the fibre addresses** list and click **Deselect**. To reverse the selection of all of the selected Fibre Channel port addresses, click **Deselect All**.

7. Click **Set**. A confirmation window appears.
8. Click **OK**. The new addresses are set and the data in the pane is updated.

## Setting or changing Fibre Channel port topology

1. Click **Fibre Configuration** in the LUN Management pane. The View Fibre Port Configuration pane appears.
2. Click **Next**. The Set Fibre Port Configuration pane appears.



### 3. Click **Set Fibre Topology**.

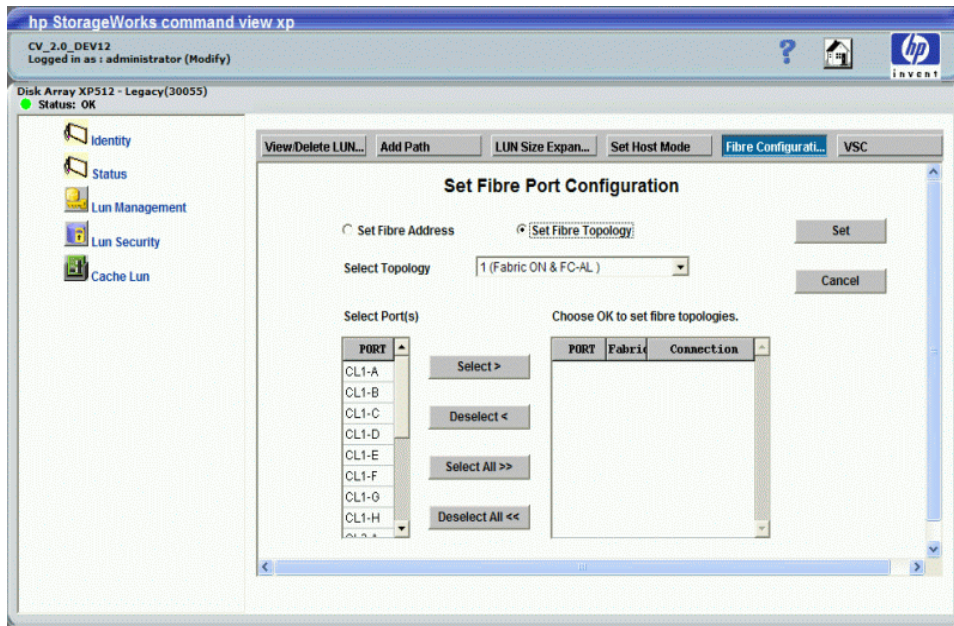

**Figure 79** Setting a Fibre Channel topology

4. Select a topology in the **Select Topology** list, You can select only one topology at a time.
5. In the **Select Port(s)** list, select the port. You can select multiple ports.
6. Click **Select**. To select all the available ports, click **Select All**.

The **Choose OK to set fibre topologies** list shows the selected ports. The topology selected in the **Select Topology** list is assigned to each selected port.

If you want to reverse the selected Fibre Channel port topologies, select the ports in the **Choose OK to set fibre topologies** list and click **Deselect**. To reverse all of the selected Fibre Channel port topologies, click **Deselect All**.

7. Click **Set**. A confirmation dialog box appears.
8. Click **OK**. The new addresses are set and the data in the pane is updated.

---

## Volume size configuration

The Volume Size Configuration (VSC) process configures custom volumes (CVs) that are smaller than normal volumes. Custom volumes improve data access performance by reducing logical device contention and host I/O queue times, which can occur when several frequently accessed files are located on the same volume.

If you have several frequently accessed files on the same LDEV, you can reduce conflicts and improve performance by using VSC to set up smaller “separate” custom volumes for them.

A small custom volume can also be useful for a command device. This leaves the rest of the LDEV free for other uses.

## VSC functions

VSC functions include:

- Volume to space (“[Converting volumes to space \(volume to space\)](#)” on page 172) formats one or more LDEVs on a selected VDEV into free space, which can be left as free space or used to install custom volumes (Install CV).

- Install CV (“Installing custom volumes” on page 173) creates custom volumes from free space.
- Deinstall CV (“Deinstalling custom volumes” on page 175) deletes selected custom volumes on a VSC volume.
- Volume initialize (“Converting a VSC volume to a normal volume (volume initialize)” on page 175) uninstalls all custom volumes under a VSC volume and reformats as the original normal volume. You must to assign new CU and LDEV numbers to each normal volume.

The first step in creating custom volumes is to convert a normal volume to a VSC volume. During this conversion, all of the logical blocks in the volume are reformatted for use in custom volumes. You can use the Install CV procedure to extend a VSC volume.

When you no longer require a VSC volume, use the Volume Initialize procedure to convert it to a normal volume.

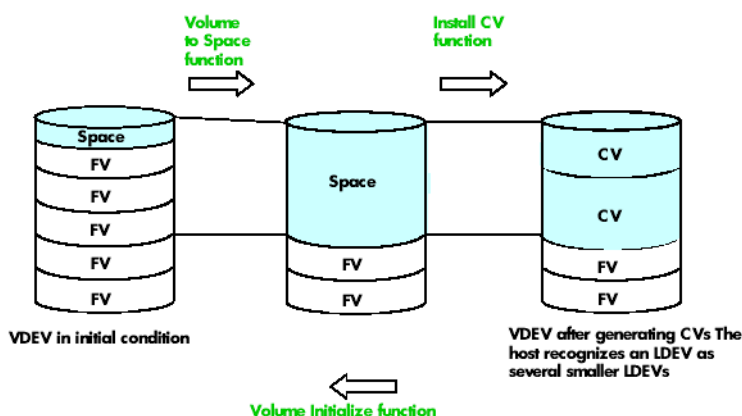

**Figure 80** VSC functions



**NOTE:** A fixed volume (FV) is the same as a standard LDEV.

## VSC limitations

- LUSE, LUN Security, and LDEV Security volumes are not available for VSC operations.
- When space is converted to a custom volume, an LDEV address is assigned to that custom volume automatically. For mainframes, each custom volume has an assigned unit control block (UCB). The UCB can be assigned automatically or manually.



**CAUTION:** The VSC function is destructive. Back up your data before performing VSC operations.

## VSC specifications

Table 22 lists the custom volume specifications. Each custom volume has an assigned unit control block (UCB), and multiple custom volume types can be configured within each parity group. Add and delete

custom volumes at any time. The administrator can control the emulation type associated with each custom volume.

**Table 22** VSC specifications

Parameter	Specification
Emulation type	OPEN-3/8/9/E/K
Minimum custom volume size	35 MB
Maximum custom volume size	OPEN-3: 2.4 GB OPEN-8: 7.3 GB OPEN-9: 7.3 GB OPEN-E: 13.5 GB OPEN-K: 1.75 GB
Size increment	1 MB
Maximum number of volumes (custom and normal) per parity group	124
Maximum number of volumes (custom and normal) per disk array	4096
Control (overhead) capacity required per custom volume	OPEN-3: 5.6 MB OPEN-8: 19 MB OPEN-9: 19 MB OPEN-E: 13.3 MB OPEN-K: 6.4 MB

Volumes are composed of 512-byte pieces called logical blocks. Logical block addresses (LBAs) are used for referencing locations within volumes. Use the following information when configuring custom volumes.

**Table 23** Volume types, logical blocks, and capacities

Volume type	Logical blocks	Capacity (GB)	User capacity (GB)
OPEN-3	4,806,720	2.461 GB	2.292 GB
OPEN-8	14,423,040	7.384 GB	6.877 GB
OPEN-9	14,423,040	7.384 GB	6.877 GB
OPEN-E	28,452,960	14.226 GB	13.567 GB
OPEN-K	3,661,920	1.83096 GB	1.746 GB

# Starting VSC

Click **VSC** in the LUN Management pane. The Volume Size Configuration (Main Screen) pane appears.

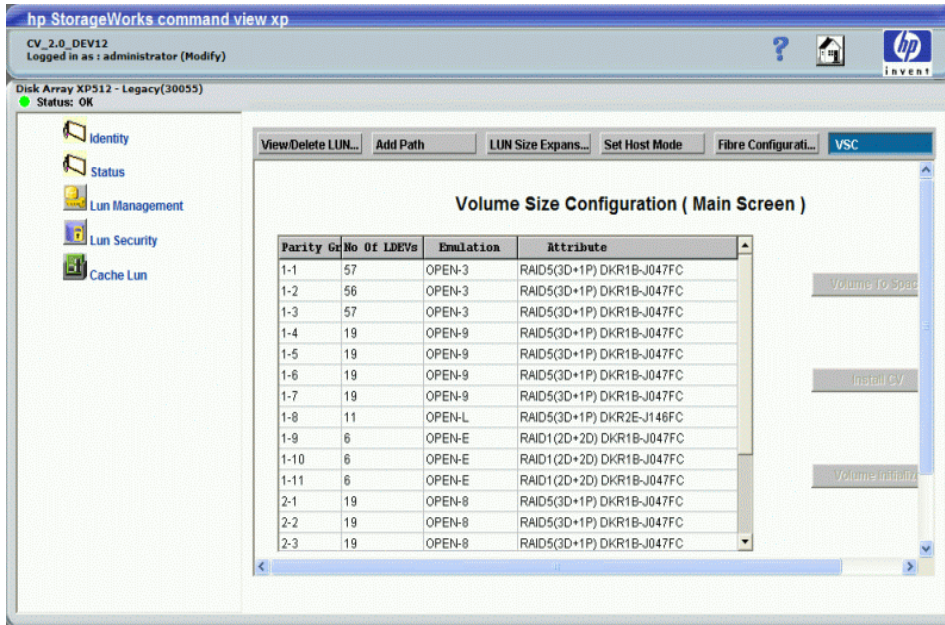

**Figure 81** Volume Size Configuration (Main Screen) pane

## Details

This pane lists the following items:

- The VSC table lists the parity group configuration of each CU, including the number of LDEVs, emulation type, RAID level, and HDD designation of each parity group.

If an attribute value is a plus sign (+), the LDEV is part of a LUSE expanded volume. If the attribute value is CV, then it is a custom volume.

- **Normal -> Volume To Space** button: Converts a normal volume to free space.
- **Install CV** button: Adds a new custom volume.
- **VSC -> Volume Initialize** button: Deletes all custom volumes and reformats as the original normal volume.

## Converting volumes to space (volume to space)

Before you can configure custom volumes, you must use the volume to space procedure to convert a normal volume to free space.



**CAUTION:** The volume to space conversion is destructive. The data on the volume will be lost when the operation is complete. Back up your data before performing this operation.

You cannot convert a volume that is part of a LUN expansion, Auto LUN reserved, or command device into free space.

## Details

Use the Volume Size Configuration (Normal To VSC) and (Volume To Space) panes to convert volumes to space. These panes list the following items:

- The VSC table has an entry for each LDEV selected in the Volume Size Configuration (Main Screen) pane. The LDEV ID, emulation, type, user size, and total size (the sum of user space and the control overhead) are displayed for each LDEV selected in the VSC Main Screen.
- **Customized Volume Size** box: Contains boxes to select an emulation type and set a volume size during add operations. This is disabled during Volume to Space operations.
- **Add** button: Adds a new volume configuration to the table. The **Add** button is enabled when new custom volumes are to be created.
- **Delete** button: Deletes a selected custom volume.
- **LDEV ID** button: Displays a pane for assigning the LDEV ID to new custom volumes.
- **Set** button: Commits the new volume configuration. The **Set** button and **Cancel** button are the only buttons enabled when the pane is displayed.
- **Cancel** button: Returns to the VSC Main Screen without making changes.
- **Free Space**: Displayed at the bottom of the pane is the free space available in the selected parity group.

## Procedure

1. Click **VSC** in the LUN Management pane. The Volume Size Configuration (Main Screen) pane appears.
2. Select a parity group.
3. Click **Volume To Space**. A confirmation dialog box appears.
4. Click **OK**. The Volume Size Configuration (Normal To Space)/(Volume To Space) pane appears.
5. Select the LDEV (normal or custom volumes) you want to convert to free space.
6. Select the volume from the list, and click **Delete**.
7. Repeat [step 5](#) through [step 6](#) for each volume selected in the VSC Volume To Space pane.
8. Click **Set**. A confirmation dialog box appears.
9. Click **OK**.



**NOTE:** Converting a normal volume or custom volumes to VSC free space can take several minutes because the disk array must format the volume. You can convert multiple volumes in a single operation.

---

## Installing custom volumes

1. Click **VSC** in the LUN Management pane. The Volume Size Configuration (Main Screen) pane appears.
2. Select a parity group.

- Click **Install CV**. The Volume Size Configuration (Install CV) pane appears.

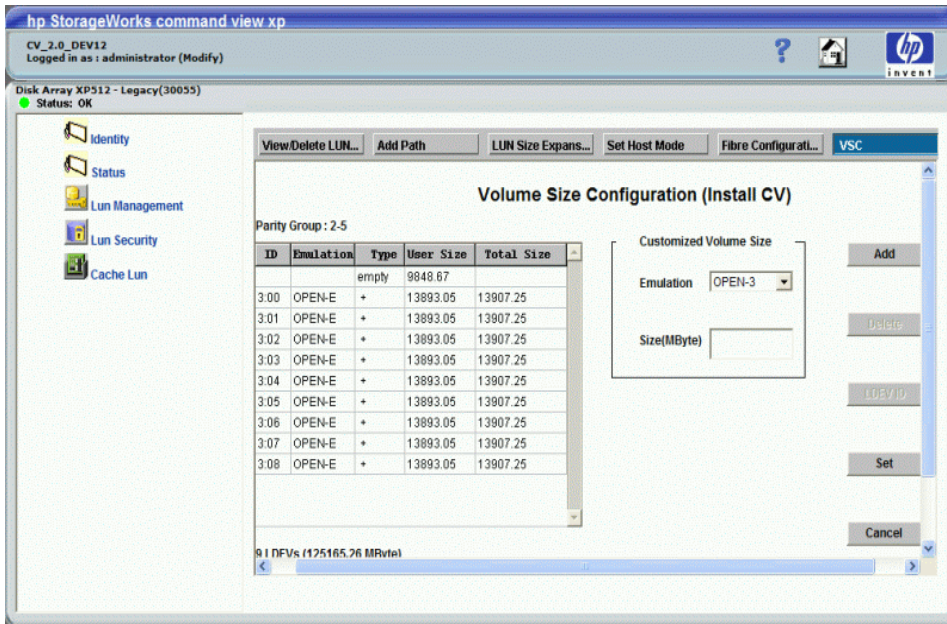

**Figure 82** Volume Size Configuration (Install CV) pane

- Select the VSC volume to configure.
- In the **Emulation** list, select the emulation type. The maximum size for a custom volume of the selected type appears below the **Emulation** list.
- In the **Size** box, enter the custom volume size and click **Add**.  
 If the free space is zero (0), the **Add** button is unavailable. If the size is valid, the created custom volume appears in the list. The free space on the volume is updated at the bottom of the pane.  
 If you make a mistake, select the custom volume, click **Delete**, and enter the correct information. You cannot delete a custom volume that was not created in the current session.  
 The **LDEV ID** button is available if the volume containing the new custom volume is selected in the list. You cannot complete the install until an LDEV ID is assigned to all new custom volumes.
- Repeat [step 4](#) – [step 6](#) for each selected volume.
- Assign the LDEV ID ("[Setting the LDEV ID](#)" on page 174) and subsystem ID (if required).
- Click **Set**. A confirmation window appears.
- Click **OK**.

## Setting the LDEV ID

You must assign an LDEV ID to newly created custom volumes, installed custom volumes, or any normal volume that has been converted from a VSC volume.

- Verify that the correct volume is selected.



Click **LDEV ID**. The LDEV ID Configuration pane lists new custom volumes or reconverted normal volumes. The LDEV ID list shows the available LDEV IDs.

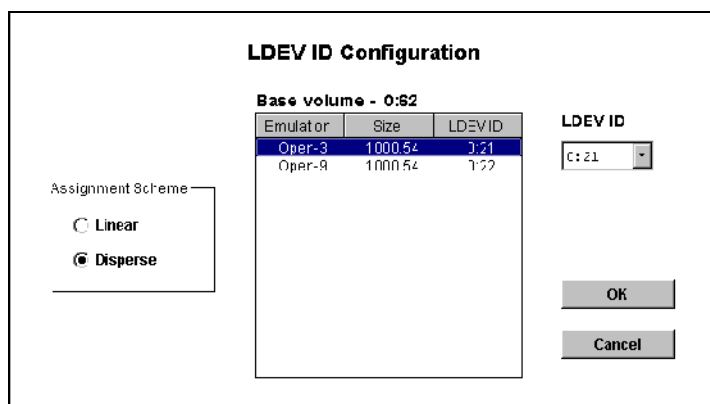

**Figure 83** LDEV ID Configuration pane

2. Select the volume.
3. In the **Assignment Scheme** box, select one of the following:
  - Linear.** Assigns the LDEV IDs in sequential order for all unassigned logical addresses within the parity group. The **Linear** option is appropriate for users who actively balance their disk array workloads.
  - Disperse.** Randomly rotates the LDEV IDs among multiple groups across the disk array, eliminating hot spots and improving data access. The **Disperse** option is appropriate for users who do not actively balance their disk array workloads.
4. Click **OK** to confirm your selections and return to the Volume Configuration pane.

## Deinstalling custom volumes

The Deinstall CV procedure uninstalls one or more custom volumes. The process deletes selected custom volumes on a VSC volume.

 **CAUTION:** The Deinstall CV process is destructive. The data on the custom volumes being uninstalled will be lost when the operation is complete.

1. Click **VSC** in the LUN Management pane. The Volume Size Configuration (Main Screen) pane appears.
2. Select one or more base volumes (CVs).
3. Click **Volume To Space**. A confirmation window appears.
4. Click **OK**. The Volume Size Configuration (Volume To Space) pane appears.
5. Select one or more custom volumes that do not contain a plus sign (+) in the **Type** column and click **Delete**.
6. Click **Set**. A confirmation window appears.
7. Click **OK** to confirm and return to the Volume Size Configuration (main Screen) pane.

## Converting a VSC volume to a normal volume (volume initialize)

The VSC to Normal process converts a VSC volume back to a normal volume. This operation uninstalls all custom volumes under a VSC volume and reformats the VSC volume as a normal volume.



If the VSC volume was originally formatted as a VSC volume by your HP representative (using the SVP), you cannot use Command View to convert it back to normal. If the volume was converted to a VSC volume with Command View, you can use the remote console to convert it back to normal.

 **CAUTION:** Converting a VSC volume to a normal volume is a destructive operation. The data on the custom volume being converted will be lost when the operation is complete.

1. Click **VSC** in the LUN Management pane. The Volume Size Configuration (Main Screen) pane appears.
2. Select a parity group that can be initialized.
3. Click **VSC -> Volume Initialize**. The Volume Size Configuration (VSC to Normal)/(Volume Initialize) pane appears.
4. Select a custom volume and click **Delete**.

When deleting the last custom volume, the **Delete** button is unavailable.

By default the LDEV ID of the custom volume being converted is assigned to the normal volume. You can change the LDEV ID as described on "[Setting the LDEV ID](#)" on page 174.

5. Click **Set** to convert the VSC volume to a normal volume.

## Operational restrictions

The success of some LUN Management activities depends on the status of the security switch and whether I/O is active or inactive to the port or LUN. The following tables describe those restrictions.

**Table 24** LUN Management operation restrictions

Activity		Security Switch OFF	Security Switch ON
Security SW OFF=>ON	With active I/O on port	Permitted	Invalid operation
	With no active I/O on port		
Security SW ON=>OFF	With active I/O on port	Invalid operation	Permitted
	With no active I/O on port		
Adding WWN Group	With active I/O on port	Invalid operation	Permitted
	With no active I/O on port		
Adding LUN Groups	With active I/O on port	Invalid operation	Permitted
	With no active I/O on port		
Adding WWN	With active I/O on port	Invalid operation	Permitted
	With no active I/O on port		
Adding LUN	With active I/O on port	Permitted (XP48/XP512)	Permitted
	With no active I/O on port	Permitted	

**Table 24** LUN Management operation restrictions (continued)

Activity		Security Switch OFF	Security Switch ON
Deleting WWN Groups	With active I/O on port	Invalid operation	Permitted
	With no active I/O on port		
Deleting LUN Groups	With active I/O on port	Invalid operation	Permitted
	With no active I/O on port		
Deleting WWNs	With active I/O on port	Invalid operation	Permitted
	With no active I/O on port		
Deleting LUN, including VSC, LUSE, and command devices	With active I/O on LUN	Not permitted	
	With no active I/O on LUN	Permitted	

**Table 25** VSC and LUSE operation restrictions

Activity		
VSC Volume to Space	With active I/O on LUN	Not permitted
	With no active I/O on LUN	Permitted
VSC Volume Initialize	With active I/O on LUN	Not permitted
	With no active I/O on LUN	Permitted
Deleting a LUSE volume	With active I/O on	Not permitted
	With no active I/O on	Permitted

**Table 26** Port operation restrictions

Activity	
Changing Topology	Operation is possible when I/O does not exist on the port. When I/O exists on the port, SNMP agent returns an error code.  The XP48/XP512 checks the I/O of all LUNs under the port.
Changing Fibre Address	
Changing PCB mode	
Changing Host mode	



---

# 15 LUN Management for the XP128/XP1024/XP12000

You can connect XP arrays to open system and mainframe hosts using Fibre Channel for an XP12000 and iSCSI (Internet Small Computer System Interface), Fibre Channel, and Network Attached Storage (NAS) for an XP128 or XP1024. Use LUN Management to configure host groups, logical units (LUs), and Fibre Channel and NAS ports. You can also configure NAS cache settings.

---

## LU configuration overview

One of the important tasks in logical unit (LU) configuration is to define I/O paths from hosts to LUs. After the paths are defined, the hosts can send commands and data to the LUs and can receive data from them.

LUN Management can also configure security policies to protect LUs from unauthorized access.

## Fibre Channel environment

In a Fibre Channel environment, you must configure the Fibre Channel ports on the disk array. With LUN Management, you can set addresses and speed, and specify topology for Fibre Channel ports.

## iSCSI environment

In an iSCSI environment (XP128/XP1024 only), the XP disk array provides mutual user authentication between hosts and ports by using Challenge Handshake Authentication Protocol (CHAP).

## NAS environment

There are two types of LUs in a NAS environment:

- system LUs
- user LUs

When configuring a NAS system, you must define paths between hosts and user LUs. You cannot define paths to system LUs, and you cannot define any LU paths to external volumes.

---

## Supported emulation types

LUN Management supports the following device emulation types:

- OPEN-3, OPEN-9, OPEN-8 (XP128/XP1024 only), OPEN-E, OPEN-L, and OPEN-V for open systems
  - 3390-3A/B/C and 3380-KA/B/C for mainframe systems
- 

## LU paths

After hosts and the disk array are physically connected by cables, switches, etc., use LUN Management to establish paths between the hosts and LUs. These paths are called LU paths and they determine which host can access which LU.

- Up to 256 LU paths can be defined for a host group in a Fibre Channel or iSCSI environment

- Up to 512 LU paths can be defined for a Fibre Channel port for the XP128/XP1024 arrays
- Up to 1,024 LU paths can be defined for a Fibre Channel port for the XP12000 array
- Up to 256 LU paths can be defined for a NAS port
- Up to 128 host groups can be defined for a Fibre Channel port for the XP128/XP1024 arrays
- Up to 256 host groups can be defined for a Fibre Channel port for the XP12000 array
- In an iSCSI environment, you can define:
  - up to 16 initiators per port
  - up to 16 host groups per port
  - up to 16 initiators per host group



**NOTE:** In an iSCSI environment, the number of initiators per host group multiplied by the number of host groups must be less than or equal to 16.

- Up to 65,536 host groups can be defined for one disk array (256 x 256)
- Up to 255 hosts can be included in all the host groups for one Fibre Channel port
- Up to 16 hosts can be included in all the host groups for one iSCSI port

---

## Configuring LU paths in a Fibre Channel environment

Before defining LU paths, you must classify server hosts by host storage domains. For example, if Linux and Windows hosts are connected to the disk array, you must create a separate host storage domain for each host type. When this is done, register the host bus adapters for each host type in the appropriate host storage domain.

### Host storage domains

A host storage domain can contain only hosts that are connected to the same port and cannot contain hosts that are connected to different ports. For example, if two Windows hosts are connected to port 1A and three Windows hosts are connected to port 1B, you cannot register all five Windows hosts in one host storage domain. You must register the first two Windows hosts in one host storage domain and the remaining three Windows hosts in another host storage domain.

After server hosts are classified into host storage domains, you must associate host storage domains to logical volumes. In [Figure 84](#), the host storage domain *hg-lnx* is associated with the logical volumes

00:00, 00:01, and 00:02. LU paths are defined between the two hosts in the *hg-lnx* group and the three logical volumes.

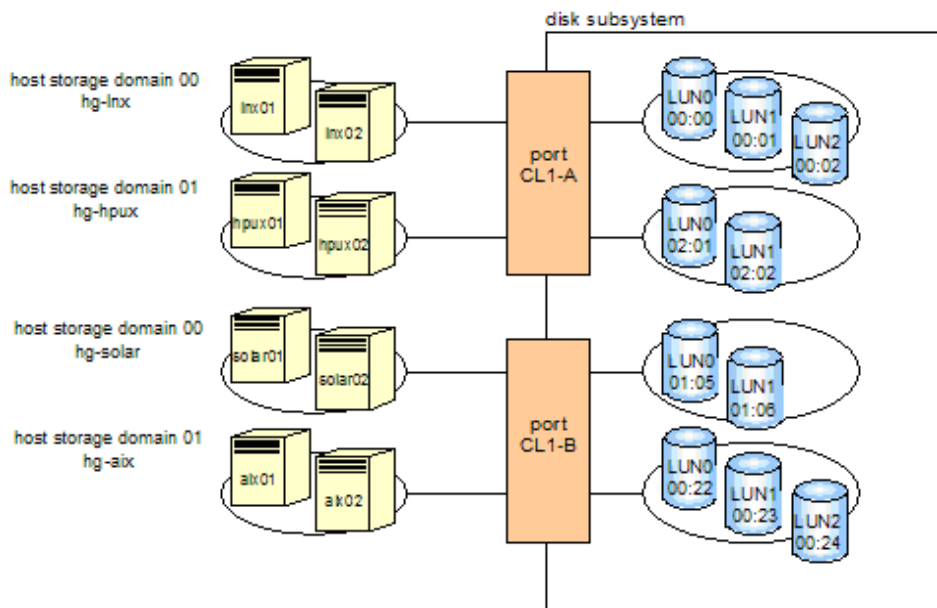
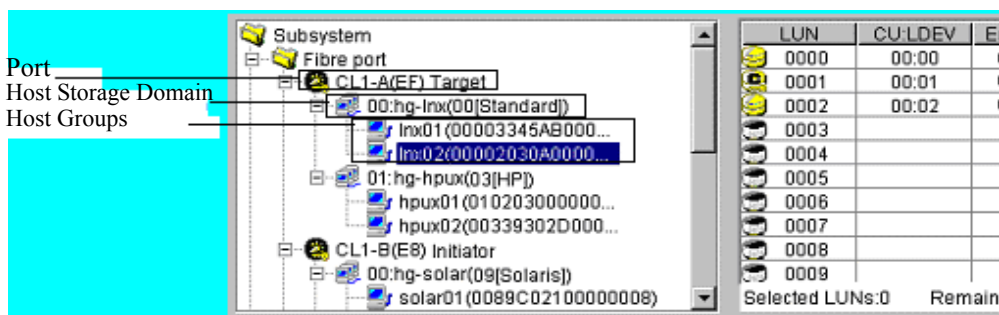

**Figure 84** LU paths configuration in a Fibre Channel environment

LUN Manager lets you define paths between a single server host and multiple LUs. In [Figure 84](#), both hosts in the *hg-lnx* host storage domain can access the three available LUs.

LUN Manager lets you define paths between multiple server hosts and a single LU. In [Figure 84](#), the LU identified as CU-LDEV 00:00 is accessible to the two hosts in the *hg-lnx* host storage domain.

In [Figure 84](#), the LUs associated with the *hg-lnx* domain are addressed by numbers 0 to 2. The address number of an LU is referred to as the logical unit number (LUN). When StorageWorks TrueCopy XP and other optional features manipulate LUs, they use LUNs to specify the LUs to be manipulated.

You can add, change, and delete LU paths when the system is operational. For example, if new disks or server hosts are added to your disk array, you can add new LU paths. If an existing server host is to be replaced, you can delete the corresponding LU paths before replacing the host. You do not need to restart the system when you add, change, and delete LU paths.

If a hardware failure (such as a CHA failure) occurs, there is a chance that some LU paths are disabled and some I/O operations are stopped. To avoid this, the system administrator can define alternate LU paths. If one LU path fails, the alternate path takes over the host I/O.

In a Fibre Channel environment, up to 1,024 LU paths can be defined for one host storage domain. Up to 1,024 LU paths can be defined for one port.



---

**NOTE:** You cannot define an LU path to LUN On Demand volumes or volumes reserved by CruiseControl.

---

- Up to 256 host storage domains can be created for one Fibre Channel port. Up to 57,344 host storage domains can be created for one disk subsystem. The maximum number of ports per subsystem is 224.
  - Up to 255 host groups can be created for one Fibre Channel port.
- 

## Configuring LU paths in a NAS environment (XP128/XP1024 only)

In a Fibre Channel or iSCSI environment, hosts are classified into platform-based host groups (host storage domains). This is not required in a NAS environment. Hosts attached to a NAS port are registered automatically in a host group (host storage domain) called **User**.

In a NAS environment, LUs are classified into system LUs and user LUs. System LUs contain system information necessary for managing the NAS environment and can only be manipulated by your HP account support representative. User LUs contain data that can be accessed by ordinary network users. When configuring a NAS system, you need to define paths between hosts and user LUs.

[Figure 85](#) shows an example of defined paths between hosts and user LUs. In a NAS environment, paths are always defined between a user LU and a group of four ports. In [Figure 85](#), two paths are defined to the user LU 00:00 (LUN 00). One path comes from the CL1-N port and the other path comes from the



CL1-Q port. Thanks to this two path configuration, hosts can access the user LU even if one of the paths fails.

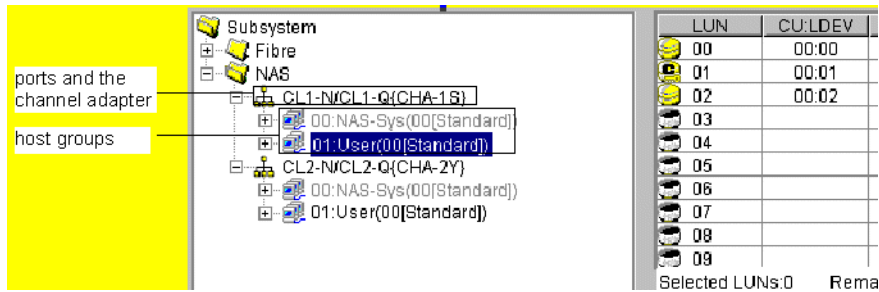

The "User" host group

Disk array

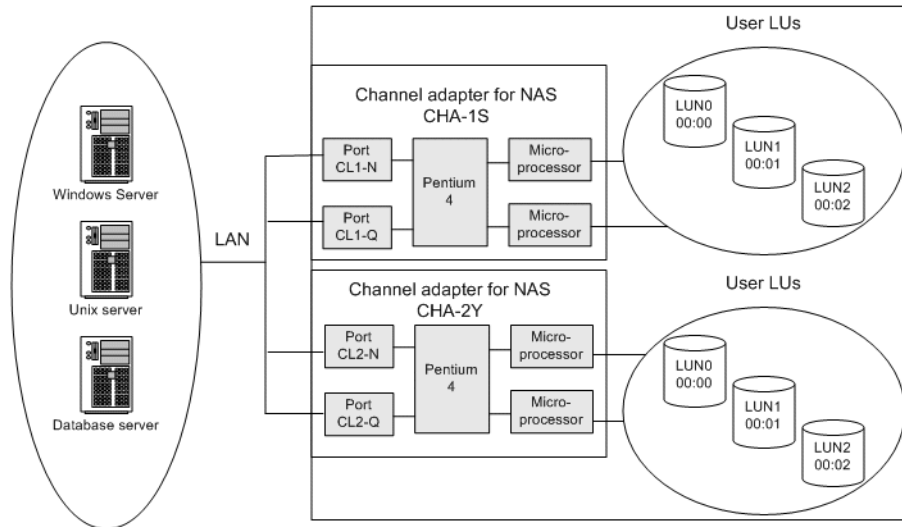

**Figure 85** LU paths configuration in a NAS environment (XP128/XP1024 only)

Notes:

- In a NAS environment, up to 256 LU paths can be defined for one NAS port.
- In a NAS environment, you cannot define LU paths to logical volumes unless they have the Read/Write access attribute.
- The LUN Management pane displays two host groups (**User** and **NAS-Sys**) below each NAS port. When you define LU paths, you can use only the **User** host group; you cannot use the **NAS-Sys** host group.

## 16-Port FC/CA CHIP product

Although there is not a significant performance gain compared to the 8-port FC/CA CHIP product, the primary advantage of the 16-port FC/CA CHIP product is its increased FC connectivity (or port count).

High-speed mode is currently unavailable on the 16-port FC/CA CHIP product.

Odd/even LUN data path handling through the processor does not exist on the XP128/XP1024. There is no odd/even LUN mapping issue associated with this product. Each processor of the 16-port CHIP product handles the data flow of two ports (eight total processors for 16 total ports = two ports per processor).

For load balancing, the two ports serviced by a processor should be considered as one port. Although volumes can be mapped to both ports handled by a processor, the I/O will go through one processor. For redundancy and performance reasons, consider distributing the load across multiple CHiPs.

When deciding whether to map volumes to ports (LUN mapping) for host connectivity, after considering load balancing across processors, there is no reason to not use all 16 ports immediately. After considering load balancing among processors, there is no reason not to use both ports in the I/O path of one processor or to use both ports in the I/O path of a processor.

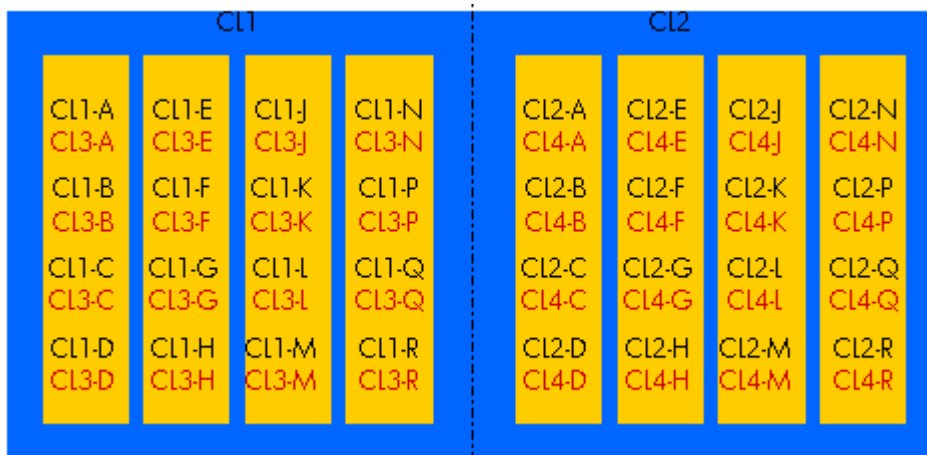

**Figure 86** 16-Port CHIP pair labeling

Port numbering is as follows: Cluster 1 uses CL1-\* and CL3-\*, while Cluster 2 uses CL2-\* and CL4-\*, where \* is an alphabetical character designation of the port such as A, B, C, and so on. Ports A, for example, CL1-A and CL3-A, share the same processor for I/O purposes.

## Host groups

Begin by grouping server hosts into host groups. For example, if HP-UX and Windows hosts are connected to the disk array, you must create a separate host group for each host type. When this is done, register the hosts in their corresponding host groups. After hosts are classified into host groups, associate the host groups with LUs.

In [Figure 87](#), the host group *hpux01* is associated with six LUs. LU paths are defined between the three hosts in the *hpux01* group (*WWN\_1*, *WWN\_2*, *WWN\_3*) and the six logical units LUN00-LUN05.

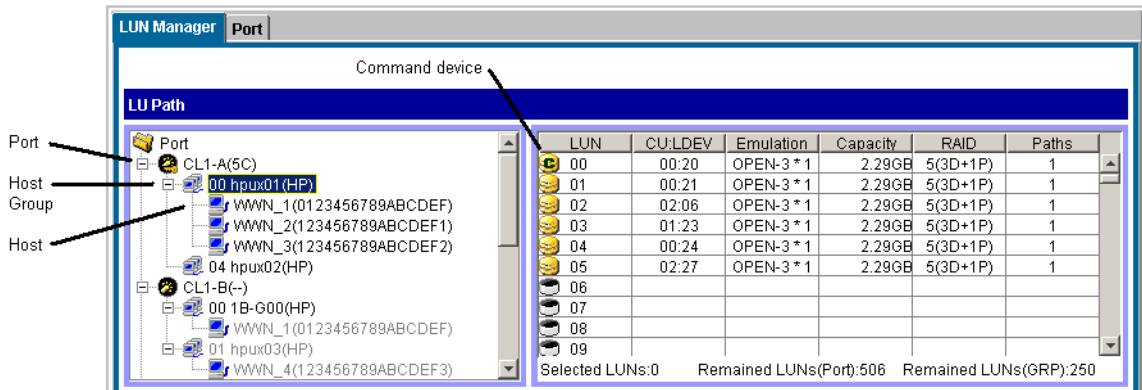

**Figure 87** Host group example 1

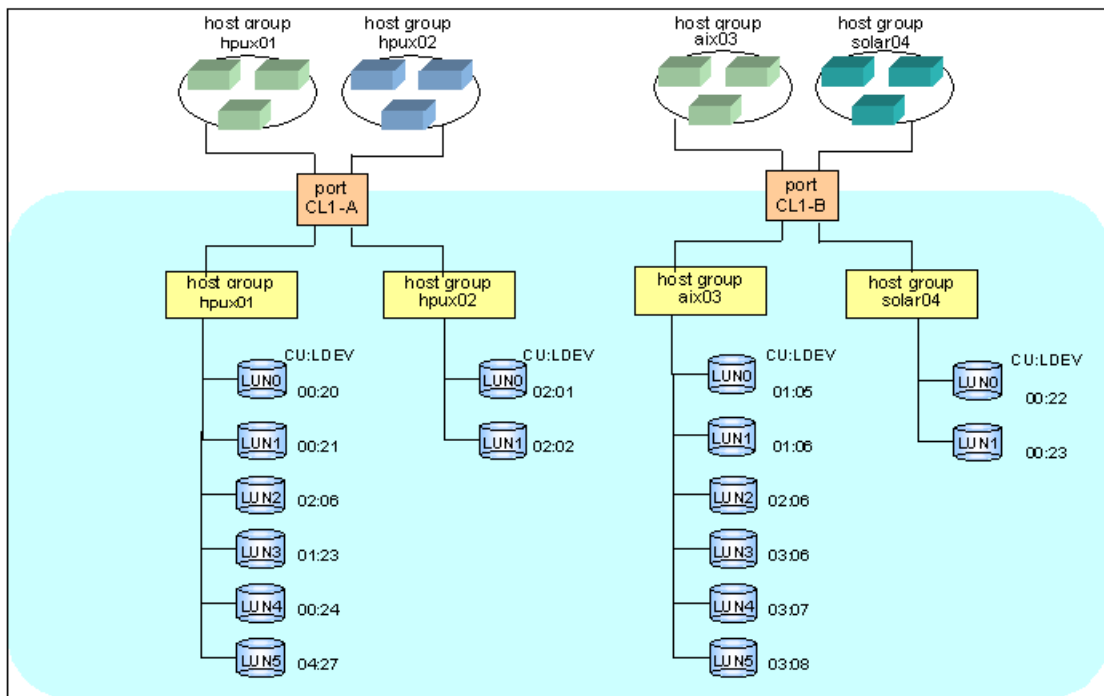

**Figure 88** Host group example 2

LUN Management can define paths between a single host and multiple LUs. In [Figure 88](#), each of the three hosts in the host group *hpux01* can access the six LUs. LUN Management can also define paths between multiple hosts and a single LU.

Hosts can be members of only one host group for a given port. Host group definitions and members apply only to the port that they are defined for.

# Host modes

As part of registering hosts in host groups, you will be asked for the host mode. Use [Table 27](#) to determine the host mode.

**Table 27** Host modes for host operating systems (XP128/XP1024)

Host mode	Host operating system
00	Red Hat Linux, IRIX, or Windows <sup>1</sup> (Standard)
01 - 03	Reserve
04	DYNIX/ptx (Sequent)
05	OpenVMS
06	Reserve
07	Tru64
08	HP-UX or Windows <sup>2</sup>
09	Solaris
0A	NetWare
0B	Reserve
0C	Windows <sup>3, 4</sup>
0D, 0E	Reserve
0F	AIX
10 - 19	Reserve
1A - 1F	Reserve
20 - 29	Reserve
2A, 2B	Reserve
2C	Windows Extension <sup>3, 4</sup>
2D - 2F	Reserve
29	Solaris <sup>5</sup>

1. For Windows with any FC HBAs when MSCS is not needed.
2. For Windows with D8602 FC HBAs with or without MSCS.
3. For Windows with Emulex or QLogic FC HBAs with or without MSCS.
4. If you register Windows server hosts in a host group, verify that the host mode of the host group is **0C: Windows** or **2C: Windows Extension**. If you are thinking about creating LUSE volumes, such as expanded LUs, consider setting the host mode 2C: Windows Extension to the host group. If the host mode is **0C: Windows** and an LU path is defined for a volume, you cannot execute LUSE operations on the volume without unmapping the volume first.
5. When registering Sun Cluster server hosts in the host group (Use this host mode both VERITAS Cluster Server and Sun Cluster are used).

# LUN Security

To protect data from unauthorized access, apply security policies to LUNs. LUN Management can apply LUN security to ports to safeguard LUs. If a port has the External attribute, you cannot apply LUN security to the port.



**NOTE:** You cannot apply LUN security to NAS ports.

If LUN security is applied, it limits which host can access which LUs. A host can only access LUs associated with its host group. Hosts cannot access LUs associated with other host groups.

In [Figure 89](#), the hosts in the *hpux-G01* group can access LUN0 and LUN1 associated with the same host group, but cannot access LUN0 and LUN1 in the *winG02* host group. The hosts in *hpuxG01* can only access the two LUs, identified by 01:05 and 02:01; the hosts cannot access the LUs 02:00 and 02:02.

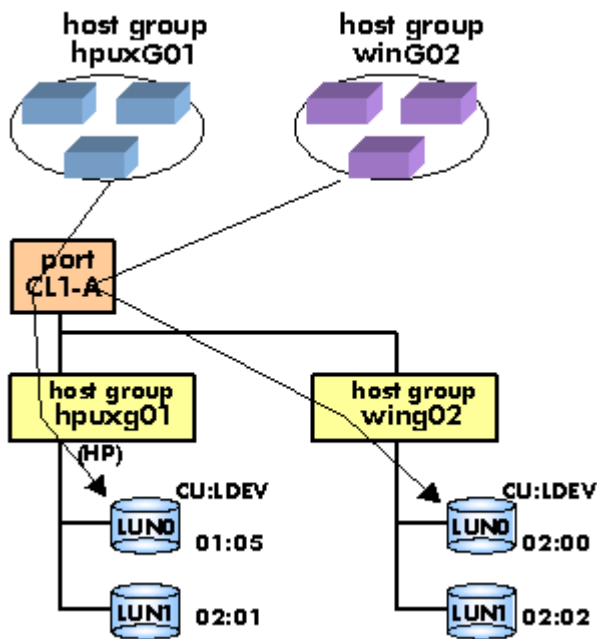

**Figure 89** Host group example 3 (LUN security)

If LUN security is disabled, the hosts will not be able to access most of the LUs. Hosts will have access to only those LUs defined in host group 0.

By default, LUN security is disabled on a port, so host group 0 is the only accessible host group reserved for the port. Initially it contains no LUs or WWNs.

When security is disabled, only LUs defined in host group 0 are accessible to hosts connected to the port, regardless of any WWNs that may be defined for a host group. After security is enabled, WWNs are used, permitting or restricting access based on WWN.

If you have more than one host group defined on a port, you can locate host group 0 by disabling LUN security from the port. When done, the tree display will “gray” out all host groups except host group 0.

---

# RAID Manager command devices

To use RAID Manager commands for Business Copy and Continuous Access operations, you must designate at least one LDEV on the disk array as a command device. A command device receives RAID Manager commands entered from hosts. When you enter a RAID Manager command from a host, the command is transferred to the target device via the command device.

If you want to restrict access to LUs and by RAID Manager, you can apply command device security in LUN Manager.

## Restrictions

You cannot use the following LDEVs as command devices:

- Volumes that do not have read/write access
- Volumes reserved by Auto LUN
- CA volumes
- BC volumes
- External LUs
- iSCSI volumes (volumes to which paths are defined from iSCSI ports)
- Flex Copy volumes

You cannot use an LDEV as a command device if a path is defined between an iSCSI port and the LDEV.

If you want to use a LUSE volume as a command device, you must specify only the first LU as the command device.

---

# Fibre Channel port attributes

In Fibre Channel environments, you must configure the Fibre Channel topology and set addresses for the Fibre Channel ports. You can enhance system performance by adjusting the data transfer speed at the Fibre Channel ports and changing the channel adapter mode.

## Fibre Channel topologies

Fibre Channel provides the following topologies:

- **Fabric:** Uses a fabric switch to connect a large number of devices. Each device has the full bandwidth of 100 MB/sec.
- **FC-AL (Fibre Channel-Arbitrated Loop):** A shared-bandwidth topology that can connect up to 126 devices (AL ports).
- **Point-to-point:** A simple Fibre Channel topology in which two devices are connected directly.

When configuring the disk array, use LUN Management to specify whether the hosts and the disk array are connected by a fabric switch. Also, you must specify FC-AL or point-to-point in the LUN Management pane. The default is FC-AL.

If you are using a fabric switch, consult the switch's documentation to learn whether FC-AL or point-to-point should be used. Some fabric switches require that you specify point-to-point to get the system running.

## Arbitrated loop physical addresses

You will need to set addresses for Fibre Channel ports. When addressing Fibre Channel ports, you can use AL-PA (arbitrated loop physical address) or loop IDs as the addresses (see [Table 28](#)).

**Table 28** AL-PA and loop IDs (XP128/XP1024)

AL-PA	Loop ID	AL-PA	Loop ID	AL-PA	Loop ID	AL-PA	Loop ID
EF	0	B2	32	72	64	3A	96
E8	1	B1	33	71	65	39	97
E4	2	AE	34	6E	66	36	98
E2	3	AD	35	6D	67	35	99
E1	4	AC	36	6C	68	34	100
E0	5	AB	37	6B	69	33	101
DC	6	AA	38	6A	70	32	102
DA	7	A9	39	69	71	31	103
D9	8	A7	40	67	72	2E	104
D6	9	A6	41	66	73	2D	105
D5	10	A5	42	65	74	2C	106
D4	11	A3	43	63	75	2B	107
D3	12	9F	44	5C	76	2A	108
D2	13	9E	45	5A	77	29	109
D1	14	9D	46	59	78	27	110
CE	15	9B	47	56	79	26	111
CD	16	98	48	55	80	25	112
CC	17	97	49	54	81	23	113
CB	18	90	50	53	82	1F	114
CA	19	8F	51	52	83	1E	115
C9	20	88	52	51	84	1D	116
C7	21	84	53	4E	85	1B	117
C6	22	82	54	4D	86	18	118
C5	23	81	55	4C	87	17	119
C3	24	80	56	4B	88	10	120
BC	25	7C	57	4A	89	0F	121



**Table 28** AL-PA and loop IDs (XP128/XP1024) (continued)

AL-PA	Loop ID	AL-PA	Loop ID	AL-PA	Loop ID	AL-PA	Loop ID
BA	26	7A	58	49	90	08	122
B9	27	79	59	47	91	04	123
B6	28	76	60	46	92	02	124
B5	29	75	61	45	93	01	125
B4	30	74	62	43	94		
B3	31	73	63	3C	95		

## Data transfer speed for Fibre Channel ports

As disk array operation continues, you may notice that a larger amount of data is transferred at some ports and a smaller amount is transferred at other ports. To improve system performance, set a faster data transfer speed for ports where a larger amount of data is transferred, and a slower data transfer speed for ports where a smaller amount of data is transferred.

## Standard, high-speed, and high-speed (2 port) modes

The channel adapter boards can operate in standard, high-speed, or high-speed (2-port) mode. Standard mode is the default. If a channel adapter board satisfies certain conditions, you can set it to high-speed or high-speed (2 port) mode to improve port performance.



**NOTE:** High-speed (2 port) mode is available only if firmware version 21.06.22 or later is installed on the disk array.

High-speed mode can be applied to channel adapter boards that satisfy the following conditions:

- Only one port is planned for use.
- All ports take the same Fibre topology option (on or off).
- All ports take FC-AL as the Connection option.
- All ports use different port addresses and no matching addresses.
- All ports take the same port attribute (Initiator, RCU target, or Target).

If high-speed mode is applied to a channel adapter board, only one of the ports on the channel adapter board can be used. This port can exclusively use channel processors and fibre optic processors (FOPs) that would otherwise be reserved for the other ports. Balancing the workload on the processors can improve system performance.

If high-speed (2 port) mode is applied to a four-port channel adapter board, two ports out of the four ports cannot be used. The remaining two ports can exclusively use channel processors and FOPs that would otherwise be reserved for the other two ports.

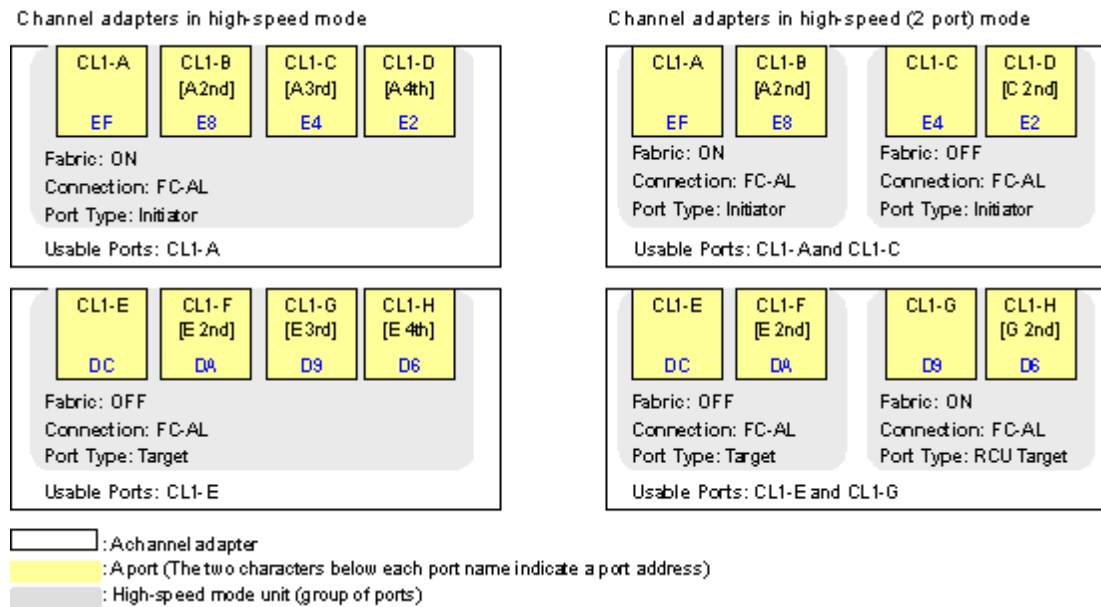

**Figure 90** Differences between high-speed and high-speed (2 port) modes

Before changing the configuration of a port that is being used, perform a backup operation. You cannot switch between standard and high-speed while you are online to the hosts.

## iSCSI environments (XP128/XP1024 only)

iSCSI (Internet Small Computer System Interface) is a protocol that enables data transfers between host computers and large-scale storage devices over an IP (Internet Protocol) network. If you want to use the disk array as an IP storage device, host servers should be attached to disk array's iSCSI ports.

iSCSI environments that can be created with LUN Management support local connections (i.e., hosts in the same domain can communicate with each other), but do not support inter-domain connections or external LAN connections.

## Configuring an iSCSI environment

When configuring an iSCSI environment:

- Confirm what operating systems are used to run hosts in your IP network. To configure an iSCSI network, each of the hosts must run under the Windows Server 2003, Windows 2000, or HP-UX 11i operating system. However, user authentication is not available on hosts running under HP-UX 11i.
- You can set ports to perform user authentication. The ports use CHAP (Challenge Handshake Authentication Protocol) as the authentication method.
- Switching hubs can be connected to iSCSI ports, but other network relay devices cannot be connected to iSCSI ports.

## iSCSI port settings and iSNS server settings

You must configure iSCSI ports and iSNS servers, if necessary, when configuring an iSCSI environment. Specify the following items when configuring an iSCSI environment. (See "Configuring iSCSI Ports" on page 220).

- **IP:** (Mandatory). The IP addresses of iSCSI ports. In LUN Management, the default value of an iSCSI port IP address is 192.168.0.xxx, where xxx is the location of the iSCSI port.
- **Subnet mask:** (Mandatory). The subnet mask is the value that is used to obtain a network address from an IP address. In LUN Management, the default subnet mask is 255.255.255.0.
- **Gateway address:** (Mandatory if a gateway is used). A gateway is hardware that connects networks of different protocols.
- **iSCSI name:** (Mandatory). You must assign iSCSI names to iSCSI ports. iSCSI names are used to uniquely identify each iSCSI node. iSCSI nodes are devices that use the iSCSI protocol for communication, such as iSCSI ports in the disk array, host bus adapters in host servers, and switching hubs for network relaying.

iSCSI names must be specified in one of the following formats:

- **eui format:**

An IEEE 64-bit Extended Unique Identifier is used to specify the iSCSI name. The iSCSI name begins with "eui.", which is followed by a WWN (world wide name) of an iSCSI port.

If a host is connected to an iSCSI port, LUN Management automatically displays the iSCSI name in eui format.

Example: `EUI.02004567A425678D`

- **iqn format:**

The iSCSI Qualified Name format is used to specify an iSCSI name. For information on specifying iSCSI names in this format, refer to iSCSI-related documentation.

Example: `iqn.2003.09.com.hp:iscsi-r450:model-xxx:sn-xxxxxxx:lun00`

The length of an iSCSI name must be exactly 20 characters in *eui* format, and up to 223 characters in *iqn* format. iSCSI names can include letters, numbers, periods (.), hyphens (-), and colons (:), but they cannot include double-byte characters. iSCSI names are not case-sensitive.

- **iSCSI alias:** (Optional). An iSCSI alias is a nickname you can assign to an iSCSI name. iSCSI aliases are helpful for managing and identifying iSCSI ports.

It can be difficult to identify iSCSI ports by iSCSI names because an iSCSI name contains many characters and can be difficult to remember. Assigning a short, easy-to-remember iSCSI alias allows you to identify iSCSI ports easily and quickly.

An iSCSI alias can contain up to 32 characters. iSCSI aliases can include letters, numbers, periods (.), hyphens (-), and colons (:), and cannot include double-byte characters. iSCSI aliases are case sensitive; for example, MyPort and myport are different iSCSI aliases.

- **Port number:** (Mandatory). LUN Management allows you to specify a port number as an integer from 1 to 65535. The initial value of a port number is 3260.
- **Keep-alive timer:** (Mandatory). This timer is used when there is a connection between an iSCSI port and another iSCSI node. For example, if the keep-alive timer is set to 60 seconds, the disk array checks whether a communication packet was sent between an iSCSI port and another iSCSI node (such as a host bus adapter or a switching hub) every 60 seconds.  
  
You can specify a value from 0 to 64800 seconds. The initial value for the keep-alive timer is 60 seconds.

- **Whether to register iSCSI ports in iSNS servers:** The iSNS server is a server computer on which an Internet Storage Name Service (iSNS) service is installed. This server is used to manage IP addresses and iSCSI names of iSCSI ports. Using iSNS servers is optional. If iSNS servers are configured and used, iSCSI ports are easily discovered and managed.



---

**NOTE:** For detailed information about configuring iSNS servers, see the iSNS-related documentation.

---

- **IP address of iSNS server:** To use an iSNS server, specify the IP address of the iSNS server.
  - **TCP port number of iSNS server:** To use an iSNS server, specify a TCP port number of the iSNS server.
- 



**NOTE:** Specify 3205 as the TCP port number if you use Microsoft iSNS Server as the iSNS server. If you specify other than 3205, you cannot register iSCSI ports in iSNS server.

---

## Checking the status of the connection between hosts and the disk subsystem

Use LUN Management to issue a ping command from an XP128/XP1024 iSCSI port to a host. The ping command checks whether the host and the XP128/XP1024 can communicate with each other. If the host responds to the ping command, the host and the XP128/XP1024 can communicate with each other. See [“Checking the status of connection between hosts and the disk array \(iSCSI environment only\)”](#) on page 221.

## User authentication (iSCSI environments only)

When configuring an iSCSI environment, you can use LUN Management to set ports of the disk array to authenticate hosts. In an iSCSI environment, the ports use CHAP as the authentication method.

### User authentication operations and settings

User authentication involves two phases:

1. **Host authentication:** A disk array port authenticates a host when it attempts to connect to the array
2. **Port authentication:** The host authenticates the connection-target port of the disk array

The disk array performs user authentication by ports. Therefore, the ports and hosts need to have their own user information in order to perform user authentication.

When a host attempts to connect to the disk array, the host authentication phase starts. In this phase, the array determines whether the port requires host authentication. If the port does not require host authentication, the host will connect to the disk array without authentication; otherwise authentication is performed for the host. When the host is authenticated successfully, the next phase begins.

This port authentication phase starts if the host requires user authentication for the connection target port. Thus the ports and hosts perform *mutual authentication*. If the host does not require user authentication for the port, the host will connect to the disk array without port authentication.

The following section explains the required settings for user authentication. Port authentication settings are needed only if you want to perform mutual authentication.

- Host authentication settings
  - On the disk array:

Use LUN Management to specify whether to perform host authentication on each port. On a port that performs authentication, register the user information (iSCSI name, user name, and secret) for the hosts that are allowed to connect to the port.



**NOTE:** A *secret* is a password used in CHAP authentication.

When registering user information, you can also specify whether to enable or disable host authentication. For details, see ["Specifying whether to enable or disable host authentication on a port"](#) on page 224 and ["Registering user information of hosts on a port"](#) on page 224.

- On hosts:

Configure the operating system and iSCSI driver for port authentication using CHAP. Specify the user name and secret of the host used for CHAP. For details, refer to your operating system and iSCSI driver documentation.

- Port authentication settings (required for mutual authentication)

- On the disk array:

Use LUN Management to specify user information (user name and secret) of each port. For details, see ["Specifying user information of ports \(when performing mutual authentication\)"](#) on page 227.

- On hosts:

Configure the operating system and iSCSI driver for CHAP port authentication. Specify the user name and secret of the port that is the connection target. For details, refer to your operating system and iSCSI driver documentation.

## Host authentication

When a host attempts to connect to the disk array, the connection results of the host's authentication depend on the port settings. [Figure 91](#) illustrates the relationship between port settings and the connection results.

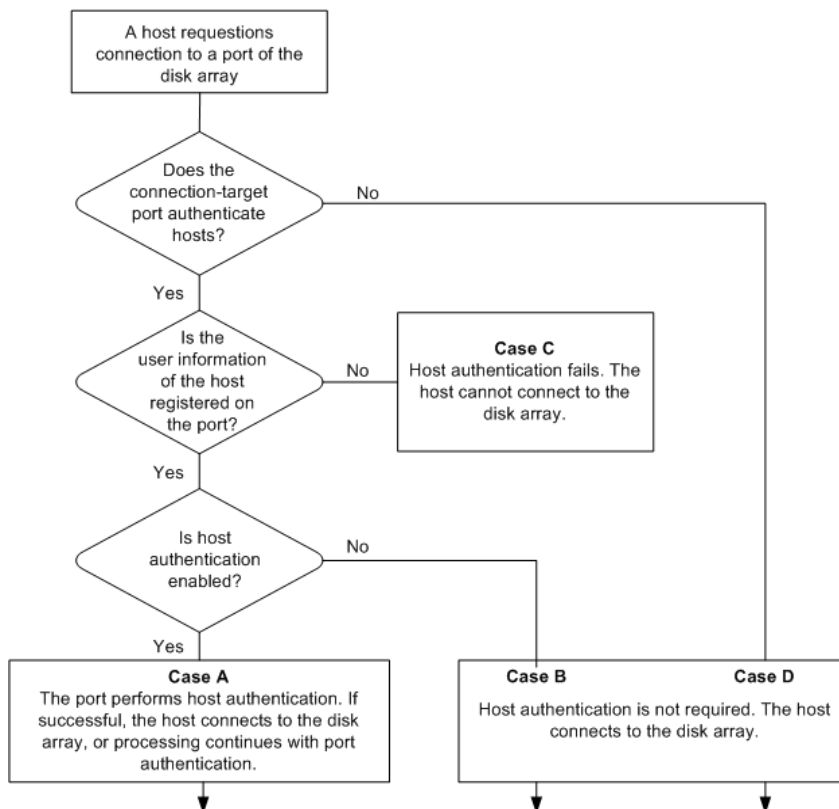

**Figure 91** Flow of port authentication

Each case in [Figure 91](#) is explained below.

- When connecting via a port that performs host authentication:
  - If the user information of the host is registered on the port and host authentication is enabled (Case A): The port authenticates the user information sent from the host. If the host authentication is successful, then:

If the host is configured for mutual authentication, processing continues with port authentication. If the host is not configured for port authentication using CHAP, the authentication fails and the host cannot connect to the disk array.

If the host is not configured for mutual authentication, the host connects to the disk array.
  - If the user information of the host is registered on the port but host authentication is disabled (Case B): The port does not perform host authentication. Irrespective of whether the host is configured for port authentication using CHAP, the host connects to the disk array.

---

 **CAUTION:** If a host uses Microsoft iSCSI Initiator and is configured for port authentication using CHAP, host authentication will fail. To allow such a host to connect to the port without authentication, do not configure it for port authentication using CHAP.

---

- If the user information of the host is not registered on the port (Case C): Irrespective of the setting on the host, the port performs host authentication and it fails. The host cannot connect to the disk array.
- When connecting via a port that does not perform host authentication (Case D): The host can connect to the disk array without host authentication irrespective of whether the host is configured for port authentication using CHAP. In this case, registering the user information of the host on the port is not required.

---

 **CAUTION:** If a host uses Microsoft iSCSI Initiator and is configured for port authentication using CHAP, host authentication will fail. To allow such a host to connect to the port without authentication, do not configure it for port authentication using CHAP.

---

---

 **NOTE:** You must register user information of all the hosts to be connected to a port on which host authentication is performed. If you want to allow a specific host to connect to a port without authentication, configure the port and the host as follows:

- On the port: Register the user information of the host you want to allow to connect without authentication, then clear the **Enable authentication** check box.
  - On the host: It does not matter whether you configure the host for port authentication using CHAP. If the host uses Microsoft iSCSI Initiator, do not configure the host for port authentication using CHAP.
-

Figure 92 provides an overview of user authentication. In this figure, iSCSI names of host bus adapters (HBAs) are abbreviated as a, b, and so on.

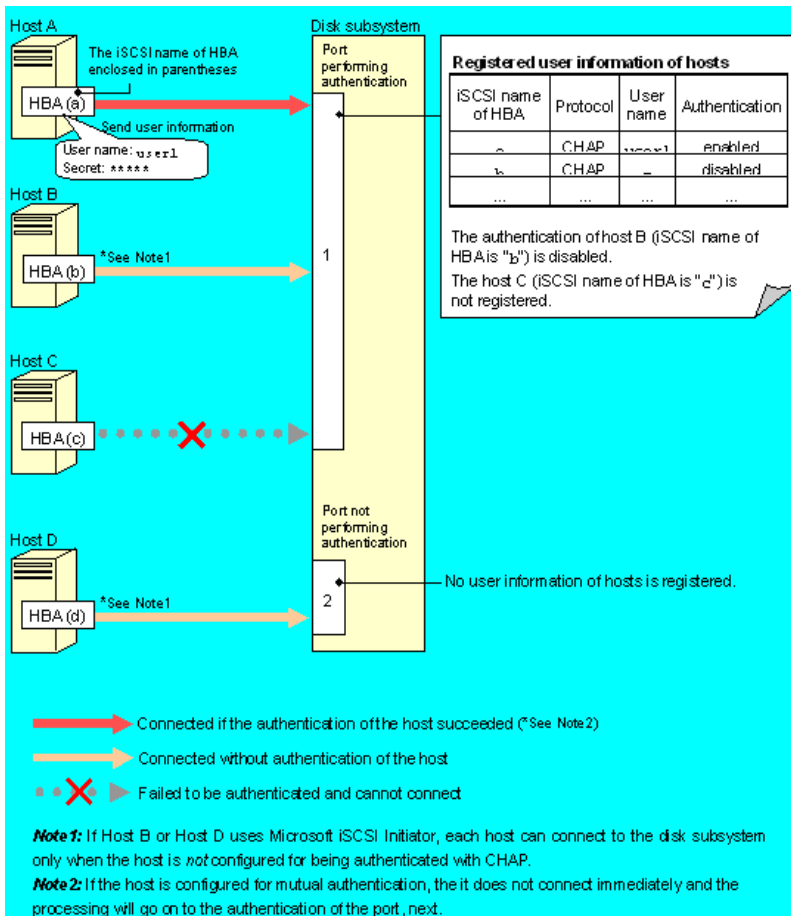

Figure 92 Overview of user authentication

In this example, port 1 performs host authentication while port 2 does not.

The user information of Host A is registered on port 1, and the authentication setting is enabled. If the host authentication is successful, Host A can connect to the disk array (or the processing continues with port authentication). In order for host authentication to succeed, Host A must be configured for port authentication using CHAP.

The user information of Host B is also registered on port 1, but the authentication setting is disabled, and Host B can connect to the disk array without authentication. If Host B uses Microsoft iSCSI Initiator, it can connect to the disk array only when Host B is not configured for port authentication using CHAP.

The user information of Host C is not registered on port 1. When Host C tries to connect to the disk array, authentication fails and the connection request is denied.

Host D is attached to port 2, which does not authenticate hosts, so Host D can connect to the disk array without authentication. In this case, it does not matter whether the user information of Host D is registered on port 2. If Host D uses Microsoft iSCSI Initiator, Host D can connect to the disk array only when Host D is not configured for port authentication using CHAP.

For more information about port settings, see "Specifying whether to enable or disable host authentication on a port" on page 224 and "Registering user information of hosts on a port" on page 224. For host configuration details, refer to your operating system and iSCSI driver documentation.



## Port authentication (performing mutual authentication)

When host authentication is successful, the host performs port authentication if required (mutual authentication). During port authentication, if the user information specified on the port side matches the information on the host, the host allows the port to connect.

For more information about port authentication settings, see “[Specifying user information of ports \(when performing mutual authentication\)](#)” on page 227. For details on how to configure a host, refer to your operating system and iSCSI driver documentation.

## LUN Management operations

This section includes procedures for performing the most common LUN Management operations.

### Starting LUN Management

1. Click an XP128, XP1024, or XP12000 link in the Device Launcher pane.
2. Click **LUN Manager** in the left pane. The LUN Manager pane appears.

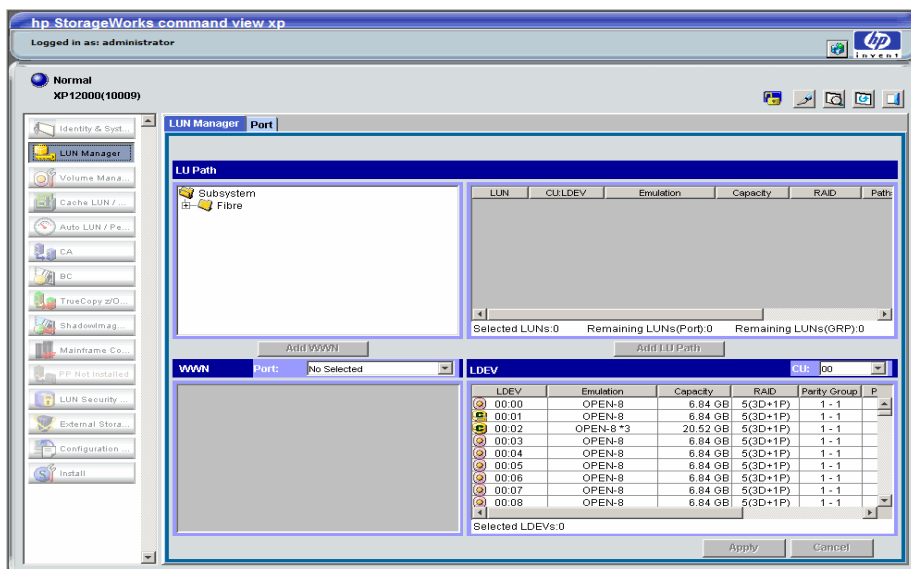

**Figure 93** LUN Management main pane

### LUN Management main pane

The LUN Management main pane contains the tabs listed in [Table 29](#).

**Table 29** LUN Management tabs

Tab	Use this tab to...
LUN Manager	Define LU paths and apply LUN security for logical volumes.
Port	Configure ports by setting the topology and port addresses (“ <a href="#">Starting Port Operations</a> ” on page 216).
User Authentication (XP128/XP1024/XP12000)	Enable or disable authentication settings and register user information on hosts and ports (“ <a href="#">User Authentication tab</a> ” on page 222).

## LU Path tree









The LU Path tree on the upper left of the LUN Manager tab lists the Fibre Channel and NAS ports in the disk array and hosts connected to them. Hosts are identified by nicknames and WWNs and are classified by host groups.

The LU Path tree may contain different folders: Fibre Channel, NAS, iSCSI, etc.

## Fibre Channel folder

The following Fibre Channel port icons are used in the LU Path tree:

**Table 30** Fibre Channel port icons for LUN Management operations

Icon	Status
	A short-wave port in standard mode without LUN security
	A short-wave port in standard mode with LUN security
	A long-wave port in standard mode without LUN security
	A long-wave port in standard mode with LUN security
	A short-wave port in high-speed mode without LUN security
	A short-wave port in high-speed mode with LUN security
	A long-wave port in high-speed mode without LUN security
	A long-wave port in high-speed mode with LUN security



**NOTE:** High-speed (2 port) mode is available only if the XP disk array has firmware version 21.06.22 or later installed (XP128/XP1024 only).

## NAS folder (XP128/XP1024 only)

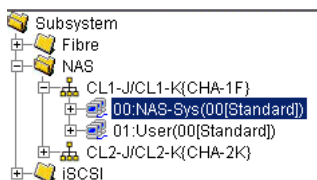

**Figure 94** NAS folder in LU path tree



In a NAS environment, if you double-click the NAS folder, NAS ports in the disk array appear as icons. Two port names appear to the right of each icon, followed by the channel adapter name in parentheses.



**NOTE:** The NAS folder appears only if the disk array contains one or more NAS channel adapters.

The following are the NAS port icons used in the LU Path tree:

**Table 31** NAS port icons for LUN Management operations

Icon	Status
	Indicates that you can assign paths from this NAS port to logical volumes
	Represents a short-wave port in standard mode with LUN security

When you double-click a NAS port, the following host groups appear:

- NAS-Sys
  - If you select **NAS-Sys**, the table on the right displays information about paths to system LUs. The table contents are dimmed and cannot be changed.
  - This host group number is 00.
- User
  - If you select **User**, the table on the right displays information about paths to user LUs.
  - This host group number is 01.

## iSCSI folder

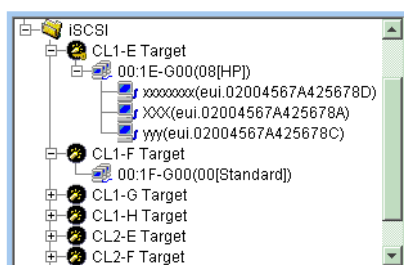

**Figure 95** iSCSI folder in LU path tree

When you double-click the iSCSI folder, iSCSI ports in the disk array appear as icons. The port name and port attribute appear to the right of each icon.







### NOTE:

- The iSCSI folder is available if the disk array has an iSCSI channel adapter
- iSCSI ports always have the Target attribute
- iSCSI is not supported for the XP12000

The following iSCSI port icons are used in the LU Path tree:

**Table 32** iSCSI port icons for LUN Management operations

Icon	Meaning
	LUN security is not applied to the port.
	LUN security is applied to the port.

- When you double-click an iSCSI port in the tree, a list of host groups appears represented by the following icon: . The host group number, host group name, and host mode appear to the right of the icon. For more information about host modes, see [Table 27](#).
- When you double-click a host group in the tree, a list of host bus adapters appears represented by the following icon: . The nickname and the iSCSI name of the host bus adapter appear to the right of this icon.



**NOTE:** Host bus adapters are adapters in host computers and are used as ports for connecting hosts and the disk array.

- When you double-click a port to which LUN security is not applied, the host groups except for the first group (host group 0) are dimmed. If you double-click a dimmed host group, the contents of the LU Path table (“[LU Path table](#)” on page 200) are dimmed.





## LU Path table

On the right side of the LU Path tree is a table that displays LU Path information about the hosts in the tree. The table contains the following information:

- **LUN:** LUNs (address numbers) assigned to LUs, which are LDEVs that can be accessed by hosts. If no paths are defined, the other table columns are blank.

The following icons indicate status:

**Table 33** LUN icons for LUN Manager operations

Icon	Status
	A logical volume to which an LU path is defined
	An expanded LU
	A command device
	A command device with security enabled
	A LUN to which no LU path is defined

- **CU:LDEV:** The CU image and LDEV numbers. If an LDEV number ends with the sharp symbol (#), the logical volume is an external LU.
- **EMU Type:** Emulation type for each LDEV

- **Capacity:** Size of each LDEV
- **RAID:** RAID level for each LDEV. If the logical volume is an external LU, the RAID column displays a hyphen (-) instead of a RAID level.
- **Array Group** (XP128/XP1024 only): Names of the array groups. If an array group name begins with the letter E, the group includes one or more Flex Copy LDEVs.
- **Parity Group** (XP12000 only): Names of parity groups. If the name begins with the letter “E”, the group is an external volume group consisting of one or more external volumes.
- **Paths:** Number of alternate paths, if any
- **Access Attribute:** Access attribute of each LDEV
- **Ex-Dev. Info:** The array where the LDEVs exist. This column displays a hyphen (-) if the LDEV exists in an XP12000 array.
- **Serial:** (XP12000 only) Displays the serial number of the disk array.

## WWN or iSCSI name table

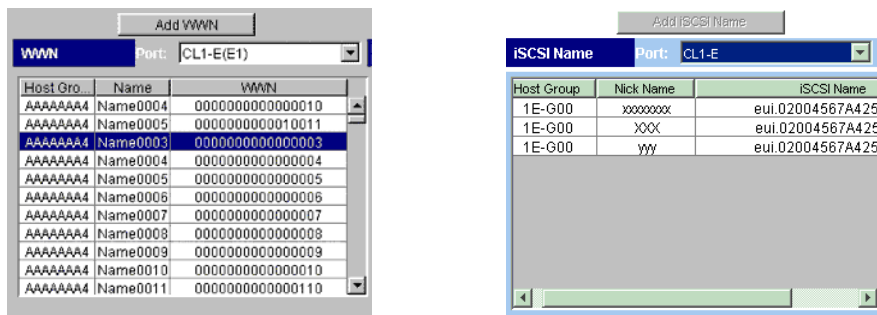

**Figure 96** WWN and iSCSI name tables

The lower-left corner of the LUN Manager tab displays the WWN or iSCSI Name table. If you selected a Fibre Channel port in the LU Path tree, the WWN table appears. If you selected an iSCSI port, the iSCSI Name table appears.

The WWN table lists host bus adapters that are connected to Fibre Channel ports on the disk array and the iSCSI Name table lists host bus adapters that are connected to iSCSI ports on the disk array.

The tables contain the following information:

- A list of ports
- **Host Group:** Host groups are used to classify servers (hosts) connected to the disk array. You can create host groups in the LUN Manager pane.
- **Name (Nick Name** in iSCSI Name table): Indicates nicknames for hosts. Nicknames can be specified in the LUN Manager pane.
- The **WWN** (WWN table only). Each worldwide name represents one host.
- The **iSCSI Name** (iSCSI Name table only)

## LDEV table

The LDEV table in the lower-left corner of the LUN Manager tab lists LDEVs in the disk array. The LDEV table does not list Auto LUN-reserved LDEVs.





The table contains the following information:

- A list of CU images

- **LDEV:** A combination of the CU image number and LDEV number that identifies an LDEV. If an LDEV number ends with the sharp symbol (#), the logical volume is an external LU.

The following icons indicate LDEV status:

**Table 34** LDEV icons for LUN Management operations

Icon	Status
	Normal logical volume
	Expanded LU
	A VSC volume
	A command device.
	A command device with security enabled

- **Emulation:** Emulation type for each LDEV
- **Capacity:** Size of each LDEV
- **RAID:** RAID level for each LDEV. If the logical volume is an external LU, the RAID column displays a hyphen (-) instead of a RAID level.
- **PG:** Displays names of parity groups. If a parity group name begins with the letter E, the parity group consists of one or more external LUs.
- **Paths:** The number of alternate paths, if any
- **Access Attribute:** Provided for each logical volume

### Buttons

- **Apply:** Applies settings in the pane to the disk array
- **Cancel:** Cancels settings in the pane
- **Add LU Path:** Adds LUs to LU Path table
- **Add WWN** (WWN table only): Registers host bus adapters in a host group. Applies to Fibre Channel ports only.
- **Add iSCSI Name** (iSCSI Name table only): Registers host bus adapters in a host group. Applies to iSCSI ports only.

## Defining LU paths

To configure a Fibre Channel or iSCSI environment, complete the following major steps:

1. Find the WWNs of the host bus adapters connected to the Fibre Channel ports (Fibre Channel only).
2. Create host groups ("[Creating host groups](#)" on page 203)
3. Register hosts in host groups ("[Registering hosts in host groups](#)" on page 204)
4. Associate host groups to logical volumes ("[Associating host groups to logical volumes](#)" on page 207)



**NOTE:** If you are configuring a NAS environment (XP128/XP1024 only), skip steps [step 1](#) through [step 3](#) above and follow the procedure in “[Associating host groups to logical volumes](#)” on page 207.

## Creating host groups



**NOTE:** If you are configuring a NAS environment (XP128/XP1024 only), skip this section.

You can connect multiple server hosts of different platforms to one port of your disk array. When configuring the system, you must group server hosts connected to the disk array by host groups. For example, if HP-UX and Windows hosts are connected to a port, create a host group for each host type.

1. In the LU Path tree, locate the port and verify that LUN security is enabled.



**NOTE:** If the port icon has a key , LUN security is enabled.

If LUN security is not enabled, right-click the port and select **LUN Security: OFF->ON** (XP128/XP1024) or **Disable->Enable** (XP12000) in the shortcut menu.

2. After LUN security is enabled, right-click the port in the LU Path tree and select **Add New Host Group**. The Add New Host Group dialog box appears.

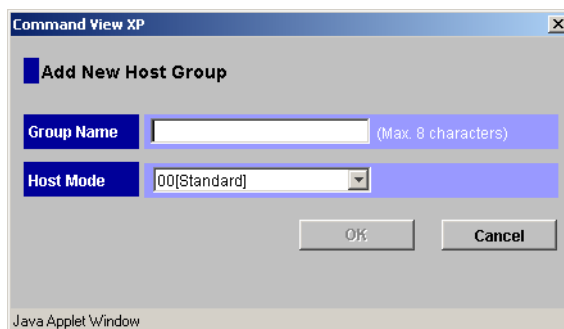

**Figure 97** Add New Host Group dialog box

3. In the Group Name box, enter the host group name.



**NOTE:** It is convenient to name each host group after the host platform. For example, if you are creating a host group for Windows NT hosts, the host group name could be WNT or WinNT. Host group names are case sensitive and can have up to eight characters.

4. In the Host Mode list, select a host mode. Host groups on the same port can have different host modes.
5. If necessary, select **Option**, and select the host mode options. For detailed information about host mode options, see [Table 35](#).



**NOTE:** After you select **Option**, the pane expands to display check boxes. The check boxes are numbered sequentially from left to right. The leftmost check box on the upper row is #0, and the check box immediately to the right is #1, and so on. The numbers indicate option numbers; select check box #0 to select option #0.

6. Click **OK**. The host group name and the host mode appear in blue in the LU Path tree.



7. In the LUN Management main pane, click **Apply**. A confirmation message appears.

8. Click **OK**. The settings are applied to the disk array.

The next step is to register hosts to the appropriate host group.

**Table 35** Host mode options

Host mode option	When to select option
2	When VERITAS Database Edition/Advanced Cluster for Real Application Clusters or VERITAS Cluster Server 4.0 (I/O fencing function) is used
7	When all the following conditions are satisfied: <ul style="list-style-type: none"><li>• The host mode <b>00 Standard</b> or <b>09 Solaris</b> is used</li><li>• SUN StorEdge SAN Foundation Software Version 4.2 or later is used</li><li>• You want to automate recognition of increase and decrease of devices when a genuine SUN HBA is connected</li></ul>
12	When all the following conditions are satisfied: <ul style="list-style-type: none"><li>• The host mode <b>03 HP</b> is used</li><li>• You want to suppress creation of device files for devices to which the paths are not defined</li></ul>
14	When all the following conditions are satisfied: <ul style="list-style-type: none"><li>• The host mode <b>07 Tru64</b> is used</li><li>• You want to use TruCluster to set a cluster to TrueCopy P-VOL and S-VOL, respectively</li></ul>



**CAUTION:** Do not select options other than those listed in [Table 35](#).

## Registering hosts in host groups



**NOTE:** If you are configuring a NAS environment (XP128/XP1024 only), skip this section.

Before you can set LU paths, you must register hosts in host groups. For example, if HP-UX and Windows hosts are connected to a port, you must register them separately in two different host groups.

When registering a host, you can assign a nickname to the host bus adapter. If you assign a nickname, you will be able to easily identify each host bus adapter in the LUN Management main pane. Although WWNs (or iSCSI names) are also used to identify each host bus adapter, a nickname is more helpful because you can name host bus adapters after the host installation site or the host owners.

When using nicknames, note the following:

- A nickname can consist of up to eight ASCII characters (letters, numerals, and symbols). You cannot use the following characters for nicknames:

`\ / : , ; * ? " < > | ~`

- You cannot use the space character for the first or the last nickname character.
- Nicknames are case sensitive. For example, `hp` and `HP` are different nicknames.

## To register hosts in a host group:

1. In the LU Path tree, locate the port the host group belongs to and verify that LUN security is enabled.



**NOTE:** If the port icon has a key , LUN security is enabled.

If LUN security is not enabled, right-click the port and select **LUN Security: OFF->ON** (XP128/XP1024) or **Disable->Enable** (XP12000) in the shortcut menu.

2. If the desired host has never been connected via a cable to another port in the disk array, skip to step 8.
3. In the Port list on the upper right corner of the WWN table (Fibre Channel) or the iSCSI name table (iSCSI environment), select the port to which the desired host is connected.
4. Select the desired host bus adapter from the WWN (or iSCSI Name) table.
5. Select a host group from the tree and click the **Add WWN** (or **Add iSCSI Name**) button. The Add New WWN (Fibre Channel) or Add New iSCSI Name (iSCSI) dialog box appears.

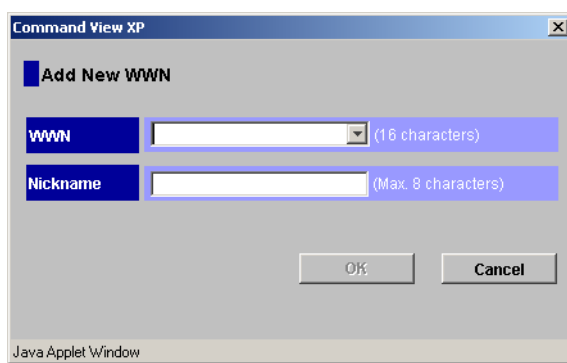

**Figure 98** Add New WWN dialog box (Fibre Channel)

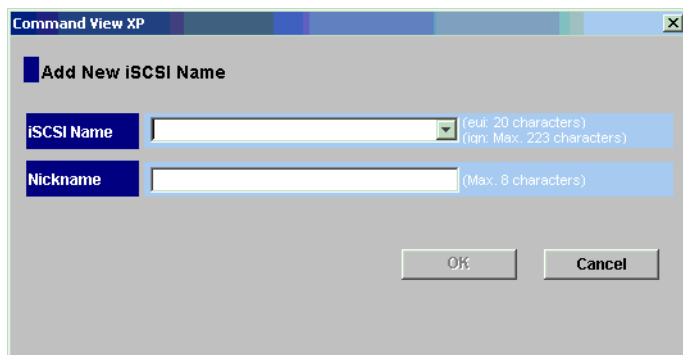
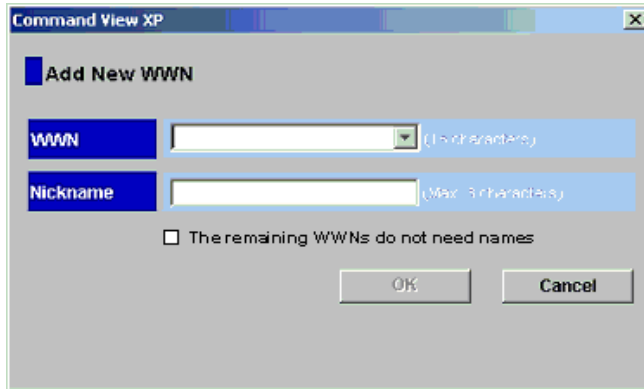

**Figure 99** Add New iSCSI Name dialog box (iSCSI)

6. To assign a nickname to the host bus adapter, enter the nickname in the **Nickname** box and click **OK**.



**NOTE:** If two or more host bus adapters are selected, the Add New WWN (or Add New iSCSI) dialog box displays repeatedly to let you assign a nickname to each selected HBA (see [Figure 100](#) and [Figure 101](#)). If you do not need to assign nicknames to HBAs, enable the **The remaining WWNs (iSCSI Names) do not need names** check box and click **OK**. If you select this option, the Add New WWN (Add New iSCSI Name) dialog box will not prompt you for additional nicknames.



**Figure 100** Add New WWN dialog box (when registering a host that has previously been connected to the disk array)

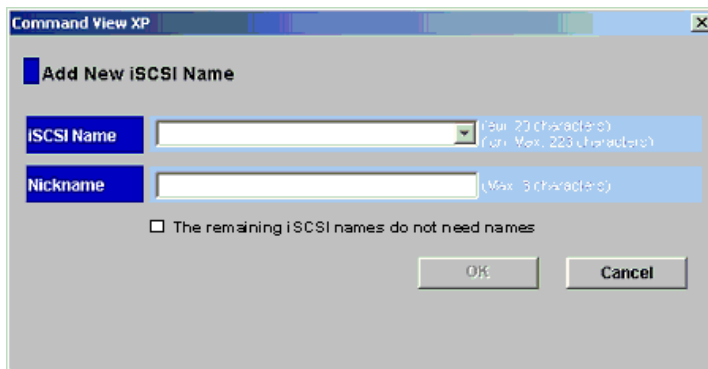

**Figure 101** Add New iSCSI Name dialog box (when registering a host that has previously been connected to the disk array)

7. Skip to [step 11](#). If the desired host has never been connected via a cable to any port in the array, only [step 8](#) through [step 10](#) apply.
8. Right-click the host group and select **Add New WWN** (Fibre Channel) or **Add New iSCSI Name** (iSCSI environment). The Add New WWN (or Add New iSCSI Name) dialog box appears ([Figure 98](#) for Fibre Channel and [Figure 99](#) for iSCSI).
9. Select the desired host bus adapter from the WWN/iSCSI name list. If the host bus adapter is not in the list, enter the **WWN (iSCSI name)** in the box.
10. If necessary, enter a nickname for the host bus adapter.
11. Click **OK**. The new WWN (iSCSI Name) and nickname appear below the selected host group in the LU Path tree.
12. Click **Apply** in the LUN Management main pane. A confirmation message appears.
13. Click **OK**. The settings are applied to the disk array.



**NOTE:** For Fibre Channel environments only: If the WWN table (located in the lower-left corner of the pane) includes a host that you want to register, you can register the host by selecting the host group in the LU Path tree, selecting the host from the WWN table, and then clicking **Add WWN**.

## Associating host groups to logical volumes

You can use LUN Management to define LU paths by associating host groups to logical volumes. For example, if you associate a group of three hosts with logical volumes, LU paths are defined between the three hosts and the logical volumes.

1. In the LU Path tree on the LUN Management main pane, select a host group.



**NOTE:** If you are configuring a NAS environment, you must select the User host group.

2. In the **CU** list above the LDEV table, select a CU number. The LDEV table shows LDEVs in the CU.
3. In the LDEV table, select one or more LDEVs. Press the **Ctrl** key to select multiple LDEVs.
4. In the LU Path table, select the LUs.
5. Click **Add LU Path**. A dialog box prompts you to confirm the LU Paths to be defined.

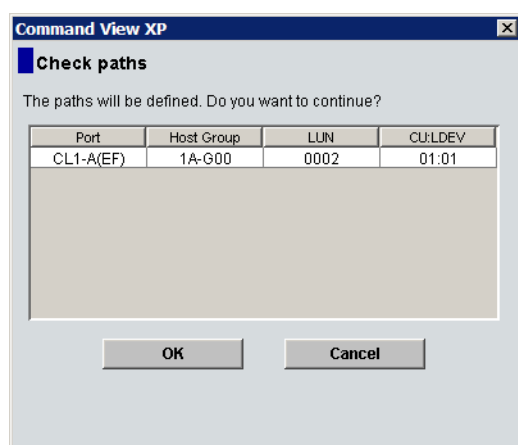

**Figure 102** Check paths dialog box

6. Click **OK**. The settings are shown in blue in the LU Path table.
7. Click **Apply** in the LUN Management main pane. A confirmation message appears.
8. Click **OK**. The settings are applied to the disk array.

## Changing or viewing LU path settings

### Deleting LU paths

1. In the LU Path tree on the LUN Management main pane, select a port.
2. In the LU Path table, select one or more LUNs to which LDEVs are assigned (If an LDEV is assigned to a LUN, the columns to the right of the LUN column are not empty).

3. Right-click the selected port and select **Release LU Path**. A dialog box displays information about the LU Paths to be deleted.

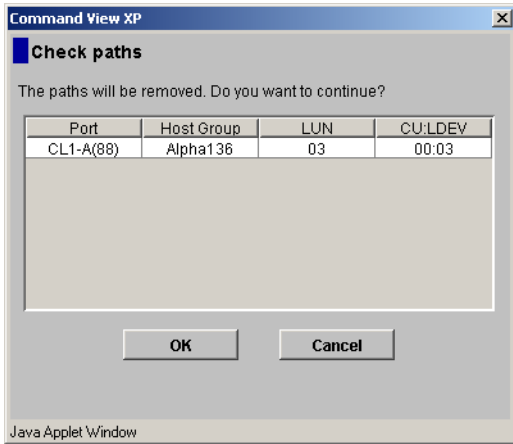

**Figure 103** Confirm path deletion

4. Click **OK**. The settings are shown in blue in the LU Path table.
5. Click **Apply** in the LUN Management main pane. A confirmation message appears.
6. Click **OK**. The settings are applied to the disk array.

## Changing the name and host mode of a host group

Before changing the host mode of a host group, back up the data on the host group's port. The operation for changing host mode should not be destructive, but data integrity cannot be guaranteed without a backup.

To change the host mode for host group 0, port security can be enabled or disabled. For all other host groups, you must enable port security before changing the host mode.



**NOTE:** You cannot perform this operation on host groups for NAS ports.

1. In the LU Path tree on the LUN Management main pane, right-click the host group and select **Change Host Group**. The Change Host Group dialog box appears.

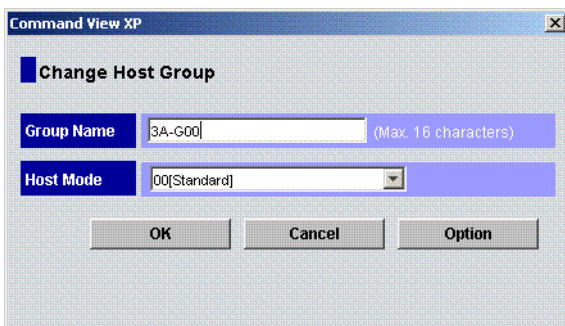

**Figure 104** Change Host Group dialog box



**NOTE:** After you select the **Option** button, the pane expands to display check boxes. The check boxes are numbered sequentially from left to right. The leftmost check box on the upper row is #0, and the check box immediately to the right is #1, and so on. The numbers indicate option numbers; select check box #0 to select option #0.

2. To change the name of the host group, enter a new name in the **Group Name** box.
3. To change the host mode, select the new host mode from the **Host Mode** list.
4. If necessary, select **Option**, and select the host mode options. For detailed information about host mode options, see [Table 35](#).
5. Click **OK**. The settings are shown in blue in the LU Path table.
6. Click **Apply** in the LUN Management main pane. A confirmation message appears.
7. Click **OK**. The settings are applied to the disk array.

## Deleting host groups

You cannot delete the host group 0 (zero). If you want to remove all the WWNs and LU paths from the host group 0, you must initialize the host group 0 ("[Initializing the host group 0 \(zero\)](#)" on page 209).



**NOTE:** You cannot perform this operation on host groups for NAS ports.

1. In the LU Path tree on the LUN Management main pane, right-click a host group and select **Delete Host Group**. A confirmation message appears.
2. Click **Yes** to delete the host group. The host group you specified is removed from the LU Path tree.
3. Click **Apply** in the LUN Management main pane. A confirmation message appears.
4. Click **OK**. The settings are applied to the disk array.

## Initializing the host group 0 (zero)

Initializing the host group 0 sets the group to its default state. This process:

- Removes all the WWNs from the host group 0 and all the LU paths related to the host group 0.
- Changes the host mode of the host group 0 to Standard and initializes the host group name. For example, if you initialize the host group 0 for the port CL1-A, the name of the host group 0 will change to 1A-G00.



**NOTE:** You cannot perform this operation on host groups for NAS ports.

1. In the LU Path tree on the LUN Management main pane, right-click the host group 0 and select **Clear Host Group**. A confirmation message appears.
2. Click **Yes**.
  - The host mode and host group name are changed in the LU Path tree.
  - WWNs are removed from host group 0.
  - LU paths are removed from the LU Path table.
  - The LUNs corresponding to the removed LU paths are shown in blue.
3. Click **Apply** in the LUN Management main pane. A confirmation message appears.
4. Click **OK**. The settings are applied to the disk array.

## Changing WWNs, iSCSI names, and nicknames

1. In the LU Path tree, locate the port the HBA is connected to and verify that LUN security is enabled.



**NOTE:** If the port icon has a key , LUN security is enabled.

If LUN security is not enabled, right-click the port and select **LUN Security: OFF->ON** (XP128/XP1024) or **Disable->Enable** (XP12000) in the shortcut menu.

2. In the LU Path tree, right-click the WWN or iSCSI Name and select **Change WWN & Nickname** or **Change iSCSI Name & Nickname**. The Change WWN & Nickname or Change iSCSI Name & Nickname dialog box appears.

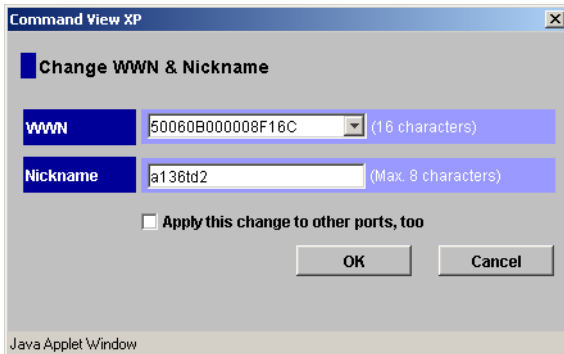

**Figure 105** Change WWN & Nickname dialog box

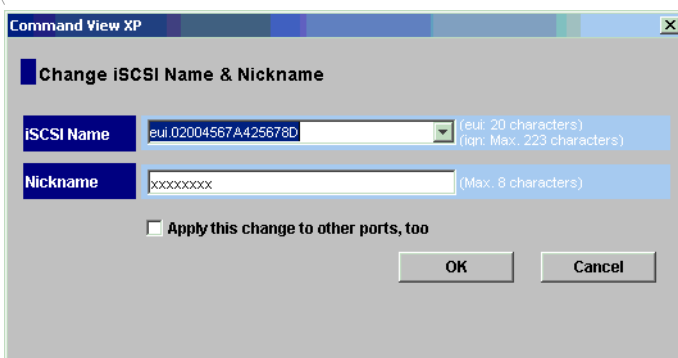

**Figure 106** Change WWN & Nickname dialog box

If the selected WWN or iSCSI name is not registered in a host group, [Figure 105](#) or [Figure 106](#) is not displayed.

3. Enter the WWN or iSCSI appropriate box, or select it from the list.
4. In the **Nickname** box, enter the new nickname.
5. If necessary, select the **Apply this change to other ports, too** check box.

If this check box is selected, the change will affect other ports. For example, if you select a host bus adapter located beneath ports CL1-A and CL2-A in the tree, and you change the host bus adapter name under port CL1-A, the host bus adapter will also be renamed under port CL2-A.



**NOTE:** The change in the pane will *not* affect any port that satisfies at least one of the following conditions:

- LUN security is OFF.
- The resulting nickname is already used as the nickname of a host bus adapter connected to the port.
- The resulting nickname is already used as the name of a *host group* (i.e. a *host storage domain*) in the port.



- The resulting WWN or iSCSI name exists in the port.

6. Click **OK**.

The changes you made are shown in blue. If you selected the **Apply this change to other ports, too** check box, the **Check WWNs** (or **Check iSCSI names**) dialog box appears. To accept the changes to the other ports, click **OK**.

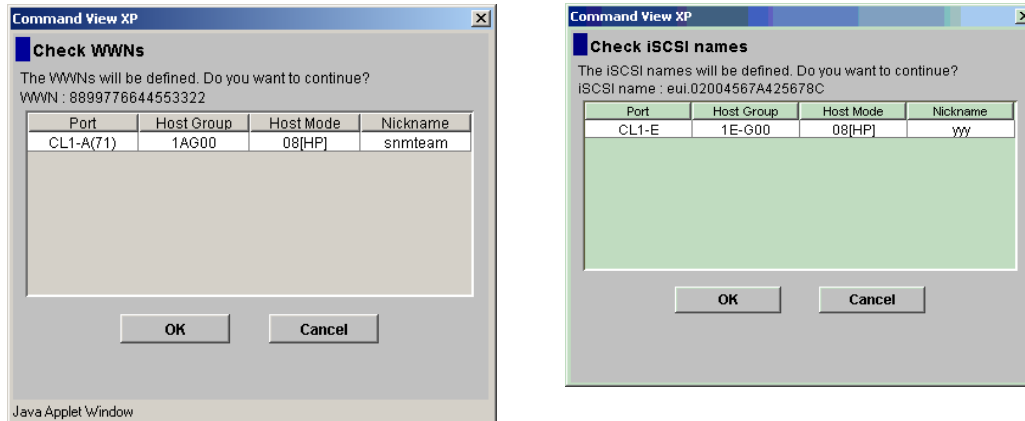

**Figure 107** Check WWNs / Check iSCSI names

7. Click **Apply** in the LUN Management main pane. A confirmation message appears.
8. Click **OK**. The settings are applied to the disk array.

## Deleting HBAs from host groups



**NOTE:** You cannot perform this operation on host groups for NAS ports.

1. In the LU Path tree, right-click the HBA and select **Delete WWN** (or **Delete iSCSI Name**). A confirmation message appears.
2. Click **Yes**. The WWN or (iSCSI name) you specified is removed from the LU Path tree.
3. Click **Apply** in the LUN Management main pane. A confirmation message appears.
4. Click **OK**. The settings are applied to the disk array.

## Deleting unneeded WWNs from the WWN table

If you disconnect a host that has been connected through a cable to your disk array, the WWN for the host remains in the WWN table until you remove it.

1. In the WWN table, locate the WWN that is not registered in any host group.



**NOTE:** If the Host Group column is blank, the WWN is not registered in any host group.

2. Right-click the WWN and select **Erase WWN**.
3. Click **Apply** in the LUN Management main pane. A confirmation message appears.
4. Click **OK**. The settings are applied to the disk array.

## Viewing a list of concatenated parity groups

The XP128/XP1024 supports concatenation of parity groups. If parity groups are concatenated, a logical volume can be dispersed across the concatenated parity groups. Dispersal of logical volumes can provide faster access to data (particularly, faster sequential access to data).

1. In the LDEV table, right-click a logical volume (an LDEV).  
If the parity groups are concatenated, the **Concatenation List** command is available in the shortcut menu.
2. Select **Concatenation List**. The Concatenation List dialog box appears.
3. Click **OK** to return to the LUN Management main pane.

## Defining alternate paths

LUN Management can define alternate paths. If an LU path fails, you can switch to its alternate path.

To create an alternate path, copy the original path from one port to another. For example, to define an alternate for the LU path between the CL1-A port and logical volume 00:01, copy the LU path from the CL1-A port to another port.

If you want to define alternate paths when LUN security is removed, you must redefine the LU path.

**Table 36** Copying LU paths

To copy paths...	See...
from one iSCSI or Fibre Channel port to another	"Copying paths from one Fibre Channel or iSCSI port to another" on page 212
from one NAS port to another	"Copying paths from one NAS port to another (XP128/XP1024 only)" on page 213
from a Fibre Channel or iSCSI port to a NAS Port	"Copying paths from a Fibre Channel or iSCSI port to a NAS port" on page 213
from a NAS Port to a Fibre Channel or iSCSI Port	"Copying paths from a NAS port to a Fibre Channel or iSCSI port" on page 214

## Copying paths from one Fibre Channel or iSCSI port to another



**CAUTION:** Before performing the following steps, see "[Restrictions on port operations](#)" on page 230 for important information.

1. In the LU Path tree, locate the port that you want to use as the copy destination and verify that LUN security is enabled.



**NOTE:** If the port icon has a key , LUN security is enabled.

If LUN security is not enabled, right-click the port and select **LUN Security: OFF->ON** (XP128/XP1024) or **Disable->Enable** (XP12000) in the shortcut menu.

2. To copy all the LU paths defined to a host group, complete the following steps. To copy some LU paths, skip to [step 3](#).
  - a. Right-click a host group in the tree and select **Copy**. The selected host group turns green.
  - b. Right-click the copy destination port and select **Paste**.

3. To copy some, but not all of the LU paths defined to a host group, complete the following steps. To copy all LU paths, see [step 2](#).
  - a. Select a host group in the LU Path tree.
  - b. In the LU Path table, select one or more LUNs to which volumes are assigned.
  - c. Right-click the selection and select **Copy Paths** in the shortcut menu. The selected LUNs turn green.
  - d. Double-click the copy destination port.
  - e. Right-click the copy destination host group and select **Paste Paths**.
4. Click **Apply** in the LUN Management main pane. A confirmation message appears.
5. Click **OK**. The settings are applied to the disk array.

## Copying paths from one NAS port to another (XP128/XP1024 only)

---

 **CAUTION:** Before performing the following steps, see “[Restrictions on port operations](#)” on page 230 for important information.

---

1. Specify the LU paths to copy:
  - a. In the LU Path tree, double-click a **NAS** port (the copy source port) and select the **User** host group.
  - b. In the LU Path table, select one or more LUNs to which volumes are assigned.

---

 **NOTE:** If a volume is assigned to a LUN, the columns on the right of the LUN column are not empty.

---

- c. Right-click the selected LUNs and select **Copy Paths**. The selected LUNs turn green.
2. Paste the LU paths:
  - a. In the LU Path tree, double-click the copy destination port (a NAS port) to display the **User** host group below the port.
  - b. Right-click the **User** host group and select **Paste Paths**.
3. Click **Apply** in the LUN Manager tab. A confirmation message appears.
4. Click **OK**. The settings are applied to the disk array.

## Copying paths from a Fibre Channel or iSCSI port to a NAS port

---

 **CAUTION:** Before performing the following steps, see “[Restrictions on port operations](#)” on page 230 for important information.

---

1. Specify the LU paths to copy:
  - a. In the LU Path tree, double-click a Fibre Channel or iSCSI port (the copy source port) and then select a host group. The LU Path table displays LU path information.
  - b. In the table, select one or more LUNs to which volumes are assigned.

---

 **NOTE:** If a volume is assigned to a LUN, the columns on the right of the LUN column are not empty.

---

- c. Right-click the selected LUNs and select **Copy Paths**. The selected LUNs turn green.

2. Paste the LU paths:
  - a. In the LU Path tree, double-click a NAS port (the copy destination port) to display the **User** host group.
  - b. Right-click the **User** host group and select **Paste Paths**.
3. Click **Apply** in the LUN Manager tab. A confirmation message appears.
4. Click **OK**. The settings are applied to the disk array.

## Copying paths from a NAS port to a Fibre Channel or iSCSI port



**CAUTION:** Before performing the following steps, see “[Restrictions on port operations](#)” on page 230 for important information.

1. Specify the LU paths to copy:
  - a. In the LU Path tree, double-click a NAS port (the copy source port) and select the **User** host group.
  - b. In the LU Path table, select one or more LUNs to which volumes are assigned.



**NOTE:** If a volume is assigned to a LUN, the columns on the right of the LUN column are not empty.

- c. Right-click the selected LUNs and select **Copy Paths**. The selected LUNs turn green.
2. In the LU Path tree, locate the Fibre Channel or iSCSI port that you want to use as the copy destination and verify that LUN security is enabled on the port.



**NOTE:** If the port icon has a key , LUN security is enabled.

If LUN security is not enabled, right-click the port and select **LUN Security: OFF->ON** (XP128/XP1024) or **Disable->Enable** (XP12000) in the shortcut menu.

3. Paste the LU paths:
  - a. Double-click the Fibre Channel or iSCSI port (the copy destination port) to display host groups below the port.
  - b. Right-click the host group to which you want to paste paths and select **Paste Paths**.
4. Click **Apply** in the LUN Manager tab. A confirmation message appears.
5. Click **OK**. The settings are applied to the disk array.

## Viewing alternate paths

1. From the LUN Management main pane, do one of the following:
  - In the LU Path table, select a LUN containing one or more paths.
  - In the LDEV table, select an LDEV containing one or more paths.

2. Right-click the selection and select **Alternate Paths**. The Alternate Paths dialog box appears.

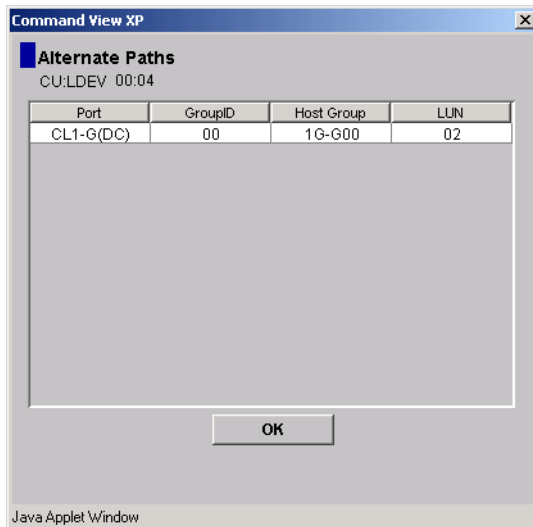

**Figure 108** Alternate Paths dialog box

3. Click **OK**.

## Deleting WWNs



1. In the LU Path tree, right-click a WWN and select **Delete WWN**. A confirmation message appears.



**NOTE:** If the selected WWN is not registered in a host group, the **Delete WWN** command is not available.

2. Click **Yes**. The selected WWN is no longer listed in the LU Path tree.
3. Click **Apply** in the LUN Management main pane. A confirmation message appears.
4. Click **OK**. The settings are applied to the disk array.

## Applying and removing LUN security

By default, LUN security is not applied to any ports. When configuring your system, you must apply LUN security to the ports. If a port has the External attribute, you cannot apply LUN security to the port. The  icon indicates a port without LUN security and changes to a  icon when LUN security is applied.





**NOTE:** You cannot apply LUN security to NAS ports.

1. Right-click a port in the LU Path tree.
  - a. To apply LUN security, select **LUN Security: OFF->ON** (XP128/XP1024) or **Disable->Enable** (XP12000). A confirmation message appears.
  - b. To remove LUN security, select **LUN Security: ON->OFF** (XP128/XP1024) or **Enable->Disable** (XP12000). A confirmation message appears.
2. Click **Yes**. The changes are shown in blue.
3. Click **Apply** in the LUN Management main pane. A confirmation message appears.
4. Click **OK**. The settings are applied to the disk array.

# Creating RAID Manager Command Devices

To enter RAID Manager commands, set up at least one LU as a command device.

The  icon indicates an LDEV that is not a command device and changes to a  icon when set to a command device. When security is enabled, the icon changes to .



## CAUTION:

- If a path is defined between an iSCSI port and a logical device, you cannot use the logical device as a command device.
- You cannot define paths between iSCSI ports and command devices.

## Setting an LU as a command device

1. In the LU Path tree, double-click a port and then select a host group.
2. In the LU Path or LDEV table, right-click the LUN and select **Command Device: OFF->ON**. A confirmation message appears.



**NOTE:** If the shortcut menu includes the item **Command Device: ON->OFF**, the logical device is already specified as a command device and you do not need to complete this procedure.

3. Click **Yes**. The changes are shown in blue.
4. Click **Apply** in the LUN Management main pane. A confirmation message appears.
5. Click **OK**. The settings are applied to the disk array.

### Stopping the use of an LU as a command device

Right-click the command device and select **Command Device: ON->OFF**.

### Applying command device security

Right-click the command device and select **Cmd. Dev. Security: OFF->ON**.

### Removing command device security

Right-click the command device and select **Cmd. Dev. Security: ON->OFF**.

## Port Operations

Use the **Port** tab in the LUN Management pane to configure Fibre Channel and iSCSI ports in your disk array. You can also use this pane to modify the port configuration when the disk array is operating.



**NOTE:** You cannot use the **Port** tab to make settings on NAS ports.

## Starting Port Operations

1. From the Device Launcher pane, click an XP128/XP1024/XP12000 link.
2. Click **LUN Manager** in the left pane. The LUN Manager pane appears.

3. Click the **Port** tab. The Port pane appears.

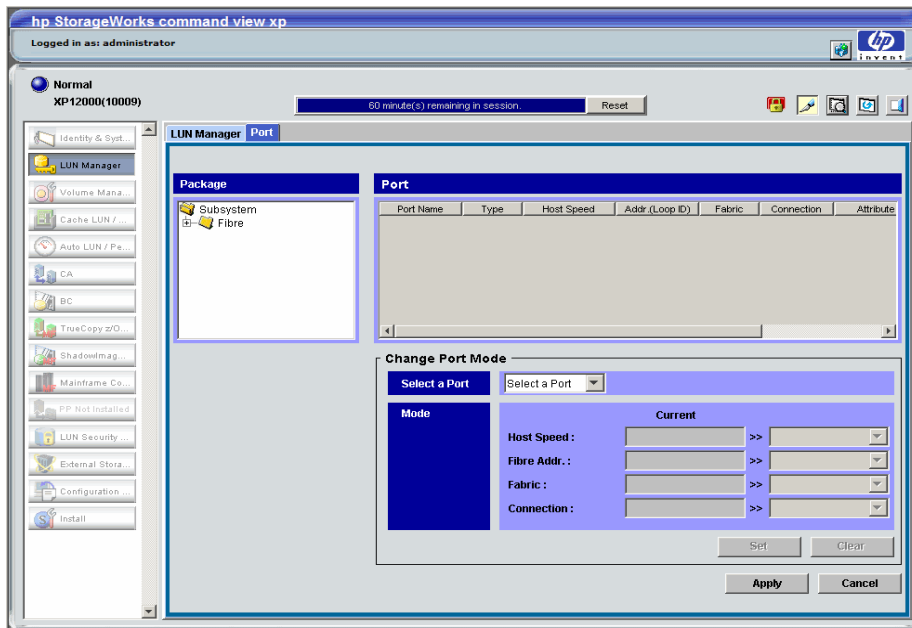

**Figure 109** Port pane

## Port tab

The Port tab includes the package tree, port table, and change port mode box.

## Package tree

The Package tree lists all Fibre Channel and iSCSI channel adapter (CHA) packages. When you right-click a CHA package, you can choose standard mode, high-speed mode, or high-speed (2 port) mode.



**NOTE:** High-speed (2 port) mode is available only if the XP disk array has firmware version 21.06.22 or later installed.

The following icons are used to indicate status:

**Table 37** Channel adapter package icons for Port operations

Icon	Status
	A short-wave CHA package in standard mode (Fibre Channel) <b>or</b> A short-wave iSCSI CHA package
	A long-wave CHA package in standard mode
	A short-wave CHA package in high-speed or high-speed (2 port) mode
	A long-wave CHA package in high-speed or high-speed (2 port) mode

## Port table

The Port table displays information about the ports in the selected CHA packages. The information in this table differs depending on the type of channel adapter package selected in the tree.

The table lists the following for Fibre Channel CHA packages:

- **Port Name:** Displays port names
- **Type:** Fibre indicates a Fibre Channel port, used for connecting open system hosts. MF-Serial indicates an ESCON port, used for connecting mainframe hosts.
- **Host Speed:** Specifies the data transfer speed for Fibre Channel ports. If Auto is selected, the disk array automatically sets the data transfer speed to 1 GB/sec or 2 GB/sec.
- **Addr (Loop ID):** Displays addresses of ports. You can change port addresses.
- **Fabric:** Specify ON if a fabric switch is used, or OFF if no fabric switch is used
- **Connection:** Specifies the topology. The default is FC-AL. Some fabric switches require you to specify point-to-point topology. Check the switch's documentation.
- **Attribute:** Indicates whether the port is an initiator port, a target port, an RCU target port, or an external port
- **WWN:** Displays WWNs of ports.

The table lists the following for iSCSI CHA packages:

- **Port Name:** Displays iSCSI port names
- **IP Address:** Displays the iSCSI port IP addresses
- **Subnet Mask:** Displays subnet masks
- **Gateway:** Displays gateway addresses
- **iSCSI Name:** Displays iSCSI port names
- **iSCSI Alias:** Displays iSCSI port aliases
- **Port Number:** Displays iSCSI port numbers
- **Keep Alive Timer:** Displays the keep-alive timer values in seconds
- **INS Server:** Indicates whether you can register the iSCSI port in the ISNS server
  - **Enable:** You can register the iSCSI port
  - **Disable:** You cannot register the iSCSI port
- **iSNS IP Address:** Displays the IP address of the ISNS server
- **iSNS Port No:** Displays the TCP port number of the iSNS server
- **MAC Address:** Displays the iSCSI port media access control (MAC) addresses
- **Attribute:** Indicates the port attribute (always set to Target for iSCSI ports)
- **iSCSI Function box:** Enables you to perform iSCSI-related operations

## iSCSI Function box

Use this box to perform iSCSI-related operations.

- **Ping:** Issues a ping command from an iSCSI port to a host



- **Register:** Registers iSCSI port information (such as IP addresses and iSCSI names) in the iSNS server
- **Delete:** Removes iSCSI port information (such as IP addresses and iSCSI names) from the iSNS server

## Change Port Mode box

Use this box to change information in the Port table.

## Setting the Fibre Channel Topology

1. In the Port table or the Select a Port list, select a Fibre Channel port.
2. If a fabric switch is used, select **ON** in the Fabric list in the Mode area. If a fabric switch is not used, select **OFF** in the Fabric list.
3. In the **Connection** list, select **FC-AL** or **P-to-P**.  
If a fabric switch is used, consult the switch documentation to check if it requires point-to-point topology.
4. Click **Set**. A confirmation message appears.
5. Click **OK**. The settings are applied to the Port table (shown in blue), but not to the disk array.
6. Click **Apply**. A confirmation message appears.
7. Click **OK**. The settings are applied to the disk array.

## Setting Fibre Channel Port Addresses

1. In the Port table or the Select a Port list, select a Fibre Channel port.
2. In the Fibre Address list in the Mode area, select an address.
3. Click **Set**. A confirmation message appears.
4. Click **OK**. The settings are applied to the Port table (shown in blue), but not to the disk array.
5. Click **Apply**. A confirmation message appears.
6. Click **OK**. The settings are applied to the disk array.

## Setting the Data Transfer Speed

1. In the Port table or the Select a Port list, select a Fibre Channel port.
2. In the Host Speed list in the Mode area, select a data transfer speed.
3. Click **Set**. A confirmation message appears.
4. Click **OK**. The settings are applied to the Port table (shown in blue), but not to the disk array.
5. Click **Apply**. A confirmation message appears.
6. Click **OK**. The settings are applied to the disk array.

## Switching to standard, high-speed, or high-speed (2 port) mode

Channel adapter boards can be set for standard mode, high-speed, or high-speed (2 port) mode. If possible, apply high-speed mode to channel adapters to improve the system performance. Be aware that you can only apply high-speed or high-speed (2 port) mode to channel adapters that satisfy certain requirements.



**NOTE:** High-speed (2 port) mode is available only if the XP disk array has firmware version 21.06.22 or later installed (XP128/XP1024 only).

---

1. In the Package tree on the Port pane, right-click a channel adapter (CHA) package. A shortcut menu appears. The current mode is preceded by a bullet.
2. Select the mode that you want. A confirmation message appears.
3. Click **OK**.
4. Click **Apply**. A confirmation message appears.
5. Click **OK**. The settings are applied to the disk array.

## Configuring iSCSI Ports

1. In the Port table or the Select a Port list on the Port pane, select an iSCSI port.  
The current configuration of the iSCSI port appears below the **Select a Port** list.
2. To configure the port, edit the items below the list. For detailed information about the items, see ["iSCSI port settings and iSNS server settings"](#) on page 191.



**NOTE:** Use the vertical scroll bar to view all the items (some of the items are hidden).

3. Click **Set**. A confirmation message appears.
4. Click **OK**. The settings are applied to the Port table (shown in blue), but not to the disk array.
5. Click **Apply**. A confirmation message appears.
6. Click **OK**. The settings are applied to the disk array.

## Making settings on iSCSI ports and iSNS servers

Use the Port tab of the LUN Management pane to configure iSCSI ports in your disk array, make settings on iSNS servers, and modify settings when the system is in operation.

1. Ensure that the Command View main pane is in Modify mode. For more information, see ["Device Launcher"](#) on page 47.
2. In the LUN Manager pane, select the **Port** tab.
3. In the Package tree view, click the iSCSI folder. The Port table displays a list of iSCSI ports in the disk array.



**TIP:** If you specify a channel adapter in the Package tree view, the Port table displays only the ports in the specified channel adapter.

4. Select an iSCSI port from the Port table or the **Select a Port** drop-down list. The current configuration of the iSCSI port is displayed below the **Select a Port** drop down list.



**NOTE:** Use the vertical scroll bar to view all the items.

5. Edit the items below the drop-down list.
6. Click **Set**. A message appears asking if you want to change the port settings.
7. Click **OK** to close the message. Settings are applied to the Port table, but not to the disk array.
8. Click **Apply**. A message appears asking if you want to apply the setting to the disk array.
9. Click **OK** to close the message. Settings are applied to the disk array.



---

**NOTE:** If a message appears prompting you to register the iSCSI port, click **Yes**. If the registration process finishes, a pane appears indicating if the registration ended successfully. If the registration ended successfully, the pane displays **Success**. If the registration failed, the pane displays the error code and error message. Resolve the error and retry registration by clicking **Register** in the **iSCSI Function** box in the Port tab.

---

## Removing information about an iSCSI port from an iSNS server

1. In the Port tab, click **Delete** in the **iSCSI Function** box. The Delete iSNS Information pane appears.
2. Select an iSCSI port from the **Subsystem Port Name**. The IP address of the iSNS server appears in the **iSNS Server IP Address**. Also, the port number of the iSNS server appears in the **iSNS Server Port Number**.
3. Click **OK**. Information about the iSCSI port is removed from the iSNS server, and the iSCSI port is unregistered from the iSNS server.

---

## Checking the status of connection between hosts and the disk array (iSCSI environment only)

In an iSCSI environment, use LUN Management to issue a ping command from a disk array port to a host. The ping command checks whether the host and disk array can communicate with each other. If the host responds to the ping command, the host and disk array can communicate with each other.

## Issuing a ping command from an iSCSI port to a host

1. Ensure that the Port tab is displayed in the pane.
2. Click **Ping** below the Package tree view. The Ping pane appears.
3. Select an iSCSI port from **From (Subsystem Port)**.
4. Enter the IP address of the host in **To (IP Address)**.
5. Click **OK**. A ping command is issued from the iSCSI port to the host five times. After the ping command is issued five times, the Ping Result pane appears and displays the results in the order attempts were made.
  - If the host responded to the ping command, the **Status** column displays **Success**.
  - If the host did not respond to the ping command, the **Status** column displays **Error**.
  - The **Success Rate** field displays the success rate of the ping command. If the host responds to each of the five ping attempts, the success rate is 100 percent. If the host responds three times out of five ping attempts, the success rate is 60 percent.
6. Click **OK** to close the Ping Result pane.
7. To issue a ping command, return to [step 3](#). Otherwise, click **Cancel** to close the Ping window.



---

**TIP:** You can issue a ping command from an iSCSI port to an iSNS server. To verify connectivity between an iSNS server and disk array, issue a ping command to the iSNS server. If the iSNS responds to the ping command, the iSNS server and disk array can communicate with each other.

---

# Setting user authentication (iSCSI environments only)

When configuring an iSCSI environment, you can use the User Authentication tab to set the user authentication on disk array ports. First specify whether to perform authentication of hosts for each port. Then register user information of hosts on the ports that perform authentication. This setting determines whether ports can authenticate hosts that request to connect, and can restrict the connections. In addition, if you want to implement mutual authentication, specify user information about each disk array port.



**NOTE:** The hosts to be connected must also be configured for authentication by ports (and for port authentication by the host, if required). For details on how to configure the host for CHAP authentication, refer to your operating system and iSCSI driver documentation.

## Starting User Authentication Operations



**NOTE:** User authentication can be performed in an iSCSI environment only.

1. From the Device Launcher pane, click an XP128/XP1024/XP12000 link.
2. Click the **LUN and Volume Mgmt** tab, and then click the **LUN Management** button (🔑). The LUN Management main pane appears.
3. Click the **User Authentication** tab. The User Authentication pane appears.

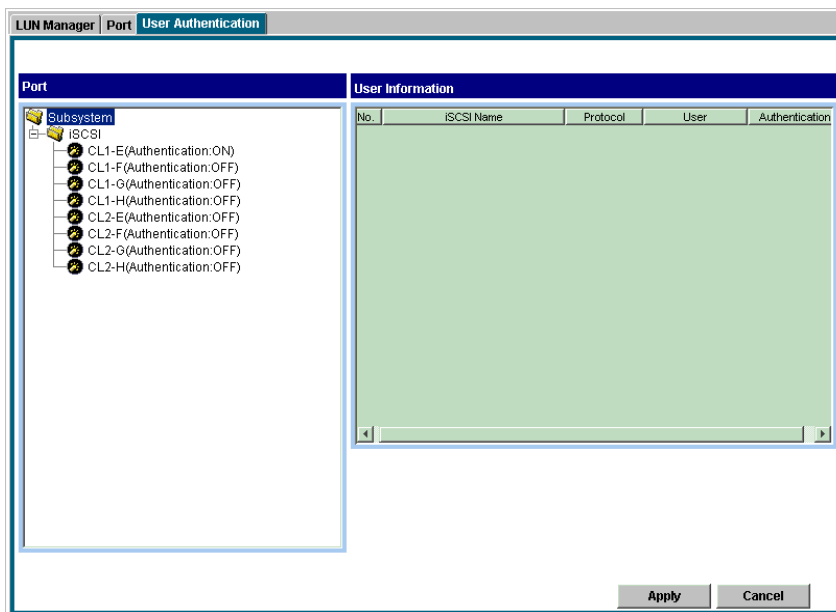

Figure 110 User Authentication tab (LUN Management pane)

## User Authentication tab

The User Authentication tab includes the port tree and User Information (Host) table.

### Port tree

This tree displays information about user authentication on each port. When you select a port from this tree, the User Information (Host) table on the right displays user information of hosts registered on the

port. In addition, the User Information (Port) table below the User Information (Host) table displays user information of the selected port.

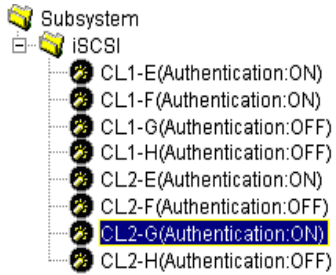

**Figure 111** iSCSI folder in the Port tree

The iSCSI folder appears below the Subsystem folder located at the top of the tree. If you double-click the iSCSI folder, iSCSI ports in the disk array appear as icons. The port name and user authentication status to the right of each icon:



- (Authentication:ON): the port performs host authentication
- (Authentication:OFF): the port does not perform host authentication. This is the default value.



**NOTE:** The **iSCSI** folder is displayed only if the disk array contains an iSCSI channel adapter.

The following icons are used to indicate the port's user authentication status:

**Table 38** iSCSI port icons for User Authentication operations

Icon	Status
 CLX-Y (Authentication:ON)	The port authenticates hosts
 CLX-Y (Authentication:OFF)	The port does not authenticate hosts

## User Information (Host) table

The User Information (Host) table, on the top right of the User Authentication tab, displays user information of hosts that are allowed to connect to the iSCSI port specified in the tree. You can register up to 64 user information items in this table.

The table contains the following columns:

- **iSCSI Name:** Displays iSCSI names of host bus adapters.
- **Protocol:** Indicates the user authentication protocol. This is always equal to `CHAP`.
- **User:** Indicates user names of hosts. When no user name is defined, this column is blank.
- **Authentication:** Indicates whether to perform authentication for the host. If the host is a target of user authentication, `Enable` appears. If the host is not a target of user authentication, `Disable` appears.

## User Information (Port) table

The User Information (Port) table, on the bottom right of the User Authentication tab, displays user information of the port selected in the tree.

The table contains the following columns:

- **iSCSI Name:** Displays the iSCSI name of the port.
- **User:** Indicates the user name of the port. When the user name is not defined for a port, this column is left blank. If you use upgraded LUN Management and the port performed host authentication before upgrading, *Administrator* appears as the default.

## Buttons

- **Apply:** Applies settings in the pane to the disk array.
- **Cancel:** Cancels settings in the pane.

## Specifying whether to enable or disable host authentication on a port

You can specify whether to perform host authentication on each port. By default, user authentication is disabled.

1. In the Port tree on the User Authentication tab, double-click the **Subsystem** folder.  
If the disk array contains any iSCSI channel adapters, the iSCSI folder appears below the Subsystem folder.
2. Double-click the **iSCSI** folder.
3. Right-click an iSCSI port that is displayed with `(Authentication:OFF)`.
4. Select **Authentication: OFF -> ON**.  
The `(Authentication:OFF)` displayed on the right of the port name changes to `(Authentication:ON)`, and the port name and `(Authentication:ON)` are displayed in blue.
5. Click **Apply**. A confirmation message appears.
6. Click **OK**. The setting is applied to the disk array.



---

**NOTE:** To disable authentication on a port (return the port setting to `(Authentication:OFF)`), perform the same operation, but select **Authentication: ON -> OFF** in [step 4](#).

---

## Registering user information of hosts on a port

On iSCSI ports that authenticate hosts, you must register user information for all the hosts that you allow to connect.

1. In the Port tree, select a port for which you want to register user information of a host. The user information of hosts currently registered on the selected port appears in the User Information (Host) table to the right of the Port tree.



---

**NOTE:** You can register user information of a host even if the port status is `(Authentication:OFF)`. In this case, however, the registered user information of the host is ignored.

---

2. Do one of the following:
  - a. In the Port tree, right-click a port on which you want to register user information of a host.
  - b. Right-click any point in the User Information (Host) table.

3. Select **Add New User Information (Host)** from the shortcut menu. The Add New User Information (Host) dialog box appears.

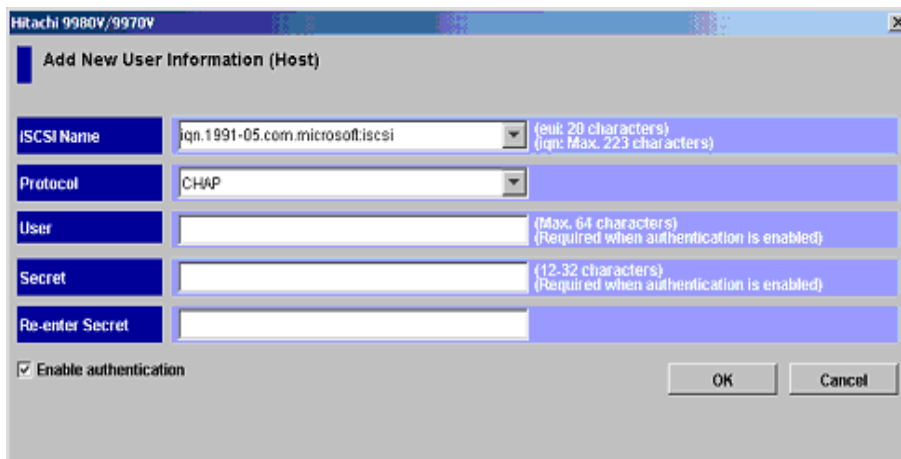

**Figure 112** Add New User Information dialog box

In this dialog box, specify the following user information for the host you want to allow to connect:

- **iSCSI Name:** Specify the iSCSI name of the host bus adapter by selecting an HBA from the list or entering it directly. The list displays all the iSCSI names of host bus adapters connected to the selected port by the cable. For details on the characters and length you can specify as an iSCSI name, see “iSCSI port settings and iSNS server settings” on page 191.
- **Protocol:** Specify the protocol used in the user authentication. The required value is CHAP.
- **User:** Specify the user name of the host (up to 64 characters). If you select the **Enable authentication** check box on the bottom-left, the user name is mandatory.

You can use alphanumeric characters, spaces, and the following symbols in a user name:

. - + @ \_ = : / [ ] , ~

User names are case sensitive. For example, the user names `host1` and `Host1` represent different users.

- **Secret:** Specify the secret (a password used in CHAP authentication). The secret can be between 12 and 32 characters. If you select the **Enable authentication** check box, the secret is mandatory.

You can use same characters and symbols as in a user name.

- **Re-enter Secret:** Specify the secret, again, for confirmation.
- **Enable authentication:** Select this check box when you want to perform user authentication of the registered host. By default, this check box is selected.

If you clear this check box, the host connects to the disk array without authentication. When the Enable authentication check box is deselected, you do not need to specify the **User**, **Secret**, and **Re-enter Secret** boxes.



**NOTE:** If a host uses Microsoft iSCSI Initiator and is configured for port authentication using CHAP, the host cannot connect to the disk array even if you clear the **Enable authentication** check box.

4. Click **OK**. The specified user information is added in blue in the User Information (Host) table.
5. Click **Apply**. A confirmation message appears.
6. Click **OK**. The setting is applied to the disk array.



**NOTE:** If you want to allow a specific host to connect to a port without user authentication, see the information in “[Host authentication](#)” on page 194.

## Changing user information of hosts

You can change the registered user name or secret of a host, and toggle switch authentication settings between enable and disable after registration.



**NOTE:** You cannot change iSCSI names when you change user information.

1. In the **Port** tree, expand the **iSCSI** folder and select a port on which the user information you want to change is registered. All the user information of the hosts registered on the selected port appears in the User Information (Host) table.
2. In the User Information (Host) table, right-click a user information item that you want to change and select **Change User Information (Host)**. The Change User Information (Host) dialog box appears.

**Figure 113** Change User Information (Host) dialog box

3. Change the user information of the host as required in the Change User Information (Host) dialog box.

You can change the contents of **User**, **Secret**, and **Enable authentication** check box. For details on characters and length you can use in the user name or secret, see “[Registering user information of hosts on a port](#)” on page 224.

4. Click **OK**. The specified user information is added in blue in the User Information (Host) table.
5. Click **Apply**. A confirmation message appears.
6. Click **OK**. The setting is applied to the disk array.

## Deleting user information of hosts

1. In the Port tree, expand the iSCSI folder and select a port on which the user information you want to delete is registered. The user information of hosts currently registered on the selected port appears in the User Information (Host) table.
2. In the User Information (Host) table, right-click a user information item that you want to delete and select **Delete User Information (Host)**. A confirmation message appears.
3. Click **OK**.
4. Click **Apply**. A confirmation message appears.



5. Click **OK**. The user information is deleted from the disk array.

## Specifying user information of ports (when performing mutual authentication)

To perform mutual authentication, you need to specify user information on the disk array ports. You must provide unique user information for each port. You can change the specified user information of ports the same way you specified them initially.

1. In the Port tree on the User Authentication tab, select a port whose user information you want to specify.

The currently registered user information for the selected port appears in the User Information (Port) table below the User Information (Host) table.

2. Right-click any point in the User Information (Port) table and select **Specify User Information (Port)**. The Specify User Information (Host) dialog box appears.

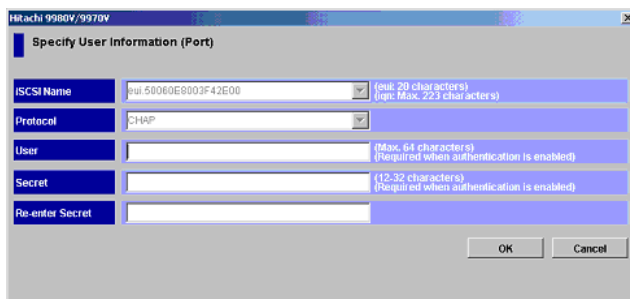

**Figure 114** Specify User Information (Port) dialog box

The following items are entered automatically and cannot be changed.

- iSCSI Name of the selected port appears. You cannot change the iSCSI name.
- **Protocol** used in the user authentication appears. This protocol is set to CHAP and you cannot change it.

Specify the following user information for the selected port.

- **User**. Enter the user name of the port up to 64 characters. You can use alphanumeric characters, spaces, and the following symbols in a user name:

. - + @ \_ = : / [ ] , ~

User names are case sensitive. For example, the user names `port1` and `Port1` represent different users.

If you use the upgraded LUN Management and the port performed authentication of hosts before upgrading, `Administrator` appears as the default. To perform mutual authentication on such a port, rename the user name of the port.

- **Secret**. Specify the secret (a password used in CHAP authentication) between 12 to 32 characters. You can use same characters and symbols as a user name.
- **Re-enter Secret**. Specify the secret again for confirmation.

3. Click **OK**. The specified user information of the port appears in blue in the User Information (Port) table.
4. Click **Apply**. A confirmation message appears.
5. Click **OK**. The setting is applied to the disk array.

## Clearing user information of ports (when performing mutual authentication)

1. In the Port tree on the User Authentication tab, expand the iSCSI folder and select a port whose user information you want to clear.  
The currently registered user information of the port appears in the User Information (Port) table below the User Information (Host) table.
2. Right-click any point in the User Information (Port) table and select **Clear User Information (Port)**. A confirmation message appears.
3. Click **OK**. The user information of the selected port disappears from the User Information (Port) table.
4. Click **Apply**. A confirmation message appears.
5. Click **OK**. The setting is applied to the disk array.

## Relationship between port settings and connection results

During host authentication, the connection result is determined by the combination of the following port settings:

- Port settings in the Port tree: `Authentication:ON` or `Authentication:OFF`
- Whether the user information of the host that is trying to connect is registered on the host
- Whether the **Enable authentication** check box is selected for the user information of the host to be connected

Table 39 shows the relationship between the combinations of port settings and the connection results. Irrespective of whether a host is configured for port authentication using CHAP, the connection results are as follows, unless otherwise noted.

**Table 39** Combinations of iSCSI port settings and connection results

Port settings			Connection results
Authentication: at port	User information registered on host?	Enable authentication	
ON	Yes	Selected	Connected if the host authentication was successful (processing will continue to port authentication) <sup>1</sup>
ON	Yes	Not selected	Connected without host authentication
ON	No	---	Authentication failed to be authenticated and cannot be connected
OFF	---	---	Connected without host authentication <sup>2</sup>

---: This item does not affect the connection results, or cannot be specified.  
<sup>1</sup> If a host is not configured for port authentication using CHAP, the host cannot connect to the disk array.  
<sup>2</sup> If a host uses Microsoft iSCSI Initiator and is configured for port authentication using CHAP, host authentication will fail. To allow such a host to connect to the port without authentication, do not configure it for CHAP port authentication.

For additional information on user authentication, see “[User authentication \(iSCSI environments only\)](#)” on page 193.

# Operational restrictions

The success of some LUN Management activities depends on the status of the security switch and whether I/O is active or inactive to the port or LUN. The following tables describe those restrictions.

Notes:

- If you attempt to apply a large number of the settings in the LUN Management panels in a single session, the XP128/XP1024 might be unable to continue processing. It is recommended that you apply no more than 1,000 settings per session. Note that a large number of settings are likely to be applied when you define alternate paths (see ["Defining alternate paths"](#) on page 212), even though only two commands are required to define alternate paths.
- Do not remove LU paths (see ["Changing or viewing LU path settings"](#) on page 207) when the hosts are performing I/O processing.
- Do not remove LUN security (see ["Applying and removing LUN security"](#) on page 215) when the hosts are performing I/O processing.

## Restrictions on LUN Management operations

**Table 40** LUN Management operation restrictions (XP128/XP1024)

Activity		Security switch OFF		Security switch ON	
		Host group 0	Host group 01-7F	Host group 0	Host group 01-7F
Setting the LUN Security Switch ON	With active I/O on port	Permitted with confirmation message	Invalid operation	Invalid operation	
	With no active I/O on port				
Setting the LUN Security Switch OFF	With active I/O on port	Invalid operation		Permitted with confirmation message	
	With no active I/O on port				
Adding a host group	With active I/O on port	Default host group	Not permitted	Default host group	Permitted
	With no active I/O on port				
Adding a WWN or iSCSI name	With active I/O on port	Invalid operation		Permitted	
	With no active I/O on port				
Adding a LUN	With active I/O on port	Permitted	Invalid operation	Permitted	
	With no active I/O on port				

**Table 40** LUN Management operation restrictions (XP128/XP1024) (continued)

Activity		Security switch OFF		Security switch ON	
		Host group 0	Host group 01-7F	Host group 0	Host group 01-7F
Deleting a WWN or iSCSI name	With active I/O on port	Invalid operation		Permitted with confirmation message	
	With no active I/O on port				
Deleting a LUN	With active I/O to deleted LUN	Not permitted	Invalid operation	Not permitted	
	With no active I/O on LUN	Permitted		Permitted	
Deleting a command device	With active I/O on LUN	Not permitted	Invalid operation	Not permitted	
	With no active I/O on LUN	Permitted		Permitted	
Deleting a host group	With active I/O on LUN	Not permitted	Invalid operation	Not permitted	
	With no active I/O on LUN			Not permitted	Permitted

## Restrictions on port operations

**Table 41** Port operation restrictions (XP128/XP1024)

Activity		
Changing topology	With active I/O on LUN	Not permitted
	With no active I/O on LUN	Permitted
Changing fibre address	With active I/O on LUN	Not permitted
	With no active I/O on LUN	Permitted
Changing host speed	With active I/O on LUN	Not permitted
	With no active I/O on LUN	Permitted
Changing PCB mode	With active I/O on LUN	Not permitted
	With no active I/O on LUN	Permitted
Changing host mode	With active I/O on LUN	Not permitted
	With no active I/O on LUN	Permitted

# 16 LUN Security for the XP48/XP512

Use LUN Security to restrict LUN availability to specified hosts, using the hosts' worldwide names (WWNs). Unauthorized hosts cannot access a secured LUN and its data.

You can secure some or all of the LUNs on a port. You can consolidate LUNs into LUN groups to help simplify this task. Use a LUN group to assign a group of LUNs to a host under a single LUN group name.

You can also combine host WWNs into WWN groups. For the XP48/XP512, you can assign up to 256 WWNs to a single group.

By giving a WWN group access to a specified LUN or group of LUNs, you give every host in the WWN group access to the LUN or LUN group.

You can assign more than one WWN to one port and one WWN to several ports.

## Starting LUN Security

1. From the Device Launcher pane, click **Modify** or **View** for an XP48/XP512.
2. Click **LUN Security**. The LUN Security pane appears.

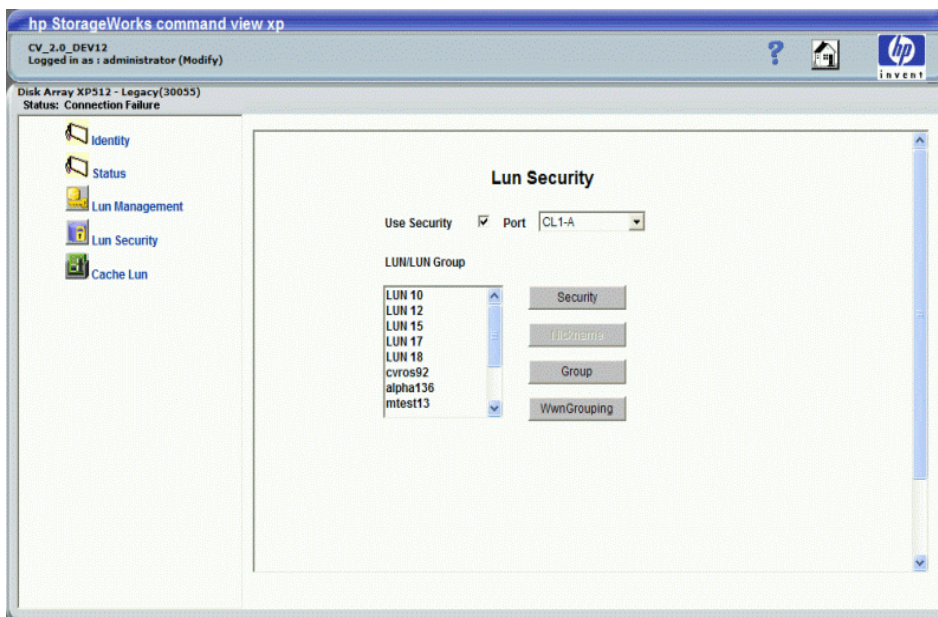

**Figure 115** LUN Security main pane

This pane includes the following items:

- **Use Security** check box: Check to enable LUN Security for the port selected in the Port list
- **Port**: A list containing the Fibre Channel ports
- **LUN/LUN Group**: Displays the LUNs and LUN groups defined for the selected port
- Buttons:
  - **Security**: Sets the security options for selected LUNs or LUN groups

- The top section of the pane changes when you click **Security**. The top section is used to group LUNs, change LUN group nicknames, and set the security for LUNs and LUN groups defined for the selected port.
- **Nickname**: Changes the nickname of the selected LUN group
- **Group**: Creates, modifies, or deletes the selected LUN group
- **WwnGrouping**: Used to define WWNs, create and modify WWN groups, delete WWNs and WWN groups, and change WWN, WWN nickname, and WWN group nicknames

The WWN/WWNGroup section appears when you click **WwnGrouping**.

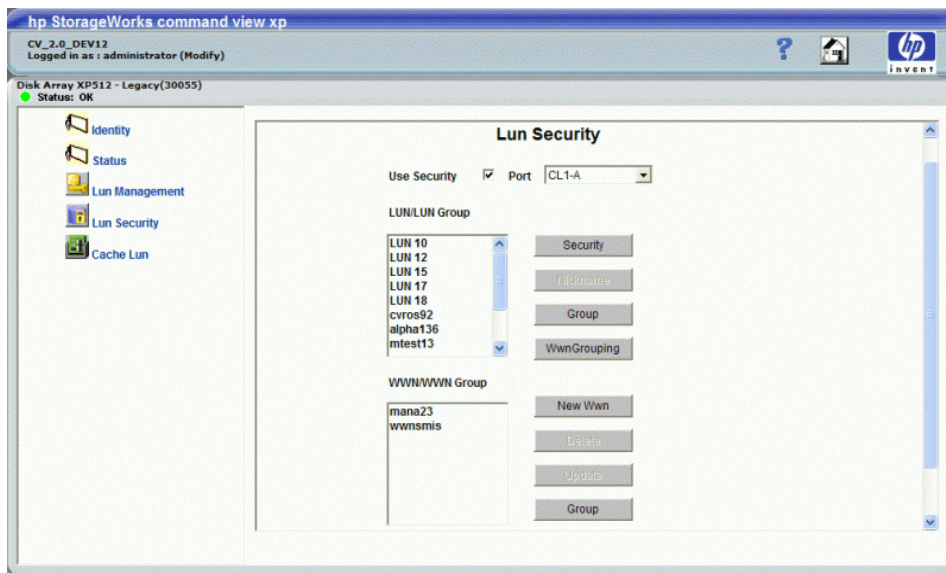

**Figure 116** LUN Security main pane with WWN/WWN Group list displayed

- **WWN/WWN Group**: Displays WWNs and WWN groups for the selected port
- Buttons:
  - **New Wwn**: Used to define WWNs and WWN nicknames
  - **Delete**: Deletes WWNs and WWN groups
  - **Update**: Changes the WWN, WWN nickname, and WWN group nickname
  - **Group**: Creates, modifies, and deletes WWN groups

## Enabling and disabling LUN Security

If no paths are defined for a selected port, you cannot perform LUN Security operations for that port. Exit LUN Security, establish paths, and then return to LUN Security.

1. From the LUN Security main pane, select a port in the Port list.
2. To enable LUN security for the selected port, select the **Use Security** check box. If no WWN is defined for the selected port, the **New Wwn** button will be enabled in the bottom section of the pane. To add new WWNs, see [“Adding a new WWN”](#) on page 235.

To disable LUN security for the selected port, clear the **Use Security** check box. All security permissions for the port will be disabled and any host can access the port. Disabling LUN Security for a port does not erase the LUN security setting for a LUN. The assigned setting for the LUN is held until that LUN or its port is uninstalled or until the settings are manually erased.



# Defining LUN Security

You can allow access to a single LUN or a group of LUNs. To do this, you must create a LUN group.

You can make access to a LUN or a LUN group available to a single host WWN, or you can group WWNs in a WWN group as a simple way to allow multiple hosts to access a LUN or LUN group.

1. From the LUN Security main pane, select a port in the Port list. The LUN/LUN Group list displays the LUNs for the port.

If no LUNs are displayed, a LUN must be defined. To define LUNs, see “LUN Management for the XP48/XP512” on page 157.

2. Select the **Use Security** check box.
3. Select a LUN or LUN Group.
4. Click **Security**. The LUN/LUN Group Security pane appears.

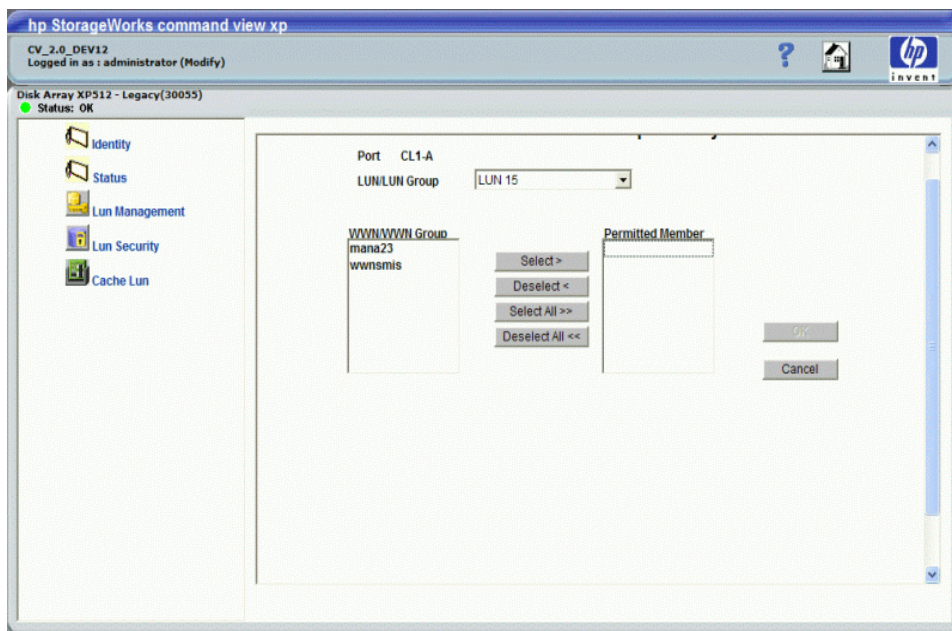

**Figure 117** LUN/LUN Group Security pane

5. Select the WWN or WWN group that will be granted access to the selected LUN or LUN group.
6. Click **Select**. To select all of the WWNs in the list, click **Select All**. The selected WWNs appear in the Permitted Member list.

If you do not want to grant access for a selected WWN, click the unwanted WWN in the Permitted Member list and click **Deselect**. To move all of the selected WWNs out of the Permitted Member list, click **Deselect All**.

7. Click **OK**. The LUN Security pane appears.

Repeat these steps for each port and LUN or port and LUN group combination you want secure.

# Changing LUN Security parameters

## Changing WWN access to a LUN

You can change WWNs or a WWN group permission to communicate with a selected LUN.

1. From the LUN Security main pane, select a port in the Port list.
2. In the LUN/LUN Group list, select a LUN or LUN group.
3. Click **Security**. The LUN/LUN Group Security pane appears.
4. To grant access to the LUN or LUN group, select a WWN or WWN group and click **Select**. To select all WWNs or WWN groups, click **Select All**. The selected WWNs or WWN groups are moved into the Permitted Member list.

To remove access, select the WWNs or WWN groups in the Permitted Member list and click **Deselect**. To remove permissions for all of the WWNs or WWN groups, click **Deselect All**.

5. Click **OK**. You are returned to the LUN Security main pane.

## Creating a LUN group

1. From the LUN Security main pane, select a port in the Port list.
2. Click **Group**. The LUN Group pane appears.

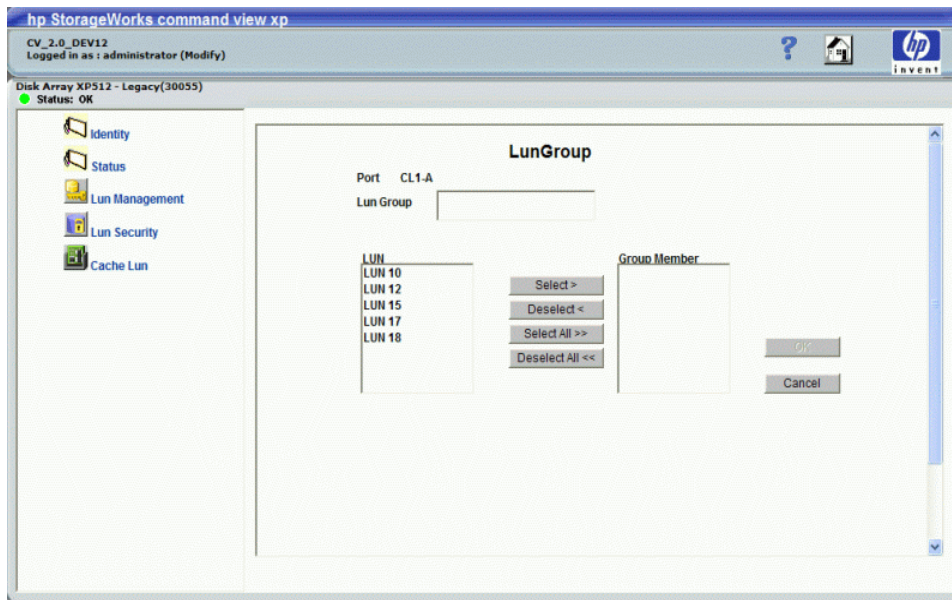

**Figure 118** LUN Group pane

The **LUN Group** list displays the available LUNs for the port.

3. In the **LUN Group** box, enter a name for the LUN Group.
4. Add LUNs to the group by selecting each LUN you want to assign and clicking **Select**. To select all the displayed LUNs, click **Select All**. The Group Member list displays the newly-assigned LUNs.

To remove a LUN from the Group Member list, select the LUN you want to remove and click **Deselect**. To remove all the displayed LUNs, click **Deselect All**.

5. Click **OK**.

## Changing LUN Group Information

1. From the LUN Security main pane, select a port in the **Port** list.
2. In the **LUN/LUN group** list on the LUN Security main pane, select a LUN group.
3. Click **Group**. The LUN Group pane appears.



4. Add LUNs to or remove LUNs from the group:
  - a. To add a LUN to the LUN group, select it and click **Select**. To select all the displayed LUNs, click **Select All**. The Group Member list displays the newly-assigned LUNs.
  - b. To remove a LUN from the group, select it in the Group Member list and click **Deselect**. To remove all the LUNs in the **Group Member** list, click **Deselect All**.
5. Click **OK**.

## Creating or changing a LUN group nickname

You can assign a nickname to a LUN group.



**NOTE:** You cannot assign a nickname to an individual LUN.

1. From the LUN Security main pane, select a port in the **Port** list.
2. Select the LUN group for which the nickname is to be created or changed.
3. Click **Nickname**. The pane expands to display a Nickname box.

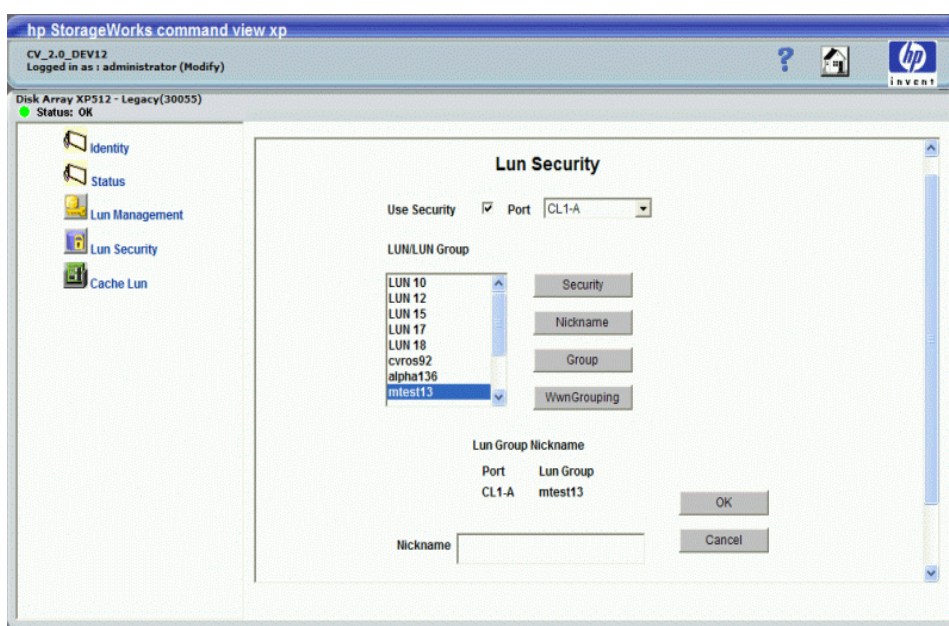

**Figure 119** LUN Security main pane with Nickname box displayed

4. To add a nickname, enter the nickname for the LUN group. To change a nickname, enter a new nickname.
5. Click **OK**.

## Adding a new WWN

1. From the LUN Security main pane, select a port in the Port list.
2. Click **WwnGrouping**. The pane expands to display WWN information.

3. Click **New Wwn**. The New WWN pane appears.

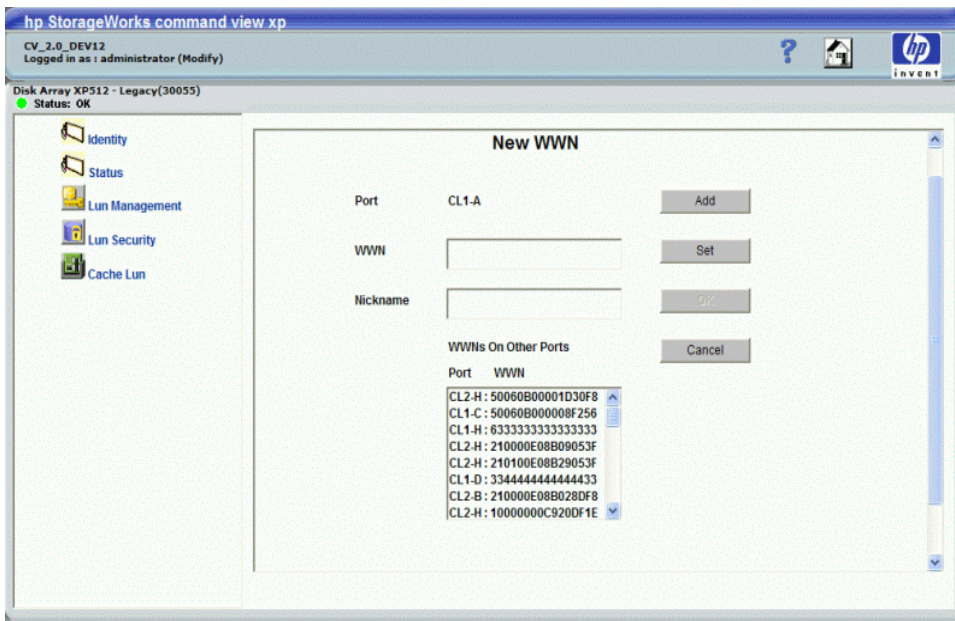

**Figure 120** New WWN pane

4. In the WWN box, enter the new WWN. The WWN is a hexadecimal string containing 16 characters.
5. In the Nickname box, enter the nickname. The nickname is mandatory for all WWNs. Maximum length is 8 characters.
6. Click **Add**. The WWN is added to the list.
7. Click **Set** or **OK** to register the WWN.

If you click **Set**, the display remains in the same pane after registering the WWN for the selected port. If you click **OK**, the display returns the LUN Security main pane after adding the WWN.

## Creating a WWN Group

WWNs can be combined into groups.

1. From the LUN Security main pane, select a port in the Port list.
2. Click **WwnGrouping**. The pane expands to display WWN information.

3. In the WWN/WWN Group area, click **Group**. The WwnGroup pane appears.

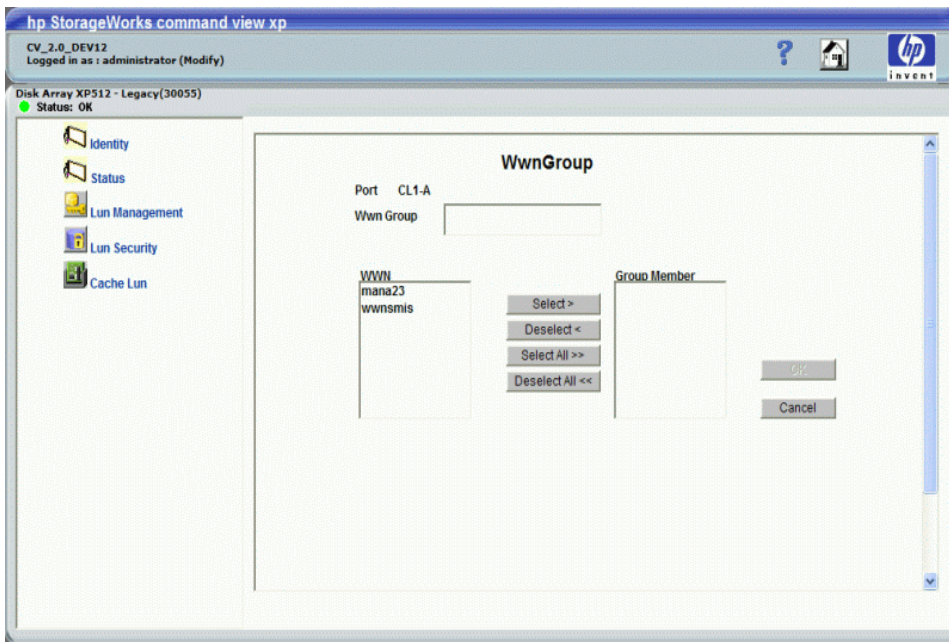

**Figure 121** WwnGroup pane

4. In the **WwnGroup** box, enter a name for the WWN Group.

To add a WWN to the new WWN group, select the WWN in the WWN list and click **Select**. To select all the WWNs in the list, click **Select All**.

The selected WWN appears in the **Group Member** list.

To remove a WWN from the group, click **Deselect**. To remove all the WWNs, click **Deselect All**.

5. Click **OK**.

## Deleting a WWN or WWN Group

1. From the LUN Security main pane, select a port in the Port list.
2. Click **WwnGrouping**. The pane expands to display WWN information.
3. Click the WWN or WWN group you want to delete.
4. Click **Delete**. A confirmation message appears.
5. Click **OK**.

## Updating WWNs and Nicknames

1. From the LUN Security main pane, select a port in the Port list.
2. Click **WwnGrouping**. The pane expands to display WWN information.

3. Click **Update**. The pane displays the Update WWN/WWN Group boxes.

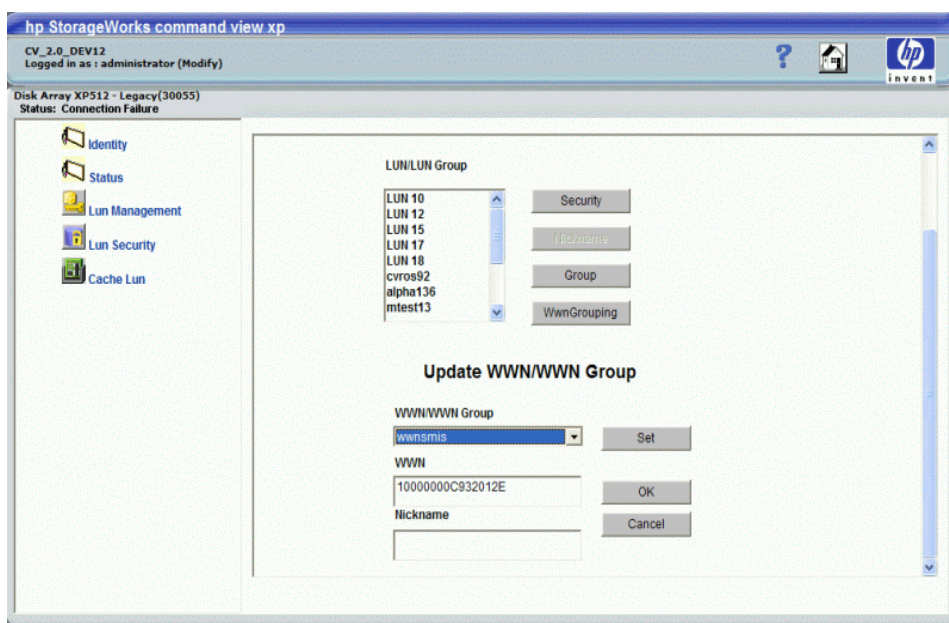

**Figure 122** LUN Security main pane with Update WWN/WWN group boxes displayed

4. In the **WWN/WWN Group** list, select the WWN or WWN group you want to modify.
5. Enter a WWN name and WWN's nickname.
6. Click **Set** or **OK** to register the change.

If you click **Set**, the display remains in the same pane after registering the change. If you click **OK**, the display returns to the LUN Security main pane after changing the WWN.

## Changing WWN group members

1. From the LUN Security main pane, select a port in the **Port** list.
2. Click **WwnGrouping**. The pane expands to display WWN information.



3. Select the WWN group you want to modify and click **Group** in the WWN/WWN Group area. The WwnGroup pane appears.

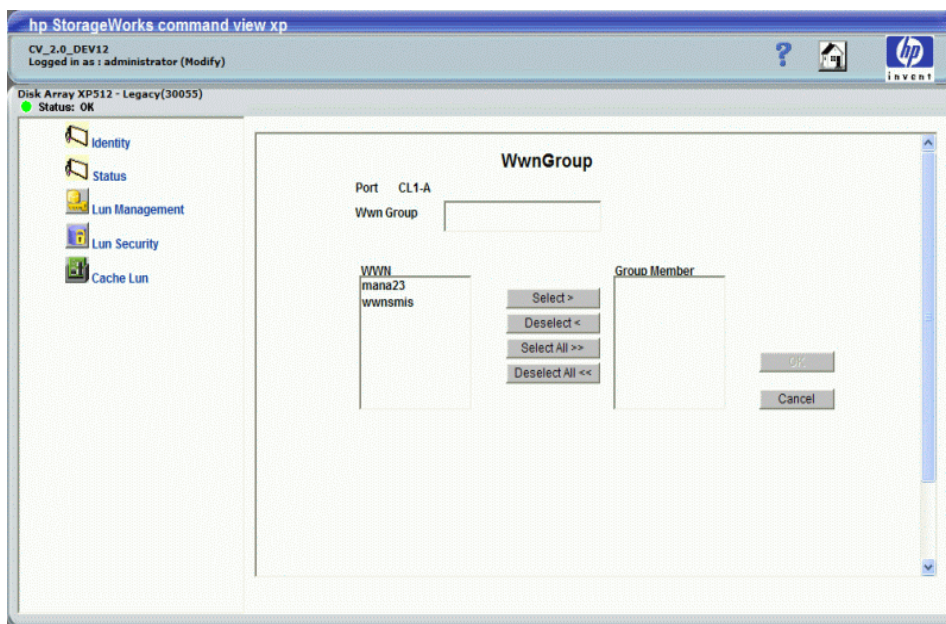

**Figure 123** WwnGroup pane

4. To add a WWN to the new WWN group, select the WWN in the WWN list and click **Select**. To select all the WWNs in the list, click **Select All**. The Group Member list displays the selected WWN. To remove a WWN from the group, click **Deselect**. To remove all the WWNs, click **Deselect All**.
5. Click **OK**.



# 17 Volume Management for the XP128/XP1024/XP12000

Use Volume Management to perform the following tasks:

- “Volume Management (LU Size Expansion)” on page 241)
- “Volume Size Configuration (VSC)” on page 243)
- “Data Shredder” on page 278)

## Volume Management (LU Size Expansion)

Volume Management (LU Size Expansion or LUSE) combines two or more LDEVs to function as a larger LDEV. As a result, a host can access a greater amount of storage with a smaller number of LDEVs.

Figure 124 shows the effect of a LUSE configuration.

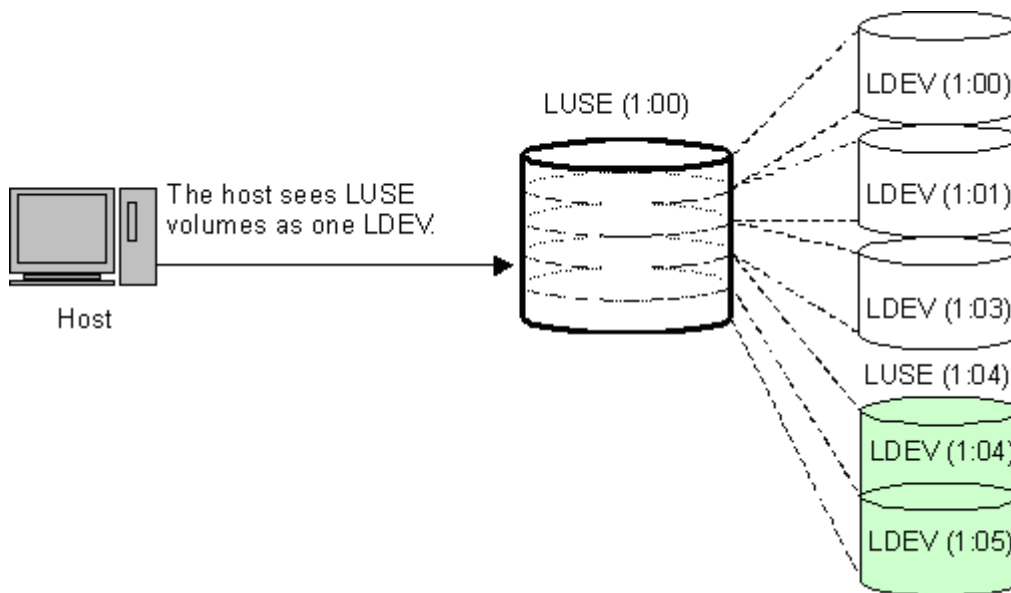

Figure 124 LUSE configuration

LUSE can combine up to 36 LDEVs into a LUSE volume. The LDEV number of the LUSE volume is the *first* or *lowest* number of the LDEVs making up the LUSE volume. This is the *top* LDEV, and is the number the host will recognize.

## Drawbacks

- Some operating systems may experience slow disk access times with large logical units, if they contain a large number of high-use files.
- The size of a LUSE volume can increase the amount of time required to perform backups.

## LUSE rules

- Open volume emulation types OPEN-3, OPEN-8, OPEN-9, OPEN-E, OPEN-L, or OPEN-V are supported.

- The maximum number of LDEVs that can be used to create a LUSE is 36.
- LDEVs must be of the same emulation type.
- LDEVs must be at the same RAID level. Combining RAID 1 and RAID 5 volumes into the same LUSE volume is supported, but not recommended.
- LDEVs or LUSE volumes to be combined must have no assigned path definitions. These are known as free (or available) LDEVs. For this reason, Business Copy, Continuous Access, TrueCopy (TC390), ShadowImage (SI390), and Continuous Access XP - Journal pair volumes cannot be targets of LUSE operations. For more information, see [“LUSE operations that handle a path-defined LDEV”](#) on page 242.
- LDEVs that are to be combined into LUSE volumes must not be reserved for Auto LUN.
- When you combine a LUSE volume with another LUSE volume, the range of LDEVs should not be overlapped.

For example, if you combine LDEV00, LDEV03 and LDEV05 into LUSE 1, LDEV02 and LDEV04 into LUSE 2, and LDEV06 and LDEV07 into LUSE 3, you can also combine LUSE 1 and LUSE 3. However, you cannot combine LUSE 1 and LUSE 2, because the LDEV range in LUSE 1 and LUSE 2 is overlapped.

- A maximum of 256 expanded logical units (LUs) can be configured on the same port.
- The maximum capacity of a LUSE volume is 60 TB for XP12000 arrays.
- The maximum capacity of a LUSE volume is 2 TB for XP128/XP1024 arrays.
- The access attribute must be set to read/write when creating or releasing a LUSE volume.
- When releasing a LUSE volume, the volume should have no path definitions.
- Combining internal and external volumes is not supported.
- The IO suppression mode and cache mode settings of the LDEVs combined into a LUSE volume must be the same.
- All the LDEVs combined into a LUSE volume must be of the same drive type (either the SATA drive or non-SATA drive).

## LUSE operations that handle a path-defined LDEV

You can use an LDEV or another LUSE volume that has path definitions as the top LDEV of the resulting LUSE volume, and can combine the top LDEV with other LDEVs or LUSEs that have no path definitions. Creating this type of LUSE volume is referred to as “a LUSE operation that handles a path-defined LDEV.”

When creating a LUSE volume in this manner, the following rules apply:

- You can combine an LDEV or LUSE volume having no path definitions with another LDEV or LUSE volume having no path definitions.
- You can perform a LUSE operation that handles a path-defined LDEV regardless of how many paths are defined to the LDEV.
- If you want to use an LDEV or a LUSE volume having no path definitions as the top LDEV of the resulting LUSE volume, you cannot combine this LDEV or LUSE volume with other LDEVs or LUSE volumes having path definitions.

When performing a LUSE operation that handles a path-defined LDEV:

- If a path is defined from a Windows 2000 host, a Windows Server 2003 host, or an AIX 5.2 host to an LDEV, the LDEV can be used for LUSE operations that handle a path-defined LDEV. However, if a



path is defined from a host running another operating system to an LDEV, the LDEV cannot be used for LUSE operations that handle a path-defined LDEV.

- If a path is defined from a Windows 2000 host or a Windows Server 2003 host to an LDEV and you want to perform a LUSE operation that handles this path-defined LDEV, verify that the host mode of the Windows host is 2C (Windows Extension). If the host mode is not 2C, change the host mode to 2C before performing the LUSE operation.
- If the host mode is 0C (Windows Extension) and an LU path is defined for a volume, you cannot perform LUSE operations on the volume without unmapping the volume first.

---

## Volume Size Configuration (VSC)

The Volume Size Configuration (VSC) process configures custom volumes (CVs) that are smaller than normal volumes. Custom volumes improve data access performance by reducing logical device contention as well as host I/O queue times, which can occur when several frequently-accessed files are located on the same volume.

If several frequently-accessed files are on the same LDEV, using VSC to set up smaller, *separate* custom volumes for them can reduce conflicts and improve performance.

A small custom volume can be used as a command device. This leaves the rest of the LDEV free for other uses.

### VSC operations

VSC operations include the following:

- **Volume to Space:** Formats one or more LDEVs on a selected VDEV into free space, which can be used to install one or more custom volumes using the Install CV function, or left as free space for future use.
- **Install CV:** Creates custom volumes from free space.
- **Make Volume** or **Volume Initialize** (supported for OPEN-V VDEVs only for XP12000 arrays): Converts a custom volume back to a normal volume (VDEV).

The Make Volume function clears all custom volumes under a VSC volume and creates an initial volume (VDEV) that consists of new user-defined custom volumes.

The Volume Initialize function uninstalls all custom volumes under a VSC volume, and reformats the VSC volume as a normal volume (VDEV).

Compared to other emulation types, use OPEN-V to easily create volumes of any size. OPEN-V volumes always consist of custom volumes, instead of fixed-size volumes.



**CAUTION:** VSC operations are destructive. Back up your data before performing VSC operations.

---

Figure 125 and Figure 126 show a sample VDEV (whose components are LDEVs) in its initial condition and the VDEV after custom volumes are created.

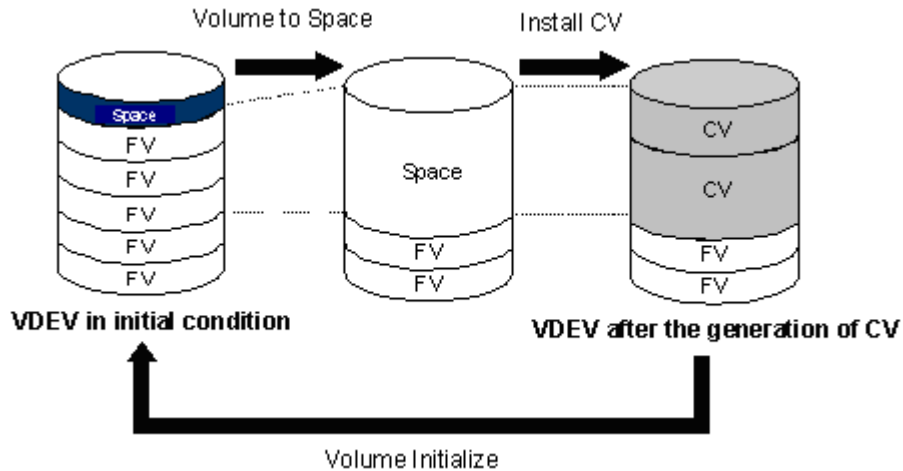

Figure 125 VSC process (all supported emulation types except for OPEN-V)

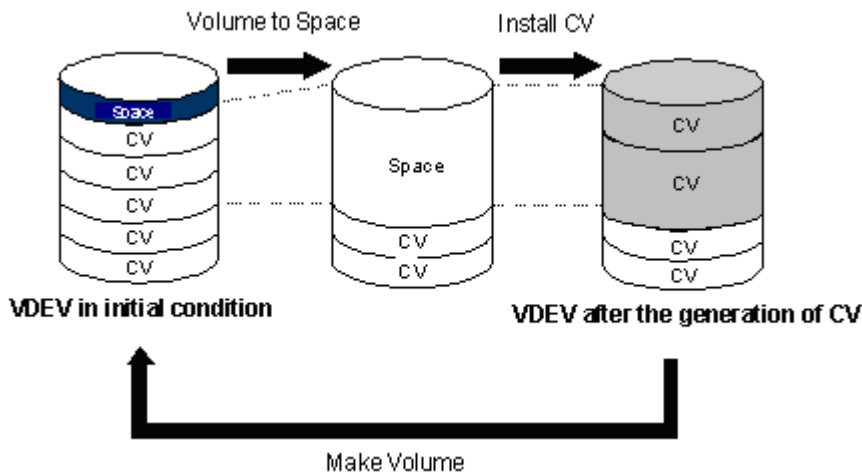

Figure 126 VSC process (OPEN-V)

## Parity group configuration

This section explains the parity group configuration of emulation types other than OPEN-V. OPEN-V volumes always consist of variable sized volumes instead of fixed-size volumes (FVs). To use OPEN-V, parity groups must be enabled to support the OPEN-V emulation type. To enable OPEN-V, contact your HP account support representative.

For emulation types other than OPEN-V, one parity group consists of a maximum of 16 VDEVs. For RAID-5 (7D + 1P) level, a maximum of 512 fixed-size volumes (FVs), and a certain amount of free space are available in one VDEV. For other RAID levels, a maximum of 256 FVs and a certain amount of space are available. Each VDEV in a parity group has the same configuration, and is assigned the same FVs of the same size and RAID level.

VSC functions (Volume to Space, Install CV, Volume Initialize, and Make Volume) are performed on each VDEV. VDEVs are also separated from each other by the boundary limitation. You cannot define a volume across two or more VDEVs beyond the boundaries.

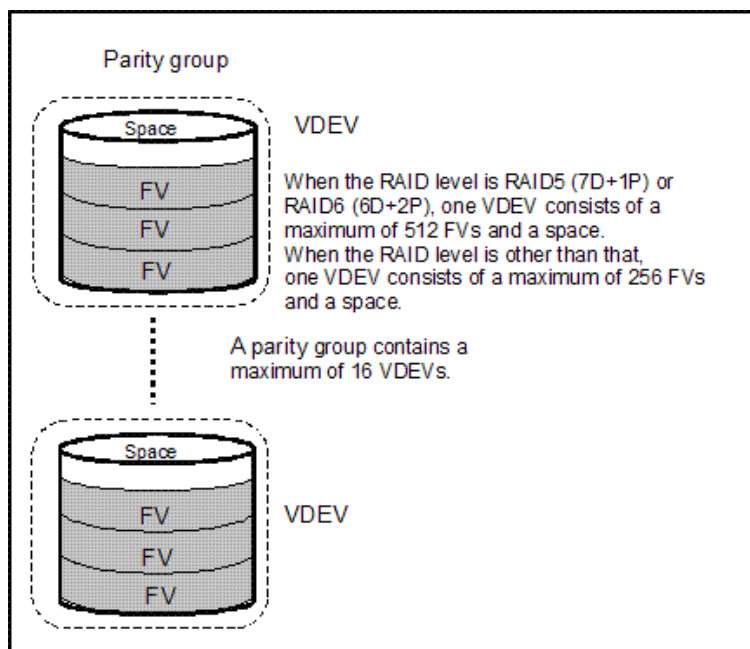

**Figure 127** Parity group configuration for other than OPEN-V

As the result of VSC operations, a VDEV contains fixed volumes, custom volumes, and free spaces that are delimited in logical cylinders. Sequential free spaces are combined into a single free space.

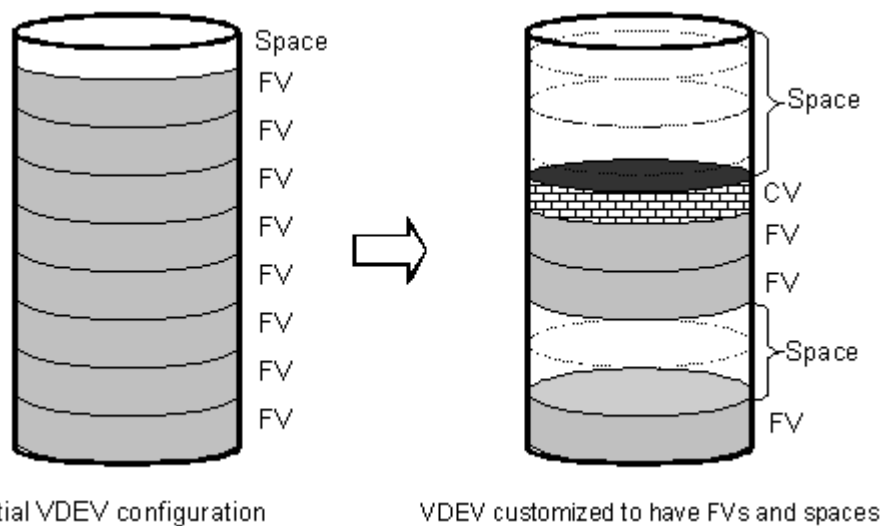

**Figure 128** Virtual VSC volume configuration for other than OPEN-V

Before changing ordinary target ports or RCU target ports to initiator ports, make sure that no I/Os (such as Extended Copy commands) are being performed from the host server to the affected port(s). You can change the port type of free ports only.

## Volume to Space operation

The Volume to Space function converts one or more LDEVs (fixed or custom volumes) into free space, which deletes the selected LDEVs from that volume.

## Restrictions

- The LDEV must not have a path definition, including TrueCopy (TC390), Continuous Access (CA), ShadowImage (SI390), Business Copy (BC), and Continuous Access XP - Journal pair volumes.
- The LDEV must not be a component of a LUSE volume. This applies to all supported emulation types except for OPEN-V.
- The LDEV must not be reserved for Auto LUN.
- The access attribute must be set to Read/Write.

## Install Custom Volume (CV) operation

The Install CV function defines and installs one or more VSC volumes under an existing volume (free space in a VDEV). You can assign a specific number of physical cylinders (for mainframe systems) or MB (for open systems) to each VSC volume for maximum control over the volume size.

When you specify the capacity and the emulation type other than OPEN-V for a VSC volume to be created, the Install CV function automatically creates and formats the VSC volume in sufficient free space. You must specify a new CU number and LDEV number for the created VSC volume. The created VSC volume contains the user-specified number of user cylinders and a predetermined number of control cylinders by the emulation type.

If you select free space and perform an Install CV operation, VSC volumes will be created only in the selected free space.

For OPEN-V volumes, there are four ways to create VSC volumes (Table 42). You can specify from 46 MB (50 cylinders) up to the maximum capacity of VDEV for the capacity of a volume. If the specified capacity exceeds 60 gigabytes (65,535 cylinders), the Install CV function creates the volume in LUSE configuration automatically.

When there is only one free space in the VDEV, you can use any method to create VSC volumes. When there are two or more free spaces, you can use the first method only. The other methods are not available.



**NOTE:** Virtual LUN operations are not available for OPEN-L volumes.

**Table 42** Creating VSC volumes by Install CV (for OPEN-V)

No.	Install CV method	Description
1	Specify size and number	Used to specify the capacity and the number of custom volumes in the VSC volume that you want to create.
2	Divide free space by number	Used to create VSC volumes by specifying the number of custom volumes in the VSC volume to be created.
3	Divide free space by size	Used to create VSC volumes by specifying the capacity of custom volumes in the VSC volume to be created.
4	Set remaining space as volume	Used to create a VSC volume using the remaining space on the VDEV.



**NOTE:** Volume Management functions are not available for OPEN-L and OPEN-M volumes.



**NOTE:** Allocating custom volumes in descending order of capacity optimizes custom volume allocation during the Install CV process.

As defined in [Table 43](#), VSC does not work with OPEN-L and OPEN-M emulation types. VSC supports OPEN-3, OPEN-8, OPEN-9, OPEN-E, and OPEN-V emulations.

**Table 43** VSC supported emulations

Emulation	Can create these volume size configurations
OPEN-3	3, 8, 9, E
OPEN-8	3, 8, 9, E
OPEN-9	3, 8, 9, E
OPEN-E	3, 8, 9, E
OPEN-V	V

[Table 44](#) lists specifications and the minimum and maximum volume capacities for mainframe and open systems.

**Table 44** Install Custom Volume operation parameters for mainframe and open system volumes

Item	Mainframe system volumes	Open system volumes	
Track format	3380 or 3390	OPEN-3, OPEN-8, OPEN-9, OPEN-E	OPEN-V
Emulation type	3380-E, -F, -J, -K, -KA/KB/KC; 3390-1,-2,-3,-3R, -3A/3B/3C, -9	OPEN-3, OPEN-8, OPEN-9, OPEN-E	OPEN-V
Maximum number of LDEVs (fixed and custom volumes) per VDEV	512 for RAID5 (7D+1P) 256 for other RAID levels	512 for RAID5 (7D+1P) 256 for other RAID levels	512 for RAID5 (7D+1P) 256 for other RAID levels
Maximum number of LDEVs (fixed and custom volumes) per disk array <sup>1</sup>	8192 (XP128/1024) 16,384 (XP12000)	8192 (XP128/1024) 16,384 (XP12000)	8192 (XP128/1024) 16,384 (XP12000)
Minimum custom volume capacity	1 cylinder (+ control cylinders)	36 MB (+ control cylinders)	48 MB (50 cylinders)
Maximum custom volume capacity	Emulation volume size	Emulation volume size	Emulation volume size
Increment of custom volume capacity	1 cylinder	1 MB	1 MB (1 cylinder)
Custom volume disk location	Anywhere	Anywhere	Anywhere

1. The value for the maximum number of LDEVs per disk array depends on the installed firmware version.

Table 45 shows specified and actual capacities of various open system custom volume sizes.

**Table 45** Capacities of open system custom volume sizes

Setting size (MB)	User size <sup>1</sup> (MB)	Notes
36	36.15625	Minimum custom volume size (other than OPEN-V)
46	48.875	Minimum custom volume size (OPEN-V)
500	500.625	
1000	1000.546875	
2000	2000.390625	
2347	2347.03125	Maximum OPEN-3 volume size
7007	7007.34375	Maximum OPEN-8 volume size
7042	7042.5	Maximum OPEN-9 volume size
13893	13893.04688	Maximum OPEN-E volume size
737256	737256.09375	Maximum OPEN-V volume size (maximum VDEV volume size) Applies only to XP128/Xp1024 arrays.

1. The term *user size* refers to capacity available to users. User size does not include the number of control cylinders and the number of cylinders for volume boundary control.

## Volume Initialize and Make Volume operations

The Volume Initialize and the Make Volume functions reset a VDEV to its original configuration.

If you are not using OPEN-V, use the Volume Initialize function. The Volume Initialize function removes all custom volume areas and free spaces on the VDEV and regenerates and formats initial fixed volumes. The newly-formatted fixed volumes must be assigned CU and LDEV numbers. Existing fixed volumes on the VDEV are not reformatted.

If you are using OPEN-V, use the Make Volume function. The Make Volume function deletes all volumes in a VDEV, and creates new custom volumes according to the specified settings. Table 46 shows the available settings.

**Table 46** Settings for the Make Volume operation (OPEN-V only)

No.	Specifies...	VSC volumes to be created
1	The capacity and number of custom volumes under a VSC volume.	A VSC volume with the specified number of custom volumes of the specified capacity is created. This is the same as the Install CV operation.
2	The number of custom volumes.	A VSC volume with the specified number of custom volumes is created. The VDEV is divided by the specified number.

**Table 46** Settings for the Make Volume operation (OPEN-V only) (continued)

No.	Specifies...	VSC volumes to be created
3	The capacity of custom volumes.	A VSC volume with custom volumes of the specified capacity is created. The VDEV is divided by the specified capacity.
4	The remaining capacity for a VSC volume.	If some space remains in the VDEV after VSC volumes are created by settings 1 - 3, the remaining space can be converted into a VSC volume.

If the specified capacity exceeds 60 gigabytes (65,535 cylinders), the Make Volume function automatically creates the VSC volume in LUSE configuration.

## Restrictions

If the VDEV contains a custom volume that violates any of the restrictions, the Volume Initialize and Make Volume functions are disabled. You must eliminate invalid custom volumes before performing the Volume Initialize and Make Volume functions.

- The LDEV must not have a path definition, including TrueCopy (TC390), Continuous Access (CA), ShadowImage (SI390), Business Copy (BC), and Continuous Access XP - Journal pair volumes.
- The LDEV must not be a component of a LUSE volume (Volume Initialize only).
- The LDEV must not be reserved for Auto LUN.
- The access attribute must be set to Read/Write (Volume Initialize only).

---

## LUSE operations

Users belonging to the Administrator and StorageAdmin groups can perform Modify VSC and Modify LUSE operations.

### Starting LUSE operations

1. From the Device Launcher pane, click an XP128/XP1024/XP12000 link.

2. Click the **Volume Management** button (  Volume Mana... ). The Volume Management pane appears.

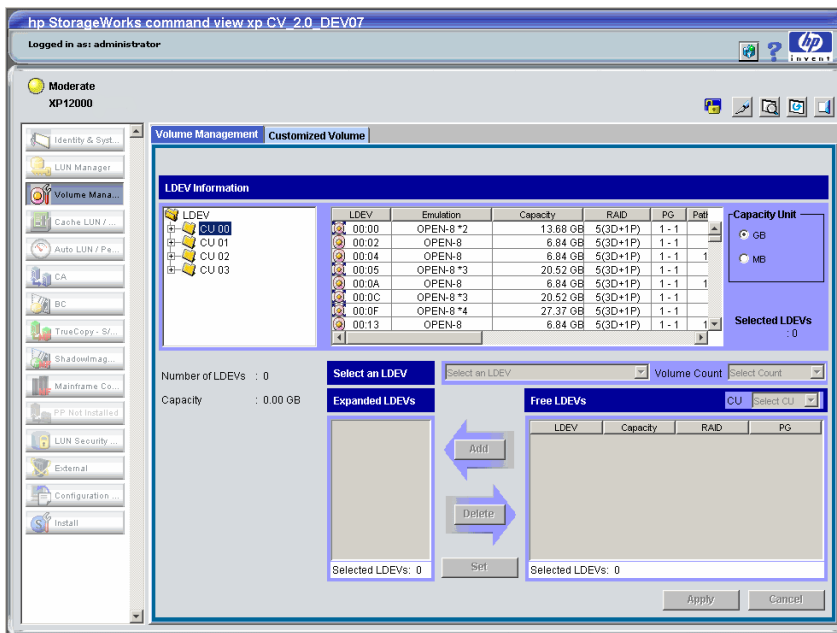

**Figure 129** Volume Management pane

## Volume Management pane

The Volume Management pane includes the following sections.



### LDEV Information tree

The top of the pane shows a tree and list of CU numbers (CUxx) and LDEV numbers (xx:xx). When an LDEV is made up of LUSE volumes, the top LUSE number is displayed with the number of members preceded by an asterisk (\*n). The number is the number of LDEVs that the LUSE volume contains, such as 00:02\*2.

### LDEV Information table

The status of each LDEV is indicated by one of the following icons:

**Table 47** LDEV status icons for LUSE operations

Icon	LDEV status
	Normal LDEV
	Custom volume
	LUSE volume

When you select a CU in the LDEV Information tree, this table shows information about all LDEVs in the CU. When you select an LDEV, the table shows detailed information about the LDEV. When you select a LUSE volume, the table shows detailed information about all LDEVs in the LUSE volume.

The table contains the following information:

- **LDEV:** An LDEV status icon ([Table 47](#)), a CU number, and an LDEV number. If the selected LDEV is a LUSE volume, the LDEV number of the top LDEV in the LUSE volume is displayed. An LDEV number that ends with a # indicates that the LDEV is an external LU (for example, 00:01#).



- **Emulation:** The emulation type of the LDEV. If the selected LDEV is a VSC volume, the emulation type is displayed together with CVS (for example, OPEN-3 CVS). If the selected LDEV is a LUSE volume, the emulation type is displayed with an asterisk and the number of volumes in the LUSE volume (for example, OPEN-E\*5). If the LDEVs that comprise a LUSE volume extend over two or more VDEVs, the emulation type is not displayed with an asterisk and the number of volumes (\*n), and each LDEV in the LUSE volume is displayed.
- **Capacity:** The capacity of the LDEV in either MB or GV, depending on which unit you selected in the **Capacity Unit** box.
- **RAID:** The RAID level of the LDEV. The RAID level column contains a hyphen (-) when the LDEV is an external LU.
- **PG:** A combination of a disk group and a parity group. If the LDEV extends over two or more parity groups, the PG column displays the smaller parity group number. A parity group number that starts with a letter E indicates that the parity group consists of one or more external LUs (for example, E1-1).
- **Paths:** The number of paths that is set for the LDEV. If this column displays the number of paths for an LDEV, you can use the LDEV as the top LDEV of a LUSE volume. For more information, see [“LUSE operations that handle a path-defined LDEV”](#) on page 242.
- **Access Attribute:** The access attribute that is set for the LDEV
- **IO Suppression:** Displays `Disable` when the I/O request from the host is suppressed, or `Enable` if the I/O request from the host is not suppressed
- **Cache mode:** Displays `Disable` when the cache is not set to be used for responding to the I/O request from the host, or `Enable` when the cache is set to be used for responding to the I/O request from the host
- **Ex-Dev Info.:** Displays the drive type of the LDEV. Displays an asterisk (\*) when the drive type is SATA. Nothing is displayed when the drive type is not SATA.
- **CLPR:** The ID of the CLPR (cache logical partition) to which the displayed volume(s) belong. The CLPR ID is a CLPR number (two-digit) and a CLPR name (16 characters maximum)
- **Selected LDEVs:** The number of LDEVs selected in the LDEV Information table
- **Capacity Unit** button: Select a capacity unit (GB or MB) to describe LDEVs

## Select an LDEV list

Displays the LDEVs, VSC volumes, and LUSE volumes of the selected CU that are eligible to become part of a LUSE volume. The selected LDEV number becomes the top LDEV number of a LUSE volume.



**NOTE:** On an XP12000 array, an LDEV selected in the LDEV Information Tree appears in the Select an LDEV list. On an XP128 array, a selected LDEV in the Information Tree does not appear in the Select an LDEV list.

---

## Volume Count list

Specifies the number of LDEVs that should form a LUSE volume. For example, if you select 3 in the Volume Count list, three LDEVs are expected to form a LUSE volume and then three LDEVs are added to the Expanded LDEVs list. You can select an LDEV only from the Volume Count list. You cannot select a LUSE volume.

## Free LDEVs table

Lists the LDEVs, VSC volumes, and LUSE volumes that can constitute a LUSE volume in combination with the LDEV selected as a top LDEV in the Select an LDEV list. The table contains the following information:

- **LDEV:** An LDEV status icon (Table 47), a CU number, and an LDEV number. If the selected LDEV is a LUSE volume, the LDEV number of the top LDEV in the LUSE volume is displayed. An LDEV number that ends with a # indicates that the LDEV is an external LU (for example, 00:01#).
- **Capacity:** Capacity of the LDEV represented in units (GB or MB), based on the capacity you indicate with the **Capacity Unit** box.
- **RAID:** RAID level of the LDEV. The RAID level column contains a hyphen (-) when the LDEV is an external LU.
- **PG:** A combination of the disk group and the parity group. If the LDEV extends over two or more parity groups, the PG column displays the smaller parity group number. A parity group number that starts with a letter E indicates that the parity group consists of one or more external LUs (for example, E1-1).
- **CLPR:** The cache logical partition (CLPR) number and name. The CLPR number consists of two digits. The CLPR name consists of up to six characters. For detailed information about CLPRs, see ["Disk/Cache Partition for the XP12000"](#) on page 143.
- **Selected LDEVs:** The number of LDEVs selected in the Free LDEVs table

## Expanded LDEVs list

Lists the LDEVs that are selected as LUSE volume components. An LDEV from the Free LDEVs table is added to this list by clicking **Add**. The Expanded LDEVs list contains the following information:

- **Selected LDEVs:** Number of LDEVs selected in the Expanded LDEVs list
- **Number of LDEVs:** Number of LDEVs contained in a LUSE volume
- **Capacity:** The capacity of a LUSE volume. The number is displayed in GB or MB depending on the selected capacity unit.

### Buttons

- **Add:** Adds the selected LDEV(s) from the Free LDEVs table to the Expanded LDEVs list
- **Delete:** Removes the selected LDEV(s) from the Expanded LDEVs list and moves it back to the Free LDEVs table
- **Set:** Creates a LUSE volume consisting of the volumes in the Expanded LDEVs list. The LDEVs that are set as LUSE volume components are shown in blue in the LDEV Information table and the free LDEVs are deleted from the table.
- **Apply:** Registers the LUSE settings with the disk array
- **Cancel:** Cancels the LUSE settings

## Viewing LUSE Configuration Information

- The LDEV Information tree displays an outline view of the CU and LDEV numbers installed on the disk array in a hierarchical structure.
- The LDEV Information table displays detailed information for all open system LDEVs in the selected CU. If you select a normal LDEV, the information in this section is for the top LDEV. If you select a LUSE volume, the information in this table is for all of the LDEVs in the LUSE volume.

An LDEV number that ends with a # indicates that the LDEV is an external LU (for example, 00:01#).

## Viewing Concatenated Parity Groups

1. From the Volume Management pane, select a CU number in the LDEV Information tree. The LDEV Information table displays all the LDEVs in the selected CU.
2. In the LDEV Information table, select the free LDEVs for the LUSE volume and right-click. If the parity groups are concatenated, the **Concatenation List** command is available in the shortcut menu.
3. Select **Concatenation List**. The Concatenation List dialog box appears.
4. Click **OK** to return to the Volume Management pane.

## Creating a LUSE volume using the Volume Count list



**CAUTION:** Creating a LUSE volume destroys existing data. To protect your data, make a backup copy of the existing data before starting the LUSE creation operation.

1. From the Volume Management pane, select a CU number in the LDEV Information tree.
2. In the Select an LDEV list, select a top LDEV of the LUSE volume. The Expanded LDEVs list displays the selected volume. The Free LDEVs table displays normal LDEVs, allocated LDEVs, VSC volumes, and LUSE volumes that can be used for a LUSE volume.

If you select a LUSE volume as the top LDEV, the Volume Count list is unavailable, and [step 3](#) cannot be performed. In this case, select the LDEVs in the Free LDEVs table and click **Add**. To delete LDEVs, select the LDEVs in the Expanded LDEVs list and click **Delete**.

3. In the Volume Count list, select the number of LDEVs that should form a LUSE volume.

The Expanded LDEVs list displays as many LDEVs as specified in the Volume Count list. For example, if 3 is specified, the Expanded LDEVs list displays three LDEVs.



**NOTE:** You cannot select the LUSE volumes in the Volume Count list. To select LUSE volumes, select the LDEVs in the Free LDEVs table and click **Add**.

- To add more LDEVs to the Expanded LDEVs list, select one or more LDEVs in the Free LDEVs table and click **Add**.
  - To delete LDEVs from the Expanded LDEVs list, select one or more LDEVs in the Expanded LDEVs list and click **Delete**.
4. Click **Set**. A confirmation message appears.
    - If you are performing a LUSE operation on a path-defined volume, a confirmation message appears. Click **OK** to confirm. Another confirmation message appears. Go to [step 5](#).
    - If you are performing a LUSE operation on a volume that does not have a path definition, a confirmation message appears.
  5. To create a LUSE volume, click **OK**. The changes are shown in blue in the LDEV Information table.
  6. Click **Apply**. A confirmation message appears.
  7. Click **OK**. The LUSE settings are registered with the disk array. A dialog box appears when the requested action is complete.
  8. Click **OK**.

## Creating a LUSE volume using the Select an LDEV list

---

 **CAUTION:** Creating a LUSE volume destroys existing data. To protect your data, make a backup copy of the existing data before starting the LUSE creation operation.

---

1. In the Volume Management pane, select a CU number in the LDEV Information tree.
2. In the **Select an LDEV** list, select a top LDEV of the LUSE volume. The Expanded LDEVs list displays the selected volume. The Free LDEVs table displays normal LDEVs, allocated LDEVs, VSC volumes, and LUSE volumes that can be used for a LUSE volume.
  - To add LDEVs to the Expanded LDEVs list, select one or more LDEVs in the Free LDEVs table and click **Add**. The selected LDEV(s) are added to the Expanded LDEVs list and deleted from the Free LDEVs table.
  - To delete LDEVs from the Expanded LDEVs list, select one or more LDEVs in the Expanded LDEVs list and click **Delete**. The selected LDEV(s) are deleted from the Expanded LDEVs list and displayed in the Free LDEVs table.
3. Click **Set**. A confirmation message appears.
4. To perform a LUSE operation on a volume that has a path definition, click **OK**. If a message appears asking if you want to perform a LUSE operation that will affect more than one SLPR or CLPR, go to [step 5](#). Otherwise, go to [step 6](#).
5. To perform a LUSE operation that will affect more than one SLPR or CLPR, click **OK**. A confirmation message appears.
6. Click **OK**. The changes are shown in blue in the LDEV Information table.
7. Click **Apply**. A confirmation message appears.
8. Click **OK**. The LUSE settings are registered with the disk array. A dialog box appears when the requested action is complete.
9. Click **OK**.

## Creating a LUSE volume using the LDEV information table

---

 **CAUTION:** Creating a LUSE volume destroys existing data. To protect your data, make a backup copy of the existing data before starting the LUSE creation operation.

---

1. In the Volume Management pane, select a CU number in the LDEV Information tree.
2. In the LDEV Information table, select the normal LDEVs, VSC volumes, or LUSE volumes. Right-click the selection and select **Set LUSE Volume**.
  - a. To perform a LUSE operation on a volume that has a path definition, click **OK**. If a message appears asking if you want to perform a LUSE operation that will affect more than one SLPR or CLPR, go to [step 2](#). Otherwise, go to [step 3](#).

- b. To perform a LUSE operation on a volume that will affect more than one SLPR or CLPR, click **OK**. A confirmation message appears.

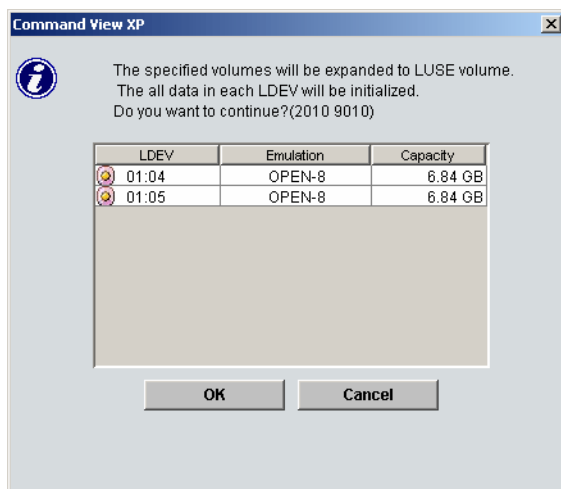

**Figure 130** LUSE creation confirmation message

3. Verify the information in the dialog box and click **OK**. The LUSE creation starts. The changes are shown in blue in the LDEV Information table.
4. Click **Apply**. A confirmation message appears.
5. Click **OK**. The LUSE setting is registered. A dialog box appears when the requested action is complete.
6. Click **OK**.

## Releasing a LUSE volume

**CAUTION:** This operation destroys data. To protect data, be sure to make a backup copy before starting the LUSE releasing operation.

1. In the Volume Management pane, select the CU number from which you want to release a LUSE volume. The LDEV Information table shows all LDEVs that the selected CU contains.
2. In the LDEV Information table, right-click the desired LUSE volume and select **Release LUSE Volume**. A LUSE release confirmation message appears.

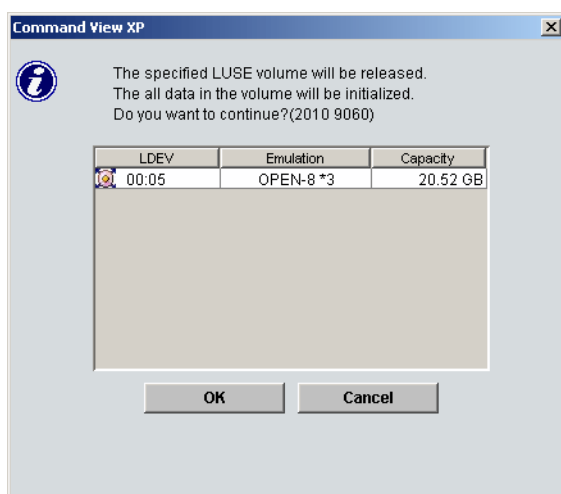

**Figure 131** LUSE release confirmation message

3. Verify that the information is correct and click **OK**. The LUSE release starts. The changes are shown in blue in the LDEV Information table.
4. Click **Apply**. A confirmation message appears.
5. Click **OK**. The LUSE volume is released. A dialog box appears when the requested action is complete.
6. Click **OK**.

## Changing LUSE capacities

- Expanding LUSE capacities

To expand the capacity of a LUSE volume, select the LUSE volume you want to expand, and then add LDEVs or LUSE volume(s), or first select the LDEVs or LUSE volume(s) you want to add, and then select a LUSE volume to be expanded. For more information, see ["Creating a LUSE volume using the Volume Count list"](#) on page 253, ["Creating a LUSE volume using the Select an LDEV list"](#) on page 254, or ["Creating a LUSE volume using the LDEV information table"](#) on page 254.

Each LDEV or LUSE volume that you want to add must have the same capacity as each LDEV in a LUSE volume to be expanded.

- Reducing LUSE capacities

You may not reduce the capacity of an existing LUSE volume. If you want a LUSE volume to have a smaller capacity, you must release and then redefine the LUSE volume.

## Resetting an unregistered LUSE volume

When you create a LUSE volume, the screen shows the changes in blue bold italics until you register the volume into the disk array by clicking **Apply**. The LUSE volume in blue bold italics indicates that you can reset this LUSE volume to the state before it was created.

If the XP disk array has firmware version 21.06.22 or later installed, you can reset an unregistered LUSE volume to the state before it was created. However, you cannot recover any LUSE volumes that have been released already to the state when they were created. If the LUSE volume that you have created consists of any LDEVs (those in blue bold italics) that have once been released from a different LUSE volume, you can only reset your LUSE volume to the state when the constituting LDEV(s) was released from the other LUSE volume.

1. In the Volume Management pane, select the CU number from which you want to reset an unregistered LUSE volume. The LDEV Information table shows all LDEVs that the selected CU contains.
2. In the LDEV Information table, right-click an unregistered LUSE volume (displayed in blue bold italics) and select **Reset Selected Volume**. A confirmation message appears.

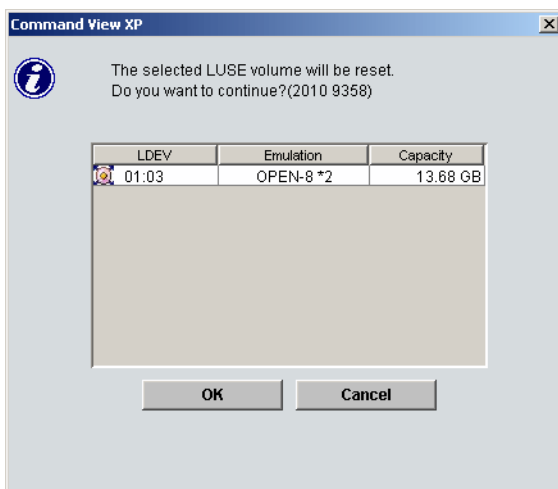

**Figure 132** LUSE reset confirmation message

3. Verify the information in the dialog box and click **OK**. The unregistered LUSE volume will be reset to the state before this LUSE volume was created. The LDEV Information table displays the LUSE volumes or the LDEVs constituting the selected LUSE volume that has just been reset.

## VSC Operations

Before beginning VSC operations, put the volumes in an offline state or unmount them (deallocate LUN paths).

Users belonging to the Administrator and StorageAdmin groups can perform VSC operations.

### Starting VSC operations

1. From the Device Launcher pane, click an XP128/XP1024/XP12000 link.
2. Click the **Volume Management** button (  Volume Mana... ). The Volume Management pane appears.
3. Click the **Customized Volume** tab. The Customized Volume pane appears.

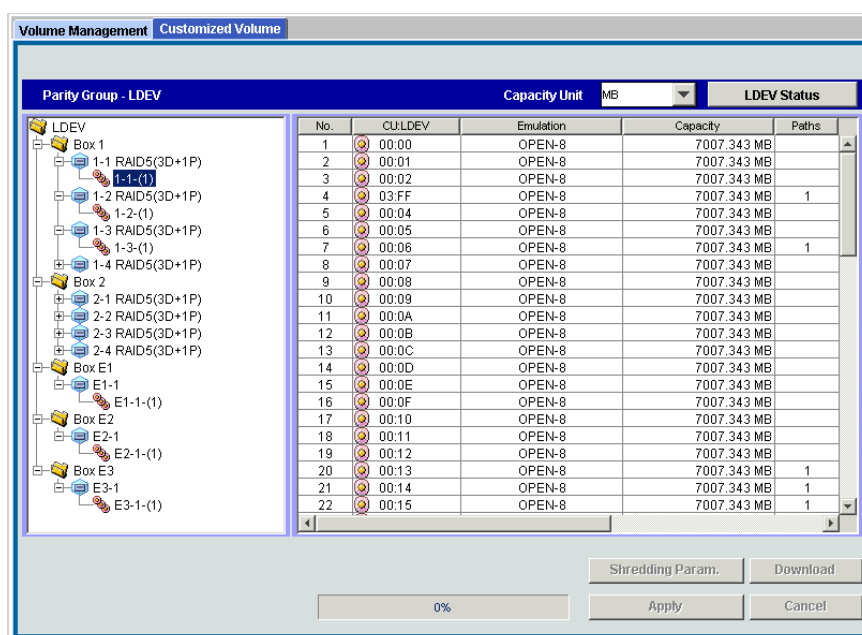

**Figure 133** Customized Volume pane (Volume Management screen)

## Customized volume screen

### Parity Group - LDEV tree



This tree shows a hierarchical structure of a disk group number (Box 1), parity group numbers (for example, 1-1), RAID levels (for example, 3D+1P), and VDEV numbers (for example, 1-1-1).

An LDEV number that ends with a # indicates that the LDEV is an external LU (for example, 00:01#).

The RAID level is left unspecified with a hyphen (-) when the LDEV is an external LU.



The status of each parity group is indicated by one of the following icons:

**Table 48** Parity group status icons

Icon	Status
	Parity group
	Set of concatenated parity groups.

The status of each VDEV is indicated by one of the following icons:

**Table 49** VDEV status icons







Icon	Status
	No pending VSC actions.
	VSC actions have been stored, but not yet implemented on the subsystem.

## Parity Group - LDEV table

This table shows information about volumes in a VDEV selected in the Parity Group - LDEV tree.

The status of each LDEV is indicated by one of the following icons:

**Table 50** LDEV status icons for VSC operations

Icon	Status
	Normal LDEV
	LUSE volume
	LDEV reserved for Auto LUN
	VSC volume
	VSC volume reserved for Auto LUN
	Free space

The table contains the following information:

- **No.:** The number of a volume in the VDEV
- **CU:LDEV:** A CU number/LDEV number combination. Free indicates a free space. An LDEV number that ends with a # indicates that the LDEV is an external LU (for example, 00:01#).
- **Emulation:** Emulation type of the volume
- **Capacity:** Capacity of the volume represented in the selected unit (MB, Cyl, or block)
- **Paths:** Number of LU paths that the volume has. This box is blank when the volume has no LU paths.
- **Access Attribute:** Access attribute of the volume



- **Status:** Status of the volume. You must click **LDEV Status** to display the volume status. [Table 51](#) describes the volume status displayed in the **Status** column.

**Table 51** Volume status

Status	Description
<b>Normal</b>	Volume is in a normal status
<b>Blocked</b>	Volume is in a blocked status. Hosts cannot access the blocked volume.
<b>Warning</b>	Volume has a problem.
<b>Format</b>	Volume is being formatted.
<b>Correction Access</b>	Volume's access attribute is being changed.
<b>Copying</b>	Volume's data is being copied.
<b>Read Only</b>	Hosts can only read the volume. Hosts cannot write any data to the volume.
<b>Unknown</b>	System does not recognize the volume's status.

## Capacity unit list

The Capacity Unit list allows you to select the unit (MB, Cyl, or block) to display for volume capacity.

When you manipulate mainframe volumes, you can only select Cyl.

## Buttons

- **Apply:** Registers the VSC settings
- **Cancel:** Cancels the VSC settings
- **LDEV Status:** Displays the current volume status

---

**NOTE:** Currently, the **Shredding Param** and **Download** buttons are not supported.

---

## Viewing VSC configuration information

Use the Customized Volume pane and its associated panes to view the current VSC configuration information:

- View the VDEV and LDEV configuration information on the Customized Volume pane. This pane shows an outline of group numbers, parity group numbers, RAID levels, and VDEV numbers and a table of CU:LDEV numbers, emulation types, LDEV capacities, and path settings of VDEVs selected in the outline.
- View the LDEV number setting information from the Install CV, Make Volume, and Volume Initialize panes. In the table, gray indicates LDEV numbers that are already in use, white indicates unused LDEV numbers, and blue indicates available LDEV numbers.

## Viewing concatenated parity groups

1. In the Customized Volume pane, select a set of parity groups from the Parity Group - LDEV tree and right-click. If the parity groups are concatenated, the **Concatenation List** command is available in the shortcut menu.

2. Select **Concatenation List**. The Concatenation List dialog box appears.
3. Click **OK**.

## Converting volumes to space (Volume to Space)

Use the Volume to Space function to convert logical volumes to space (free areas).



**CAUTION:** The Volume to Space operation destroys data on the logical volumes that are converted.

1. From the Customized Volume pane, select a disk group, a parity group, and a VDEV in the Parity Group - LDEV tree. The Parity Group - LDEV table displays information about LDEVs in the selected VDEV.
2. Select one or more LDEVs (normal or custom volumes) you want to convert to space.

For the OPEN-V emulation type, LUSE volumes can also be converted into free space. If the available LDEV is a LUSE volume, the emulation type is displayed together with an asterisk and the number of volumes in the LUSE volume (for example, OPEN-V\*3) in the Emulation column of the table.

To select two or more consecutive LDEVs, click the LDEVs while pressing the **Shift** key. To select two or more non-consecutive LDEVs, click the LDEVs while pressing the **Ctrl** key.



**NOTE:** You cannot change all LDEVs in the selected VDEV into space. You cannot select the last normal or custom volume.

3. Right-click the selected LDEV and select **Volume to Space**. A volume confirmation dialog box is displayed.

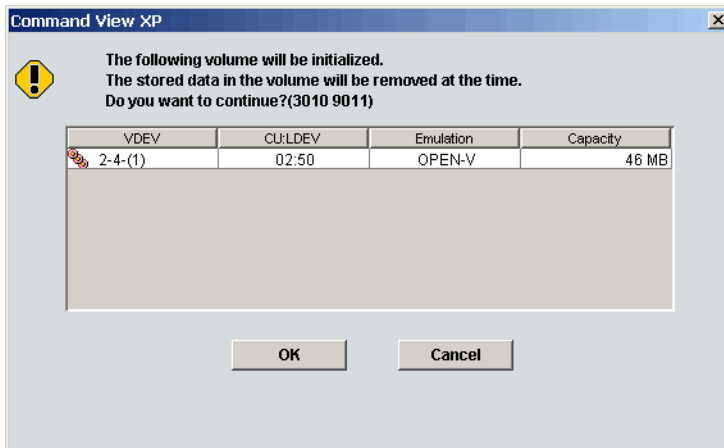

**Figure 134** Volume to space confirmation

4. Click **OK**. The Parity Group - LDEV table is displayed and the selected LDEVs are marked Free. The figures in the Capacity column are not yet updated, and the color of the VDEV icon that you manipulated changes from red to blue. You cannot manipulate blue VDEVs until you click **Apply** or **Cancel**.
5. Click **Apply**. a confirmation message appears.
6. Click **OK**. The LDEVs are converted to space. A dialog box appears when the requested action is complete.
7. Click **OK**.

## Creating custom volumes (Install CV)

Use the Install CV function to create and install one or more custom volumes in the free space that is prepared by the Volume to Space function. The Install CV function can define (install) one or more new custom volumes in the free space prepared when volumes are created in VDEVs.

1. In the Customized Volume pane, click the LDEV folder in the Parity Group - LDEV tree to open a list of CUs, and then select a VDEV. The Parity Group - LDEV table displays information about LDEVs in the selected VDEV.
2. Right-click any part of the Parity Group - LDEV tree and select **Install CV**.

If the selected VDEV is an OPEN-V volume, the Install CV pane (1) for OPEN-V appears (Figure 135). Go to [step 3](#).

If the VDEV you selected is not an OPEN-V volume, the Install CV pane (1) for non-OPEN-V appears (Figure 136). Go to [step 4](#).

Command View XP

**Install CV**

Parity Group: 2-4-(1)

Emulation: OPEN-V

How to Create Volumes

No.	Emulation	Capacity
-----	-----------	----------

Capacity Unit: MB

Specify capacity and number

Capacity: 46 MB (46 - 9641 MB)

Number: 1 (1 - 200)

Divide free space by number

Number: [ ]

Divide free space by capacity

Capacity: [ ] MB

Set remaining space as volume

available LDEVs: 251

Buttons: Set, Delete, Clear, Next, Cancel

**Figure 135** Install CV pane (1) for OPEN-V (when two or more free spaces are available)

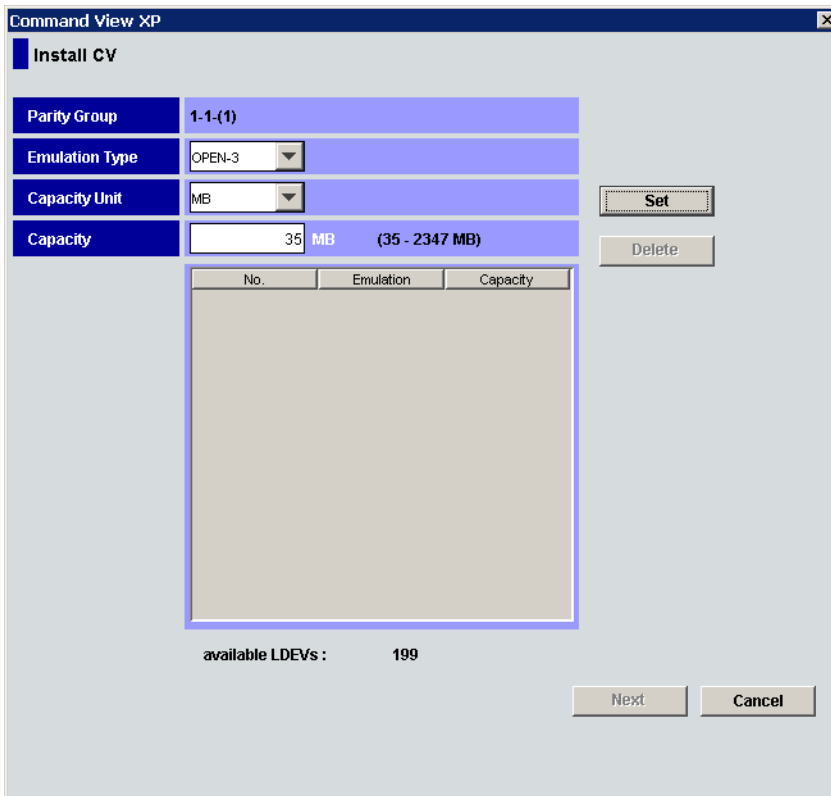

**Figure 136** Install CV pane (1) for other than OPEN-V

3. From the Install CV pane (1) for OPEN-V, do the following:

- a. In the Capacity Unit area, select **MB**, **Cyl**, or **block** for the capacity unit.
- b. Select one of methods by clicking **Specify capacity and number**, **Divide free space by number**, **Divide free space by capacity**, or **Set remaining space as volume**.



**NOTE:** If there are two or more free spaces in the VDEV, only the **Specify capacity and number** option is available.

- c. Specify the capacity of the volume and/or the number of volumes according to the selected method. For example:
  - If you selected **Specify capacity and number**, enter the capacity, either in MB, Cyl, or blocks, in the Capacity box and the number of custom volumes in the Number box.
  - If you selected **Divide free space by number**, enter the number of custom volumes in the Number box.
  - If you selected **Divide free space by capacity**, enter the capacity in the Capacity box.
  - If you selected **Set remaining space as volume**, go to [step 3d](#).

The Install CV Volume function allocates custom volumes in the order in which the function finds sufficient free space for the custom volumes, so for optimum space allocation you should allocate custom volumes in descending order of capacity.

- d. Click **Set**. The pane displays the selected custom volumes.

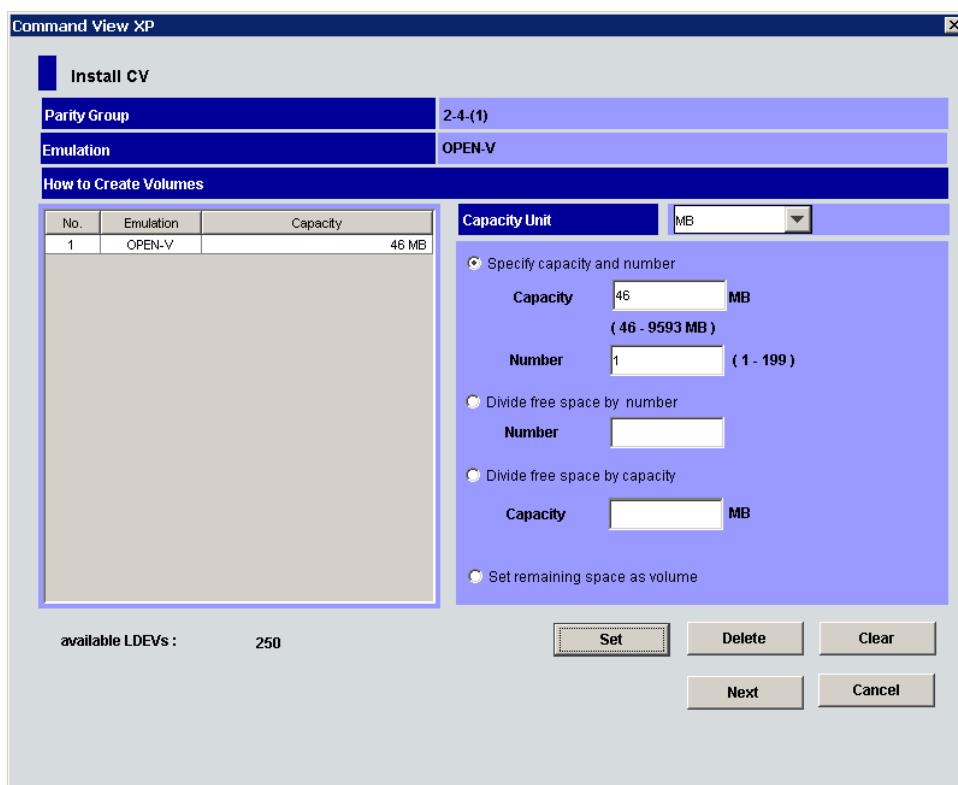

**Figure 137** Install CV pane (1) for OPEN-V after clicking Set

- e. To create other custom volumes, repeat [step 3a](#) through [step 3d](#).
  - f. To delete a custom volume, select the custom volume, click **Delete**, and then click **OK** to the confirmation message. To delete all custom volumes, click **Clear**, and then click **OK**. Go to [step 5](#).
4. From the Install CV pane (1) for other than OPEN-V, do the following:
    - a. In the **Emulation Type** list, select the emulation type.
    - b. In the **Capacity** box, enter the capacity of the custom volume you want to create. Use MB or blocks for open systems and cylinders (Cyl) for mainframe volumes. The available capacity range (minimum - maximum) appears to the right of the **Capacity** box. The value can be increased incrementally by one MB or block (open systems) or by one cylinder (mainframe systems).  
 The Install CV function allocates custom volumes in the order in which the function finds free space sufficient enough to hold them. Allocate custom volumes in descending order of capacity for optimum space allocation.

- c. Click **Set**. The pane displays the selected custom volumes.

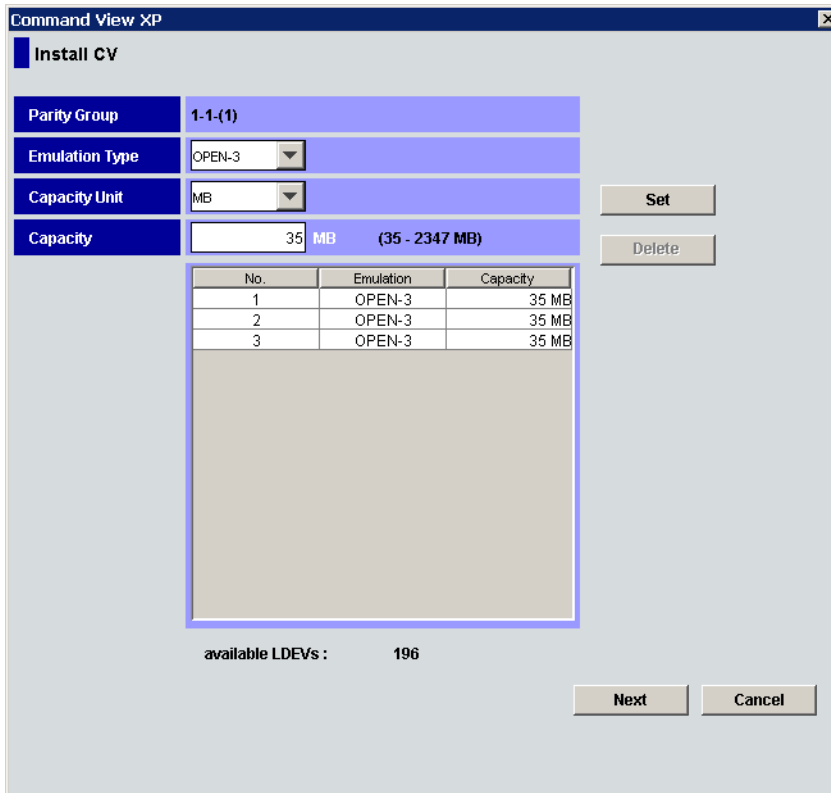

**Figure 138** Install CV pane (1) for other than OPEN-V after clicking Set

- d. Repeat [step 4a](#) through [step 4c](#) to create additional custom volumes.
- e. To delete a custom volume, click the custom volume, click **Delete**, and then click **OK**.

5. After configuring custom volumes, click **Next**. The Install CV pane (2) is displayed.

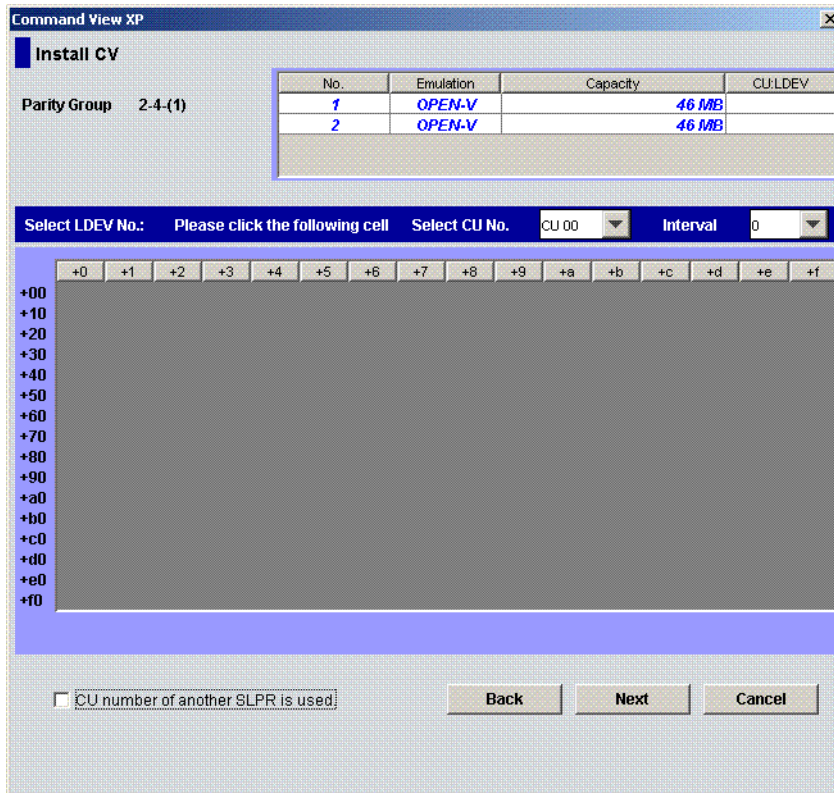

**Figure 139** Install CV pane (2)

Use this pane to assign the CU and LDEV numbers of a custom volume to be created. The top area is the *CV setting information* area and shows detailed information about the custom volumes to be created. The bottom area is the *LDEV number setting* area and is used to set the CU and LDEV numbers for the custom volume to be created.

6. In the CV setting information area, select one or more custom volumes.
7. In the Select CU No. list, select a CU number. The LDEV number setting area is updated to reflect the selected CU number.
8. If you selected multiple custom volumes, select an interval from the Interval list. This value specifies the interval between the LDEV numbers that need to be assigned to the new volumes. The default value is 0. When you select 0, consecutive LDEV numbers are assigned. The value you specify as the interval between LDEV numbers counts only the available LDEV numbers.
9. In the LDEV number setting area, select an LDEV number by clicking the appropriate white box. For example, to select an LDEV number of 96, click the +90/+6 box as shown in [Figure 140](#).



**NOTE:** The **CU number of another SLPR is used** check box is displayed only when you logged in as a user in the StorageAdmin group with full array access and when there are two or more SLPRs. When the **CU number of another SLPR is used** check box is selected, you can select the number of an LDEV that does not exist in an SLPR to which the priority group does not belong. When the check box is cleared, you can only select the number of an LDEV in the SLPR to which the parity group belongs.

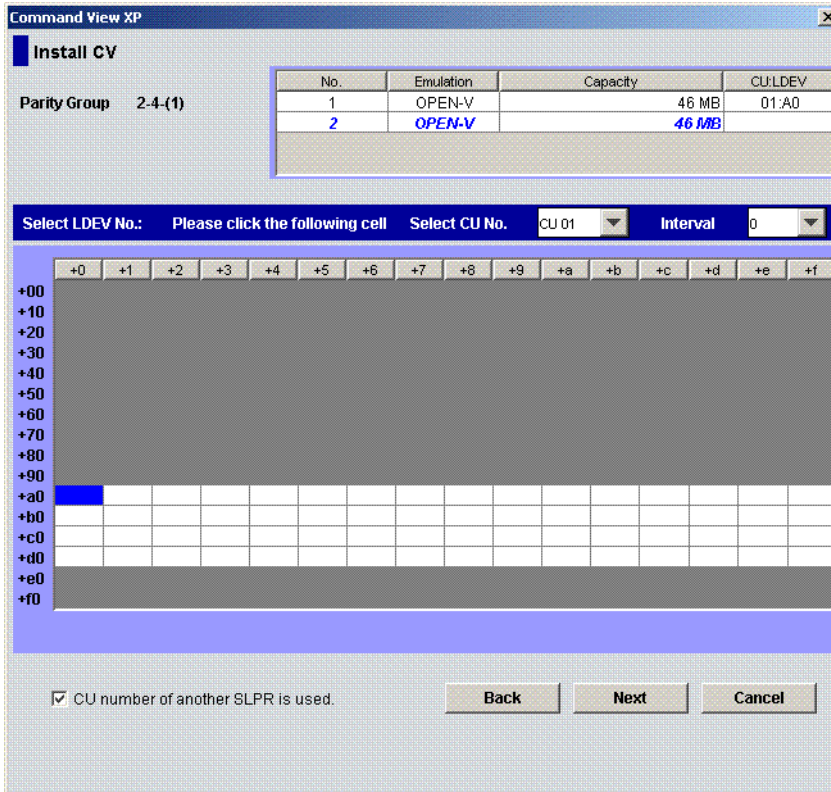

**Figure 140** Select an LDEV number

The CU:LDEV number in the CV setting information area is updated.



**NOTE:** If you specify an LDEV number in the selected CU, free sequential LDEV numbers in LUSE configuration are automatically assigned. You cannot specify an LDEV number, if free LDEV numbers in LUSE configuration are not available in either of the following CUs:

- The CU displayed in the **Select CU No.** list.
- A CU whose CU number is larger than the CU number displayed in the **Select CU No.** list.

**10.** Repeat [step 6](#) - [step 9](#) to set additional custom volumes.

**11.** To change a set volume, right-click the volume in the CV setting information area, and select **Clear**.

**12.** After setting all CU and LDEV numbers, click **Next**.

If the boundary area of the selected LDEV number does not have an SSID, a dialog box is displayed for setting the SSID ([Figure 141](#)). Go to [step 13](#).



If the boundary area of the selected LDEV number has an SSID, the Install CV confirmation dialog box is displayed (Figure 142). Go to step 15.

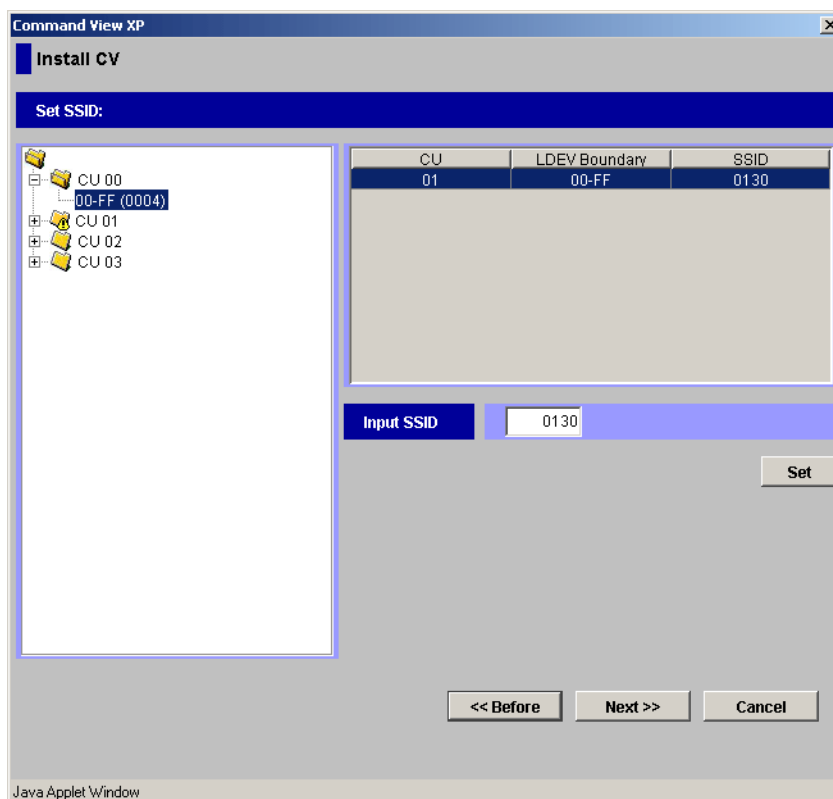

**Figure 141** Setting the SSID

**13.** In the SSID setting area, select a CU number to assign an SSID to, enter a new SSID in the Input SSID box, and click **Set**. The SSID is displayed in the SSID box of the SSID setting area. Repeat this step until all the SSIDs are set.



**NOTE:** You can enter the SSID only when logged in as a user in the StorageAdmin group with full array access.



**NOTE:** The **SSID of another SLPR is used** check box is displayed only when you logged in as a user in the StorageAdmin group with full array access and when there are two or more SLPRs. When the **SSID of another SLPR is used** check box is selected, you can select the number of an SSID that does not exist in an SLPR to which the parity group does not belong. When the check box is cleared, you can only select the number of the SSID in the SLPR to which the parity group belongs.

You cannot enter the number in the **Input SSID** box when the **SSID number of another SLPR is used** check box is cleared.

14. After setting all the SSIDs, click **Next**. The Install CV confirmation dialog box is displayed.

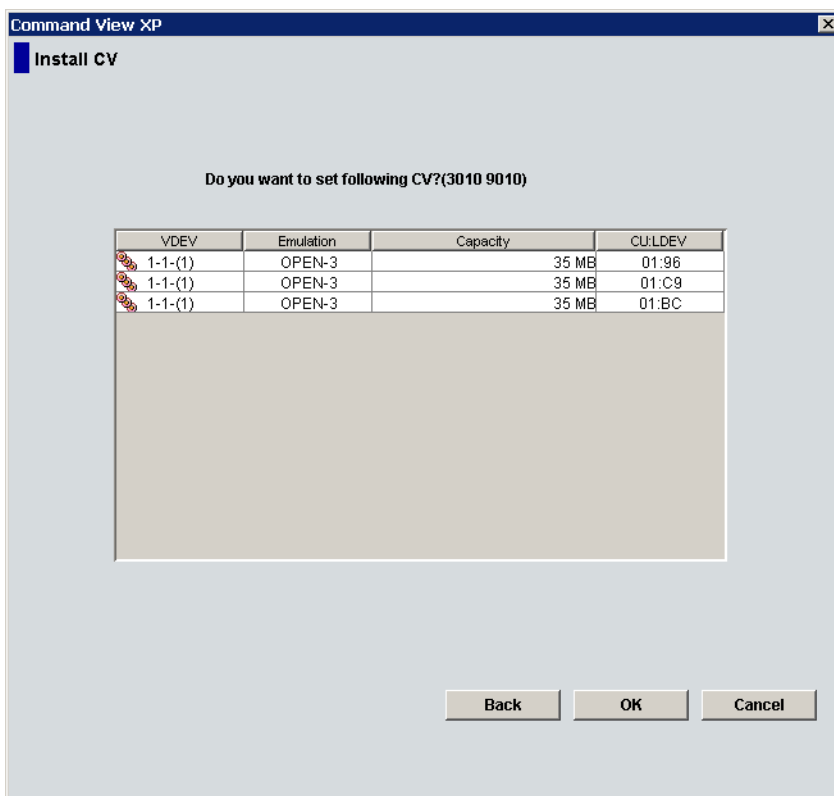

Figure 142 Install CV confirmation dialog box

15. Verify that the information in the Install CV confirmation dialog box is correct, and click **OK**. The Customized Volume screen is displayed with the new settings in blue.

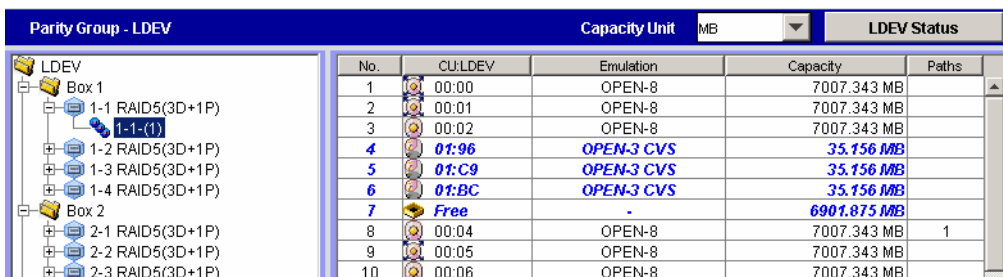

Figure 143 Customized volume screen

16. Click **Apply**. a confirmation message appears.

17. Click **OK**. The custom volume is created. A dialog box appears when the requested action is complete.

18. Click **OK**.

## Deleting custom volumes (Volume to Space)

To delete a custom volume from a VDEV, convert the custom volume into free space with the Volume to Space function (see "Converting volumes to space (Volume to Space)" on page 260).

## Creating initial custom volumes for OPEN-V (Make Volume)

Use the Make Volume function to clear all custom volumes under a VSC volume and create an initial volume (VDEV) that consists of new user-defined custom volumes.



**CAUTION:** The Make Volume function is a destructive operation and destroys the data on selected custom volumes. Back up the data as needed before performing this operation.

1. From the Customized Volume pane, click the LDEV folder in the Parity Group - LDEV tree to open a list of CUs, and then select a VDEV. The Parity Group - LDEV table displays information of LDEVs in the selected VDEV.



**NOTE:** If the selected VDEV contains one or more custom volumes that violates any restriction for the Make Volume function (see “Volume to Space operation” on page 245), you cannot perform the Make Volume function. Remove all invalid custom volumes before performing the Make Volume function.

2. Right-click any part of the Parity Group - LDEV tree and select **Make Volume**. The Make Volume pane (1) appears.

No.	Emulation	Capacity
-----	-----------	----------

available LDEVs : 256

**Figure 144** Make Volume pane (1)

3. From the Make Volume pane (1), do the following:
  - a. In the Capacity Unit list, select **MB**, **Cyl**, or **block** for the capacity unit.
  - b. Select one of methods by clicking **Specify capacity and number**, **Divide free space by number**, **Divide free space by capacity**, or **Set remaining space as volume**.



**NOTE:** If there are two or more free spaces in the VDEV, only the **Specify capacity and number** option is available.

- c. Specify the capacity of the custom volume and/or the number of custom volumes according to the selected method. For example:
  - If you selected **Specify capacity and number**, enter the capacity, in MB, Cyl, or blocks, in the **Capacity** box and the number of custom volumes in the **Number** box.

- If you selected **Divide free space by number**, enter the number of custom volumes in the **Number** box.
- If you selected **Divide free space by capacity**, enter the capacity in the **Capacity** box.
- If you selected **Set remaining space as volume**, go to the next step.

d. Click **Set**. The pane displays the setting in the table.

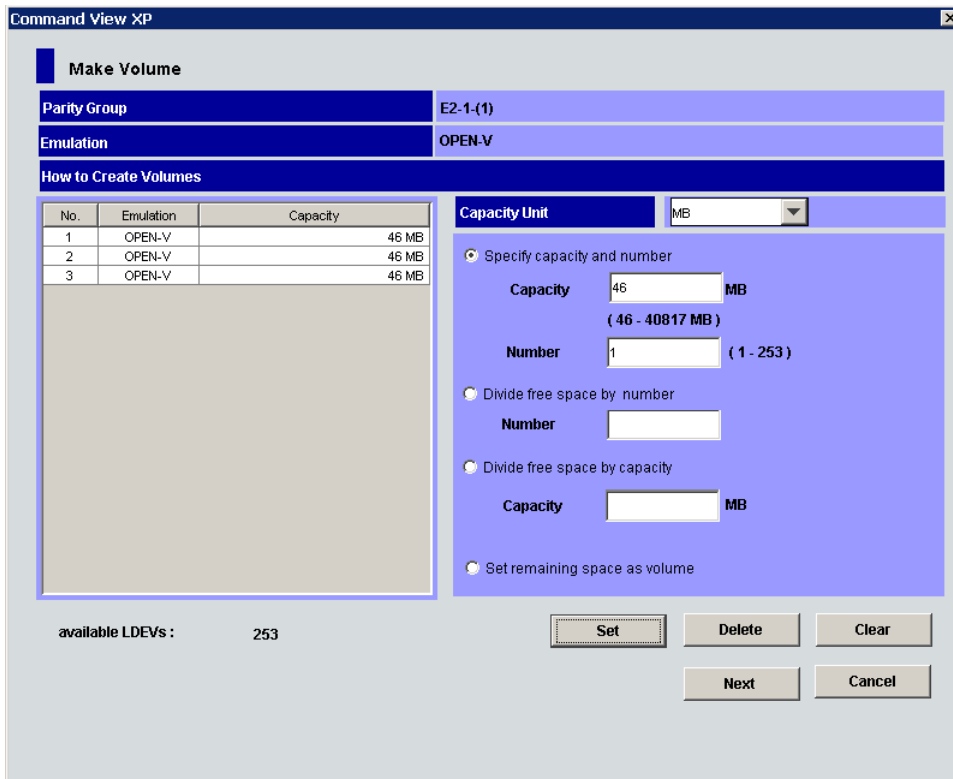
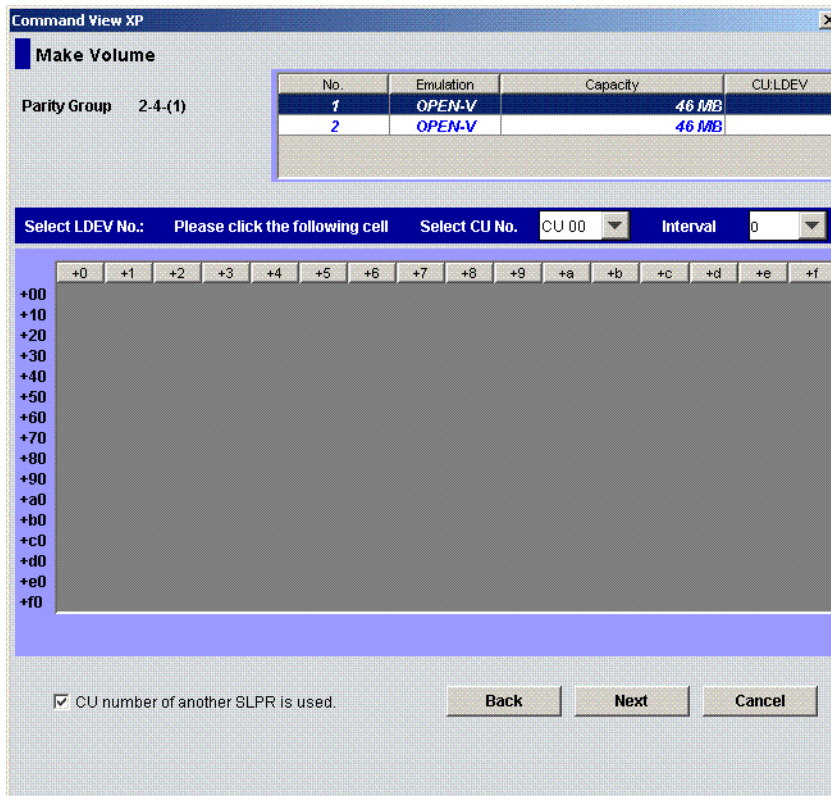

**Figure 145** Make Volume pane (1) after clicking Set

- e. To set other custom volumes, repeat [step 3a](#) through [step 3d](#).
  - f. To remove a setting, select the custom volume, click **Delete**, and then click **OK**. To remove all settings, click **Clear**, and then click **OK**.
4. After setting all custom volumes, click **Next**. The Make Volume pane (2) appears.



**NOTE:** If no CV is set, the Make Volume operation does not create a volume in the VDEV. In this case, a message appears and the Volume Management pane appears.



**Figure 146** Make Volume pane (2)

Use this pane to assign CU and LDEV numbers to the custom volumes to be created. The top area is the *CV setting information area* and shows detailed information about the custom volumes to be initialized. The bottom area is the *LDEV number setting area* and is used to set the CU and LDEV numbers for the custom volume to be initialized.

5. In the CV setting information area, select one or more custom volumes.
6. In the **Select CU No.** list, select a CU number.
7. If you selected multiple custom volumes, select an interval from the Interval list. This value specifies the interval between the LDEV numbers that need to be assigned to the new volumes. The default value is 0. When you select 0, consecutive LDEV numbers are assigned. The value you specify as the interval between LDEV numbers counts only the available LDEV numbers.
8. In the LDEV number setting area, select an LDEV number by clicking the appropriate white box. For example, to select an LDEV number of 97, click the +90/+7 box as shown in [Figure 147](#).



**NOTE:** The **CU number of another SLPR is used** check box is displayed only when you logged in as a user in the StorageAdmin group with full array access and when there are two or more SLPRs. When the **CU number of another SLPR is used** check box is selected, you can select the number of an LDEV that does not exist in an SLPR to which the parity group does not belong. When the check box is cleared, you can only select the number of an LDEV in an SLPR to which the parity group belongs.

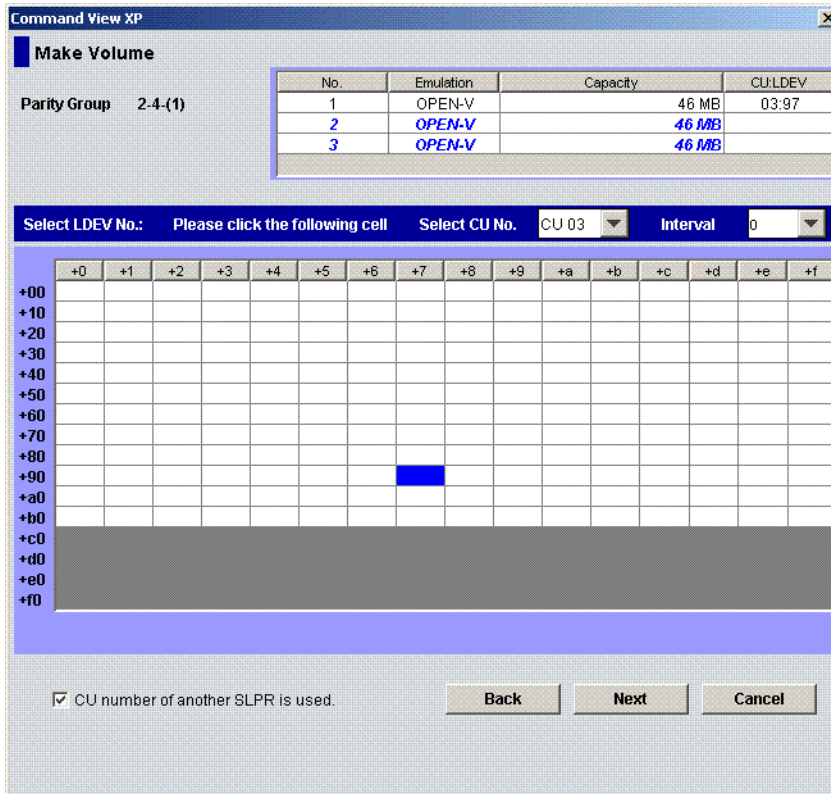

**Figure 147** Select an LDEV number

The CU:LDEV number in the CV setting information area is updated.



**NOTE:** If you specify an LDEV number in the selected CU, free sequential LDEV numbers in LUSE configuration are automatically assigned. You cannot specify an LDEV number if free LDEV numbers in LUSE configuration are not available in either of the following CUs:

- The CU displayed in the **Select CU No.** list.
- A CU whose CU number is larger than the CU number displayed in the **Select CU No.** list.

**9.** Repeat [step 5](#) - [step 8](#) to set additional volumes.

**10.** To change a set volume, right-click the volume and select **Clear** from the shortcut menu.

**11.** After setting all CU and LDEV numbers, click **Next**.

If the boundary area of the selected LDEV number does not have an SSID, a dialog box is displayed for setting the SSID. Go to [step 12](#).

If the boundary area of the selected LDEV number has an SSID, the Make Volume confirmation dialog box is displayed. Go to [step 14](#).

12. In the SSID setting area, select a CU number to assign an SSID to it, enter a new SSID in the Input SSID box, and click **Set**. The SSID is displayed in the SSID box of the SSID setting area. Repeat this step until all the SSIDs are set.
13. After setting all the SSIDs, click **Next**. The Make Volume confirmation pane is displayed.

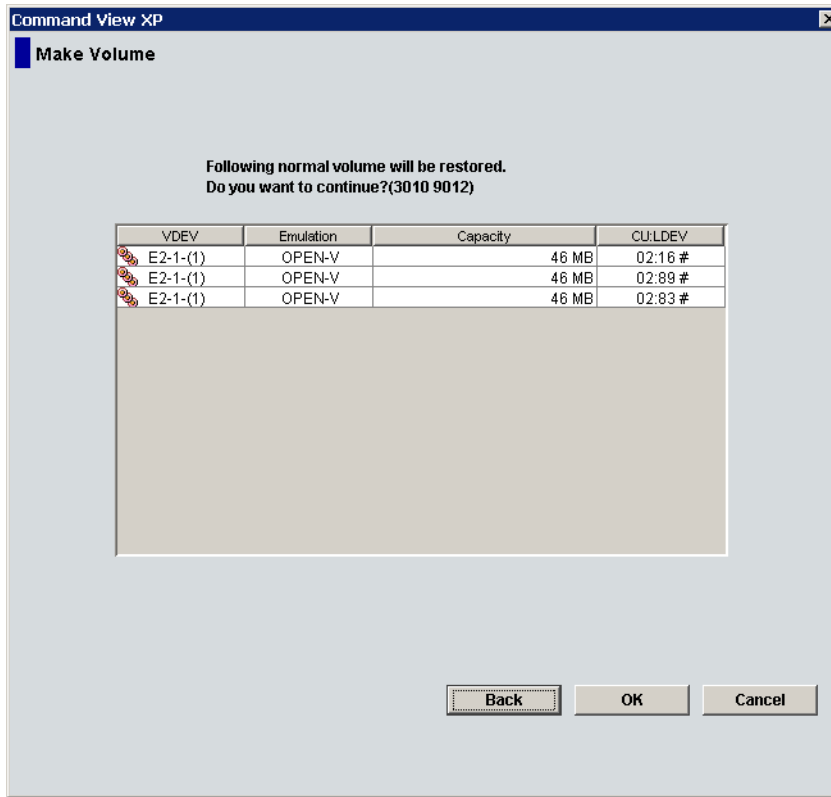

**Figure 148** Make Volume confirmation message

14. Verify that the information is correct and click **OK**. The Customized Volume pane is displayed. The created custom volumes are shown in blue.



**NOTE:** You cannot manipulate the VDEVs denoted by blue icons until you apply the changes to the disk array or cancel them, but you can initialize additional custom volumes in VDEVs denoted by red icons.

15. Click **Apply**. A confirmation message appears.
16. Click **OK**. The Make Volume operation begins. When LDEV formatting is in progress and at completion, a notation is displayed across the bottom of the screen to indicate the progress. A dialog box is displayed when the requested action is complete.
17. Click **OK**.

## Initializing custom volumes for other than OPEN-V (Volume Initialize)

Use the Volume Initialize function to uninstall all custom volumes under a VSC volume, and reformat the VSC volume as a normal volume (VDEV).



**CAUTION:** The Volume Initialize function is a destructive operation and destroys the data on selected custom volumes. Back up the data as needed before performing this operation.

1. From the Customized Volume pane, click the LDEV folder in the Parity Group - LDEV tree to open a list of CUs, and then select a VDEV. The Parity Group - LDEV table displays information about the LDEVs in the selected VDEV.



**NOTE:** If the selected VDEV contains one or more custom volumes that violates any restriction for the Volume Initialize function (see “[Volume to Space operation](#)” on page 245), you cannot perform the Volume Initialize function. Remove all invalid custom volumes before performing the Volume Initialize function.

2. Right-click any part of the Parity Group - LDEV tree and select **Volume Initialize**. The Volume Initialize pane is displayed.

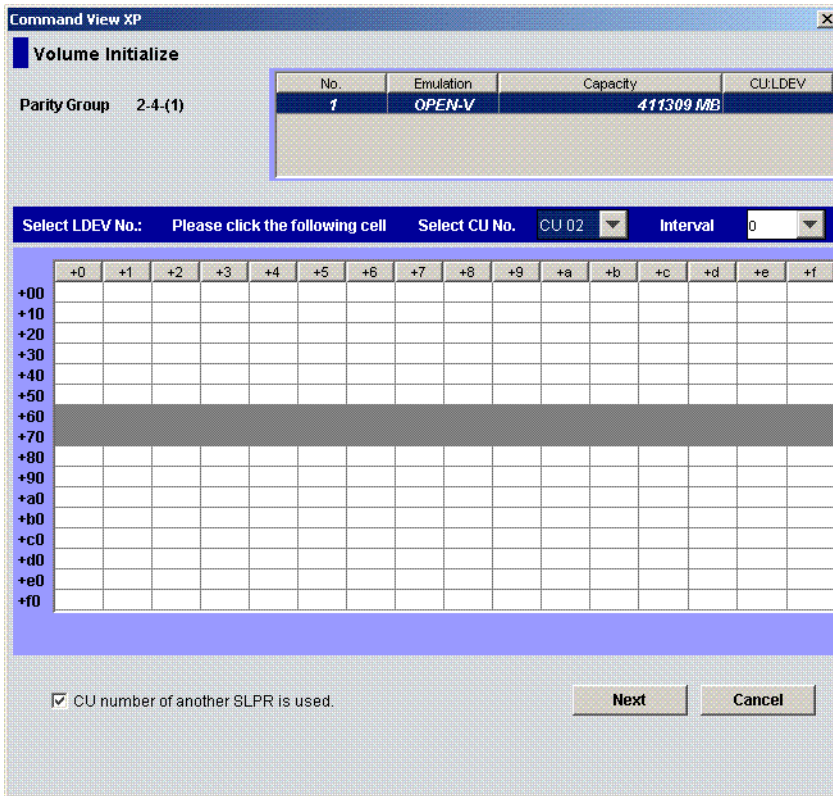

**Figure 149** Volume Initialize pane

Use this pane to initialize custom volumes other than OPEN-V. The top area is the *CV setting information area* and shows detailed information about the custom volumes to be initialized. The bottom area is the *LDEV number setting area* and is used to set the CU and LDEV numbers for the custom volume to be initialized.

3. In the CV setting information area at the top of the pane, select one or more custom volume numbers.
4. In the Select CU No. list, select a CU number. The LDEV number setting area is updated to reflect the selected CU number.
5. In the LDEV number setting area, select an LDEV number by clicking the appropriate white box. For example, to select an LDEV number of 16, click the +10/+6 box as shown in [Figure 150](#).





**NOTE:** The **CU number of another SLPR is used** check box is displayed only when you logged in as a user in the StorageAdmin group with full array access and when there are two or more SLPRs. When the **CU number of another SLPR is used** check box is selected, you can select the number of an LDEV that does not exist in an SLPR to which the parity group does not belong. When the check box is cleared, you can only select the number of an LDEV in an SLPR to which the parity group belongs.

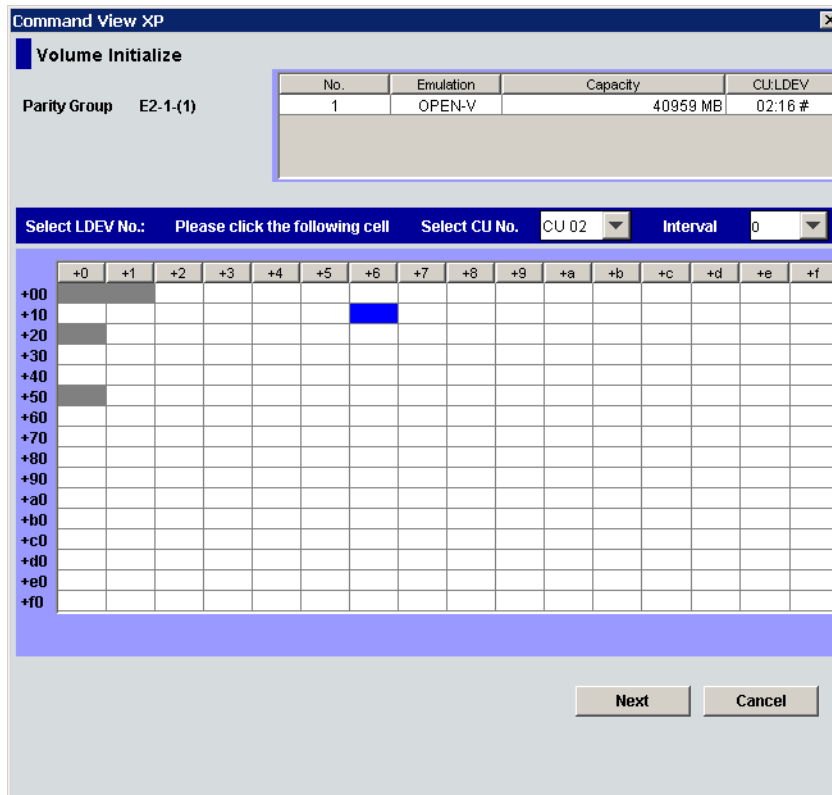

**Figure 150** Select an LDEV number

The CU:LDEV number in the CV setting information area is updated.

6. To set additional volumes, repeat [step 3](#) - [step 5](#).
7. To change a set volume, right-click the volume and select **Clear** from the shortcut menu.
8. After setting all CU and LDEV numbers, click **Next**.

If the boundary area of the selected LDEV number does not have an SSID, a dialog box is displayed for setting the SSID. Go to [step 9](#).

If the boundary area of the selected LDEV number has an SSID, the Volume Initialize confirmation dialog box is displayed. Go to [step 11](#).

9. In the SSID setting area, click a CU number to assign an SSID to it, select or enter a new SSID in the **Input SSID** box, and click **Set**. The SSID is displayed in the SSID box of the SSID setting area. Repeat this step until all the SSIDs are set.



**NOTE:** You can enter the SSID in the **Input SSID** box only when logged in as a user in the StorageAdmin group with full array access.



**NOTE:** The **SSID of another SLPR is used** check box is displayed only when you logged in as a user in the StorageAdmin group with full array access and when there are two or more SLPRs. When the **SSID of another SLPR is used** check box is selected, you can select the number of an SSID that does not exist in an SLPR to which the parity group does not belong. When the check box is cleared, you can only select the number of the SSID in the SLPR to which the parity group belongs.

You cannot enter the number in the **Input SSID** box when the SSID number of another SLPR is used check box is cleared.

10. After setting all the SSIDs, click **Next**. The Volume Initialize confirmation pane is displayed.

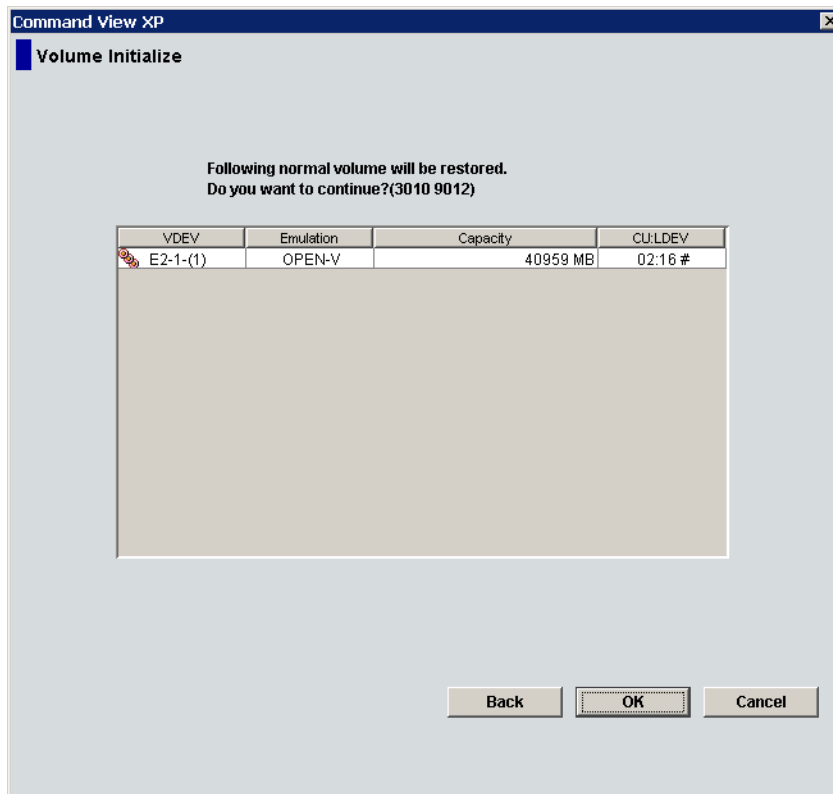

**Figure 151** Volume Initialize confirmation pane

11. Verify that the information in the Volume Initialize pane is correct and click **OK**. The Customized Volume pane is displayed.

A notation is displayed across the top of the screen to indicate that the volume has been initialized, and the color of the VDEV icon that you manipulated in the Parity Group - LDEV outline view changes from red to blue.



**NOTE:** You cannot manipulate VDEVs with blue icons until you apply the changes to the subsystem or cancel them, but you can initialize additional custom volumes in VDEVs with red icons.

12. Click **Apply**. a confirmation message appears.

13. Click **OK**. The Volume Initialize operation begins. When LDEV formatting is in progress and at completion, a notation is displayed across the bottom of the screen to indicate the progress.

## Formatting LDEVs

The LDEV Format feature allows you to format external volumes (including external volumes). To format volumes, use the following procedure to ensure that the volumes are in block status:

1. Click the **LDEV Status** button in the Customized Volume pane.
2. Confirm that the current status of the desired external mainframe volume is displayed as `Normal` in the Status column of the Parity Group - LDEV table.
3. Right-click an external mainframe volume and select **Blockade** from the shortcut menu. A confirmation message appears. Click **OK**.
4. The status of the volume in the Parity Group - LDEV table changes to **Blocked**, and the selected volume is displayed in blue.
5. Click **Apply**. When prompted to confirm the changes, click **OK**. The new setting is implemented into the subsystem and a message notifies you that the implementation is complete. Click **OK**.
6. Confirm that the volume is listed as `Blocked` in the Status column of the Parity Group - LDEV table.
7. To specify blocked volumes to format, do one of the following:
  - Select the volume with **Blocked** status in the LDEV Information table, right-click, and select **Format**.
  - To format all blocked internal and external volumes, right-click **LDEV** at the top of the tree, and select **All Format**. In the All Format pane, select **All Type** from the **Parity Group Type** list. Confirm that the list displays internal and external volumes to be formatted, and click **OK** to close the All Format pane.
  - To format all blocked internal volumes, right-click **LDEV** at the top of the tree, and select **All Format**. In the All Format pane, select **Internal PG** from the **Parity Group Type** list. Confirm that the list displays internal volumes to be formatted, and click **OK** to close the All Format pane.
8. Confirm that the volume is listed in blue with a status of `Format` in the Parity Group - LDEV table.
9. Click the **Apply** button in the Customized Volume pane. When prompted for confirmation, click **OK**. The words `Format in progress` appear next to the Progress Bar.
10. When the percentage shown on the Progress Bar reaches 100%, a message informs you that the format operation is complete. Click **OK**.
11. Confirm that the status of the volume is `Normal`.

## Formatting all blocked volumes

Use the All Format pane to format all blocked volumes in parity groups in the local disk array and/or external disk array. This pane contains the following:

- **Parity Group Type:** Volumes to be formatted.
  - **All Type:** Formats blocked volumes in all parity groups in the local and external disk arrays.
  - **Internal PG:** Formats blocked volumes in all parity groups in the local disk array.
  - **External PG:** Formats block volumes in all parity groups in the external disk array.
- **List:** Information about volumes to be formatted.
  - **PG:** Parity groups containing volumes to be formatted.
  - **Blocked Count:** Number of blocked volumes to be formatted.
- **OK:** Applies settings to the Volume Management pane, and closes the All Format pane.
- **Cancel:** Cancels settings, and closes the All Format pane.

# Operational restrictions

The success of some volume management activities depends on the status of the security switch and whether I/O is active or inactive to the port or LUN. The following tables describe those restrictions.

## Restrictions on VSC and LUSE operations

**Table 52** VSC and LUSE operation restrictions (XP128/XP1024/XP12000)

Activity		Security Switch OFF		Security Switch ON	
		Host Group 0	Host Group 01-7F	Host Group 0	Host Group 01-7F
Volume to Space (VSC operation)	With active I/O on LUN	Not permitted	Invalid operation	Not permitted	
	With no active I/O on LUN	Permitted		Permitted	
Make Volume/Volume Initialize (VSC operation)	With active I/O on LUN	Not permitted	Invalid operation	Not permitted	
	With no active I/O on LUN	Permitted		Permitted	
Deleting a LUSE volume	With active I/O on	Not permitted	Invalid operation	Not permitted	
	With no active I/O on	Permitted		Permitted	

## Data Shredder

If you change the user for a volume, you should delete data stored by the previous user for security purposes. The Data Shredder feature deletes data on volumes and prevents deleted data from being restored. *Shredding operation* refers to the process of deleting all data on a volume by overwriting it with dummy data.

Data Shredder is based on DoD5220.22-M, which is the standard defined by the U.S. Department of Defense.

Data Shredder is used for both open and mainframe systems.



**NOTE:** Data Shredder is only available in Command View 2.1, and can be used only for the XP128/XP1024 disk array. Data Shredder cannot be used for the XP12000 disk array.

# Overview of Shredding operations

The Shredding operation completely deletes data on a specified volume by repeatedly overwriting existing data with dummy data. You perform Shredding operations from the Command View management station. [Figure 152](#) shows an example of Shredding operations.

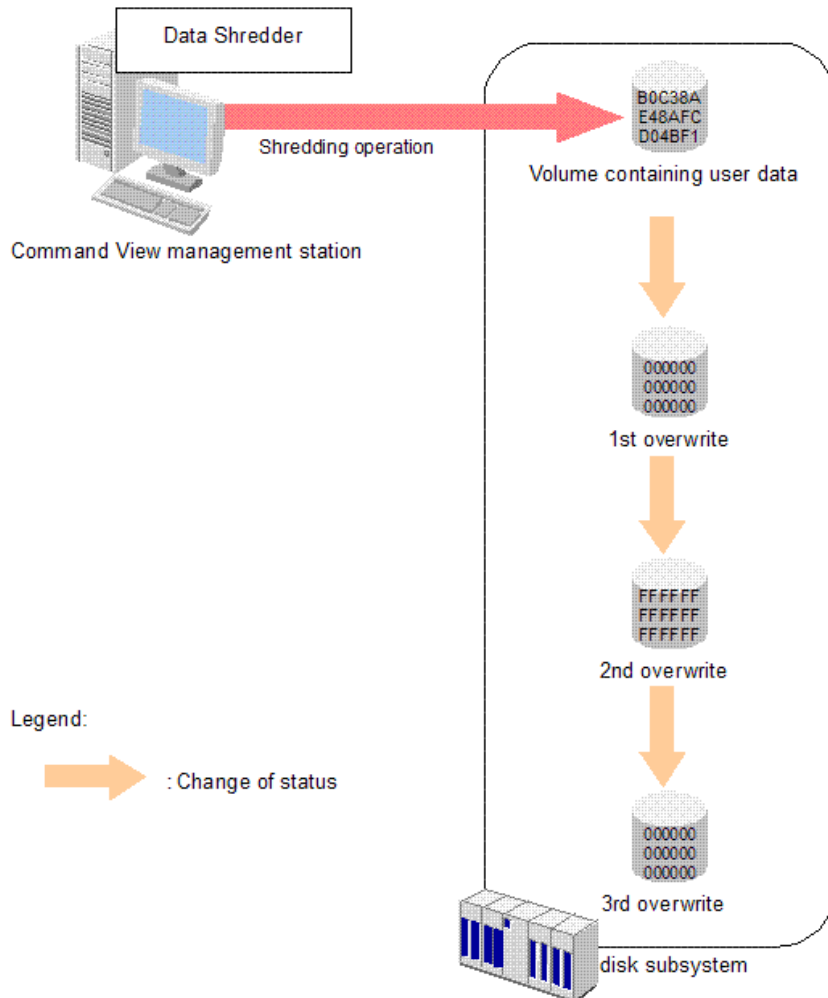

**Figure 152** Overview of Shredding operations

Because of the nature of hard disks, overwriting a volume once is not enough to completely delete data, which means deleted data could be restored. Therefore, HP recommends you overwrite a volume with dummy data at least three times.

By default, Data Shredder overwrites volumes with dummy data three times. You can change the default and overwrite the volume up to eight times. For more information, see ["Defining Shredding operation settings"](#) on page 282.

## Target volumes for Shredding operations

You can use the Shredding operation for any type of volume (for example, VDEV, LDEV, or CV) and emulation type, but the status of the volume must be **Blocked**. If the status is **Normal**, the volume cannot be the target of Shredding operations. For instructions to change the status of a volume to **Blocked**, see ["Preparing for Shredding operations"](#) on page 282.



**NOTE:** Select target volumes for Shredding operations in the Volume Manager pane. You cannot perform Shredding operations on external volumes. For more information, see “[Shredding operations](#)” on page 282.

## Preparing to use Data Shredder

Before launching Data Shredder, install and enable Data Shredder on each disk array where you intend to use these options.

## Starting Data Shredder

1. From the Device Launcher pane, click an XP128/XP1024 link.
2. Click the **Volume Management** button ( Volume Mana...). The Volume Management pane appears.



**NOTE:** To change settings for Data Shredder, you must be in Modify mode.

3. Click the **Customized Volume** tab.

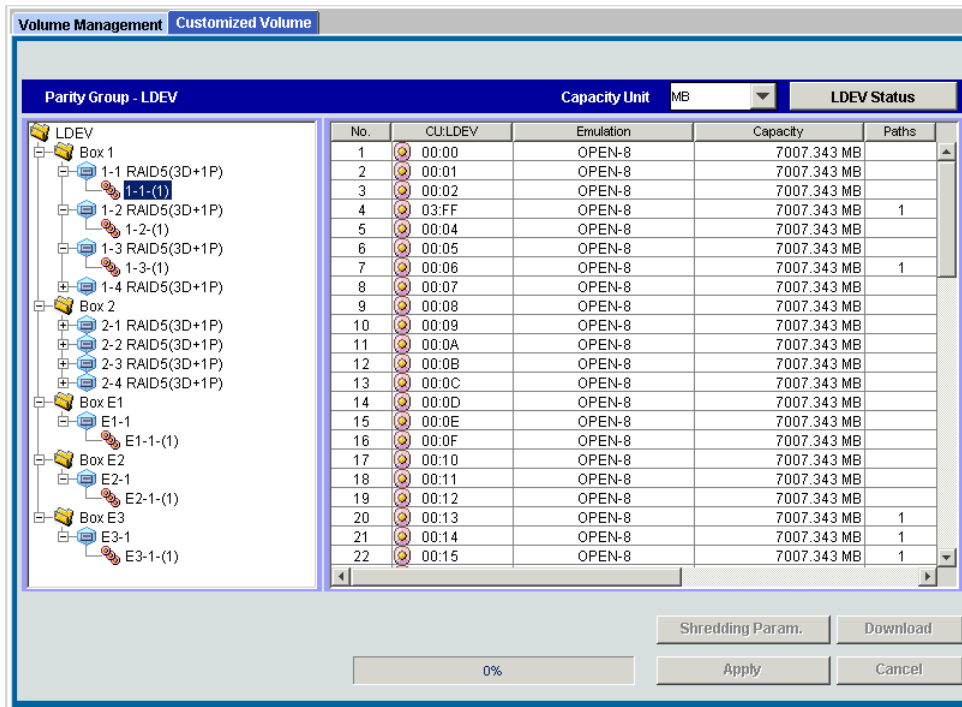

**Figure 153** Customized Volume pane.

## Shredding Param pane

Use this pane to define settings for Shredding operations. To open this pane, click **Shredding Param** (Parameter) on the Customized Volume pane. The Shredding Param pane contains the following:

- **Write Data Type:** Settings for Shredding operations.
  - **Default (00-FF-00):** If selected, defaults are used for Shredding operations. Data on a volume is deleted by overwriting the volume with dummy data three times. When the volume is overwritten the first and third times, Data Shredder uses 00 (hexadecimal number) for the dummy data. When the volume is overwritten the second time, Data Shredder uses FF (hexadecimal number) for the dummy data.

- **User:** If selected, you define the dummy data and how many times the volume is overwritten. For more information, see “[Defining Shredding operation settings](#)” on page 282.
- **Write Data:** Dummy data.
  - **Define:** Enter up to four numbers or characters for the dummy data. You can enter only hexadecimal numbers, including numbers 0 to 9, and alphabetic characters A to F. If you enter more than four digits, the entry is not accepted.



**NOTE:** Dummy data is written two digits at a time. Therefore, enter an even number of digits in the text box. If you enter an odd number of digits (for example, 123) and click **Set**, an error message appears.

- **Random:** Data Shredder randomly selects 4-digit hexadecimal numbers for the dummy data.
- **Format List:**
  - **NO.:** Number of times volume is overwritten.
 

If you select **User** in the **Write Data Type** field, and specify number of times volume is overwritten, **Last Data** appears in this column.
  - **Data:** Contents of the dummy data. Dummy data is shown in sets of two digits with a space between each set of digits. If **Last Data** appears in the **NO.** column, the dummy data is always 00.
- **Set:** Adds dummy data defined in the **Write Data** field to the **Format List**. You can add dummy data a maximum of seven times.

If you select **Define** in the **Write Data** field, and click **Set** without entering anything in the text box, an error message appears.

The **Set** button is not available when you select **Default** in the **Write Data Type** field.

- **Delete:** Deletes the selected in the **Format List** field.

If you select a row with **Last Data**, and click **Delete**, an error message appears.

The **Delete** button is not available when you select **Default** in the **Write Data Type** field.

- **OK:** Registers settings in the **Format List** field, and closes the Shredding Param pane.
- **Cancel:** Cancels all settings, and closes the Shredding Param pane.

## Confirmation pane for completing Shredding operations

When the Shredding operation is finished, a confirmation pane appears. This pane displays how often the volume was overwritten and the dummy data used each time the volume was overwritten.

If the Shredding operation finishes normally, use the following buttons:

- **OK:** Closes the confirmation pane.
- **Download:** Downloads the file containing the results of the shredding operation. The name of the file is shown in **Output File Name**.



**NOTE:** The results file is compressed. Use the appropriate software to decompress the file.

If the Shredding operation fails, contact your HP account support representative.

# Shredding operations

Shredding operations proceed as follows:

- Display the Volume Manager pane (see “Starting Data Shredder” on page 280 and “Volume Management pane” on page 250).
- Prepare for Shredding operations (see “Preparing for Shredding operations” on page 282).
- Define Shredding operation settings (see “Shredding Param pane” on page 280 and “Defining Shredding operation settings” on page 282).
- Perform Shredding operations (see “Deleting data on volumes (Shredding)” on page 283).



**NOTE:** To quit shredding operations, see “Canceling Shredding operations” on page 284.

## Preparing for Shredding operations

Before performing shredding operations, change the status of the target volume to **Blocked**.



**NOTE:** When you change the status of a volume to **Blocked**, I/O operations cannot be performed on the volume. By specifying write permissions, you can limit who is allowed to perform shredding operations.

1. In the Command View XP main pane, change to **Modify** mode by clicking the button (  ). A message pane appears asking if you want to change the mode.
2. Click **OK**. The operation mode changes.
3. In the Volume Manager pane, click **LDEV Status**. The status of volumes is displayed in the **Status** column in the **LDEV Information** table.



**NOTE:** If hyphens appear in the **Status** column, click **LDEV Status** in the Volume Manager pane to display the status of volumes (for example, **Normal** or **Blocked**).

4. Select the target volume in the **LDEV Information** table.
5. Right click the target volume, and select **Blockade**. Information about the target volume is shown in blue and italics.
6. Click **Apply**. A message pane appears asking if you want to change the status of the volume.
7. Click **OK**. The status of the volume changes to **Blocked**.



**NOTE:** If you select **Restore** and click **Apply**, you can change the status of the volume from **Blocked** to **Normal** again.

## Defining Shredding operation settings

Use the Shredding Param pane to define the settings used for Shredding operations.



**NOTE:** When you change the status of a volume to **Blocked**, I/O operations cannot be performed on the volume. By specifying write permissions, you can limit who is allowed to perform shredding operations.



1. In the Customized Volume pane, click **Shredding Param**. The Shredding Param pane appears.
2. Select **Default** or **User** in the **Write Data Type** field.  
If you selected **User**, go to [step 3](#).  
If you selected **Default**, go to [step 7](#).
3. Select **Define** or **Random** in the **Write Data** field.  
If you selected **Define**, go to [step 4](#).  
If you selected **Random**, go to [step 5](#).
4. Enter dummy data in the text box.
5. Click **Set**. A row is added to the **Format List**.
6. If you selected **Define** in the **Write Data** field, repeat [step 4](#) and [step 5](#) until there are three or more rows in the **Format List**, including the **Last Data** row.  
If you selected **Random** in the **Write Data** field, repeat [step 5](#) until there are three or more rows in the **Format List**, including the **Last Data** row.

---

 **CAUTION:** Although you can execute Shredding operations when there are less than three rows in the **Format List**, you might not be able to completely delete data from the volume. Therefore, HP recommends you define three or more rows in the **Format List**.

---

7. Click **OK**. The Shredding Param pane closes.

---

 **NOTE:** To delete a row from the **Format List**, select the row, and click **Delete**. You cannot delete the row defined as **Last Data**.

---

## Deleting data on volumes (Shredding)

1. In the Volume Manager pane, check the **LDEV Information** table, and verify that the status of the target volume is **Blocked**.

---

 **NOTE:** If the status of the volume is not shown in the **LDEV Information** table, click LDEV Status. If the status of the volume is not **Blocked**, see "[Preparing for Shredding operations](#)" on page 282 for instructions on changing the status to **Blocked**.

---

2. Select the target volume in the **LDEV Information** table, and right click.
3. Select **Shredding**. Information about the target volume is shown in blue and italics.
4. Click **Apply**. A message pane appears asking if you want to change the status of the volume.
5. Click **OK**. During the shredding operation, a message pane appears.

---

 **CAUTION:** If you click **Cancel** on the message panel to quit the Shredding operation, you cannot restart the Shredding operation. For instructions on canceling Shredding operations, see "[Canceling Shredding operations](#)" on page 284.

---

6. When the shredding operation is finished, a confirmation pane appears.  
To download the file containing the results of the shredding operation, go to [step 7](#).

If you do not need to download the file, go to [step 9](#).

7. Click **Download**.
8. Select the folder where you want to download the file.
9. Click **OK**.

If you downloaded the file, the file is downloaded to the specified folder.

If you did not download the file, the confirmation pane closes.

When the shredding operation is finished, the status of the volume is automatically changed to **Normal**.



**NOTE:** You can also click the **Download** button in the Volume Management pane to download the file containing the results of the Shredding operation. If you click **Download** in the Volume Management pane, all results of shredding operations are in the file to be downloaded. If you have not performed any shredding operations, an error occurs when you click **Download**.

---

## Canceling Shredding operations

During the shredding operation, a message pane appears. To cancel Shredding during the operation, click **Cancel** in the message pane.



**CAUTION:** If you cancel shredding, you cannot restart the Shredding operation, and data on the volume cannot be assured.

---

# 18 LUN Security Extension for the XP128/XP1024/XP12000

LUN Security Extension protects data on an XP disk array from I/O operations performed on open systems hosts. You can use LUN Security Extension to assign an access attribute to each logical volume. If you use LUN Security Extension, you can use a logical volume as a read-only volume and protect a logical volume against read and write operations.

LUN Security Extension allows you to suspend data activity within the environment. This ensures that logical volumes whose retention period expires will not return to Read/Write mode. This feature is called *Expiration Lock* (also called *Audit Lock*).

You cannot use LUN Security Extension to change the access attribute of logical volumes that meet certain conditions. For detailed information, see “[Using LUN Security Extension with other products](#)” on page 287.

In local disk array documentation, logical volumes are sometimes referred to as *logical devices* (or LDEVs). Logical volumes to be accessed by open-systems hosts are sometimes referred to as *logical units* or LUs.



**CAUTION:** HP StorageWorks LUN Security XP Extension provides the ability to place logical volumes into secure states. In these secure states, data on the volumes cannot be modified until the retention time specified when the volume is placed in the secured state has elapsed. TO THE FULLEST EXTENT PERMITTED BY LAW, UNLESS EXPRESSLY PROVIDED OTHERWISE UNDER WRITTEN AGREEMENT BETWEEN HP AND CUSTOMER, HP WILL NOT BE LIABLE FOR ANY DIRECT, SPECIAL OR CONSEQUENTIAL DAMAGES (INCLUDING BUT NOT LIMITED TO LOSS OF PROFITS AND LOSS OF DATA) REGARDLESS OF WHETHER SUCH DAMAGES ARE BASED ON TORT, WARRANTY, CONTRACT OR ANY OTHER LEGAL THEORY, EVEN IF ADVISED OF THE POSSIBILITY OF SUCH DAMAGES, ARISING OUT OF ANY PERFORMANCE OF OR IN FURTHERANCE OF UNLOCKING OR OTHERWISE UNSECURING AT THE REQUEST OF THE CUSTOMER DATA THAT HAS BEEN SECURED USING HP StorageWorks LUN Security XP Extension BEFORE THE RETENTION TIME HAS EXPIRED.

## Assigning access attributes to logical volumes

By default, all open systems volumes are subject to read and write operations by open systems hosts. For this reason, data on open systems volumes could be damaged or lost if an open systems host performs erroneous write operations. Also, confidential data on open systems volumes could be stolen if a malicious operator performs read operations on open systems hosts.

Restricting read and write operations on logical volumes can prevent data from being damaged, lost, or stolen. With LUN Security Extension, you can use logical volumes as read-only volumes to protect them against write operations, or you can protect logical volumes against both read and write operations.

## Restricting read and write operations

To restrict read and write operations, use LUN Security Extension to assign one of the following access attributes to each logical volume (see “[Changing access attributes of logical volumes](#)” on page 292):

- **Read/Write:** Open systems hosts can perform read and write operations on the logical volume.

Continuous Access (CA) and Business Copy (BC) can copy data to logical volumes that have the Read/Write attribute. If necessary, you can prevent copying data to logical volumes that have the Read/Write attribute.

Read/Write is the default attribute for open systems volumes.

- **Read Only:** Open systems hosts can perform read operations, but cannot perform write operations on the logical volume.

CA and BC cannot copy data to logical volumes that have the Read Only attribute.

- **Protect:** Open systems hosts cannot access the logical volume. Open systems hosts cannot perform read or write operations on the logical volume.

CA and BC cannot copy data to or from logical volumes that have the Protect attribute.

Figure 154 shows the access attributes of the logical volumes 00, 01, and 02. The access attribute of logical volume 03 is Can't Guard, which means you cannot assign any access attribute to the logical volume. LUN Security Extension cannot assign access attributes to:

- Mainframe volumes
- Logical volumes (logical devices) that are not mapped to physical devices

LDEV#	Attribute	Type	Capacity	S-Vol	Reserved	Paths	Retention Term	Mode
00	Read/Write	OPEN-V	58.59 GB	Enable	-	0	-	-
01	Read Only	OPEN-V	58.59 GB	Disable	-	0	2190 days	-
02	Protect	OPEN-V	58.59 GB	Disable	-	0	0 days	Inv
03	Can't Guard	-	-	-	-	-	-	-

Figure 154 Example of access attributes

If you change the access attribute of a logical volume to Read Only or Protect, you will be prevented from changing the access attribute to Read/Write for a selected time period called the Retention Term.

For example, in Figure 154, you cannot change the access attribute of logical volume 01 to Read/Write within the next 2,190 days, but you can change the access attribute of logical volume 02 since its Retention Term is over. If you need to change the access attribute of a volume before its Retention Term ends, contact your HP support team representative.

You are prompted to specify the retention term when you change the logical volume's access attribute to Read Only or Protect. After the retention term is set, you can only extend the term. For more information about extending the retention term, see "Modifying the retention term" on page 293.



**CAUTION:** After the retention term is set for a particular volume, there is no way to shorten the term.

If you set the Expiration Lock to ON (Enable on an XP12000), attempts to change Read Only or Protect volumes to Read/Write will fail even if the retention term is over. Expiration Lock is OFF when you start LUN Security Extension for the first time. For more information, see "Prohibiting changes to Read/Write volumes after the retention term ends" on page 293.

Also note the following:

- If a host computer attempts to write data to a read-only logical volume, the write operation fails and the write failure is reported to the host.
- If a host computer attempts to read data from or write data to a logical volume with the Protect attribute, the attempt fails and the failure is reported to the host.
- When Hitachi Multiplatform Backup and Restore (HMBR) is used and a mainframe host attempts to write data to a read-only logical volume, the write operation fails and Write Inhibit is reported to the host.

- When HMBR is used and a mainframe host attempts to read data from or write data to a logical volume with the Protect attribute, the attempted access fails and `CC=3` is reported to the host.

## Using LUN Security Extension with other products

Do not perform LUN Security Extension operations on a volume on which another operation, such as AutoLUN Monitoring, is running.

Do not assign an access attribute to a logical volume if any job is manipulating data on the logical volume. If you assign an access attribute to such a logical volume, the job might end abnormally.

- **Logical volumes:** You cannot use LUN Security Extension to change the access attribute of the following logical volumes:
  - Logical volumes with emulation types other than OPEN-3, OPEN-8, OPEN-9, OPEN-E, OPEN-K, OPEN-L, OPEN-M, and OPEN-V.
  - Logical volumes that do not exist.
  - Logical volumes that are configured as command devices.
  - NAS system volumes, which are also known as system LUs.
  - NAS user volumes, which are also known as user LUs.
  - Logical volumes that are expanded by the Just in Time Storage function
  - External LUs
  - Flex Copy volumes
  - Logical volumes to which paths are defined from iSCSI ports.
  - Logical volumes that are specified as Continuous Access XP (CA).
  - Logical volumes that are specified as Business Copy XP (BC).
  - Logical volumes that are reserved for Volume Migration
- **Difference between Administrators and StorageAdmins**

In this guide, a user who manages the whole disk array is called an *Administrator*. When the disk array's resources are partitioned by Disk/Cache Partition, a group of the virtually divided resources is called an SLPR. A user who manages the SLPR is called a *StorageAdmin*.

While the Administrator can set the access attribute for logical volumes in any CUs in the disk array, the StorageAdmin can set the access attribute only for logical volumes in CUs in the SLPR the StorageAdmin manages. Therefore, if you are a StorageAdmin and using the LUN Security XP Extension pane (see [Figure 155](#)), only the CUs in your SLPR are displayed on the pane. CUs in the SLPRs that other StorageAdmins manage are not displayed.

For more information about SLPRs, see "[Disk/Cache Partition for the XP12000](#)" on page 143.

- **LUN Management:** You cannot combine logical volumes that do not have the Read/Write attribute when you create a LUSE volume. You can assign an access attribute other than Read/Write to the resulting LUSE volume.

You cannot release a LUSE volume that does not have Read/Write attribute.

- **Volume Management:** You cannot convert volumes that do not have the Read/Write attribute into spaces. You cannot initialize custom volumes that do not have the Read/Write attribute.
- **RAID Manager:** If RAID Manager is used to change the access attribute of a volume when you are using LUN Security Extension, you will be unable to change the access attribute of the volume with

LUN Security Extension. If you attempt to change the access attribute of the volume with LUN Security Extension, an error occurs. If an error occurs, click the **Refresh** button and retry the access attribute change.

- **Products that can start automatically at a specified time:** Certain products, such as Auto LUN monitoring, start automatically at specified times. If a product that can start automatically is enabled, you must perform LUN Security Extension operations when the program is not running or cancel the start time setting of the program.

## Starting LUN Security Extension

To use LUN Security Extension, install the following:

- LUN Security Extension license key
- Firmware version 21.07.04 or later. If you want to use the Expiration Lock feature, firmware version 21.10.02 or later is required.

To assign an access attribute, you must use an account that has write permission, such the Administrator account, and you must be in Modify mode. If you use an account that does not have write permission or you are in View mode, you can view the access attribute of a volume, but you cannot assign an access attribute.

1. From the Device Launcher pane, click an XP128/XP1024/XP12000 link.
2. Click the **LUN Security Extension** button . The LUN Security XP Extension pane appears.

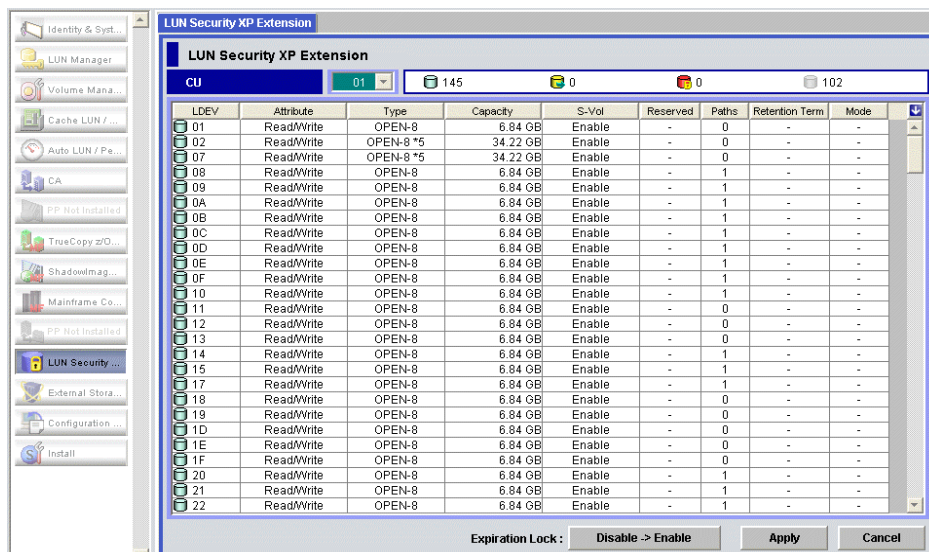

**Figure 155** LUN Security XP Extension pane

To implement changes for LUN Security Extension, you must be in Modify mode.





- If Command View is being used, only one user at a time can be in Modify mode. For information on changing between View and Modify modes, see ["Identity pane buttons and icons"](#) on page 98.
- If RAID Manager is being used at the same time as Command View, more than one user can be in Modify mode. For more information on simultaneous access by multiple users, see ["Session Administration"](#) on page 53.

# LUN Security Extension pane

The LUN Security Extension pane (Figure 155) is the starting point for all LUN Security Extension operations. This pane includes the following items:

- **CU# list:** Used to specify a CU image. When you select a CU image, the table displays details about the logical volumes in the CU image. To the right of this list are icons:

**Table 53** LUN Security Extension icons

Icon	Status
	Logical volumes that have the Read/Write attribute.
	Logical volumes that have the Read Only attribute.
	Logical volumes that have the Protect attribute.
	Mainframe volumes and logical volumes (logical devices) that are not mapped to physical storage devices. You cannot assign an access attribute to these volumes.



**NOTE:** If two or more volumes are combined into a LUSE volume, LUN Security Extension counts the number of the combined volumes as one. For example, if you combine five logical volumes into one LUSE volume, the number of volumes is one, not five.

- **LDEV#:** Displays logical volume numbers and status icons (Table 53).

If the # symbol is displayed to the right of a logical volume number, the logical volume is a Flex Copy volume. You cannot assign access attributes to Flex Copy volumes.

- **Attribute:** Indicates the access attribute of each logical volume. If the attribute is Can't Guard, you cannot assign an access attribute to the logical volume.
- **Type:** Displays volume emulation types.

If an asterisk and a number appear to the right of an emulation type, the logical volume is a LUSE volume. For example, OPEN-3\*36 indicates a LUSE volume into which 36 logical volumes are combined. For detailed information about LUSE volumes, refer to "Volume Management for the XP128/XP1024/XP12000" on page 241.

- **Capacity:** Displays the capacity of each logical volume in gigabytes (GB).
- **S-Vol:** Indicates whether each logical volume can be specified as a copy destination for CA and BC operations.



**NOTE:** This guide sometimes uses the term S-VOL or secondary volume to refer to a logical volume used as a CA or BC copy destination.

- **Reserved:** Indicates whether RAID Manager or Command View can be used to set LU path and command device settings.
  - If the Reserved column displays a hyphen (-), Command View users can change LU path and command device settings on the logical volume.
  - If the Reserved column says RAID Manager, only RAID Manager can be used to change LU path or command device settings on the logical volume.

- **Paths:** Displays the number of LU paths to each logical volume.
- **Retention Term:** Displays the period (in days) during which you are prohibited from changing the access attribute to Read/Write.

For example, if the Retention Term shows 500 days, attempts to change the access attribute to Read/Write are prohibited during the next 500 days. If Unlimited is displayed, the retention term is extended indefinitely and you can no longer change the access attribute. If a hyphen (-) is displayed, no retention term is assigned. If you need to change the access attribute to Read/Write, contact your HP support team representative.



**CAUTION:** After the retention term is set, you can only extend the term. There is no way to shorten the term. For information about extending the retention term, see ["Modifying the retention term"](#) on page 293.

If the retention term is 0 days, you can change the access attribute to Read/Write. During the retention term, you can change Read Only to Protect, or vice versa.

- **Mode:** Displays the logical volume mode assigned by a RAID Manager user:
  - **Zer:** Indicates that Zero Read Cap mode is assigned to the logical volume. If the `Read Capacity` command (a SCSI command) is issued to a logical volume in Zero Read Cap mode, the capacity of the logical volume is reported as zero.
  - **Inv:** Indicates that Invisible mode is assigned to the logical volume. If the `Inquiry` command (a SCSI command) is issued to a logical volume in Invisible mode, it will be reported that the logical volume does not exist. Therefore, the hosts will be unable to recognize the logical volume.
  - **Zer/Inv:** Indicates that both Zero Read Cap mode and Invisible mode are assigned to the logical volume.
  - - (a hyphen): Indicates that no mode is assigned by RAID Manager to the logical volume.

You cannot use LUN Security Extension change modes. Use RAID Manager to change modes.

-  button: Located in the upper-right corner of the table. Use this button to select all logical volumes in the table.

If two or more volumes are combined into a LUSE volume, this pane displays the top LDEV, and does not display other LDEVs (other volumes) that are combined into the LUSE volume. For example, if volumes 03, 04, and 05 in CU image 01 are combined into a LUSE volume, the table lists volume 03, but does not list volumes 04 and 05. To view all logical volumes that form a LUSE volume, see ["Viewing a list of logical volumes combined into a LUSE volume"](#) on page 295.

- **Expiration Lock:** A switch for implementing stronger protection on logical volumes. If this setting is ON, attempts to change the access attribute to Read/Write fail even after the retention term. The Expiration button says **OFF -> ON** when the setting is OFF and **ON -> OFF** when it is ON. The default setting is OFF.



**NOTE:** When viewing an XP12000, the button says **Disable -> Enable** and **Enable -> Disable**.



**NOTE:** **Expiration Lock** can only be turned on and off with Command View.

- Buttons:
  - **Apply:** Applies settings in the LUN Security Extension pane to the disk array.



- **Cancel:** Discards settings in the LUN Security Extension pane.

## Term Setting dialog box

Use this dialog box to enter a retention term. During this period, attempts to change the access attribute to Read/Write are prohibited.



**Figure 156** Term Setting dialog box

This dialog box includes the following items:

- **Term:** Defines the retention term using the following boxes:
  - **years:** Enter the number of years (0 to 60). LUN Security Extension counts one year as 365 days whether or not the year is a leap year.
  - **days:** Enter the number of days (0 to 21900).

For example, if you enter 10 years 5 days (or 0 years 3655 days), the access attribute of the logical volume cannot be changed to Read/Write in the next 3,655 days.

- **Unlimited:** Extends the retention term indefinitely.
- **OK** button: Applies the current settings to the LUN Security Extension main pane and closes the dialog box. This button does not apply the settings to the disk array. To do so, click **Apply** in the LUN Security Extension main pane.
- **Cancel** button: Discards the settings in the dialog box.

## Volume Detail dialog box

This dialog box displays a list of logical volumes combined into a LUSE volume (see “[Viewing a list of logical volumes combined into a LUSE volume](#)” on page 295). For detailed information about LUSE volumes, refer to “[Volume Management for the XP128/XP1024/XP12000](#)” on page 241.

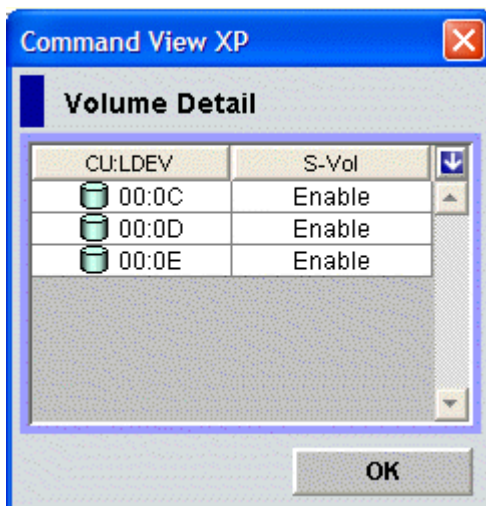

**Figure 157** Volume Detail dialog box

This dialog box includes the following items:

- **CU:LDEV:** Lists the CU image number and logical volume number of each volume that is combined into a LUSE volume.
- **S-Vol:** Indicates whether a logical volume can be specified as a copy destination volume (a secondary volume) for CA and BC operations. Enable means the logical volume can be specified as a copy destination volume. Disable indicates that the logical volume cannot be specified as a copy destination volume.
- **OK button:** Closes the dialog box.

## Error Detail pane

The Error Detail pane displays error locations and LUN Security Extension error messages. It does not display Command View error messages.

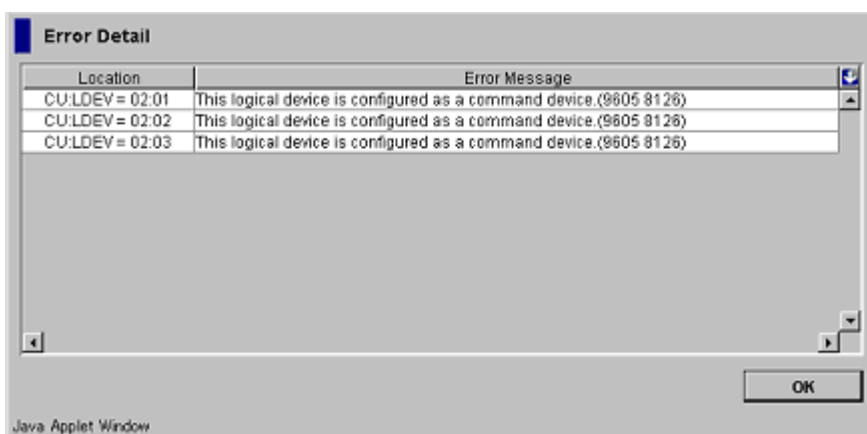

**Figure 158** Error Detail pane

The Error Detail pane displays the following items:

- **Location:** Indicates where errors occur. If an error occurs with a logical volume, this column displays the CU number and the LDEV number (logical volume number).
- **Error Message:** Displays error messages.
- **OK button:** Closes the Error Detail pane.

---

## Using LUN Security Extension

You must operate Command View in Modify mode to perform LUN Security Extension operations. Users in view mode can only view LUN Security Extension information.

### Changing access attributes of logical volumes

Before changing the access attributes of logical volumes, review the sections "[Assigning access attributes to logical volumes](#)" on page 285 and "[Using LUN Security Extension with other products](#)" on page 287.

1. In the LUN Security Extension pane, select a CU image in the CU# list. The table displays a list of logical volumes in the specified CU image.
2. Right-click a logical volume, select **Attribute** and then select the access attribute you want to assign (Read Only, Read/Write, Protect).



**NOTE:** To assign the same access attribute to all the logical volumes, click the  button in the upper-right corner of the table and then right-click and select an access attribute to assign.

If you selected **Read Only** or **Protect**, the Term Setting dialog box appears.

- a. Enter a Retention Term in years and days. To extend the retention term indefinitely, select **Unlimited**.
- b. Click **OK**.

The logical volume is displayed in blue italics in the LUN Security Extension pane. The volume icon also changes when the access attribute changes. If you want to change access attribute of other logical volumes, repeat this step.

LDEV	Attribute	Type	Capacity	S-Vol	Reserved	Paths	Retention Term	Mode
UF	Read/Write	OPEN-8	6.84 GB	Enable	-	1	-	-
10	Read/Write	OPEN-8	6.84 GB	Enable	-	1	-	-
11	Read/Write	OPEN-8	6.84 GB	Enable	-	0	-	-
12	Read/Write	OPEN-8	6.84 GB	Enable	-	0	-	-
13	<i>R/W -&gt; R/O</i>	<i>OPEN-8</i>	<i>6.84 GB</i>	<i>Ena -&gt; Dis</i>	-	<i>0</i>	<i>0days -&gt; Unl...</i>	-
14	Read/Write	OPEN-8	6.84 GB	Enable	-	1	-	-
15	Read/Write	OPEN-8	6.84 GB	Enable	-	1	-	-
17	Read/Write	OPEN-8	6.84 GB	Enable	-	1	-	-

**Figure 159** Access attribute before applying the changes

3. If you want to change access attributes of logical volumes in other CU images, repeat [step 1](#) - [step 2](#).
4. Click **Apply**. A confirmation message appears.
5. Click **OK**. The settings are applied to the disk array.

## Modifying the retention term

You can extend the retention term for logical volumes with the Read Only or Protect attribute.



**CAUTION:** After the retention term is set, there is no way to shorten the term.

1. In the LUN Security Extension pane, select a CU image in the CU# list. The table displays a list of logical volumes in the specified CU image.
2. Right-click a logical volume and select **Retention Term**. The Term Setting dialog box appears.
3. Enter a Retention Term in years and days. To extend the retention term indefinitely, select **Unlimited**.
4. Click **OK**. The new settings are displayed in blue italics. At this point, the settings have not been applied to the disk subsystem.
5. Click **Apply** in the LUN Security Extension pane. A confirmation message appears.
6. Click **OK**. The settings are applied to the disk array.

## Prohibiting changes to Read/Write volumes after the retention term ends

You can use LUN Security Extension to ensure Read Only and Protect volumes cannot be changed to Read/Write volumes after the retention term expires.

1. In the LUN Security Extension pane, locate the button next to the words *Expiration Lock*.
  - If the button is **OFF** -> **ON**, go to [step 2](#).
  - If the button is **ON** -> **OFF**, attempts to change the access attribute to Read/Write are already prohibited.



**NOTE:** When viewing an XP12000, the button says **Disable -> Enable** and **Enable -> Disable**.

2. Click the **OFF -> ON** button. A confirmation message appears.
3. Click **OK**. The button changes to **ON -> OFF** and the Expiration Lock is set to ON. If nothing happens when you click **ON -> OFF**, see "Troubleshooting LUN Security Extension XP" on page 296.

To turn off the Expiration lock click **ON -> OFF**.

## Protecting logical volumes against CA and BC

When CA and BC copy data, the data on the copy destination volume (also known as secondary volume) is overwritten. If a volume containing important data is specified as a secondary volume by mistake, you could lose important data. LUN Security Extension can protect you from this type of data loss.

If you assign the Read Only or Protect attribute to a logical volume, CA, BC, and other business application software cannot write data to that logical volume.

If you want to prohibit CA and BC from copying data to a logical volume, but do not want to prohibit other write operations to the same logical volume, ensure that the logical volume has the Read/Write attribute, and set the volume so it cannot be specified as a secondary volume (a copy destination volume) for CA or BC operations.

## Protecting a Read/Write logical volume against CA and BC operations



**NOTE:** This procedure does not work if a logical volume is already used as a secondary volume (S-VOL) for CA or BC.

1. In the LUN Security Extension pane, select a CU image in the CU# list. The table displays a list of logical volumes in the specified CU image.  
In the S-Vol column, volumes labeled **Enable** can be specified as a secondary volumes.
2. Right-click a logical volume. Select **S-Vol** and then **Disable**. The logical volume is displayed in blue and italics.

LDEV	Attribute	Type	Capacity	S-Vol	Reserved	Paths	Retention Term	Mode
00	Read/Write	OPEN-8 *2	13.69 GB	Enable	-	0	-	-
02	Read/Write	OPEN-8	6.84 GB	Enable	-	1	-	-
03	Can't Guard	-	0.00 GB	-	-	-	-	-
04	Read/Write	OPEN-8	6.84 GB	Enable	-	1	-	-
05	<i>Read/Write</i>	<i>OPEN-8 *3</i>	<i>20.53 GB</i>	<i>Ena -&gt; Dis</i>	-	<i>1</i>	-	-
06	Read/Write	OPEN-8	6.84 GB	Enable	-	1	-	-
09	Read/Write	OPEN-8	6.84 GB	Enable	-	0	-	-

**Figure 160** Disabling an S-Vol

3. Repeat [step 1](#) and [step 2](#) for additional logical volumes.
4. Click **Apply**. A confirmation message appears.
5. Click **OK**. The settings are applied to the disk array.



**NOTE:** To allow a logical volume to be specified as a secondary volume, right-click the logical volume and select **S-Vol** and **Enable** from the shortcut menu. Confirm that the logical volume is listed in blue italics, and then click **Apply**.

# Preventing Command View users from configuring LU paths and command devices

LUN Management lets Command View users change LU path and command device configurations. If you use LUN Security Extension to protect a logical volume, Command View users cannot change LU path and command device settings on that logical volume.



**NOTE:** If RAID Manager is installed on a server host, you can change LU path and command device settings from that server host. If **Reserved** is set, LU path and command device settings can only be configured with RAID Manager.

1. In the LUN Security Extension pane, select a CU image in the CU# list. The table displays a list of logical volumes in the specified CU image.
2. In the Reserved column, right-click a logical volume represented by a hyphen (-), and select **Reserved** and then **Set** from the shortcut menu.

The Reserved column displays RAID Manager for the selected logical volume, and the logical volume is displayed in blue italics.

3. To prevent Command View users from configuring other logical volumes, repeat [step 2](#) and [step 3](#).
4. Click **Apply** in the LUN Security Extension pane. A confirmation message appears.
5. Click **OK**. The settings are applied to the disk array.



**NOTE:** To permit Command View users to make LU path settings and command device settings on a logical volume, look for logical volumes showing RAID Manager in the Reserved column. Right-click the desired logical volume, and select **Reserved** and then **Release** from the shortcut menu. Verify that the Reserved column displays a hyphen (-), and then click **Apply**.

## Viewing a list of logical volumes combined into a LUSE volume

If logical volumes are combined into a LUSE volume, the LUN Security Extension pane does not display all the combined volumes, but displays only the top LDEV. The top LDEV is a logical volume whose LDEV number is the smallest of all the logical volumes combined into a LUSE volume. For information about LUSE volumes, refer to “[Volume Management for the XP128/XP1024/XP12000](#)” on page 241.

1. From the LUN Security Extension pane, locate a LUSE volume by looking at the Type column of the table. If an asterisk (\*) and a number appear to the right of the emulation type, the volume is a LUSE volume. For example, *OPEN-V\*3* indicates a LUSE volume consisting of three OPEN-V volumes.

- Right-click the LUSE volume and select Volume Detail. The Volume Detail dialog box displays the logical volumes combined into the selected LUSE volume.

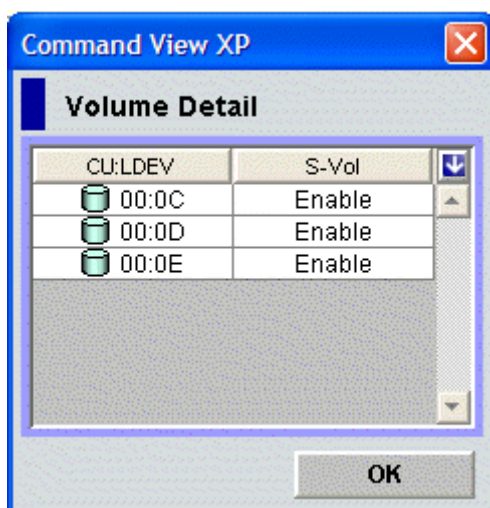

**Figure 161** Volume Detail dialog box

- Click **OK**.

## Troubleshooting LUN Security Extension XP

If an error occurs with LUN Security Extension, the Error Detail pane (Figure 158) displays the error locations and messages. The LUN Security Extension Error pane does not include Command View errors.

**Table 54** Troubleshooting LUN Security Extension XP

Problem	Solution
You cannot find certain logical volumes in the LUN Security Extension XP pane.	If logical volumes are combined into an LUSE volume, the table displays only the top LDEV of the combined volumes. To view all the logical volumes combined into an LUSE volume, see <a href="#">"Viewing a list of logical volumes combined into a LUSE volume"</a> on page 295.
The <b>OFF -&gt; ON</b> button or the <b>ON -&gt; OFF</b> button at the right of Expiration Lock is unavailable.  Nothing happens when you click the button.	You have been making changes in the LUN Security Extension XP pane, but the changes have not been applied to the disk array.  The changes you have made are displayed in blue italics. If you cannot find the changes, scroll the table up and down. If you still cannot find the changes, select another CU from the CU# list and then scroll the table up and down.  When you find the changes, either: <ul style="list-style-type: none"> <li>Click <b>Apply</b> to apply the changes to the disk array, or</li> <li>Click <b>Cancel</b> to discard the changes.</li> </ul>







---

# 19 Configuration File Loader for the XP128/XP1024/XP12000

This chapter covers the following:

- “Working with Configuration File Loader” on page 299
- “Starting Configuration File Loader” on page 303
- “Spreadsheet rules and formats” on page 305
- “LUN Manager spreadsheet” on page 311
- “Using Configuration File Loader” on page 317

---

## Working with Configuration File Loader

You can use Command View to define the configuration of the disk array. Using the Command View GUI is appropriate for small-scale changes, but can be too time consuming for large-scale changes or for new settings. In addition, setting up large-scale changes within the GUI can produce errors. Configuration File Loader solves this problem by writing the parameters in a file and applying the settings quickly.

Use any text editor or spreadsheet software to edit the configuration definition files. Make sure you edit the files according to the specific formats and rules described in this chapter.

With Configuration File Loader, you can set disk arrays to have the same configuration by applying the same configuration definition file. You can also define the configuration offline.

## Requirements for Configuration File Loader

Configuration File Loader comes preloaded from the factory. Before using Configuration File Loader, you will want to do the following;

- Ensure you meet the Command View installation requirements
- Install:
  - Command View
  - spreadsheet software or a text editor

HP StorageWorks LUN Configuration and Security Manager XP (to manage LUN configuration files)

## Configuration File Loader components

Configuration File Loader is comprised of two main components:

- Configuration File Loader pane
- Spreadsheet file

## Using the Configuration File Loader pane

Use the Configuration File Loader pane for these tasks:

- Export a spreadsheet file that includes the current configuration information
- Import a file with new configuration information.

The Configuration File Loader pane shows the status and the error information of the imported file. From this pane, you can check the error information on the imported file and if there is no error in the file, you can apply the new configuration in the file by clicking **Apply**.

For detailed information on the components and the operations of the Configuration File Loader pane, see "[Configuration File Loader pane](#)" on page 304.

## Using the spreadsheet file

The spreadsheet file, which contains information that defines the configuration settings, is a text file in CSV (Comma Separated Value) format and must use the `.spd` file extension.

At the beginning of the Configuration File Loader operation, the spreadsheet file must be exported from the disk array. You can then edit the exported file and import the edited file.

Use spreadsheet software or a text editor to edit the spreadsheet file. For information on using spreadsheet software, see "[Spreadsheet software requirements](#)" on page 302. Also, the spreadsheet must be written in a specific format and follow certain rules. See "[Spreadsheet rules and formats](#)" on page 305.

# Configuration File Loader tasks

Figure 162 shows an outline of the Configuration File Loader tasks.

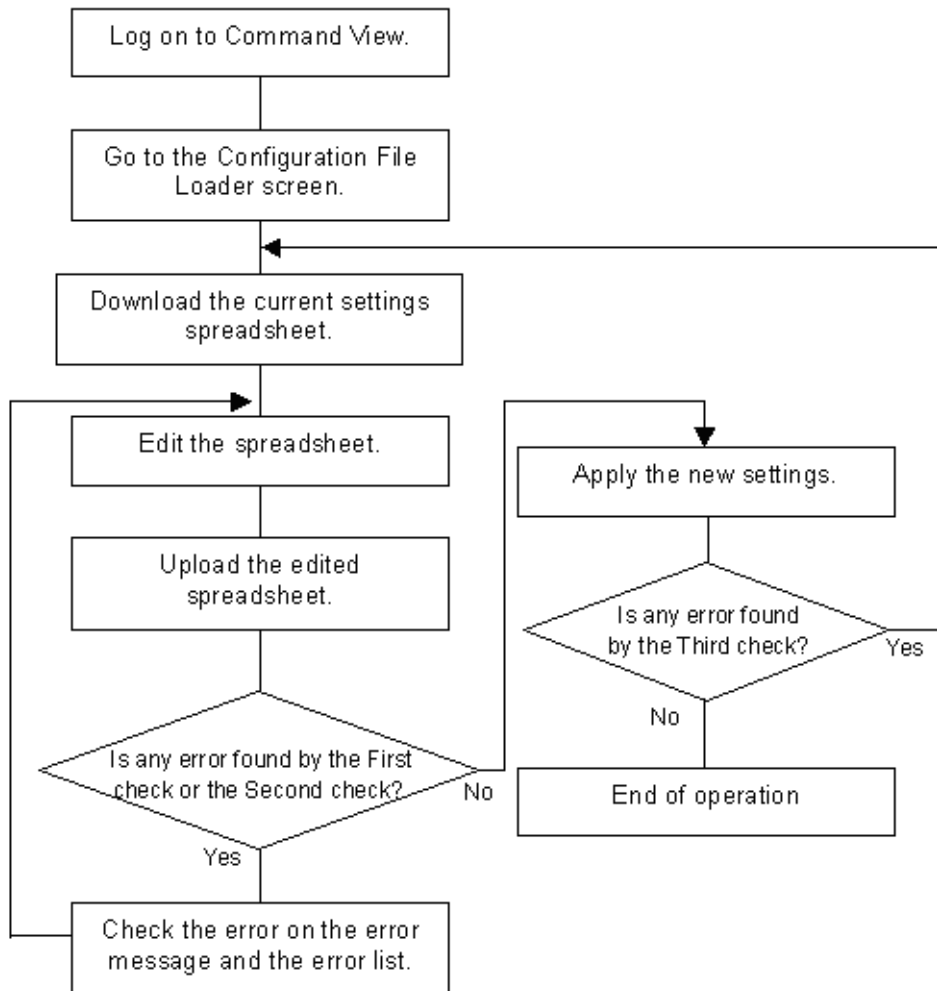

Figure 162 Outline of the Configuration File Loader tasks

## Spreadsheet type and available function

At this time, the LUN Manager spreadsheet is the only available spreadsheet. The spreadsheet for other features is not yet available, which means that Configuration File Loader can be used to set the LUN Manager settings (such as adding host group or path settings), but not for the other features such as Cache LUN or Volume Management.

For further information on the LUN Manager functions and settings, see “[LUN Management for the XP128/XP1024/XP12000](#)” on page 179. The available formats and the parameters of the LUN Manager spreadsheet are described in “[LUN Manager spreadsheet](#)” on page 311.

The spreadsheet can define the following LUN Manager settings.

- LUN path settings:
  - Add, delete, or change LU paths.
  - Set or release the command device and command device security.
- LUN security settings:
  - Create, delete, or change the host group (host storage domain).

- Add or delete WWNs.
- Apply or remove LUN security (security switch).
- Port settings:
  - Change the settings for AL-PA, data transfer speed (host speed) and topology.
- CHA settings:
  - Change the PCB mode (high-speed, high-speed (2 port), or standard).



**NOTE:** High-speed (2 port) mode is available only if the XP disk array has firmware version 21.06.22 or later installed.

## Spreadsheet software requirements

To edit an exported spreadsheet, you can use spreadsheet software or a text editor. If you use spreadsheet software, Microsoft Excel is recommended. When you open the spreadsheet file on spreadsheet software, it is important that all of the settings are displayed in the text format. You also need to be careful when you save the spreadsheet after you have edited it with spreadsheet software.

This section explains how to open a spreadsheet and save the edited spreadsheet file in Microsoft Excel 2000.

## Opening the spreadsheet file

The following instructions describe how to use Microsoft Excel to open the spreadsheet file. If you use a different spreadsheet application, open the spreadsheet file and display the values in text format.

### To open the spreadsheet file in Microsoft Excel 2000:

1. Start Microsoft Excel 2000.
2. From the **File** menu, select **Open**.
3. Select the spreadsheet file and click **Open**.
4. Set the Text Import Wizard options as shown in the following figures.

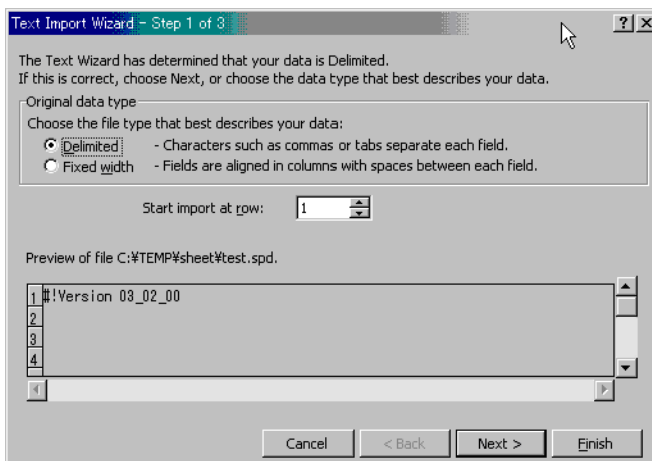

**Figure 163** Text Import Wizard - Step 1 of 3

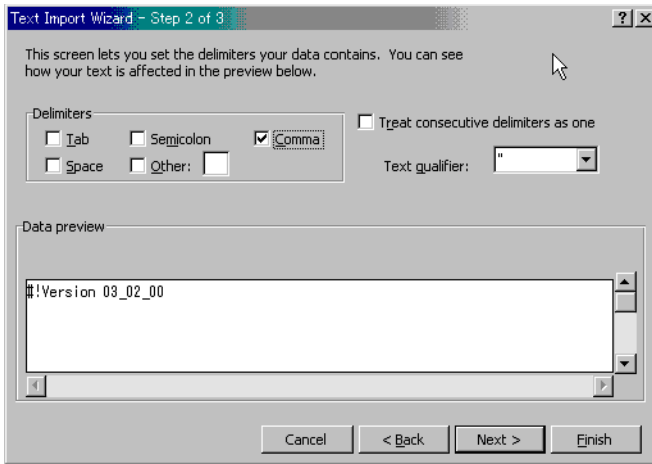

**Figure 164** Text Import Wizard - Step 2 of 3

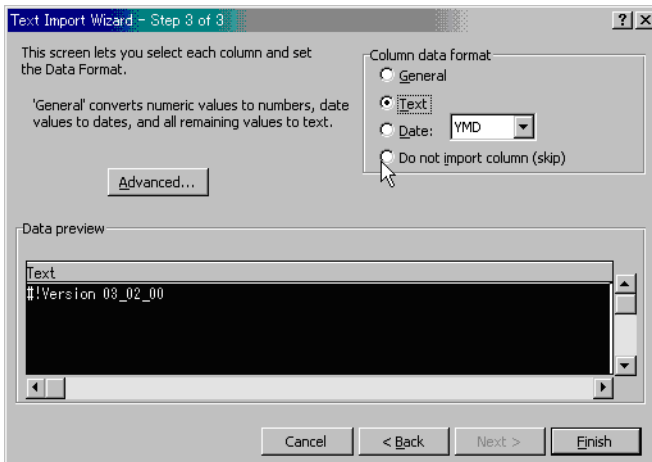

**Figure 165** Text Import Wizard - Step 3 of 3

5. Click **Finish** when you are done. The spreadsheet is opened.

## Closing the spreadsheet file

After you have edited the spreadsheet with Microsoft Excel 2000, save the spreadsheet file in CSV (Comma Separated Value) format. If you save the spreadsheet file in Microsoft Excel format or text format, a format error occurs. Also, save the spreadsheet file using the *.spd* file extension.

To save the file in CSV format with the *.spd* file extension, select **CSV** in the **Save as type** list in the Save As dialog box, and enter the file name within the quotation marks in the **File name** box.

---

## Starting Configuration File Loader

To access Configuration File Loader:

1. From the Device Launcher pane, click an XP128, XP1024, or XP12000.

2. Click the **Configuration File Loader** button (  ). The Configuration File Loader pane is displayed.

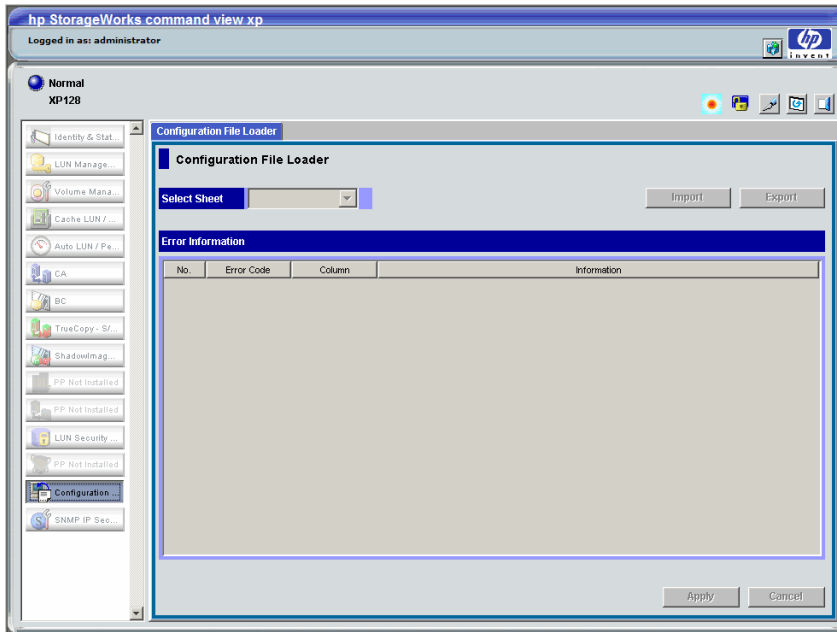

**Figure 166** Configuration File Loader pane

## Configuration File Loader pane

The components of the Configuration File Loader pane are as follows:

- **Select Sheet:** Used to select the function item to display error information in the Error Information list. An asterisk (\*) is displayed beside the function item that has the error. After you have imported the spreadsheet, the list becomes available. The function items are as follows:
  - Port
  - Cha
  - HostGroup
  - WWN
  - LUN
  - LDEV
- **Status:** Displays the status of the imported spreadsheet after importing the spreadsheet. When the spreadsheet includes some errors, **Error** is displayed. When there is no error in the spreadsheet, **Ready** is displayed. When **Ready** is displayed, the settings in the list can be applied to the disk array and therefore the **Apply** button becomes available.
- **Error Information:** Displays error information if the imported spreadsheet contains errors. Select the function item from the **Select Sheet** list to display the error information for a particular function. The displayed information includes:
  - **No.:** The row number that includes the error.
  - **Error Code:** The error code.
  - **Column:** The column number that includes the error. When the error column cannot be specified, "-" is displayed.
  - **Information:** The error message.

- Buttons:
  - Import:** Imports the edited spreadsheet file. For detailed information on the procedure to import the spreadsheet file, see ["Importing a spreadsheet file"](#) on page 319.
  - Export:** Exports the current spreadsheet file. For detailed information on the procedure to export the spreadsheet file, see ["Exporting a spreadsheet file"](#) on page 317.
  - Apply:** Applies the settings in the imported spreadsheet to the disk array. The **Apply** button becomes available only when a spreadsheet without errors is imported.
  - Cancel:** Cancels the imported spreadsheet file and returns the Configuration File Loader pane to the original status.

## Spreadsheet rules and formats

To set the configuration specified in the spreadsheet file, edit the spreadsheet according to the rules and formats indicated in this section. Following these rules and formats will prevent errors. The following figure shows a sample spreadsheet.

Declaration											
#Version 03_00_01,LUN,Change											
[Port]											
#Port	Switch	AL-PA	Fabric	Connection	Speed						
1A	OFF	EF	OFF	FC-AL	Auto	1A	ON	EF	OFF	FC-AL	Auto
[CHA]											
#CHA	PCB	Mode	Comment								
CHA-1P	HighSpeed										
[HostGroup]											
#Port	Grp ID	Name	Host	Adding							
			Mode								
1A	00	Grp00	01	1A	00	Grp04	02	1A	00	Grp00	00
1A	01	Grp01	00	1A	01	Grp01	01				
1A	02	Grp02	00								
[WWN]											
#Port	Grp ID	WWN	Name	Deleting							
1A	00	000000000000 0001	AA_2								
[LUN]											
#Port	Grp ID	LUN#	CU#	LDEV#	#Port	Grp ID	LUN#	CU#	LDEV#		

Current Configuration Definition (including a blank column)      New Configuration Definition (user settings)

**Figure 167** Sample Spreadsheet

## Spreadsheet file rules

The following table lists the requirements and rules for writing spreadsheets. To produce a spreadsheet file without errors, all of the requirements must be satisfied.

**Table 55** Requirements and rules for the spreadsheet file

Item	Requirements and Rules
File type	Text file
File name	<p>Extension must be <i>.spd</i>.</p> <p>Maximum number of letters for the file name is 32 including four letters of extension.</p> <p>Do not use spaces in the file name.</p> <p>The following symbols cannot be used for the file name:            \ / : , ; * ~ ? " &lt; &gt;   space</p> <p>File path must be under 255 letters.</p>
Maximum number of rows in a spreadsheet	70,000 rows
End-of-line character	Linefeed code must be in the end of each row.
Maximum number of letters in a row	Maximum number of letters in a row is 128 bytes including the linefeed code at the end.
Case-sensitivity	<p>Settings are not case-sensitive.</p> <p>However, the exceptions are the names of WWN and host group (host storage domain). The names of WWN and host group (host storage domain) are case-sensitive.</p>
Writing rules	<p>The following parameters should be written in hexadecimal numbers in two digits (one digit is also acceptable):            Host group ID, host mode, LUN, CU, LDEV</p> <p>Tab codes and a series of spaces before or after comma are ignored.</p>

If an error occurs with the spreadsheet file import operation, the following factors could be causing the problem. Review the following factors, check and revise the spreadsheet, and then try the operation again.

- First row of the spreadsheet (the declaration row) is not written correctly. For information on the declaration row, see "[Spreadsheet declaration](#)" on page 307.
- Spreadsheet file is not in the text file format (the file is a binary file).
- No function tag exists in the spreadsheet. For information on the function tag, see "[Function tag](#)" on page 307.
- File name is incorrect.  
 For example, the extension is not *.spd* or the file name exceeds the maximum number of letters.
- Number of letters in a row exceeds 128.
- Number of rows in the spreadsheet exceeds 70,000.
- The program product that is stated in the declaration row is not installed. For information on the declaration row, see "[Spreadsheet declaration](#)" on page 307.



# Spreadsheet components

The spreadsheet consists of the following components:

- "Spreadsheet declaration" on page 307
- "Function tag" on page 307
- "Configuration definition (settings)" on page 308
- "Comments" on page 309

## Spreadsheet declaration

The spreadsheet definition must be written at the beginning of the spreadsheet. Some parts of the declaration have already been written in the current spreadsheet. The declaration cannot be omitted. If the declaration line is incorrect, an error occurs during the spreadsheet file import operation and the spreadsheet file is rejected.

The spreadsheet declaration line is not case-sensitive.

- Format (*Italics are variables*):

```
#!Version Version number,Program Product,Process mode
```

- Example:

```
#!Version 03_02_00,LUN,Change
```

The components of the spreadsheet declaration are described in the following table.

**Table 56** Components of the spreadsheet declaration line

Component	Description
#!	The symbols indicate the declaration line. They cannot be changed.
Version	The word indicates that the RMI version number follows. It cannot be changed.
(1 byte space)	One byte space is required between <i>Version</i> and the version number.
Version number	RMI version number.
, (comma)	-
Program Product	The term that indicates the program product is required. For this version of the spreadsheet, <i>LUN</i> , which indicates LUN Manager, should be written.
, (comma)	-
Process mode	The term that indicates the process mode is required. For this version of the spreadsheet, <i>Change</i> , which indicates the changing process, is only available. When the exported spreadsheet file is opened, the process mode is not stated yet.

## Function tag

Each group of settings are identified by a function tag. The function tag is a string contained in brackets ([ ]). The types of the function tags depend on the program product (for example, the LUN Manager spreadsheet). Also, the order the function tag is displayed in a spreadsheet is set by the program product.

The following rules apply to function tags:

- A function tag must be written from the beginning of the row. Do not add a space or any other characters before a function tag.
- If you are not changing any of the settings for a function tag, delete the function tag and all its settings from the spreadsheet. In this situation, the function tag and settings should be in the spreadsheet.
- At least one function tag is required in a spreadsheet.
- Any other comments and settings written in the same row with the function tag are ignored.

An example of the declaration and the function tag is as follows:

```
#!Version 03_00_02,LUN,Change
[Port]
[Cha]
[HostGroup]
[WWN]
[LUN]
[LDEV]
```

## Configuration definition (settings)

After each function tag, write the configuration definition (settings). The configuration definition sets the parameters (adding, deleting, or changing) for the disk array. A configuration definition row can be divided into three different parts: the current settings area, a blank column, and the new settings area.

The following figure shows an example of the format of the configuration definition rows.

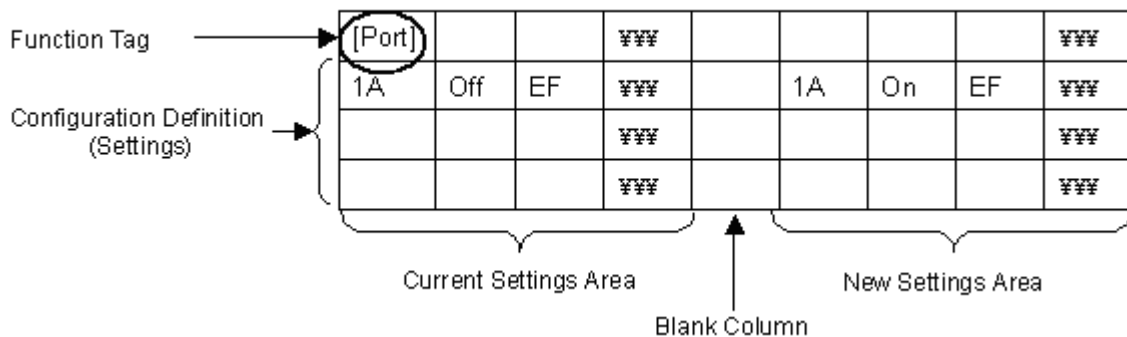

**Figure 168** Format of configuration definition (settings)

When you first export the spreadsheet, the current settings area contains setting information, but the new settings area does not. The new settings area is blank, but will eventually contain information that you add.

The following rules apply:

- Current settings area and the new settings area must be the same format. The easiest way of doing this is to copy the current settings columns, paste the columns in the new settings area, and then make the changes to the settings.
- Between the current settings area and the new settings area, add a blank column.
- For XP128/XP1024 arrays, you must begin the new settings area in the 8th column or an error will occur when the spreadsheet is imported.
- For XP12000 arrays, you must begin the new settings area in the 11th column or an error will occur when the spreadsheet is imported.
- Number of the available columns for each function tag depends on the number of parameters that can be set for each function. However, it also depends on the version of the spreadsheet.

- All the columns should be separated by comma.

For more information on adding, deleting, or changing settings, see [“Writing the configuration definition”](#) on page 309.

## Comments

In the spreadsheet, you can also add comment rows other than the configuration definition rows. To set a row as a comment row, write “#” at the very beginning of the row. If a space or other letters are inserted before “#”, the row is not recognized as a comment row and an error occurs. Because the comment row does not affect the settings of the spreadsheet, the comment row can consist of any character in any language. The row that includes only a linefeed code is also recognized as a comment row.

- Example:

```
#
#Change CHA settings.
[Cha]
#Cha, PcbMode
#
#
CHA-1P, Standard
CHA-1Q, Standard
```

In the exported spreadsheet, which includes the current configuration definition, some comment rows have already been inserted. The existing comment rows are as follows:

- The next row of the function tag indicates the required setting items (Cha and PcbMode in the example) for the function. The setting items are written separately by commas.

- Example:

```
[Cha]
#Cha, PcbMode
```

- The existing settings for the function are written. The existing settings row, which starts with “#\$”, is recognized as a comment row.



---

**NOTE:** The settings in the rows that start with “#\$” cannot be changed.

---

- Example:

```
[LUN]
#Port, HostGroup, LUN, CU, LDEV
#$1C, 0, 1, 1, 1
```

## Writing the configuration definition

Use the spreadsheet to set the configuration definition. Setting the configuration definition means the following:

- Add new settings
- Delete current settings
- Change current settings

The configuration definition must be written in a specific format. The types (add, delete, change) of configuration definition and the notes on writing a configuration definition are described in the following sections.



# LUN Manager spreadsheet

Use the LUN Manager spreadsheet to write the settings of port, CHA mode, host group (host storage domain), WWN, path definition, and command device. The format of the LUN Manager spreadsheet is as follows:

- **1st column to 6th column:** Current settings area
- **7th column (XP1028/1024), 7th column to 10th column (XP12000):** Blank column(s)
- **8th column to 13th column (XP1028/1024), 11th column to 16th column (XP12000):** New settings area

The number of columns used depends on the function tag. Some function tags require fewer than six columns. In this case, the unused columns remain blank. The following tables show the format of the LUN Manager spreadsheet.

**Table 57** Format of LUN Manager spreadsheet (XP128/1024)

Columns							
Function Tag	1st, 8th	2nd, 9th	3rd, 10th	4th, 11th	5th, 12th	6th, 13th	7th
[Port]	Port	Security Switch	AL-PA	Fabric	Connection	ChannelSpeed	Blank <sup>1</sup>
[Cha]	Cha	PcbMode	Blank	Blank	Blank	Blank	
[HostGroup]	Port	GroupId	GroupName	HostMode	Blank	Blank	
[WWN]	Port	GroupId	WWN	Nickname	Blank	Blank	
[LUN]	Port	GroupId	LunId	Cu	Ldev	Blank	
[LDEV]	Cu	Ldev	Cmd.Dev	Cmd.Sec	Blank	Blank	

1. When the LUN Manager spreadsheet is exported, the settings are written up to 7th column (blank column).

**Table 58** Format of LUN Manager spreadsheet (XP12000)

Columns							
Function Tag	1st, 11th	2nd, 12th	3rd, 13th	4th, 14th	5th, 15th	6th, 16th	7th to 10th
[Port]	Port	Security Switch	AL-PA	Fabric	Connection	ChannelSpeed	Blank <sup>1</sup>
[Cha]	Cha	PcbMode	Blank	Blank	Blank	Blank	
[HostGroup]	Port	GroupId	GroupName	HostMode	Blank	Blank	
[WWN]	Port	GroupId	WWN	Nickname	Blank	Blank	
[LUN]	Port	GroupId	LunId	Cu	Ldev	Blank	
[LDEV]	Cu	Ldev	Cmd.Dev	Cmd.Sec	Blank	Blank	

1. When the LUN Manager spreadsheet is exported, the settings are written up to 7th column (blank column).

The available values of the function tags for LUN Manager spreadsheet are explained in the following sections.

For detailed information on the function, the available values for LUN Manager, and the relationship between each function, see “[LUN Management for the XP128/XP1024/XP12000](#)” on page 179.

When you change the settings, edit the spreadsheet according to the rules of LUN Manager settings.

## Port settings

The [Port] tag sets the port information and the security switch (LUN security), and is available only for the changing operation. You cannot add or delete the settings with the [Port] tag definitions.

The following table shows the items and values available for the [Port] tag.

**Table 59** Available values of configuration definitions for the [Port] tag

Column XP128/1024	Column XP12000	Item	Available Value
1st, 8th (Index)	1st, 11th (Index)	Port	One of the following can be set: 1A, 1B, 1C, 1D, 1E, 1F, 1G, 1H, 1I, 1J, 1K, 1L, 1M, 1N, 1O, 1P, 1Q, 1R, 2A, 2B, 2C, 2D, 2E, 2F, 2G, 2H, 2I, 2J, 2K, 2L, 2M, 2N, 2O, 2P, 2Q, 2R, 3A, 3B, 3C, 3D, 3E, 3F, 3G, 3H, 3I, 3J, 3K, 3L, 3M, 3N, 3O, 3P, 3Q, 3R, 4A, 4B, 4C, 4D, 4E, 4F, 4G, 4H, 4I, 4J, 4K, 4L, 4M, 4N, 4O, 4P, 4Q, 4R
2nd, 9th	2nd, 12th	Security Switch	ON or OFF
3rd, 10th	3rd, 13th	AL-PA	Set with hexadecimal numbers in two digits.
4th, 11th	4th, 14th	Fabric	ON or OFF
5th, 12th	5th, 15th	Connection	FCAL or PtoP
6th, 13th	6th, 16th	ChannelSpeed	One of the following can be set: 1, 2, or Auto

When you change the settings on the port, note the following restrictions:

- CHA PCB mode: If the PCB mode is set to high-speed or high-speed (2 port) mode, changing the port settings is restricted. In this case, if there are settings with the [Cha] tag in the same spreadsheet, an error occurs, and the error information is displayed in the Error Information list when the spreadsheet is imported. If there is not a setting with the [Cha] tag in the same spreadsheet, the error occurs when the spreadsheet is imported and **Apply** is clicked.



**NOTE:** High-speed (2 port) mode is available only if the XP disk array has firmware version 21.06.22 or later installed.

- When the security switch is OFF, changing the security settings in other function tags is restricted. However, if you change the setting of the security switch from ON to OFF, the operation is not restricted. [Table 60](#) shows the relationship between the status of the security switch and availability of

the changing operation of the settings of each function tag. If you write the settings for the unavailable item, the error occurs and the error information is displayed in the Error Information list.

**Table 60** Status of security switch and restriction on setting operation

	Operation	Status of Security Switch			
		ON →OFF	ON →ON	OFF →ON	OFF →OFF
Host group	Adding	Yes <sup>1</sup>	Yes	Yes	No
	Changing the name	Yes	Yes	Yes	No
	Changing the host mode	Yes	Yes	Yes	No
	Changing the host mode for Group 00	Yes	Yes	Yes	Yes
	Deleting	Yes	Yes	Yes	Yes
	Deleting (settings for Group00) <sup>2</sup>	Yes	Yes	Yes	Yes
WWN	Adding	Yes	Yes	Yes	No
	Changing	Yes	Yes	Yes	No
	Deleting	Yes	Yes	Yes	Yes
LUN	Adding	Yes	Yes	Yes	No
	Changing	Yes	Yes	Yes	No
	Deleting	Yes	Yes	Yes	Yes

1. Yes: Available, No: Unavailable

2. WWN and LUN path definition under the Group 00 are deleted, host mode becomes 00, and the group name is changed to default.

## CHA mode settings

The [Cha] tag sets the CHA mode and is available only for the changing operation. You cannot add or delete the settings with the [Cha] tag definitions. The settings for the mainframe system are not written on the exported spreadsheet. The following table shows the items and values available for the [Cha] tag.

**Table 61** Available values of configuration definitions for the [Cha] tag

Column XP128/1024	Column XP12000	Item	Available Value
1st, 8th (Index)	1st, 11th (Index)	Cha	<p>The available values are different between the MC array and the SC array. One of the following can be set:</p> <p>For MC array: CHA-1P, CHA-1Q, CHA-1R, CHA-1S, CHA-2V, CHA-2W, CHA-2X, CHA-2Y</p> <p>For SC array: CHA-1D, CHA-1E, CHA-1G, CHA-2H, CHA-2K, CHA-2L</p>

**Table 61** Available values of configuration definitions for the [Cha] tag (continued)

Column XP128/1024	Column XP12000	Item	Available Value
2nd, 9th	2nd, 12th	PcbMode	One of the following can be set: For standard mode: Standard For high-speed mode: HighSpeed For high-speed (2 port) mode: HighSpeed2
3rd - 6th, 10th - 13th	3rd - 6th, 13th - 16th	Blank	



**NOTE:** High-speed (2 port) mode is available only if the XP disk array has firmware version 21.06.22 or later installed.

## Host group settings

The [HostGroup] tag sets the host group (host storage domain) information and is available for the adding, deleting and changing operation.

When you change the settings of the host group, note the following:

- You can delete the settings for the host group 0 (zero), but the host group 0 itself cannot be deleted. If you delete all the settings for the host group 0, the settings for the host group 0 become default.
- If you delete a host group, the WWN and path definition of the deleted host group are automatically deleted. Therefore, if you write the settings for the host group that is deleted in the [LUN] tag or [WWN] tag, an error occurs.
- When you want to add or change the host group, the security switch of the related port must be ON. If the security switch is OFF, you need to set the security switch ON in the [Port] tag. However, you can change the host mode of the host group 0, even if the security switch of the port is OFF.

The following table shows the items and values available for the [HostGroup] tag.

**Table 62** Available values of configuration definitions for the [HostGroup] tag

Column XP128/1024	Column XP12000	Item	Available Value
1st, 8th (Index)	1st, 11th (Index)	Port	One of the following can be set: 1A, 1B, 1C, 1D, 1E, 1F, 1G, 1H, 1I, 1J, 1K, 1L, 1M, 1N, 1O, 1P, 1Q, 1R, 2A, 2B, 2C, 2D, 2E, 2F, 2G, 2H, 2I, 2J, 2K, 2L, 2M, 2N, 2O, 2P, 2Q, 2R, 3A, 3B, 3C, 3D, 3E, 3F, 3G, 3H, 3I, 3J, 3K, 3L, 3M, 3N, 3O, 3P, 3Q, 3R, 4A, 4B, 4C, 4D, 4E, 4F, 4G, 4H, 4I, 4J, 4K, 4L, 4M, 4N, 4O, 4P, 4Q, 4R
2nd, 9th (Index)	2nd, 12th (Index)	GroupId	00–7F. Set with hexadecimal numbers in two digits.



**Table 62** Available values of configuration definitions for the [HostGroup] tag (continued)

Column XP128/1024	Column XP12000	Item	Available Value
3rd, 10th	3rd, 13th	GroupName	Up to eight ASCII characters (letters, numerals, and symbols). The setting is case-sensitive.
4th, 11th	4th, 14th	HostMode	00—1F
5th, 6th, 12th, 13th	5th, 6th, 15th, 16th	Blank	

## WWN settings

The [WWN] tag sets the WWN information and is available for the adding, deleting and changing operation. The following table shows the items and values available for the [WWN] tag.

**Table 63** Available values of configuration definitions for the [WWN] tag

Column XP128/1024	Column XP12000	Item	Available Value
1st, 8th (Index)	1st, 11th (Index)	Port	One of the following can be set: 1A, 1B, 1C, 1D, 1E, 1F, 1G, 1H, 1I, 1J, 1K, 1L, 1M, 1N, 1O, 1P, 1Q, 1R, 2A, 2B, 2C, 2D, 2E, 2F, 2G, 2H, 2I, 2J, 2K, 2L, 2M, 2N, 2O, 2P, 2Q, 2R, 3A, 3B, 3C, 3D, 3E, 3F, 3G, 3H, 3I, 3J, 3K, 3L, 3M, 3N, 3O, 3P, 3Q, 3R, 4A, 4B, 4C, 4D, 4E, 4F, 4G, 4H, 4I, 4J, 4K, 4L, 4M, 4N, 4O, 4P, 4Q, 4R
2nd, 9th (Index)	2nd, 12th (Index)	GroupId	00—7F. Set with hexadecimal numbers in two digits.
3rd, 10th (Index)	3rd, 13th	WWN	Set with hexadecimal numbers in 16 digits.
4th, 11th	4th, 14th	Nickname	Up to eight ASCII characters (letters, numerals, and symbols). The setting is case-sensitive.
5th, 6th, 12th, 13th	5th, 6th, 15th, 16th	Blank	

## Path settings

The [LUN] tag sets the path definition and is available for the adding, deleting and changing operation. The following table shows the items and values available for the [LUN] tag.

**Table 64** Available values of configuration definitions for the [LUN] tag

Column XP128/1024	Column XP12000	Item	Available Value
1st, 8th (Index)	1st, 11th (Index)	Port	One of the following can be set: 1A, 1B, 1C, 1D, 1E, 1F, 1G, 1H, 1I, 1J, 1K, 1L, 1M, 1N, 1O, 1P, 1Q, 1R, 2A, 2B, 2C, 2D, 2E, 2F, 2G, 2H, 2I, 2J, 2K, 2L, 2M, 2N, 2O, 2P, 2Q, 2R, 3A, 3B, 3C, 3D, 3E, 3F, 3G, 3H, 3I, 3J, 3K, 3L, 3M, 3N, 3O, 3P, 3Q, 3R, 4A, 4B, 4C, 4D, 4E, 4F, 4G, 4H, 4I, 4J, 4K, 4L, 4M, 4N, 4O, 4P, 4Q, 4R
2nd, 9th (Index)	2nd, 12th (Index)	GroupId	00—7F. Set with hexadecimal numbers in two digits.
3rd, 10th (Index)	3rd, 13th (Index)	LunId	00—FF. Set with hexadecimal numbers in two digits.
4th, 11th	4th, 14th	Cu	00—1F. Set with hexadecimal numbers in two digits.
5th, 12th	5th, 15th	Ldev	00—FF. Set with hexadecimal numbers in two digits.
6th, 13th	6th, 16th	Blank	

## Command device settings

The [LDEV] tag changes the command device settings and is available only for the changing operation. You cannot add or delete the settings with the [LDEV] tag definitions. When the command device (Cmd. Dev) is OFF, and the command device security (Cmd. Sec) is ON, an error occurs. You can set the command device OFF, regardless of the existence of the LU path.

The following table shows the items and values available for the [LDEV] tag.

**Table 65** Available values of configuration definitions for the [LDEV] tag

Column XP128/1024	Column XP12000	Item	Available Value
1st, 8th (Index)	1st, 8th (Index)	Cu	00—1F. Set with hexadecimal numbers in two digits.
2nd, 9th (Index)	2nd, 9th (Index)	Ldev	00—FF. Set with hexadecimal numbers in two digits.
3rd, 10th	3rd, 10th	Cmd.Dev (Command Device)	ON or OFF
4th, 11th	4th, 11th	Cmd.Sec (Command Device Security)	ON or OFF
5th, 6th, 12th, 13th	5th, 6th, 12th, 13th	Blank	

# Using Configuration File Loader

Using Configuration File Loader topics also include the following:

- “Exporting a spreadsheet file” on page 317
- “Editing a spreadsheet file” on page 318
- “Importing a spreadsheet file” on page 319

## To use Configuration File Loader:

1. From the Device Launcher pane, click an XP128, XP1024 or XP12000.
2. Make sure you are in Modify mode (the pen icon with the yellow background will be displayed if you are in Modify mode).
3. Click the **Configuration File Loader** button (  ). The Configuration File Loader pane is displayed.
4. Click **Export** to export the current spreadsheet. See “Exporting a spreadsheet file” on page 317.
5. Edit the exported spreadsheet. For an explanation of the rules and format to follow when editing the spreadsheet, see “Spreadsheet rules and formats” on page 305. For instructions on using spreadsheet software, see “Spreadsheet software requirements” on page 302. For instructions on making changes to the spreadsheet file, see “Editing a spreadsheet file” on page 318.
6. Click **Import** to import the edited spreadsheet file. See “Importing a spreadsheet file” on page 319.
  - a. If the spreadsheet includes errors, the error message is displayed or error information is listed in the Error Information list. Go to [step 7](#).
  - b. If the spreadsheet does not have any errors, the **Apply** button becomes available. Go to [step 8](#).
7. Edit the spreadsheet to correct the errors, and then import the corrected spreadsheet file.

If the spreadsheet still contains errors, the error message or error information is displayed again. Repeat this step to correct and import the spreadsheet file until all errors have been corrected. When a spreadsheet file without errors is imported, the **Apply** button becomes available.
8. Click **Apply** to apply the settings in the spreadsheet to the disk array.

If an error occurs, the error message is displayed. Correct the spreadsheet according to the error message, import the corrected spreadsheet, and click **Apply**. The **Apply** button will not be available until a spreadsheet without errors is imported. If no errors are displayed, the operation is completed.

## Exporting a spreadsheet file

As the first step of editing the spreadsheet, export the current spreadsheet from the disk array by clicking **Export**.

### To export the spreadsheet file:

1. From the Configuration File Loader pane, click **Export**. The Export dialog box is displayed.

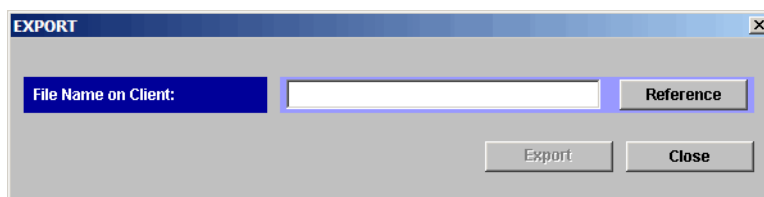

**Figure 170** Export dialog box

2. From the Export dialog box, indicate where to save the spreadsheet by clicking **Reference** to open the Save dialog box.

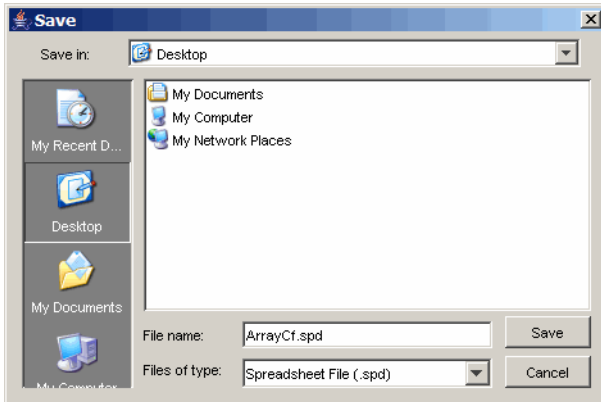

**Figure 171** Specifying where to save the spreadsheet

3. Navigate to the directory in which to save the file, and enter the file name in the **File name** box. Be sure to use the .spd file extension when naming the file. For additional information on file naming rules, see “[Spreadsheet file rules](#)” on page 306.
4. Click **Save**. The specified directory is displayed in the **File Name on Client** box and the **Export** button becomes available.



5. Click **Export** to export the spreadsheet file. To cancel the operation, click **Close**.

## Editing a spreadsheet file

This section explains how to add, delete, and change settings in an exported spreadsheet file. These instructions assume you are using a spreadsheet application such as Microsoft Excel. When editing a spreadsheet file in a text editor, the same rules apply. The main difference is that a spreadsheet application uses the concept of columns, and in a text editor, each column is separated by a comma.

### To edit the spreadsheet file:

1. Export the spreadsheet and open the file in a spreadsheet application or text editor.
2. Edit the declaration, which is the first line, by adding the word *Change* in the third column.
3. For XP128/1024, copy and paste columns 1 through 6 into columns 8 through 13. Be sure to leave column 7 blank. For XP12000, copy and paste columns 1 through 10 into columns 11 through 20. Be sure to leave columns 7, 8, 9, 10 blank.
4. Identify the settings you want to change by locating its function tags.

- To add a new setting, insert a new row below the function tag and column heading, and add the changes to the new settings area.

#! Version 03_02_00				Lun	Change							
[HostGroup]												
#Port	GroupId	Group Name	Host Mode									
1A	00	1A-G00	00									
1B	00	1B-G00	00									
[WWN]												
#Port	GroupId	WWN	Nickname									
1A	00	200301300000001	WN01									
1B	00	200211130000001	WN02									

New setting

- To delete an existing setting, delete the settings in the new settings area. Leaving the new settings area blank resets the settings.

#! Version 03_02_00				Lun	Change							
[HostGroup]												
#Port	GroupId	Group Name	Host Mode									
1A	00	1A-G00	00									
1A	01	1A-G01	00									
1B	00	1B-G00	00									
[WWN]												
#Port	GroupId	WWN	Nickname									
1A	00	200301300000001	WN01									
1B	00	200211130000001	WN02									

Delete setting

- To change a current setting, edit the setting in the new settings area. Note that certain settings cannot be changed. For example, you cannot change the ports in the [Port] tag.

#! Version 03_02_00						Lun	Change						
[Port]													
#Port	Security Switch	AL-PA	Fabric	Connection	ChanelSpeed								
1A	Off	E2	On	FCAL	2								
1B	Off	D6	Off	PtoP	1								
1C	Off	DC	On	FCAL	Auto								
1D	Off	E2	On	FCAL	Auto								
[Cha]													
#Cha	PcbMode												
CHA-1C	Standard												

Changed setting

- If you are not changing a setting, delete the entire row. If you are not changing any of the settings for an entire function tag, delete the function tag and all its settings.
- Save the spreadsheet file when you are done making changes and import the file using Configuration File Loader.

## Importing a spreadsheet file

After editing the spreadsheet, complete the following instructions to import the spreadsheet file.

## To import the spreadsheet file:

1. From the Configuration File Loader pane, click **Import**. The Import dialog box is displayed.



Figure 172 Import dialog box

2. From the Import dialog box, indicate from where to import the spreadsheet file by clicking **Reference** to open the Open dialog box.

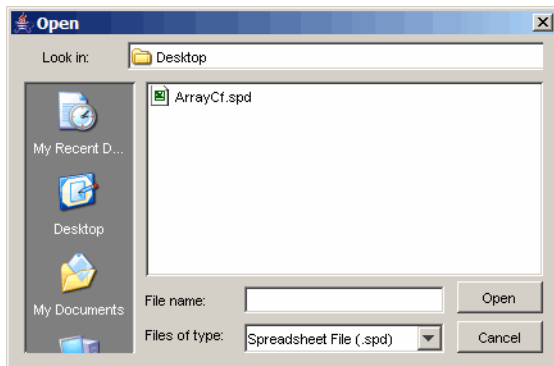

Figure 173 Specifying from where to import the spreadsheet

3. Navigate to the directory containing the spreadsheet, and then select the file. Be sure the file uses the .spd file extension. For additional information on file naming rules, see ["Spreadsheet file rules"](#) on page 306.
4. Click **Open**. The specified directory is displayed in the **File Name on Client** box and the **Import** button becomes available.



5. Click **Import** to import the spreadsheet file. To cancel the import operation, click **Close**.

---

## Spreadsheet error checking

Before the configuration definition on the spreadsheet is applied to the disk array, Configuration File Loader checks the spreadsheet in three steps on the different criteria. The three different criteria are explained in the following sections.

### First check

The first check is performed when the spreadsheet file is imported. Configuration File Loader checks the format of the spreadsheet to verify it is formatted and written in the specified way. If an error occurs, the spreadsheet is rejected and the error message is displayed.

The spreadsheet is checked according to the following criteria for the first check:

- First row of the spreadsheet (the declaration row) is not correctly written. For information on the declaration row, see "[Spreadsheet declaration](#)" on page 307.
- Spreadsheet file is not in the text file format (the file is a binary file).
- No function tag exists in the spreadsheet. For information on the function tag, see "[Function tag](#)" on page 307.
- File name is incorrect. For example, the extension is not *.spd* or the file name exceeds the maximum number of letters.
- Number of letters in a row exceeds 128.
- Number of rows in the spreadsheet exceeds 70,000.
- Program product that is stated in the declaration row is not installed. For information on the declaration row, see "[Spreadsheet declaration](#)" on page 307.

## Second check

Configuration File Loader then checks the settings (configuration definitions) in the spreadsheet. The second check is performed before the **Apply** button becomes available. The information on the errors found by the second check is listed in the Error Information list. The second check consists of two kinds of the checks.

The first step is the check on the written format and the parameters. The second step is the logical check of the settings. When no error is found by the first step of the check, the check of the second step is performed. The criteria of each step is as follows:

- Check on the written format and the parameters:

If the imported spreadsheet corresponds with the following criteria, the error information is displayed in the Error Information list.

- An unsupported function tag is written.
- An unsuitable setting value is written or not written at all.
- The range of the setting is not correct. The correct range of the settings are as follows:

CU: 00—1F

LDEV: 00—FF

LUN: 00—FF

Group ID: 00—7F

Host Mode: 00—1F

- Logical check on the settings:

Configuration File Loader compares the current settings and the settings in the imported spreadsheet file, and checks the settings logically. However, the errors, which can only be found by the third check, cannot be detected.

## Third check

The third check is performed after **Apply** is clicked. The errors that cannot be detected by the first and the second check are finally detected by the third check. If an error is detected, the error message is displayed.

The spreadsheet is checked according to the following criteria for the third check:

- No difference is found between the current configuration definition and the configuration definition on the imported spreadsheet.

The spreadsheet is accepted anyway, but no operation is performed.

- The [Port] tag is on the spreadsheet, but the [Cha] tag is not, and the new port settings and the current PCB mode settings of the [Cha] tag do not match.

First, the port settings are processed and then the CHA settings are processed. Therefore, when the CHA settings are not stated on the spreadsheet, the error cannot be detected at the second check.

On the other hand, when the PCB mode settings of the [Cha] tag are on the spreadsheet, and the port settings are not, the PCB mode is checked with the current settings of the port. Therefore, the error is detected by the second check.

- The setting to delete LUN is defined for the port to which the I/Os are demanded.

The errors caused by other factors are detected by the second check as the logical errors of the settings. However, there could be a case that the current settings are changed even though you are in the Modify mode. In this case, the error occurs at the third check.



# 20 Cache LUN for the XP48/XP512

Use Cache LUN to reserve areas of cache memory on the disk array for storing high-use data from LDEVs. Data access speed is improved because the cache-resident data is available to the hosts at much faster transfer speeds. This can be applied to both read and write I/O operations.

## Supported volumes

Cache LUN works with normal volumes, LUSE volumes, and customized (VSC) volumes.

Use VSC volumes and Cache LUN together to achieve higher data access performance (than when these features are used separately).

## Cache LUN tasks

Use Cache LUN to perform the following tasks:

- Set (creating) data areas (called cache extents) in cache memory (see ["Setting \(creating\) a cache extent"](#) on page 326)
- Release (removing) data areas from cache memory (see ["Releasing \(removing\) a cache extent"](#) on page 328)
- Change an extent's mode (see ["Changing an extent's mode"](#) on page 328)

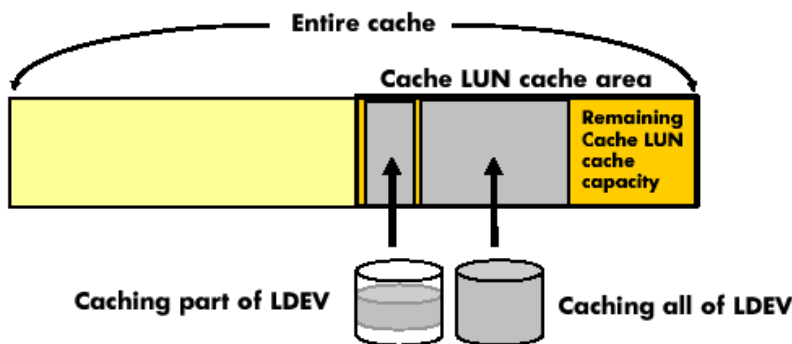

**Figure 174** Cache LUN operations

Cache LUN requires a portion of cache memory, called the *Cache LUN cache area*. You can change the capacity of the Cache LUN cache area when installing or removing cache memory.

Typically, data assigned to Cache LUN becomes resident (*staged*) in cache after it is first accessed by a host. Then, the host finds the data in cache for the second and subsequent accesses.

Cache areas (also called *cache extents*) can be added or removed at any time. Each cache extent is defined as a range of logical blocks within an LDEV or as an entire LDEV. Logical blocks are defined by starting and ending Logical Block Addresses (LBAs).

## Supported emulation types and other parameters

### Supported emulation types

OPEN-3, OPEN-8, and OPEN-9 are supported.

## Modified volume types

LUSE (LU Size Expansion) and VSC volumes can be placed in the Cache LUN cache area.

If you want to apply Cache LUN to a LUSE volume, you must apply Cache LUN to all the LDEVs that form the LUSE volume.

## Unit of cache area allocation

A Cache LUN extent is a range of logical blocks within an LDEV. A logical block is 512 bytes.

**Table 66** Cache LUN supported emulation types and parameters

Parameter	OPEN-3	OPEN-8	OPEN-9
Minimum size for a Cache LUN extent	512 bytes (1 logical block)	512 bytes (1 logical block)	512 bytes (1 logical block)
Maximum size for a Cache LUN extent	2.4 GB	7.3 GB	7.3 GB
Cache LUN size increment	512 bytes (1 logical block)	512 bytes (1 logical block)	512 bytes (1 logical block)
Maximum number of Cache LUN extents	1024	1024	1024
Maximum number of Cache extents per LDEV	1024	1024	1024

## Restrictions

**Table 67** Restrictions

Configuration Restrictions	<ul style="list-style-type: none"><li>Do not exceed the capacity of the Cache LUN cache.</li><li>Do not configure an Auto LUN reserved volume for Cache LUN.</li><li>Do not place an LDEV in cache twice.</li><li>You cannot allocate Cache LUN cache space for an on-demand LDEV.</li><li>To apply Cache LUN to a LUSE volume, you must apply it to all the LDEVs that form the LUSE volume.</li></ul>
Usage Restrictions	<ul style="list-style-type: none"><li>If an LDEV is placed in cache, do not use it for BC/CA quick restore operations or Auto LUN migration. These operations may swap the internal locations of the primary and secondary volumes and cause a loss of data integrity.</li><li>You cannot change a Cache LUN extent after it is configured. To change the specification, you must reset (<i>release</i>) the Cache LUN extent, and then re-allocate (<i>set</i>) the Cache LUN extent.</li></ul>
VSC Automatic Resets	<p>In the following cases, a Cache LUN cache extent is deleted (<i>reset</i> or <i>released</i>) automatically:</p> <ul style="list-style-type: none"><li>If a fixed volume, part or all of which is assigned to Cache LUN, is converted into free space by the VSC Volume to Space function.</li><li>If a custom volume, part or all of which is assigned to Cache LUN, is converted into free space using the VSC Volume to Space function.</li><li>If an LDEV (or VDEV) containing fixed and custom volumes assigned to Cache LUN is initialized by the VSC Volume Initialize function.</li></ul>

---

# Cache LUN modes

Cache LUN has two modes:

- priority mode
- bind mode

## Priority mode

Priority mode requires fewer cache resources but has performance limitations over bind mode. Priority mode keeps all read data in cache (until you delete the extent) but all writes are destaged to disk normally (using the same algorithms as for regular, non-Cache LUN data).

### Priority mode details

- All reads following the initial read to a block will result in cache hits (100% cache read hits).
- After destaging of the write block to disk, the duplicated write areas in general cache become free.
- While destaging to disk, read requests to the same block are delayed until the disk operation is completed.
- Priority mode generates write traffic to disk, whereas bind mode does not.

### General cache capacity

In addition to the Cache LUN cache, you should set the general cache capacity according to the number of areas set in priority mode. This prevents a reduction in general cache performance.

If the general cache is overloaded (having very little cache space), it will be exhausted, often resulting in a wait for free cache space. This may degrade access to the general cache.

- If you set up to 512 areas in Cache LUN, set 512 MB x 2 (1024 MB) of standard cache.
- If you set 513-1024 areas in Cache LUN, set 1024 MB x 2 (2048 MB) of standard cache.

## Bind mode

Bind mode keeps both read and write data in cache, eliminating disk traffic (100% read/write hits). All data stays in cache until the extent is removed. The data stored in the Cache LUN cache is duplexed for data protection, which requires additional Cache LUN cache capacity. If AC power is lost, data is maintained in cache for up to 48 hours, using battery power.

### Bind mode details

- All reads following the initial read to a block will result in cache hits.
- Duplicated write blocks are stored in cache and are never “evicted.”
- All read or write blocks stay resident in cache until the extent is deleted.
- Bind mode requires more cache because duplicated write blocks are not destaged to disk.

### Bind mode and RAID groups

For RAID-5 parity groups, a Cache LUN extent in bind mode requires a cache capacity three times larger than the user data.

For RAID-1 parity groups, a Cache LUN extent in bind mode requires a cache capacity twice as large as user data.

If you want to change a RAID-1 or RAID-5 parity group's mode from priority mode to bind mode, reset and re-allocate the affected Cache LUN extent. When you re-allocate, specify the greater capacity needed for bind mode.

## Starting Cache LUN

1. From the Device Launcher pane, click **Modify** or **View** for an XP48/XP512.
2. Click **Cache LUN** in the left pane. The Cache LUN pane appears.

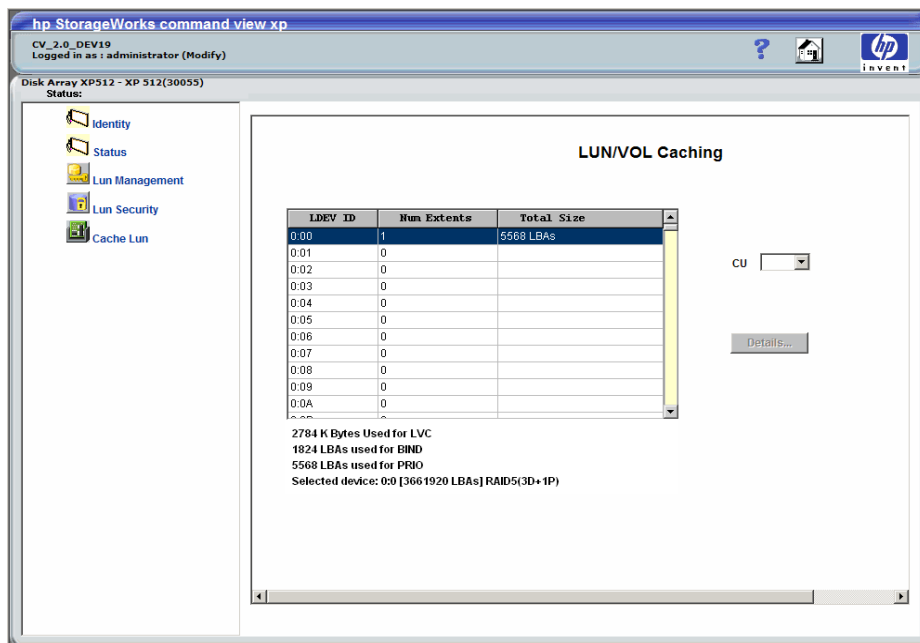

Figure 175 Cache LUN pane

## Cache LUN pane

This pane lists the following items:

- **CU:** A list where you can select the CU containing the LDEVs you want to work with.
- **Table:** Displays the current caching configurations of the LDEVs in the selected disk array CU, including the LDEV ID, number of extents used, and total size of cache extents are displayed.

Displayed below the table are the bytes used for LVC, the number of LBAs used for Bind mode, the number of LBAs used for Priority mode, and the selected device (CU:LDEV number, number of LBAs on the device, and RAID type of the device).

- **Details** Button: Enabled when you select an LDEV. Click **Details** to view buttons for adding and deleting cache extents.

## Setting (creating) a cache extent

To place data in cache

1. From the LUN/VOL Caching pane, select a CU in the **CU** list.
2. Select an LDEV in the LDEV table.

3. Click **Details**. The LUN/VOL Caching Define pane is displayed.

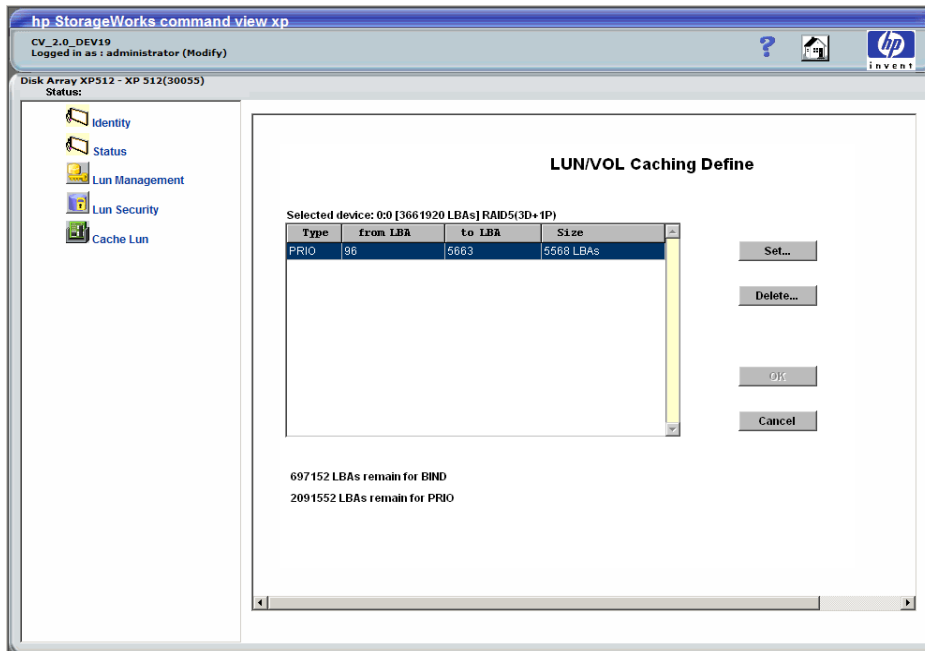

Figure 176 LUN/VOL Caching Define pane

4. Click **Set**.

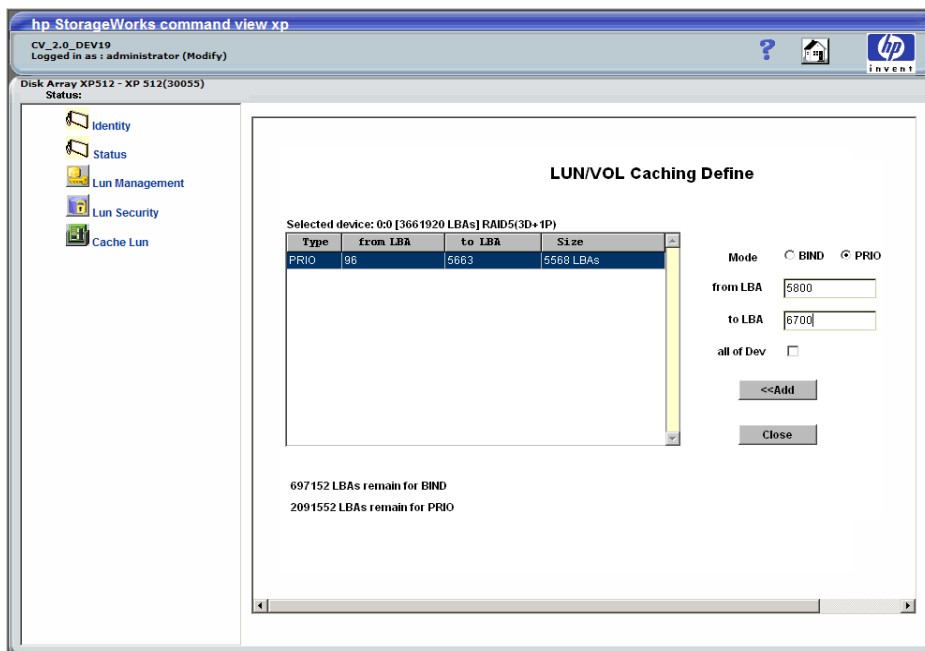

Figure 177 LUN/VOL Caching Define pane after clicking Set

5. Select a mode (**Bind** or **Prio**).
6. Enter the starting and ending LBAs. Alternately, you can select the **all of Dev** check box.
7. Click **Add**. To add more cache extents, repeat [step 5](#) - [step 7](#).
8. Click **Close**. This pane is replaced on with the original set of four buttons.
9. Click **OK**.

---

## Releasing (removing) a cache extent

### To remove data from cache

1. From the LUN/VOL Caching pane, select a CU in the **CU** list.
2. In the list, select an LDEV.
3. Click **Details**. The LUN/VOL Caching Define pane is displayed.
4. Click the cache extent you want to remove.
5. Click **Delete**. The cache extent is removed from the list box. To delete more cache extents, repeat [step 4](#) - [step 5](#).
6. Click **OK**.

---

## Changing an extent's mode

You cannot directly change a cache extent's mode; however you can delete the extent and reconfigure it with a new mode setting.

1. Select and release (remove) the extent in the Cache LUN cache.
2. Remake the extent with the new mode.

# 21 Cache LUN for the XP128/XP1024/XP12000

Use Cache LUN to reserve areas of cache memory on the disk array for storing high-use data from the LDEVs. Data access speed is improved because the cache-resident data is available to the hosts at much faster transfer speeds. This can be applied to both read and write I/O operations.

## Supported volumes

Cache LUN works with normal volumes, LUSE volumes, and custom volumes (configured through VSC).

Use custom volumes and Cache LUN together to achieve higher data access performance (than when these features are used separately).

## Cache LUN tasks

Use cache LUN to perform the following tasks:

- "Setting (Creating) a Cache Extent" on page 335
- "Releasing (Removing) a Cache Extent" on page 338
- "Changing an Extent's Mode and Pre-staging" on page 339

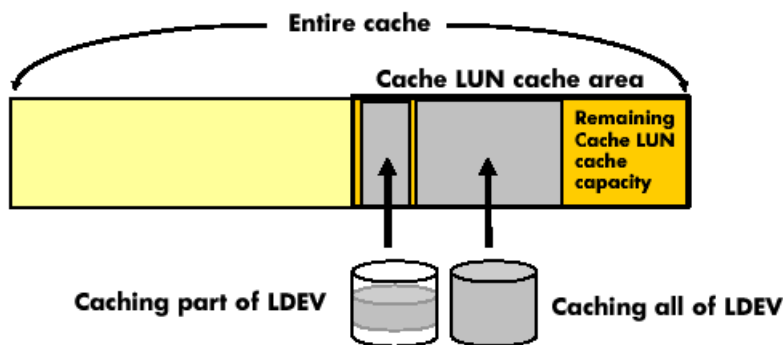

**Figure 178** Cache LUN operations

Cache LUN requires a portion of cache memory, called the *Cache LUN cache area*. You can change the capacity of the Cache LUN cache area when installing or removing cache memory.

Typically, data assigned to Cache LUN becomes resident (*staged*) in cache after it is first accessed by a host. Then, the host finds the data in cache for the second and subsequent accesses.

Another function, called pre-staging, puts data in the Cache LUN cache area when the data is first set up for caching. Pre-staging allows the host to find data in the cache at the first access.

Cache areas (also called *cache extents*) can be added or removed at any time. Each cache extent is defined as a range of logical blocks within an LDEV or as an entire LDEV. Logical blocks are defined by starting and ending Logical Block Addresses (LBAs).

---

# Supported Emulation Types and Other Parameters

## Supported emulation types

Supported open system emulation types are OPEN-3, OPEN-8, OPEN-9, OPEN-E, OPEN-L, and OPEN-V.

Supported mainframe emulation types are 3390-3, 3390-3A, 3390-3B, 3390-3C, 3390-3R, 3390-9, 3390-9A, 3390-9B, 3390-9C, 3390-L, 3390-LA, 3390-LB, and 3390-LC.

## Modified volume types

LUSE (LU Size Expansion) and VSC (Volume Size Configuration) volumes can be placed in the Cache LUN cache area.

If you want to apply Cache LUN to a LUSE volume, you must apply Cache LUN to all the LDEVs that form the LUSE volume.

## Unit of cache area allocation

A Cache LUN extent is a range of logical blocks within an LDEV. A logical block is 512 bytes.

For OPEN-V, a cache extent must have at least 128 Logical Block Addresses (LBAs), or 66 kB. For all other supported open system emulation types, a cache extent must have at least 96 Logical Block Addresses (LBAs), or 49.5 KB. This is known as a cache slot. A cache extent can have a maximum size of an entire LDEV, up to the limits of Cache LUN cache memory. Allocate data to Cache LUN with a minimum size of 128 LBAs for OPEN-V and 96 LBAs for other than OPEN-V.

For mainframe systems, a cache extent must be at least one cache slot or track (48 KB or 64 KB). Its maximum size may be an entire LDEV, up to the limits of Cache LUN cache memory. Allocate data to Cache LUN in units of cylinders and tracks.

### Number of cache areas allowed

- In DKC: 1,024
- In LDEV: 1,024

---

## Restrictions

**Table 68** Restrictions

Configuration Restrictions	<ul style="list-style-type: none"><li>• Do not exceed the capacity of the Cache LUN cache.</li><li>• Do not configure an Auto LUN reserved volume for Cache LUN.</li><li>• Do not place an LDEV in cache twice.</li><li>• You cannot allocate Cache LUN cache space for an on-demand LDEV.</li><li>• To apply Cache LUN to a LUSE volume, you must apply it to all the LDEVs that form the LUSE volume.</li></ul>
----------------------------	---



**Table 68** Restrictions (continued)

Usage Restrictions	<ul style="list-style-type: none"><li>If an LDEV is placed in cache, do not use it for BC/CA quick restore operations or Auto LUN migration. These operations may swap the internal locations of the primary and secondary volumes and cause a loss of data integrity.</li><li>You cannot change a Cache LUN extent after it is configured. To change the specification, you must reset (<i>release</i>) the Cache LUN extent, and then re-allocate (<i>set</i>) the Cache LUN extent.</li></ul>
VSC Automatic Resets	<p>In the following cases, a Cache LUN cache extent is deleted (<i>reset or released</i>) automatically:</p> <ul style="list-style-type: none"><li>If a fixed volume, part or all of which is assigned to Cache LUN, is converted into free space by the VSC Volume to Space function.</li><li>If a custom volume, part or all of which is assigned to Cache LUN, is converted into free space using the VSC Volume to Space function.</li><li>If an LDEV (or VDEV) containing fixed and custom volumes assigned to Cache LUN is initialized by the VSC Volume Initialize function.</li></ul>

## Cache LUN modes

Cache LUN has two modes:

- priority mode
- bind mode

### Priority mode

Priority mode requires fewer cache resources but has performance limitations over bind mode. Priority mode keeps all read data in cache (until you delete the extent) but all writes are destaged to disk normally (using the same algorithms as for regular, non-Cache LUN data).

#### Priority mode details

- All reads following the initial read to a block will result in cache hits (100% cache read hits).
- After destaging of the write block to disk, the duplicated write areas in general cache become free.
- While destaging to disk, read requests to the same block are delayed until the disk operation is completed.
- Priority mode generates write traffic to disk, whereas bind mode does not.

#### General cache capacity

In addition to the Cache LUN cache, you should set the general cache capacity according to the number of areas set in priority mode. This prevents a reduction in general cache performance.

If the general cache is overloaded (having very little cache space), this can result in a wait for free cache space. This may degrade access to the general cache.

- If you set up to 512 areas in Cache LUN, set 512 MB x 2 (1024 MB) of standard cache.
- If you set 513-1024 areas in Cache LUN, set 1024 MB x 2 (2048 MB) of standard cache.
- For OPEN-V, one slot is 66 kB, which requires 4 cache segments (16.5 kB/segment). For example, 16 slots require 1,056 kB of reserved cache.

- For other than OPEN-V, one slot is 49.5 kB, which requires 3 cache segments. For example, 16 slots require 792 kB of reserved cache.

## Bind mode

Bind mode keeps both read and write data in cache, eliminating disk traffic (100% read/write hits). All data stays in cache until the extent is removed. The data stored in the Cache LUN cache is duplexed for data protection, which requires additional Cache LUN cache capacity. If AC power is lost, data is maintained in cache for up to 48 hours, using battery power.

### Bind mode details

- All reads following the initial read to a block will result in cache hits.
- Duplicated write blocks are stored in cache and are never “evicted.”
- All read or write blocks stay resident in cache until the extent is deleted.
- Bind mode requires more cache because duplicated write blocks are not destaged to disk.

### Bind mode and RAID groups

For RAID-5 parity groups, a Cache LUN extent in bind mode requires a cache capacity three times larger than the user data.

- For OPEN-V, one slot is 66 kB, which requires 12 cache segments (16.5 kB/segment). For example, 16 slots require 3,168 kB of reserved cache.
- For other than OPEN-V, one slot is 49.5 kB, which requires 9 cache segments. For example, 16 slots require 2,376 kB of reserved cache.

For RAID-1 parity groups, a Cache LUN extent in bind mode requires a cache capacity twice as large as user data.

- For OPEN-V, one slot is 66 kB, which requires 8 cache segments (16.5 kB/segment). For example, 16 slots require 2,112 kB of reserved cache.
- For other than OPEN-V, one slot is 49.5 kB, which requires 6 cache segments. For example, 16 slots require 1,584 kB of reserved cache.

If you want to change a RAID-1 or RAID-5 parity group’s mode from priority mode to bind mode, reset and re-allocate the affected Cache LUN extent. When you re-allocate, specify the greater capacity needed for bind mode.

---

## Pre-staging

As mentioned before, data assigned to a Cache LUN cache extent becomes resident (“staged”) in cache after it is first accessed by the host. Then, the host finds the data in cache for the second and subsequent accesses. The pre-staging function puts data in cache before the first read. Therefore, pre-staging allows the host to find data in cache on the first access.

Specify pre-staging when you set up the cache extent. You can use this function with either priority or bind mode.

You cannot change a Cache LUN extent after it is configured. To change the specification, you must reset (“release”) the Cache LUN extent, and then re-allocate (“set”) the Cache LUN extent.

---

## Starting Cache LUN

1. In the Device Launcher pane, click an XP128/XP1024/XP12000 link.

2. Click **Cache LUN** in the left pane. The Cache LUN pane appears.

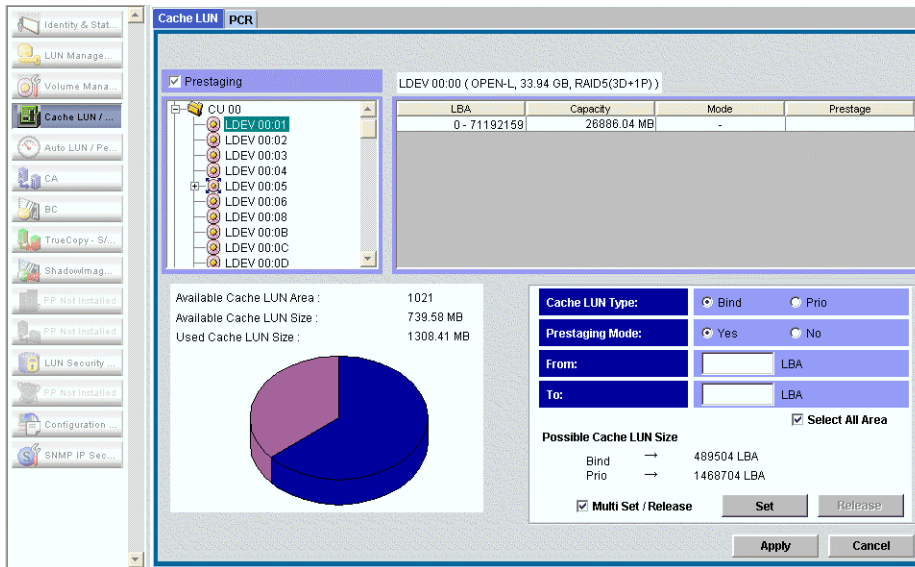

**Figure 179** Cache LUN pane

## Cache LUN pane

This pane lists the following items:

### Prestaging check box

Select or clear this check box to enable or disable the pre-staging function:

- If you select this check box, set the Prestaging Mode to **Yes** and click **Apply**. A non-pre-staging operation will be performed and then a pre-staging operation will be performed.
- If you clear this check box and then click **Apply**, a non-pre-staging operation will be performed, but a pre-staging operation will not be performed. If you select this check box later and then click **Apply**, only a pre-staging operation will be performed.

When a pre-staging operation is in progress, the text **Prestaging operation in progress** is shown at the bottom of the Cache LUN pane. The progress is displayed in percentage.

The **Prestaging** check box is enabled in Modify mode and is selected by default. However, the **Prestaging** check box is disabled in either of the following conditions:

- No cache
- Prestaging mode is set to **No** for each cache



### LDEV tree

The LDEV tree displays the CU number (for example, CU 00) and LDEV number (for example, LDEV 00) available for Cache LUN operations in a tree. The tree uses the following icons to show the settings:

**Table 69** Cache LUN icons (XP128/XP1024)

Icon	Description
	Indicates an LDEV for which Cache LUN is not set.

**Table 69** Cache LUN icons (XP128/XP1024) (continued)

Icon	Description
	Indicates an LDEV for which Cache LUN is set.
	Indicates a LUSE volume (two or more LDEVs) for which Cache LUN is not set.

The LDEV tree does not show Auto LUN-reserved volumes because they cannot be used in Cache LUN operations.

### LDEV table

Information about the LDEV selected in the tree appears on a single line in the upper-right portion of the pane. It includes LDEV number, emulation type, capacity, and RAID level.

The LDEV's capacity is shown in MB for open systems, or cylinders and tracks for mainframe systems. The table shows the cache settings for the LDEV selected in the tree and contains the following columns:

- **LBA** (open systems only): Displays the logical block starting and ending addresses.
- **CC HH** (mainframe systems only): Displays the cylinder and head starting and ending addresses.
- **Capacity**: Displays the capacity of the cache extent in megabytes for open systems. Displays the capacity of the cache extent in cylinders and tracks for mainframe systems.
- **Mode**: Displays the mode of the cache extent. "PRIO" indicates priority mode, "BIND" indicates bind mode, and "-" indicates that the LDEV is not assigned to the cache.
- **Prestage**: If this is blank, then pre-staging is not set. "ON" indicates that pre-staging is set.

### Cache LUN pie chart

The text above the pie chart lists the used cache and the amount of free space left in cache. For the XP12000, it also lists the total cache LUN area and size that can be created in the SLPR (storage logical partition).

In the pie chart, pink indicates the amount of cache available, blue shows cache use, and yellow shows the size of the specified cache extent.

### Cache settings section

Sets the mode and area for data that will reside in the Cache LUN cache. Also displays the settings for an existing cache extent. This area contains the following:

- **Cache LUN Type** (referred to as **Cache LUN Mode for XP12000**): Select the Cache LUN mode by clicking either **Bind** or **Prio**.
- **Prestaging Mode**: Select the **Prestaging** check box (located above the LDEV tree) to perform the pre-staging operation, and then click **Apply**. Click **Yes** if pre-staging is enabled. Click **No** if pre-staging is disabled.
- **From**: The starting address for data that will reside in the cache. This is expressed as a logical block address for open systems and as a cylinder and head address for mainframe systems.
- **To**: The ending address for data that will reside in the cache. This is expressed as a logical block address for open systems and as a cylinder and head address for mainframe systems.
- **Select All Area check box**: If you select this check box, all data areas in the selected LDEV will be set to Cache LUN cache.

This check box can be selected if no data areas in the selected LDEV are set to Cache LUN cache. This check box cannot be selected and is grayed out if some data areas in the selected LDEV are set to

Cache LUN cache. If you select the **Select All Area** check box, nothing will be set to the starting address and the ending address, and the **From** and **To** fields remain empty.

- **Possible Cache LUN Size** (Referred to as **Available Cache LUN Size for the XP12000**): Displays the size you can set. “Bind” displays the size you should set for bind mode and “Prio” displays the size you should set for priority mode.
- **Multi Set / Release check box**: Selecting this check box and then clicking **Set** displays the Multi Set pane, which you can use to make Cache LUN settings on more than one LDEV. Selecting this check box and then clicking **Release** displays the Multi Release pane, which you can use to cancel Cache LUN settings on more than one LDEV.

Data that will reside in the Cache LUN cache is specified by the starting address in the **From** field and the ending address in the **To** field. When the **SELECT ALL AREA** check box is selected, all data areas of the selected LDEVs will be set for the Cache LUN.

If you cancel the settings, all the settings specified for the LDEV will be canceled.

The **Multi Set / Release** check box does not select and cancel an individual Cache LUN data area specified for the LDEV. You must use the **Release** button to cancel an individual Cache LUN data area.

## Buttons

- **Set**: Creates a cache extent.
- **Release**: Deletes a cache extent.
- **Apply**: Applies the parameters to the disk array. You can then set or release other cache extents.
- **Cancel**: Cancels the operation.

---

# Setting (Creating) a Cache Extent

## To place data in cache

1. In the LDEV tree of the Cache LUN pane, click the CU:LDEV number of the LDEV you want to put in cache.  
The LDEV table displays Cache LUN information for the LDEV you selected.
2. Select an area to be made resident in the Cache LUN cache from one of those marked “-” in the Mode column. The **Set** button is enabled. The **From** and **To** boxes display the selected area’s values.
3. Click **Bind** or **Prio** to indicate the mode.
4. Click **Yes** or **No** to indicate whether to set pre-staging.
5. Complete one of the following steps:
  - To place all data on an LDEV into cache, go to [step 6](#).
  - To place specific data from an LDEV into cache, go to [step 7](#).
  - To place all data on multiple LDEVs into cache, go to [step 8](#).
  - To place specific data from multiple LDEVs into cache, go to [step 9](#).
6. To place all data on an LDEV into cache:
  - a. Select the **Select All Area** check box.
  - b. Clear the **Multi Set / Release** check box.
  - c. Click **Set**. A confirmation dialog box appears.

- d. Click **OK** to continue. The new settings are shown in blue on the Cache LUN pane. To cancel operations, click **Cancel**. Go to [step 10](#).

Cache LUN configuration interface showing LDEV 01:49 (OPEN-V, 0.04 GB, RAID5(3D+1P)) with a table of LBA, Capacity, Mode, and Prestage. The interface includes a tree view of Cache Units (CU 01) and Logical Device Elements (LDEV 01:40 to 01:4F), a 3D pie chart, and configuration options for Cache LUN Type, Prestaging Mode, From/To LBA ranges, and Possible Cache LUN Size.

7. To place specific data from an LDEV into cache:

- a. If the **Select All Area** check box is dimmed, go to the next step. If the **Select All Area** check box is activated, clear the **Select All Area** check box.
- b. Enter the starting and ending addresses (LBAs or CC HHs) of the area to be made resident in the cache.

For open systems, Cache LUN identifies a logical area in units of 128 blocks for OPEN-V, and 96 blocks for other than OPEN-V. For OPEN-V, if you have entered 1 as the starting logical block address and a value less than 128 as the ending logical block address, Cache LUN automatically changes the ending block address to 128. For other than OPEN-V, if you have entered 1 as the starting logical block address and a value less than 96 as the ending logical block address, Cache LUN automatically changes the ending block address to 96.

- c. Clear the **Multi Set / Release** check box.
- d. Click **Set**. A confirmation dialog box appears.
- e. Click **OK** to continue. The new settings are shown in blue on the Cache LUN pane. To cancel operations, click **Cancel**. Go to [step 10](#).

8. To place all data on multiple LDEVs into cache:

- a. Select the **Select All Area** check box.
- b. Select the **Multi Set / Release** check box.
- c. Click **Set**. A confirmation dialog box appears.

- d. Click **OK** to continue. The Multi Set pane appears.

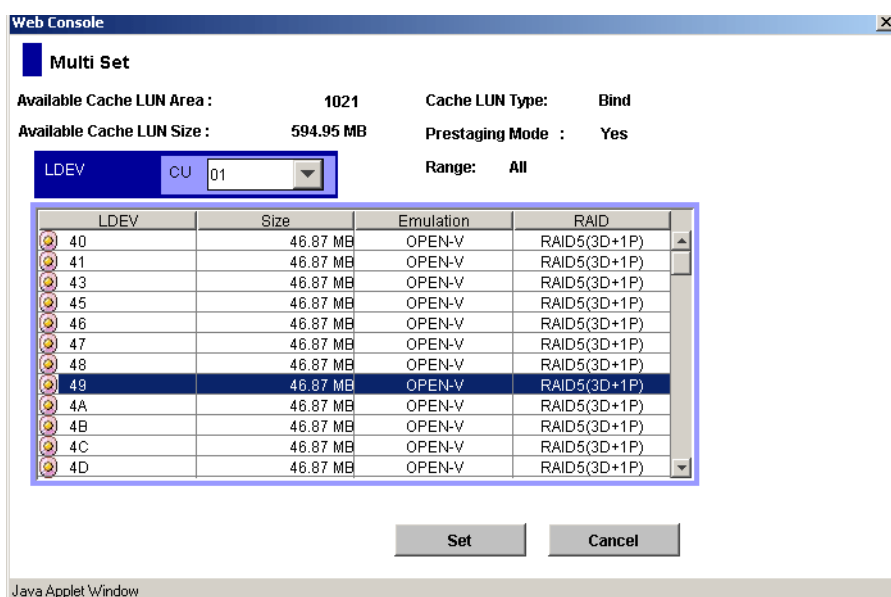

- e. In the **CU** drop-down list, click the CU.
  - f. In the table, click more than one LDEV and then click **Set**. The Multi Set pane closes and the new settings are shown in blue on the Cache LUN pane. To cancel operations, click **Cancel**. Go to [step 10](#).
9. To place specific data from multiple LDEVs into cache:
- a. If the **Select All Area** check box is grayed out, go to the next step. If the **Select All Area** check box is activated, clear the **Select All Area** check box.
  - b. Enter the starting and ending addresses (LBAs or CC HHs) of the area to be made resident in the cache.  
  
For open systems, Cache LUN identifies a logical area in units of 128 blocks for OPEN-V, and 96 blocks for other than OPEN-V. For OPEN-V, if you have entered 1 as the starting logical block address and a value less than 128 as the ending logical block address, Cache LUN automatically changes the ending block address to 128. For other than OPEN-V, if you have entered 1 as the starting logical block address and a value less than 96 as the ending logical block address, Cache LUN automatically changes the ending block address to 96.
  - c. Select the **Multi Set / Release** check box.
  - d. Click **Set**. A confirmation dialog box appears.
  - e. Click **OK** to continue. The Multi Set pane appears.
  - f. In the **CU** drop-down list, click the CU.
  - g. In the table, click more than one LDEV and then click **Set**. The Multi Set pane closes and the new settings are shown in blue on the Cache LUN pane. To cancel operations, click **Cancel**. Go to [step 10](#).
10. To make data in other volumes reside in the Cache LUN cache, repeat the previous steps.



**NOTE:** You cannot use the **Release** button to delete the set data until you click **Apply** or **Cancel**.

11. To enable the pre-staging function, select the **Prestaging** check box. To disable the pre-staging function, clear the **Prestaging** check box.
12. If the settings are correct, click **Apply**. A confirmation dialog box appears.

13. Click **OK** to confirm. The Cache LUN operation begins. If prestaging was selected, the prestaging operation will occur next. When the operation has been completed, a confirmation dialog box appears.
14. Click **OK**.

## Releasing (Removing) a Cache Extent

### To remove data from cache

1. In the LDEV tree of the Cache LUN pane, click the CU:LDEV number of the LDEV you want to remove from cache. The LDEV table displays Cache LUN information about the LDEV you selected.
2. Select an extent to be removed from the Cache LUN cache. The **Release** button is enabled.
3. Complete one of the following steps:
  - To remove specific data from cache, go to [step 4](#).
  - To remove all data from cache, go to [step 5](#).
4. To remove specific data from cache:
  - a. Click **Release**. A confirmation dialog box appears.
  - b. Click **OK** to continue. The new settings are shown in blue on the Cache LUN pane. To cancel operations, click **Cancel**. Go to [step 6](#).
5. To remove all data from cache
  - a. Select the **Multi Set / Release** check box.
  - b. Click **Release**. A confirmation dialog box appears.
  - c. Click **OK** to continue. The Multi Release window appears.

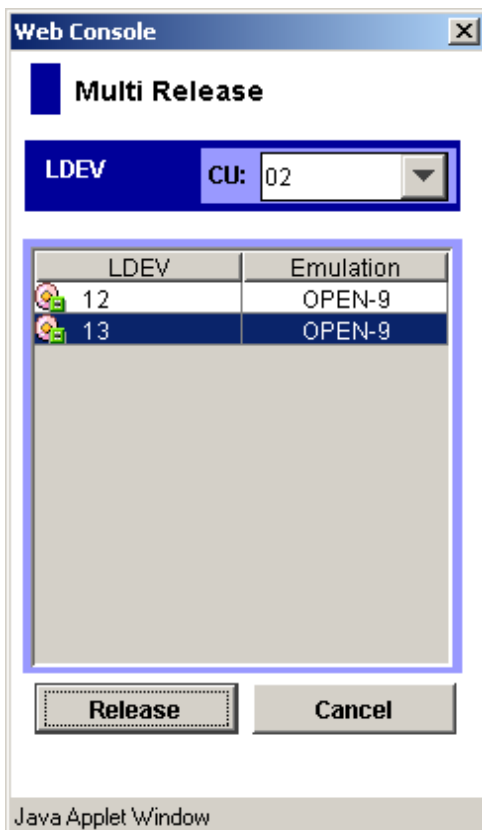

- d. In the **CU** box, click the CU.



- e. In the table, click more than one LDEV and then click **Release**. The Multi Release pane closes and the new settings are shown in blue on the Cache LUN pane. To cancel operations, click **Cancel**. Go to [step 6](#).
6. To remove cache data for another CU:LDEV, repeat the previous steps.
7. If the deletions are correct, click **Apply**. A confirmation dialog box appears.
8. Click **OK** to confirm. The Cache LUN operation begins. If prestaging was selected, the prestaging operation will occur next. When the operation has been completed, a confirmation dialog box appears.
9. Click **OK**.

## Changing an Extent's Mode and Pre-staging

You cannot directly change a cache extent's mode or pre-staging settings. You must delete the extent and reconfigure it with new settings.

1. Select and release (remove) the extent in the Cache LUN cache.
2. Remake the extent with the new mode and pre-staging settings.

---

# Partial Cache Residence (PCR) Operations

## Overview of the PCR Function

The XP128/XP1024/XP12000 has a special network board that allows the array to be connected directly to a LAN. This network connection interface is called Network Attached Storage (NAS).

The NAS disk array uses a cache to store two types of data:

- Management information (called *i-node*), including information on managing file system directories and file pointers
- Log information, used by the NAS channel file system to improve performance of data throughput in the LAN via the NAS channel

This cache function is called *Partial Cache Residence* (PCR). A PCR cache is assigned to each channel, and the PCR cache is shared and used by all files that are accessed through NAS channels. User data transferred through a NAS channel uses the ordinary cache area. [Figure 180](#) shows the PCR cache area (cache extent).

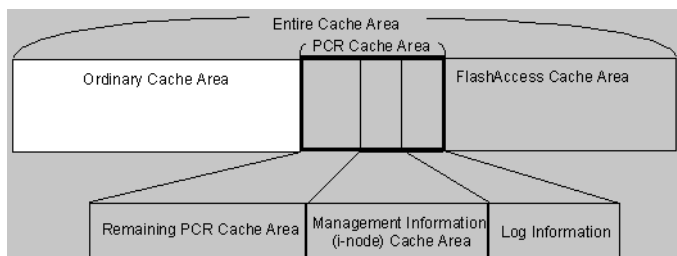

**Figure 180** PCR Cache Area (Cache Extent)

## PCR Operations

To perform PCR operations, you must belong to the Administrators or StorageAdmins group. If you belong to the Users group, you can only view PCR information.



**NOTE:** Only users belonging to the Administrators group are permitted to make modifications to arrays.

1. From the Device Launcher pane, click an XP128/XP1024/XP12000 link.
2. Click **Cache LUN** in the left pane. The Cache LUN pane appears.
3. Click the **PCR** tab. The PCR pane appears.

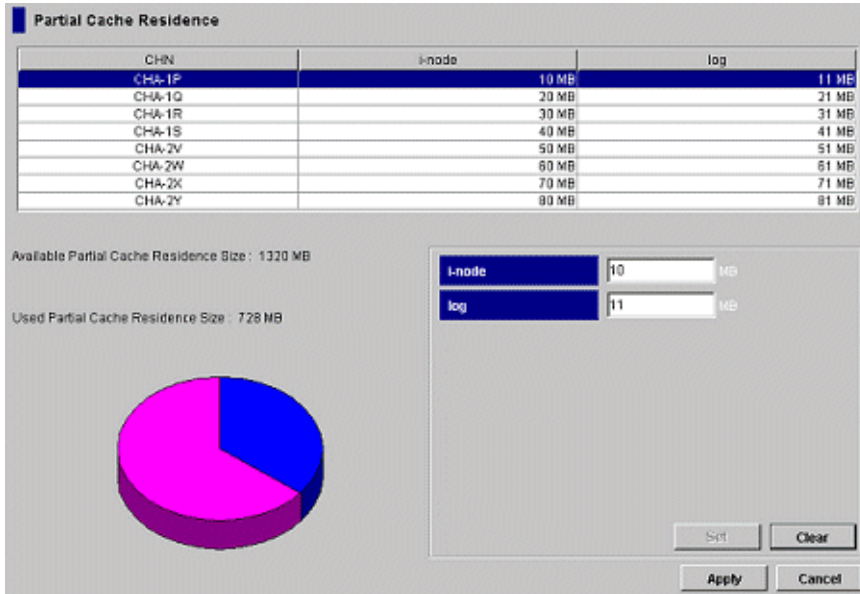

**Figure 181** PCR Pane

## PCR Pane

The PCR pane displays the table of NAS channels available for PCR operations, as well as a pie chart showing PCR cache usage. You can set the PCR cache size for management information (i-node) and log information used by the NAS channel file system.

This pane lists the following items:

- The PCR information table shows the PCR cache size for both management information (i-node) and log information files used to manage data on NAS channels.
  - The **CHN** column displays the name of the NAS channel.
  - The **i-node** column displays the cache size assigned to the area used by the NAS channel file system for two types of management: *current status management* (i-node) and *directory management*.
  - The **log** column displays the cache size assigned to the area used for obtaining log information on NAS channels.
- The PCR information area, located above the pie chart, displays two fields with PCR cache usage information:
  - **Available Partial Cache Residence Size:** the amount of the PCR cache available for use (pink area in the pie chart).
  - **Used Partial Cache Residence Size:** the amount of PCR cache currently in use (blue and/or yellow areas in the pie chart).

- The pie chart uses the following colors:
  - **Blue:** Shows PCR cache usage
  - **Yellow:** Shows the increase in the specified size of the PCR cache
  - **Pink:** Shows the remaining amount of available PCR cache
- The PCR operations box, located on the lower right corner of the PCR main panel, allows you to set the PCR cache size for both management information (i-node) and log information used by the NAS channel selected in the PCR information table. You can select several NAS channels at once.
  - Use the **i-node** field to enter the amount of cache assigned to the area used by the NAS channel file system for current status management (i-node) and directory management.
  - Use the **log** field to enter the amount of cache assigned to the area used for obtaining log information on NAS channels.
- Buttons:
  - **Set:** Adds the requested PCR operation (set PCR cache) to the PCR information table.
  - **Clear:** Enters 0 (zero) into both the **i-node** and **log** fields.
  - **Apply:** Starts the requested operation(s) listed in the PCR information table.
  - **Cancel:** Cancels the requested operation(s) and resets the PCR information table.

## Viewing the current PCR settings

You can view the current PCR settings in the PCR pane.

- The PCR information table shows the current PCR cache size for management information (i-node) and for log information files that are used to manage data on NAS channels.
- The 3D pie chart shows current cache usage.

## Setting the PCR cache

To set PCR cache for management information (i-node) and log information

1. Connect to the desired disk array and log on with Administrator or PCR write access.
2. Open the PCR pane.

- Click the desired NAS channel in the PCR information table. You can select more than one channel at a time.

CHN	i-node	log
CHA-1P	10 MB	11 MB
CHA-1Q	20 MB	24 MB
CHA-1R	20 MB	31 MB
CHA-1S	40 MB	41 MB
CHA-2V	50 MB	51 MB
CHA-2W	60 MB	61 MB
CHA-2X	70 MB	71 MB
CHA-2Y	80 MB	81 MB

Available Partial Cache Residence Size: 1220 MB

Used Partial Cache Residence Size: 720 MB

i-node: 0 MB  
log: 0 MB

Buttons: Set, Clear, Apply, Cancel

- Enter desired values (the capacities of PCR cache) in the **i-node** and **log** fields.



**NOTE:** If you want to enter 0 (zero) in both boxes, click the **Clear** button.

- Click **Set**.

A confirmation message appears.

- Click **OK** to continue your operations.

The requested PCR operation appears in blue bold italics in the PCR information table.

CHN	i-node	log
CHA-1P	10 MB	11 MB
CHA-1Q	20 MB	24 MB
CHA-1R	20 MB	31 MB
CHA-1S	40 MB	41 MB
CHA-2V	50 MB	51 MB
CHA-2W	60 MB	61 MB
CHA-2X	70 MB	71 MB
CHA-2Y	80 MB	81 MB

Available Partial Cache Residence Size: 1220 MB

Used Partial Cache Residence Size: 826 MB

i-node: 11 MB  
log: 11 MB

Buttons: Set, Clear, Apply, Cancel

- Repeat [step 3](#) - [step 6](#) until all desired operations are listed.

- Review the requested operation(s) in the PCR pane.

- To start the operation(s), click **Apply** in the PCR pane. The Apply confirmation message appears.
- Click **OK**. The Complete confirmation message appears.
- To cancel the operation(s), click **Cancel** in the PCR pane, and then click **OK** in the Cancel confirmation message.

9. To confirm the operations, click **OK** in the Complete confirmation message. The PCR pane appears.

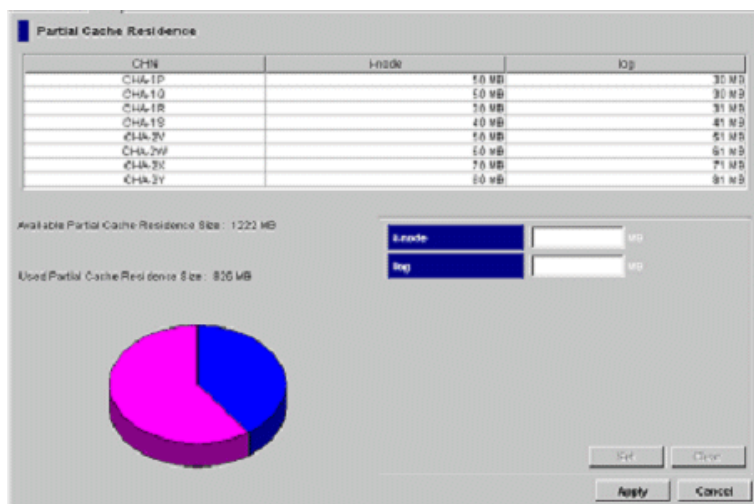

10. Monitor the PCR pane to make sure the operation(s) was successful.



---

# 22 Auto LUN for the XP128/XP1024/XP12000

Auto LUN monitors resources in disk arrays and hosts connected to disk arrays. Auto LUN works with open system and mainframe volumes. You can analyze the information Auto LUN provides to optimize data storage and retrieval on disk arrays, resolve activity bottlenecks, and optimize volume allocation.

---

## Auto LUN features

Auto LUN provides the following features:

- When a migration plan (set of detailed user-specified parameters) is in place, Auto LUN automatically migrates logical volumes in disk arrays.
- Auto LUN operations are completely non-disruptive. Data being migrated remains online to all hosts for read and write I/O operations throughout the volume migration process.
- Auto LUN supports manual volume migration operations and estimates performance improvements prior to migration.

Auto LUN begins by obtaining usage statistics about physical hard disk drives, logical volumes, processors, and other resources in disk arrays. Then, using manual or automatic migration, Auto LUN balances the workload among hard disk drives, logical volumes, and processors to improve system performance.

Use HP Performance Control XP to ensure that I/O operations requiring high performance receive higher priority than I/O operations from other, lower-priority hosts. You can set the priority of disk arrays, monitor I/O and transfer rates, and limit performance of less-critical arrays when necessary to maintain performance of high-priority arrays.



**NOTE:** Partition-level users in the StorageAdmins group cannot use Auto LUN, but users with full array access can use Auto LUN.

For users in the StorageAdmins group, the functions you can use are limited. For more information about these limitations, see "[Security system](#)" on page 57.

---

## Auto LUN statistics

Disk arrays automatically collect statistics twice a day (in the morning and afternoon). Auto LUN monitors disk arrays and obtains usage statistics about resources such as front-end and back-end processors, hard disk drives, and logical volumes every 15 minutes.

Auto LUN displays statistics collected for the last three months. Statistics over three months old are discarded.

You can specify a time period and view a graph illustrating how usage rates change within that time period. You can also view average and maximum usage rates.

You can analyze information displayed on the pane and identify overloaded resources. If necessary, take load-balancing measures to improve system performance.

Auto LUN displays the following types of information:

- **Usage statistics about parity groups.** If data shows overall high parity group usage, consider installing additional HDDs and using Auto LUN to migrate high-usage volumes to the new parity groups. If monitor data shows unbalanced parity group usage, use Auto LUN to migrate volumes from high-usage parity groups to low-usage parity groups.
- **Usage statistics about logical volumes.** Auto LUN displays average and maximum usage, including sequential and random access, for each LDEV in a parity group. Logical volume usage is the time in use (sequential and random access) of the physical drives of each LDEV, averaged by number of physical drives in the parity group.

If data shows overall high logical volume usage, consider installing additional hardware (for example, HDDs, DKAs, or cache). If monitor data shows unbalanced volume usage, use Auto LUN to migrate high-usage volumes to higher HDD classes and/or lower-usage parity groups. You can also use logical volume usage data to analyze access characteristics of volumes and determine appropriate RAID level and/or HDD type for the volumes.

- **Usage statistics about channel adapters and channel processors.** Channel adapters (CHAs) process host commands and control data transfer between hosts and cache. A channel adapter contains multiple channel processors (CHPs), which process host commands and control data transfer.

If data shows overall high CHA usage, consider installing additional CHAs. If data shows unbalanced CHP usage, consider moving some devices defined on overloaded ports to ports with lower-usage CHPs to balance front-end usage.

- **Usage statistics about disk adapters and disk processors.** Disk adapters (DKAs) control data transfer between cache and disk devices. A disk adapter contains multiple disk processors (DKPs), which control data transfer.

If data shows overall high DKP usage, consider installing additional HDDs and/or DKAs and using Auto LUN to migrate high-write-usage volumes (especially sequential writes) to the new parity groups. If data shows unbalanced DKP usage, use Auto LUN to migrate logical volumes from high-usage parity groups to low-usage parity groups.

Auto LUN cannot estimate DKP usage. Use Auto LUN migration only for obvious cases of high or unbalanced DKP usage. Auto LUN migration might not improve performance if DKP usage values vary only slightly or if overall DRR usage values are relatively high.

- **Usage statistics about data recovery and reconstruction processors.** Data recovery and reconstruction processors (DRRs) are microprocessors located on DKAs that generate parity data for RAID-5 parity groups. DRRs use “old data + new data + old parity” to generate new parity.

If data shows overall high DRR usage, this might indicate a high write penalty. Consult your HP representative about high write penalty conditions. If data shows unbalanced DRR usage, consider using Auto LUN to relocate volumes to balance DRR usage within the disk array.

- **Write pending rate.** The write pending rate indicates the ratio of write-pending data to cache memory capacity. The Auto LUN pane displays average and maximum write pending rates for the specified time period. The pane also displays a graph indicating how the write pending rate changed within that period.
- **Usage statistics about access paths.** An access path is a path through which data and commands are transferred within a disk array.

In a disk array, channel adapters control data transfer between hosts and cache memory. Disk adapters control data transfer between cache memory and disk drives. Data transfer does not occur between channel adapters and disk adapters. Data is transferred via the cache switch (CSW) to cache memory.



When hosts issue commands, they are transferred via channel adapters to shared memory (SM). Disk adapters check the contents of shared memory.

Auto LUN monitors and displays usage rates for the following access paths:

- Between channel adapters and the cache switch
- Between disk adapters and the cache switch
- Between the cache switch and cache memory
- Between channel adapters and shared memory
- Between disk adapters and shared memory
- **Statistics about logical devices.** You can check whether I/O operations converge on particular logical volumes or how much data is read from logical volumes into cache memory.

Auto LUN displays the following information:

- Number of read and write requests made to logical devices (or parity groups)
- Number of data transfers occurring between logical devices (or parity groups) and cache memory
- Size of data transferred to logical devices (or parity groups)
- Read hit rate
- Write hit rate

For read I/Os, when requested data is already in cache, the operation is a read hit. For example, if ten read requests were made from hosts to devices during a time period, and the read data was already in cache memory for three of the ten requests, the read hit rate for that time period is 30 percent. Higher read hit rates imply higher processing speed because fewer data transfers are made between devices and cache memory.

For write I/Os, when requested data is already in cache, the operation is a write hit. For example, if ten write requests were made from hosts to devices during a time period, and the write data was already in cache memory for three of the ten requests, the write hit rate for that time period is 30 percent. Higher write hit rates imply higher processing speed because fewer data transfers are made between devices and cache memory.

- **Statistics about port traffic.** Auto LUN monitors host ports and disk array ports to obtain statistics about I/O and transfer rates. If you analyze these rates, you can determine which host issues the most I/O requests and which host transfers the most data.
- **Statistics about LU path traffic.** Auto LUN monitors LU paths to obtain statistics about I/O and transfer rates. If you analyze these rates, you can determine which LU paths are used to make many of the I/O requests to disks and which LU paths are used to transfer much of the data to disks.

---

## Auto LUN tasks

- **Load balance disk array resources to improve performance.** Balancing resource usage can significantly improve disk array performance. Use Auto LUN data to optimize several areas of performance, including front-end and back-end processor usage and allocation of logical volumes to physical disk drives and RAID level.
- **Optimize disk drive access patterns.** Auto LUN collects and analyzes information about disk drive access patterns and can migrate volumes to optimize host access to data. For example, RAID-1 technology might provide better performance than RAID-5 under certain conditions, and one disk drive type might provide better performance than another for certain types of access. Auto LUN fine-tunes logical volume allocation.

- **Analyze disk array usage.** Auto LUN displays performance data graphically to highlight peaks and trends. Use the graph to identify activity bottlenecks.
- **Better utilize RAID levels and HDD types.** The XP128/XP1024/XP12000 supports both RAID-1 and RAID-5 technologies and a mixture of RAID-1 and RAID-5 parity groups. The XP128/XP1024/XP12000 also supports several types of hard disk drives (HDDs) and allows a mixture of HDD types within each disk array domain to provide maximum flexibility in configuration. Auto LUN takes into account RAID level and physical HDD performance of each parity group, enabling reallocation of logical volumes and optimization with respect to both RAID level and HDD type. The proper combination of RAID level and HDD type for logical volumes can significantly improve disk array performance.

---

## Reserve volumes

The reserve volume function reserves target volumes for automatic and manual migration operations. After you reserve a number of target volumes, Auto LUN maintains this number of reserved volumes by swapping the reserve attribute after each migration operation (following the migration operation, the original source volume becomes a reserved volume).

---

## Volume migration

Auto LUN volume migration operations consist of two steps:

- Copy the data on the Auto LUN source volume to the Auto LUN target volume
- Transfer host access to the target volume to complete the migration

The Auto LUN source volume can be online to hosts during migration. The target volume is reserved prior to migration to prevent host access during migration. The source and target volumes can be anywhere in the disk array.

The Auto LUN copy operation copies the entire contents of the source volume to the target volume. If write I/Os update the source volume during the copy operation, the XP128/XP1024/XP12000 uses a cylinder map to track updates and performs additional copy operations after the initial copy is complete to duplicate the updates at the target volume.

When volumes are fully synchronized (no differential data on source volume), the XP128/XP1024/XP12000 completes the migration by swapping the reserve attribute (target becomes normal and source becomes reserved) and redirecting host access to the target volume. Auto LUN performs all migration operations sequentially (one volume migration at a time).

Typical copy times for open system volumes (with no other I/O activity) are:

- OPEN-3: 1.5 minutes
- OPEN-8/9: 4.5 minutes
- OPEN-E: 9 minutes
- OPEN-V: variable

For automatic and manual migration operations, Auto LUN checks the current write pending rate. If the write pending rate is higher than 60%, Auto LUN cancels the migration. For auto migration, Auto LUN also checks current disk usage of source volumes and source and target parity groups. If current disk usage is higher than the user-specified maximum for auto migration, Auto LUN cancels the migration.

---

## Estimating usage rates

The estimate function calculates expected usage of source and target parity groups after a proposed volume migration. The estimate function uses subsystem usage data collected by the monitor function, HDD performance characteristics, and RAID level to estimate expected usage rates. The automatic and manual migration functions use these estimated values to verify proposed migrations.

For each proposed migration operation, Auto LUN automatically estimates expected usage rates for source and target parity groups. The estimate function calculates expected results of a proposed volume migration based on XP128/XP1024 monitor data collected during the user-specified monitor data term. The estimate function considers RAID level and HDD type when estimating expected usage rates (RAID-1 and RAID-5 have different access characteristics).

The estimate function is a critical component of the auto migration function. The estimate function calculates expected parity group usage for source and target parity groups, and the auto migration function uses these estimates to verify proposed migrations. If any condition prevents Auto LUN from estimating an expected usage rate (for example, invalid monitor data), the auto migration function will not schedule the migration operation.

For manual migration operations, when you select the source volume, Auto LUN displays expected usage rates for the source parity group, so you can see the predicted effect of migrating the selected volume out of its group. When you select the target volume, Auto LUN displays expected usage rates for the target parity group, so you can see the predicted effect of adding the selected source volume to the selected parity group.

Auto LUN does not estimate processor or access path usage. You can use Auto LUN migration operations to improve DKP and DRR usage, but cannot use them to address CHP or access path usage.

Perform Auto LUN migration only when you expect a large improvement in disk array performance. Auto LUN migration might not provide significant improvement if parity group or volume usage varies only slightly or if overall DKP or DRR usage is relatively high. Also keep in mind that disk array tuning operations might improve performance in one area while decreasing performance in another. For example, suppose parity groups A and B have average usage values of 20% and 90%, respectively. Auto LUN estimates that if one logical volume is migrated from parity group B to parity group A, the usage values will become 55% and 55%. If you perform this migration operation, I/O response time for parity group B will probably decrease and I/O response time for parity group A might increase, while the overall throughput might increase or decrease.

---

## Automatic migration

Auto migration is the primary tuning method for disk arrays. Auto migration analyzes data and executes migration plans automatically based on user-specified parameters. Use Auto LUN to schedule auto migration operations, select data to be analyzed, and specify maximum time and performance impact of auto migration operations. Auto LUN displays a detailed log of auto migration activities.

Auto migration operations are based on the following major parameters:

- **Hierarchy of parity groups.** Auto LUN arranges parity groups in the XP128/XP1024/XP12000 in a hierarchy based on HDD type, and assigns each parity group to a class based on performance of its HDD type. Classes are ordered from highest performance drive (class A) to lowest performance drive (class B, C, or higher depending on number of HDD types available). The auto migration function uses this hierarchy to identify target volumes for auto migration operations.

The auto migration function can also specify “fixed” parity groups that are excluded from auto migration operations.

- **Maximum disk usage.** The auto migration function specifies the maximum disk usage rate for each HDD class in the XP128/XP1024/XP12000, and uses these limits to identify source volumes for auto migration operations.

You must identify and specify disk usage limits for your environment. When you use the same maximum disk usage rate for all HDD classes, HDD performance is the only factor used in determining auto migration plans. When you specify different usage limits for HDD classes, you can bias the auto migration function to favor (or avoid) certain HDD types. Migrating high-usage volumes to higher HDD classes should significantly improve host access to volumes, which can also have a large effect on disk array performance.

The auto migration function also specifies the maximum disk usage rate during auto migration operations, so you can control the impact of Auto LUN copy operations on disk array performance. If source or target parity group usage exceeds the specified limit during migration, the auto migration operation is canceled.

Do not perform manual migration operations while the auto migration function is active. Always turn off the auto migration function and cancel any existing auto migration plan before performing manual migration operations.

## Storage management by maximum disk usage

Use the auto migration function to specify maximum usage rate for each HDD class in an XP128/XP1024/XP12000. When a parity group exceeds this limit, the auto migration function makes a plan to migrate one or more volumes in this parity group to a parity group in a higher HDD class or to a parity group in the same HDD class with lower usage.

This storage tuning method addresses and can eliminate disk drive activity bottlenecks. Auto LUN uses its estimated usage rates to verify each proposed auto migration, and will not perform a migration operation that might result in a target parity group exceeding the user-specified maximum disk usage rate.

The auto migration function identifies parity groups that exceed the user-specified usage limit, and selects high-usage volumes as source volumes to be migrated to parity groups in higher HDD classes or to other parity groups in the same HDD class with lower usage.

## Keep reserved volumes in high HDD classes

When parity groups in the highest HDD classes start to run out of reserved (empty) volumes, Auto LUN maintains available reserve volumes by automatically migrating low-usage volumes from higher HDD class groups to lower HDD class groups.

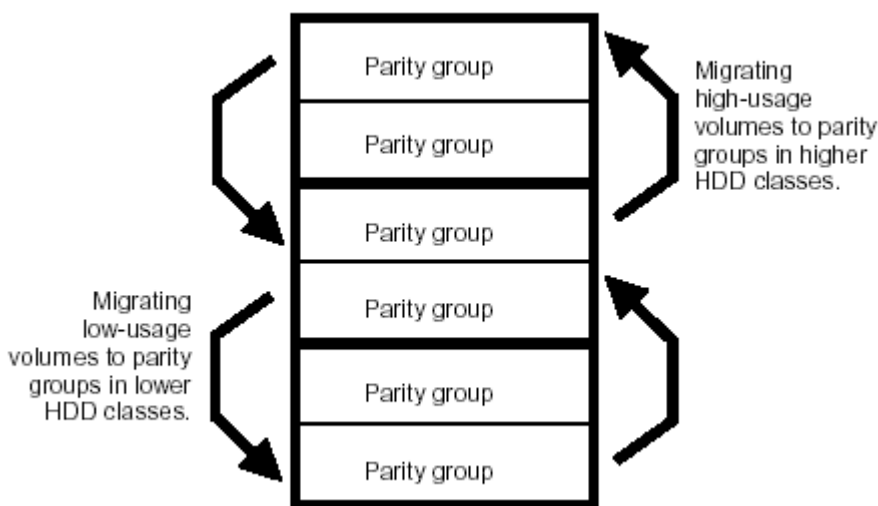

**Figure 182** Moving volumes to another class based on usage

The auto migration function can move a high-usage volume to a higher HDD class group, forcing a low-usage volume out of that HDD class group. To do so, the auto migration function requires a minimum of 5% difference in estimated disk usage between the two volumes. If the difference is less than 5%, this migration is considered ineffective and the volume is not moved.

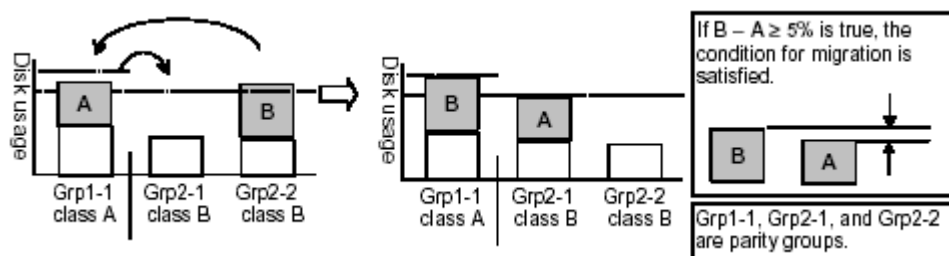

**Figure 183** Auto migration function example 1

The auto migration function can also move a volume from one parity group to another group of the same HDD class, forcing another volume out of the destination parity group. To do so, the auto migration function requires a minimum of 20% difference in estimated disk usage between the two volumes. If the difference is less than 20%, this migration is considered ineffective and the volume is not moved.

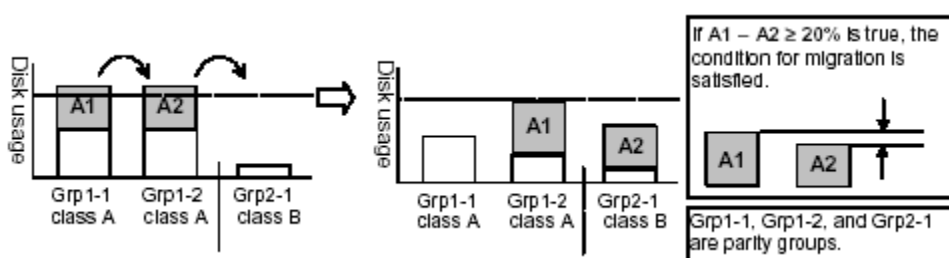

**Figure 184** Auto migration function example 2

## Auto migration sequence of events

The following are the typical steps to set up an auto migration plan:

1. Analyze monitor data. You specify the monitor data term to be analyzed.
2. Make auto migration plan. You specify the auto migration plan's parameters.
3. Perform auto migration plan. You specify when the auto migration plan is executed.
4. Analyze monitor data to confirm tuning results.

## Manual migration

Use manual migration to select and migrate logical volumes under direct, manual control. The manual migration function displays estimated results of proposed migration operations, which you can use to determine expected performance improvements prior to the actual migration.

While auto migration operations are based on disk usage and hierarchy of parity groups, you can use manual migration operations to address back-end processor usage (DKPs and DRRs) and volume and parity group usage. If monitoring shows high or unbalanced processor usage, use manual migration operations to tune the processor performance of the XP128/XP1024/XP12000.

---

# Performance Control

Use HP Performance Control XP to ensure that I/O operations for hosts requiring high performance receive higher priority than I/O operations for other hosts.

## Optimal performance of high-priority hosts

In a storage area network (SAN) environment, disk arrays are usually connected to several host servers. Some types of host servers might require high performance, while the performance of other hosts is less critical.

For example, *production servers*, such as database servers and application servers, perform daily business tasks requiring top performance. When performance of these servers drops, productivity in critical business activities decreases. Therefore, system administrators must maintain performance of production servers at optimal levels.

Computer systems in business organizations often include lower-priority servers, such as *development servers*. Development servers are used for developing, testing, and debugging business applications. If performance levels of development servers drops, developers are unhappy, but the productivity of critical business applications is not affected. Therefore, production servers are given higher priority than development servers.

Use Performance Control to limit I/O requests from development servers to disk arrays and limit the amount of data transferred between development servers and disk arrays. Production servers can expect faster response times and better performance.

Throughout this chapter, the term *upper limit control* refers to limiting performance of low-priority host servers to maintain performance of high-priority host servers.

## Automatically disable upper limit control

While upper limit control improves performance of production servers, it is not always useful. Upper limit control is not required when production servers are not busy. For example, if the number of production server I/O operations is very high from 9:00 a.m. to 3:00 p.m. and decreases sharply thereafter, upper limit control suppresses performance of development servers even after 3:00 p.m. Development servers should be free from upper limit control when production servers are not busy.

Performance Control provides a function called *threshold control* that automatically disables upper limit control when traffic between production servers and disk arrays decreases to a certain level. A *threshold* is a value indicating the conditions at which upper limit control is disabled. For example, if you apply a threshold of 500 IO/s (500 I/O operations per second) to the entire disk array, the I/O rate of development servers is not limited when the number of I/Os from all production servers is below 500 IO/s. If the number of production server I/Os increases beyond 500 IO/s, upper limit control is restored to limit the number of I/Os from development servers.

The threshold can control the I/O rate (number of I/Os per minute) or transfer rate (amount of data transferred per second). For example, if you set a threshold of 20 MB/s (20 megabytes per second) for a disk array, the I/O rate limit for development servers is disabled when the amount of data transferred between the disk array and all production servers is below 20 MB/s.

## Overview of Performance Control procedures

The procedure for using Performance Control depends on the type of connection established between host bus adapters (HBAs) and disk array ports. For one-to-one connections between HBAs and ports, use the **Port** tab of the Performance Control pane. For many-to-many connections between HBAs and ports, use the **WWN** tab of the Performance Control pane.

## Procedure for one-to-one connections between HBAs and ports

The following figure shows an example of a network where each host bus adapter is connected to only one port on the disk array. (Henceforth, this network is referred to as network A.) Host bus adapters and disk array ports are connected directly, rather than through hubs and switches.

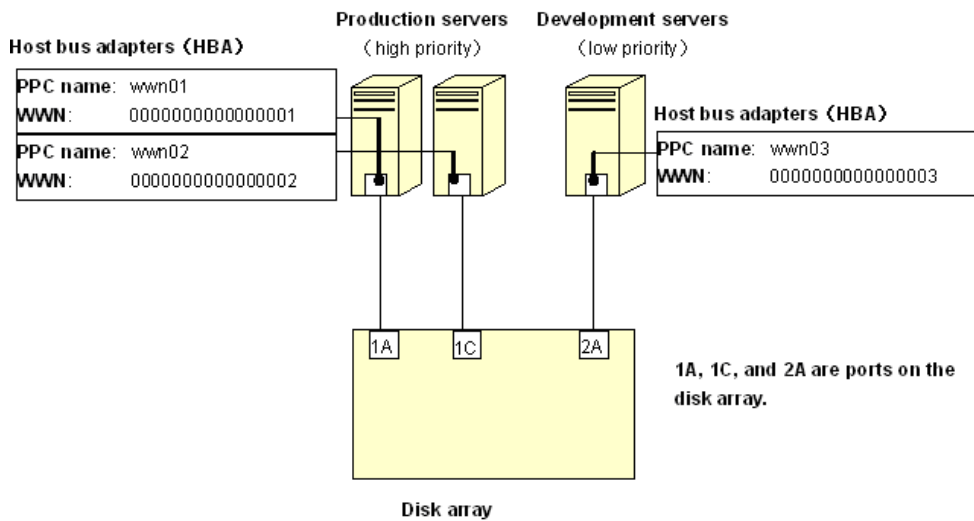

**Figure 185** Network A (one-to-one connections between HBAs and ports)

In this example, setting up Performance Control requires the following major steps:

1. **Set the priority of disk array ports.** Use the **Port** tab of the Performance Control pane to specify the priority of each port on the disk array.

In network A, ports 1A and 1C are connected to high-priority production servers. Port 2A is connected to a low-priority development server. Therefore, ports 1A and 1C should be given high priority, and port 2A should be given low priority.

[Figure 186](#) shows a portion of the Performance Control pane. **Prio.** indicates that the port is given high priority, and **Non-Prio.** indicates that the port is given low priority.



**NOTE:** Throughout this chapter, *prioritized port* refers to a high-priority port and *non-prioritized port* refers to a low-priority port.

Port	Ave.[IOPS]	Max.[IOPS]	Attribute
CL1-A(E2)	-	-	Prio.
CL1-C(DC)	-	-	Prio.
CL2-A(EF)	-	-	Non-Prio.

**Figure 186** Priority specified in the Performance Control pane

2. **Monitor traffic at ports.** Obtain statistics about traffic at each port on the disk array.

Auto LUN provides two types of traffic statistics: *I/O rate* (number of I/Os per second) and *transfer rate* (amount of data transferred between a host and disk array). When you view traffic statistics in the Performance Control pane, select the I/O or transfer rate. The **Port-LUN** tab of the Performance Monitor pane displays a line graph illustrating changes in traffic.

[Figure 187](#) shows changes in the I/O rate for the three ports (1A, 1C, and 2A). At first the I/O rate for ports 1A and 1C was approximately 400 IO/s and the I/O rate for port 2A was approximately 100 IO/s. However, the I/O rate for port 2A gradually increased and the I/O rate for ports 1A and 1C decreased, lowering the performance of the high-priority production servers. As network administrator,

you might want to maintain the I/O rate for prioritized ports 1A and 1C at 400 IO/s. To do this, set an upper limit to the I/O rate for port 2A.

For detailed information about monitoring traffic, see [“Measuring traffic between host bus adapters and ports for one-to-one connections”](#) on page 404 and [“Measuring traffic between host bus adapters and ports for many-to-many connections”](#) on page 404.

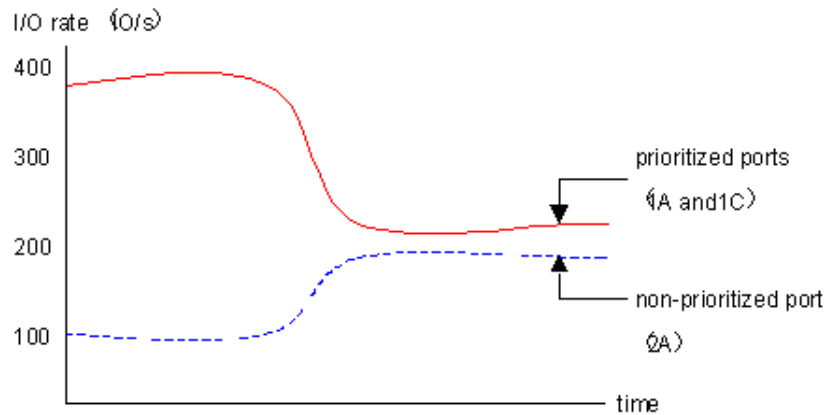

**Figure 187** Traffic at ports on network A

- 3. Set an upper limit to traffic at non-prioritized ports.** To maintain I/O rates at prioritized ports, set upper limit values to the I/O rate for non-prioritized ports.

When you first set an upper limit, HP recommends an upper limit of approximately 90 percent of peak traffic. In network A, the peak I/O rate for the non-prioritized port (2A) is 200 IO/s, so the recommended upper limit is 180 IO/s.

For detailed information, see [“Setting upper limit values for traffic at non-prioritized ports or WWNs”](#) on page 406.

- 4. Check the result of applying upper limit values.** After applying upper limit values, measure traffic at ports by viewing traffic statistics for prioritized ports 1A and 1C to check whether the host performance has improved to a desirable level.

In network A, if the desirable I/O rate (400 IO/s for ports 1A and 1C) has not been achieved, change the upper limit for port 2A to a lower value and apply the new upper limit to the disk array. In network A, if the upper limit is set to 180 IO/s but the I/O rate for 1A and 1C is still below 400 IO/s, reduce the upper limit until the I/O rate reaches 400 IO/s.

- 5. If necessary, apply a threshold.** To use threshold control, set threshold values in the **Port** tab in the Performance Control pane. You can set threshold values in either of the following ways:

- Set one threshold for each prioritized port.

In network A, if you set a threshold of 200 IO/s for port 1A and 100 IO/s for port 1C, the upper limit on the non-prioritized port (2A) is disabled when either of the following conditions is met:

- I/O rate for port 1A is 200 IO/s or lower
- I/O rate for port 1C is 100 IO/s or lower
- Set only one threshold for the entire disk array.

In network A, if you set a threshold of 500 IO/s for the disk array, the upper limit on the non-prioritized port (2A) is disabled when the sum of the I/O rates for all prioritized ports (1A and 1C) falls below 500 IO/s.

For detailed information, see [“Setting thresholds”](#) on page 407.



## Procedure for many-to-many connections between HBAs and ports

Figure 188 shows an example of a network where a production server and development server are connected to the disk array. (Henceforth, this network is referred to as network B.) The host bus adapter (wwn01) in the production server is connected to four disk array ports (1A, 1C, 1A, and 2C). The host bus adapters (wwn02 and wwn03) in the development server are connected to the same four ports.

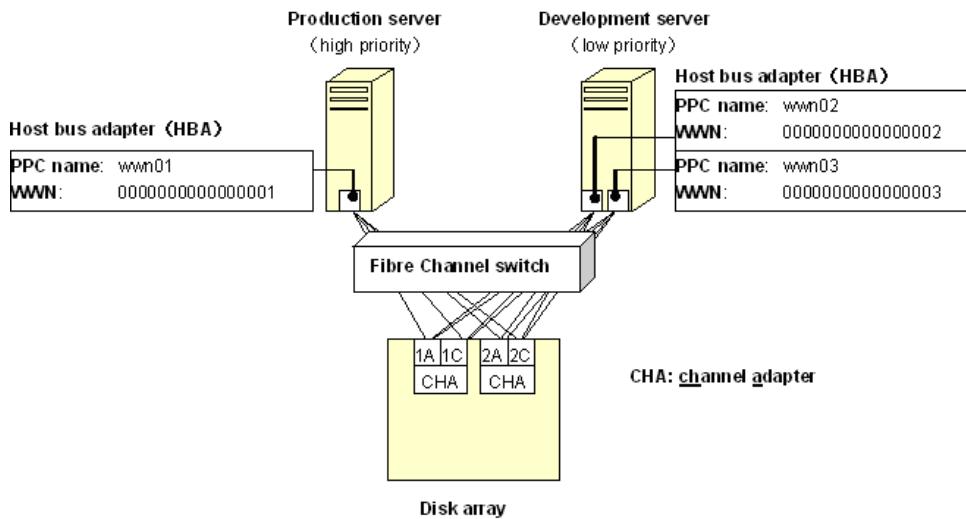
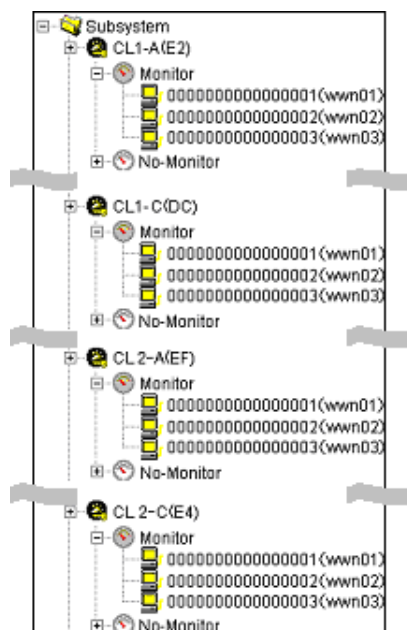

**Figure 188** Network B (many-to-many connections between HBAs and ports)

In this example, setting up Performance Control requires the following major steps:

- 1. Find WWNs of host bus adapters.** Before using Performance Control, find the Worldwide Name (WWN) of each host bus adapter in the host servers. WWNs are 16-digit hexadecimal numbers identifying host bus adapters. For detailed information about finding WWNs, see “LUN Management for the XP128/XP1024/XP12000” on page 179.
- 2. Define relationships between host bus adapters and ports:** In the **WWN** tab of the Performance Control pane, define which port is connected to which host bus adapter.

In network B, the four ports are connected to three host bus adapters (wwn01, wwn02, and wwn03). The resulting definitions are as follows:



**Figure 189** Specifying host bus adapters to be monitored

For detailed instructions, see “[Measuring traffic between host bus adapters and ports for many-to-many connections](#)” on page 404.



**NOTE:** When defining relationships, you must place the host bus adapters below the **Monitor** branch, as illustrated in [Figure 189](#). Performance Control cannot monitor and control host bus adapters below the **Non-Monitor** branch.

**3. Set the priority of host bus adapters.** In the **WWN** tab of the Performance Control pane, specify the priority of each host bus adapter.

In network B, the production server is given high priority and the development server is given low priority. If your network is configured as in [Figure 189](#), you must give high priority to wwn01 and low priority to wwn02 and wwn03.

To set the priority of host bus adapters, take the following steps (see the figure below):

- a. In the **WWN** tab, click one of the four ports to which the HBAs are connected (1A, 1C, 3A, or 3C).
- b. Set wwn01 to **Prio.**, and set wwn02 and wwn03 to **Non-Prio.**

WWN	Per Port[IOPS]		WWN Total[IOPS]		Attribute
	Ave.	Max.	Ave.	Max.	
0000000000000001	-	-	-	-	Prio.
0000000000000002	-	-	-	-	Non-Prio.
0000000000000003	-	-	-	-	Non-Prio.

**Figure 190** Priority specified in the Performance Control pane



**NOTE:** Throughout this chapter, *prioritized WWN* refers to a high-priority host bus adapter (such as wwn01) and *non-prioritized port* refers to a low-priority host bus adapter (such as wwn02 or wwn03).

**4. Monitor traffic between host bus adapter and ports.** Obtain statistics about traffic between host bus adapter and ports.

There are two types of traffic statistics: *I/O rate* (number of I/Os per second) and *transfer rate* (amount of data transferred between a host and disk array). When you view traffic statistics in the Performance Control pane, select I/O or transfer rate.

If your network is configured like network B, measure the traffic between the three host bus adapters (wwn01, wwn02, and wwn03) and the four ports (1A, 1C, 2A, and 2C).

[Figure 191](#) illustrates the I/O rate at the paths between port 1A and the host bus adapters. Initially the I/O rate on the path between 1A and the prioritized WWN (wwn01) was approximately 400 IO/s, while the I/O rate on the path between 1A and the non-prioritized WWNs (wwn02 and wwn03) was approximately 100 IO/s. However, the I/O rate for non-prioritized WWNs gradually increased, while the I/O rate of the prioritized WWN gradually decreased, causing performance of the high-priority production server to suffer. As network administrator, you might want to maintain the I/O rate for the prioritized WWN (wwn01) at 400 IO/s.

For detailed information, see “[Measuring traffic between host bus adapters and ports for many-to-many connections](#)” on page 404 and “[Analyzing traffic statistics](#)” on page 405.

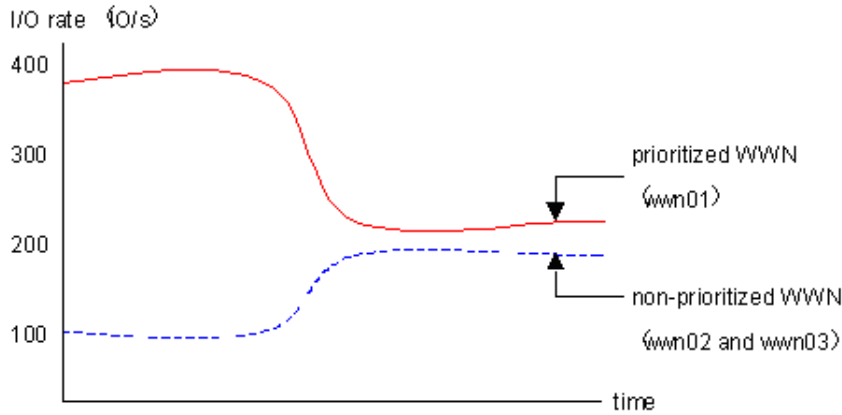

**Figure 191** Traffic at ports on network B

- 5. Set an upper limit to traffic between ports and the non-prioritized WWN.** To maintain sufficient I/O rates at prioritized WWNs, set upper limit values for the I/O rate for non-prioritized WWNs. When you first set an upper limit, HP recommends that the upper limit be approximately 90 percent of peak traffic.

In network B, the peak I/O rate is 200 IO/s on the paths between the non-prioritized WWNs (wwn02 and wwn03) and all four ports on the disk array (1A, 1C, 2A, and 2C). Therefore, the recommended upper limit for non-prioritized WWNs is 720 IO/s (200 x 4 x 0.90).

If your network is configured like network B, perform the following steps (see [Figure 192](#)):

- a. In the **WWN** tab, click one of the four ports to which the HBAs are connected (1A, 1C, 2A, or 2C).
- b. Set an upper limit for the non-prioritized WWNs (wwn02 and wwn03).

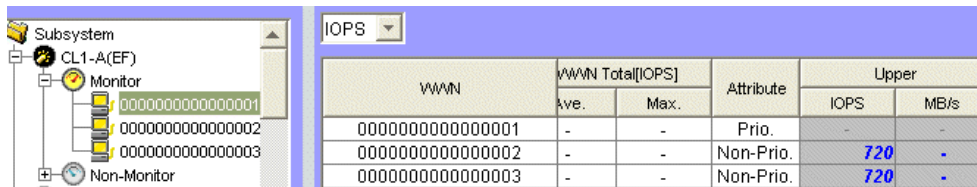

**Figure 192** Setting upper limits

[Figure 193](#) shows the result of setting an upper limit of 720 IO/s to the paths between 1A and the non-prioritized WWNs. For details, see “[Setting upper limit values for HBAs in a PFC group](#)” on page 409.

- 6. Check the result of applying upper limit values.** Measure traffic at ports and view traffic statistics for the prioritized WWN to check whether host performance improved to a desirable level.

In network B, the desirable I/O rate for the prioritized WWN is 400 IO/s. If production server performance has not achieved the desired level, lower the value of the upper limit and apply the new upper limit to the disk array. In network B, if the upper limit is set to 720 IO/s but the I/O rate for wwn01 remains below 400 IO/s, lower the upper limit until the I/O rate reaches 400 IO/s.

- 7. If necessary, apply a threshold.** Set a threshold in the **WWN** tab of the Performance Control pane.

In the **WWN** tab, specify only one threshold for the entire subsystem, regardless of the number of prioritized WWNs. For example, if there are three prioritized WWNs in the network and the threshold is 100 IO/s, the upper limit on non-prioritized WWNs is disabled when the sum of the I/O rates for all prioritized WWNs goes below 100 IO/s.

For details, see ["Setting thresholds"](#) on page 407.

## Notes on using Performance Control

- **User types.** Users belonging to the StorageAdmins group cannot use Performance Control. For more information about limitations, see ["Security system"](#) on page 57
- **I/O rates and transfer rates.** Performance Control measures I/O and transfer rates every second, and every minute calculates the average I/O rate and the average transfer rate for the previous minute.

Suppose the I/O rate at port 1-A changes as illustrated in [Figure 193 Graph 1](#). When you display the I/O rate graph for 1A in Performance Monitor, the line in the graph indicates changes in the average I/O rate calculated every minute (see [Graph 2](#)). If you click the **Detail** check box in the Performance Monitor pane, the graph displays changes in maximum, average, and minimum I/O rates in one minute.

Performance Control applies upper limits and thresholds to the average I/O or transfer rate calculated every minute. For example, if you set an upper limit of 150 IO/s to port 1A, the highest data point in.

the line CL1-A in Graph 2 and the line Ave.(1 min) in Graph 3 is around 150 IO/s. The lines Max (1 min.) and Min (1 min.) in Graph 3 might exceed the upper limit.

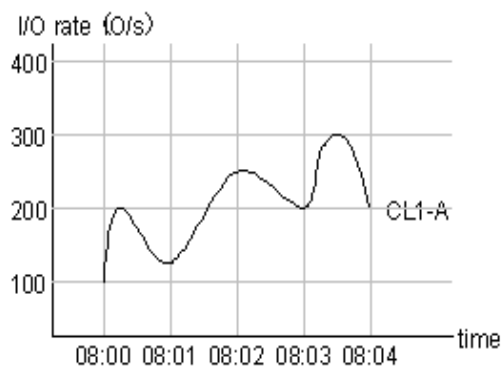

Period	Minimum	Average	Maximum
08:00 - 08:01	100	160	200
08:01 - 08:02	130	180	250
08:02 - 08:03	200	225	250
08:03 - 08:04	200	250	300

Graph 1: Actual I/O rate (measured every second)

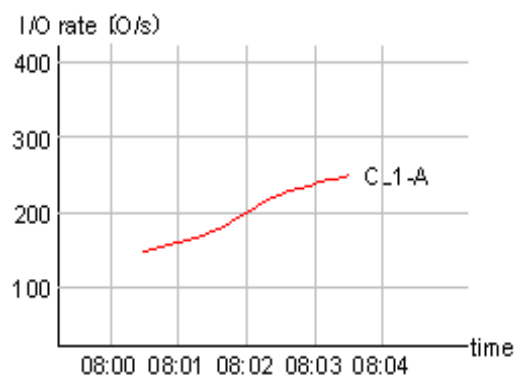

Graph 2: I/O rate displayed in Performance Control (with Detail option)

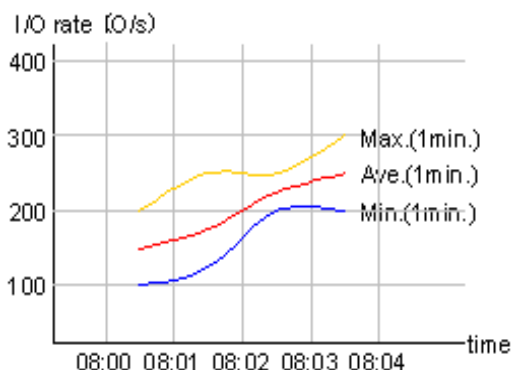

Graph 3: I/O rate displayed in Performance Control (without Detail option)

**Figure 193** Graphs indicating changes in port traffic

- **Continuous Access.** Performance Control monitors write I/O requests issued from initiator ports of the disk array.



**NOTE:** When using continuous access functions, Performance Control monitors write I/O requests issued from initiator ports to your disk array.

If you specify an RCU target port as a prioritized port, I/O requests from the initiator port will be a target of threshold control. If you specify an RCU target port as a non-prioritized port, I/O requests from the initiator port will **not** be a target of upper limit control.

# Requirements and restrictions

## Logical volumes

Source and target volumes must be in the same XP128/XP1024/XP12000 and have the same emulation type and capacity.



**NOTE:** For users in the StorageAdmins group, the function you can use are limited. For more information about these limitations, see “[Security system](#)” on page 57.

Whether you can or cannot perform volume migration with a pair consisting of customized volumes (CVs) and normal volumes depends on the volumes’ emulation type. For details, see [Table 70](#).

**Table 70** Movability of volumes in pairs consisting of CV and normal values

Source Volume	Target Volume			
	Normal Volume (not OPEN-V)	Normal Volume (OPEN-V)	CV (not OPEN-V)	CV (OPEN-V)
Normal Volume (not OPEN-V)	Movable	-	Not movable	-
Normal Volume (OPEN-V)	-	Movable	-	Movable
CV (not OPEN_V)	Not movable	-	Movable	-
CV (OPEN-V)	-	Movable	-	Movable

You cannot make pairs of the volumes.

## Source volumes

The following describes whether volumes can be used as source volumes:

- Volumes set as command devices (reserved for use by hosts) cannot be used as source volumes.
- Volumes in an abnormal or inaccessible condition (for example, fenced) cannot be used as source volumes.
- Volumes with Cache LUN data stored in cache cannot be used as source volumes.
- iSCSI volumes (volumes to which paths are defined from iSCSI ports) cannot be used as source volumes.
- Volumes that Continuous Access XP - Journal (CA Journaling) or CA Journaling for z/OS uses as a data or journal volume cannot be used as source volumes.
- Volumes reserved by a migration program other than Volume Migration cannot be used as source volumes.
- **Continuous Access.** If the status of a CA volume is PSUS, PSUE, or SMPL, the volume can be used as a source volume. If not, the volume cannot be used as a source volume. When a CA pair is deleted from the MCU, the status of both volumes changes to SMPL, and both volumes can be used as source

volumes. When a CA pair is deleted from the RCU, the status of the P-VOL changes to PSUS, the status of the S-VOL changes to SMPL, and both volumes can be used as source volumes.

- **Business Copy.** Using a BC volume as a source volume depends on the status and cascade configuration of the volume. If the status of a BC volume is not split-pending COPY(SP) or PSUS(SP), the volume can be used as a source volume. If the status is COPY(SP) or PSUS(SP), the volume cannot be used as a source volume. This applies to cascaded and non-cascaded volumes.

Table 71 shows which non-cascaded volumes can be used as source volumes.

**Table 71** Non-cascaded volumes that can be used as source volumes (XP128/XP1024/XP12000)

Pair Configuration	Use P-VOL as source volume	Use S-VOLs as source volumes
Ratio of P-VOL to S-VOLs is 1:1	Yes	Yes
Ratio of P-VOL to S-VOLs is 1:2	Yes	Yes
Ratio of P-VOL to S-VOLs is 1:3	No	Yes

Table 72 shows which cascaded volumes can be used as source volumes.

**Table 72** Cascaded volumes that can be used as source volumes (XP128/XP1024/XP12000)

Pair Configuration	Use P-VOL as source volume	Use S-VOLs as source volumes
L1 pair, ratio of P-VOL to S-VOLs is 1:1	Yes	Yes
L1 pair, ratio of P-VOL to S-VOLs is 1:2	Yes	Yes
L1 pair, ratio of P-VOL to S-VOLs is 1:3	No	Yes
L2 pair, ratio of P-VOL to S-VOLs is 1:1	Yes	No
L2 pair, ratio of P-VOL to S-VOLs is 1:2	No	No

If any of the following operations are performed on an Auto LUN source volume during migration, the Auto LUN volume migration process stops:

- CA operations that change the volume status to something other than PSUS, PSUE, or SMPL
- BC operations that change the volume status to COPY(SP) or PSUS(SP)
- CA Journaling operations

## LUSE source volumes

To specify a LUSE source volume for migration, specify individual LDEVs within the LUSE volume (for example, LDEVs with high usage). Auto LUN migrates only specified LDEVs. If needed, specify all LDEVs of the LUSE volume to relocate the entire LUSE volume. In this case, ensure that the required reserved target LDEVs are available.

## Target volumes

Target volumes must be reserved prior to migration. Hosts cannot access reserved volumes. The following volumes cannot be reserved:

- Logical Unit Size Expansion (LUSE) volumes

- Volumes set as command devices
- Volumes assigned to BC or CA pairs
- Volumes reserved for BC operations
- Volumes with Cache LUN data stored in cache
- iSCSI volumes (for example, volumes to which paths are defined from iSCSI ports)
- Volumes in abnormal or inaccessible conditions (for example, fenced)
- Volumes CA Journaling uses
- Volumes specified with the Read Only or Protect attribute
- Volumes that Volume Security disabled for use as secondary volumes
- Volumes that LUN Security XP Extension specified as Read Only or Protect or disabled for use as secondary volumes
- Volumes reserved by a migration program other than Volume Migration

## Number of volumes

In manual migrations, the number of migration plans that can be executed concurrently might be restricted, depending on use of other Command View XP programs and emulation types and sizes of migrated volumes. Therefore, the number of migration plans that can be executed concurrently is not constant.

A maximum of 36 Auto LUN copy operations can be requested at the same time. Auto LUN performs migration operations sequentially (one volume at a time).

The maximum number of Auto LUN copy operations plus BC pairs is 1024.

## Auto migration planning

Auto LUN will not plan an auto migration when:

- There is no reserve volume with the same emulation type and capacity as the source volume in the same or next higher/lower HDD class (auto migration is performed only between consecutive classes or within the same class)
- Auto LUN cannot estimate the usage rate for the target parity group because of some condition (for example, invalid monitor data)
- The estimated usage of the target parity group or volume is over the user-specified maximum disk usage value for that HDD class
- The estimated performance improvement is not large enough

## Auto migration execution

Auto LUN will not execute an auto migration operation when:

- The current usage (last 15 minutes) of the source or target parity group or volume is over the maximum disk usage rate for auto migration
- The current write pending rate for the disk array is 60% or higher

## Manual migration execution

Auto LUN will execute a manual migration operation when the current write pending rate for the disk array is 60% or higher.



## Maintenance

Do not perform Auto LUN migration operations during disk array maintenance activities (for example, cache or drive installation, replacement, or de-installation).

## Auto migration parameters

Auto migration parameters are initialized when the disk array configuration is changed (for example, when new drives or LDEVs are installed). Parameters include disk usage limit and migration time. After a change is made to the subsystem configuration, you must specify auto migration parameters again.

## Powering off disk arrays

To turn the power off at the disk array, ensure that volume migration is finished. If migration is not finished, HP strongly recommends that you do not turn off the power until the migration is finished.

If you turn the power off while migration is in progress, data migration stops and some of the data are not migrated. If you turn the power on later, Auto LUN resumes data migration. If data remains in shared memory, which is volatile memory, Auto LUN attempts to copy only data that have not been migrated to the migration destination. However, if data is lost from shared memory, Auto LUN attempts to copy all data to the migration destination; therefore, the copy operation takes more time. Auto LUN attempts to copy data that have not been migrated and data that have already been copied to the migration destination.

To power off the disk array, obtain the monitoring results first. If you do not, the **Physical** tab will not display some monitoring results. For example, if 4:00 a.m. and p.m. is specified in the **Gathering Time** option in the Auto LUN Monitoring Options pane and you turn off the power to the disk array at 5:00 p.m., the **Physical** tab will not display the monitoring results from 4:00 p.m. to 5:00 p.m.

## Performance Control restrictions

The following restrictions apply to the Performance Control panes:

- You cannot drag and drop objects. You must use the buttons.
- After clicking **Performance Control** to access Performance Control or clicking **Plan** to access AutoLUN Plan, a new browser opens. While working in the new browser, the main Command View window is inactive. You must exit secondary windows to return to the main Command View window.
- The **Close** button () on the Auto LUN and Performance Control panes remains active even if you click **Apply**, and processing is being executed. If you click **Close** after clicking **Apply**, the pane closes, but processing continues.
- For the first two operations only, the word "Processing" is displayed on the message dialog box of the Auto LUN and Performance Control panes. This message does not appear for the third and later operations.

## iSCSI support



**NOTE:** iSCSI is currently supported only for XP128/XP1024 disk arrays.

## Starting Auto LUN

1. Log in to Command View. For detailed information, see "[Starting Command View from a browser](#)" on page 42.

2. In the Device Launcher pane, click an XP128/XP1024/XP12000 link. The Identity pane appears. Ensure that you are in Modify mode. For details, see [Table 9](#) on page 98.
3. Depending on the selected disk array:
  - For an XP12000: Click **Auto LUN / Perf Control Base Monitor / PFC** in the left pane. The Auto LUN pane appears.

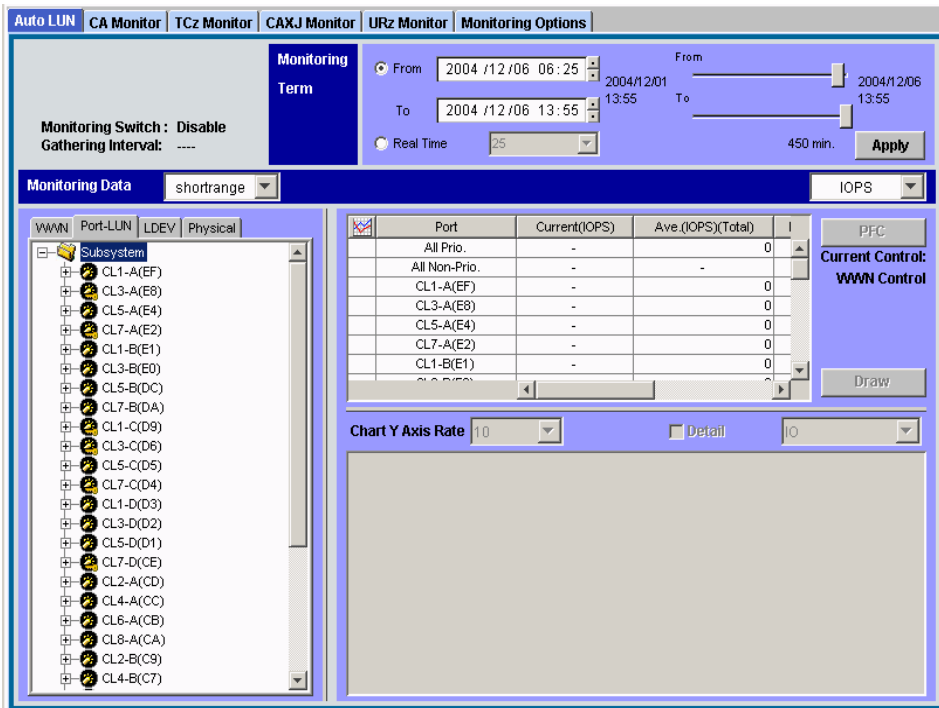

Figure 194 Auto LUN pane for an XP12000

- For an XP128/XP1024: Click **Auto LUN** in the left pane. The Auto LUN pane appears.

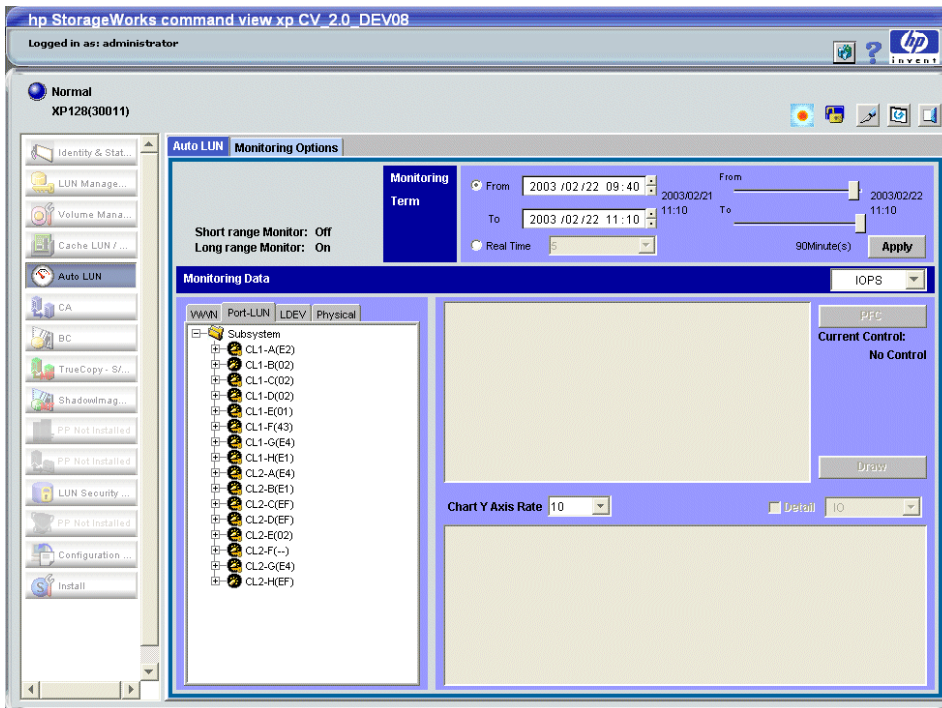

Figure 195 Auto LUN pane for an XP128/XP1024

4. Click **Monitoring Options**. The Monitoring Options pane appears.

## Auto LUN pane

The Auto LUN pane is the performance management pane. It displays usage rates for parity groups, logical volumes, channel processors, disk processors, and so forth. The pane has several sections.



**NOTE:** If a hyphen appears in monitoring data columns on the Auto LUN pane, statistics cannot be collected for that item.

---

## Tabs and selection trees

When you click one of the tabs (**WWN**, **Port-LUN**, **LDEV**, or **Physical**) in the lower-left portion of the pane, the pane displays different trees of items you can click.

The top left of the pane shows the status of the Short range Monitor and Long range Monitor. For information about these monitors, see "[Auto LUN Monitoring Options pane](#)" on page 370.

## Monitoring Term section

Use this section to specify the monitoring period. This setting affects all Auto LUN monitoring panes.

Use the **From** box and slide bar to specify the starting date for the monitoring period. Use the **To** box and slide bar to specify the ending date for the monitoring period.

Click **Real Time** to display workload statistics in real time. Use the list to specify the data range to be displayed in the graph. This check box appears dimmed when the **Physical** or **LDEV** tab is active. If the service processor is overloaded, extra time might be required for gathering monitoring results, and a portion of the results will not be displayed.

The **Apply** button applies the monitoring period settings to the disk array.

## Monitoring Data section

This section includes the following:

- A list on the left to specify the units in which usage are displayed (MB/s, IOPS, and so forth).
- The **UR Monitor** pane displays information about CA Journaling's continuous access operation. This information is also displayed in the **Usage Monitor** pane. For more information, see "[Continuous Access XP Journal](#)" on page 591.
- The **URz Monitor** pane displays information about the CA Journaling for z/OS's continuous access operation. This information is also displayed in the **Usage Monitor** pane. For more information, see "[Continuous Access XP Journal](#)" on page 591.



**NOTE:** If any continuous access function is not installed in your environment, the corresponding tab for that function is inactive and you cannot display that pane.

---



**NOTE:** The usage box on the left is available only for the XP12000 array.

---

- A list on the right to specify the type of monitoring required: long range or short range. Long range monitoring is available only when the **Physical** tab is active.

## Table section

This section displays the following:

- Statistics about traffic between host bus adapters (HBAs) in the hosts and ports on the disk array, if the **WWN** tab is active.
- Traffic statistics about WWNs and ports if the **Port-LUN** tab is active.
- Workload statistics about logical volumes if the **LDEV** tab is active.
- Statistics about parity group usage, processor usage, and so forth if the **Physical** tab is active.
- The **Plan** button is displayed when the **Physical** tab is active. Clicking this button displays Plan pane containing the **Manual Migration**, **Auto Migration**, **Attribute**, and **History** tabs.
- The **Draw** button draws a graph in the pane's graph section. The graph charts the statistics displayed in the table section.
- The **PFC** button is displayed when the **WWN** or **Port** tab is active. Clicking this button displays the Performance Control pane. For details, see ["Using Performance Control"](#) on page 399.
- The **Current Control** status is displayed when the **WWN** or **Port** tab is active. It displays the status of Performance Control:
  - **Port Control**: System performance is controlled by the upper limits and threshold specified in the **Port** tab of the Performance Control pane
  - **WWN Control**: System performance is controlled by the upper limits and threshold specified in the **WWN** tab of the Performance Control pane
  - **No Control**: System performance is not controlled by Performance Control

For further information, see ["Using Performance Control"](#) on page 399.

## Graph section

The graph shows statistics displayed in the table. The vertical axis shows usage values. The horizontal axis shows date or time.

Use the **Chart Y Axis Rate** list to select the highest value of the Y-axis (the vertical axis). This list is not displayed when the **Plan** button is active.

If you click the **Detail** check box, the graph displays detailed statistics. This check box is displayed when the **Port-LUN** or **LDEV** tab is active. The contents of the graph depend on the item selected in the list to the right of the table, as shown in the following table.

**Table 73** Graph contents based on list selection (Port-LUN tab)

Selection in list	Graph contents
I/O Rate (number of I/Os per second)	<ul style="list-style-type: none"><li>• Statistics in sequential access mode</li><li>• Statistics in random access mode</li><li>• Statistics in CFW (cache fast write) mode</li></ul> <p>If the read hit ratio or write hit ratio is high, random access mode is used for transferring data instead of sequential access mode. For example, random access mode might be used for transferring data to disk areas where Cache LUN XP is applied.</p>
Read (number of read accesses per second)*	
Write (number of write accesses per second)*	
Read Hit (read hit ratio)	
Write Hit (write hit ratio)	

**Table 73** Graph contents based on list selection (Port-LUN tab) (continued)

Selection in list	Graph contents
Back Transfer (backend transfer: number of I/Os between the cache memory and disk drives)	<ul style="list-style-type: none"> <li>• Number of data transfers from the cache memory to disk drives</li> <li>• Number of data transfers from disk drives to cache memory in sequential access mode</li> <li>• Number of data transfers from disk drives to cache memory in random access mode</li> </ul>
Trans. Rate (number of data transfers)	The graph does not display detailed information.

\* Available only when I/O rates are displayed.

## WWN, Port-LUN, LDEV, and Physical tabs

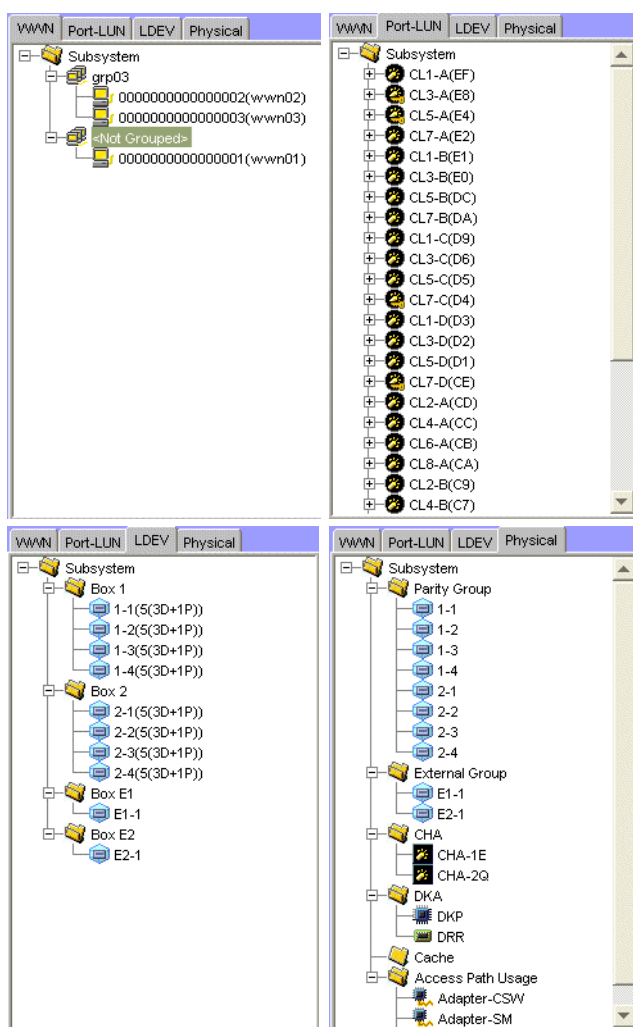



**Figure 196** WWN, Port-LUN, LDEV, and Physical tabs

Click one of the tabs (**WWN**, **Port-LUN**, **LDEV**, or **Physical**) in the lower-left portion of the pane to view data about ports, LDEVs, or physical components.

When you click a tab, the selection tree in the lower-left portion of the pane changes. You can then click entities to display information in the table and graph sections of the pane.

If I/O workloads between hosts and the disk array become heavy, the disk array gives higher priority to I/O processing than monitoring processing; therefore, some monitoring data might be missing. If monitoring data are frequently missing, use the **Gathering Interval** option in the **Monitoring Options** pane to increase the collection interval.

## WWN tab

This tab displays the **Subsystem** folder and PFC groups, which are groups of multiple WWNs. Double-clicking a PFC group (  ) displays host bus adapters (  ) in the PFC group. Double-clicking **Not Grouped** in the tree shows host bus adapters (WWNs) that do not belong to any PFC group.

To start monitoring traffic between host bus adapters and disk array ports, you must specify settings before starting monitoring.











**NOTE:** If a host bus adapter's WWN is displayed in red in the tree, the host bus adapter is connected to two or more ports, but Performance Control does not control traffic between the HBA and some ports. For information about controlling the traffic between the HBA and all connected ports, see "Performance Monitor and Performance Control" on page 411.

## Port-LUN tab

This tab displays ports. The tree view displays the following icons.

**Table 74** Auto LUN pane, Port-LUN tab icons (XP128/XP1024/XP12000)

Icon	Status
	Short-wave Fibre Channel port in standard mode with LUN security. Or iSCSI port with LUN security (XP128/XP1024 only).  If the port name is followed by its fibre address, the port is a Fibre Channel port. If the port name is followed by two hyphens, the port is an iSCSI port. For example, CL1-A(EF) indicates that the CL1-A port is a Fibre Channel port, and CL1-A(-) indicates that the CL1-A port is an iSCSI port.
	Short-wave Fibre Channel port in standard mode without LUN security. Or iSCSI port without LUN security (XP1024 only).
	Short-wave Fibre Channel port in high-speed or high-speed (2 port) mode with LUN security.
	Short-wave Fibre Channel port in high-speed or high-speed (2 port) mode without LUN security.
	Long-wave Fibre Channel port in standard mode with LUN security.
	Long-wave Fibre Channel port in standard mode without LUN security.
	Long-wave Fibre Channel port in high-speed or high-speed (2 port) mode with LUN security.
	Long-wave Fibre Channel port in high-speed or high-speed (2 port) mode without LUN security.



**NOTE:** High-speed (2 port) mode is available only if the XP disk array has firmware version 21.06.22 or later installed.

## LDEV tab

This tab displays parity groups. **Box** folders appear below the **Subsystem** folder. The number at the end of a Box folder name indicates the number at the beginning of the parity group ID. For example, if you double-click the **Box 1** folder, the tree view displays a list of parity groups that have IDs beginning with 1 (such as **1-1** and **1-2**).

If you double-click a parity group, the logical volumes in the parity group appear in the table. If a parity group ID starts with the letter E, the logical volumes in the parity group are external LUs.

The parity group icon () represents a single parity group or two or more connected parity groups. If two or more parity groups are connected, logical volumes can be striped across two or more drives. Therefore, connected parity groups provide faster access (particularly faster sequential access) to data.









If the parity group icon represents a single parity group 1-3, the text 1-3 is displayed on the right of the icon. If the parity group icon represents two or more connected parity groups, all connected parity groups are displayed to the right of the icon. For example, if parity group 1-3 is connected with parity group 1-4, the text 1-3[1-4] is displayed on the right of the parity group icon. All parity groups connected with 1-3 are enclosed by square brackets.

When the ShadowImage or SI390 quick restore operation is being performed, a Control View pane might display old information (status prior to the quick restore operation) on logical volume (LDEV) configurations. In this case, wait until the quick restore operation completes, and click Refresh () to update the Command View window.



## Physical tab

This tab displays parity groups, CHAs, DKAs, and other related items. The tree view displays the following icons.

**Table 75** Auto LUN pane, Physical tab icons (XP128/XP1024/XP12000)

Icon	Description
	Parity group.
	ESCON or FICON channel adapter.
	Short-wave Fibre Channel adapter in standard mode.
	Short-wave Fibre Channel adapter in high-speed or high-speed (2 port) mode.
	Long-wave Fibre Channel adapter in standard mode.
	Long-wave Fibre Channel adapter in high-speed or high-speed (2 port) mode.
	Channel adapter for use in a NAS environment
	Disk processor (DKP).

**Table 75** Auto LUN pane, Physical tab icons (XP128/XP1024/XP12000) (continued)

Icon	Description
	Data recovery and reconstruction processor (DRR).
	Access path.



**NOTE:** High-speed (2 port) mode is available only if the XP disk array has firmware version 21.06.22 or later installed.

In short range, if I/O workloads between hosts and the disk array become heavy, the disk array gives higher priority to I/O processing than monitoring processing; therefore, some monitoring data might be missing. If monitoring data is missing frequently, use the **Gathering Interval** option in the **Monitoring Options** pane to increase the collection interval.

## Auto LUN Monitoring Options pane

Use this pane to set the gathering time for monitoring.



**NOTE:** When statistics are collected, a heavy workload is likely to be placed on servers. This might slow down client processing.

The pane contents vary according to your disk array.



**NOTE:** Settings in the **Monitor Options** pane work with settings for Continuous Access XP and CA Journaling. Therefore, changes you make to one pane affect the settings in the other panes.

## XP12000 disk arrays



**NOTE:** To begin monitoring the disk array, Command View XP must be in **Modify** mode. A yellow background color signals **Modify** mode. A gray background color signifies **View** mode. You cannot change in the Monitoring Options pane in **View** mode.

To change settings, when the background color of the lock icon is blue, click the lock icon. If the background of the lock icon is red, wait a few minutes and try again.



XP12000 arrays display the following pane:

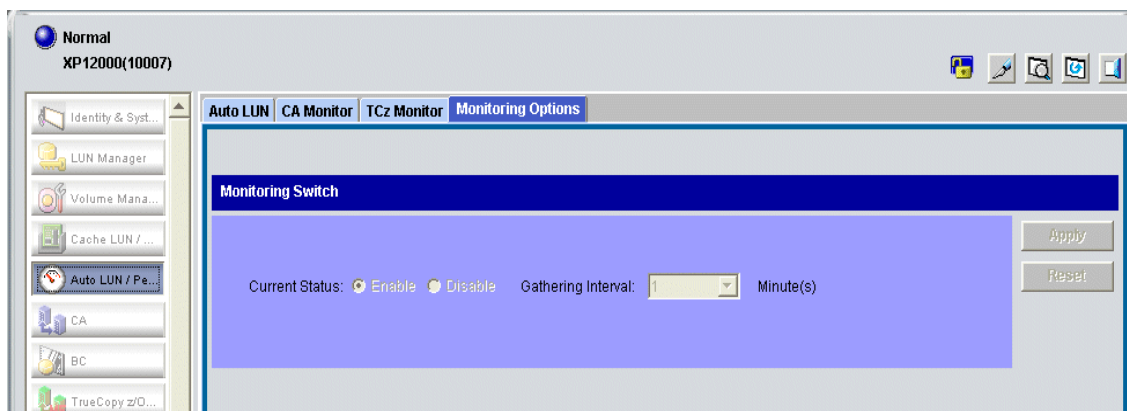

Figure 197 Auto LUN Monitoring Options pane (XP12000)

This pane contains the following items:

- **Current Status:** Specifies whether the disk array is monitored. Click **Enable** to start monitoring. Click **Disable** to stop monitoring. The default is **Disable**.
- **Gathering Interval (XP12000):** If **Current Status** is **Enable**, specifies the interval during which statistics are collected, in minutes. For example, if you enter 2, statistics are gathered every two minutes. The default is 1 minute.

## XP128/XP1024 disk arrays

XP128/XP1024 arrays display the following pane:

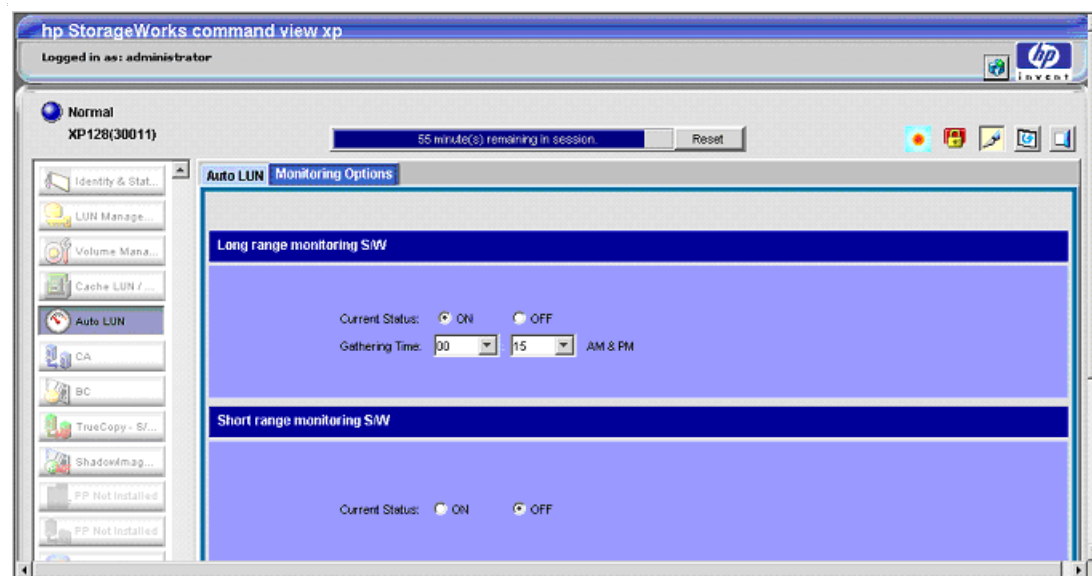

Figure 198 Auto LUN Monitoring Options pane (XP128/XP1024)

This pane contains the following items:

- **Long range monitoring S/W:** Monitors resources in the disk array to obtain usage statistics.



**NOTE:** When you select long range, you cannot view the ratio of Business Copy XP and ShadowImage for z/OS to all processing and usage statistics about cache memory.

- **Current Status:** Specifies whether the disk array is monitored. Click **ON** to start monitoring. Click **OFF** to stop monitoring. The default is **OFF**.
- **Gathering Time:** Specifies when statistics are collected. If **Current Status** is **ON**, statistics are collected at the time specified (once in the morning and once in the afternoon). The default is **0:00** (0:00 a.m. and 0:00 p.m.).
- **Short range monitoring S/W:** Monitors disks, ports, and LU paths to obtain workload statistics, and measures traffic between host bus adapters and ports.
  - **Current Status:** Specifies whether the disk array is monitored. Click **ON** to start monitoring. Click **OFF** to stop monitoring. The default is **OFF**.

If you click **ON**, the option setting automatically changes to **OFF** 24 hours later.

If the **Physical** tab is displayed and the monitoring term exceeds one day, data in the graph might be subject to a margin of error. To display the graph correctly, ensure that the monitoring term does not exceed one day. In the **Physical** tab, a maximum of 96 data points are plotted to form a single graph line. Data point values can differ depending on whether the monitoring term exceeds one day.

If the **LDEV** or **Port-LUN** tab is displayed and the monitoring term exceeds 90 minutes, data in the graph might be subject to a margin of error. To display the graph correctly, ensure that the monitoring term does not exceed 90 minutes. In the **LDEV** or **Port-LUN** tab, a maximum of 90 data points are plotted to form a single graph line. Data point values can differ depending on whether the monitoring term exceeds 90 minutes.

---

## Usage statistics

### Collecting usage statistics about disk array resources

To obtain usage statistics about a disk array's resources, complete the following instructions to start monitoring the disk array.

1. In the Auto LUN pane, click **Monitoring Options**. The Monitoring Options pane appears.
2. Do either of the following:
  - For XP128/XP1024 arrays: Under Long range monitoring S/W and/or Short range monitoring S/W, click **ON** for the **Current Status** option.
  - For XP12000 arrays: Click **Enable** for the **Current Status** option.
3. Do either of the following:
  - For XP128/XP1024 arrays: Use the two lists in **Gathering Time** to specify the time when the disk array collects statistics.
  - For XP12000 arrays: Use the **Gathering Interval** box to specify the interval during which the disk array collects statistics.
4. Click **Apply**. Auto LUN starts monitoring the disk array.

To stop monitoring the disk array, complete the following instructions. If you stop monitoring, Auto LUN stops collecting statistics.

1. In the Auto LUN pane, click **Monitoring Options**. The Monitoring Options pane appears.
2. Do either of the following:
  - For XP128/XP1024 arrays: Under Long range monitoring S/W, click **OFF** for the **Current Status** option.
  - For XP12000 arrays: Click **Disable** for the **Current Status** option.

3. Click **Apply**.

## Viewing parity group usage statistics

Auto LUN monitors parity groups, and displays average and maximum usage rates for the specified period. Auto LUN also displays a graph illustrating changes in parity group usage within that period.

1. In the Auto LUN pane, click **Physical**, and click the Parity Group folder. The table displays usage statistics about the parity group.

	PG	RAID	Drive Type	Usage(%)		CLPR
				Ave.(Total)	Max.	
	1-1	5(3D+1P)	DKR2E-J146FC	-	-	02:CLPR2
	1-2	5(3D+1P)	DKR2E-J146FC	0	0	00:CLPRO
	1-3	5(3D+1P)	DKR2E-J146FC	0	0	00:CLPRO
	1-4	5(3D+1P)	DKR2E-J146FC	0	0	00:CLPRO
	2-1	5(3D+1P)	DKR2E-J146FC	0	0	00:CLPRO
	2-2	5(3D+1P)	DKR2E-J146FC	0	0	00:CLPRO
	2-3	5(3D+1P)	DKR2E-J146FC	0	0	00:CLPRO

**Figure 199** Parity group usage statistics



**NOTE:** If an exclamation mark (!) appears before a usage rate, that parity group usage rate might be inaccurate because the configuration has changed (for example, volumes have been moved by a migration plan or changed by VSC).

2. To display a graph illustrating changes in usage rates, click the parity groups in the table, and click **Draw**.

The table displays the following items:

- **Graph column:** The “check mark” icon () indicates the graph is currently illustrating data for that item.
- **PG:** Parity group ID.
- **RAID:** RAID level (RAID-5 or RAID-1).
- **Drive Type:** Hard disk drive type.
- **Usage:** The Ave. (Total) column displays the average usage rate in the specified period. The Max. column displays the maximum usage rate in the specified period.
- **CLPR:** The number and name of the CLPR that corresponds to the parity group. For more information about CLPRs, see “Working with CLPRs” on page 152.

## Viewing logical volume usage statistics

1. In the Auto LUN pane, click **Physical**, and double-click the **Parity Group** folder. The folder opens. A list of parity groups appears below the folder.
2. Click the parity group. The table displays usage statistics about logical volumes in the specified parity group.



**NOTE:** To view the ratio of Business Copy XP and ShadowImage for z/OS processing to all processing in the physical drive, select **Short Range**.

<input checked="" type="checkbox"/>	LDEV	Emulation	Usage(%)		Read Rate(%)		Write Rate(%)		Parity Gr.Use[Exp](%)		CLPR
			Ave.(Total)	Max.	Rnd.	Seq.	Rnd.	Seq.	Ave.(Total)	Max.	
	00:63	OPEN-8	0	0	-	-	-	-	0 -> 0	0 -> 0	02:CLPR2
	00:68	OPEN-8	0	0	-	-	-	-	0 -> 0	0 -> 0	02:CLPR2
	00:6E	OPEN-8	0	0	-	-	-	-	0 -> 0	0 -> 0	02:CLPR2
	00:74	OPEN-8	0	0	-	-	-	-	0 -> 0	0 -> 0	02:CLPR2
	00:76	OPEN-8	0	0	-	-	-	-	0 -> 0	0 -> 0	02:CLPR2
	00:77	OPEN-8	0	0	-	-	-	-	0 -> 0	0 -> 0	02:CLPR2
	00:78	OPEN-8	0	0	-	-	-	-	0 -> 0	0 -> 0	02:CLPR2

**Figure 200** Logical volume usage statistics



**NOTE:** If an exclamation mark (!) appears before a usage rate, that parity group usage rate might be inaccurate because the configuration has changed (for example, volumes have been moved by a migration plan or changed by VSC).

- To display a graph illustrating changes in usage rates for parity groups, click the parity groups in the table, and click **Draw**.

The table displays the following items:

- **Graph column:** The “check mark” icon () indicates the graph is currently illustrating data for that item.
- **LDEV:** Logical volumes (LDEVs). The number on the left of the colon is the CU image number. The number on the right of the colon is the LDEV number.
- **Emulation:** Device emulation type.
- **Usage:** The Ave. column displays the average usage rate in the specified period. The Max. column displays the maximum usage rate in the specified period.
- **Read Rate:** The Rnd. column indicates the random read rate, which is the ratio of random read requests to read and write requests. The Seq. column indicates the sequential read rate, which is the ratio of sequential read requests to read and write requests.
- **Write Rate:** The Rnd. column indicates the random write rate, which is the ratio of random write requests to read and write requests. The Seq. column indicates the sequential write rate, which is the ratio of sequential write requests to read and write requests.
- **Parity Gr. Use[Exp](%):** Expected (estimated) average and maximum usage rates of the parity group, if the volume was migrated out of the group (or de-installed). The Ave. (Total) column indicates an estimated change in average usage rate. The Max. column indicates an estimated change in maximum usage rate. For example, if the Ave. (Total) box for volume 0:01 displays “20 -> 18,” average usage rate of the parity group to which the volume belongs is 20 percent. If the volume was migrated out of the parity group, average usage rate of that group is expected to drop to 18 percent.
- **Business Copy:** (Displayed only when you select **Short Range** as the storing period of statistics.) For each logical volume, the percentage of processing of the following programs to all processing of the physical drives:
  - ShadowImage for z/OS
  - Business Copy XP
  - Flex Copy XP

- Hitachi® FlashCopy® Mirroring
- Hitachi® FlashCopy® Mirroring Version 2
- Volume Migration

This value is found by dividing access time to physical drives by the following programs by all the access time to physical drives. The Ave. (Total) column indicates the average percentage of processing in the specified period for the programs listed above. The Max. column indicates the maximum percentage of processing of the programs listed above in the specified period. For more information, see the programs' documentation.

- **CLPR:** The number and name of the CLPR that corresponds to the parity group to which the logical volume belongs, in the format **CLPR number:CLPR name**. For more information about CLPRs, see "Working with CLPRs" on page 152.

## Viewing channel adapter (CHA) usage statistics

Auto LUN monitors channel adapters, and displays average and maximum usage rates in the specified period.

1. In the Auto LUN pane, click **Physical**, and click the CHA folder. The table displays usage statistics about channel adapters (CHAs).

	ID	Usage(%)	
		Ave.(Total)	Max.
<input checked="" type="checkbox"/>	CHP00-1P	-	-
<input type="checkbox"/>	CHP01-1P	-	-
<input type="checkbox"/>	CHP02-1P	-	-
<input type="checkbox"/>	CHP03-1P	-	-
<input type="checkbox"/>	CHP40-2V	-	-
<input type="checkbox"/>	CHP41-2V	-	-
<input type="checkbox"/>	CHP42-2V	-	-
<input type="checkbox"/>	CHP43-2V	-	-

**Figure 201** CHA usage statistics

2. To display a graph illustrating changes in usage rates for channel adapters, click the channel adapters in the table, and click **Draw**.

The table displays the following items:

- **Graph column:** The "check mark" icon () indicates the graph is currently illustrating data for that item.
- **ID:** Channel processor ID numbers.
- **Usage:** The Ave. (Total) column displays the average usage rate in the specified period. The Max. column displays the maximum usage rate in the specified period.

## Viewing channel processor (CHP) usage statistics

Auto LUN monitors channel processors in each channel adapter, and displays average and maximum usage rates in the specified period.

1. In the Auto LUN pane, click **Physical**, and double-click the CHA folder. A list of channel adapters appears below the CHA folder.

2. Click a channel adapter. The table displays usage statistics about channel processors in the selected channel adapter.

	ID	Usage(%)	
		Ave.	Max.
	CHP00-1P	20	82
	CHP01-1P	20	82
	CHP02-1P	20	82
	CHP03-1P	20	82

**Figure 202** CHP usage statistics

3. To display a graph illustrating changes in usage rates for channel processors, click the channel processors in the table, and click **Draw**.

The table displays the following items:

- **Graph column:** The “check mark” icon () indicates the graph is currently illustrating data for that item.
- **ID:** Channel processor ID numbers.
- **Usage:** The Ave. (Total) column displays the average usage rate in the specified period. The Max. column displays the maximum usage rate in the specified period.

## Viewing disk adapter (DKA) usage statistics

Auto LUN monitors disk adapters, and displays average and maximum usage rates in the specified period. If you click the DKA folder, the table displays a list of disk adapters and indicates whether each disk adapter is located in Cluster-1 or Cluster-2.

In the Auto LUN pane, click **Physical**, and click the DKA folder. The table displays a list of disk adapters.

Adapter	Cluster-1	Cluster-2
DKA-1B	0	-
DKA-1C	0	-
DKA-2H	-	0
DKA-2J	-	0

**Figure 203** DKA usage statistics

The table displays the following items:

- **Adapter:** Disk adapter ID numbers.
- **Cluster-1:** If the Cluster-1 column displays 0 and the Cluster-2 column displays a hyphen, the disk adapter is located in Cluster-1.
- **Cluster-2:** If the Cluster-2 column displays 0 and the Cluster-1 column displays a hyphen, the disk adapter is located in Cluster-2.

## Viewing disk processor (DKP) usage statistics

Auto LUN monitors disk processors, and displays average and maximum usage rates in the specified period.

1. In the Auto LUN pane, click **Physical**, and double-click the DKA folder. A list of disk processors appears below the DKA folder.

2. Click the DKP. The table displays usage statistics about disk processors in the disk adapter.

	ID	Usage(%)	
		Ave.(Total)	Max.
<input checked="" type="checkbox"/>	DKP80-1.A	+0	4
<input type="checkbox"/>	DKP81-1.A	+0	1
<input type="checkbox"/>	DKP82-1.A	+0	4
<input type="checkbox"/>	DKP83-1.A	+0	1
<input type="checkbox"/>	DKP84-1.A	+0	4
<input type="checkbox"/>	DKP85-1.A	+0	1
<input type="checkbox"/>	DKP86-1.A	+0	4

**Figure 204** DKP usage statistics

3. To display a graph illustrating changes in usage rates for disk processors, click the disk processors in the table, and click **Draw**.

The table displays the following items:

- **Graph column:** The “check mark” icon () indicates the graph is currently illustrating data for that item.
- **ID:** Disk processor ID numbers.
- **Usage:** The Ave. (Total) column displays the average usage rate in the specified period. The Max. column displays the maximum usage rate in the specified period.

## Viewing data recovery and reconstruction processor (DRR) usage statistics

Auto LUN monitors data recovery and reconstruction processors (DRRs), and displays average and maximum usage rates in the specified period.

1. In the Auto LUN pane, click **Physical**, and double-click the DKA folder. A list of DRRs appears below the DKA folder.
2. Click the DRR below the disk adapter. The table displays usage statistics about DRRs in the disk adapter.

	CLPR	Write Pending(%)	
		Ave.(Total)	Moment Max.
<input type="checkbox"/>	00:CLPR0	0	0
<input type="checkbox"/>	01:ClprUno	0	0
<input type="checkbox"/>	02:CLPR2	0	0
<input type="checkbox"/>	03:kamani_cache	0	0

**Figure 205** DRR usage statistics

3. To display a graph illustrating changes in usage rate for DRRs, click the DRRs in the table, and click **Draw**.

The table displays the following items:

- **Graph column:** The “check mark” icon () indicates the graph is currently illustrating data for that item.
- **ID:** DRR ID numbers.

- **Usage:** The Ave. (Total) column displays the average usage rate in the specified period. The Max. column displays the maximum usage rate in the specified period.

## Viewing write pending rates

Auto LUN displays write pending rates. The write pending rate indicates the ratio of write-pending data to cache memory capacity. Auto LUN displays average and maximum write pending rates in the specified period.

1. In the Auto LUN pane, click **Physical**, and click the Cache folder.

	CLPR	CLPR Name	Write Pending(%)	
			Ave.(Total)	Moment Max.
	0	CLPR0	6	70

**Figure 206** Write pending rates

2. To display a graph illustrating changes in the write pending rate, click the write pending rate in the table, and click **Draw**.

The table displays the following items:

- **Graph column:** The “check mark” icon () indicates the graph is currently illustrating data for that item.
- **CLPR:** The number and name of the CLPR that corresponds to the parity group to which the logical volume belongs, in the format **CLPR number:CLPR name**. For more information about CLPRs, see “Working with CLPRs” on page 152.
- **Write Pending (%):** The Ave. column displays the average write pending rate for the specified period. The Moment Max. column displays the maximum write pending rate for the specified period.

## Viewing access path usage statistics

Channel adapters (CHAs) and disk adapters (DKAs) transfer data to the cache switch (CSW) and shared memory (SM) when I/O requests are issued from hosts to the disk array. Also, the cache switch transfers data to cache memory.

Auto LUN monitors these data transfer paths, and displays average and maximum usage rates for the paths in a specified period.

1. In the Auto LUN pane, click **Physical**, and double-click the Access Path Usage folder.
2. Do any of the following:
  - To check usage statistics about paths between adapters (CHAs and DKAs) and the cache switch, click **Adapter-CSW** below the Access Path Usage folder.

	Adapter	CSW	Usage(%)	
			Ave.(Total)	Max.
	CHA-1E	CSW-1D	+0	2
	CHA-1E	CSW-2P	+0	2
	CHA-2Q	CSW-1D	0	0
	CHA-2Q	CSW-2P	0	0
	DKA-1A	CSW-1D	0	0
	DKA-1A	CSW-2P	0	0
	DKA-2M	CSW-1D	0	0

**Figure 207** Usage statistics about paths between adapters and the cache switch



- To check usage statistics about paths between adapters (CHAs and DKAs) and shared memory, click **Adapter-SM** below the Access Path Usage folder.

	Adapter	SM	Usage(%)	
			Ave.(Total)	Max.
	CHA-1E	SM-1SA	6	20
	CHA-1E	SM-2SB	2	8
	CHA-2Q	SM-1SA	5	19
	CHA-2Q	SM-2SB	1	8
	DKA-1A	SM-1SA	2	4
	DKA-1A	SM-2SB	2	4
	DKA-2M	SM-1SA	2	4

**Figure 208** Usage statistics about paths between adapters and shared memory

- To check usage statistics about paths between cache switches and cache memory, click **CSW-Cache** below the Access Path Usage folder.

	CSW	Cache	Usage(%)	
			Ave.(Total)	Max.
	CSW-1D	CACHE-1CA	0	0
	CSW-2P	CACHE-1CA	0	0
	CSW-1D	CACHE-2CB	0	0
	CSW-2P	CACHE-2CB	0	0

**Figure 209** Usage statistics about paths between cache switches and cache memory

3. To display a graph illustrating changes in usage statistics about paths, click the paths in the table, and click **Draw**.

The table displays the following items:

- **Graph column:** The “check mark” icon () indicates the graph is currently illustrating data for that item.
- **Usage(%):** The Ave. (Total) column displays the average path usage rate in the specified period. The Max. column displays the maximum path usage rate in the specified period.

## Workload and traffic statistics

### Collecting workload and traffic statistics about disk drives, ports, and LU paths

To obtain usage statistics about workloads, port traffic, LU path traffic, and traffic between host bus adapters and ports, complete the following instructions to start monitoring the disk array:

1. In the Auto LUN pane, click **Monitoring Options**. The Monitoring Options pane appears.
2. Do either of the following:
  - For XP128/XP1024 arrays: Under Short range monitoring S/W, click **ON** for the **Current Status** option.
  - For XP12000 arrays: Click **Enable** for the **Current Status** option.
3. Do either of the following:
  - For XP128/XP1024 arrays: Use the two lists in **Gathering Time** to specify the time when the disk array collects statistics.

- For XP12000 arrays: Use the **Gathering Interval** box to specify the interval during which the disk array collects statistics.

4. Click **Apply**. Auto LUN starts monitoring the disk array.

To stop monitoring the disk array, complete the following instructions. If you stop monitoring, Auto LUN stops collecting statistics.

1. In the Auto LUN pane, click **Monitoring Options**. The Monitoring Options pane appears.
2. Do either of the following:
  - For XP128/XP1024 arrays: Under Short range monitoring S/W, click **OFF** for the **Current Status** option.
  - For XP12000 arrays: Click **Disable** for the **Current Status** option.
3. Click **Apply**.

## Viewing disk drive workload statistics

Use the **LDEV** tab of the Auto LUN pane to check workloads on physical disk drives (parity groups) or logical volumes. The pane displays the following information:

- Number of I/O requests issued to parity groups and logical volumes
- Amount of data transferred to parity groups and logical volumes
- Read hit rate
- Write hit rate
- Number of data transfers between parity groups (or logical volumes) and cache memory

1. In the Auto LUN pane, click **LDEV**. The LDEV tree displays a list of parity groups.
2. In the list on the right, click **IOPS** to specify I/Os per second, or click **MB/s** to specify megabytes transferred per second.
3. In the LDEV tree, do one of the following:
  - To check workload statistics for all parity groups, click the folder containing the parity groups.

	PG	IO Rate(IOPS)	Read(IOPS)	Write(IOPS)
	1-1	0	0	
	1-2	0	0	
	1-3	0	0	

**Figure 210** Workload statistics for all parity groups

- To check workload statistics for certain parity groups, click a **Box** folder. For example, if you click the **Box 1** folder, the table displays only parity groups that have IDs beginning with "1-".

	PG	IO Rate(IOPS)	Read(IOPS)	Write(IOPS)
	1-1	0	0	0
	1-2	0	0	0
	1-3	0	0	0

**Figure 211** Workload statistics for a specific parity group

- To check workload statistics for logical volumes in a parity group, click the parity group.

	LDEV	Emulation	IO Rate(IOPS)	Read(IOPS)	Write
<input checked="" type="checkbox"/>	00:00	OPEN-8	0	0	
<input type="checkbox"/>	00:01	OPEN-8	0	0	
<input type="checkbox"/>	00:02	OPEN-8	0	0	
<input type="checkbox"/>	00:03	OPEN-3	0	0	
<input type="checkbox"/>	00:04	OPEN-8	0	0	

**Figure 212** Workload statistics for logical volumes in a parity group

4. To display a graph, click the parity groups or logical volumes, use the list on the lower-right side of the table to select the type of information you want to view, and click **Draw**. A graph displays below the table. The horizontal axis indicates the time.
5. To view detailed information in the graph, click the **Detail** check box on the lower-right side of the table, and click **Draw**. The graph contents change. If you specify more than one parity group or logical volume, you cannot click the **Detail** check box to view detailed information.

If the graph does not display changes in workload statistics, change the value in the **Chart Y Axis Rate** list. For example, if the largest value in the table is 200 and the value in Chart Y Axis Rate is 100, select a value larger than 200 from Chart Y Axis Rate.

The table displays the following:

- **Graph column:** The “check mark” icon () indicates the graph is currently illustrating data for that item.
- **Group:** Parity group ID. If the ID starts with the letter E, logical volumes in the parity group are external LUs.
- **LDEV:** Logical volume ID. If the ID ends with the symbol #, logical volume is an external LU.
- **Type:** Emulation type.
- **IO Rate (IOPS):** Number of I/O requests to the parity group (or logical volume) per second. This column is displayed when IOPS is selected in the list on the upper-right side of the table.
- **Read (IOPS):** Number of read accesses to the parity group (or logical volume) per second. This column is displayed when IOPS is selected in the list on the upper-right side of the table.
- **Write (IOPS):** Number of write accesses to the parity group (or logical volume) per second. This column is displayed when IOPS is selected in the list on the upper-right side of the table.
- **Trans.(MB/s):** Size (in megabytes) of data transferred to the parity group (or logical volume) per second. This column is displayed when MB/s is selected in the list on the upper-right side of the table.
- **Read Hit(%):** Read hit rate.
- **Write Hit(%):** Write hit rate.
- **Back Trans.(count/sec):** Number of data transfers between parity group (or logical volume) and cache memory.
- **Response Time (ms):** Time (in milliseconds) for replying from an external volume group when I/O accesses are made from the disk array to the external volume group. Average response time in the period specified for **Monitoring Term** is displayed.
- **CLPR:** The number and name of the CLPR that corresponds to the parity group to which the logical volume belongs, in the format **CLPR number:CLPRname**. For more information, see “[Working with CLPRs](#)” on page 152.

# Viewing disk array port traffic statistics

1. In the Auto LUN pane, click **Port-LUN**, and click the **Subsystem** folder in the tree. The Port-LUN tree lists ports on the disk array. When you double-click a port, a list of host groups for the port appears. When you double-click a host group, the **LUN** icon appears.
2. To check the number of I/Os, click **IOPS** in the list on the right side of the pane. To check the amount of data transferred, click **MB/s**. To view IOPS or amount of data in real time, select the **Real Time** option, specify the number of collections to display, and click **Apply**.
3. In the Port-LUN tree, do one of the following:
  - To view traffic statistics about ports in the disk array, click the root.

	Port	Current(IOPS)	Ave.(IOPS)...	Peak...	Response...	A
	All Non-Prio.	-	-	-	-	Nc
	All Prio.	-	0	0	-	
	CL1-A(EF)	-	0	0	-	
	CL1-B(E1)	-	0	0	-	
	CL1-C(D9)	-	0	0	-	

**Figure 213** Traffic statistics about ports in a disk array

- To view traffic statistics about host ports to which a disk array port is connected, click the disk array port.

	WWN	PFC Name	Current...	Ave....	Max...	Response...
	0000000000000001	wwn01	-	0	0	-
	0000000000000002	wwn02	-	0	0	-
	0000000000000003	wwn03	-	0	0	-
	Others	-	-	0	0	-

**Figure 214** Traffic statistics about host ports to which a disk array port is connected

- To view traffic statistics about host ports in a host group, click the host group.

	WWN	Nickname	Current...	Ave....	Max....	Response...

**Figure 215** Traffic statistics about host ports in a host group

- To view traffic statistics about LU paths, click the **LUN** icon.

	LUN	CU:LDEV	Emulation	Paths	Current(IOPS)	Ave....	Max....	Respon

**Figure 216** Traffic statistics about LU paths

4. To find out how traffic has changed, click the ports, WWNs, or LUNs, and click **Draw**. A graph appears below the table.
5. To view more detailed information in the graph, click the **Detail** check box on the lower-right side of the table, and click **Draw**. The graph contents change.

The table displays the following:

- **Graph column:** The “check mark” icon () indicates the graph is currently illustrating data for that item.

- **Port:** Ports on the disk array.
- **WWN:** WWNs of the host bus adapters.
- **LUN:** LUNs (logical unit numbers).
- **PFC Name:** PFC names of host bus adapters.
- **Nickname:** Nickname for host bus adapters. LUN Management allows you to assign a nickname to each host bus adapter so you can easily identify each host bus adapter in the LUN Management panes.
- **CU:LDEV:** Logical volume IDs. The number on the left of the colon is the CU image number. The number on the right of the colon is the LDEV number. If a logical volume ID ends with the symbol #, the logical volume is an external LU.
- **Emulation:** Emulation types.
- **Paths:** Number of LU paths.
- **Current:** Current I/O rate.
- **Ave.:** Average I/O rate for the specified period.
- **Max.:** Maximum I/O rate for the specified period.
- **Response Time (ms):** Time (in milliseconds) for replying from an external volume group when I/O accesses are made from disk array to external volume group. Average response time in the period specified for Monitoring Term is displayed.

If you select a port in the list, click **Draw**, and select the **Detail** check box, a detailed graph of the port I/O rate is drawn. The Peak value means the top of the Max. line in this graph.

- **Attribute:** Priority of each port. Prio. indicates a prioritized port. Non-Prio. indicates a non-prioritized port. iSCSI ports are always prioritized ports. Therefore, the **Attribute** column displays Prio. for each iSCSI port. When calculating I/O rates to be displayed in the All Prio. row, Auto LUN uses I/O rates of iSCSI ports and other prioritized ports.





**NOTE:** iSCSI is currently supported only for the XP128/XP1024 disk arrays.

## Viewing HBA/port traffic statistics

If Performance Control is enabled, Auto LUN monitors paths between host bus adapters (HBAs) in host servers and ports on disk arrays. You can view both I/O and transfer rates between HBAs and ports.

1. In the Auto LUN pane, click **WWN**.

The tree view displays a list of PFC groups (  ). The **Not Grouped** item appears below the PFC groups.

- If you double-click a PFC group, host bus adapters (  ) in the PFC group are displayed.
- If you double-click **Not Grouped**, host bus adapters (  ) that do not belong to any PFC group are displayed.

2. In the list on the right side of the pane, do either of the following:

- To view I/O rates, select **IOPS**.
- To view transfer rates, select **100KB/s (MB/s [XP 12000])**.

3. In the tree view, do one of the following:

- To view traffic statistics for host bus adapters in a PFC group, click the PFC group.

WWN	PFC Name	Current...	Ave.(I...	Max.(IOPS)	Response Time(ms)	Attribute
0000000000000003	wwn03	-	0	0	-	Non-Prio.
0000000000000002	wwn02	-	0	0	-	Non-Prio.

**Figure 217** Traffic statistics for host bus adapters

- To view traffic statistics for host bus adapters that do not belong to any PFC group, click **Not Grouped** (see [Figure 217](#)).
- To view the I/O or transfer rates at each PFC group, click the **Subsystem** folder.

Group	Current(IOPS)	Ave.(IOPS)...	Max.(IOPS)	Response...
grp03	-	0	0	-
<Not Grouped>	-	-	-	-

**Figure 218** Traffic statistics for each PFC group

- To view traffic statistics for each port connected to a given host bus adapter, click the HBA.

Port	Current(IOPS)	Ave.(IOPS)(Total)	Max.(IOPS)	Re
CL1-A	-	0	0	
CL3-A	-	0	0	
CL5-A	-	0	0	

**Figure 219** Traffic statistics for each port connected to a specified HBA

4. To find out how traffic has changed, in the table, click the PFC groups or WWNs, and click **Draw**. A graph appears below the table.



**NOTE:** If a host bus adapter's WWN is displayed in red in the tree view, the host bus adapter is connected to two or more ports, but Performance Control does **not** control traffic between the HBA and some ports. When many-to-many connections are established between HBAs and ports, monitor all traffic between HBAs and ports. For information about controlling traffic between the HBA and connected ports, see "[Performance Monitor and Performance Control](#)" on page 411.

5. To view more detailed information in the graph, click the **Detail** check box on the lower-right side of the table, and click **Draw**. The graph contents change.

The table displays the following:

- **Graph column:** The "check mark" icon () indicates the graph is currently illustrating data for that item.
- **Group:** PFC groups.
- **PFC Name:** PFC names of host bus adapters.
- **Port:** Ports on the disk array.
- **Current:** Current I/O or transfer rate.
- **Ave.:** Average I/O or transfer rate for the specified period.
- **Max.:** Maximum I/O or transfer rate for the specified period.
- **Response Time:** Time between when the DKC receives the read/write command and when the DKC responds to the command. The value is average response time over one minute.

- **Attribute:** Priority of each host bus adapter. **Prio.** indicates a high-priority HBA (prioritized WWN). **Non-Prio.** indicates a low-priority HBA (non-prioritized WWN). iSCSI ports are always prioritized ports. Therefore, the Attribute column displays Prio. for each iSCSI port. When calculating I/O rates displayed in the All Prio. row, Auto LUN uses I/O rates of iSCSI ports and other prioritized ports.



**NOTE:** iSCSI is currently supported only for the XP128/XP1024 disk arrays.

## Creating and executing migration plans

Before you use Auto LUN, you must first reserve logical volumes for migration destinations. See “Reserving target volumes” on page 393.

1. In the Auto LUN pane, click **Physical**.
2. Click **Plan**. The **Plan - Manual Migration** tab appears.

There are four tabs: **Manual Migration**, **Auto Migration**, **Attribute**, and **History**. Click the tabs to access that pane. By default, the Manual Migration tab appears.

### Manual Migration tab

Use this tab to create and execute migration plans for manually migrating volumes.

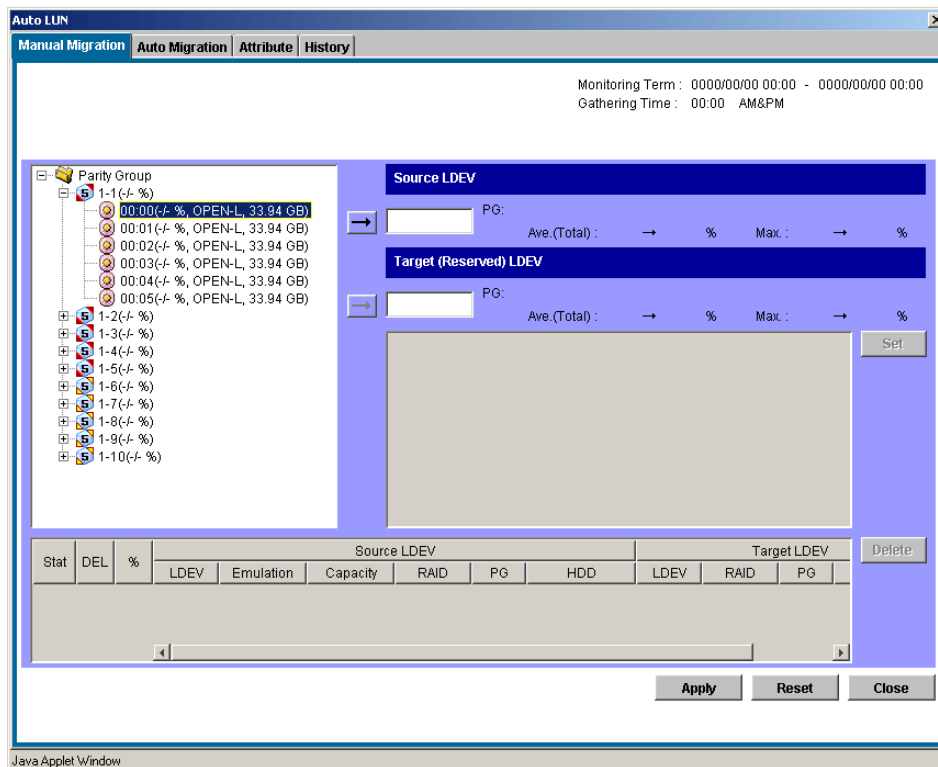

**Figure 220** Manual Migration tab

### Pane contents

This pane contains the following items:

- **Monitoring Term:** Displays the monitoring period specified in the Auto LUN pane, analyzes disk usage information collected by Auto LUN during the monitoring period, and calculates estimated usage rates of the source and target parity groups after a proposed volume migration.

- **Gathering Time:** Displays the time specified in the Auto LUN Monitoring Options pane. The disk array collects usage statistics about resources (such as hard disk drives) at the specified gathering time. Auto LUN uses collected usage statistics to estimate usage rates of parity groups after a proposed volume migration.
- **Source LDEV section:** Specifies the source volume (logical volume you want to migrate). On the right are the current usage rate for the parity group to which the source volume belongs and estimated usage rate for the parity group after a proposed volume migration.
- **Target (Reserved) LDEV section:** Specifies the target volume (where you want to migrate the source volume). On the right are the current usage rate for the parity group to which the target volume belongs and estimated usage rate for the parity group after a proposed volume migration.

### Tree view

This view lists parity groups in the disk array. Double-clicking a parity group icon displays the logical volumes in that parity group.

### Table view

- **Plan columns:**
  - **Stat:** Displays an error code if an error occurs during execution of a migration plan. To view detailed information about an error, select and right-click the error code, and click **Details**.
  - **DEL:** Displays the character “D” if you delete a migration plan that is waiting for execution. Migration plans indicated by “D” are deleted when you click **Apply**.
  - **%:** Displays the progress of the manual migration.
- **Source LDEV columns:**
  - **LDEV:** Logical volume ID
  - **Emulation:** Emulation type of the logical volume
  - **Capacity:** Capacity of the logical volume
  - **RAID:** RAID type
  - **PG:** Parity group ID (frame and group number)
  - **HDD:** Type of hard disk drive
- **Target LDEV columns:**
  - **LDEV:** Logical volume ID
  - **RAID:** RAID type
  - **PG:** Parity group ID (frame and group number)
  - **HDD:** Type of hard disk drive

### Buttons

- **Set:** Adds a new manual migration plan consisting of the logical volume in SourceLDEV and the logical volume in TargetLDEV. Each row in the table indicates a migration plan.
- **Delete:** Deletes the migration plan. If you select a migration plan in black (migration plan waiting for execution or being executed) and click **Delete**, the DEL column displays the character “D.” The selected migration plan will not be deleted until you click **Apply**.
- **Apply:** Applies manual migration plans in the table to the disk array.
- **Source LDEV addition:** The “→” button below the Source LDEV section.



- **Target LDEV addition:** The “→” button below the Target (Reserved) LDEV section.
- **Reset:** Cancels execution of the manual migration plan.
- **Close:** Closes this pane.

## Migrating volumes manually

To migrate volumes manually, you must create migration plans. A migration plan is a pair of volumes—source volume and corresponding target (destination) volume. To migrate more than one logical volume, you must create multiple migration plans.



**NOTE:** For manual migrations, you can specify logical volumes in a fixed parity group as source or target volumes.



**CAUTION:** Do not perform manual migrations while the Auto Migration function is active. Doing so cancels all existing auto migration plans. Use the following procedure to turn off Auto Migration and cancel any auto migration plans before doing a manual migration.

1. In the Auto LUN pane, click **Physical**.
2. Click **Plan**. The Manual Migration tab appears.
3. Before migrating logical volumes manually, click **Auto Migration** to turn off Auto Migration.
4. In Auto Migration Plans, click **Delete All** to remove all auto migration plans.
5. In Auto Migration Function, click **OFF**, and click **Set**.
6. Click **Manual Migration**.
7. In the tree, double-click a parity or external volume group. A list of logical volumes in that group appears. Logical volumes that can be migrated are indicated by the icon.
8. From a volume with the icon, click the source volume (logical volume to migrate), and click the **S** button. The selected volume is defined as the source volume.
9. In the tree, double-click the parity group to which you want to migrate the source volume. A list of logical volumes in that parity group appears. Click the target (destination) volume. You can click only volumes with a green pin icon or an icon framed by a blue line.
10. From the logical volumes indicated by a blue icon with a left-pointing arrow, select the logical volume to define as the target volume, and click the **T** button below the **Target (Reserved) LDEV** section.

Auto LUN calculates estimated usage rates of the source and target parity group. Estimated results are displayed on the right of the **Source LDEV** and **Target (Reserved) LDEV** text box and in the graph.

11. Check the estimated results in **Source LDEV**, **Target (Reserved) LDEV**, and the graph. If you think you can achieve the necessary disk performance, go to the next step. If not, change the source or target volume.
12. Click **Set**.

A new migration plan, consisting of the specified source and target volumes, is added to the table. The new migration plan is shown in blue.

To migrate more than one volume manually, repeat the steps to add migration plans.

13. Click **Apply**.

Migration plans are applied to the disk array and wait for execution. Volume Migration performs multiple migration plans concurrently. The font color of the migration plans changes from blue to black.

When a logical volume starts migration, the % column displays the migration's progress. When migration is complete, the volume's migration plan disappears.

If an error occurs during migration, an error code appears.

## Deleting manual migration plans

To delete a migration plan, click a migration plan, and click **Delete**.

You cannot use the **Delete** button to delete migration plans executed by programs other than Volume Migration.

If you select a migration plan in black (migration plan waiting for execution or being executed) and click **Delete**, the character "D" is displayed in the DEL column. The migration plan will not be deleted until you click **Apply**.



**CAUTION:** If you delete a migration plan that is being executed, the integrity of data on the target volume cannot be guaranteed.

When an error condition exists on the disk array, resource usage can increase or become unbalanced. Do not use the usage statistics collected during an error condition as the basis for planning migration operations.

## Auto Migration tab

Use this tab to make settings for automating volume migrations.



**NOTE:** Auto migration cannot use external volumes or volumes reserved by another program.

Manual Migration | **Auto Migration** | Attribute | History

Monitoring Term : 2004/08/04 01:00 - 2004/08/05 01:00  
Gathering Interval : 15 Minute(s)

### Auto Migration Plans

Auto Migration :  Disable    Migration Status : Not planned yet    Auto Refresh :  Enable  Disable  
Plan Creation :    Next Migration :

%	Source LDEV					Target LDEV						
	LDEV	Emulation	Capacity	RAID	PG	HDD	LDEV	RAID	PG		HDD	

Make New Plan  
Delete  
Delete All

### Auto Plan Parameters

Auto Migration Function :  Enable  Disable    Default

Sampling Term  
Date :  None  Every day  Once every X days: 2  
 Once a week: Sunday  Once a month: 1  
Time : From 06 : 00 To 02 : 00

Number of Sampling Points :  All sampling points  X highest sampling points: 1

Migration Time : 04 : 30

Auto Migration Condition  
Max. Migration duration: 60 min.  
Max. disk utilization: 50 %  
Max. number of vols for migration: 1

Set  
Reset  
Close

Figure 221 Auto Migration tab

## Pane contents

This pane contains the following items:

- **Monitoring Term:** Displays the monitoring period specified in the Auto LUN pane, analyzes disk usage information collected by Auto LUN during the monitoring period, and calculates estimated usage rates of the source and target parity groups after a proposed volume migration.
- **Gathering Time:** Displays the time specified in the Auto LUN Monitoring Options pane. The disk array collects usage statistics about resources (such as hard disk drives) at the specified gathering time. Auto LUN uses collected usage statistics to estimate usage rates of parity groups after a proposed volume migration.

### Auto Migration Plans section

- **Auto Migration Function:** If Auto Migration Function is ON, auto migrations take place at the next migration time
- **Migration Status:** Progress of auto migration plans
  - **Not planned yet:** Has not yet created auto migration plans
  - **Not performed yet:** Has created auto migration plans, but has not executed them
  - **Failed to make plan:** Failed to create auto migration plans
  - **Under migration:** Is executing an auto migration plan
  - **Last migration has canceled (Please see log file):** Has canceled the plan
  - **Migration successfully ended. Plan has done:** Successfully executed the migration plans
- **Plan Creation Time:** When auto migration plans were created
- **Next Migration Time:** When the next auto migrations will be performed
- **Make New Plan button:** Discards existing auto migration plans and creates new auto migration plans
- **Delete button:** Deletes the selected auto migration plan
- **Delete All button:** Deletes all auto migration plans

### Auto Plan Parameter section

- **Auto Migration Function:** If you click **ON**, logical volumes are automatically migrated. If you click **OFF**, they are not.
- **Sampling Term:** The auto migration function analyzes resource usage within the Sampling Term and creates auto migration plans based on that analysis. Use Sampling Term to narrow resource usage statistics to be analyzed.
- **Date and Time:** Specifies a date/time frequency for analyzing resource usage.
- **Number of Sampling Points:** Click **All sampling points** or **X highest sampling points**. With X highest sampling points, Auto LUN uses the Xth highest average usage rate during the sampling period to determine disk usage. Use the list to specify the value of X.
- **Migration Time:** Specifies the time when auto migration starts
- **Auto Migration Condition:** Specifies the following auto migration conditions:
  - **Max. migration duration:** Time limit (10-120 minutes) for an auto migration plan. If the migration is not completed within this limit, remaining migration operations are performed at the next scheduled execution time.

- **Max. disk utilization:** Disk usage limit (10-100%) during auto migration. If the most recent usage for any source or target parity group is over this limit when auto migration starts, Auto LUN cancels the auto migration plan and retries the plan at the next execution time.
- **Max. number of vols for migration:** The maximum number of volumes (1-40) that can be migrated during one auto migration plan.
- **Default button:** Sets parameters to their default values and applies them to the disk array.
- **Set button:** Applies parameters to the disk array.
- **Reset button:** Restores parameters to the value before the change.
- **Close button:** Closes this pane.

## Setting auto migration parameters

1. In the Auto LUN pane, click **Physical**.
2. Click **Plan**. The Manual Migration tab appears.
3. Click **Auto Migration**. The Auto Migration tab appears.
4. In the **Date** and **Time** boxes in Sampling Term, specify a period to analyze resource usage statistics.  
Ensure that the data term and auto migration execution time are separated by at least one hour. For example, if the sampling term is from 10:00 to 14:00, auto migration should not be performed between 09:00 and 15:00.
5. In Number of Sampling Points, click **All sampling points** or **X highest sampling points**, and click the value of X in the list.
6. In Migration Time, specify when to start auto migration operations. The following scheduling restrictions apply to Migration Time:
  - Must be at least 15 minutes plus the specified maximum migration duration earlier than disk array auto-reboot or data gathering.
  - Must be at least 30 minutes later than disk array auto-reboot or data gathering.
  - Must be at least 15 minutes plus the specified maximum migration duration earlier than the specified Data Term start time.
  - Must be at least 60 minutes later than the specified Data Term end time.
7. If necessary, set the auto migration parameters as follows:
  - **Max. migration duration.** Set a time limit for auto migrations. If auto migration is not completed within this limit, Auto LUN cancels operations.
  - **Max. disk utilization.** Set a disk usage limit.
  - **Max. number of vols for migration.** Specify the maximum number of volumes that can be auto migrated at the same time.
8. In Auto Migration Function, click **ON**.
9. Click **Set**.
10. Click **Close**.

## Deleting auto migration plans

- To delete all auto migration plans, click **Delete All**.
- To delete one auto migration plan, click the plan in the table, and click **Delete**.

## Remaking auto migration plans

If auto migration operations do not produce enough improvements in disk access performance, discard the current migration plans and create new auto migration plans.

1. In the Auto LUN pane, click **Physical**.
2. Click **Plan**. The Manual Migration tab appears.
3. Click **Auto Migration**. The Auto Migration tab appears.
4. In the Auto Migration tab, change the limit on the disk usage rate for HDD classes.
5. Make any other changes in the Auto Plan Parameters section of the pane.
6. Click **Make New Plan**. The existing auto migration plans are deleted and new auto migration plans are created.
7. Click **Close**.

## Attribute tab

Use this tab to find out which parity group belongs to which HDD class. The tab also displays information about parity groups, such as parity group usage, logical volume capacity, and RAID type.

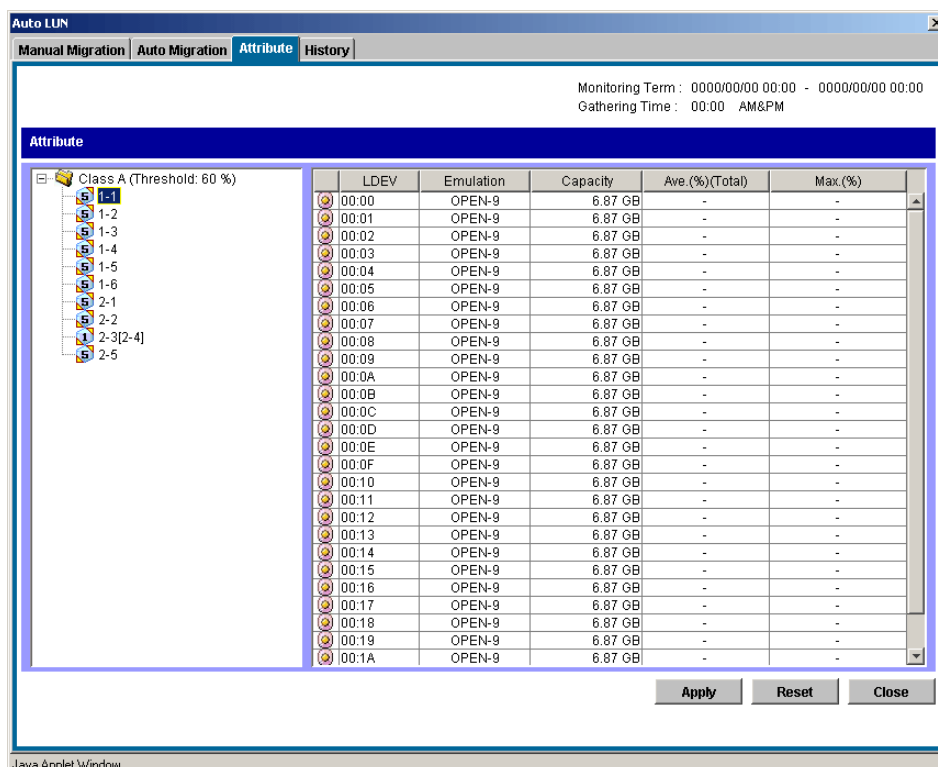

Monitoring Term : 0000/00/00 00:00 - 0000/00/00 00:00  
Gathering Time : 00:00 AM&PM

Attribute

Class A (Threshold: 60 %)

LDEV	Emulation	Capacity	Ave. (%)(Total)	Max. (%)
00:00	OPEN-9	6.87 GB	-	-
00:01	OPEN-9	6.87 GB	-	-
00:02	OPEN-9	6.87 GB	-	-
00:03	OPEN-9	6.87 GB	-	-
00:04	OPEN-9	6.87 GB	-	-
00:05	OPEN-9	6.87 GB	-	-
00:06	OPEN-9	6.87 GB	-	-
00:07	OPEN-9	6.87 GB	-	-
00:08	OPEN-9	6.87 GB	-	-
00:09	OPEN-9	6.87 GB	-	-
00:0A	OPEN-9	6.87 GB	-	-
00:0B	OPEN-9	6.87 GB	-	-
00:0C	OPEN-9	6.87 GB	-	-
00:0D	OPEN-9	6.87 GB	-	-
00:0E	OPEN-9	6.87 GB	-	-
00:0F	OPEN-9	6.87 GB	-	-
00:10	OPEN-9	6.87 GB	-	-
00:11	OPEN-9	6.87 GB	-	-
00:12	OPEN-9	6.87 GB	-	-
00:13	OPEN-9	6.87 GB	-	-
00:14	OPEN-9	6.87 GB	-	-
00:15	OPEN-9	6.87 GB	-	-
00:16	OPEN-9	6.87 GB	-	-
00:17	OPEN-9	6.87 GB	-	-
00:18	OPEN-9	6.87 GB	-	-
00:19	OPEN-9	6.87 GB	-	-
00:1A	OPEN-9	6.87 GB	-	-

Apply Reset Close

Java Applet Window









Figure 222 Attribute pane

## Pane contents

This pane contains the following items:









- **Monitoring Term:** Displays the monitoring period specified in the Auto LUN pane, analyzes disk usage information collected by Auto LUN during the monitoring period, and calculates estimated usage rates of the source and target parity groups after a proposed volume migration.
- **Gathering Time:** Displays the time specified in the Auto LUN Monitoring Options pane. The disk array collects usage statistics about resources (such as hard disk drives) at the specified gathering time. Auto LUN uses collected usage statistics to estimate usage rates of parity groups after a proposed volume migration.

- **Attribute tree:** Lists HDD classes. When you double-click an HDD class icon, a list of parity groups in that HDD class appears.
- **Apply button:** Applies settings in the **Attribute** tab to the disk array.
- **Reset button:** Discards changes in the **Attribute** tab and restores the original settings.
- **Close button:** Closes this pane.
- **Class table boxes:** When you click a class in the Attribute tree, the table displays information about parity groups in that class.



PG	HDD	Ave.(%)(To...	Max.(%)	Total	Reserved	CLPR
 1-1	DKR2E-J146FC	0	0	58	0	02:CLPR2
 1-2	DKR2E-J146FC	0	0	56	0	00:CLPR0
 1-3	DKR2E-J146FC	0	0	58	0	00:CLPR0
 1-4	DKR2E-J146FC	0	0	58	0	00:CLPR0
 2-1	DKR2E-J146FC	0	0	58	0	00:CLPR0
 2-2	DKR2E-J146FC	0	0	58	0	00:CLPR0
 2-3	DKR2E-J146FC	0	0	58	0	00:CLPR0
 2-4	DKR2E-J146FC	0	0	58	0	00:CLPR0

**Figure 223** Class table boxes

- **PG:** Parity group ID.
- **HDD:** Type of hard disk drive.
- **Ave.:** Average usage rate for the parity group. If an exclamation mark (!) appears, the reported usage rate might be inaccurate because the configuration has changed (for example, volumes have been moved by a migration plan or changed by VSC).
- **Max.:** Maximum usage rate for the parity group. If an exclamation mark (!) appears, the reported usage rate might be inaccurate.
- **Total:** Total number of logical volumes in the parity group.
- **Reserved:** (XP128/XP1024 only) Number of reserved logical volumes.
- **CLPR:** The number and name of the CLPR that corresponds to the parity group to which the logical volume belongs, in the format **CLPR number:CLPRname**. For more information, see [“Working with CLPRs”](#) on page 152.
- **Parity group table boxes:** When you click a parity group, the table displays information about logical volumes in that parity group.

LDEV	Emulation	Capacity	Ave.(%)	Max.(%)
 0:08	OPEN-9	7.21GB	!10	!20
 0:09	OPEN-9	7.21GB	15	25
 0:0A	OPEN-9	7.21GB	0	0
 0:0B	OPEN-9	7.21GB	0	0
 0:0C	OPEN-9	7.21GB	0	0
 0:0D	OPEN-9	7.21GB	0	0
 0:0E	OPEN-9	7.21GB	0	0
 0:0F	OPEN-9	7.21GB	0	0

**Figure 224** Parity group table boxes

- **Icons:** A reserved volume () , which can be used as a migration destination; a normal volume () , which cannot be used as a migration destination; free space () ; and so forth.
- **LDEV:** Logical volume ID.
- **Emulation:** Emulation type of logical volume.



- **Capacity:** Capacity of logical volume.
- **Ave.:** Average usage rate for logical volume. If an exclamation mark (!) appears, the reported usage rate might be inaccurate.
- **Max.:** Maximum usage rate for logical volume. If an exclamation mark (!) appears, the reported usage rate might be inaccurate.
- **CLPR:** Number and name of the CLPR that corresponds to the parity group to which the logical volume belongs, in the format **CLPR number:CLPRname**. For more information about CLPRs, see “Working with CLPRs” on page 152
- **Owner:** Program that reserved the volume. If Auto LUN reserved this volume, **USP** is displayed. If another program reserved this volume, **Other[XX]** is displayed, where **[XX]** is the program ID. If this volume is not reserved and is a normal volume, a hyphen (-) is displayed.



## Reserving target volumes

To migrate volumes, you must reserve logical volumes as migration destinations (targets) regardless of the migration method (manual or automatic). Migration will not take place if no logical volume is reserved.



**NOTE:** The term *reserved volume* refers to a volume that is reserved for use as a migration destination. Reserved volumes are denoted by blue  icons. The term *normal volume* sometime refers to a volume that is not reserved as a migration destination.

1. In the Auto LUN pane, click **Physical**.
2. Click **Plan**. The Manual Migration tab appears.
3. Click **Attribute**. The Attribute tab appears.
4. In the Attribute tree, locate a logical volume to use as a migration destination. First click an HDD class to display a list of parity groups in that class. Next, click a parity group to display a list of logical volumes in that group.
5. In the table on the right, locate logical volumes preceded by the  or  icons. From those logical volumes, choose the logical volume, and right-click.
6. Click **Reserved LDEV**. The icon changes to .
7. Click **Apply**. The settings in the pane are applied to the disk array. The specified logical volume is reserved as a migration destination.

If you right-click a logical volume preceded by the  icon (reserved volume) and click **Normal LDEV**, the icon changes to , and you cannot use the volume as a migration destination. This procedure does not work when the logical volume is preceded by the green **Reserved** icon, which indicates another program reserved the volume.

## Setting (“fixing”) parity groups

The auto migration function excludes fixed parity groups. However, volumes in a “fixed” parity group can be used for manual migration operations.

1. In the Auto LUN pane, click **Physical**.
2. Click **Plan**. The Manual Migration tab appears.
3. Click **Attribute**. The Attribute tab appears.
4. In the tree, double-click an HDD class folder.

The table on the right displays a list of parity groups in the HDD class. An icon indicates parity groups that can include source or target volumes. A different icon indicates fixed parity groups, which cannot include source nor target volumes.

5. Right-click the parity group you want to fix.

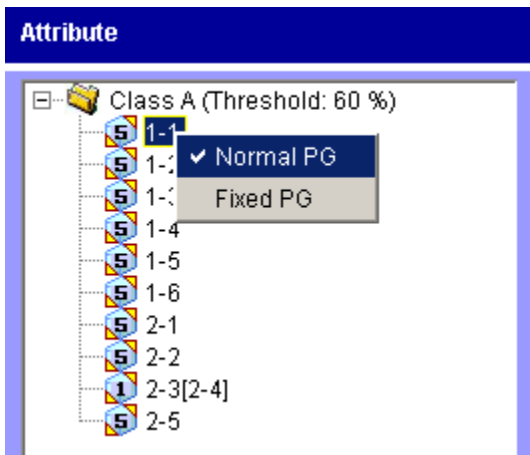

6. Click **Fixed PG**. The parity group becomes “fixed” and is marked with an icon.
7. Click **Apply**.

## Releasing (“unfixing”) parity groups

To move logical volumes in a fixed parity group to another parity group, change the fixed parity group to a “normal” parity group. To do this, go to the Attribute tab, right-click the fixed parity group, and click **Normal PG**.

## Changing maximum disk usage rates for HDD classes

Each HDD class has a default disk usage rate. This limit affects auto migration behavior. You can change the limit on disk usage rate.

1. In the Auto LUN pane, click **Physical**.
2. Click **Plan**. The Manual Migration tab appears.
3. Click **Attribute**. The Attribute tab appears.
4. In the Attribute tree, right-click an HDD class folder, and click **Change Class Threshold**. The Change Threshold pane appears.

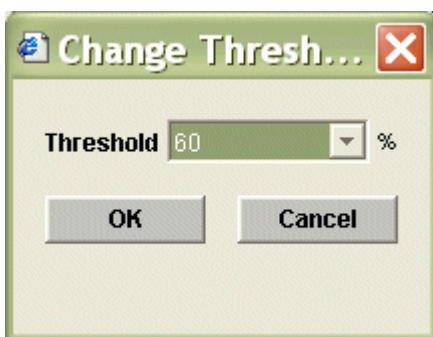

**Figure 225** Change Threshold pane

5. Click the value you want to use as the limit.
6. Click **OK**. In the Attribute tree, the selected value is displayed to the right of the specified class.
7. Click **Apply**. The new limit is applied to the disk array.



## History tab

Use this tab to display information about automatic and manual migration operations that occurred in the past. You can find out when migration operations took place and whether they finished successfully.

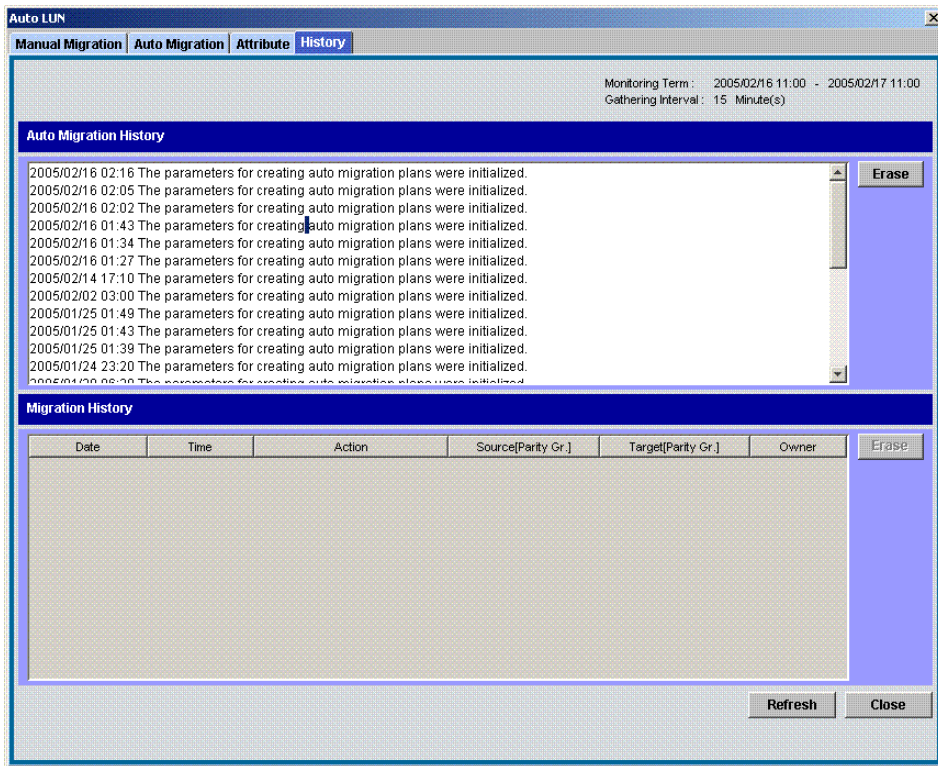

Figure 226 History tab

## Pane contents

This pane contains the following items:

- **Monitoring Term:** Displays the monitoring period specified in the Auto LUN pane, analyzes disk usage information collected by Auto LUN during the monitoring period, and calculates estimated usage rates of the source and target parity groups after a proposed volume migration.
- **Gathering Time:** Displays the time specified in the Auto LUN Monitoring Options pane. The disk array collects usage statistics about resources (such as hard disk drives) at the specified gathering time. Auto LUN uses the collected usage statistics to estimate usage rates of parity groups after a proposed volume migration.
- **Auto Migration History:** Displays log information, showing the creation and execution of auto migration plans. The **Erase** button erases the information.
- **Migration History:** Displays a log of volume migration events and a log or migration plan executed by programs other than Auto LUN. The table displays the following information:
  - **Date:** Event date
  - **Time:** Event time
  - **Action:** Description of migration operation or event
  - **Source[Parity PR.]:** Source volume and parity group
  - **Destination:** Target volume and parity group

- **Owner:** Program that reserved the volume. If Auto LUN reserved this volume, **USP** is displayed. If another program reserved this volume, **Other[XX]** is displayed, where **[XX]** is the program ID.
- **Refresh button:** Updates information in the **History** tab.
- **Close button:** Closes this pane.

## Viewing migration history logs

The History tab displays logs of automatic and manual migration operations.

1. In the Auto LUN pane, click **Physical**.
2. Click **Plan**. The Manual Migration tab appears.
3. Click the **History** tab. The History tab appears.

To view logs of auto migration operations, look at **Auto Migration History**.

To view logs of manual migration operations, look at **Migration History**.

The migration logs may display the following messages.

### **Normal end of migration:**

```
Migration Complete (CU:LDEV->CU:LDEV) Start:yyyy/mm/dd hh:min:sec -> End:yyyy/mm/dd
hh:min:sec
```

```
                (a)                (b)                (c)                (d)
```

(a) Source volume

(b) Target volume

(c) Copy start time

(d) Copy end time

### **Migration was canceled (over the limit duration):**

```
Migration Canceled (CU:LDEV->CU:LDEV) Start:yyyy/mm/dd hh:min:sec -> End:yyyy/mm/dd
hh:min:sec
```

```
                (a)                (b)                (c)                (d)
```

(a) Source volume

(b) Target volume

(c) Copy start time

(d) Copy end time

### **Migration was canceled (invalid parity group):**

```
Migration Canceled (CU:LDEV (X-X)->CU:LDEV (X-X)) yyyy/mm/dd hh:min:sec (Invalid Parity
Group)
```

```
                (a)                (b)                (c)                (d)                (e)
```

(a) Source volume

(b) Parity group of the source volume

(c) Target volume

(d) Parity group of the target volume

(e) Canceled time

**Migration was stopped (other reason):**

Migration Stopped (CU:LDEV->CU:LDEV) yyyy/mm/dd hh:min:sec (XXXXXXXXXXXX)

(a) (b) (c) (d)

(a) Source volume

(b) Target volume

(c) Canceled time

(d) Reason for cancellation:

- No reserve volume. No reserved volume is set. Please make another plan.
- Reserve volume emulation is different. The reserved volume's emulation type is different.
- Utilization check. The usage rate is over the limit, or there is no monitor data.
- Migration failed. Error code: XXXX. The migration operation failed.
- Reserve volume size is different. Reserve volume size is different.
- Reserve volume emulation is not supported. The emulation type of reserved volume is not supported.
- Utilization check failed. The check of the usage rate finished abnormally.
- Reserve volume check failed. The check of the reserved volume finished abnormally.

**Migration plan was deleted (because the previous plan had been deleted):**

Migration Plan deleted (CU:LDEV->CU:LDEV) yyyy/mm/dd hh:min:sec (Pre-Plan is deleted)

(a) (b) (c)

(a) Source volume

(b) Target volume

(c) Canceled time

**Started making an auto migration plan:**

yyyy/mm/dd hh:min : MakePlan function starts

(a)

(a) Start time

**Finished making an auto migration plan:**

yyyy/mm/dd hh:min : MakePlan function finishes

(a)

(a) End time

**Output the auto migration plans:**

X plans are output

(a)

(a) Number of plans

**Contents of auto migration plan:**

PlanXXX: Src LDEV CU:LDEV in Grp X-X, Dst LDEV CU:LDEV in Grp X-X

(a) (b) (c) (d) (e)

- (a) Plan number
- (b) Source volume
- (c) Parity group of the source volume
- (d) Target volume
- (e) Parity group of the target volume

**Failed making an auto migration plan:**

yyyy/mm/dd hh:min : MakePlan is terminated by error: XXXXXXXXXXXX

(a) (b)

- (a) End time
- (b) Reason for failure:
  - Cannot make proper migration plan: The program could not make a proper migration plan. Check the number of the reserved volumes and their locations. Check the maximum disk usage and change if necessary.
  - Failed to get XXXXXXXXXXXX (information or data): The program failed to get the information or data to make a plan. In the case of information, make the initial value again by selecting [Initialize]. In the case of data, check the status of gathered data and get them again.
  - Failed to write to XXXXXXXXXXXX (information or data): The program failed to write the information to make a plan.
  - Invalid XXXXXXXXXXXX (information or data): The required information/data could not be used because the information was invalid. In the case of information, make the initial value again by selecting [Initialize]. In the case of data, check the status of gathered data and get them again.
  - Memory allocation error: The program failed to allocate the memory to make the plan.
  - "C:\dkc200\others\Auto LUNatm.ini does not exist.": Auto LUN failed to make plans because the Auto LUN atm.ini file did not exist. Click the [Initialize] button before making plans again.

**Log entry that the auto migration plan could not be made:**

Cannot make plan: Class X Grp X-X

(a) (b)

- (a) Class
- (b) Parity group

**Some monitor data samples were invalidated:**

Grp X-X: X samples are invalidated because of migration.

**New volumes have been installed:**

New entries are added for following LDEVs: CU:LDEV, CU:LDEV, ...

**Invalid data:**

Too many invalid data: invalidated all data

**Volume utilization check failed:**

Utilization check failed

Check volume usage failed because the necessary data could not be obtained. Please get the data again.

**Volume reserve attribute check failed:**

Reserve volume check failed

Check volume reserve attribute failed because the necessary data could not be obtained. Please get the data again.

The migration logs may display the following messages:

**Table 76** Migration log messages (XP128/XP1024/XP12000)

Message	Meaning
Migration Start	Migration operation started
Migration Complete	Migration operation completed successfully
Migration Cancel	User canceled the migration operation
Migration Failed	Migration operation failed
Migration Give Up	Migration operation was canceled by Auto LUN (for example, volume usage rate exceeded specified maximum)

## Using Performance Control

### Starting Performance Control

1. In the Auto LUN pane, click **WWN** or **Port-LUN**.
2. Click the **PFC** button. The Performance Control pane appears.

### Performance Control pane

The Performance Control pane contains two tabs: **Port** and **WWN**.

- Use the **Port** tab to set the limit on performance of non-prioritized ports and set the threshold on performance of prioritized ports.

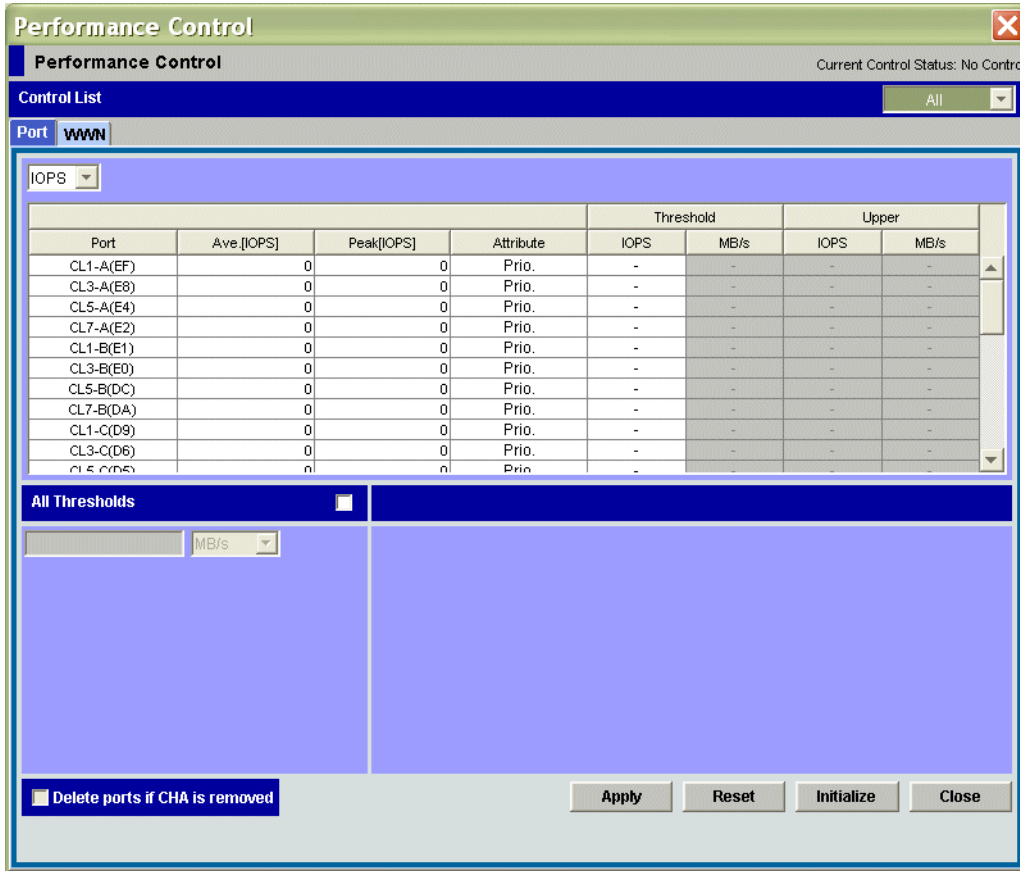
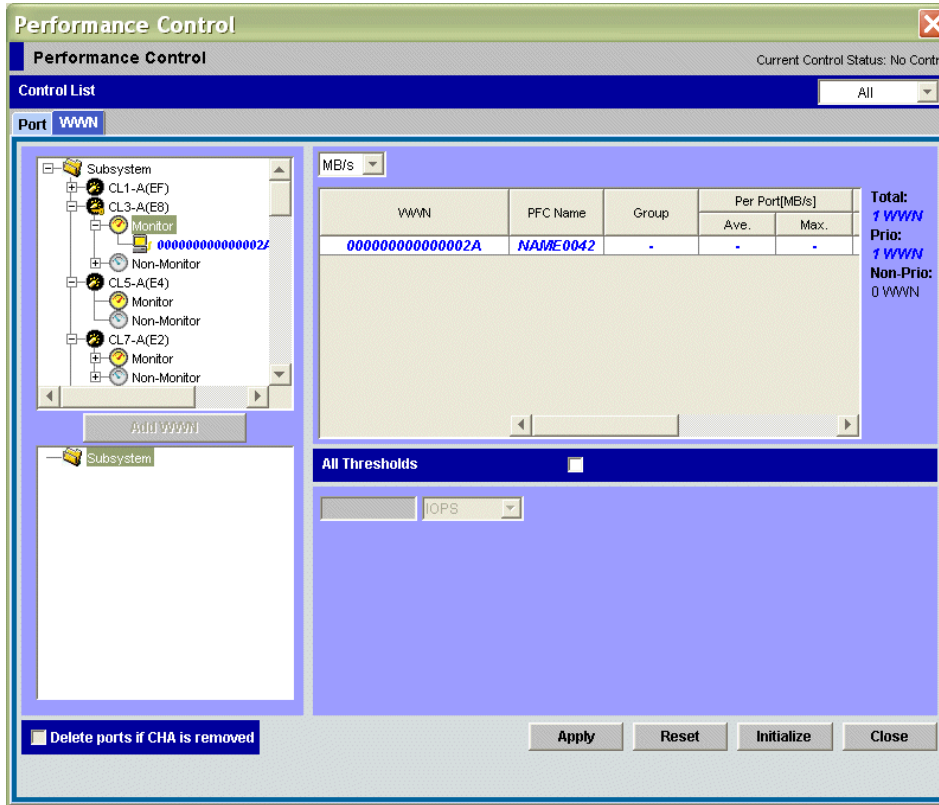

Figure 227 Port tab in the Performance Control pane

- Use the **WWN** tab to set the limit on performance of non-prioritized WWNs and set the threshold on performance of prioritized WWNs.



**Figure 228** WWN tab in the Performance Control pane

## Pane contents

The **Port** and **WWN** tabs contain several sections:

### Top section

- **Current Control Status** at the top of the pane displays one of the following values:
  - **Port Control**: System performance is controlled by the upper limits and threshold specified in the **Port** tab
  - **WWN Control**: System performance is controlled by the upper limits and threshold specified in the **WWN** tab
  - **No Control**: System performance is not controlled by Performance Control

If **WWN Control** is displayed when the **Port** tab is active, click **Apply** to switch control so that **Port Control** is displayed. Conversely, if **Port Control** is displayed when the **WWN** tab is active, click **Apply** to switch control so that **WWN Control** is displayed.

- Use **Control List** near the upper right corner of the tab to limit the number of ports or WWNs shown in the table:
  - **All**: Shows all the ports or WWNs
  - **Prio.**: Shows only prioritized ports or WWNs
  - **Non-Prio.**: Shows only non-prioritized ports or WWNs

If you change a port's settings, the port remains in the table regardless of the selection in the list.

## Tree section (WWN tab only)





- The tree in the upper-left of the **WWN** tab lists ports and host bus adaptors connected to the disk array's ports.
  - Icons representing ports on the disk array appear below the **Subsystem** folder.
  - If you double-click a port, the tree collapses to display two items: **Monitor** and **Non-Monitor**. The table on the right displays a list of host bus adapters that are connected to the specified port and can be monitored by Performance Control.
  - If you double-click **Monitor**, the tree view and table display a list of host bus adapters that are connected to the specified port and can be monitored by Performance Control.
  - If you double-click **Non-Monitor**, the tree view and table display a list of host bus adapters that are connected to the specified port and **cannot** be monitored by Performance Control.
  - If many-to-many connections are established between host bus adapters (HBAs) and disk array ports, ensure that all connected HBAs are displayed under **Monitor**.



**NOTE:** The list to the right of the tree changes depending on the item selected



**NOTE:** If a host bus adapter's WWN is displayed in red in the tree view, the host bus adapter is connected to two or more ports, but upper limits and/or thresholds do not control traffic between the HBA and some ports. If many-to-many connections are established between host bus adapters (HBAs) and disk array ports, ensure that all connected HBAs are monitored. For information about controlling the traffic between the HBA and connected ports, see "[Performance Monitor and Performance Control](#)" on page 411.

- The tree in the lower-left of the **WWN** tab lists *PFC groups* and host bus adapters (WWNs) in each PFC group.
  - PFC groups, which contain one or more WWNs, appear below the **Subsystem** folder. For details about PFC groups, see "[Grouping host bus adapters](#)" on page 408.
  - If you double-click a PFC group () , host bus adapters in the PFC group appear. WWNs and nicknames appear to the right of the host bus adapter icon (). WWNs uniquely identify host bus adapters. The system administrator can assign nicknames, so users can easily identify each host bus adapter.
- The **Add WWN** button between the trees adds a host bus adapter to a PFC group. Before using this button, select a host bus adapter () from the upper-left tree view and a PFC group () from the lower-left tree view.

## Table section

- Use the list at the top left of the tables to change the type of performance statistics displayed in the table:
  - **IOPS** (I/Os per second) displays I/O rates for ports or WWNs (host bus adapters). The I/O rate indicates number of I/Os per second.
  - **MB/s** (megabytes per second) displays transfer rates for ports. The transfer rate indicates amount of data transferred via a port in one second.
  - **100KB/s** (100 kilobytes per second) displays transfer rates for WWNs (host bus adapters). The transfer rate indicates amount of data transferred via a port in one second.



- The table displays a list of ports or WWNs and indicates the I/O or transfer rate for each. The measurement unit for the values in the table are specified by the list at the upper left corner of the tab. The table can display the following columns:
  - **Port:** In the **Port** tab, indicates ports on the disk array.
  - **Port:** In the **WWN** tab, indicates the port to which the HBA is connected.
  - **Group:** In the **WWN** tab, indicates the PFC group to which the host bus adapter belongs. This column appears when a port is selected in the upper-left tree view, and does not appear when a PFC group is selected in the lower-left tree view.
  - **Ave.:** Average I/O or transfer rate for the specified period.
  - **Max.:** Maximum I/O or transfer rate for the specified period.
  - **Attribute:** Priority of each port or WWN. **Prio.** indicates a prioritized port or WWN. **Non-Prio.** indicates a non-prioritized port or WWN.
  - **Threshold:** In the **Port** tab, specifies the threshold for I/O and transfer rates for each prioritized port. Use the **IOPS** column to specify the threshold for I/O rates. Use the **MB/s** column to specify the threshold for transfer rates. To specify a threshold, double-click a cell to display the cursor in the cell.
  - **Upper:** Specifies the upper limit on I/O and transfer rates for each non-prioritized port or WWN. Use the **IOPS** column to specify the upper limit for I/O rates. Use the **MB/s** column (or **100KB/s** column for WWN) to specify the upper limit for transfer rates. To specify an upper limit, double-click a cell to display the cursor in the cell.



**NOTE:** The **Upper** columns are not displayed in the WWN tab if a PFC group is selected in the lower-left tree view.

### Bottom section

- If you click the **All Thresholds** check box and enter a threshold value in the text box, the threshold value is applied to the entire disk array. To specify the threshold for I/O rates, select **IOPS** from the list on the right of the text box. To specify the threshold for transfer rates, select **MB/s** (or **100KB/s** in the **WWN** tab) from the list. For example, if you specify 128 IOPS in **All Thresholds**, the upper limits on non-prioritized ports are disabled when the sum of I/O rates for all the prioritized ports is below 128 IOPS.
- The **Delete ports if CHA is removed** check box deletes settings on ports in channel adapters that have been removed.

### Buttons

- **Apply:** Applies settings in this pane to the disk array.
- **Reset:** Restores original settings in the pane.
- **Initialize:** Changes settings in this pane as explained below, and applies the resulting settings to the disk array:
  - All ports or WWNs become prioritized ports or WWNs.
  - The threshold value for all ports in the **Port** tab becomes 0 (zero).



**NOTE:** The pane displays a hyphen (-) instead of 0 (zero).

- If you check the **All Thresholds** check box, the check mark disappears.
- **Close**: Closes the Performance Control pane.

## Managing traffic between HBAs and ports

If one-to-one connections are established between host bus adapters (HBAs) and disk array ports, use the **Port** tab in the Performance Control pane to measure and analyze traffic.

If many-to-many connections are established between host bus adapters (HBAs) and disk array ports, use the **WWN** tab in the Performance Control pane to measure and analyze traffic.

Use the **Port** and **WWN** tabs to perform the following functions:

- [“Measuring traffic between host bus adapters and ports for one-to-one connections”](#) on page 404
- [“Measuring traffic between host bus adapters and ports for many-to-many connections”](#) on page 404
- [“Analyzing traffic statistics”](#) on page 405
- [“Setting upper limit values for traffic at non-prioritized ports or WWNs”](#) on page 406
- [“Setting thresholds”](#) on page 407
- [“Changing PFC names of host bus adapters \(many-to-many connections only\)”](#) on page 407
- [“Replacing host bus adapters \(many-to-many connections only\)”](#) on page 408

## Measuring traffic between host bus adapters and ports for one-to-one connections

If a one-to-one connection is established between HBAs and ports, you must measure traffic between high-priority HBAs and prioritized ports and between low-priority HBAs and non-prioritized ports.

1. Start Performance Control ([“Starting Performance Control”](#) on page 399). The Performance Control pane appears.
2. Click **Port**.
3. Select **All** from the list at the top right corner of the pane.
4. Right-click a high-priority port, and select **Non-Prio. ->> Prioritized**. If there is more than one high-priority port, repeat this operation.  
**Prio.** is displayed in the **Attribute** column.
5. Right-click a low-priority port, and select **Prio. ->> Non-Prio.** If there is more than one low-priority port, repeat this operation.  
**Non-Prio.** is displayed in the **Attribute** column.
6. Click **Apply**. The settings on the pane are applied to the disk array.
7. Follow the instructions in [“Collecting usage statistics about disk array resources”](#) on page 372 to measure traffic (I/O and transfer rates).

## Measuring traffic between host bus adapters and ports for many-to-many connections

If a many-to-many connection is established between host bus adapters (HBAs) and ports, you must measure traffic between each HBA and the port to which the HBA is connected.

1. Start Performance Control ([“Starting Performance Control”](#) on page 399). The Performance Control pane appears.
2. Click **WWN**.
3. Select **All** from the list at the top right corner of the pane.

4. In the upper-left tree view, double-click a port.
5. Double-click **Non-Monitor** below the specified port. Host adapters that are not being monitored are displayed under **Non-Monitor**.
6. Right-click **Monitor**, and select **Add WWN** to display the Add WWN dialog box where you can add a prioritized or non-prioritized WWN to the **Monitor** branch.

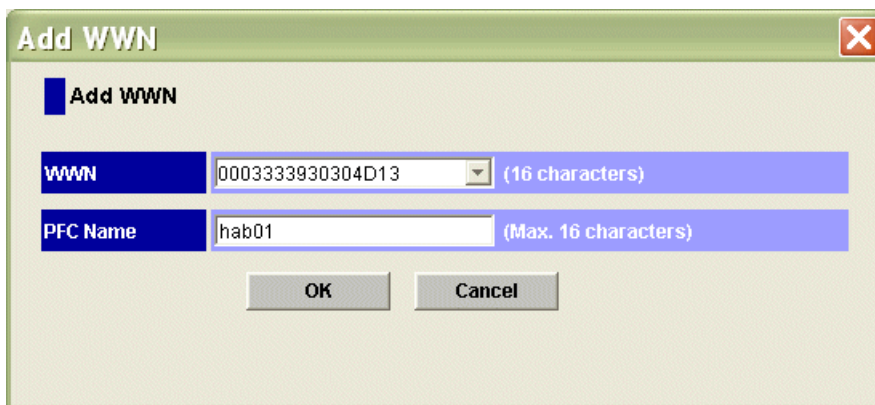

**Figure 229** Add WWN dialog box

7. Specify the WWN and PFC name (16-character maximum), and click **OK**. The specified WWN appears below **Monitor**.



**NOTE:** To simplify managing HBAs, use the same name for the PFC name and HBA nickname.



**NOTE:** Performance Control does not monitor HBAs below **Non-Monitor**. You cannot set upper limits and thresholds to HBAs that are not monitored. To move an HBA (WWN) from **Monitor** to **Non-Monitor**, select an HBA from below **Monitor**, right-click **Monitor**, and select **Delete WWN**. You can monitor up to 32 HBAs (WWNs) for each port.

8. Click **Monitor**. The table on the right lists HBAs that are displayed below **Monitor**.
9. Right-click a prioritized WWN, and select **Non-Prio. -> Prioritized**. If there is more than one high-priority port, repeat this operation.  
**Prio.** is displayed in the **Attribute** column.
10. Right-click a non-prioritized WWN, and select **Prio. -> Non-Prio.** If there is more than one non-prioritized WWN, repeat this operation.  
**Non-Prio.** is displayed in the **Attribute** column.
11. Repeat [step 4](#) - [step 10](#) for all ports except the one selected in [step 4](#).
12. Click **Apply** in the Performance Control pane. The settings on the pane are applied to the disk array.
13. Follow the instructions in "[Collecting usage statistics about disk array resources](#)" on page 372 to measure traffic (for example, I/O and transfer rates).

## Analyzing traffic statistics

With one-to-one connections, traffic statistics consist of the number of I/Os made via ports and the amount of data transferred via ports. Analyze traffic statistics to determine upper limit values that should be applied to I/O or transfer rates for non-prioritized ports.

With many-to-many connections, traffic statistics consist of the number of I/Os made via ports from HBAs and the amount of data transferred between ports and HBAs. Analyze traffic statistics to determine upper limit values that should be applied to I/O or transfer rates for low-priority HBAs.

The following is the procedure for using the Performance Control pane to analyze traffic statistics. Note that you can also use the Performance Monitor pane to analyze traffic statistics. Performance Monitor displays a line graph indicating traffic changes. (For details, see [“Viewing disk array port traffic statistics”](#) on page 382 for one-to-one connections, or [“Viewing HBA/port traffic statistics”](#) on page 383 for many-to-many connections.)

1. Start Performance Control ([“Starting Performance Control”](#) on page 399). The Performance Control pane appears.
2. Click **Port** (for a one-to-one connection) or **WWN** (for a many-to-many connection).
3. Select **All** from the list at the top right corner of the pane.
4. Do either of the following:
  - To analyze I/O rates, select **IOPS** from the list at the upper left corner of the table.
  - To analyze transfer rates, select **MB/s** in the **Port** tab or **100KB/s** in the **WWN** tab from the list at the upper left corner of the table.

The table displays traffic statistics (for example, I/O or transfer rates).

5. Analyze the information in the table, and determine upper limit values that should be applied to non-prioritized ports or WWNs. If necessary, determine threshold values that should be applied to prioritized ports or WWNs. For details, see [“Procedure for one-to-one connections between HBAs and ports”](#) on page 353 (for ports) or [Procedure for many-to-many connections between HBAs and ports](#), page 355 (for WWNs).

## Setting upper limit values for traffic at non-prioritized ports or WWNs

After analyzing traffic statistics about prioritized and non-prioritized ports and WWNs, you must set upper limit values to I/O or transfer rates. Upper limit values for I/O rates suppress the number of I/Os from low-priority host servers, which provides better performance for high-priority host servers. Upper limit values for transfer rates suppress the amount of data that should be transferred between the disk array and low-priority ports, which provides better performance for high-priority host servers.

1. Start Performance Control ([“Starting Performance Control”](#) on page 399). The Performance Control pane appears.
2. Click **Port** (for a one-to-one connection) or **WWN** (for a many-to-many connection).
3. Do either of the following:
  - To limit the I/O rate, select **IOPS** from the list at the upper left corner of the table.
  - To limit the transfer rate, select **MB/s** (or **100KB/s** for WWNs) from the list at the upper left corner of the table.
4. Locate the non-prioritized port or WWN.

The **Attribute** column indicates whether ports or WWNs are prioritized or non-prioritized. If you cannot find non-prioritized ports or WWNs, check the list at the top right corner of the pane. If it displays **Prioritize**, select **All** or **Non-Prioritize** from the list.
5. Do either of the following:
  - To limit the I/O rate, double-click the desired cell in the **IOPS** column in **Upper**, and enter the upper limit in the cell.
  - To limit the transfer rate, double-click the desired cell in the **MB/s** column (or **100KB/s** column for WWNs) in **Upper**, and enter the upper limit in the cell.

The upper limit value you entered is shown in blue.

6. Click **Apply**. The settings in the pane are applied to the disk array. The upper limit value you entered turns black.

## Setting thresholds

If threshold control is used, upper limit control is automatically disabled when traffic between production servers and the disk array is reduced to a specified level. For details, see [“Automatically disable upper limit control”](#) on page 352, and [“Procedure for one-to-one connections between HBAs and ports”](#) on page 353 (for one-to-one connections) or [“Procedure for many-to-many connections between HBAs and ports”](#) on page 355 (for many-to-many connections).

1. Start Performance Control ([“Starting Performance Control”](#) on page 399). The Performance Control pane appears.
2. Click **Port** (for one-to-one connection) or **WWN** (for many-to-many connection).
3. Do either of the following:
  - To disable the upper limit on I/O rates, select **IOPS** from the list at the upper left corner of the table.
  - To disable the upper limit on transfer rates, select **MB/s** (or **100KB/s** for WWNs) from the list at the upper left corner of the table.
4. To set a threshold for a WWN, skip to [step 7](#).
5. Do either of the following:
  - To set a threshold for a prioritized port, locate the desired prioritized port, which is indicated by **Prio.** in the **Attribute** column. Double-click the cell in the **IOPS** or **MB/s** column in **Threshold**, and enter the threshold value.



**CAUTION:** If you enter 0 (zero) in a cell, the cell displays a hyphen (-) and the threshold for the prioritized port becomes ineffective. If the threshold for any prioritized port is ineffective, threshold control will not be performed, but upper limit control will be performed.

- To set a threshold to the entire disk array, click the **All Thresholds** check box, enter the threshold value in the text box, and select **IOPS** or **MB/s** from the list in **All Thresholds**.
6. Skip to [step 10](#).
7. Select the **All Thresholds** check box.
8. Do either of the following:
  - To disable the upper limit on I/O rates, select **IOPS** from the list below the check box.
  - To disable the upper limit on transfer rates, select **100KB/s** from the list below the check box.
9. Enter the threshold in the text box.
10. Click **Apply**. The settings in the pane are applied to the disk array.

## Changing PFC names of host bus adapters (many-to-many connections only)

Use the Performance Control pane to assign a *PFC name* to a host bus adapter (HBA). Although you can identify HBAs by WWNs (Worldwide Names), you can identify HBAs more easily if you assign PFC names. WWNs are 16-digit hexadecimal numbers and cannot be changed. However, PFC names should not necessarily be 16-digit hexadecimal numbers and can be changed.

The following is the procedure for changing an existing PFC name. For details about assigning PFC names, see [“Measuring traffic between host bus adapters and ports for many-to-many connections”](#) on page 404.

1. Start Performance Control ("Starting Performance Control" on page 399). The Performance Control pane appears.
2. Click **WWN**.
3. In the upper-left tree view, click a host bus adapter (  ) from below the **Monitor** branch, and right-click the selection.
4. Select **Change WWN & PFC Name**. The Change WWN and PFC Name dialog box appears.

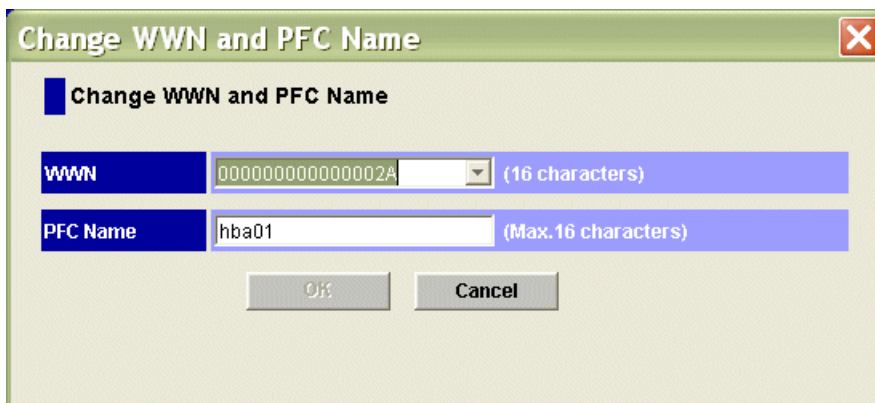

**Figure 230** Change WWN and PFC Name dialog box

5. Enter a new PFC name (up to eight characters) in the **PFC Name** box, and click **OK**.
6. In the Performance Control pane, click **Apply**. The settings in the pane are applied to the disk array.

## Replacing host bus adapters (many-to-many connections only)

If a host bus adapter fails, replace the adapter with a new one. After you finish the replacement, delete the old host bus adapter from the Performance Control pane, and register the new host bus adapter.

Use the following procedure to quickly and easily remove the old adapter and register a new one.

1. Start Performance Control ("Starting Performance Control" on page 399). The Performance Control pane appears.
2. Click **WWN**.
3. In the upper-left tree view, click the old host bus adapter (  ) below the **Monitor** branch, and right-click the selection.
4. Select **Change WWN & PFC Name**.

The Change WWN and PFC Name dialog box appears (Figure 230).

5. Enter the WWN of the new host bus adapter in the **WWN** box.
6. If necessary, enter a new PFC name (up to eight characters) in the **PFC Name** box.
7. Click **OK**.
8. In the Performance Control pane, click **Apply**.

The settings in the pane are applied to the disk array.

## Grouping host bus adapters

Use Performance Control to create a PFC group that contain multiple host bus adapters. All host bus adapters (HBAs) in one PFC group must be of the same priority. Prioritized WWNs (for example, high-priority HBAs) and non-prioritized WWNs (for example, low-priority HBAs) cannot be mixed in one PFC group.



You can use a PFC group to switch the priority of multiple HBAs from prioritized to non-prioritized, or vice versa. You can also use a PFC group to set the same upper limit value to all HBAs in the group.

## Adding multiple HBAs to a PFC group

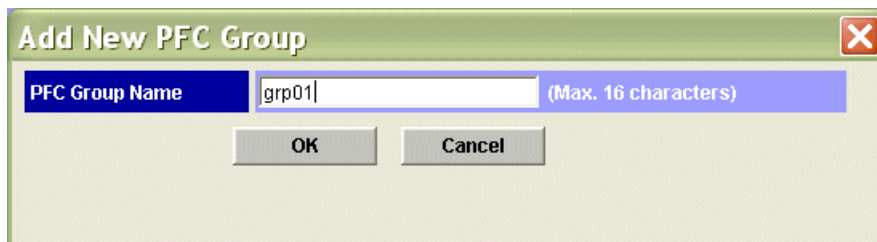
1. Start Performance Control ("Starting Performance Control" on page 399). The Performance Control pane appears.
2. Click **WWN**.
3. In the lower-left tree view, right-click the **Subsystem** folder.
4. Select **Add New PFC Group**. The **Add New PFC Group** dialog box appears.



**Figure 231** Add New PFC Group dialog box

5. Enter the name of the PFC group, and click **OK**.  
A PFC group is created and a PFC group icon () is added to the lower-left tree view.
6. Select an HBA () from the upper-left tree view, and select a PFC group from the lower-left tree view. Click **Add WWN**.  
Repeat this operation until all desired HBAs are added to the PFC group.



**NOTE:** Select a host bus adapter from below the **Monitor** branch. You cannot add HBAs from below the **Non-Monitor** branch to PFC groups.

7. Click **Apply**. The settings are applied to the disk array.

## Switching the priority of PFC groups

All host bus adapters (HBAs) in one PFC group must have the same priority. Prioritized WWNs (for example, high-priority HBAs) and non-prioritized WWNs (for example, low-priority HBAs) cannot be mixed in a given PFC group.

Use a PFC group to switch the priority of several HBAs from prioritized to non-prioritized, or vice versa.

1. Start Performance Control ("Starting Performance Control" on page 399). The Performance Control pane appears.
2. Click **WWN**.
3. In the lower-left tree view, right-click a PFC group () .
4. Do either of the following:
  - To switch the priority from prioritized to non-prioritized, select **Prio. ->> Non-Prio.**
  - To switch the priority from non-prioritized to prioritized, select **Non-Prio. ->> Prioritized.**
5. Click **Apply**. The settings in the pane are applied to the disk array.

## Setting upper limit values for HBAs in a PFC group

If all host bus adapters in a PFC group are non-prioritized WWNs (for example, low-priority HBAs), set an upper limit value to HBA performance (I/O or transfer rate). You can assign one upper limit value for each PFC group.



For example, suppose the upper limit value **100 IOPS** is assigned to a PFC group consisting of four host bus adapters. If the sum of the I/O rate of the four HBAs reaches 100 IOPS, Performance Control controls the system so that the sum of the I/O rates does not exceed 100 IOPS.

1. Start Performance Control ("[Starting Performance Control](#)" on page 399). The Performance Control pane appears.
2. Click **WWN**.
3. In the lower-left tree view, click the **Subsystem** folder or PFC group (  ).
4. If you selected the **Subsystem** folder, take the following steps:
  - a. Select **IOPS** or **100KB/s (MB/s on XP12000)** from the list at the upper-left corner of the table. **IOPS** assigns an upper limit to the I/O rate. **100KB/s** assigns an upper limit to the transfer rate.
  - b. To assign an upper limit to the I/O rate, enter the upper limit value in the **IOPS** column. To assign an upper limit to the transfer rate, enter the upper limit value in the **100KB/s** column.



**NOTE:** If you cannot see the IOPS or 100KB/s column, scroll to the left. The column is located at the right side of the table.

If you selected a PFC group, take the following steps:

- a. Right-click the selected PFC group, and select **Change Upper Limit**. The **Change Upper Limit** dialog box appears.

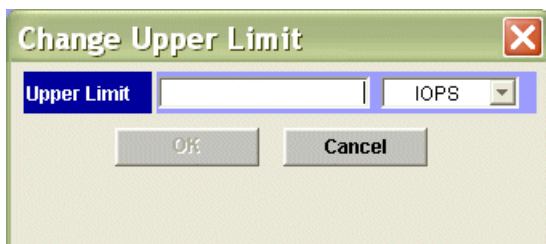

**Figure 232** Change Upper Limit dialog box

- b. To assign an upper limit to the I/O rate, enter the upper limit value, select **IOPS** from the list, and click **OK**.  
To assign an upper limit to the transfer rate, enter the upper limit value, select **100KB/s** from the list, and click **OK**.

5. In the Performance Control pane, click **Apply**. The settings are applied to the disk array.

## Renaming PFC groups

1. Start Performance Control ("[Starting Performance Control](#)" on page 399). The Performance Control pane appears.
2. Click **WWN**.
3. In the lower-left tree view, right-click a PFC group (  ).



4. Select **Change Name**. The **Change PFC Group Name** dialog box appears.

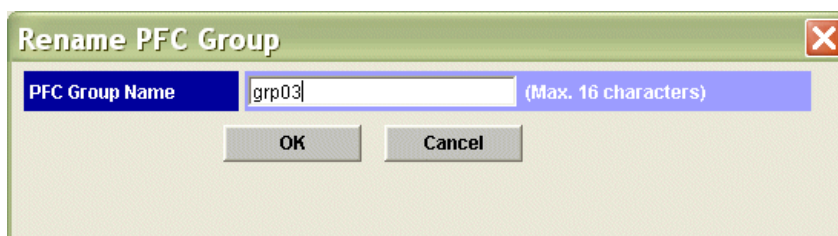

**Figure 233** Change PFC Group Name dialog box

5. Enter the new name, and click **OK**.
6. In the Performance Control pane, click **Apply**. The settings are applied to the disk array.

## Deleting PFC groups

1. Start Performance Control ("Starting Performance Control" on page 399). The Performance Control pane appears.
2. Click **WWN**.
3. In the lower-left tree view, right-click a PFC group (  ).
4. Select **Delete**.
5. In the Performance Control pane, click **Apply**. The settings in the pane are applied to the disk array.

---

# Troubleshooting

## Performance Monitor and Performance Control

If the WWN of a host bus adapter is displayed in red in the WWN tree view, the host bus adapter is connected to two or more ports, but Performance Control does not control traffic between the HBA and some ports. To control traffic between the HBA and all connected ports, take the following steps:

1. Start Performance Control, and ensure that the **WWN** tab is displayed.
2. In the upper-left tree view, double-click all ports to which the HBA is connected.
3. Double-click all **Monitor** and **Non-Monitor** entries that appear below the specified ports.
4. If you find HBAs below the **Non-Monitor** entries, drag them to **Monitor**.
5. Ensure that the HBA appears below each of the **Monitor** entries, and click **Apply**.

While displaying Performance Monitor in short range, if I/O workloads between hosts and the disk array become heavy, the disk array gives higher priority to I/O processing than monitoring processing; therefore, some monitoring data might be missing. If monitoring data is missing frequently, use the **Gathering Interval** option in the Monitoring Options pane to increase the collection interval.

The display on the **LDEV**, **Port-LUN**, and **WWN** tabs is fixed to in short range.

## Auto LUN XP

Auto LUN displays error messages on the Command View computer when error conditions occur during Auto LUN operations.

If you need to contact your HP account support representative, provide as much information about the problem as possible, including the error codes.



---

## 23 Business Copy (BC) for the XP128/XP1024/XP12000

Business Copy (BC) maintains internal copies of user data on disk arrays for purposes such as data backup or duplication. Duplicate volumes are created on the same disk array as the primary volume at hardware speeds. BC is used for UNIX and PC server data, and can provide up to nine duplicates of one primary volume.

This chapter provides instructions for performing BC operations using Command View. BC operations are nondisruptive and allow the primary (main) volume of each volume pair to remain online to all hosts for read and write I/O operations.

After establishing operations, BC operations continue unattended to provide asynchronous internal data backup. Usability is further enhanced through a resynchronization capability that reduces data duplication requirements and backup time, thereby increasing user productivity. BC also supports reverse resynchronization.

You can perform BC operations with Continuous Access (CA) operations to provide additional remote copies of BC volumes. BC also supports the disk array's VSC and Cache LUN features, ensuring that BC operations can duplicate all user data. See "[Combining BC with other data management operations](#)" on page 446 for further information on combining BC with other data management features.

You can also perform BC operations with External Storage XP operations to create pairs with external volumes.

---

### Overview of BC operations

BC is a storage-based hardware solution for duplicating logical volumes that reduces backup time and provides point-in-time backup. BC primary volumes (P-VOLs) contain original data; BC secondary volumes (S-VOLs) contain duplicate data. You can use the BC cascaded volume function to make up to nine copies of each P-VOL. Because each S-VOL is paired with its P-VOL independently, each S-VOL can be maintained as an independent copy set that can be split, resynchronized, and deleted separately from other S-VOLs assigned to the same P-VOL.

### BC components

BC operations on the Command View management station involve primary and secondary volumes in the disk array. [Figure 234](#) shows a typical BC configuration. BC system components are:

- "[BC volume pairs \(P-VOLs and S-VOLs\)](#)" on page 414

- "BC software on Command View management station" on page 415

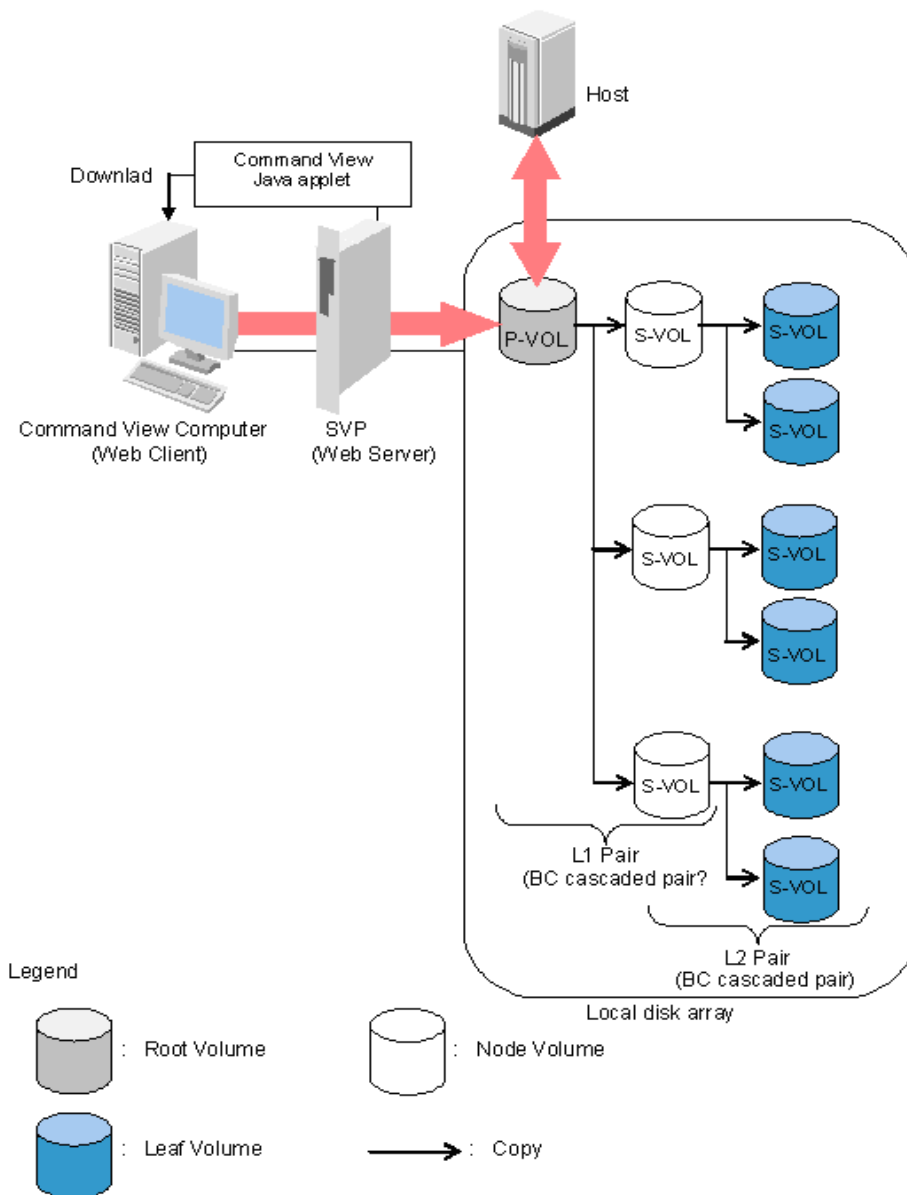

**Figure 234** BC overview

Use BC from the Command View management station to copy volumes in the local disk array. The volume that has original data is called a P-VOL (primary volume), and a volume to which data is copied is called an S-VOL (secondary volume). Pairs of P-VOLs and S-VOLs made by BC are called BC pairs. You can specify an S-VOL as a P-VOL to make another two BC pairs. As a result, you can use BC to make a total of nine S-VOLs. Use the cascade style to make BC pairs by specifying S-VOLs as P-VOLs. In cascade style, pairs in the first cascade layer are called L1 pairs and pairs in the second cascade layer are called L2 pairs.

## BC volume pairs (P-VOLs and S-VOLs)

Disk arrays contain and manage original and copied BC data. The XP128/XP1024 disk arrays support a maximum of 8,190 BC volumes: 4,095 pairs and the RAID Manager command device. The XP12000 disk array supports a maximum of 16,382 BC volumes (8,191 pairs: 8,191 P-VOLs and 8,191 S-VOLs). When BC pairs include size-expanded LUs, the maximum number of pairs decreases. When pairs include more than one S-VOL, the maximum number of P-VOLs decreases.

BC performs internal copy operations for logical volume pairs that you establish. Each BC pair consists of one primary volume (P-VOL) and up to three secondary volumes (S-VOLs) located in the same disk array. BC P-VOLs are primary volumes containing original data. BC S-VOLs are secondary or mirrored volumes containing backup data. Each S-VOL must be paired with only one P-VOL. During BC operations, P-VOLs remain available to all hosts for read and write I/O operations (except during reverse resync and quick restore). S-VOLs become available for host access only after the pair is split.

When a BC volume pair is created, data on the P-VOL is copied to the S-VOL to synchronize the volumes. During this initial copy operation and after the pair is synchronized, all write operations to the S-VOL are prohibited. To access an S-VOL, you can “split” the pair to make the S-VOL accessible (the P-VOL is accessible except during reverse resync). While a BC pair is split, the disk array keeps track of all changes to the P-VOL and S-VOL. When you “resync” the pair, the differential data in the P-VOL (due to P-VOL and S-VOL updates) is copied to the S-VOL, so the S-VOL is again identical to the P-VOL. For reverse resync, the differential data in the S-VOL (due to P-VOL and S-VOL updates) is copied to the P-VOL, so the P-VOL is now identical to the S-VOL.



**NOTE:** BC S-VOLs are updated asynchronously. For a volume pair with PAIR status, the P-VOL and S-VOL may not be identical. For further information on BC update copy operations, see “[Paircreate operation](#)” on page 425.

BC P-VOLs or S-VOLs should not be concentrated in the same RAID group. To disperse workloads of RAID groups, each RAID group should have both P-VOLs and S-VOLs evenly distributed. BC pairs for which BC operations are performed simultaneously should be in different RAID groups. If BC pairs are concentrated in only a few RAID groups, host I/O performance may be degraded.

---

If the disk array is overloaded, increase cache, disk adapters, and/or RAID groups. Consider assigning BC S-VOLs in newly installed RAID groups. If you continue BC operations with an overloaded disk array, host I/O performance may be degraded.

## Cascade pairs

The BC cascade function adds a second layer of pairs onto the first layer of original BC pairs. Use these two layers of pairs (L1 and L2) to create and maintain up to nine copies of one original BC primary volume (P-VOL). See “[Cascade function](#)” on page 436 for further information on the cascade function.

## BC software on Command View management station

When installed on the Command View management station, the BC software displays BC information and performs BC operations. The Command View management station can be attached to multiple disk arrays. The Command View management station acquires status from and issues commands to BC P-VOLs and S-VOLs.

# BC requirements for XP128/1024

BC operations provide disk array-internal copies of UNIX/PC server volumes (LUs) on the disk array. [Table 77](#) describes operational requirements for the use of BC.

**Table 77** BC operational requirements for XP128/1024

Parameter	Requirement
Pair objects	<p>Logical devices (LDEVs): OPEN-x (such as OPEN-3, OPEN-9, OPEN-E, or OPEN-V), including custom-size devices and size-expanded LUs. Devices must be installed and configured. The P-VOL and S-VOL must be the same type (for example, OPEN-3 to OPEN-3 is allowed, OPEN-3 to OPEN-9 is not allowed).</p> <p>A custom-size/expanded P-VOL must be paired with S-VOLs of the same type and capacity. A LUSE P-VOL must be paired with S-VOLs of the same size and structure. For example, if a LUSE P-VOL is connected to volumes of 1GB, 2GB, and 3GB in this order, you must specify the LUSE volume that has exactly the same size and connection order as the S-VOL. BC does not support multiplatform devices (for example, 3390-3A, -3B, or -3C). Volumes that are specified as Continuous Access XP - Journal (CA Journaling) data volumes or journal volumes cannot be specified as P-VOLs or S-VOLs. Contact your HP account team for the latest information about supported device types.</p>
Number of copies	<p>Maximum of three copies (S-VOLs) per primary volume (P-VOL). Maximum of one P-VOL per S-VOL (P-VOLs cannot share an S-VOL).</p> <p>An additional six copies can be created by using the BC cascade function.</p>
Maximum number of pairs <sup>1</sup>	The total number of BC, ShadowImage (SI390), ShadowImage - FlashCopy, Auto LUN, and Flex Copy (or Flex Copy V2) volume pairs. For details, see <a href="#">"Maximum number of pairs for XP128/1024" on page 417</a> .
Maximum number of S-VOLs	4,095
MU numbers of cascade pairs	<p>L1 pairs = 0, 1, and 2 (total of 3 pairs)</p> <p>L2 pairs = 1 and 2 (total of 2 pairs)</p>
Combinations of RAID levels (primary- secondary)	All combinations supported: RAID1-RAID1, RAID5-RAID5, RAID1-RAID5, and RAID5-RAID1.
Dynamic sparing and automatic correction copy	If a failure occurs requiring the disk array to utilize dynamic sparing or automatic correction copy, the status of the paired volumes associated with the failed physical device is not affected.
Physical device (PDEV) maintenance	If a PDEV requires maintenance, the status of the logical volumes associated with that PDEV is not affected. However, if PDEV maintenance requires access to a BC S-VOL, the pair must be deleted, and the <b>Reserve</b> attribute must be reset (unreserved).
Logical device (LDEV) maintenance	LDEV maintenance cannot be performed on LDEVs assigned to BC pairs. If LDEV maintenance requires access to a BC LDEV, the pair must be deleted, and the <b>Reserve</b> attribute must be reset (unreserved).
Cache maintenance	If disk array cache maintenance is performed during a period of high I/O usage, one or more BC pairs may be suspended. Reduce the I/O load before cache maintenance.

**Table 77** BC operational requirements for XP128/1024 (continued)

Parameter	Requirement
Point-in-time backup	For pairs in PAIR status, host I/Os are copied to S-VOLs asynchronously. To synchronize a pair and access the S-VOL as soon as possible, vary the P-VOL offline and split the pair before using the S-VOL. If the P-VOL cannot be taken offline, a P.I.T. backup still occurs if a pairsplit is issued. When all data on the P-VOL (up to the pairsplit time) is copied to the S-VOL, the pair is split and the S-VOL becomes available for use (R/W). The operation may take longer to complete if high write activity from the host to the P-VOL is occurring. A P.I.T. backup can also be performed by issuing a pairsplit to P-VOLs in the SMPL (simplex) state.
Failures	When a failure of any kind prevents a BC copy operation from completing, the disk array suspends the pair. If an LDEV failure occurs, the disk array suspends the pair. If a PDEV failure occurs, the BC pair status is not affected because of the RAID architecture.
Maintenance/ upgrade	Under certain conditions, BC volume pairs may need to be re-established.

1. Maximum number of pairs per disk array depends on installed firmware version.

## Maximum number of pairs for XP128/1024

The number of copy pairs BC can create is the difference between total number of available resources and number of resources already used to create pairs by ShadowImage (SI390), ShadowImage - FlashCopy, Auto LUN, and Flex Copy (or Flex Copy V2). The maximum is 4,096 pairs. However, when a high-capacity LU is used to create pairs, the number of pairs that can be created may be less than 4,096.

This section describes how to calculate the number of resources used by ShadowImage (SI390), ShadowImage - FlashCopy, Auto LUN, and Flex Copy (or Flex Copy V2).

The number of pairs you can create depends on the emulation type and capacity of paired volumes. [Table 78](#) on page 418 shows the number of pairs you can create for volumes of each emulation type and capacity.

When volumes with different emulation types and capacities are paired, the number of pairs you can create is determined according to the following conditions.

- If an LU consists of one volume (when LUSE is not used):

The maximum number of pairs you can create is the largest number that meets the equation,  $\Sigma(\alpha) \leq (\beta)$ , where:

$\Sigma(\alpha)$  is total number of differential tables per pair

$(\beta)$  is number of differential tables in the disk array

$(\beta) = 2,048$  when number of CUs is equal to or less than 4

$(\beta) = 4,096$  when number of CUs is equal to or more than 5

For example, if you create 10 pairs of OPEN-3 volumes and 20 pairs of OPEN-V (60 GB) volumes, the total number of differential tables per pair,  $\Sigma(\alpha)$ , is  $(1 \times 10) + (7 \times 20) = 150$ .

Because 150 is smaller than 2,048 (when number of CUs is equal to or less than 4) or 4,096 (when number of CUs is equal to or more than 5), it meets the equation,  $\Sigma(\alpha) \leq (\beta)$ , ensuring that 10 pairs of OPEN-3 volumes and 20 pairs of OPEN-V (60 GB) volumes can be created.

- If an LU consists of more than one volume (when LUSE volumes are used):

The maximum number of pairs you can create is the largest number that meets the equation,  $[\Sigma(\alpha) \times (\text{number of volumes that configure a LUSE volume})]$  is less than  $(\beta)$ , where:

$\Sigma(\alpha)$  is total number of differential tables per pair

$(\beta)$  is number of differential tables in the disk array

$(\beta) = 2,048$  when number of CUs is equal to or less than 4

$(\beta) = 4,096$  when number of CUs is equal to or more than 5

For example, if you create 10 pairs of LUSE volumes consisting of three OPEN-3 volumes and 20 pairs of LUSE volumes consisting of five OPEN-V (60 GB) volumes,  $[\Sigma(\alpha) \times (\text{number of volumes that configure a LUSE volume})]$  is  $(1 \times 3 \times 10) + (7 \times 5 \times 20) = 730$ .

Because 730 is smaller than 2,048 (when number of CUs is equal to or less than 4) or 4,096 (when number of CUs is equal to or more than 5), it meets the equation,  $[\Sigma(\alpha) \times (\text{number of volumes that configure a LUSE volume})]$  is less than  $(\beta)$ , ensuring that 10 pairs of OPEN-3 volumes and 20 pairs of OPEN-V (60GB) volumes can be created.

The maximum number of pairs you can create is limited to the number of volumes installed.

**Table 78** Number of pairs that can be created with volumes of each emulation type and capacity

Volume			No. of differential tables per pair needed for controlling the difference between the primary and secondary volumes	No. of pairs that can be created (If the volumes of the same emulation type and capacity are used to create all the pairs)	
No.	Emulation Type	Capacity		CUs is 4 or less	CUs is 5 or more
1	OPEN-3	Does not depend on capacity	1	2,047	4,095
2	OPEN-8	Does not depend on capacity	1	2,047	4,095
3	OPEN-9	Does not depend on capacity	1	2,047	4,095
4	OPEN-E	7.2 GB or less	1	2,047	4,095
5		7.3 GB or more	2	1,024	2,048
6	OPEN-L	7.2 GB or less	1	2,047	4,095
7		7.3 GB – 14.4 GB	2	1,024	2,048
8		14.5 GB – 21.6 GB	3	682	1,365
9		21.7 GB – 28.9 GB	4	512	1,024
10		29.0 GB or more	5	409	819



**Table 78** Number of pairs that can be created with volumes of each emulation type and capacity

Volume			No. of differential tables per pair needed for controlling the difference between the primary and secondary volumes	No. of pairs that can be created (If the volumes of the same emulation type and capacity are used to create all the pairs)	
No.	Emulation Type	Capacity		CUs is 4 or less	CUs is 5 or more
11	OPEN-V	9.6 GB or less	1	2,047	4,095
12		9.7 GB – 19.1 GB	2	1,024	2,048
13		19.2 GB – 28.8 GB	3	682	1,365
14		28.9 GB – 38.5 GB	4	512	1,024
15		38.6 GB– 48.1 GB	5	409	819
16		48.2 GB– 57.8 GB	6	341	682
17		57.9 GB or more	7	292	585

## BC requirements for XP12000

BC operations provide disk array-internal copies of UNIX/PC server volumes (LUs) on the disk array. The following table describes the operational requirements for BC.

**Table 79** BC operational requirements for XP12000

Parameter	Requirement
Pair objects	<p>Logical devices (LDEVs): OPEN-x (such as OPEN-3, OPEN-9, OPEN-E, and OPEN-V), including custom-size devices and size-expanded LUs. Devices must be installed and configured. The P-VOL and S-VOL must be the same type (for example, OPEN-3 to OPEN-3 is allowed, OPEN-3 to OPEN-9 is not allowed). A custom size/expanded P-VOL must be paired with S-VOLs of the same type and capacity. BC does not support multiplatform devices (for example, 3390-3A, -3B, -3C).</p> <p>BC operations can also be performed with External Storage XP operations to create pairs, using the external volumes as BC S-VOLs (or mirroring volumes) under the same conditions applied to the volumes in the local subsystem.</p>
Number of copies	<p>Maximum of three copies (S-VOLs) per primary volume (P-VOL). Maximum of one P-VOL per S-VOL (P-VOLs cannot share an S-VOL).</p> <p>An additional six copies can be created by using the BC cascade function.</p>
Maximum number of pairs <sup>1</sup>	<p>A maximum of 8,191 pairs (8,191 P-VOLs and 8,191 S-VOLs) can be created per disk array. The maximum number of pairs equals the total number of BC, ShadowImage for z/OS, Hitachi FlashCopy mirroring, Auto LUN XP, and Cross-system Copy volume pairs. For details, see <a href="#">“Maximum number of pairs for XP128/1024” on page 417</a>.</p>
Maximum number of S-VOLs	<p>8,191. See <a href="#">“Maximum number of pairs for XP128/1024” on page 417</a> for more information.</p>

**Table 79** BC operational requirements for XP12000 (continued)

Parameter	Requirement
MU numbers of cascade pairs	L1 pairs = 0, 1, and 2 (a total of 3 pairs) L2 pairs = 1 and 2 (a total of 2 pairs)
Combinations of RAID levels (primary-secondary)	All combinations supported: RAID1-RAID1, RAID5-RAID5, RAID1-RAID5, and RAID5-RAID1.
Dynamic sparing and automatic correction copy	If a failure occurs requiring the disk array to utilize dynamic sparing or automatic correction copy, the status of the paired volumes associated with the failed physical device is not affected.
Physical device (PDEV) maintenance	If a PDEV requires maintenance, the status of the logical volumes associated with that PDEV is not affected. However, if PDEV maintenance requires access to a BC S-VOL, the pair must be deleted, and the <b>Reserve</b> attribute must be reset (unreserved).
Logical device (LDEV) maintenance	LDEV maintenance cannot be performed on LDEVs that are assigned to BC pairs. If LDEV maintenance requires access to a BC LDEV, the pair must be deleted, and the <b>Reserve</b> attribute must be reset (unreserved).
Cache maintenance	If disk array cache maintenance is performed during a period of high I/O usage, one or more BC pairs may be suspended. Reduce the I/O load before cache maintenance.
Point-in-time backup	For pairs in PAIR status, host I/Os are copied to S-VOLs asynchronously. To synchronize a pair and access the S-VOL as soon as possible, vary the P-VOL offline and split the pair before using the S-VOL. If the P-VOL cannot be taken offline, a P.I.T. backup still occurs if a pairsplit is issued. When all data on the P-VOL (up to the pairsplit time) is copied to the S-VOL, the pair is split and the S-VOL becomes available for use (R/W). The operation may take longer to complete if high write activity from the host to the P-VOL is occurring. A P.I.T. backup can also be performed by issuing a pairsplit to P-VOLs in the SMPL (simplex) state.
Failures	When a failure of any kind prevents a BC copy operation from completing, the disk array suspends the pair. If an LDEV failure occurs, the disk array suspends the pair. If a PDEV failure occurs, BC pair status is not affected because of the RAID architecture.
Maintenance/upgrade	Under certain conditions, BC volume pairs may need to be re-established.

1. Maximum number of pairs per disk array depends on installed firmware version.

## Maximum number of pairs for XP12000

The number of pairs you can create depends on the following conditions.

- How much shared memory is available for differential tables.

The number of differential tables you can use is determined by whether additional shared memory for differential tables is installed.

- You can use 13,652 differential tables if no additional shared memory for differential tables is installed.
- You can use 30,718 differential tables if additional shared memory for differential tables is installed.



**NOTE:** The maximum number of pairs you can create is 8,192 and does not change, no matter how much shared memory for differential tables is available. If a command device is installed, the maximum number of pairs you can create is 8,191 (when configuring pairs of 1 P-VOL: 1 S-VOL ratio), and the maximum number of volumes you can use for creating pairs decreases to 16,383.

- Emulation type of each volume used to create a pair.
- Capacity of each volume used to create a pair.

Table 80 shows the relationship between emulation type, capacity, and differential tables. Table 81 shows the number of differential tables used in OPEN-V.

**Table 80** Relationship between emulation type, capacity, and differential tables

Emulation Type	Capacity (1 GB = 1024 <sup>3</sup> Byte)	Differential Tables per Pair
OPEN-3	Does not depend on capacity	1
OPEN-9	Up to 2.7GB	1
	Up to 5.5GB	2
	Up to 6.8GB	3
OPEN-E	Up to 2.7GB	1
	Up to 5.5GB	2
	Up to 8.4GB	3
	Up to 11.2GB	4
	Up to 13.5GB	5
OPEN-L	33.9GB	13
OPEN-V	See Table 81	

**Table 81** Number of differential tables used in OPEN-V

Capacity <sup>1</sup>	Differential Tables	Capacity <sup>1</sup>	Differential Tables	Capacity <sup>1</sup>	Differential Tables
Up to 14.9GB	1	Up to 493.9GB	33	Up to 972.9GB	65
Up to 29.9GB	2	Up to 508.9GB	34	Up to 987.9GB	66
Up to 44.9GB	3	Up to 523.9GB	35	Up to 1,002.8GB	67
Up to 59.8GB	4	Up to 538.8GB	36	Up to 1,017.8GB	68
Up to 74.8GB	5	Up to 553.8GB	37	Up to 1,032.8GB	69
Up to 89.8GB	6	Up to 568.8GB	38	Up to 1,047.8GB	70
Up to 104.7GB	7	Up to 583.7GB	39	Up to 1,062.7GB	71

**Table 81** Number of differential tables used in OPEN-V (continued)

Capacity <sup>1</sup>	Differential Tables	Capacity <sup>1</sup>	Differential Tables	Capacity <sup>1</sup>	Differential Tables
Up to 119.7GB	8	Up to 598.7GB	40	Up to 1,077.7GB	72
Up to 134.7GB	9	Up to 613.7GB	41	Up to 1,092.7GB	73
Up to 149.6GB	10	Up to 628.7GB	42	Up to 1,107.6GB	74
Up to 164.6GB	11	Up to 643.6GB	43	Up to 1,122.6GB	75
Up to 179.6GB	12	Up to 658.6GB	44	Up to 1,137.6GB	76
Up to 194.5GB	13	Up to 673.5GB	45	Up to 1,152.5GB	77
Up to 209.5GB	14	Up to 688.6GB	46	Up to 1,167.6GB	78
Up to 224.5GB	15	Up to 703.5GB	47	Up to 1,182.5GB	79
Up to 239.4GB	16	Up to 718.4GB	48	Up to 1,197.4GB	80
Up to 254.4GB	17	Up to 733.4GB	49	Up to 1,212.4GB	81
Up to 269.4GB	18	Up to 748.4GB	50	Up to 1,227.4GB	82
Up to 284.3GB	19	Up to 763.4GB	51	Up to 1,242.5GB	83
Up to 299.3GB	20	Up to 778.3GB	52	Up to 1,257.3GB	84
Up to 314.3GB	21	Up to 793.3GB	53	Up to 1,272.3GB	85
Up to 329.3GB	22	Up to 803.3GB	54	Up to 1,287.3GB	86
Up to 344.2GB	23	Up to 823.2GB	55	Up to 1,302.2GB	87
Up to 359.2GB	24	Up to 838.2GB	56	Up to 1,317.2GB	88
Up to 374.2GB	25	Up to 853.2GB	57	Up to 1,332.2GB	89
Up to 389.1GB	26	Up to 868.1GB	58	Up to 1,347.1GB	90
Up to 404.1GB	27	Up to 883.1GB	59	Up to 1,362.1GB	91
Up to 419.1GB	28	Up to 898.1GB	60	Up to 1,377.1GB	92
Up to 434.0GB	29	Up to 913.0GB	61	Up to 1,392.0GB	93
Up to 449.0GB	30	Up to 928.0GB	62	Up to 1,407.0GB	94
Up to 464.0GB	31	Up to 943.0GB	63	Up to 1,422.0GB	95
Up to 478.9GB	32	Up to 957.9GB	64	Up to 1,436.9GB	96
Up to 1,451.9GB	97	Up to 1,945.9GB	130	Up to 2,439.9GB	163
Up to 1,466.9GB	98	Up to 1,960.9GB	131	Up to 2,454.8GB	164
Up to 1,481.8GB	99	Up to 1,975.8GB	132	Up to 2,469.8GB	165

**Table 81** Number of differential tables used in OPEN-V (continued)

Capacity <sup>1</sup>	Differential Tables	Capacity <sup>1</sup>	Differential Tables	Capacity <sup>1</sup>	Differential Tables
Up to 1,496.8GB	100	Up to 1,990.8GB	133	Up to 2,484.8GB	166
Up to 1,511.8GB	101	Up to 2,005.8GB	134	Up to 2,499.7GB	167
Up to 1,526.8GB	102	Up to 2,020.7GB	135	Up to 2,514.7GB	168
Up to 1,541.7GB	103	Up to 2,035.7GB	136	Up to 2,529.7GB	169
Up to 1,556.7GB	104	Up to 2,050.7GB	137	Up to 2,544.6GB	170
Up to 1,571.7GB	105	Up to 2,065.6GB	138	Up to 2,559.6GB	171
Up to 1,586.6GB	106	Up to 2,080.7GB	139	Up to 2,574.6GB	172
Up to 1,601.6GB	107	Up to 2,095.6GB	140	Up to 2,589.5GB	173
Up to 1,616.6GB	108	Up to 2,110.5GB	141	Up to 2,604.5GB	174
Up to 1,631.5GB	109	Up to 2,125.5GB	142	Up to 2,619.5GB	175
Up to 1,646.5GB	110	Up to 2,140.5GB	143	Up to 2,634.4GB	176
Up to 1,661.5GB	111	Up to 2,155.4GB	144	Up to 2,649.4GB	177
Up to 1,676.4GB	112	Up to 2,170.4GB	145	Up to 2,664.4GB	178
Up to 1,691.4GB	113	Up to 2,185.4GB	146	Up to 2,679.3GB	179
Up to 1,706.4GB	114	Up to 2,200.4GB	147	Up to 2,694.3GB	180
Up to 1,721.4GB	115	Up to 2,215.3GB	148	Up to 2,709.3GB	181
Up to 1,736.3GB	116	Up to 2,230.3GB	149	Up to 2,724.3GB	182
Up to 1,751.3GB	117	Up to 2,245.3GB	150	Up to 2,739.2GB	183
Up to 1,766.3GB	118	Up to 2,260.2GB	151	Up to 2,754.2GB	184
Up to 1,781.2GB	119	Up to 2,275.2GB	152	Up to 2,769.2GB	185
Up to 1,796.2GB	120	Up to 2,290.2GB	153	Up to 2,784.1GB	186
Up to 1,811.2GB	121	Up to 2,305.1GB	154	Up to 2,799.1GB	187
Up to 1,826.1GB	122	Up to 2,320.1GB	155	Up to 2,814.1GB	188
Up to 1,841.1GB	123	Up to 2,335.1GB	156	Up to 2,829.0GB	189
Up to 1,856.1GB	124	Up to 2,350.0GB	157	Up to 2,844.0GB	190
Up to 1,871.0GB	125	Up to 2,365.0GB	158	Up to 2,859.0GB	191
Up to 1,886.0GB	126	Up to 2,380.0GB	159	Up to 2,873.9GB	192
Up to 1,901.0GB	127	Up to 2,394.9GB	160	Up to 2,880.0GB	193

**Table 81** Number of differential tables used in OPEN-V (continued)

Capacity <sup>1</sup>	Differential Tables	Capacity <sup>1</sup>	Differential Tables	Capacity <sup>1</sup>	Differential Tables
Up to 1,915.9GB	128	Up to 2,409.9GB	161		
Up to 1,930.9GB	129	Up to 2,424.9GB	162		

1. 1 GB = 10243 Byte

If you intend to create pairs with volumes of different emulation types, the maximum number of pairs you can create depends on the following conditions.

- If an LU consists of one volume (when LUSE is not used):

The maximum number of pairs you can create is the largest number that meets the equation,  $\Sigma(\alpha) \leq (\beta)$ , where:

$\Sigma(\alpha)$  is total number of differential tables per pair (see [Table 81](#))

$(\beta)$  is number of differential tables in the disk array

$(\beta) = 13,652$  when additional shared memory for differential tables is not installed

$(\beta) = 30,718$  when additional shared memory for differential tables is installed

For example, if you create 10 pairs of OPEN-3 volumes and 20 pairs of OPEN-L volumes in a disk array that does not have additional shared memory for differential tables, use the following equation to calculate,  $\Sigma(\alpha)$ :

$$(1 \times 10) + (13 \times 20) = 270$$

Because 270 is smaller than 13,652, it meets the equation,  $\Sigma(\alpha) \leq (\beta)$ , ensuring that 10 pairs of OPEN-3 volumes and 20 pairs of OPEN-L volumes can be created.

- If an LU consists of more than one volume (when LUSE volumes are used):

The maximum number of pairs you can create is the largest number that meets the equation,  $\Sigma(\Sigma(\alpha)) \leq (\beta)$ , where:

$\Sigma(\alpha)$  is total number of differential tables used by each volume constituting a LUSE volume. Every volume constituting a LUSE volume shares the same differential tables with the other volume in the same pair.

$(\beta)$  is number of differential tables available in the disk array.

For example, if you create 10 pairs of LUSE volumes consisting respectively of three OPEN-3 volumes and one OPEN-E volume (that is, not a customized volume), and 20 pairs of LUSE volumes consisting respectively of five OPEN-L, use the following equation to calculate  $\Sigma(\Sigma(\alpha))$ :

$$((1 \times 3) + (5 \times 1)) \times 10 + (13 \times 5 \times 20) = 1,380$$

Because 1,380 is smaller than 13,652, it meets the equation,  $\Sigma(\Sigma(\alpha)) \leq (\beta)$ , ensuring that 10 pairs of LUSE volumes consisting respectively of three OPEN-3 volumes and 20 pairs of LUSE volumes consisting respectively of five OPEN-L volumes (33.9GB) can be created.

## BC operations

### Set reserve attribute operation

This operation reserves a volume so it can be used as a BC S-VOL. Reserved volumes can only be used as BC S-VOLs. The disk array rejects all write operations to reserved volumes (unless in split (PSUS) status).

You can reserve up to 4,095 volumes in one disk array. Use the Set Reserve Attribute window (see ["Setting reserve attributes"](#) on page 459) to reserve volumes for use as BC S-VOLs.

A volume might be reserved for BC to ensure that a server does not mount it before BC can use it in a pair. BC cannot use a volume as an S-VOL if it is being used by a server.



**NOTE:** BC leaf volumes (L2 cascade pair) also function as S-VOLs and must be reserved prior to being assigned to an L2 cascade pair.

---

## Reset reserve attribute operation

This operation unreserves a volume so it can be mounted and accessed by all hosts. After you reset the reserve attribute, the disk array accepts all subsequent I/O operations to the volume. Use the Reset Reserve Attribute window (see ["Resetting reserve attributes"](#) on page 460) to unreserve volumes.

## Paircreate operation

This operation establishes the new BC pair(s). The volume that will be the P-VOL must be in the SMPL (simplex) state, and the volume that will be the S-VOL must be in the SMPL state before being added to a BC pair.



**NOTE:** You can reserve the S-VOL before creating a pair, but you can also create a pair with an unreserved S-VOL. Use the Paircreate window (see ["Creating BC pairs \(Paircreate\)"](#) on page 461) to create new BC volume pairs.

---

## Initial copy operation

This operation occurs when you create a new volume pair (see [Figure 235](#)). The BC initial copy operation copies all data on the P-VOL to the associated S-VOL. The P-VOL remains available to all hosts for read and write I/Os throughout the initial copy operation. After the initial copy is complete, the update copy operation duplicates write operations performed on the P-VOL during the initial copy operation at the S-VOL.

Before the initial copy operation, the status of a pair is SMPL. The status of the pair is COPY(PD) (PD = pending) while the initial copy operation is in progress. The status changes to PAIR when the initial copy is complete. Write operations performed on the P-VOL during the initial copy operation are duplicated at the S-VOL by update copy operations after the initial copy is complete.



**NOTE:** When creating pairs, you can select the pace for the initial copy operation: slower, medium, and faster. The slower pace minimizes the impact of BC operations on disk array I/O performance, while the faster pace completes the initial copy operation as quickly as possible.

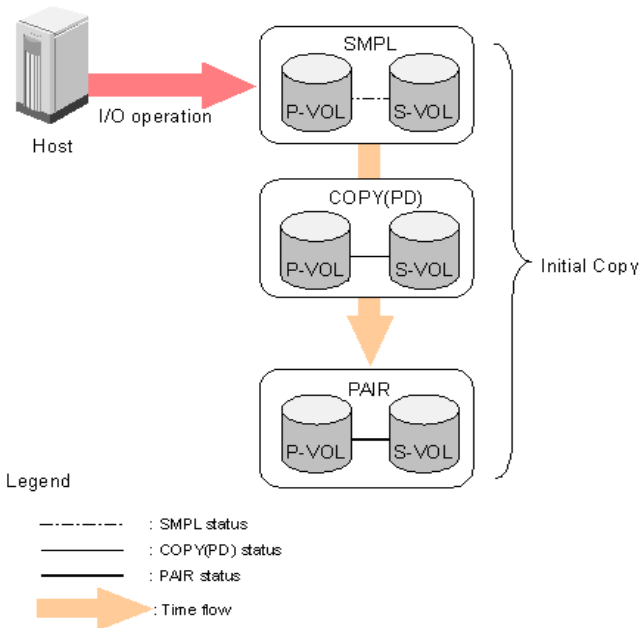

**Figure 235** Adding a pair in BC

## Update copy operation

This operation updates the S-VOL of a BC pair after the initial copy operation is complete. Since a P-VOL remains available to all hosts for read and write I/Os during the initial copy operation, the P-VOL might be updated during the operation. Therefore, when the status of the pair changes to PAIR after the initial copy operation is complete, the update copy operation takes place and the P-VOL's differential data is copied to the S-VOL. Update copy operations take place only for duplex pairs (status = PAIR). As write I/Os are performed on a duplex P-VOL, the disk array stores a map of the P-VOL's differential data, and performs update copy operations periodically based on the amount of differential data present on the P-VOL and the elapsed time between update copy operations. [Figure 236](#) illustrates an update copy operation in a BC pair with only one S-VOL.



### NOTE:

- Update copy operations are not performed for pairs with the following status: COPY(PD) (*pending duplex*), COPY(SP) (*steady split pending*), PSUS(SP) (*quick split pending*), PSUS (*split*), COPY(RS) (*resync*), COPY(RS-R) (*resync-reverse*), and PSUE (*suspended*).
- Update copy operations do not occur every time a host issues a write I/O operation to the P-VOL of a BC pair. BC update copy operations are performed asynchronously according to the differential bitmap, which is stored in shared memory.
- If shared memory is lost (for example, offline micro exchange or volatile PS on), the differential bitmap is also lost. In this case, the disk array treats the entire BC P-VOL (S-VOL for COPY(RS) pairs) as difference data and recopies all data to the S-VOL (P-VOL for COPY(RS) pairs) to ensure proper pair resynchronization. For pairs with COPY(SP) or PSUS(SP) status, the disk array changes the status to



PSUE due to the loss of the differential bitmap, also ensuring proper resynchronization of these pairs. If shared memory is lost, allow extra time for BC operations.

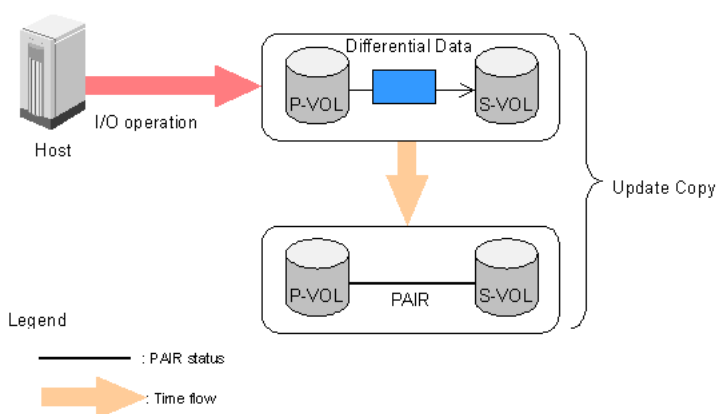

**Figure 236** Update copy operation

## Cascade function

This function creates a second layer of BC volume pairs (L2) underneath the first layer of BC pairs (L1). Cascade pairs are created by clicking **Cascade** instead of **Set** in the Paircreate window (see ["Creating BC pairs \(Paircreate\)"](#) on page 461). This cascade layering scheme creates up to nine copies of one BC P-VOL. See ["Cascade function"](#) on page 436 for further information on cascade pairs and the cascade function.

## Pairsplit operation

The BC split capability provides point-in-time backup of data, and facilitates real data testing by making the BC copies (S-VOLs) available for host access. The BC pairsplit operation performs all pending S-VOL updates (those issued prior to the split command and recorded in the P-VOL track map) to make the S-VOL identical to the state of the P-VOL when the split command was issued, and then provides full read/write access to the split S-VOL. You can split existing pairs as needed. You can also use the pairsplit operation to create and split pairs in one step.

Use the Pairsplit window (see ["Splitting BC pairs \(Pairsplit\)"](#) on page 465) to split existing BC pairs or to add and split new BC pairs in one step. When the split operation is complete, the pair status changes to PSUS, and you have full read/write access to the split S-VOL (even though it is still reserved). While the pair is split, the disk array establishes a track map for the split P-VOL **and** S-VOL, and records all updates to **both** volumes. The P-VOL remains fully accessible during the pairsplit operation. Pairsplit operations cannot be performed on suspended (PSUE) pairs.

- When splitting pairs, you can select the pace for the pending update copy operation: **Slower**, **Medium**, and **Faster**. The slower pace minimizes the impact of BC operations on disk array I/O performance, while the faster pace splits the pairs as quickly as possible.
- When splitting pairs, you can also select the split type: **Quick Split** or **Steady Split**.
  - When quick split operations start, the pair status changes to PSUS(SP), and the S-VOL is available immediately for read and write I/Os (even though it is still reserved). The disk array performs all pending update copy operations to the S-VOL in the background. When the quick split is complete, the pair status changes to PSUS.
  - When steady split operations start, the pair status changes to COPY(SP), and the disk array performs all pending update copy operations to the S-VOL. When the Steady Split operation is complete, the pair status changes to PSUS, and you have full read/write access to the split S-VOL (even though it is still reserved).

## Pairresync operations

To change the status of the pairs from PSUS to PAIR, or from PSUE to PAIR, you must resynchronize the pairs. BC can perform the following types of pairresync operations according to the speed and direction of the resynchronization:

- Normal Copy
- Quick Resync
- Reverse Copy
- Quick Restore

Use the Pairresync panel to resynchronize split and suspended BC pairs. When the pairresync operation starts, the pair status changes to COPY(RS) or COPY(RS-R). When the pairresync is complete, the pair status changes to PAIR. The local disk array resumes BC update copy operations after the pair status changes to PAIR. The P-VOL remains fully accessible during a normal pairresync operation, but is inaccessible to all hosts during a reverse or quick restore pairresync operation. This ensures that data on the P-VOL is identical to data on the S-VOL when the reverse or quick restore pairresync operation completes.



**NOTE:** You can use BC to perform normal or quick pairresync operations on split and suspended pairs, but you can perform reverse or quick restore pairresync operations only on split pairs.

---

## Forward pairresync operation

A forward pairresync operation resynchronizes pairs by copying data on P-VOLs to S-VOLs. The following are the types of forward pairresync operations:

- **Normal.** This operation (see [Figure 237](#)) resynchronizes the S-VOL with the P-VOL. The copy direction for a normal pairresync operation is P-VOL to S-VOL. The pair status during a normal resync operation is COPY(RS), and the P-VOL remains accessible to all hosts for read and write operations during a normal pairresync.
- **Quick.** This operation speeds up the normal pairresync operation without copying the P-VOL data to the S-VOL. The P-VOL and S-VOL are resynchronized when update copy operations are performed for duplex pairs (status = PAIR). The pair status during a quick pairresync operation is PSUS(SP) until the

differential map is copied, and the P-VOL remains accessible to all hosts for read and write operations. The S-VOL becomes inaccessible to all hosts during a quick pairresync operation.

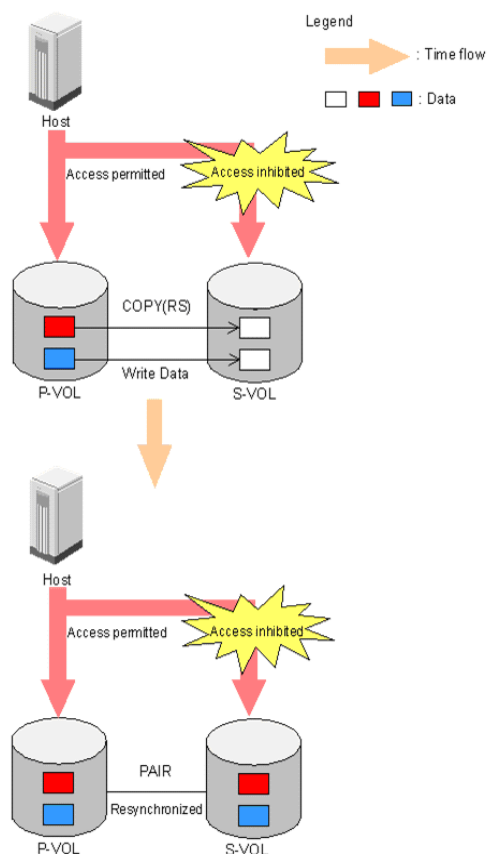

**Figure 237** Normal and quick pairresync operations

## Backward pairresync operation

A backward pairresync operation resynchronizes pairs by copying data on S-VOLs to P-VOLs. The following are the types of backward pairresync operations:

- **Reverse.** This operation (see [Figure 238](#)) synchronizes the P-VOL with the S-VOL. The copy direction for a reverse pairresync operation is S-VOL to P-VOL. [Table 82](#) lists operational requirements for the reverse pairresync operation. The pair status during a reverse resync operation is COPY(RS-R), and the P-VOL and S-VOL become inaccessible to all hosts for write operations during a reverse pairresync operation. When the reverse pairresync is complete, the P-VOL becomes accessible. The reverse pairresync operation can only be performed on split pairs, not on suspended pairs. The reverse pairresync operation cannot be performed on L2 cascade pairs.



**NOTE:** The P-VOL remains read-enabled during the reverse pairresync operation only to enable the host to recognize the volume. Data on the P-VOL is not guaranteed until the reverse pairresync operation is complete and the status changes to PAIR.

- **Quick Restore.** This operation ([Figure 238](#)) speeds up reverse resync by changing the volume map in the disk array to swap the contents of the P-VOL and S-VOL without copying the S-VOL data to the P-VOL. The P-VOL and S-VOL are resynchronized when update copy operations are performed for pairs in PAIR status. The pair status during a quick restore operation is COPY(RS-R) until the volume map change is complete. The P-VOL and S-VOL become inaccessible to all hosts for write operations during

a quick restore operation. Quick restore cannot be performed on L2 cascade pairs. [Table 82](#) lists operational requirements for the quick restore operation.

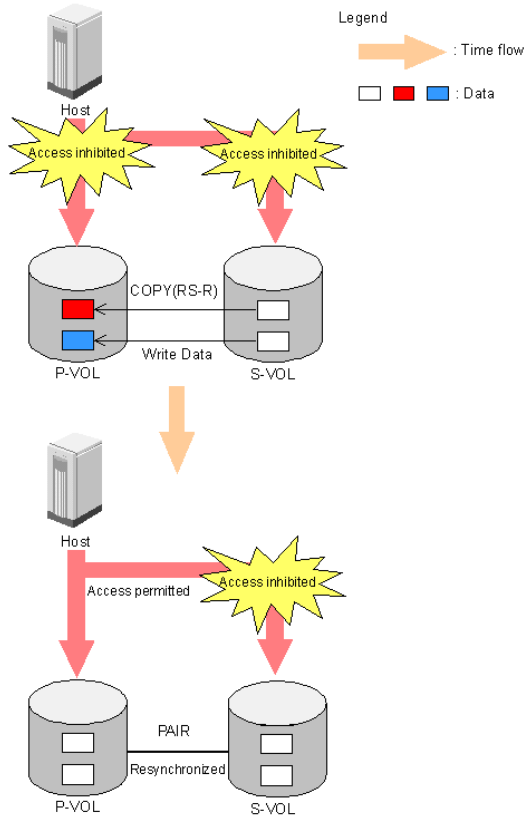

**Figure 238** Reverse and quick restore pair operations



**NOTE:** The P-VOL remains read-enabled during the quick restore operation only to enable the host to recognize the volume. Data on the P-VOL is not guaranteed until the quick restore operation is complete and the status changes to PAIR.



**NOTE:** When a quick restore operation is in progress, the array management user interface may display old configuration information. To update the information in the user interface, wait for the quick restore operation to finish, and click **Refresh**.



**CAUTION:** During a quick restore operation, the **RAID levels**, **HDD types**, and **Cache LUN** settings of the P-VOL and S-VOL are exchanged. For example, if the P-VOL has a RAID-1 level and the S-VOL has a RAID-5 level, the quick restore operation changes the P-VOL to RAID-5 and the S-VOL to RAID-1.

### To avoid any performance impact due to the quick restore operation

1. Ensure that the P-VOL and S-VOL have the same RAID level and HDD type before performing the quick restore operation. To restore the original RAID levels after a quick restore, stop host I/Os to the pair, split the pair, perform the quick restore operation for that pair again, and restart host I/Os to the pair.
2. Because Cache LUN settings are exchanged during a quick restore operation, you must perform one of the following operations. If you do not, the change of location of cache residence areas may cause I/O performance to the Cache LUN data to be down.

- Set the same Cache LUN settings (locations) for the P-VOL and S-VOL before performing the quick restore operation.
- Release the Cache LUN settings of the P-VOL and S-VOL before the quick restore operation, and reset the Cache LUN settings of the P-VOL and S-VOL after the pair changes to PAIR status as a result of the quick restore operation.



**CAUTION:** If you do not want the P-VOL and S-VOL to be resynchronized after the quick restore operation, set the Swap&Freeze option before performing the quick restore operation (see "Swap&Freeze option" on page 435 and "Setting BC options" on page 477).

**Table 82** BC pairresync parameter requirements

Parameter	Requirement(s)
Pair status.	<p>The specified pair must be in the PSUS state. If not, the reverse or quick restore pairresync command will be rejected.</p> <p>All other pairs sharing the same P-VOL as the specified pair must also be in the PSUS or PSUE state. If not, the reverse or quick restore pairresync command will be rejected.</p>
Effect on other pairs sharing the P-VOL.	<ul style="list-style-type: none"> <li>• If the BC P-VOL is also a CA P-VOL and the pair is in PAIR status, the reverse and quick restore pairresync operations cannot be performed. (The command will be rejected.)</li> </ul> <p>If the pair is in PSUS (suspended) status, the reverse and quick restore pairresync operations can be performed.</p> <ul style="list-style-type: none"> <li>• If the BC P-VOL is also a CA S-VOL and the pair is in PAIR status, the reverse and quick restore pairresync operations cannot be performed. (The command will be rejected.)</li> </ul> <p>If the pair is in PSUS (suspended) status, the reverse and quick restore pairresync operations can be performed.</p> <ul style="list-style-type: none"> <li>• If the BC S-VOL is also a CA P-VOL, the reverse and quick restore pairresync operations cannot be performed. (The command will be rejected.)</li> <li>• During the reverse or quick restore pairresync operation, a CA pair cannot be created. The CA paircreate command will be rejected when the BC pair status is COPY(RS-R).</li> <li>• For XP12000 only, if the BC P-VOL forms a pair with a CA S-VOL and an external S-VOL, the quick restore pairresync operation cannot be performed.</li> <li>• For XP12000 only, if the BC P-VOL forms a pair with an external S-VOL and a shared CA S-VOL, the quick restore pairresync operation cannot be performed.</li> <li>• For XP12000 only, if the BC S-VOL forms a pair with an external P-VOL and a shared CA P-VOL, the quick restore pairresync operation cannot be performed.</li> </ul>

**Table 82** BC pairresync parameter requirements (continued)

Parameter	Requirement(s)
Reverse or quick restore pairresync command issued to a shared BC/CA volume.	If the reverse or quick restore pairresync operation is performed on one BC pair in a 1-to-n BC configuration ( $n > 1$ ), the P-VOL and the other S-VOLs are no longer synchronized. While this reverse or quick restore pairresync is in progress, you cannot perform paircreate, pairsplit, or pairresync operations for any other pair sharing the same P-VOL (pairsplit-S and pairsplit-E are allowed). During the reverse or quick restore pairresync operation, you cannot create a CA pair or CA Journaling pair. The CA paircreate command and CA Journaling paircreate command will be rejected when the BC pair status is COPY(RS-R). When the shared BC or CA volume is paired with an external volume shown in <a href="#">Figure 239</a> , <a href="#">Figure 240</a> , or <a href="#">Figure 241</a> , the quick restore pairresync operation cannot be performed. Also, when the shared BC or CA Journaling volume is paired with an external volume shown <a href="#">Figure 242</a> and <a href="#">Figure 243</a> , the quick restore pairresync operation cannot be performed. In <a href="#">Figure 239</a> , <a href="#">Figure 240</a> , <a href="#">Figure 241</a> , <a href="#">Figure 242</a> , and <a href="#">Figure 243</a> , a colored volume is an internal volume, and a volume without color is an external volume.
Reverse or quick restore resync ends abnormally; OR, Pairsplit-E (PSUE) is requested during reverse or quick restore resync.	<ol style="list-style-type: none"> <li>1. The pair status changes to PSUE.</li> <li>2. The P-VOL of the PSUE pair is read- and write-enabled for all hosts; however, data on the P-VOL is not guaranteed. The S-VOL of the PSUE pair remains write-disabled (read-only); however, data on the S-VOL is not guaranteed.</li> <li>3. The status of other BC pairs sharing the same P-VOL does not change.</li> </ol>
Reverse or quick restore pairresync command issued to a shared BC or CA Journaling volume.	If the BC and CA Journaling pairs share the same volume, and the CA Journaling pair is not suspended, the reverse and quick restore pairresync operations cannot be performed. (The command will be rejected.)



**NOTE:** A P-VOL of CA Journaling means a primary data volume of CA Journaling. An S-VOL of CA Journaling means a secondary data volume of CA Journaling.



**CAUTION:** If a reverse or quick restore resync operation ends abnormally, or a Pairsplit-E (PSUE) is requested during reverse or quick restore resync operation, the status of other BC pairs that share the same P-VOL does not change.



**NOTE:** When a reverse or quick restore pairresync is in progress, you cannot perform paircreate, pairsplit, or pairresync operations for any other pair that shares the same P-VOL (pairsplit-S and pairsplit-E are allowed).

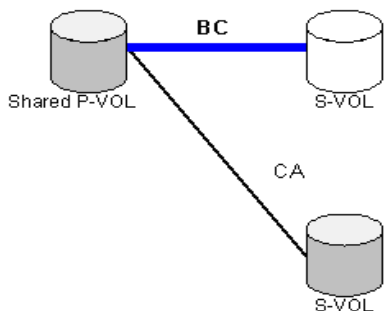

**Figure 239** BC P-VOL forming pair with CA S-VOL and external S-VOL, respectively

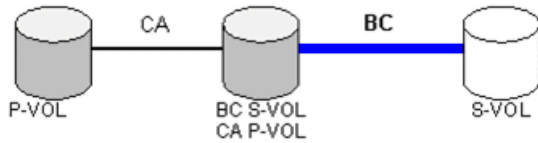

**Figure 240** BC P-VOL forming pair with external S-VOL and shared as CA S-VOL

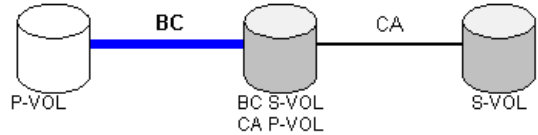

**Figure 241** BC S-VOL forming pair with external P-VOL and shared as CA P-VOL

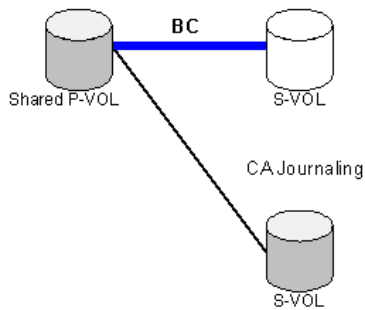

**Figure 242** BC P-VOL forming pair with CA Journaling S-VOL and External S-VOL, respectively

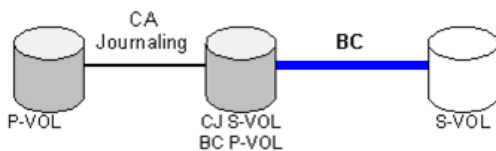

**Figure 243** BC P-VOL forming pair with external S-VOL and shared as CA Journaling S-VOL

Use the Pairresync window (see [“Resynchronizing BC pairs \(Pairresync\)”](#) on page 470) to resynchronize split and suspended BC pairs. When the pairresync operation starts, the pair status changes to COPY(RS) or COPY(RS-R). When the pairresync is complete, the pair status changes to PAIR. The disk array resumes BC update copy operations after the pair status changes to PAIR. The P-VOL remains fully accessible during a normal pairresync operation, but becomes inaccessible to all hosts during a reverse or quick restore pairresync operation. This ensures that data on the P-VOL is identical to data on the S-VOL when the reverse or quick restore pairresync operation completes.

## Pair status and time required for pairresync

The pairresync operation can be performed on a split pair or suspended pair. This section describes the relationship between the pair status and the time required for pairresync operations.

- **Pairresync for split pair.** When a normal/quick pairresync operation is performed on a split pair (status = PSUS), the disk array copies all flagged tracks from the P-VOL to the S-VOL. When a reverse or quick restore pairresync operation is performed on a split pair, the disk array copies all flagged tracks from the S-VOL to the P-VOL. This ensures that the P-VOL and S-VOL are properly resynchronized in the desired direction, and greatly reduces the time needed to resynchronize the pair.
- **Pairresync for suspended pair.** When a normal/quick pairresync operation is performed on a suspended pair (status = PSUE), the disk array copies all data on the P-VOL to the S-VOL, because all P-VOL tracks were flagged as difference data when the pair was suspended. Reverse and quick restore

pairresync operations cannot be performed on suspended pairs. The normal pairresync operation for suspended pairs is equivalent to and takes as long as the BC initial copy operation.



**CAUTION:** When resynchronizing pairs, you can select the pace for the pairresync operation: slower, medium, or faster. The slower pace minimizes the impact of BC operations on subsystem I/O performance. The faster pace resynchronizes the pairs as quickly as possible, but it may affect the disk array's I/O performance.

## Pairsplit-E operation (suspend)

This operation suspends the BC copy operations to the S-VOL of the pair. You can suspend a BC pair at any time. When a BC pair is suspended (status = PSUE), the disk array stops performing BC copy operations to the S-VOL, continues accepting write I/O operations to the P-VOL, and marks the entire P-VOL track as difference data. When a pairresync operation is performed on a suspended pair, the entire P-VOL is copied to the S-VOL. While the pairresync operation for a split BC pair can be very fast, the pairresync operation for a suspended pair takes as long as the initial copy operation. The reverse and quick restore pairresync operations cannot be performed on suspended pairs.

The disk array automatically suspends a BC pair when it cannot keep the pair mirrored for any reason. When the disk array suspends a pair, sense information is generated to notify the host. The disk array automatically suspends a pair under the following conditions:

- When the volume pair has been suspended (PSUE) or deleted (SMPL) from an open system host using the RAID Manager command line interface.
- When the disk array detects an error condition related to an initial copy operation. When a volume pair with COPY(PD) status is suspended (PSUE), the disk array aborts the initial copy operation, changes the status of the P-VOL and S-VOL to SMPL, accepts all subsequent write I/Os to the S-VOL, and does not keep track of updates.
- When the disk array detects an error condition related to an update copy operation.
- When the P-VOL and/or S-VOL track map in shared memory is lost (for example, due to offline microprogram exchange). This applies to COPY(SP) and PSUS(SP) pairs only. For PAIR, PSUS, COPY(RS), or COPY(RS-R) pairs, the pair is not suspended, but the entire P-VOL (S-VOL for reverse or quick restore pairresync) is marked as difference data.

Use the Pairsplit-E window (see “[Suspending BC pairs \(Pairsplit-E\)](#)” on page 473) to suspend BC pairs. When a pair is suspended, the status changes to PSUE. When the pairresync operation starts, the pair status changes to COPY(RS). The P-VOL remains fully accessible while suspended and during the pairresync operation.

## Pairsplit-S operation (delete)

This operation stops BC copy operations to the S-VOL of the pair and changes the pair status of both volumes to SMPL. The volumes are not deleted. A BC pair can be deleted at any time except during the quick pairsplit operation (or any status except SMPL status and PSUS(SP) status). After you delete a BC pair, the S-VOL is still not available for write operations until the reserve attribute is reset.

Use the Pairsplit-S window (see “[Deleting BC pairs \(Pairsplit-S\)](#)” on page 474) to delete BC pairs. When a BC pair is deleted, pending update copy operations for the pair are discarded, and the status of the P-VOL and S-VOL is changed to SMPL.



**CAUTION:** The S-VOL of a duplex pair (PAIR status) may not be identical to its P-VOL due to the asynchronous BC update copy operations. See “[Deleting BC pairs \(Pairsplit-S\)](#)” on page 474 for instructions on synchronizing the volumes before deleting the pair.



## BC options

Use the BC options to extend standard BC operations such as the paircreate and pairresync operations. The following table lists the options that are currently available.

**Table 83** BC options types and requirements

No.	Option Type	Requirement
1	Swap&Freeze	The BC quick restore operation can be performed on the disk array. If the disk array setting disables the quick restore operation, change the setting (that is, enable the quick restore operation in the disk array) before using the Swap&Freeze option.  See "Swap&Freeze option" on page 435.
2	Host I/O Performance	See "Host I/O Performance option" on page 436.
3 - 32	Reserved (Currently unavailable)	-



**NOTE:** The number of available option types depends on the disk array's settings.

## Swap&Freeze option

This option allows the S-VOLs of a BC pair to remain unchanged after the quick restore operation. If the quick restore operation is performed on a BC pair with the Swap&Freeze option, update copy operations are suppressed for pairs in PAIR status after the quick restore operation. If the quick restore operation is performed without the Swap&Freeze option, the P-VOL and S-VOL are resynchronized when update copy operations are performed for pairs in PAIR status.

The following figure shows the state of the S-VOL after the quick restore operation with or without the Swap&Freeze option.

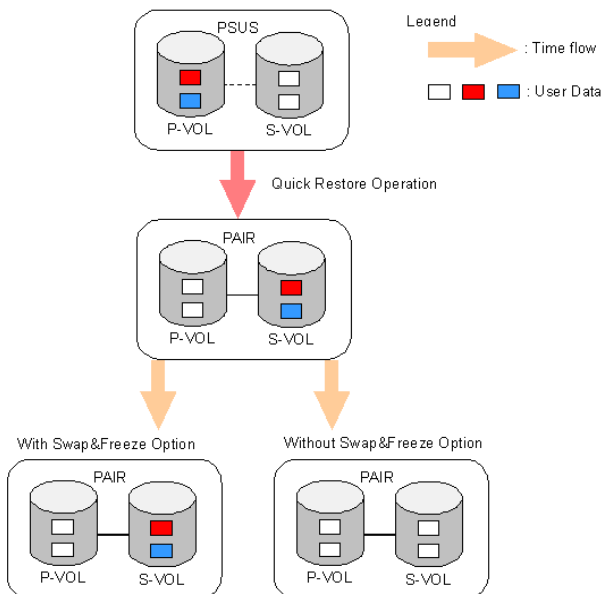

**Figure 244** Quick Restore operation with or without Swap&Freeze option

The Quick Restore pairresync operation on a pair with status of PSUS exchanges data in the pair's P-VOL and S-VOL. If you use the Swap&Freeze option when performing the Quick Restore pairresync operation, the update copy operation will not take place after the Quick Restore pairresync operation is complete. Therefore, data on the P-VOL and S-VOL is kept exchanged. If you do not use the Swap&Freeze option when performing the Quick Restore pairresync operation, the update copy operation will take place after the Quick Restore pairresync operation is complete, and data on the P-VOL overwrites data on the S-VOL.

## Host I/O Performance option

This option improves host I/O responses over ShadowImage SI390/ShadowImage for z/OS (SI390 and z/OS) copying processing time. When the Host I/O Performance option is used, the disk array suppresses execution of SI390/z/OS copying processing, and consequently host I/O responses improve.

When SI390/z/OS copying processing is suppressed, the time taken for copying increases. Also, if BC pairs exist, host I/O responses might not be faster. In this case, set the Host I/O Performance option for BC as well.

Cascade

## Cascade function

This function creates a second layer of volume pairs underneath the first layer of BC pair(s). Pairs created in the first and second layer are called cascaded pairs. [Figure 245](#) illustrates cascaded BC volume pairs. The first cascade layer (L1) is the original BC pair, consisting of one P-VOL (root volume) and up to three S-VOLs (node volumes). In the second cascade layer (L2), the S-VOLs of the original BC pair function as the P-VOLs of the L2 pairs, and each L2 P-VOL can have up to two S-VOLs (leaf volumes). This layering scheme can create up to nine copies of one BC primary volume (P-VOL).

Every volume can have up to three Mirror Unit (MU) numbers associated with it. The MU number designates a pair for which the volume is a member. The MU number is not the number of the pair, but the number of the volume. A pair is made up of two volumes of which each pair member could have the same or different MU numbers.

- MU=0 is the number of a volume for its first pair.
- MU=1 is the number of the same volume for its next pair.
- MU=2 is the number of the same volume for its third pair.
- The MU number of an S-VOL is always MU=0.

For Level 1 (L1) pairs, the root volume could have MU=0, MU=1, and MU=2. For L1 pairs, the associated S-VOLs all have MU=0 because this is the first pair of which they are a member.

For the Level 2 (L2) pairs, the L1 S-VOLs are now all acting as L2 P-VOLs. Because they are already a member of one pair, the next MU number for each of them is MU=1 for their first L2 pair and MU=2 for

their second L2 pair. For the S-VOLs associated with each of these pairs, the MU number is once again MU=0 because this is the first pair of which they are a member.

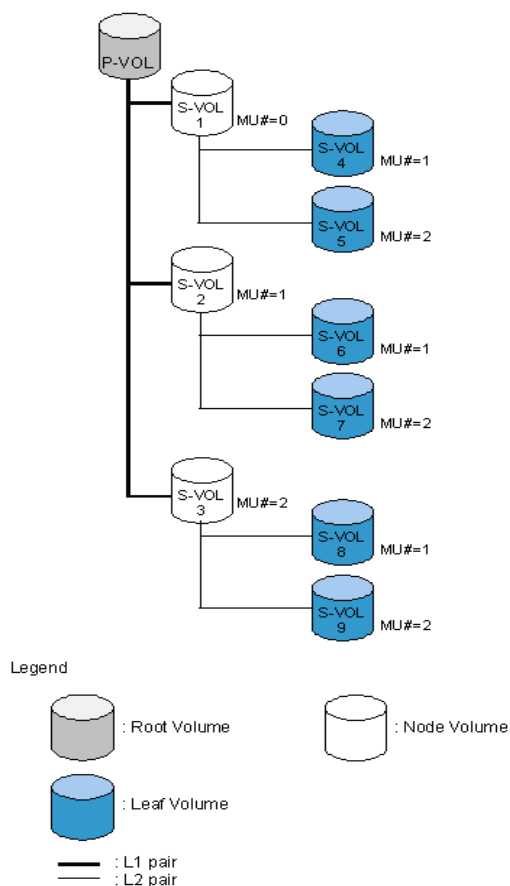

**Figure 245** Cascade pairs

When L1 and L2 cascade pairs are created, the P-VOLs and S-VOLs of the cascade pairs are classified using the following terms (as shown in the previous figure):

- The **root volume** is the P-VOL of the L1 pair, which is the original BC pair. You can add up to three S-VOLs (node volumes) to a root volume.
- The **node volume** is the S-VOL (reserved) of an L1 pair and the P-VOL of an L2 pair. You can add up to two S-VOLs (leaf volumes) to a node volume.
- The **leaf volume** is the S-VOL (reserved) of an L2 cascade pair.

[Table 84](#) shows the relationship between L1 pair status and availability of BC pair operations on the associated L2 pairs. To split an L2 pair, you must first split the L1 pair (L1 status = PSUS). The reverse and quick restore pairresync operations cannot be used for L2 pairs. [Table 85](#) shows the relationship between L2 pair status and availability of pair operations on the associated L1 pairs. (CMD RJT = command rejected.) If you delete an L1 pair containing an L2 pair, the L2 pair becomes the L1 pair.



**NOTE:**

- Combining L1 and L2 pairs with CA volumes is allowed; however, CA considers node and leaf volumes as secondary volumes (S-VOLs).
- When a P-VOL is paired with more than one S-VOL, the disk array assumes there are the same number of virtual P-VOLs. For example, when a P-VOL is paired with three S-VOLs, there is only one real P-VOL, but the disk array assumes there are three virtual P-VOLs. A Virtual P-VOL is called an MU (Mirror Unit).

- “MU#” in [Figure 245](#) means MU number, which identifies each MU. MU#=1 under S-VOL1 means the MU number of the P-VOL that is paired with the S-VOL1 is 1.

**Table 84** Relationship between L1 pair status and L2 pair operations

L1 Pair Status	L2 Pair Operations					
	Paircreate	Pairsplit	Pairresync	Reverse/ Quick Restore	Pairsplit-E	Pairsplit-S
COPY(PD)	OK	NO (CMD RJT)	OK	NO (CMD RJT)	OK	OK
PAIR	OK	NO (CMD RJT)	OK	NO (CMD RJT)	OK	OK
COPY(SP)	OK	NO (CMD RJT)	OK	NO (CMD RJT)	OK	OK
PSUS(SP)	OK	NO (CMD RJT)	OK	NO (CMD RJT)	OK	OK
PSUS	OK	OK	OK	NO (CMD RJT)	OK	OK
COPY(RS)	OK	NO (CMD RJT)	OK	NO (CMD RJT)	OK	OK
COPY(RS-R)	OK	NO (CMD RJT)	OK	NO (CMD RJT)	OK	OK
PSUE	OK	NO (CMD RJT)	OK	NO (CMD RJT)	OK	OK

[Table 85](#) shows the relationship between the L2 pair status and availability of pair operations on the associated L1 pairs. (CMD RJT = command rejected.) If you delete an L1 pair containing an L2 pair, the L2 pair becomes the L1 pair.

**Table 85** Relationship between L2 pair status and L1 pair operations

L2 Pair Status	L1 Pair Operations					
	Paircreate	Pairsplit	Pairresync	Reverse/ Quick Restore	Pairsplit-E	Pairsplit-S
COPY(PD)	OK <sup>1,2</sup>	OK	OK	OK	OK	OK
PAIR	OK <sup>1,2</sup>	OK	OK	OK	OK	OK
COPY(SP)	NO <sup>2</sup> (CMD RJT)	NO <sup>2</sup> (CMD RJT)	NO (CMD RJT)	NO (CMD RJT)	OK	OK
PSUS(SP)	NO <sup>2</sup> (CMD RJT)	NO <sup>2</sup> (CMD RJT)	NO (CMD RJT)	NO (CMD RJT)	OK	OK
PSUS	OK <sup>1,2</sup>	OK	OK	OK	OK	OK
COPY(RS)	OK <sup>1,2</sup>	OK	OK	OK	OK	OK

**Table 85** Relationship between L2 pair status and L1 pair operations (continued)

L2 Pair Status	L1 Pair Operations					
	Paircreate	Pairsplit	Pairresync	Reverse/ Quick Restore	Pairsplit-E	Pairsplit-S
COPY(RS-R) <sup>3</sup>	NO <sup>2</sup> (CMD RJT)	NO <sup>2</sup> (CMD RJT)	--	--	--	--
PSUE	OK <sup>1,2</sup>	OK	OK	OK	OK	OK

1. MU# of L2 node pair member must be 1 or 2.
2. XP12000: Not displayed by the array management interface.
3. XP12000 only.

The read/write operation to each volume (root, node, or leaf) from the host is enabled or disabled depending on the status of L1/L2 pairs. The read/write operation from the host can always be performed to the root volume regardless of the status of L1/L2 pairs. [Table 86](#) shows the relationship between read/write operations from host to node volume and status of L1/L2 pairs. [Table 87](#) shows the relationship between read/write operations from host to leaf volume and L2 pair status.

**Table 86** Read/write operation (host to the node volume) and L1/L2 pair status

L1 Pair Status	L2 Pair Status					
	COPY(PD)	PAIR	COPY(SP)	PSUS(SP)/ PSUS	COPY(RS)	PSUE
COPY(PD)	Read Only	Read Only	Read Only	Read Only	Read Only	Read Only
PAIR	Read Only	Read Only	Read Only	Read Only	Read Only	Read Only
COPY(SP)	Read Only	Read Only	Read Only	Read Only	Read Only	Read Only
PSUS(SP)/ PSUS	Read/ Write	Read/ Write	Read/ Write	Read/ Write	Read/ Write	Read/ Write
COPY(RS)	Read Only	Read Only	Read Only	Read Only	Read Only	Read Only
COPY(RS-R)	Read Only	Read Only	Read Only	Read Only	Read Only	Read Only
PSUE	Read Only	Read Only	Read Only	Read Only	Read Only	Read Only

[Table 87](#) indicates the relationship between the read/write operation from the host to the leaf volume and the L2 pair status.

**Table 87** Read/write operation (host to the leaf volume) and L2 pair status

COPY	L2 Pair Status				
	PAIR	COPY(SP)	PSUS(SP)/PSUS	COPY(RS)	PSUE
Read Only	Read Only	Read Only	Read/Write	Read Only	Read Only

## At-Time Split function

In the past, a BC pair group split each LUN pair in the group at a slightly different time. If the application data spanned multiple LUNs in the group, there was the chance of data corruption unless the application was stopped before the split. With the At-Time Split function, LUN pairs are split at the same time within the group, which keeps data consistent without having to stop the application.

At this time, the At-Time Split operation is performed using RAID Manager on the UNIX/PC server host. You can use Command View to perform BC pair operations for At-Time Split pairs created by RAID Manager. However, the At-Time Split option in Command View is disabled.

A BC consistency group is a user-defined set of BC volume pairs used for the At-Time Split function. This function creates S-VOLs of all P-VOLs in the same consistency group when the pairsplit command is executed.

BC consistency groups and the At-Time Split function have the following restrictions:

- You can configure up to 128 consistency groups in a disk array, including BC consistency groups.
- A number (0–127) is assigned to each consistency group. You can specify a consistency group number when you create BC pairs. If you do not specify a number, the disk array assigns a number automatically.
- You can define up to 1,024 BC pairs in a consistency group. However, for LUSE volumes containing n LDEVs, you should count as n volumes. For more information about LUSE volumes, see ["Volume Management for the XP128/XP1024/XP12000"](#) on page 241.
- BC pairs and ShadowImage pairs cannot co-exist in the same consistency group.
- To configure BC consistency groups, use the RAID Manager software. However, to confirm the BC consistency group numbers, use BC (see ["Volume list"](#) on page 453).

When the At-Time Split function is enabled, data in all P-VOLs in the same consistency group is copied to the corresponding S-VOLs when the disk array receives the pairsplit request from the host server. The following figure shows an overview of the At-Time Split function.

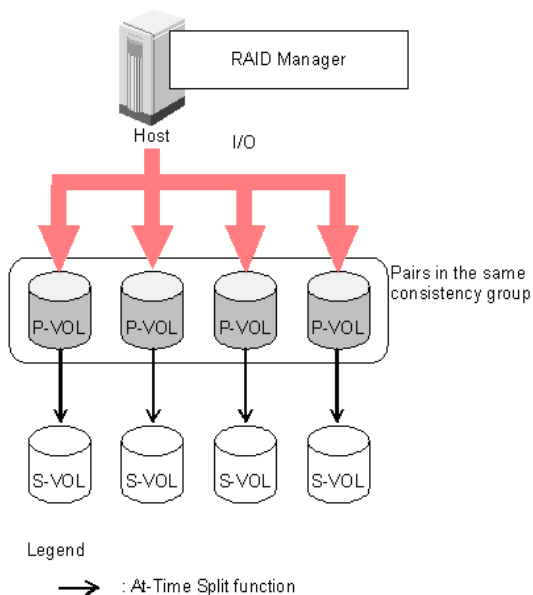

**Figure 246** Overview of At-Time Split function

## Enabling the At-Time Split function using RAID Manager

1. Create BC At-Time Split pairs as follows:
  - a. Define a consistency group for BC pairs. You cannot define L1 and L2 cascade pairs (see ["Cascade function"](#) on page 436) sharing the same node volume in a consistency group. If you specify such pairs in the same consistency group, the paircreate command will be rejected.
  - b. Specify the At-Time Split option.
  - c. Execute the paircreate command.
2. Execute the pairsplit command on the new BC At-Time Split pairs.

The At-Time Split option is enabled, and data in all P-VOLs in the same consistency group is copied to the corresponding S-VOLs when the disk array receives the pairsplit request.



### NOTE:

- You can perform BC pair operations (see ["Performing BC operations"](#) on page 459) from the Command View XP management station on the BC At-Time Split pairs created by RAID Manager; however, the At-Time Split option is disabled (the pairsplit operation does not ensure creating S VOLs of the P-VOLs in the same consistency groups).
- When the RAID Manager pairsplit operation ends abnormally, all BC pairs in the same consistency group are suspended (status = PSUE).
- When the host server is down or has failed, a consistency group with no BC pairs can be defined. If you execute the paircreate command with the At-Time Split option (-m) under these conditions, the paircreate command might be rejected. In this case, first find a consistency group number that is not used by any pairs on the BC main screen by sorting the **CTG** column (see ["Volume list"](#) on page 453). Next, specify the consistency group number explicitly, and execute the paircreate command with the At-Time Split option using RAID Manager on the host server.
- Do not mix pairs created with the At-Time Split option and pairs not created with the At-Time Split option in the same group defined in the RAID Manager configuration file. If you mix these two types of pairs, the pairsplit operation might terminate abnormally, or the S-VOLs of the P-VOLs in the same consistency group might not be created correctly when the pairsplit request is received.



**NOTE:** After the pairsplit, response time of the first I/O to each logical unit (LU) can be up to approximately five seconds in the worst case. This worst case should be in a one-to-three BC pair situation and 36 LDEV LUSE configuration.

---

## Pair status

The BC remote console software displays the pair status of all BC volumes (LUs) on the specified port of the connected disk array. The following figure shows the BC pair status transitions and the relationship between pair status and BC operations.

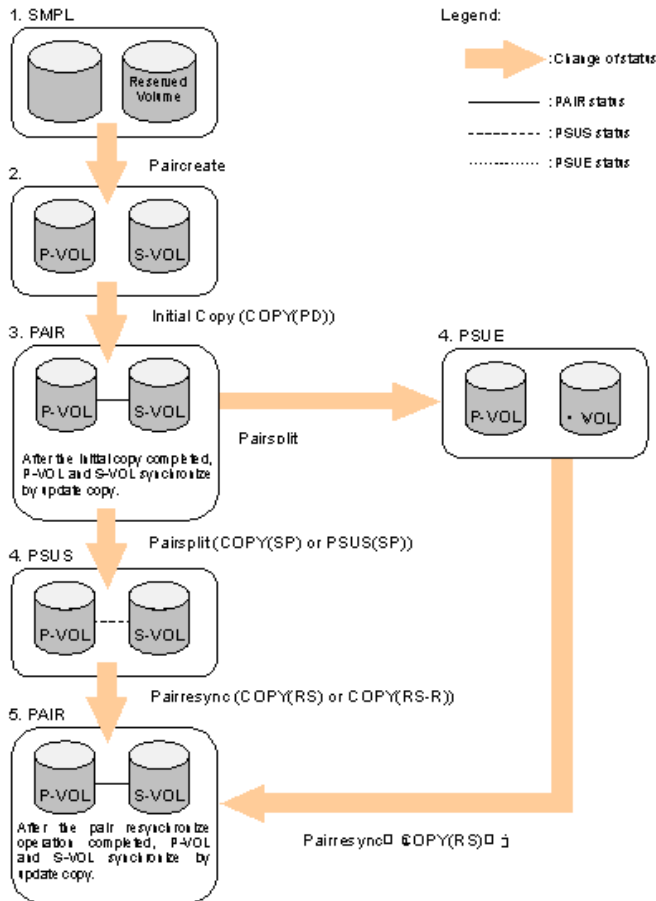

**Figure 247** BC pair status transitions

The following describes BC pair status conditions:

1. If a volume is not assigned to a BC pair, its status is SMPL.
2. Select the SMPL volumes for the P-VOL and S-VOL to create a BC pair. When you create a BC pair, the initial copy operation starts. During the initial copy operation, the status of the P-VOL and S-VOL changes to COPY(PD).
3. When the initial copy operation is complete, the pair status becomes PAIR. When the pair status is PAIR, the P-VOL and S-VOL have the same data. If the P-VOL is updated after the initial copy operation, the update copy operation takes place and synchronizes the P-VOL and S-VOL.
4. The following are the types of pair status (PSUS and PSUE) when the pair is not synchronized:
  - When you split a pair (pairsplit), the pair status changes to COPY(SP) or PSUS(SP) for quick pairsplit. During the pairsplit process, the pair status becomes COPY(SP). If you specify Quick Split pairsplit, the pair status becomes PSUS(SP) during the process. When the pairsplit operation is complete, the pair status changes to PSUS and you can access the split S-VOL. The update copy operation is not performed on pairs with status of PSUS.
  - If the disk array cannot maintain PAIR status for any reason or if you suspend the pair (pairsplit-E), the pair status changes to PSUE.



**NOTE:**

- When you specify reverse or quick restore mode for a pairresync operation, the pair status changes to COPY(RS-R) (data is copied in the reverse direction from the S-VOL to the P-VOL). For more information about pairresync operation settings, see “[Pairresync operations](#)” on page 428.
- When you delete a pair (pairsplit-S), the pair status changes to SMPL. You cannot delete a pair with status of PSUS(SP).

5. When you start a pairresync operation, the pair status changes to COPY(RS) or COPY(RS-R). When the pairresync operation is complete, the pair status changes to PAIR.

**Table 88** BC pair status conditions

Pair Status	Description	S-VOL Access
SMPL	The volume is not assigned to a BC pair. The disk array accepts read and write I/Os for all SMPL volumes that are not reserved.	N/A (there is no S-VOL yet).
COPY(PD)	The initial copy operation is in progress. The disk array continues to accept read and write operations for the P-VOL, but stops accepting write operations for the S-VOL. No update copy operations are performed.	Read only.
PAIR	The initial copy operation is complete, and the disk array performs asynchronous update copy operations from the P-VOL to the S-VOL as needed. The P-VOL and S-VOL of a duplex pair (PAIR status) may not be identical. The disk array rejects all write I/Os for S-VOLs with status PAIR.	Read only.
COPY(SP)	The status becomes COPY(SP) when the steady split mode is selected for the pairsplit operation. All P-VOL updates prior to the pairsplit command are copied to the S-VOL. When these updates are complete, the split S-VOL is identical to the state of the P-VOL when the split started. The disk array rejects all write I/Os for COPY(SP) S-VOLs.	Read only.
PSUS(SP)	The status becomes PSUS(SP) when the quick split mode is selected for the pairsplit operation. Only the P-VOL differential data is copied to the S-VOL in the background. The disk array accepts writes for PSUS(SP) S-VOLs. PSUS(SP) pairs cannot be deleted.	Read and write. The S-VOL can be mounted.
PSUS	The disk array stops update copy operations for PSUS (split) pairs, and starts accepting write I/Os for PSUS S-VOLs. The disk array keeps track of all updates to the split P-VOL and S-VOL, so the pair can be resynchronized quickly.	Read and write. The S-VOL can be mounted.
COPY(RS)	The disk array does not accept write I/Os for COPY(RS) S-VOLs. When a split pair is resynchronized in normal mode, the disk array copies only the P-VOL differential data to the S-VOL. When a PSUE (suspended) pair is resynchronized, the disk array copies the entire P-VOL to the S-VOL. No update copy operations are performed during the pairresync operation.	Read only.

**Table 88** BC pair status conditions (continued)

Pair Status	Description	S-VOL Access
COPY(RS-R)	The disk array does not accept write I/Os for COPY(RS-R) S-VOLs. When a split pair is resynchronized in reverse or quick restore mode, the disk array copies only the S-VOL differential data to the P-VOL. No update copy operations are performed during the reverse or quick restore pairresync operation.	Read only.
PSUE	The disk array continues accepting read and write I/Os for a PSUE (suspended) P-VOL, but does not perform update copy operations for a PSUE S-VOL. The disk array marks the entire P-VOL track map as difference data, so the entire P-VOL is copied to the S-VOL when the PSUE pair is resumed. Use the pairresync command to resume a PSUE pair.	Read only.

## Cautions on switching off the power supply

To switch off the power supply of the disk array during BC operations, make sure to:

- Complete copying for the BC pair in COPY(SP) or PSUS(SP) status first to change the pair status from COPY(SP) or PSUS(SP) to PSUS, and then switch off the power supply. If shared memory is volatilized when you switch on the power supply again, the pair in COPY(SP) or PSUS(SP) status changes to PSUE.
- Establish a timetable for BC copying operations. If shared memory is volatilized when you switch on the power supply again, the following conditions occur:
  - If the BC pair was in COPY(PD) or COPY(SP) status, data already copied becomes target data to be copied after the power supply is switched back on. Even if there is no host I/O, the data consistency rate does not reach 100% when the BC pair status changes to PAIR. When the BC pair status changes to PAIR, target data is copied to the secondary volume.
  - If the BC pair was in PAIR status, data already copied becomes target data to be copied after the power supply is switched back on. In this case, the data consistency rate is 0%, and target data is copied to the S-VOL.
  - If the BC pair was in PSUS status, the entire volume becomes differential data. In this case, the data consistency rate is 0%, and the entire volume is copied to the secondary volume when you perform the pairresync operation.

## Preparing for BC operations

### System requirements

BC operations involve the disk array containing the primary and secondary volumes and the licensed BC feature enabled on the Command View management station. System requirements for BC are:

- Disk array hardware, microcode, and software required for BC operations must be installed and enabled.
- Command View management station (user-supplied Windows-based PC).
- BC license key installed.

## Preparing for BC operations

To ensure that you and your disk array(s) are ready for BC operations, perform the following tasks:

- BC operations affect I/O performance of the disk array because of copy operations to the S-VOLs. If you have not already done so, consider the relative importance of the disk array's I/O performance and the BC backup copies. For example, assigning three S-VOLs to each P-VOL takes more resources than assigning one or two. You can also use the copy pace option to control the impact of BC initial copy operations. Using a slower copy pace minimizes the impact of BC operations on I/O performance, while a faster copy pace produces copies more quickly, but may affect I/O performance.
- If you are using more than one disk array data management feature (such as BC, CA, or Cache LUN) at the same time in the same disk array, contact your HP account support representative to ensure that your disk array is optimized for your configuration of concurrent operations. Each disk array feature can affect disk array performance and/or operation of other features. For example, BC and CA operations both involve initial copy and update copy operations to secondary/remote volumes in addition to host I/O workload.
- Identify the volumes (LUs) you will use for BC operations. For each volume, write down the full SCSI path (port, target ID (TID), and LUN), whether the volume will be a P-VOL or S-VOL, and the other volume(s) in its pair (see [Table 89](#) for a sample). LUN Management displays this information. Volumes that will be P-VOLs remain fully accessible to all hosts throughout normal BC operations, but volumes that will be S-VOLs must be unmounted before being reserved for BC operations.

**Table 89** Identifying the volumes for BC operations

CU	Port	TID: LUN	L1 P-VOL	Assoc. L1 S-VOL(s)	L1 S-VOL	Assoc. L1 P-VOL	L2 P-VOL	Assoc. L2 S-VOL(s)	L2 S-VOL	Assoc. L2 P-VOL
0	1A	0:00	Yes	1B-0:00, 2A-0:00, 2B-0:00	No	--	No	--	No	--
0	1A	0:01	Yes	1B-0:01, 2A-0:01, 2B-0:01	No	--	No	--	No	--
etc.										
0	1B	0:00	No	--	Yes	1A-0:00	Yes	3A-0:00, 3A-0:01	No	--
0	1B	0:01	No	--	Yes	1A-0:01	Yes	3B-0:00, 3B-0:01	No	--
etc.										
0	2A	0:00	No	--	Yes	1A-0:00	Yes	4A-0:00, 3B-0:01	No	--
0	2A	0:01	No	--	Yes	1A-0:01	Yes	4B-0:00, 3B-0:01	No	--
etc.										
0	3A	0:00	No	--	No	--	No	--	Yes	1B-0:00
0	3A	0:01	No	--	No	--	No	--	Yes	1B-0:00

## Combining BC with other data management operations

BC supports concurrent operations with the following data management functions:

- **LU Size Expansion (LUSE).** LUSE volumes can be assigned to BC pairs if the P-VOL and S-VOL have the same LU type and number of LDEVs (same size). If you must perform LUSE operations on an existing BC P-VOL or S-VOL, delete the pair first to return the volume to SMPL status.
- **VSC.** VSC volumes can be assigned to BC pairs if the S-VOL has the same capacity as the P-VOL. If you must perform VSC operations on an existing BC P-VOL or S-VOL, delete the pair first to return the volume to SMPL status.
- **LUN Security.** LUN Security operations do not affect BC operations. Volumes under secure ports and/or assigned to World Wide Name (WWN) groups and/or LUN groups can also be assigned to BC pairs. Volumes assigned to BC pairs can also be assigned to secure ports, WWN groups, and/or LUN groups for LUN Security.



**NOTE:** BC S-VOLs cannot be accessed by any host except when the pair is split.

- **Cache LUN.** Cache LUN volumes can be assigned to BC pairs. Cache LUN operations can be performed on BC P-VOLs and S-VOLs.
- **CA Journaling.** CA Journaling volumes can be assigned to BC pairs, and BC volumes can be assigned to CA Journaling pairs.



**CAUTION:** See “[Pairresync operations](#)” on page 428 for important information on performing quick restore operations on Cache LUN volumes.

- **CA.** CA volumes can be assigned to BC pairs, and BC volumes can be assigned to CA pairs. See “[Combining BC and CA operations](#)” on page 448 for important information on BC and CA shared volume configurations.
- **Auto LUN.** BC can be assigned to Auto LUN migration volumes. However, if the BC P-VOL is already paired with three S-VOLs, delete the BC pairs before migrating the volumes. Also, to assign BC volumes to destination migration volumes or reserve BC volumes for Auto LUN, delete the BC volumes or unreserve the BC volumes before using them with Auto LUN. If you assign a BC P-VOL that is already paired with three S-VOLs to Auto LUN migration volumes, or assign BC volumes to Auto LUN volumes other than migration volumes, the command will be rejected.

If you split the BC pair assigned to Auto LUN migration volumes, migration of those volumes will be canceled.



**NOTE:** You cannot use Auto LUN migration, destination, and reserved volumes for BC pair operations (the command will be rejected). To use Auto LUN volumes for BC pair operations, use Auto LUN to release the volumes.

- **External Storage XP.** BC operations can be performed with External Storage XP operations to create pairs with the external volumes.

## Combining BC and CA Journaling operations

CA Journaling volumes can be assigned to BC pairs, and BC volumes can be assigned to CA Journaling pairs.

BC and CA Journaling can function together in the same Local disk array to provide both internal and remote backup for your important data.



**NOTE:**

- A primary volume (P-VOL) of CA Journaling means a primary data volume of CA Journaling. A secondary volume (S-VOL) of CA Journaling means a secondary data volume of CA Journaling.
- Combining BC L1 and L2 pairs with CA Journaling volumes is allowed. CA Journaling considers node and leaf volumes as secondary volumes (S-VOLs).

The configuration shown in [Figure 248](#) is an example of a volume that functions as both a CA Journaling P-VOL and a BC P-VOL. This configuration allows you to:

- Use BC to provide on-site backup copies of CA Journaling P-VOLs
- Use CA Journaling to provide remote backup copies of BC P-VOLs

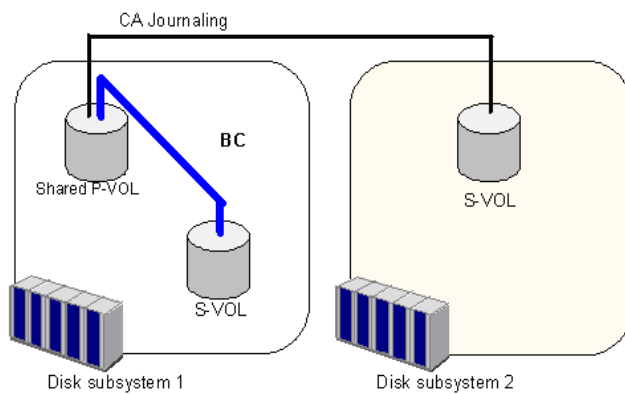

**Figure 248** BC and CA Journaling: Shared P-VOL and P-VOL

The configuration shown in [Figure 249](#) is an example of a volume that functions as both a CA Journaling S-VOL and a BC P-VOL. This configuration allows you to use BC to provide remote copies of CA Journaling S-VOLs.

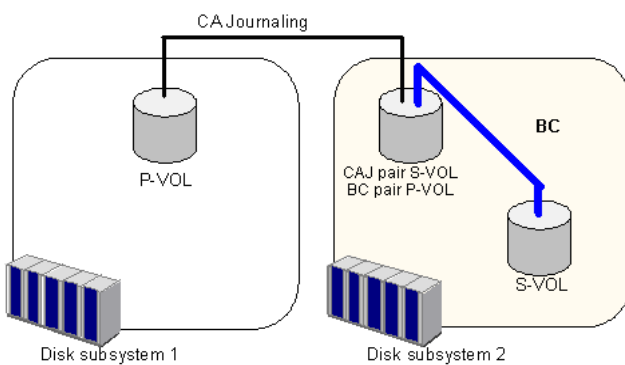
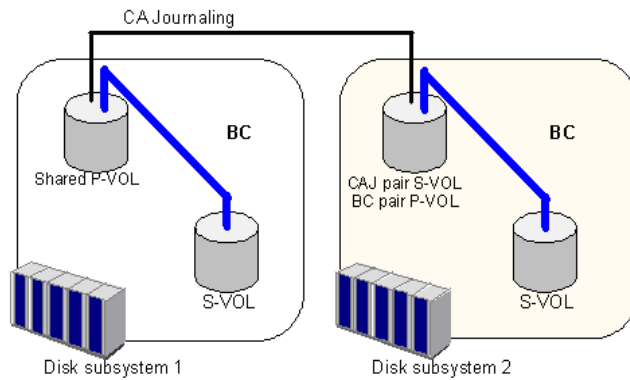

**Figure 249** BC and CA Journaling: Shared P-VOL and S-VOL

The configuration shown in [Figure 250](#) is an example of a volume that functions as both a CA Journaling P-VOL and a BC P-VOL, while the S-VOL of the same CA Journaling pair also functions as the P-VOL of another BC pair. This configuration allows you to:

- Use BC to provide on-site backup copies of CA Journaling P-VOLs and S-VOLs

- Use CA Journaling to provide remote backup of BC P-VOLs



**Figure 250** BC and CA Journaling: Shared P-VOL and P-VOL and P-VOL and S-VOL

## Combining BC and CA operations

BC and CA can function together in the same disk array to provide both internal and remote backup for important data.



### NOTE:

- BC is recommended for intra-disk array copy operations. If BC is not installed, use CA (synchronous only) to copy within the same local disk array. This CA configuration requires at least one external ESCON® cable loop (minimum of two is recommended).
- Combining BC L1 and L2 pairs with CA volumes is allowed. CA considers node and leaf volumes secondary volumes (S-VOLs).



**NOTE:** Reverse resync and quick restore operations cannot be performed on BC/ CA shared volume pairs.

The configuration shown in [Figure 251](#) is an example of a volume functioning as both a CA P-VOL and BC P-VOL. With this configuration, you can perform the following:

- Use BC to provide on-site backup copies of CA P-VOLs
- Use CA to provide remote backup copies of BC P-VOLs

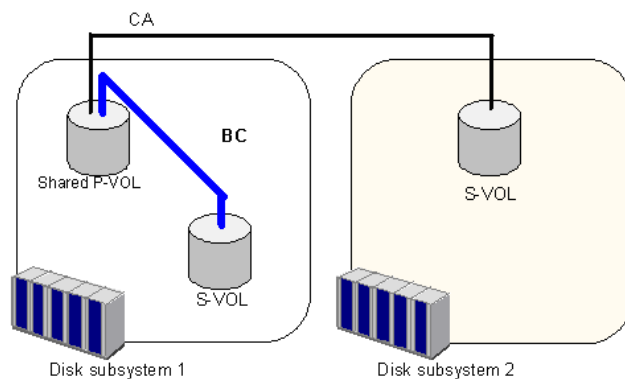

**Figure 251** BC and CA: shared P-VOL/P-VOL

The configuration shown in [Figure 252](#) is an example of a volume functioning as both a CA S-VOL and BC P-VOL. With this configuration, you can use BC to provide remote copies of CA S-VOLs.

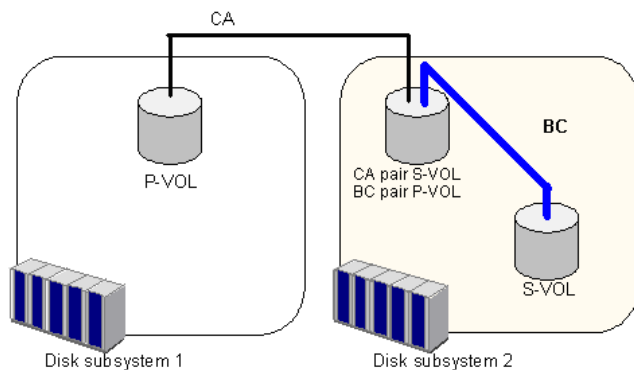

**Figure 252** BC and CA: shared P-VOL/S-VOL

The configuration shown in [Figure 253](#) is an example of a volume functioning as both a CA P-VOL and BC P-VOL, while the S-VOL of the same CA pair is also functioning as the P-VOL of another BC pair. With this configuration, you can perform the following:

- Use BC to provide on-site backup copies of CA P-VOLs and S-VOLs
- Use CA to provide remote backup of BC P-VOLs

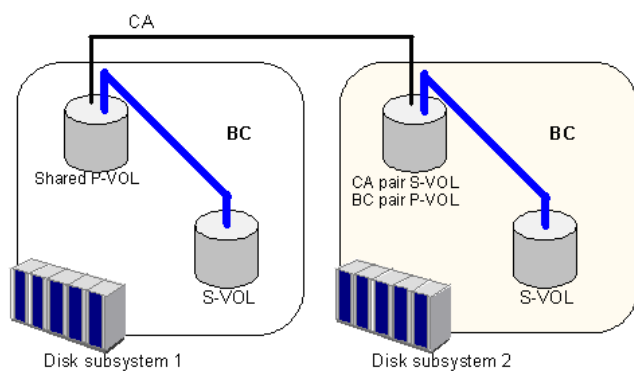
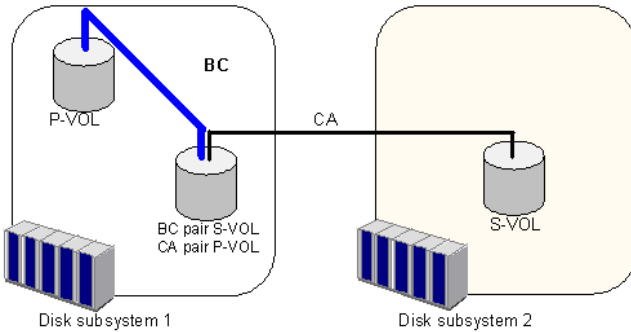

**Figure 253** BC and CA: shared P-VOL/P-VOL and P-VOL/S-VOL

The configuration shown in [Figure 254](#) is an example of a volume functioning as both a BC S-VOL and CA P-VOL. With this configuration, you can use CA to provide asynchronous remote copy.



**NOTE:** This configuration does not allow BC and CA to copy at the same time. Create the BC pair first, and then split the pair before creating the CA pair. You must suspend the CA pair to resync the BC pair. The CA pair status cannot be changed when the BC pair is in PSUS(SP) status.

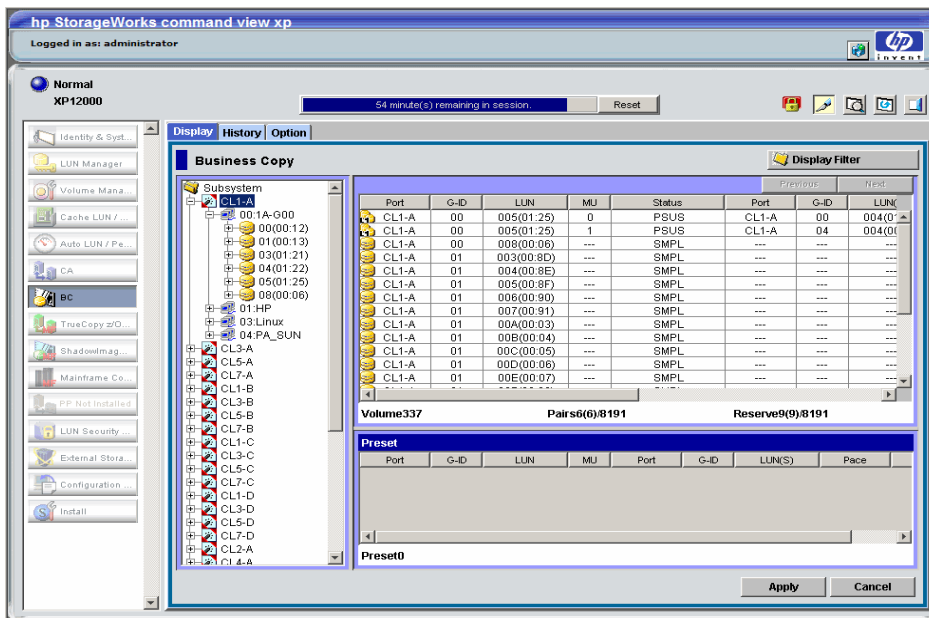

**Figure 254** BC and CA: shared S-VOL/P-VOL

## Starting BC

After you enable the BC feature on the Command View management station and prepare for BC operations, you are ready to start BC.

1. In the Device Launcher pane, click an XP128/XP1024/XP12000 link.
2. Click the **BC** button ( ). The BC main screen shows the name of the connected disk array, currently selected port, and all volumes (LUs) installed under the current port.



**Figure 255** BC main screen

You can now perform BC operations. You first need to reserve the volumes you plan to use as BC S-VOLs (see "Setting reserve attributes" on page 459 for instructions). You can then start adding BC pairs (see "Creating BC pairs (Paircreate)" on page 461 for instructions).



## BC main screen

The BC main screen displays BC volume and pair information for the selected port of the connected disk array and performs all BC operations. To open the BC main screen, click the **BC** button (). There are three tabs on the BC main screen: **Display**, **History**, and **Option**.







**NOTE:** When using an XP12000, some BC graphical interface labels differ from the labels on an XP128/XP1024. In the following sections of this document, XP12000 labels are included in parentheses.

The **Display** pane of the BC main screen has the following features:

- Use the **Tree View** box on the left side to select the port, host group, or defined P-VOL (pair).

The following icons appear in the tree:

**Table 90** BC tree icons

Icon	Meaning
	Port
	Host group
	LUN
	Root



**NOTE:** You can filter volumes or volume pairs displayed in the Volume list on the upper-right side of the **Display** tab by selecting a port, host group, or volume (P-VOL). To display all volumes and pairs, select **Port (Subsystem)** at the top of the Tree View box.



- The **Volume list** on the upper-right of the Display pane shows all available volumes on the port, host group, or P-VOL selected in the Tree View box. You can sort volumes by port, group, path, MU#, status, port (S-VOL), group (S-VOL), S-VOL path, copy pace, copy progress, volume emulation type, and capacity. You can also filter volumes by reserve attribute, pair condition, and pair status in the Display Filter window. To open the Display Filter window, click **Display Filter**, or select the **Display Filter** command from the shortcut menu.





**NOTE:** XP12000 only: The maximum number of volumes that can be displayed in the Volume List at a time is 1,024. If the number of volumes defined in the disk array exceeds this limit, use the **Previous** and **Next** buttons on the upper right of the Volume list to turn the pages of the Volume list to see the entire list.

- The following icons indicate the status of a volume or pair:

**Table 91** Status icons for BC

Icon	LDEV status
	L1 pair
	L2 pair

**Table 91** Status icons for BC (continued)

Icon	LDEV status
	S-VOL (node volume: <b>Secondary</b> , Leaf volume: <b>Leaf</b> )
	Reserved volume
	An error occurred during operations. This error icon is displayed in the Preset Volume list.

- The **Preset Volume list**, below the Volume list, displays the content of the operations (volume/pair information) that have been set or specified, but are not yet applied to the disk array.
- The **Volume/Pair Settings** box on the lower-right side displays:



**NOTE:** On the XP12000, the Volume/Pair Settings information is displayed above and below the Preset Volume list.

- **Preset:** Number of operations (volume/pair information) that have not been performed in the disk array. The Preset Volume list, located below the Volume list, displays preset operations. Click **Apply** to perform the specified operations displayed in the Preset Volume list.
- **Volume:** Total number of volumes defined in the disk array.
- **Reserve (XP128/1024):** X(Y)/Z, where:  
 X = total number of BC reserved volumes  
 Y = total number of BC reserved volumes  
 Z = maximum number of reserved volumes
- **Pair (XP128/1024):** X(Y)/Z, where:  
 X = total number of BC pairs  
 Y = total number of BC pairs  
 Z = maximum number of pairs (BC/HHSM)



**NOTE:** The value (Y) does not include HHSM pairs. If HHSM pairs exist, the BC paircreate operation may fail, even when (Y) is less than 4,095.

- **Pairs (XP12000):** X(Y)/Z, where:  
 X = total number of BC pairs  
 Y = total number of BC and ShadowImage for z/OS® pairs  
 Z = maximum number of pairs that can be created in one array (BC/ShadowImage for z/OS® /Auto LUN XP/Flex Copy)



**NOTE:** The value (Y) does not include Auto LUN XP/Flex Copy pairs. If Volume Migration/Cross-system Copy pairs exist, BC paircreate operation may fail, even when (Y) is less than 8,192.

- **Reserve (XP12000):** X(Y)/Z, where:  
 X = total number of BC reserved volumes  
 Y = total number of BC and ShadowImage for z/OS® reserved volumes  
 Z = maximum number of reserved volumes that can be created in one subsystem (BC/ShadowImage for z/OS® /Auto LUN XP/Flex Copy)



**NOTE:** The value (Y) does not include Auto LUN XP/Flex Copy pairs. If Auto LUN XP/Flex Copy pairs exist, the BC paircreate operation may fail even when (Y) is less than 8,192.

- Use the **Display Filter** button to filter volumes displayed in the Volume list.
- The **Previous** button (XP12000 only) returns to the previous page of the Volume list. This button is available only when the number of volumes defined in the disk array exceeds 1,024, which is the maximum number of volumes that can be displayed on one page. The button is unavailable if the total number of defined volumes is less than 1,024.
- The **Next** button (XP12000 only) displays the next page of the Volume list. This button is available only when the number of volumes defined in the disk array exceeds 1,024, which is the maximum number of volumes that can be displayed on one page. The button is unavailable if the total number of defined volumes is less than 1,024.
- The **Apply** button performs BC operations displayed in the Preset Volume list in the disk array. If the specified operations complete successfully, the Preset Volume list is cleared. If an error occurs during an operation, the failed operation remains in the Preset Volume list. To display the error code and message for the failed operation, select the **Detail** command.
- The **Cancel** button cancels all operations specified on the **Display** tab.

To perform BC operations for volume(s), select one or more volumes in the Volume list, right-click, and select the command (see “Volume list” on page 453 and Table 92).

For information about the **History** and **Option** tabs of the BC main screen, see “Viewing BC pair status and history” on page 475 and “Setting BC options” on page 477.

## Volume list

The Volume list (Figure 256) displays volume/pair information based on filter options selected in the Tree View box (along the left side of the screen).



**NOTE:** You can select up to 512 volumes/pairs in the Volume list.



**NOTE:** XP12000 only: The maximum number of volumes displayed in the Volume List is 1,024. If the number of volumes defined in the disk array exceeds this limit, use the **Previous** and **Next** buttons on the upper right of the Volume list to turn the pages of the Volume list to see the entire list.

Port	G-ID	LUN	MU	Status	Port	G-ID	LUN(S)	CTG	SvolMode	CopyPace	Prog./Sync.	Type	Capacity(MB)
CL1-A	00	005(01:25)	0	PSUS	CL1-A	00	004(01:22)	---	---	---	100%	OPEN-8	7007.34
CL1-A	00	005(01:25)	1	PSUS	CL1-A	04	004(00:0F)	---	---	---	100%	OPEN-8	7007.34
CL1-A	00	008(00:06)	---	SMPL	---	---	---	---	---	---	---	OPEN-8	7007.34
CL1-A	01	003(00:8D)	---	SMPL	---	---	---	---	---	---	---	OPEN-8	7007.34
CL1-A	01	004(00:8E)	---	SMPL	---	---	---	---	---	---	---	OPEN-8	7007.34
CL1-A	01	005(00:8F)	---	SMPL	---	---	---	---	---	---	---	OPEN-8	7007.34
CL1-A	01	006(00:90)	---	SMPL	---	---	---	---	---	---	---	OPEN-8	7007.34
CL1-A	01	007(00:91)	---	SMPL	---	---	---	---	---	---	---	OPEN-8	7007.34
CL1-A	01	00A(00:03)	---	SMPL	---	---	---	---	---	---	---	OPEN-8	7007.34
CL1-A	01	00B(00:04)	---	SMPL	---	---	---	---	---	---	---	OPEN-8	7007.34
CL1-A	01	00C(00:05)	---	SMPL	---	---	---	---	---	---	---	OPEN-8	7007.34
CL1-A	01	00D(00:06)	---	SMPL	---	---	---	---	---	---	---	OPEN-8	7007.34
CL1-A	01	00E(00:07)	---	SMPL	---	---	---	---	---	---	---	OPEN-8	7007.34

**Figure 256** Volume list

The Volume list contains all installed volumes (LUs) on the selected port and displays the following information for each volume:

- **Port:** Port ID (cluster and channel number) of each volume. If L2 pairs exist, a different icon displays. To display detailed information on L2 pairs, double-click the corresponding S-VOL in the Volume list.
- **Group (G-ID):** Host group of each volume.
- **Path (LUN):** CU:LDEV (control unit image:logical device ID) of each volume.



**NOTE:** XP12000 only: An LDEV number ending with “#” indicates the LDEV is an external volume (for example, 00:01#).

- **MU:** MU number of a BC cascade pair formed with the volume.
- **Status:** BC pair status of the volume pair: **SMPL**, **COPY(PD)**, **PAIR**, **PSUS**, **COPY(RS)**, **PSUE**, **COPY(SP)**, **COPY(RS-R)**, **PSUS(SP)**, **SMPL (PD)**, **Secondary**, and **Leaf**.
- **Port:** Port ID (cluster and channel number) of the first S-VOL of each volume. If there is no S-VOL, --- is displayed.
- **Group (G-ID):** Host group of the S-VOL. If there is no S-VOL, --- is displayed.
- **S-Vol Path (LUNS):** CU:LDEV (control unit image:logical device ID) of the S-VOL. If there is no S-VOL, --- is displayed.



**NOTE:** XP12000 only: An LDEV number ending with “#” indicates the LDEV is an external volume (for example, 00:01#).

- **CTG:** Consistency group number of the S-VOL. If no consistency group is set for the S-VOL, --- is displayed.
- **SvolMode:** Status of the S-VOL.
  - **S-VOL Write:** When the S-VOL status is **COPY(SP)**, **PSUS(SP)**, or **PSUS** and the host writes to the S-VOL, **W** is displayed.
  - **Hide Mode:** When the S-VOL is set to hide mode, **N** is displayed.
- **Copy Pace:** Copy pace (**Slower**, **Medium**, or **Faster**) for the pair being created.
- **Progress (Prog/Sync):** If the volume pair is in **COPY** status, the copy progress (%) is displayed (for example, **0%** or **45%**). If there is no S-VOL, --- is displayed.
- **Type:** Device emulation type (for example, OPEN-3). For more information about emulation types, see [Table 80](#) on page 421.
- **Capacity (MB):** Storage capacity of the volume in MB.
- **CLPR (P):** The cache logical partition of the P-VOL is displayed.
- **CLPR (S):** the cache logical partition of the S-VOL is displayed.

You can perform BC operations for volume(s) in the Volume list by using the following shortcut menu commands (see also [Table 92](#)):

- **Detail:** Displays pair status for selected volume(s)/pair(s).
- **Paircreate:** Creates or adds new BC pairs.
- **Pairsplit:** Splits BC pairs.
- **Pairresync:** Resynchronizes BC pairs.

- **Pairsplit-E**: Suspends BC pairs.
- **Pairsplit-S**: Deletes BC pairs.
- **Change Reserve**: Sets and resets the BC reserve attribute.
- **S-Vol Path**: Displays the S-VOL's port, group, and path (LUN) of the selected pair.
- **Display Filter**: Filters volumes displayed in the Volume list. Clicking **Display Filter** is another method of accessing this command.

**Table 92** BC operations shortcut menu commands

Operation	Pair status								
	SMPL	COPY (PD)	PAIR	COPY (SP)	PSUS (SP)	PSUS	COPY (RS)	COPY (RS-R)	PSUE
Detail	Yes	Yes	Yes	Yes	Yes	Yes	Yes	Yes	Yes
Paircreate	Yes	No	No	No	No	No	No	No	No
Pairsplit	Yes	Yes	Yes	No	No	No	No	No	No
Pairresync	No	No	No	No	Yes	Yes	No	No	Yes
Pairsplit-E	No	Yes	Yes	Yes	Yes	Yes	Yes	Yes	No
Pairsplit-S	No	Yes	Yes	Yes	No	Yes	Yes	Yes	No
Change Reserve	Yes	No	No	No	No	No	No	No	No
S-Vol Path	No	Yes	Yes	Yes	Yes	Yes	Yes	Yes	Yes

## Detail window

This window displays information for the selected volume or pair. To open the Detail window, select a pair or volume in the Volume list, right-click, and select **Detail**. If the P-VOL of the selected pair has two or more S-VOLs sharing the same P-VOL, the Detail window displays all S-VOLs.

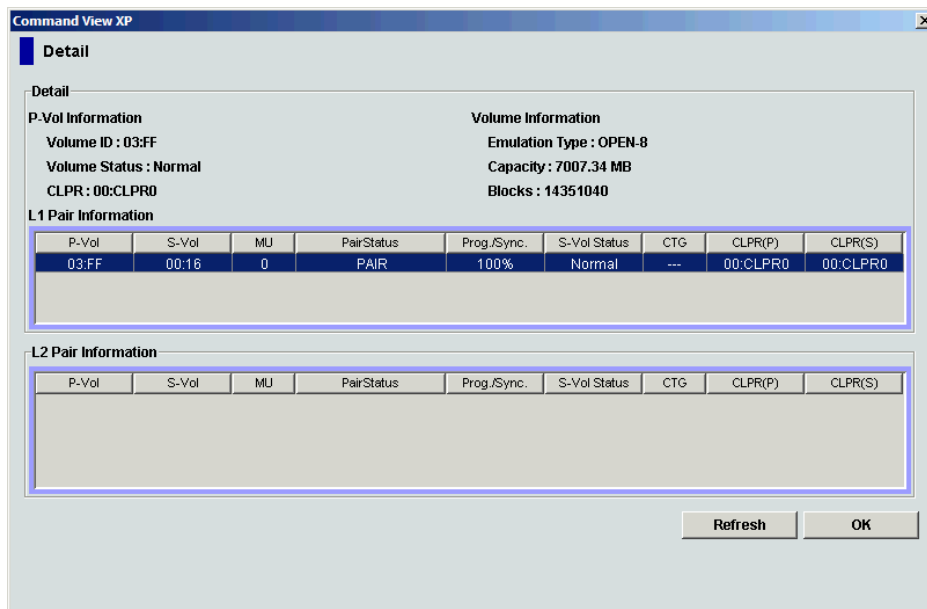

**Figure 257** Detail window

## S-Vol Path window

This window displays information on the selected pair (all paths defined for the S-VOL). To open the S-Vol Path window, select one or more pairs in the Volume list, right-click, and select **S-Vol Path**.

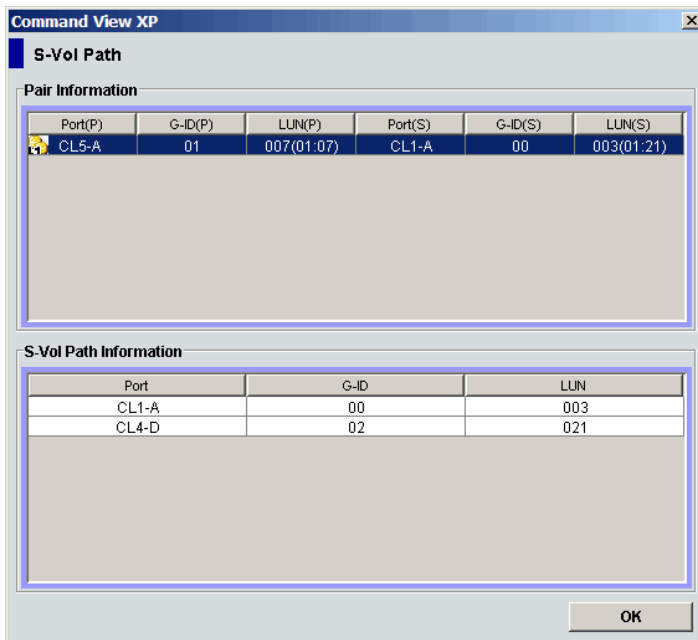

Figure 258 S-Vol Path window



**NOTE:** The **S-Vol Path** command is not available when selecting SMPL volumes.

## Display Filter window

This window filters volumes displayed in the Volume list by reserve attribute, pair condition, and pair status. To open the Display Filter window, click **Display Filter** on the BC main screen, or select any pair or volume in the Volume list, right-click, and select **Display Filter**.

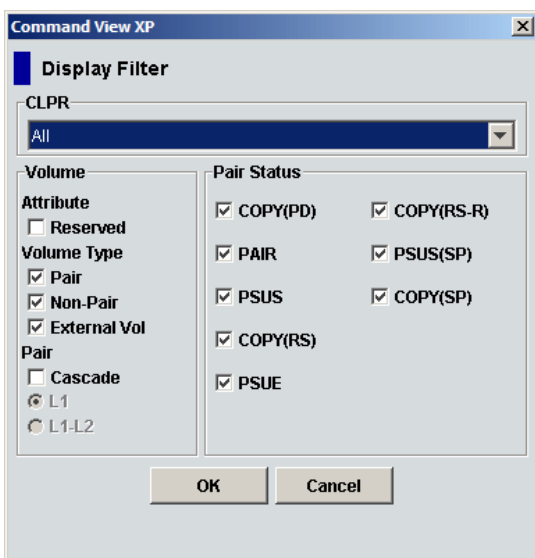

Figure 259 Display Filter window

The Display Filter window has the following features:

- The **CLPR** drop-down list displays the specified cache logical partition (CLPR).
- **Volume** box:
  - The **Reserve(d)** check box displays reserved or unreserved volumes. If you select the **Reserve(d)** check box, only reserved volumes are displayed in the Volume list. If you clear the **Reserve(d)** check box, only unreserved volumes are displayed.



**NOTE:** If you select the Reserved check box, you cannot select any other check boxes.



**NOTE:** Volumes specified as the S-VOL of a BC pair are automatically reserved by the disk array.

- The **Pair** check box displays paired volumes.
- The **Non-Pair** check box displays non-paired volumes.
- The **External Vol** check box (XP12000 only) displays external volumes.
- The **Cascade** check box filters the pairs in the Volume list by cascade level. Clicking **L1** displays L1 pairs only. Clicking **L1-L2** displays both L1 and L2 pairs.
- Use the **Pair Status** box to filter pairs displayed in the Volume list by pair status: **COPY(PD)**, **PAIR**, **PSUS**, **COPY(RS)**, **PSUE**, **COPY(RS-R)**, **PSUS(SP)**, and **COPY(SP)**. All check boxes are selected by default.
- The **OK** button applies the settings, and closes the Display Filter window.
- The **Cancel** button resets the settings, and closes the Display Filter window.



**NOTE:** Filter settings are only effective within the current BC session. If you switch to another program feature (such as LUN Management or CA) or click a button on the toolbar, the settings are reset.

## Preset Volume list

The Preset Volume list is located below the Volume list, and lists the specified operations (volume/pair information) that have not been performed in the disk array.

Preset							
Port	G-ID	LUN	MU	Port	G-ID	LUN(S)	Pace
CL5-A	01	007(01:07)	0	CL1-A	00	004(01:22)	Medium

**Figure 260** Preset Volume list

Use the Preset Volume list to hold multiple settings of the same operation only. You cannot display different types of operations (for example, pairsplit and pairresync) in the Preset Volume list at the same time. You can also cancel the operations in the Preset Volume list.

The Preset Volume list displays the following information of specified operations:

- **Port:** Port ID (cluster and channel number) of each volume. If L2 pairs exist, a different icon displays.
- **Group (G-ID):** Host group of each volume.
- **CLPR (P):** The cache logical partition (CLPR) of the P-VOL.

- **CLPR (S)**: The cache logical partition (CLPR) of the S-VOL.
- **Path (LUN)**: CU:LDEV (control unit image:logical device ID) of each volume.



**NOTE:** An LDEV number ending with “#” indicates the LDEV is an external volume (for example, 00:01#).

- 
- **MU**: MU number of a BC cascade pair member volume.
  - **Port**: Port ID (cluster and channel number) of the first S-VOL of each volume.
  - **Group (G-ID)**: Host group of the S-VOL.
  - **S-Vol Path (LUNS)**: CU:LDEV (control unit image:logical device ID) of the S-VOL.



**NOTE:** An LDEV number ending with “#” indicates the LDEV is an external volume (for example, 00:01#).

- 
- **Pace**: Copying pace for all pairs being created: **Slower**, **Medium**, and **Faster**.
  - **Code**: If the specified option in the Preset Volume list is performed by clicking **Apply**, but the operation fails, the reason code is displayed.

To perform the specified operations, click **Apply** on the BC main screen. When all operations are performed successfully, the Preset Volume list is cleared. However, failed operations remain in the Preset Volume list. You can also cancel one or all operations by using the following shortcut menu commands:

- **Delete**: Cancels the selected operation only. To display the **Delete** command, select a volume or pair, and right-click.
- **Delete All**: Cancels all operations displayed in the Preset Volume list. To display the **All Delete** command, deselect any volume or pair, and right-click.
- **Detail**: Displays the Error window, which lists error code and message for the failed operation. For the BC error codes, see [Table 94](#) on page 478.



# Performing BC operations

## Setting reserve attributes

Use the Set Reserve Attribute window to set the reserve attribute for volume(s) selected on the BC main screen. To open the Set Reserve Attribute window, select one or more unreserved SMPL volumes in the Volume list on the BC main screen, right-click, and click **Change Reserve**.

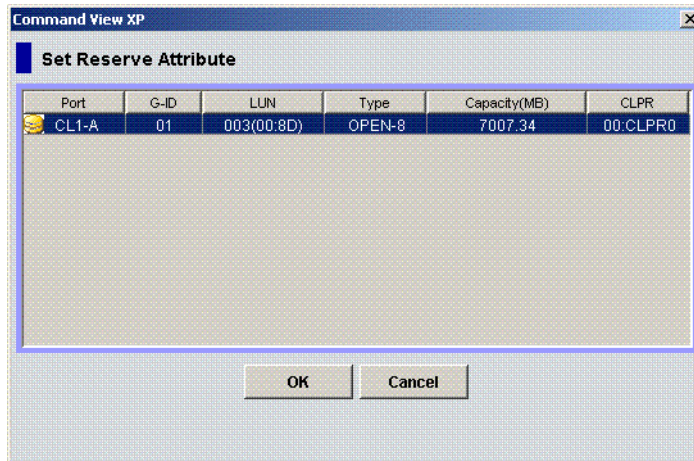

**Figure 261** Set Reserve Attribute window

The Set Reserve Attribute window displays unreserved volume selected on the BC main screen. Clicking **OK** sets the reserve attribute for unreserved volume.

The setting is displayed in the Preset Volume list on the BC main screen. The **Cancel** button closes the Set Reserve Attribute window without reflecting the settings. To apply the settings to the disk array, click **Apply** on the BC main screen.

## Reserving one or more volumes for use as BC S-VOLs

1. Unmount the volume(s) you want to reserve. The disk array rejects all write I/Os to reserved volumes (except when in PSUS status).
2. From the BC main screen, select the port, host group, or LUN in the Tree View box.
3. Display reserved SMPL volumes in the **Volume List**.



**NOTE:** To display unreserved SMPL volumes in the Volume List, open the Display Filter window, clear the **Reserved** and **Pair** check boxes, select the **Non-Pair** check box, and click **OK**.

4. Select the volume(s), right-click, and select **Change Reserve**. The Set Reserve Attribute window appears. If the **Change Reserve** command is not enabled, you selected paired volumes. Select only unreserved and unpaired volumes.
5. From the Set Reserve Attribute window, select the volumes you want to reserve, and click **OK**.  
The setting is reflected in the Preset Volume list on the BC main screen.
6. From the BC main screen, click **Apply**.
7. Verify that the settings are reflected in the disk array. To check the attribute, click **Display Filter**.



**NOTE:** You can check whether the attribute setting is updated on the Display Filter window. To open the Display Filter window, click **Display Filter**.

## Resetting reserve attributes

Use the Reset Reserve Attribute window to reset the reserve attribute for the volume selected on the BC main screen. To open the Reset Reserve Attribute window, select one or more reserved SMPL volumes in the Volume list on the BC main screen, right-click, and click **Change Reserve**.

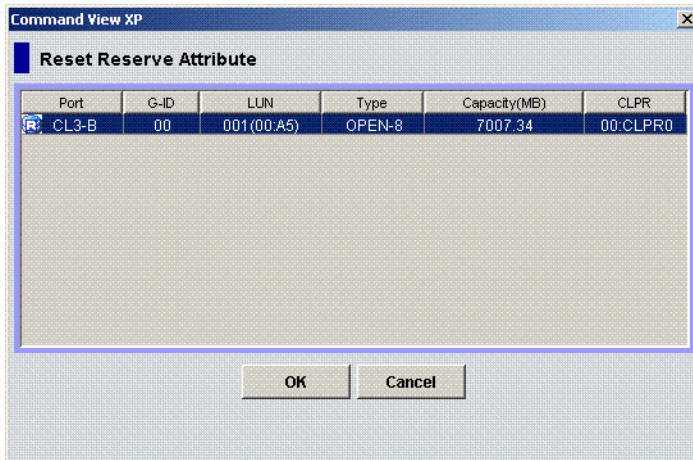

**Figure 262** Reset Reserve Attribute window

The Reset Reserve Attribute window displays the reserved volume selected on the BC main screen. Clicking **OK** resets the reserve attribute for reserved volume.

The settings are displayed in the Preset Volume list on the BC main screen. The **Cancel** button closes the Reset Reserve Attribute window without reflecting the settings. To apply the settings to the disk array, click **Apply** on the BC main screen.

## Unreserving one or more volumes

1. Ensure that the volumes you want to unreserve are no longer assigned to BC pairs as S-VOLs. See "[Suspending BC pairs \(Pairsplit-E\)](#)" on page 473 for instructions on deleting BC pairs.
2. In the BC main screen, select the port, host group, or LUN in the Tree View box.
3. To display reserved SMPL volumes in the Volume list, open the Display Filter window, select the **Reserve(d)** check box, and click **OK**.
4. Select the volumes, right-click, and select **Change Reserve**. The Reset Reserve Attribute window appears. If the **Change Reserve** command is not enabled, you selected paired volumes. Select only reserved and unpaired volumes.
5. In the Reset Reserve Attribute window, select the volume you want to unreserve, and click **OK**.  
The setting is reflected in the Preset Volume list on the BC main screen.
6. In the BC main screen, click **Apply**.
7. Verify that the settings are reflected in the disk array. To check the attribute, click **Display Filter**.

# Creating BC pairs (Paircreate)

**CAUTION:** The BC paircreate operation overwrites all existing data on the S-VOLs. You are responsible for backing up data on the S-VOLs before creating BC pairs.

The Paircreate window displays P-VOL and S-VOL information for the pair(s) being created (added). Use the Paircreate window to select the S-VOL(s) for each P-VOL, set the copy pace for all pairs being created, and start the paircreate operation(s). To open the Paircreate window, select one or more SMPL volumes or PSUS pairs in the Volume list on the BC main screen, right-click the selected volume(s), and select **Paircreate**.

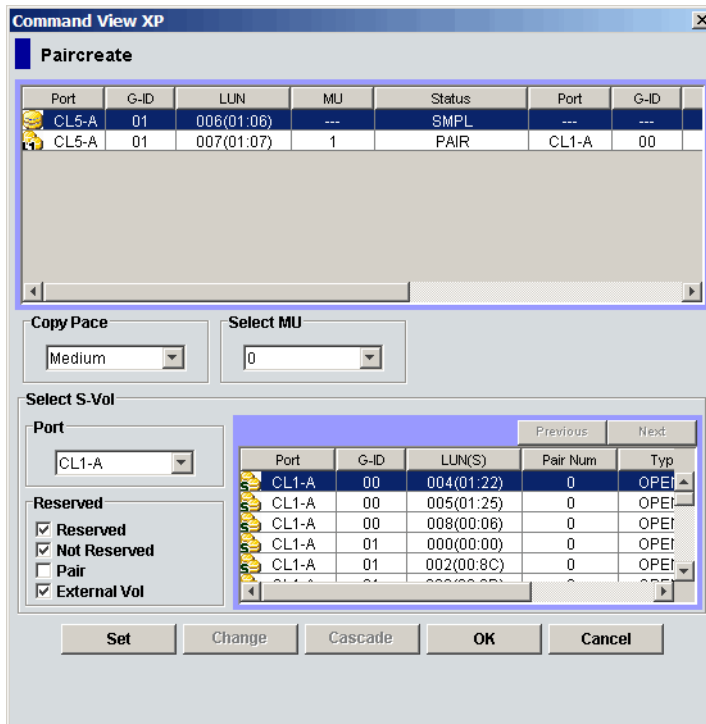

**Figure 263** Paircreate window

The Paircreate panel consists of the following components:

- "Paircreate Volume List" on page 461
- "Copy Pace list" on page 462
- "Select MU list" on page 462
- "Select S-Vol box" on page 463
- "Buttons" on page 463
- "Creating L1 pairs" on page 464
- "Creating L2 pairs" on page 465

## Paircreate Volume List

The Volume List in the upper half of the Paircreate window displays the following information about the P-VOL and S-VOL used for creating a pair:



---

**NOTE:** The S-VOL for each P-VOL is displayed only after being selected (using **Set** or **Change**).

---

- **Port:** Port ID (cluster and channel number) of the P-VOL.
  - **Group (G-ID):** Host group ID of the P-VOL.
  - **(Path) LUN:** CU:LDEV of the P-VOL.
- 



**NOTE:** XP12000 only: An LDEV number ending with “#” indicates the LDEV is an external volume (for example, 00:01#).

---

- **MU:** MU number of the P-VOL.
  - **Status:** Status of the P-VOL.
  - **Port:** Port ID (cluster and channel number) of the first S-VOL of each volume pair.
  - **Group (G-ID):** Host group ID of the S-VOL.
  - **SvolMode (LUN(S)):** CU:LDEV of the S-VOL.
- 



**NOTE:** XP12000 only: An LDEV number ending with “#” indicates the LDEV is an external volume (for example, 00:01#).

---

- **Type:** Emulation type of the P-VOL and S-VOL.
  - **Capacity (MB):** Volume capacity displayed in megabytes (MB).
  - **CLPR(P):** XP12000 only: Cache logical partition of the P-VOL.
  - **CLPR(S):** XP12000 only: Cache logical partition of the S-VOL.
- 

## Copy Pace list

Use the **Copy Pace** list to select the copy pace for all pairs being created: **Slower**, **Medium**, and **Faster**.

---



**NOTE:** When the Preset List already holds Paircreate settings, and you specify a different copy pace for new pairs in the Paircreate panel, the copy pace for the existing paircreate settings displayed in the Preset List are also changed. The latest copy pace specified in the Paircreate panel is in effect before the settings are reflected to the disk array.

---

## Select MU list

Use the **Select MU** list to select the MU number for each pair being created: **0**, **1**, and **2** for L1 pairs, and **1** and **2** for L2 pairs.

---



**NOTE:** You can select an MU number for a cascade pair. You cannot select the same MU number for different cascade pairs of the same P-VOL (root or node volume).

---

## Select S-Vol box

The **Select S-Vol** box filters S-VOLs displayed in the S-VOL list. Use the **Port** list and **Reserved** check boxes to display available S-VOLs by port and reserve attribute. Use the **Reserved** box to select pairs that can be set as L2 pairs when the **Pair** check box is selected, and (XP12000 only) external volumes when the **External Vol** check box is selected.



**NOTE:** External volumes can be selected only when the External Storage XP features are available.

---



**NOTE:** XP12000 only: The number of secondary volumes that can be displayed in the S-VOL List at a time is limited to 1,024. If the number of volumes defined in the disk array exceeds this limit, use the **Previous** and **Next** buttons on the upper right of the S-VOL List to turn the pages of the S-VOL List and see the entire list.

---

- Use the **Previous** button to return to the previous page of the S-VOL List. This button is selectable only when the number of volumes defined in the disk array exceeds 1,024, which is the maximum number of volumes that can be displayed on one page. The button is unavailable if the total number of volumes defined in the disk array is less than 1,024 volumes.
- Use the **Next** button to turn to the next page of the S-VOL List. This button is selectable only when the number of volumes defined in the disk array exceeds 1,024, which is the maximum number of volumes that can be displayed on one page. The button is unavailable if the total number of volumes defined in the disk array is less than 1,024 volumes.
- The S-VOL List displays the following information related to S-VOLs:
  - **Port:** Port ID (cluster and channel number) of the S-VOL
  - **Group (G-ID):** Host group ID of the S-VOL
  - **S-Vol Path (LUN):** CU:LDEV of the S-VOL
  - **Pair Num:** Number of pairs
  - **Type:** Emulation type of the S-VOL
  - **Capacity (MB):** Capacity of the S-VOL in megabytes (MB)
  - **CLPR:** The cache logical partition (CLPR) of the S-VOL.

## Buttons

- **Set:** Adds the selected S-VOL and P-VOL to the Paircreate Volume List as an L1 pair.
- **Change:** Replaces the existing S-VOL of the selected L1 pair (meaning the S-VOL of the pair after completing the operation selected in the Paircreate Volume List) with the selected S-VOL.
- **Cascade:** Adds the selected S-VOL and P-VOL (node volume) to the Paircreate Volume List as a L2 pair. To use the **Cascade** button, select one of the listed L1 pairs.
- **OK:** Adds the operation (setting) to create a new pair using the P-VOL and S-VOL selected in the Paircreate panel to the Preset List on the BC main panel.



**NOTE:** To apply the new pair operation setting displayed in the Preset List to the disk array, click **Apply** on the BC main screen.

---

- **Cancel:** Cancels the operations set in the Paircreate panel and closes the Paircreate panel.

To remove any volumes from the Paircreate Volume List or S-VOL List, select the volumes, right-click the selected volumes, and select **Delete**.

## Creating L1 pairs

To create new BC pairs and split them immediately so you can access the S-VOLs as soon as possible, use the pairsplit operation instead of the paircreate operation (see “[Splitting BC pairs \(Pairsplit\)](#)” on page 465).

1. Ensure that the S-VOL(s) are unmounted.
2. In the BC main screen, select the port, host group, or P-VOL in the Tree View box to filter the volumes displayed in the Volume list.
3. Select the P-VOL(s) for the new pair(s), right-click the selected P-VOL(s), and select **Paircreate**. The Paircreate window appears.

Port	G-ID	LUN	MU	Status	Port	G-ID	LUN
CL5-A	01	001(01:01)	1	PAIR	CL1-A	00	000(0)
CL5-A	01	003(01:03)	---	SMPL	---	---	---
CL5-A	01	004(01:04)	---	SMPL	---	---	---
CL5-A	01	007	---	PAIR	CL1-A	00	003(0)
CL5-A	01	008	---	SMPL	---	---	---
CL5-A	01	009	---	SMPL	---	---	---
CL5-A	01	00A	---	SMPL	---	---	---
CL5-A	02	000	---	PAIR	CL1-A	00	001(0)
CL5-A	02	001	---	SMPL	---	---	---
CL5-A	02	002	---	SMPL	---	---	---
CL5-A	02	003	---	SMPL	---	---	---
CL5-A	02	004	---	SMPL	---	---	---
CL5-A	02	005	---	SMPL	---	---	---



**NOTE:** Do not select reserved volumes.

4. Set the initial copy pace for all pairs being created: **Slower**, **Medium**, or **Faster**.
5. Verify that the Paircreate window displays the P-VOL(s). To remove any volumes from the list, select the volume(s), right-click the volume(s), and select **Delete**.
6. Select the S-VOL(s) for each P-VOL as follows:
  - a. Select the P-VOL in the Paircreate window.
  - b. In the **Select MU** list, select the MU number for the L1 pair being created: **0**, **1**, or **2**.
  - c. Select the port in the **Port** list, select the **Reserved** check box to display reserved volumes, and select the S-VOL.



**NOTE:** You can select an unreserved volume as the S-VOL. When you create the pair, the disk array changes the reserve attribute to “reserved” automatically.

- d. Click **Set** to create (add) the S-VOL to the selected P-VOL. The S-VOL is displayed next to the selected P-VOL.
  - e. To add a second and third S-VOL to the same P-VOL, repeat [step 6b](#) - [step 6d](#). Each pair to be created is displayed separately in the list of pairs in the Paircreate window.
7. Repeat [step 6](#) until all pairs are displayed. Click **Change** to replace an S-VOL, click **Set** to add an S-VOL, and use the **Delete** command to remove pairs.
  8. When the Paircreate window displays the new pair(s), click **OK** to reflect all pairs (settings) in the list to the Preset Volume list on the BC main screen.
  9. From the BC main screen, click **Apply** to create the pair(s).

When the initial copy operation(s) start, the BC main screen shows new pairs with COPY(PD) status and progress (%) of the initial copy operation(s).

10. Click **Refresh** (  ) to monitor the progress of the initial copy operation(s).



**CAUTION:** The L2 paircreate operation overwrites all existing data on the L2 S-VOLs. You are responsible for backing up the data on the S-VOLs before creating BC pairs.

---

## Creating L2 pairs

1. Ensure that the L2 S-VOLs are unmounted.
2. In the BC main screen, select the L1 pair(s) to which you want to add the L2 pair(s), right-click the selected L1 pair(s), and select **Paircreate**. The Paircreate window appears.
3. In the Paircreate window, select the L1 node volume, select the MU number (**1** or **2**) in the **Select MU** list, and select the S-VOL for the new L2 pair (MU=0 was already used as the L1 S-VOL).
4. Click **Cascade** to add the L2 pair to the list of pairs.
5. Repeat until all L2 pairs are displayed. Click **Change** to replace an S-VOL, click **Cascade** to add an S-VOL, and use the **Delete** command to remove pairs.
6. When the Paircreate window displays all new pairs, click **OK** to reflect all pairs (settings) in the list to the Preset Volume list on the BC main screen.
7. In the BC main screen, click **Apply** to create the pair(s).

When the initial copy operation(s) start, the BC main screen shows new pairs with COPY(PD) status and progress (%) of the initial copy operation(s).

8. Click **Refresh** (  ) to monitor the progress of the initial copy operation(s).

## Splitting BC pairs (Pairsplit)

The Pairsplit window displays volume and pair information for volume(s) and/or pair(s) selected on the BC main screen. Use the Pairsplit window to split existing BC pairs, or simultaneously create and split new BC pairs (see "Creating and splitting pairs" on page 469). To open the Pairsplit window, select

volume(s) or pair(s) in the Volume list on the BC main screen, right-click the selected volume(s) or pair(s), and click **Pairsplit**.

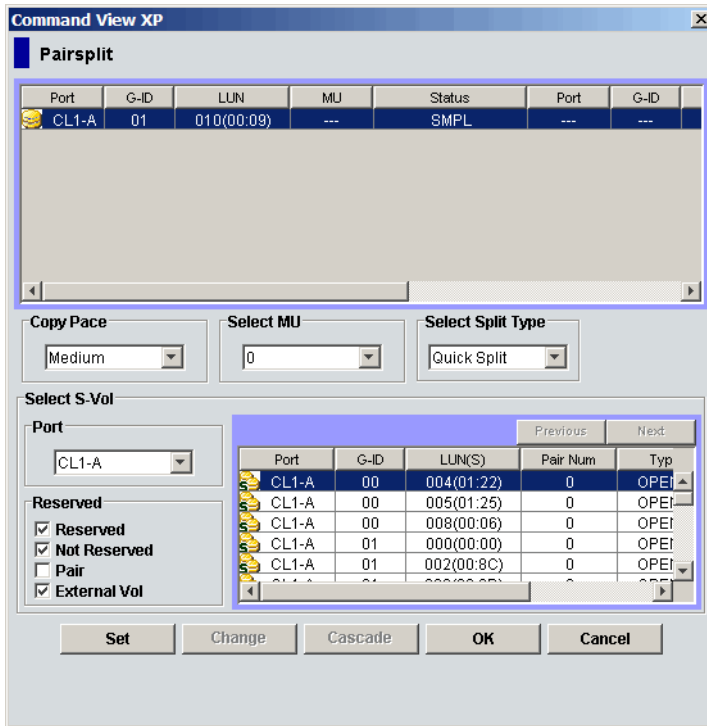

**Figure 264** Pairsplit window

The Pairsplit window consists of the following components:

- "Pairsplit Volume List" on page 466
- "Window options" on page 467
- "Select S-Vol box" on page 467
- "Buttons" on page 468
- "Splitting pairs" on page 468
- "Creating and splitting pairs" on page 469

## Pairsplit Volume List

This list in the upper half of the Pairsplit panel displays the following information about the P-VOL and S-VOL of the pair you want to split:

- **Port:** Port ID (cluster and channel number) of the P-VOL
- **Group (G-ID):** Host group ID of the P-VOL
- **(Path) LUN:** CU:LDEV of the P-VOL



**NOTE:** XP12000 only: An LDEV number ending with "#" indicates the LDEV is an external volume (for example, 00:01#).

- **MU:** MU number of the P-VOL
- **Status:** Status of the P-VOL



- **Port:** Port ID (cluster and channel number) of the first S-VOL of each volume pair
- **Group (G-ID):** Host group ID of the S-VOL
- **SvolMode (LUN(S)):** CU:LDEV of the S-VOL



**NOTE:** XP12000 only: An LDEV number ending with “#” indicates the LDEV is an external volume (for example, 00:01#).

- **Type:** Emulation type of the P-VOL and S-VOL
- **Capacity (MB):** Volume capacity displayed in megabytes (MB)
- **CLPR(P):** XP12000 only: Cache logical partition of the P-VOL
- **CLPR(S):** XP12000 only: Cache logical partition of the S-VOL

## Window options

### Copy Pace list

Use this list to select the copy pace (Slower, Medium, or Faster) for all pairs you are splitting. The **Set** button applies the same copy pace to all pairs you are splitting.

### Select MU list

Use this list to select the MU number for each pair being created: **0**, **1**, and **2** for L1 pairs, and **1** and **2** for L2 pairs.



**NOTE:** You can select a MU number for a cascade pair. You cannot select the same MU number for different cascade pairs of the same P-VOL (root or node volume).

### Select Split Type list

Use this list to select the pairsplit type: **Quick Split** or **Steady Split**.

## Select S-Vol box

This box filters S-VOLs displayed in the S-VOL list. Use the **Port** list and **Reserved** check boxes to display available S-VOLs by port and reserve attribute. Also use the **Reserved** box to select the pairs that can be set as L2 pairs when the **Pair** check box is selected, and (XP12000 only) external volumes when the **External Vol** check box is selected.



**NOTE:** External volumes can be selected only when the External Storage XP features are available.



**NOTE:** XP12000 only: The number of secondary volumes that can be displayed in the S-VOL List at a time is limited to 1,024. If the number of volumes defined in the disk array exceeds this limit, use the **Previous** and **Next** buttons on the upper right of the S-VOL List to turn the pages of the S-VOL List and see the entire list.

- Use the **Previous** button to return to the previous page of the S-VOL List. This button is selectable only when the number of volumes defined in the disk array exceeds 1,024, which is the maximum number

of volumes that can be displayed on one page. The button is unavailable if the total number of volumes defined in the disk array is less than 1,024.

- Use the **Next** button to turn to the next page of the S-VOL List. This button is selectable only when the number of volumes defined in the disk array exceeds 1,024, which is the maximum number of volumes that can be displayed on one page. The button is unavailable if the total number of volumes defined in the disk array is less than 1,024.
- The S-VOL List displays the following information related to S-VOLs:
  - **Port:** Port ID (cluster and channel number) of the S-VOL
  - **Group (G-ID):** Host group ID of the S-VOL
  - **S-Vol Path (LUN):** CU:LDEV of the S-VOL
  - **Pair Num:** Number of pairs
  - **Type:** Emulation type of the S-VOL
  - **Capacity (MB):** Capacity of the S-VOL in megabytes (MB)
  - **CLPR:** The cache logical partition (CLPR) of the S-VOL

## Buttons

- **Set:** Adds the selected S-VOL and P-VOL to the Pairsplit Volume List as an L1 pair.
- **Change:** Replaces the existing S-VOL of the selected L1 pair (that is, the S-VOL of the pair after completing the operation selected in the Pairsplit Volume List) with the selected S-VOL.
- **Cascade:** Adds the selected S-VOL and P-VOL (node volume) to the Pairsplit Volume List as an L2 pair. To use the **Cascade** button, select one of the listed L1 pairs.
- **OK:** Adds the operation (setting) to split a pair composed of the P-VOL and S-VOL selected in the Pairsplit panel to the Preset List on the BC main panel.



**NOTE:** To apply the new setting displayed in the Preset List to the disk array, click **Apply** on the BC main screen.

- 
- **Cancel:** Cancels the operations set in the Pairsplit panel and closes the Pairsplit panel.

To remove any volumes from the Pairsplit Volume List or the S-VOL List, select the volumes, right-click the selected volumes, and select **Delete**.

## Splitting pairs

1. If you want the split S-VOLs to be identical to the P-VOLs, stop all write operations to the P-VOLs before splitting the pairs. This ensures there are no updates to the P-VOLs while the pairsplit operations are synchronizing the S-VOLs to the P-VOLs.



**CAUTION:** The P-VOL and S-VOL are synchronized only when the pair status changes from COPY(SP) or PSUS(SP) to PSUS. Due to the BC asynchronous update copy operations, this status transition can take several minutes.

2. In the BC main screen, select the port, host group, or P-VOL in the Tree View box to filter the volumes displayed in the Volume list.

3. Select the pair(s) you want to split, right-click the selected P-VOL(s), and select **Pairsplit**. The Pairsplit window appears. You cannot split a suspended (PSUE) pair.

Port	G-ID	LUN	MU	Status	Port	G-ID	LUN(S)
CL5-A	01	001(01:01)	1	PAIR	CL1-A	00	000(00:1)
CL5-A	01	003(01:03)	---	SMPL	---	---	---
CL5-A	01	004(01:04)	---	SMPL	---	---	---
CL5-A	01	007(01:07)	1	PAIR	CL1-A	00	003(01:2)
CL5-A	01	008(01:08)	---	PL	---	---	---
CL5-A	01	009(01:09)	---	PL	---	---	---
CL5-A	01	00A(01:0A)	---	PL	---	---	---

4. In the Pairsplit window, set the copy pace (**Slower, Medium, or Faster**) for all pairs being split. If you change the setting, the latest setting is applied to all pairs
5. Set the split type (**Quick Split or Steady Split**) for each pair being split. The split type is set for all pairs being split. If you change the setting, the latest setting is applied to all pairs.
6. When the Pairsplit window displays the pair(s) you want, click **OK** to add all pairs to the Preset Volume list on the BC main panel. Use the **Delete** command to remove any pairs from the list.
7. In the BC main screen, click **Apply** to split the pair(s).

When the pairsplit operation(s) start, the BC main screen shows new pairs with COPY(SP) or PSUS(SP) status and progress (%) of the update copy operation(s). The PSUS status is displayed right away if there were no pending update copy operations

8. Click **Refresh** (🔄) to monitor the progress of the pairsplit operation(s).

## Creating and splitting pairs

Use the pairsplit operation to simultaneously create and split new BC pairs. In this case, the pairsplit operation changes the pair status from SMPL to COPY(SP) or PSUS(SP), copies all data on the P-VOL to the S-VOL, and changes the pair status to PSUS.

1. If you want the split S-VOLs to be identical to the P-VOLs, stop all write operations to the P-VOLs before creating and splitting the pairs. This ensures there are no updates to the P-VOLs while the pairsplit operations are synchronizing the S-VOLs to the P-VOLs.

**CAUTION:** The P-VOL and S-VOL are synchronized only when the pair status changes from COPY(SP) or PSUS(SP) to PSUS. Due to the BC asynchronous update copy operations, this status transition can take several minutes.

2. In the BC main screen, select the port, host group, or P-VOL in the Tree View box to filter the volumes displayed in the Volume list.
3. Select the volume(s) that will be the P-VOL(s) of the new pairs to be created and split, right-click the selected P-VOL(s), and select **Pairsplit**. The Pairsplit window appears.
4. Set the copy pace (**Slower, Medium, or Faster**) and split type (**Quick or Steady**) for all pairs being created and split.
5. Specify the S-VOL(s) as follows:
  - a. Select the P-VOL.
  - b. In the **Select MU** list, select the MU number (**0, 1, or 2**) for the L1 pair to be created.
  - c. Select the port in the **Port** list, display either reserved or unreserved volumes, and click the S-VOL.

- d. Click **Set** to add the S-VOL to the selected P-VOL. The S-VOL is now displayed next to the selected P-VOL.
- e. To add another S-VOL to the same P-VOL, repeat [step 5c](#) - [step 5d](#). Each pair to be created and split is displayed separately in the list of pairs.
6. Repeat [step 5](#) until the L1 pair(s) are displayed. Click **Change** to replace S-VOLs, click **Set** to add L1 S-VOLs, and use the **Delete** command to remove pairs.
7. To create and split L2 cascade pairs, add the L2 S-VOL(s) to the L1 pairs as follows:
  - a. Select the L1 pair from the list of pairs to be created and split.
  - b. Ensure that the L1 pairs are split (status = PSUS).
  - c. In the **Select MU** list, select the MU number (**1** or **2**) for the L2 pair to be created.
  - d. From the Pairsplit Volume List, select the volume to assign as the S-VOL for the L2 pair.
  - e. Click **Cascade** to add the L2 S-VOL to the selected L1 pair. The new L2 pair is now displayed.
  - f. To add another L2 S-VOL to the same L1 pair, repeat [step 7b](#) - [step 7e](#). Each L2 pair to be created and split is displayed separately in the list of pairs.
8. Repeat [step 7](#) until the pair(s) are displayed. Click **Change** to replace S-VOLs, click **Cascade** to add L2 S-VOLs, and use the **Delete** command to remove pairs.
9. When the Pairsplit window displays the L1 and L2 pair(s), click **OK** to reflect the settings to the Preset Volume list on the BC main screen.
10. In the BC main screen, click **Apply** to create and split the pair(s).  
When the pairsplit operation(s) start, the BC main screen shows new pairs with COPY(SP) or PSUS(SP) status.
11. Click **Refresh** (  ) to monitor the progress of the pairsplit operation(s).

## Resynchronizing BC pairs (Pairresync)

The Pairresync window displays pair information for pairs selected on the BC main screen. Use the Pairresync window to resynchronize pairs. To open the Pairresync window, select one or more PSUS or PSUE pairs in the Volume list on the BC main screen, right-click the selected pair, and select **Pairresync**.

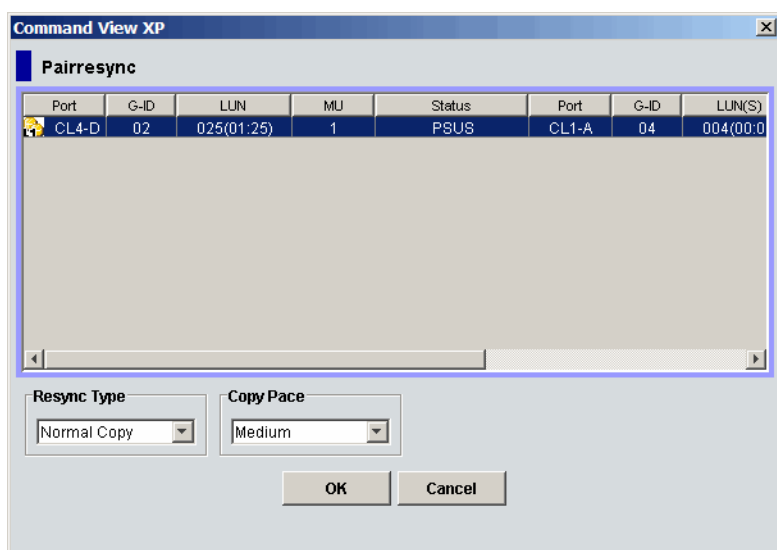

**Figure 265** Pairresync window

The Pairresync panel consists of the following components.

## Pairresync Volume List

The Volume List located on the upper side of the Pairresync panel displays the following information about the P-VOL and S-VOL of the pair you want to resynchronize:

- **Port:** Port ID (cluster and channel number) of the P-VOL
- **Group (G-ID):** Host group ID of the P-VOL
- **(Path) LUN:** CU:LDEV of the P-VOL



**NOTE:** XP12000 only: An LDEV number ending with “#” indicates the LDEV is an external volume (for example, 00:01#).

- **MU:** MU number of the P-VOL
- **Status:** Status of the P-VOL
- **Port:** Port ID (cluster and channel number) of the first S-VOL of each volume pair
- **Group (G-ID):** Host group ID of the S-VOL
- **SvolMode (LUN(S)):** CU:LDEV of the S-VOL



**NOTE:** XP12000 only: An LDEV number ending with a “#” mark indicates the LDEV is an external volume (for example, 00:01#).

- **Type:** Emulation type of the P-VOL and S-VOL
- **Capacity (MB):** Volume capacity displayed in megabytes (MB)
- **CLPR(P):** XP12000 only: Cache logical partition of the P-VOL
- **CLPR(S):** XP12000 only: Cache logical partition of the S-VOL

## Window options

- Use the Resync Type list to select the pairresync type for pairs being resynchronized (Normal Copy, Quick Resync, Reverse Copy, or Quick Restore).
- Use the Copy Pace list to select the copy pace (Slower, Medium, or Faster) for all pairs being resynchronized.
- The **OK** button adds the operation setting displayed in the Pairresync Volume List for resynchronizing the specified pair(s) to the Preset List on the BC main screen.



**NOTE:** You must select the **Apply** button on the BC main panel to start the pairresync operation for the specified pair(s).

- The **Cancel** button cancels operations set in the Pairresync panel and closes the Pairsplit panel.
- To remove any volumes from the Pairresync Volume List, right-click the selected volumes, and select **Delete**.

## Resynchronizing one or more BC pairs

1. Unmount the split (PSUS) S-VOLs before starting the pairresync operations. When the pairresync operation starts, the disk array stops accepting write I/Os to the S-VOL.

- In the BC main screen, select the port, host group, or P-VOL in the Tree View box to filter the volumes displayed in the Volume list.
- In the BC main screen, select the pair(s) to resync, right-click the selected pair(s), and select **Pairresync**. The Pairresync window appears.

Port	G-ID	LUN	MU	Status	Port	G-ID	LUN(S)
CL1-A	00	005(01:25)	0	PSUS	CL1-A	00	004(01:2)
CL1-A	00	005(01:25)	1	PSUS	CL1-A	04	004(00:0)
CL1-A	00			SMPL	---	---	---

- In the Pairresync window, select the pair(s), and set the copy pace (**Slower**, **Medium**, or **Faster**) and resync type (**Normal Copy**, **Quick Resync**, **Reverse Copy**, or **Quick Restore**) for each pair. Reverse and quick restore pairresync cannot be performed on suspended pairs (PSUE) or L2 cascade pairs.



**NOTE:** When a quick restore operation is in progress, the array management user interface may display old configuration information. To update the information in the user interface, wait for the quick restore operation to finish, and click **Refresh**.



**CAUTION:** Ensure that the correct resync direction (normal/quick, or reverse/quick restore) is selected.



**CAUTION:** During the quick restore operation, the RAID levels, HDD types, and Cache LUN settings are swapped. To avoid performance impact due to quick restore operations:

- Ensure that the P-VOL and S-VOL have the same RAID level and HDD type before performing the quick restore operation. To restore the original RAID levels after quick restore, stop host I/Os to the pair, split the pair, perform the quick restore operation for that pair again, and restart host I/Os to the pair.
- Because the Cache LUN settings are exchanged during a quick restore operation, you must perform one of the following operations. If you do not, the change of location of the cache residence areas may cause I/O performance to the Cache LUN data to be down.
  - Set the same Cache LUN settings (locations) for the P-VOL and S-VOL before performing the quick restore operation.
  - Release the Cache LUN settings of the P-VOL and S-VOL before the quick restore operation, and reset the Cache LUN settings of the P-VOL and S-VOL after the pair changes to PAIR status as a result of the quick restore operation.

If you do not want to resynchronize the P-VOL and S-VOL after the quick restore operation, set the Swap&Freeze option before performing the quick restore operation.

- Click **OK**. Repeat [step 4](#) - [step 5](#) until the Preset Volume list on the BC main screen displays the pairs (settings).



**NOTE:** Ensure that the S-VOL(s) is varied offline before starting pairresync operations.

- In the BC main screen, click **Apply** to resync the specified pair(s).

The BC main screen displays the result(s) of the pairresync operation(s) (that is, the pair status changed to COPY(RS), COPY(RS-R), or PAIR).

7. Click **Refresh** (🔄) to monitor the progress of the pairresync operation(s).

## Suspending BC pairs (Pairsplit-E)

The Pairsplit-E window displays pair information for pair(s) selected on the BC main screen. Use the Pairsplit-E window to suspend pair(s). To open the Pairsplit-E window, select one or more pairs (except SMPL and PSUE pairs) in the Volume list on the BC main screen, right-click the selected pair(s), and click **Pairsplit-E**.

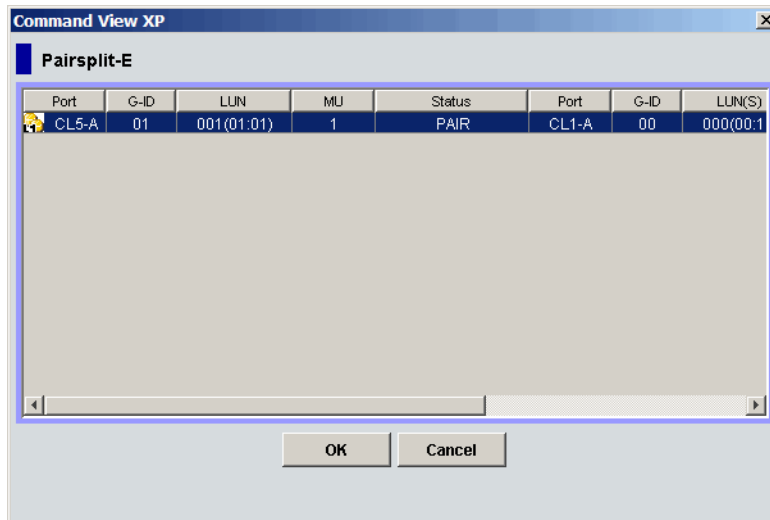
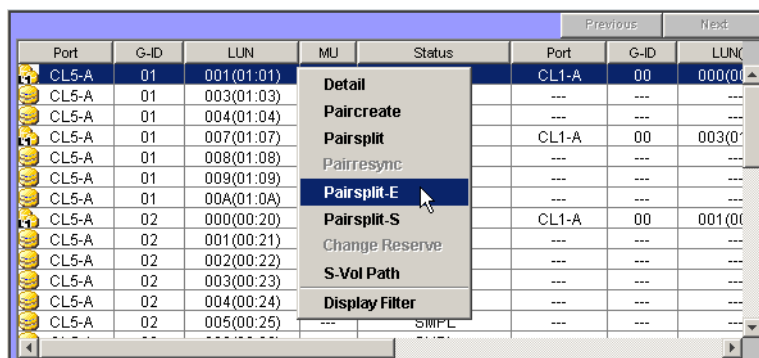

**Figure 266** Pairsplit-E window

The Pairsplit-E window lists pair(s) selected on the BC main screen and shows pair status and copy pace for each pair. The **OK** button suspends the selected pair(s). The **Cancel** button closes the Pairsplit-E window and returns to the BC main screen.

## Suspending one or more BC pairs

1. In the BC main screen, click the port, host group, or P-VOL in the Tree View box to filter the volumes displayed in the Volume list.
2. Select the pair(s) to suspend (or the volume(s) whose pairs you want to suspend), right-click the selected pair(s), and click **Pairsplit-E**. The Pairsplit-E window appears.



3. In the Pairsplit-E window, select the pair(s) to suspend, and click **OK** to reflect the settings to the Preset Volume list on the BC main screen.

To remove the pair(s) from the list, right-click while selecting the pair(s), and select **Delete**.

4. Repeat [step 2](#) - [step 3](#) to suspend additional pairs in the list.

5. In the BC main screen, click **Apply** to suspend the specified pair(s).

The BC main screen now displays the result(s) of the pairsplit-E operation(s) (that is, pair status changed to PSUE).

6. Click **Refresh** (  ) to display the latest information.

## Deleting BC pairs (Pairsplit-S)

The Pairsplit-S window displays pair information for pair(s) selected on the BC main screen. Use the Pairsplit-S window to delete pair(s). To open the Pairsplit-S window, select one or more pairs (except SMPL and PSUS(SP) pairs) in the Volume list on the BC main screen, right-click the selected pair(s), and select **Pairsplit-S**.

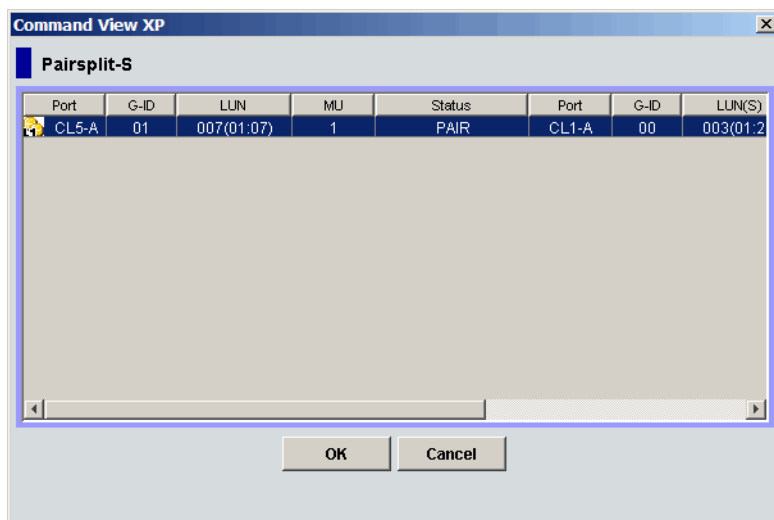

**Figure 267** Pairsplit-S window

The Pairsplit-S window lists pair(s) selected on the BC main screen and shows pair status and copy pace for each pair. The **OK** button deletes selected pair(s). The **Cancel** button closes the Pairsplit-S window and returns to the BC main screen.

## Deleting one or more BC pairs

1. To synchronize the P-VOL and S-VOL before deleting the pair:
  - a. Wait until all write I/Os to the P-VOL are complete, and take the P-VOL offline to prevent the P-VOL from being updated during or after the pairsplit-S operation.
  - b. After the P-VOL is offline, suspend the pair to copy all pending updates to the S-VOL.
  - c. When the pair status changes to PSUE, the P-VOL and S-VOL are synchronized.
2. In the BC main screen, select the port, host group, or P-VOL in the Tree View box to filter the volumes displayed in the Volume list.



3. Select the pair(s) to delete (or the volume(s) whose pairs you want to delete), right-click the selected pair(s) or volume(s), and select **Pairsplit-S**. The Pairsplit-S window appears.

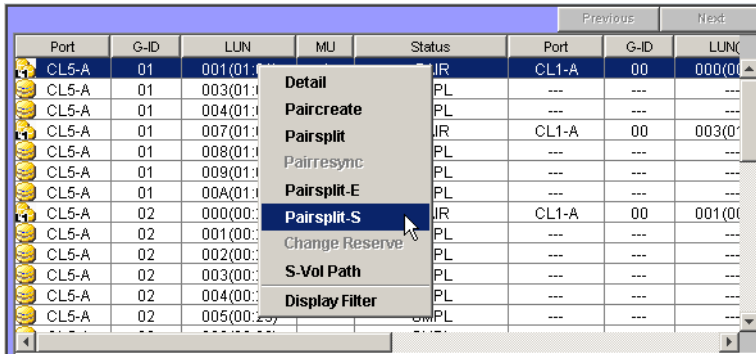

**NOTE:** Pairs with PSUS(SP) status cannot be deleted. To remove pair(s) from the list, right-click while selecting the pair(s), and select **Delete**.

4. In the Pairsplit-S window, select the pair(s) to delete, and click **OK** to reflect the settings to the Preset Volume list on the BC main screen.
5. In the BC main screen, click **Apply** to delete the specified pair(s) or volume(s).  
The BC main screen now displays the result(s) of the pairsplit-S operation(s).
6. Click **Refresh** (🔄) to display the latest information.

## Viewing BC pair status and history

The History pane displays current BC pair status information and BC pair history information for the selected port. To open the History pane, click the **History** tab on the BC main screen.

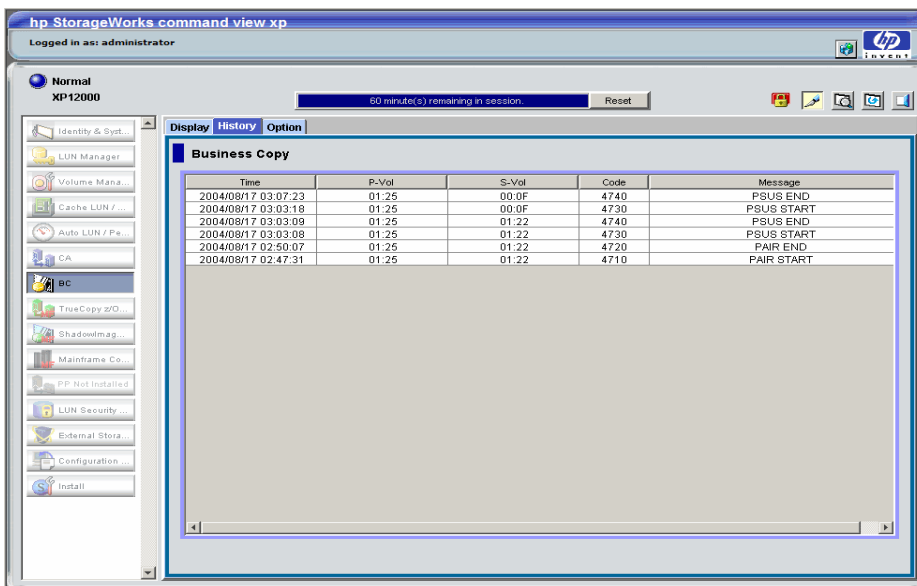

**Figure 268** History pane

The **BC History** pane displays the following information:

- BC pair activity listed by date and time, LU information (port, host group ID, LUN) and volume ID (CU:LDEV) of the P-VOL and S-VOL, and BC code and message (see [Table 93](#)). The **Time** button sorts the list by date and time. The **P-Vol** and **S-Vol** buttons sort the list by **P-VOL** or **S-VOL**. The **Code** button sorts the list by code number. The **Message** button sorts by message type.



**NOTE:** The maximum number of records that can be listed in the History pane is 16,384.

- The **Refresh** button () updates all information in the History pane.

If you perform an operation on a pair before the copy operation starts, the BC History pane will not display information about the operation.

You may need to wait for a while until the BC History pane displays operation history if the total number of the following pairs is 500 or more:

- BC pairs
- ShadowImage for z/OS pairs
- Compatible Mirroring for Hitachi® FlashCopy® pairs
- Auto LUN XP pairs
- Cross-system Copy pairs

Even if the total number of pairs is less than 500, displaying operation history may take time when some of the pairs include LUSE volumes.

**Table 93** BC pair activity codes, messages, and descriptions

Code	Message	Description
4710 - 471F	PAIR START	BC initial copy operation started.
4720 - 472F	PAIR END	BC initial copy operation ended, and pair status changed to PAIR.
4730 - 473F	PSUS START	BC pairsplit operation started, and pair status changed to COPY(SP) or PSUS(SP).
4740 - 474F	PSUS END	BC pairsplit operation ended, and pair status changed to PSUS.
4750 - 475F	COPY(RS) START COPY(RS-R) START	BC pairresync operation started, and pair status changed to COPY(RS) or COPY(RS-R).
4760 - 476F	COPY(RS) END COPY(RS-R) END	BC pairresync operation ended, and pair status changed to PAIR.
4780 - 478F	SMPL	BC pairsplit-S operation was performed, and pair status changed to SMPL.
4790 - 479F	PSUE	BC pairsplit-E operation was performed, and pair status changed to PSUE.
47A0 - 47AF	COPY WARNING END	Copy ended with a warning.
47B0 - 47BF	COPY ABNORMAL END(PVOL BLOCKADE)	Copy ended abnormally due to P-VOL blockade.
47C0 - 47CF	COPY ABNORMAL END(SVOL BLOCKADE)	Copy ended abnormally due to S-VOL blockade.
47D0 - 47DF	COPY ABNORMAL END	Copy ended abnormally (reason other than above).

**Table 93** BC pair activity codes, messages, and descriptions (continued)

Code	Message	Description
47E7	COMPULSION PAIR SUSPEND	A pair was suspended compulsorily.
47E9	SI SM INITIALIZATION START	Initialization of BC extension table was started (SM = shared memory).
47EA	SI SM INITIALIZATION END	Initialization of BC extension table was completed (SM = shared memory).
47EB	SI SM INITIALIZATION FAILED	Initialization of BC extension table failed (SM = shared memory).
7FF1 - 02	COPY ABNORMAL END (MULTIPLE PAIRS)	Multiple copies ended abnormally. This reference code is reported at a five-minute interval (one report per five minutes). If a pair ended abnormally, the pair status changed to PSUE.
FFFF	Reference Code unknown	The reference code is unknown.

## Setting BC options

You can set the BC options by selecting and/or clearing the option check boxes on the Option screen. To display the Option screen, click the **Option** tab on the BC main screen.

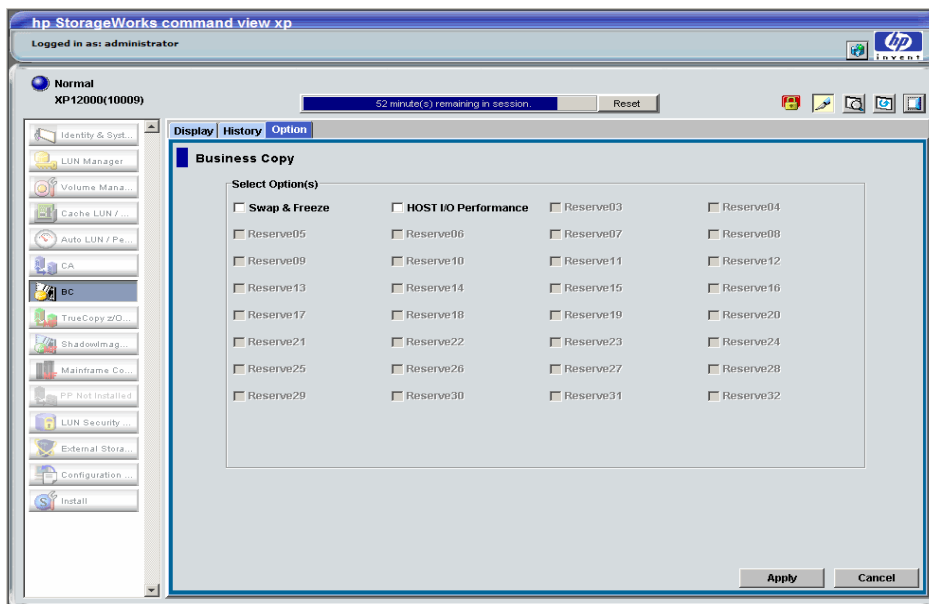

**Figure 269** Option screen

The **Select Option** box displays check boxes for the BC options.



**NOTE:** More options will be supported in the future. See “BC options” on page 435 for further information.

The **Apply** button applies the option setting(s) in the **Select Option** box.

## Setting a BC option (Swap&Freeze option)

1. In the BC main screen, click **Option** to display the **Select Option** box.  
Select the option check box. If you do not want to set any option, clear all check boxes in the **Select Option** box.
2. Click **Apply**. You can now perform a BC operation with the specified option.

## BC error codes

BC displays error messages when error conditions occur during BC operations. The BC Error window displays the BC error code and message. To display the Error window, select the failed volume in the Preset Volume list on the BC main screen (**Display** tab), right-click, and select **Detail**. The following table describes the BC error codes and provides instructions for resolving each error condition.

**Table 94** BC error codes

<b>Error Code</b>	<b>Description</b>	<b>Corrective Action</b>
0401	A locking time-out was detected during an internal processing.	A retry may result in a normal termination. Retry about five seconds later.
0402	A command (Paircreate, Pairsplit, or Reserve Volume) could not be completed because it was not in the SMPL status internally.	A retry may result in a normal termination. Retry about five seconds later.
0801	The BC feature could not be used.	Ensure that the disk array has the correct microcode level for BC, the disk array has BC installed and enabled, and the Command View management station has BC installed and enabled.
080B	The request could not be accepted.	Retry about one minute later.
0810	The specified command cannot be accepted in this status. (The command was rejected.)	Check the pair status, and ensure that the pair status is correct for the command.
0811	The specified command is treated as an NOP.	The specified command is treated as an NOP. (NOP means the command can end without errors, but executes nothing.)
0812	The new pair could not be created because a path group is set.	Disconnect from host, or cancel CA path.  On the CA main screen, confirm the specified S-VOL is simplex, specify the <b>Delete Pair by Force</b> option, and retry the operation.
0813	The Pairsplit command was issued to a pair in the PSUS status.	The Pairsplit command cannot be issued because the pair is already in PSUS status.
0814	The Paircreate command was issued to the pair in the PAIR status.	The Paircreate command cannot be issued because the pair is already in PAIR status.
0817	A Reserve volume cannot be set because a path group is set.	Disconnect volume to be reserved from host, or delete CA path.
0818	The Pairresync or Pairsplit-E command cannot be issued because a path group is set.	Unmount the S-VOL (offline from the host), or delete CA path.

**Table 94** BC error codes (continued)

<b>Error Code</b>	<b>Description</b>	<b>Corrective Action</b>
081F	Command Reject. P-VOL is used from HOST or by CA.	Disconnect from host, or cancel CA path.
0830	A pair cannot be created because the track format is different.	Ensure that the emulation type of the P-VOL and S-VOL is the same.
0831	A pair cannot be created because a number of slots is different.	Ensure that the capacity of the P-VOL and S-VOL is the same.
0834	The emulation type of the specified P-VOL is not supported by BC.	Ensure that BC supports the emulation type of the P-VOL.
0835	The emulation type of the specified S-VOL is not supported by BC.	Ensure that BC supports the emulation type of the S-VOL.
0836	The pair cannot be created.	The emulation type of the P-VOL and S-VOL is not the same.
0840	Logical contradiction.	Call HP technical support for assistance.
0841	Logical contradiction.	Call HP technical support for assistance.
0842	Logical contradiction.	Call HP technical support for assistance.
0848	Logical contradiction.	Call HP technical support for assistance.
0849	Logical contradiction.	Call HP technical support for assistance.
084A	Logical contradiction.	Call HP technical support for assistance.
084B	Logical contradiction.	Call HP technical support for assistance.
0852	Command Reject. P-VOL and S-VOL are used from HOST or by CA.	Disconnect from the host, or cancel CA path.
0880-08FF	Logical contradiction.	Call HP technical support for assistance.
0C70	A P-VOL is not installed.	Volumes that are not installed cannot be processed.
0C71	The P-VOL cannot be used.	Call HP technical support to make the P-VOL status normal.
0C72	The P-VOL is being formatted.	Wait until formatting the P-VOL completes.
0C80	The S-VOL is not installed.	Volumes that are not installed cannot be processed.
0C81	The S-VOL cannot be used.	Call HP technical support to make the P-VOL status normal.
0C82	The S-VOL is being formatted.	Wait until formatting the S-VOL completes.
0C90	The volume to be Reserved is not installed.	Volumes that are not installed cannot be processed.

**Table 94** BC error codes (continued)

<b>Error Code</b>	<b>Description</b>	<b>Corrective Action</b>
0C91	The volume to be Reserved cannot be used.	Call HP technical support to make the volume status normal.
0C92	The volume to be Reserved is being formatted.	Wait until formatting the volume completes.
1001	Logical contradiction.	Call HP technical support for assistance.
1002	Logical contradiction.	Call HP technical support for assistance.
1003	Logical contradiction.	Call HP technical support for assistance.
1004	Logical contradiction.	Call HP technical support for assistance.
1005	Logical contradiction.	Call HP technical support for assistance.
1007	Logical contradiction.	Call HP technical support for assistance.
1009	The number of BC pairs exceeded the maximum.	Delete some of the pairs.
1010	Logical contradiction.	Call HP technical support for assistance.
1011	The number of the volume specified to be a Reserve volume has already been used for a Reserve volume.	Change the volume number for specifying a Reserve volume.
1012	The number of the volume specified to be a Reserve volume has already been used for a primary BC volume.	Change the volume number for specifying a Reserve volume.
1013	The number of the volume specified to be a Reserve volume has already been used for a hierarchical control primary volume.	Change the volume number for specifying a Reserve volume.
1014	The number of the volume specified to be a Reserve volume has already been used for a hierarchical control destination volume.	Change the volume number for specifying a Reserve volume.
1015	The volume specified to be a Reserve volume is not set as a Reserve volume.	Check volume status.
1016	The volume can appropriately be allocated as an S-VOL does not exist among Reserve volumes.	Delete any Reserve volume that can be allocated as an S-VOL.
1017	A Reserve volume cannot be set because the max. number of Reserve volumes was exceeded.	Delete any Reserve volumes.
101E	The Reserve volume itself does not exist in the system.	Set one or more Reserve volumes.
1026	It is impossible to make a pair any more because the volume that was specified as P-VOL is root volume already.	Delete some of the pairs of root volume.
1027	It is impossible to make a pair any more because the volume that was specified as P-VOL is node volume already.	Delete some of the pairs of node volume.

**Table 94** BC error codes (continued)

<b>Error Code</b>	<b>Description</b>	<b>Corrective Action</b>
1028	It is impossible to make a pair because the volume that was specified as P-VOL is leaf volume already.	Confirm a pair condition.
1029	It is impossible to make a pair because the volume that was specified as S-VOL is leaf volume already.	Confirm a pair condition.
102E	P-VOL is used as source volume for HIHSM.	Confirm a matching condition.
102F	P-VOL is used as destination volume for HIHSM.	Confirm a matching condition.
1030	The specified P-VOL number does not exist.	Retry after refreshing the screen.
1031	The specified P-VOL has been set as a Reserve volume.	Check pair status.
1032	No more pairs can be created for the specified P-VOL.	Delete any pairs formed by the P-VOL.
1033	The specified P-VOL is not really a P-VOL.	Check pair status.
1037	The specified P-VOL has been set as a BC S-VOL.	Check pair status.
103A	The Pairresync command was issued to a device in the SMPL status.	Check pair status.
103B	It is impossible to make a pair because volume that was specified as S-VOL is root volume already.	Confirm a pair condition.
103C	It is impossible to make a pair because volume that was specified as S-VOL is node volume already.	Confirm a pair condition.
103D	It is impossible for L2 pair to require a split because L1 pair is not in the split condition.	After making L1 pair a split condition, re-execute.
103E	A new pair was created with a P-VOL forming the CA cooperation pattern.	Place the BC pair in SMPL status, or place the CA pair that uses the BC S-VOL as a P-VOL in SMPL status.
103F	A pair status cannot be changed to form the CA cooperation pattern.	Place the CA pair that uses the BC S-VOL as a P-VOL in PSUE or SMPL status.
1040	The specified S-VOL does not exist.	Set one or more Reserve volumes.
1042	S-VOL is used as destination volume for HIHSM.	Confirm a matching condition.
1043	The specified S-VOL number has already been used as that of an S-VOL.	Check pair status.
1044	The specified S-VOL is not a BC S-VOL.	Check pair status.
1046	The specified secondary volume is being used as a CA P-VOL.	Delete the CA pair.
1047	The specified secondary volume is being used as a CA S-VOL.	Delete the CA pair.

**Table 94** BC error codes (continued)

<b>Error Code</b>	<b>Description</b>	<b>Corrective Action</b>
104A	The specified secondary volume is being used as a BC P-VOL.	Check the pair status.
104B	S-VOL is used as source volume for HIHSM.	Confirm a matching condition.
104E	The volume specified as a Reserve volume is being used as a CA P-VOL.	Delete the CA pair.
104F	The volume specified as a Reserve volume is being used as a CA S-VOL.	Delete the CA pair.
1050	The specified P-VOL and S-VOL are not a BC pair.	Check the pair status.
1051	The volume numbers of the specified P-VOL and S-VOL are the same.	Retry after refreshing the screen.
1053	Request could not be accepted	Confirm a matching condition.
1054	Request could not be accepted	Confirm a matching condition.
1058	S-VOL is node volume whose L2 status is SP-Pend.	Confirm a matching condition.
1070	The status mode specification (status modec) in the Status Check command is incorrect.	Call HP technical support for assistance.
1071	The status classification (statusindc) in the Status Check command is incorrect.	Call HP technical support for assistance.
1072	The CU number specified by the Status Check command (volume status) does not exist.	Call HP technical support for assistance.
1084	Volume was used for reserve volume of HIHSM.	Check the volume, or cancel the reserve volume of HIHSM.
1085	P-VOL was used for reserve volume of HIHSM.	Check the P-VOL, or cancel the reserve volume of HIHSM.
1086	S-VOL was used for reserve volume of HIHSM.	Check the S-VOL, or cancel the reserve volume of HIHSM.
1087	P-VOL is used as source volume for HIHSM.	Confirm a matching condition.
1095	Request could not be accepted because status of pair who shared with P-VOL was Reverse-copy.	Confirm a matching condition.
1096	Request could not be accepted because L1 pair status was Reverse-copy.	Confirm a matching condition.
1097	Request could not be accepted because L2 pair status was Reverse-copy.	Confirm a matching condition.
1098	Reverse-Copy could not be accepted because pair status was not Split.	Confirm a matching condition.



**Table 94** BC error codes (continued)

<b>Error Code</b>	<b>Description</b>	<b>Corrective Action</b>
1099	Reverse-copy to L2 pair could not be accepted because status of pair who shared with P-VOL was neither Split nor Suspend.	Confirm a matching condition.
109A	Reverse-copy could not be accepted because P-VOL was shared with CA P-VOL whose status was not Suspend.	Confirm a matching condition.
109B	Reverse-copy could not be accepted because P-VOL was shared with CA S-VOL whose status was not Suspend.	Confirm a matching condition.
109C	Reverse-copy could not be accepted because S-VOL was shared with CA P-VOL.	Confirm a matching condition.



---

## 24 Continuous Access (CA) for the XP128/XP1024/XP12000

Continuous Access (CA) creates and maintains duplicate copies of user data from a local disk array on a remote disk array. These copies are useful for data duplication, backup, and disaster recovery. CA has synchronous and asynchronous copy modes to accommodate a wide variety of user requirements and data copy or movement scenarios. CA is used for open systems data.

If a system failure or disaster occurs at the primary (main) site, CA simplifies and expedites disaster recovery procedures.

CA operations are nondisruptive and allow the primary (main) volume of each CA volume pair to remain online to all hosts for read and write I/O operations. After operations are established, CA operations continue unattended to provide continuous, real-time data backup. CA operations can be performed across distances of up to 500 meters with a direct connection, 10 km (6.6 miles) using single-mode longwave optical fibre cables in a switch configuration, 30 km (18.6 miles) using single-mode fiber with long-haul lasers in a switched connection, and up to 100 km using DWDM in a switched configuration. For serial interface connection, CA operations can be performed across distances of up to 43 km (26.7 miles) using standard ESCON support. Long-distance solutions are provided, based on user requirements and workload characteristics, using approved channel extenders and communication lines.

CA operations can be performed with Business Copy XP operations (see [“Overview of CA operations”](#) on page 485) to provide multiple internal copies of CA volumes. CA also supports LU Size Expansion (LUSE), VSC, and HP Cache LUN volumes. See [“Combining CA with other data management operations”](#) on page 512 for more information.

---

### Overview of CA operations

CA provides a storage-based hardware solution for disaster recovery, which enables fast and accurate system recovery. After CA operations are established, duplicate copies of data are automatically maintained for backup and disaster recovery purposes. During normal CA operations, primary volumes remain online to all hosts and continue processing read and write I/O operations. If a disaster or system failure occurs, the secondary copy of data can be rapidly invoked to allow recovery with a very high level of data integrity. CA can also be used for data duplication and migration tasks.

CA Synchronous provides volume-based real-time data replication and is ideal for high-priority data backup, duplication, and migration tasks. If a disaster or system failure occurs at the primary site, secondary CA Synchronous data can be rapidly invoked to allow recovery at the volume level with an extremely high level of data integrity and currency. Up to a distance of approximately 7-9 km, CA Synchronous provides the highest theoretical throughput.

CA Asynchronous represents a unique and outstanding disaster recovery solution for large amounts of data spanning multiple volumes. The CA Asynchronous group-based update sequence consistency solution enables fast and accurate database recovery after a disaster, without time-consuming data recovery procedures. CA Asynchronous (CA Async) volume groups at the remote site can be recovered with full update sequence consistency, but data currency might be behind the primary site due to the asynchronous remote copy operations.

CA Asynchronous provides update sequence consistency for user-defined groups of volumes (such as large databases) and protection for write-dependent applications if a disaster occurs. Beyond a distance of 7-9 km, CA Asynchronous provides the highest possible theoretical throughput.

This overview of CA operations describes:

- ["Components" on page 486](#)
- ["Remote copy operations" on page 491](#)
- ["CA Asynchronous recordset operations" on page 493](#)
- ["CA Asynchronous consistency group operations" on page 496](#)
- ["CA volume pair status" on page 497](#)

## Components

CA operations involve the XP128/XP1024/XP12000 at a primary and secondary (remote) site, physical communications paths between these disk arrays, and Command View. CA copies online data at the primary site to volumes at the secondary site via dedicated Fibre Channel and/or ESCON remote copy connections.

Host failover software is required for effective disaster recovery with CA.

[Figure 270](#) and [Figure 271](#) show CA components and the following functions:

- ["XP128/XP1024/XP12000" on page 487](#)
- ["Main and remote control units \(MCUs and RCUs\)" on page 488](#)
- ["Volume pairs \(P-VOLs and S-VOLs\)" on page 488](#)
- ["CA Asynchronous consistency groups" on page 489](#)
- ["Remote copy connections" on page 489](#)
- ["Initiator ports and RCU target ports" on page 490](#)
- ["Remote control ports \(RCPs\) and local control ports \(LCPs\)" on page 490](#)
- ["Command View management station" on page 490](#)

- “Host failover software” on page 491

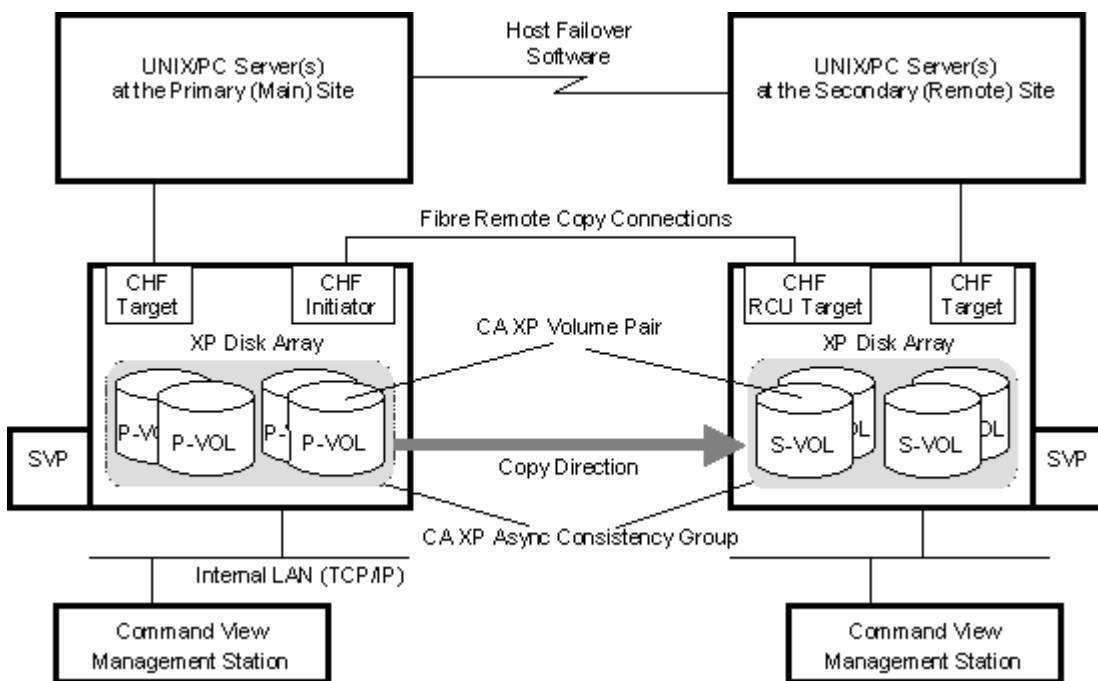

**Figure 270** CA components for Fibre Channel connections

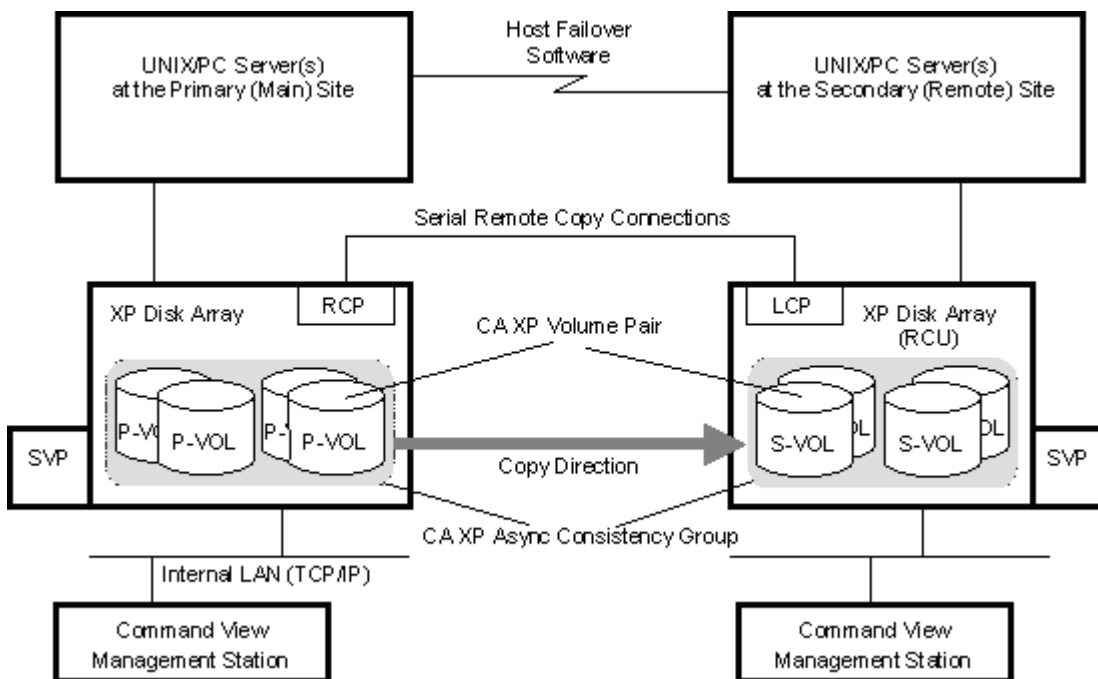

**Figure 271** CA components for Serial (ESCON) connections

## XP128/XP1024/XP12000

CA operations involve primary (main) disk arrays and secondary (remote) disk arrays (MCUs and RCUs). This document describes CA operations in which the main disk array is an XP128/XP1024/XP12000 and the remote disk array is an XP128/XP1024/XP12000. MCUs contain CA primary volumes (P-VOLs), which contain original data and are online to the host(s). RCUs contain CA secondary volumes (S-VOLs), which are synchronous or asynchronous copies of the P-VOLs. CA supports all CU images and logical volumes of the disk array and all physical hard drive options. CA supports RAID1 and RAID5 configurations for the XP128/XP1024/XP12000.

To provide greater flexibility and enable the disk array to be tailored to unique customer operating requirements, additional operational parameters, or optional modes, are available for the disk array. At installation, modes are set to their default values, so discuss these settings with your HP support team. Modes can only be changed by your HP support team representative.

Contact your HP account support representative for the latest mode information.

## Main and remote control units (MCUs and RCUs)

The main control unit (MCU) and remote control unit (RCU) control CA operations:

- The MCU is the control unit in the primary disk array that controls the P-VOLs of the CA volume pairs. The Command View management station must be LAN-attached to the MCU of each CA pair. The MCU communicates with the RCU via dedicated Fibre Channel remote copy connections. The MCU controls host I/O operations to the CA P-VOLs and CA initial copy and remote copy operations between the P-VOLs and S-VOLs. The MCU also manages CA pair status and configuration information.
- The RCU is the CU in the remote disk array that controls the S-VOLs of the CA volume pairs. The RCU assists in managing CA pair status and configuration (for example, rejects write I/Os to CA S-VOLs). The RCU executes remote copy operations issued by the MCU. The secondary Command View management station should be LAN-attached to the RCUs at the remote site. The RCUs should also be attached to a host system to allow sense information to be reported if a problem with a secondary volume or remote disk array occurs and provide disaster recovery capabilities.

The MCU and RCU can be defined separately for each CA volume pair. The XP128/XP1024/XP12000 CU can function simultaneously as an MCU for one or more P-VOLs and as an RCU for one or more S-VOLs, provided the remote copy connections and Fibre Channel or serial interface ports are properly configured. The XP128/XP1024/XP12000 provides up to 32 logical CU images (0-1F), with each CU image controlling up to 256 logical devices (LDEVs). Use CA to select the CU image in the connected MCU and specify the CU image in the RCU. CA operations can be performed on all LDEVs except the XP128/XP1024/XP12000 command device.



**NOTE:** When serial interface connections are used for remote copy operations, controller emulation of the connected ports of the MCU and RCU can be different. However, when the MCU and RCU are connected to the same host, controller emulation of the host-connected ports of the MCU and RCU must be the same.

---

## Volume pairs (P-VOLs and S-VOLs)

CA performs remote copy operations for logical volume pairs you create. Each CA pair consists of one primary volume (P-VOL) and one secondary volume (S-VOL), which can be in the same disk array (synchronous only) or different disk arrays. The CA P-VOLs are primary volumes (LUs) containing original data, and the CA S-VOLs are secondary or mirrored volumes (LUs) containing replicated or duplicate data. Volumes are copied on an Open volume basis, and logical volumes should have the same format and capacity (SCSI path definition is required). During normal CA operations, the P-VOL remains available to all hosts at all times for read and write I/O operations. During normal CA operations, the RCU rejects all host-requested write I/Os for the S-VOLs. The S-VOL write enable option allows write access to an S-VOL while the pair is split, and uses the S-VOL and P-VOL cylinder maps to resynchronize the pair (see "[S-VOL write option](#)" on page 493).

CA supports basic logical unit (LU) types available on the XP128/XP1024/XP12000. CA also supports LU Size Expansion (LUSE), VSC, and HP Cache LUN XP features, ensuring that all user data can be backed up or duplicated. See "[Logical unit \(LU\) types](#)" on page 505 for further information about LU requirements and support.

CA supports a maximum of 8,192 CA pairs (entire RCU). When CA pairs include size-expanded LUs, the maximum number of pairs decreases. When the RAID Manager command device is defined, the maximum number of CA pairs in the XP1024/XP12000 is 8,191 (4095 in the XP128).

CA supports the following RAID level configurations.

**Table 95** CA supported RAID level configurations

For P-VOL	For S-VOL
RAID 1	RAID 1
RAID 5	RAID 5
RAID 1	RAID 5
RAID 5	RAID 1

## CA Asynchronous consistency groups

A CA Asynchronous consistency group is a user-defined set of volume pairs across which update sequence consistency is maintained and ensured at the remote site. Each CA Async volume pair must be assigned to a consistency group. CA can configure up to 128 consistency groups (0-7F) for each MCU and provides group-based operations for consistency groups (for example, split and resync group). Use consistency groups to maintain update sequence consistency for databases spanning multiple volumes, allowing immediate database recovery at the remote site when needed. See ["CA Asynchronous consistency group operations"](#) on page 496 for further information.

Only CA Asynchronous pairs belonging to the same CLPR can be allocated to one CA consistency group. For more information about CLPRs, see ["Disk/Cache Partition for the XP12000"](#) on page 143.

## Remote copy connections

Remote copy connections are physical paths MCUs use to communicate with RCUs. The number of physical paths in the MCU is limited to eight per logical CU image. MCUs and RCUs are connected via Fibre Channel interface or serial (ESCON) interface cables.

- When Fibre Channel interface connections are used, switches are required for distances greater than 0.5 km (1,640 feet). Distances up to 1.5 km (4,920 feet, 0.93 miles) are supported with dual switches utilizing shortwave connections. Distances up to 10 km (6.2 miles) are supported using dual switches with longwave connections. Distances up to 30 km (18.6 miles) are supported using dual switches with longhaul connections. Distances up to 100 km are supported by using dual switches with DWDM. See ["Fibre Channel remote copy connections"](#) on page 507 for further information about installing and configuring Fibre Channel remote copy connections.
- When serial interface connections are used, ESCON directors (ESCDs) and/or ESCON repeaters are required for distances greater than 3 km (1.9 miles). CA operations can be performed at distances of up to 43 km (26.7 miles) using standard ESCON support. Long-distance solutions are provided, based on user requirements and workload characteristics, using approved protocol converters and communication lines, such as T1/T3/ATM. See ["Serial remote copy connections"](#) on page 509 for further information about installing and configuring serial remote copy connections.

The MCU-to-RCU remote copy configuration for CA Asynchronous has different requirements than the CA Synchronous configuration, as follows:

- CA Synchronous supports 1-to-n and n-to-1 remote copy connections (n $\leq$ 4). One MCU can be connected to as many as four RCUs. One RCU can be connected to as many as four MCUs (one MCU/RCU = one physical CU, including all sixteen CU images).
- CA Asynchronous supports 1-to-1 remote copy connections within the same consistency group. P-VOLs and S-VOLs of pairs in a consistency group must be within one physical MCU and one physical RCU.

This configuration ensures backup integrity for a data set spread across multiple volumes within one XP128/XP1024/XP12000 (such as large databases).

CA Asynchronous 1-to-n and n-to-1 ( $n \geq 4$ ) configurations (one main disk array and multiple remote disk arrays) are valid for CA Asynchronous if all volumes belonging to a single consistency group are only 1-to-1.

- With direct connect Fibre Channel (no switch), fibre remote copy supports 1-to-1 remote copy connections. One XP128/XP1024/XP12000 as an MCU can be connected to only one XP128/XP1024/XP12000 as an RCU via optical fibre cables. For CU images within one XP128/XP1024/XP12000, 1-to-4 and 4-to-1 remote copy connections are supported via direct connects or an FC switch.

HP strongly recommends you establish at least two independent remote copy connections (one per cluster) between each MCU and RCU to provide hardware redundancy for this critical communications path.

## Initiator ports and RCU target ports

Initiator ports are dedicated Fibre Channel interface ports on the main disk array (MCU) to which RCUs (RCU target ports) are connected. Initiator ports connect to RCUs to send write I/O operations directly to RCUs. You can configure Fibre Channel interface ports of the XP128/XP1024/XP12000 as initiator ports. Use the Port Change operation (see “[Port change operation](#)” on page 546) to change the configuration of the XP128/XP1024/XP12000 Fibre Channel ports (ordinary target port, initiator port, or RCU target port) as needed.



**NOTE:** Initiator ports cannot communicate with hosts, but are used exclusively as CA talkers. Ordinary target ports can be used only for host connect (not for CA).

---

RCU target ports are (CA) dedicated Fibre Channel interface ports on the remote disk array (RCU) to which MCUs (initiator ports) are connected. You can configure Fibre Channel interface ports of the XP128/XP1024/XP12000 as RCU target ports. For performance reasons, RCU target ports should not be shared with host connects.

## Remote control ports (RCPs) and local control ports (LCPs)

Remote control ports (RCPs) are dedicated serial interface ports on the MCU to which RCUs are connected. RCPs emulate host processor channels, enabling MCUs to send write I/O operations directly to RCUs. RCPs support the dynamic switching capability provided by ESCDs. You can configure serial interface ports of the disk array as RCPs. Use CA to change the configuration of disk array serial ports (LCP or RCP) as needed (see “[Port change operation](#)” on page 546).

Local control ports (LCPs) are used for host processor channel interfaces. All serial interface ports on the disk array have a default setting of LCP. An RCU port connected to an MCU must be in LCP mode to receive remote copy I/O operations from the MCU.

Two or more RCPs must be configured before you can add RCUs and create CA volume pairs. RCPs cannot communicate with host processor channels and are dedicated to CA operations. Host channel interface paths must be connected to other interface ports on the disk array.

Serial interface ports, 1S-1Z and 2S-2Z, cannot be specified as RCPs.

CHA package ports added to DKA slots cannot be specified as RCPs.

## Command View management station

The Command View management station is attached to the XP128/XP1024/XP12000 on the internal LAN via a TCP/IP connection. The Command View management station communicates with each attached XP128/XP1024/XP12000.



The Command View management station at the primary site must be connected to the MCU of each CA pair. A second Command View management station should be installed at the remote site and connected to the RCUs. With another Command View management station at the remote site, you can modify the CA Asynchronous options of the RCU (for example, pending update data rate or offloading timer) and access the CA S-VOLs (for example, to perform media maintenance). To perform CA operations in the reverse direction from the remote site to the primary site (for example, disaster recovery), CA simplifies and expedites this process.

## Host failover software

Host failover software, which transfers information between host servers at primary and remote sites, is a critical component of any disaster recovery effort. Host failover is configured using the host failover software product for the platform (such as Microsoft Cluster Server or HP Cluster Extension XP), depending on your installation requirements and standards. Command View does not provide host failover functions.

When CA is used as a data migration tool, host failover is recommended but not required. When CA is used as a disaster recovery tool, host failover is required to ensure effective disaster recovery operations. When a CA pair is suspended due to an error condition, the MCU generates sense information that should be transferred to the remote site via host failover software for effective disaster detection and recovery.

## Remote copy operations

There are two types of CA remote copy operations: initial copy and update copy.

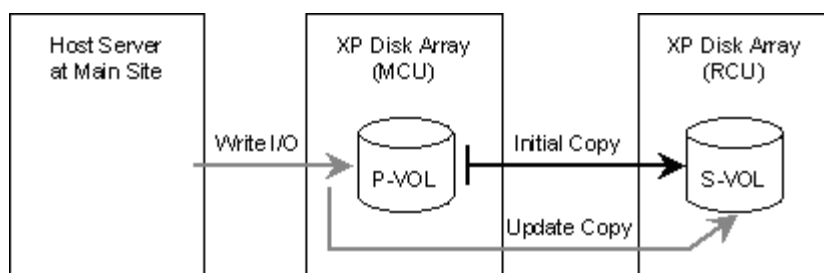

**Figure 272** Remote copy operations

## Initial copy operations

Initial copy operation synchronizes P-VOLs and S-VOLs independently of host I/O processes. Initial copy operations are the same for CA Sync and CA Async pairs. CA initial copy operations occur when adding a pair (paircreate) or resuming a split/suspended pair (pairresync). When a new pair is created, the entire contents of the P-VOL are copied to the S-VOL cylinder by cylinder, except for diagnostic and unassigned alternate tracks. You can select **No Copy** for the **Initial Copy** field of the initial copy parameters, which copies only cylinder #0 to the S-VOL. If **No Copy** is selected, you are responsible for ensuring that P-VOLs and S-VOLs are already identical. The MCU cannot verify the contents of volumes. When a split/suspended pair is resumed (pairresync), only cylinder #0 and out-of-sync cylinders (updated by write I/Os during split/suspension) are copied to the S-VOL. When the CA S-VOL write enable function is used, the RCU tracks S-VOL updates and sends the S-VOL cylinder bitmap to the MCU when the split pair is resumed. In this case the MCU merges the P-VOL and S-VOL bitmaps to identify out-of-sync cylinders.

For additional flexibility, CA provides the following options for initial copy:

- Use the **Initial Copy Pace** field of the initial copy parameters to specify how many tracks the CA initial copy operation copies simultaneously when creating/resuming a CA pair. This option can only be specified using CA.
- Use the **Priority** field of the initial copy parameters to specify the order in which initial copy operations are performed when creating/resuming multiple CA pairs. This option can only be specified using CA.

- Use the **Maximum Initial Copy Activity** option to specify maximum number of concurrent initial copy operations each MCU can perform (not pair-specific). This option can only be specified using CA.

## Update copy operations

Update copy operations occur when the host issues a write I/O operation to the P-VOL of an established CA pair. Update copy operations duplicate P-VOL write I/Os at the S-VOL to keep the volume pair synchronized. CA provides two modes for update copy operations: synchronous and asynchronous. Update copy mode is specified when you add a CA pair and is unchangeable for the life of the pair.

For synchronous update copy mode, the MCU ensures the P-VOL and S-VOL are synchronized at all times. When using fence level "data," the MCU does not return final ending status for the P-VOL write I/O until the outcome of the P-VOL write and its associated update copy operation at the RCU are known. For synchronous mode, the MCU starts the update copy operation when it receives:

- A write command whose data length is short enough not to pass the track-end
- Write data to the track-end, whose total length is long enough to pass the track-end
- Write data to the last track for the command



**NOTE:** No matter how long the write data is, update copy is executed for each track.

For asynchronous update copy mode, the MCU stores P-VOL updates with additional control information in cache, and sends updates and control information to the RCU completely independent of host I/O processes. These updates and their associated control information are called recordsets. The RCU stores recordsets in cache and performs updates to S-VOLs in the same order as they were performed at MCU(s) according to the sequence information stored in the recordset. For more information on recordset operations, see "[CA Asynchronous recordset operations](#)" on page 493.

**Priority of initial and update copy:** In both CA Synchronous and CA Asynchronous, update copy has higher priority than initial copy. However, initial copy is executed based on copy pace (3 or 15 tracks). Therefore, update copy must wait this interval if initial copy is being executed. For example, if the copy pace is 15 tracks, the update copy may wait up to 15 tracks (1 cylinder). For CA Asynchronous, update copy is executed asynchronously, but the same scheduling conflict can occur between the asynchronous update copy (write recordset) and initial copy.

## Read and write I/O operations for CA volumes

When an MCU receives a read command for a CA P-VOL, the MCU completes the read from the P-VOL. The MCU will not read the CA S-VOL over the link if a failure rendered the P-VOL inaccessible.

When an MCU receives a write command for a CA Synchronous P-VOL with COPY status and the track has already been copied to the S-VOL, the MCU performs a synchronous update copy operation to complete the write at the S-VOL. When an MCU receives a write command for a CA Asynchronous P-VOL with COPY status and the track has already been copied to the S-VOL, the MCU performs an asynchronous update copy operation.

When an MCU receives a write command for a CA P-VOL with PAIR status, the user-selected update copy mode (synchronous or asynchronous) determines the sequence of events as follows:

- **Synchronous Mode:** The MCU performs the write operation on the P-VOL, starts the update copy operation for the S-VOL, and reports final ending status to the host only after results of the update copy operation are known. If the P-VOL write or S-VOL update copy operation fails, the MCU reports a unit check, and the host system and application program regard that write operation to the P-VOL as failed.
- **Asynchronous Mode:** The MCU completes P-VOL write operations independently of the associated update copy operations at the S-VOL. The RCU manages the S-VOL updates according to recordset information and maintains sequence ordered data consistency for the S-VOLs. If the P-VOL write

operation fails, the MCU reports a unit check and does not create the CA asynchronous recordset for this operation. If the update copy operation fails, the RCU optionally suspends the affected pair or all pairs in the consistency group, depending on the type of failure. When the suspended pair or group is resumed (pairresync), the MCU and RCU negotiate the resynchronization of the pair(s). See "[CA suspend types](#)" on page 501 for further information about suspended CA Async pairs.

The RCU does not allow a CA S-VOL to be online (mounted) during normal CA operations and rejects all host-requested write I/O operations for an S-VOL. The special CA S-VOL write enable option enables write access to an S-VOL while the pair is split (see "[S-VOL write option](#)" on page 493). The S-VOL write option can be enabled only when you split the pair from the MCU.

To reduce overhead associated with CA remote copy operations, the XP128/XP1024/XP12000 uses a special write command that is allowed only for CA initial and update copy operations. This CA command transfers control parameters and FBA-format data, which includes consecutive updated records in each track, using a single write operation. This capability eliminates overhead required for performing FBA-to-CKD and CKD-to-FBA conversions.

## S-VOL write option

CA provides an S-VOL write option that enables write access to the S-VOL of a split CA pair. The S-VOL write option can be selected during the pairsplit-r operation and applies only to the selected pair(s). The S-VOL write option can be accessed only when you are connected to the MCU. When you resync a split CA pair that has the S-VOL write option enabled, the RCU sends the S-VOL cylinder bitmap to the MCU, and the MCU merges the P-VOL and S-VOL bitmaps to determine which cylinders are out-of sync. This ensures proper resynchronization of the pair.

## CA Asynchronous recordset operations

CA Asynchronous recordsets contain P-VOL updates and associated control information, including sequence number of the P-VOL update, which enables the RCU to maintain update consistency of S-VOLs. CA Recordset operations include:

- "[Creating and storing recordsets at the MCU](#)" on page 493
- "[Sending recordsets to the RCU](#)" on page 494
- "[Storing recordsets at the RCU](#)" on page 494
- "[Selecting and settling recordsets at the RCU](#)" on page 494
- "[Types of recordsets](#)" on page 495
- "[Inflow control of recordsets](#)" on page 495

## Creating and storing recordsets at the MCU

When an MCU performs an update (host-requested write I/O) on a P-VOL, the MCU creates a recordset containing the updated record, sequence number, record location (device, cylinder, track, and record number), and record length. Recordsets are queued in cache storage of the MCU and sent to the RCU independent of host I/O processes. The RCU utilizes sequence number information in the recordsets to update S-VOL(s) in the same order as P-VOL(s).

The sequence number indicates the number of recordsets the MCU created for each consistency group. Recordset information, except for updated records, is stored and queued in an area of cache known as sidefile cache (see "[Inflow control of recordsets](#)" on page 495).



**NOTE:** CA Asynchronous operations continue uninterrupted if the disk array reboots or the disk array's internal Service Processor (SVP) fails.

---

## Sending recordsets to the RCU

The MCU sends asynchronous CA recordsets to the RCU in a manner similar to CA synchronous updates. The MCU's initiator ports act as host processor channels and issue special I/O operations, called remote I/Os (RIOs), to the RCU. The RIO transfers recordsets in FBA format (not CKD) using a single channel command, eliminating overhead associated with FBA-CKD conversion and thus providing more efficient data transfer. The MCU can send several recordsets using a single RIO, even if their sequence numbers are not contiguous. Therefore, recordsets are usually sent to the RCU in a different order than the arrivals at the MCU. The RCU ensures that records are applied to the S-VOLs in the correct sequence. This method of remote I/O provides the most efficient use of MCU-to-RCU link resources.

The parameter length and detailed specification of the CA Asynchronous channel command are different than for CA Synchronous RIOs. You must ensure that your channel extenders support this command. For further details, contact your HP account support representative.

## Storing recordsets at the RCU

The RCU maintains queues to control storing recordsets in the sidefile and committing updated records in the S-VOLs. The RCU queuing mechanism for CA Async uses sequence numbers provided by the MCU to check for missing updates.

The MCU does not remove the sidefile entry for a recordset from its cache until it receives an I/O completion signal (device end) from the RCU. This is true even if the MCU and RCU are connected via a channel extender product. If a recordset is lost in transmission from the MCU to the RCU, the MCU's cylinder bitmap ensures that the missing recordset is identified and resent to the RCU.

## Selecting and settling recordsets at the RCU

The RCU selects recordsets to be promoted to formal data (or "settled") as follows:

1. The RCU checks for a valid entry at the top of each queue in the consistency group. If the top of any queue is empty (recordset not yet received), the RCU waits for that entry.
2. When the top of each queue contains a valid entry (recordset), the RCU selects the entry with the earliest sequence number, and settles that recordset.
3. The RCU repeats this process to select and settle CA Asynchronous recordsets.

The following figure illustrates recordset selection and settling at the RCU. In this example, the top of the queue contains a valid entry: S1. The RCU selects recordset S1 to be settled, because S1 is the earliest sequence number. When S1 is removed from the MCU queue, recordset S2 becomes the top entry, but it is empty. When recordset S2 arrives the RCU selects S2 as the next recordset to be settled. The recordset the RCU selects is marked as "host-dirty" and treated as formal data. The RCU settles the updated records in the recordset as follows:

- If the corresponding track is in cache (track-hit), updated records in the recordset are copied to the existing cached track, and cache space for the sidefile is released.

- If the corresponding track is not in cache (track-miss), the RCU changes the cache designation of the sidefile to formal data. Data is not physically moved.

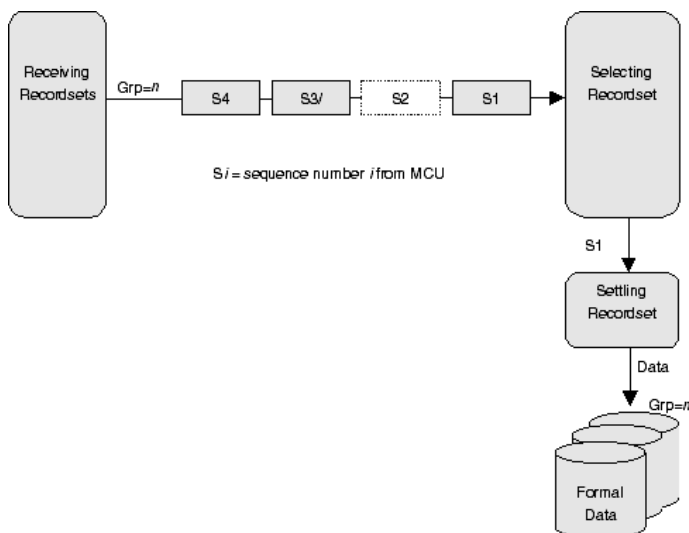

**Figure 273** Selecting and settling CA Async recordsets at the RCU

## Types of recordsets

In addition to host update recordsets, the MCU passes control information to the RCU in special non-update recordsets. These special recordsets indicate when volume pair status changes, indicate when an MCU power-off sequence is initiated, and maintain sequence numbers in periods of low host activities.

## Inflow control of recordsets

As described in previous sections, both the MCU and RCU create sidefiles for storing CA Asynchronous recordsets. Because sidefiles occupy exclusive space in cache, both the MCU and RCU perform inflow control to prevent an overload of the disk array's cache resources. The XP128/XP1024/XP12000 uses certain parameters for CA Asynchronous cache inflow control. Use the CA Async Option pane to modify the following parameters (see "[Asynchronous copy option](#)" on page 553):

- **Pending Update Data Rate (%):** Sidefile (CA) threshold = maximum cache % available for use by CA Asynchronous sidefiles.
- **Offloading Timer (sec.):** Maximum time between CA Async recordset transfers.
- **I/O Delay Start (%):** Maximum amount of cache for starting I/O inflow control.
- **I/O Delay Increase (%):** Maximum amount of cache for starting to strengthen control over I/O inflow.

### Inflow control by MCU

When the amount of MCU sidefile cache reaches the user-specified threshold (*I/O delay start*), the disk array's I/O response is delayed. When the amount of MCU sidefile cache reaches the user-specified threshold (*I/O delay increase*), the disk array's I/O delay starts increasing. If the MCU cannot send a recordset to the RCU within the user-specified *offloading timer* value, the MCU suspends all affected CA Async volume pairs and resets the SCP condition to avoid hanging up the system.

### Inflow control by RCU

When the amount of RCU sidefile cache reaches the user-specified threshold, the RCU responds with channel-command-retry requests to the RIO commands that transfer recordsets from the MCU. The RCU accepts only the recordset with the sequence number required to continue settling pending recordsets. If the RCU cannot settle a recordset within the user-specified offloading timer value, the RCU suspends all CA Asynchronous volume pairs and resets the channel-command-retry condition to avoid hanging up the MCU.

Table 96 shows sidefile threshold values for CA Asynchronous operations and write pending operations and describes actions occurring when each threshold is reached.

**Table 96** Sidefile threshold values for CA Asynchronous operations and write pending operations

Operation	Threshold(s)	Action(s)
CA Asynchronous	I/O Delay Start (threshold) = 30%  Use CA to adjust threshold to desired value between 0 and 70% in 1% increments. Specify a value not exceeding the value of I/O Delay Increase, and Sidefile threshold.	MCU reaches threshold: I/O delay starts. If sidefile threshold is set between 0 and 30%, influence to the I/O delay is kept low.  RCU reaches threshold: No action.
CA Asynchronous	I/O Delay Increase (threshold) = 40%  Use CA to adjust threshold to desired value between 0 and 70% in 1% increments. Specify a value within the range of the I/O Delay Start threshold and Sidefile threshold.	MCU reaches threshold: I/O delay increases. If sidefile threshold is set between 0 and 30%, influence to the I/O delay is kept low.  RCU reaches threshold: No action.
CA Asynchronous	Sidefile threshold = 50%  Use CA to adjust threshold (30, 40, 50, 60, or 70%).	MCU reaches threshold: I/O delay.  RCU reaches threshold: Command retry to MCU.
Write Pending	[write pending] / [avail cache - sidefile] = 70%	Command retry.

HP Cache LUN XP operations might decrease total amount of cache available for CA Asynchronous operations, but they do not directly affect sidefile cache usage. Available cache is the amount of physical cache memory installed on the disk array minus any cache reserved for the HP Cache LUN XP feature.

If you do not want to control inflow into a sidefile, specify the value of the Pending Update Data Rate for the I/O Delay Start and I/O Delay Increase, and specify 0 seconds for the Offloading Timer.

## CA Asynchronous consistency group operations

CA Asynchronous consistency groups maintain update sequence consistency across an aggregated data set spanning a group of volumes. P-VOLs and S-VOLs of the pairs in a consistency group must be located within one physical MCU and one physical RCU (1-to-1 requirement). CA consistency group operations include:

- Group options
- Group consistency time
- Group operations

### Group options

CA provides the following options for each consistency group: **copy pending timeout** and **RCU ready** timeout. These options are selected when you add a group, and can be modified only when the group does not contain any P-VOLs in the MCU.

#### Copy pending timeout

This group option specifies maximum delay allowed for CA Async copy operations. The RCU suspends all S-VOLs in the group when:

- The RCU has not had any communications from the MCU within the specified time. This situation might indicate a disaster or failure at the primary site.

- The RCU has received recordsets from the MCU(s) but has not been able to settle a particular recordset within the specified time. This situation might indicate the RCU does not have enough resources to handle remote copy and I/O workloads.

## RCU ready timeout

This group option specifies maximum delay allowed for re-establishing MCU-RCU communications following MCU power-off. During MCU power-on, the MCU re-establishes communications with all registered RCUs. If the MCU cannot re-establish communications with an RCU within the specified time, the MCU suspends all affected CA Asynchronous volume pairs.

## Group operations

CA Asynchronous provides the following group-based operations to simplify and expedite disaster and failure recovery procedures:

- Group operations at the MCU:
  - Split (pairsplit-r) all pairs in a consistency group. See ["Splitting CA pairs \(Pairsplit-r\)"](#) on page 569 for a description of the **Suspend Range-Group** pairsplit-r option.
  - Resume (pairresync) all split or suspended pairs in a group. See ["Resuming CA volume pairs \(Pairresync\)"](#) on page 572 for a description of the CA **Resume Range-Group** pairresync option.
  - Delete (pairsplit-S) all pairs in a group. See ["Deleting CA volume pairs \(Pairsplit-S\)"](#) on page 575 for a description of the **Delete Range-Group** pairsplit-S option.
- Group operations at the RCU:
  - Split (pairsplit-r) all pairs in a consistency group. See ["Splitting CA pairs \(Pairsplit-r\)"](#) on page 569 for a description of the **Suspend Range-Group** pairsplit-r option.
  - Delete (pairsplit-S) all split or suspended pairs in a consistency group except inconsistent pairs. See ["Deleting CA volume pairs \(Pairsplit-S\)"](#) on page 575 for a description of the **Delete Range-C/T** pairsplit-S option.
  - Delete (pairsplit-S) all pairs in a group regardless of their consistency status. See ["Deleting CA volume pairs \(Pairsplit-S\)"](#) on page 575 for a description of the **Delete Range-Group** pairsplit-S option.

CA also provides the **Error Level** pair option (see ["CA initial copy and pair options of the Paircreate pane"](#) on page 568), which triggers automatic suspension of an entire consistency group. When a CA Async pair is suspended due to failure (not user-requested), this CA pair option determines whether all pairs in the same consistency group are also suspended. If you selected the Group error level for the CA Async pair, all pairs in the same group are suspended. If you selected the **LU** error level, only the affected CA Async pair is suspended.

The **Error Level** pair option is very important for managing CA Asynchronous groups and planning disaster recovery. The Group error level should be selected for all CA Async volumes essential to disaster recovery. Suspended CA Async S-VOLs with the LU error level should not be used for disaster recovery because they are not consistent with the rest of the volume group.

## CA volume pair status

CA displays pair status for each volume in the selected logical CU image (CUI) of the connected XP128/XP1024/XP12000. [Table 97](#) describes CA pair status descriptions. The MCU maintains the status of the P-VOL and can change the pair status of the P-VOL and S-VOL. The RCU maintains the status of the S-VOL and can change the pair status of the S-VOL but not the P-VOL. The MCU detects when the RCU changes the S-VOL status (if path status is normal) and changes the P-VOL status accordingly. You can display detailed pair status information at the Command View management station (CA Pairdisplay pane) or UNIX/PC server host (RAID Manager Pairdisplay command).



A volume not assigned to a CA pair has status **SMPL**. When a CA pair is started, the MCU changes the status of the P-VOL and S-VOL to **COPY**. When the initial copy operation is complete, the MCU changes the status of both volumes to **PAIR**. When you split a CA pair (pairsplit-r), the MCU/RCU changes the status of the P-VOL and S-VOL to **PSUS** (if path status is normal). When a pair is suspended due to an error condition, the MCU/RCU changes the P-VOL and S-VOL status to **PSUE** (if path status is normal). When you delete a pair from the MCU (pairsplit-S), the MCU changes the status of the P-VOL and S-VOL to **SMPL** (if path status is normal). When a pair is deleted from the RCU, the RCU changes the S-VOL status to **SMPL**, and the MCU detects the pair deletion (if path status is normal) and changes the P-VOL status to **PSUS**.

When a CA pair is split or suspended, the MCU generates a service information message (SIM) to notify the host(s). This SIM results in a trap indicating the reason for suspension.

## CA LUSE pair status

For CA LUSE pairs only, **PDUB** (dubious) status indicates the status of the CA LUSE volume pair is **COPY** or **PAIR**, but the status of one or more individual LDEV pairs within the CA LUSE pair is **SMPL** or **PSUE** (due to some error condition).

## CA Asynchronous pair status

The **Suspending** and **Deleting** transitional states occur when a request to change CA Async pair status is accepted, but the change to the requested status (**PSUS**, **PSUE**, or **SMPL**) is not yet complete. These states are not reported to the host. For **Suspending**, you and the MCU can request the status change. For **Deleting**, only you can request the status change. If you requested the status change, the final status is reported at the end of the transition. If an error caused the status to change to **PSUE**, the suspended status is reported at the beginning of the transition.

**Table 97** CA Asynchronous pair status descriptions

Pair Status	Description	P-VOL Access	S-VOL Access
SMPL (simplex)	Volume is not currently assigned to a CA volume pair. When this volume is added to a CA pair, its status changes to COPY.	Read/write	Read/write
COPY	Initial copy operation for this pair is in progress. This pair is not yet synchronized. When initial copy is complete, the status changes to PAIR.	Read/write	Read only
PAIR	Pair is synchronized. Updates to the P-VOL are duplicated on the S-VOL.	Read/write	Read only



**Table 97** CA Asynchronous pair status descriptions (continued)

Pair Status	Description	P-VOL Access	S-VOL Access
<p>PSUS (pair suspended-split)  (see <a href="#">Table 98</a> for split types)</p>	<p>Pair is not synchronized because you split this pair (pairsplit-r) or deleted this pair from the RCU (pairsplit-S). For CA Async pairs, the MCU and RCU track recordsets discarded during the pairsplit-r operation. While a pair is split, the MCU and RCU track P-VOL and S-VOL cylinders updated.</p> <p>When you split a pair from the MCU, the MCU changes the status of the P-VOL and S-VOL to PSUS. When you split a pair from the RCU, the RCU changes the status of the S-VOL to PSUS. The MCU detects this (if path status is normal) and changes the P-VOL status to PSUS.</p> <p>When you delete a pair from the RCU, the RCU changes the S-VOL status to SMPL. The MCU detects this (if path status is normal) and changes the P-VOL status to PSUS. You must delete the pair from the MCU to change the P-VOL status to SMPL.</p>	<p>Read/write</p>	<p>Read only; Read and write, if write enable split option is selected.</p>
<p>PSUE (pair suspended-error)  (see the table in <a href="#">Table 98</a> for suspend types)</p>	<p>Pair is not synchronized because the MCU or RCU suspended the pair due to an error condition. For CA Async pairs, the MCU and RCU track recordsets discarded during the suspension operation. The MCU tracks P-VOL cylinders updated while the pair is suspended.</p> <p>For CA Synchronous pairs, if the MCU cannot keep the pair synchronized for any reason, the MCU changes the status of the P-VOL and S-VOL (if possible) to PSUE.</p> <p>For CA Asynchronous pairs, if the MCU detects a suspension condition (see "<a href="#">CA Asynchronous suspension conditions</a>" on page 503), the MCU changes the P-VOL and S-VOL status (if possible) to PSUE.</p> <p>For CA Asynchronous pairs, if the RCU detects a suspension condition (see "<a href="#">CA Asynchronous suspension conditions</a>" on page 503), the RCU changes the S-VOL status to PSUE, and the MCU detects this (if path status is normal) and changes the P-VOL status to PSUE.</p>	<p>Read/write; Read only if fenced.</p>	<p>Read only</p>
<p>Pair Status for CA LUSE volumes only:</p>			
<p>PDUB</p>	<p>CA pair consists of LUSE volumes (for example, OPEN3*n), and an individual LDEV within this CA LUSE pair failed due to some error condition. The status of the CA LUSE volume is PAIR or COPY, and the status of one or more LDEV pairs is PSUE or SMPL.</p>	<p>Read/write</p>	<p>Read only</p>

**Table 97** CA Asynchronous pair status descriptions (continued)

Pair Status	Description	P-VOL Access	S-VOL Access
Pair Status for CA Asynchronous only:			
Suspending	Pair is not synchronized. This pair is transitioning from PAIR or COPY to PSUS/PSUE. When the split/suspend pair operation is requested, the status of all affected pairs changes to <b>Suspending</b> . When the split/suspend operation is complete, the status changes to PSUS/PSUE.	Read/write	Read only
Deleting	Pair is not synchronized. This pair is transitioning from PAIR, COPY, or PSUS/PSUE to SMPL. When the pairsplit-S operation is requested, the status of all affected pairs changes to <b>Deleting</b> . When the pairsplit-S operation is complete, the status changes to SMPL.	Read/write	Read only

## CA split types (PSUS)

**Table 98** describes CA split types. You can split a CA pair at any time after the initial copy operation is complete. You must split a CA pair to perform media maintenance on the P-VOL or change the S-VOL (S-VOL write enable).

When you split a CA Synchronous pair, the MCU ensures synchronization by completing any pending update copy operation before changing the status to PSUS. After the pair status changes to PSUS, the MCU stops performing update copy operations to the S-VOL and may or may not continue accepting write I/Os for the P-VOL, depending on the P-VOL fence level and pairsplit-r options. If the P-VOL accepts write operations while the pair is split, the MCU tracks P-VOL cylinders updated. If you enabled the S-VOL write option when you split the pair, the RCU tracks S-VOL cylinders updated while the pair is split. When the pair is resumed (pairresync), the RCU sends the S-VOL cylinder bitmap to the MCU, and the MCU merges the P-VOL and S-VOL bitmaps to determine which cylinders are out-of-sync.

When you split a CA Asynchronous pair, the MCU and RCU ensure synchronization by completing or discarding pending update copy operations according to the user-specified drain/purge pairsplit option. The MCU and RCU track recordsets discarded during the pairsplit operation. After the pair status changes to PSUS, the MCU stops performing recordset operations for the pair, continues accepting write I/Os for the split CA Async P-VOL, and tracks P-VOL cylinders updated while the pair is split. If you enabled the S-VOL write option when you split the pair, the RCU also tracks the S-VOL cylinders updated while the pair is split. When the pair is resumed, the RCU sends the S-VOL cylinder bitmap to the MCU, and the MCU merges the P-VOL and S-VOL bitmaps to determine which cylinders are out-of-sync.

A split (or suspended) CA Async S-VOL has an additional status called consistency status. The consistency status is displayed only at the RCU and indicates the S-VOL's update sequence consistency with respect to other S-VOLs in the same group.

**Table 98** CA split types (PSUS)

Type	Applies to	Description
PSUS, P-VOL by Operator	P-VOL (CA Sync only)	You split the pair from the MCU using the <b>P-VOL Failure</b> option. S-VOL split type is <b>PSUS-by MCU</b> .
PSUS, S-VOL by Operator	P-VOL, S-VOL	You split the pair from the MCU or RCU using the <b>S-VOL</b> option.

**Table 98** CA split types (PSUS) (continued)

Type	Applies to	Description
PSUS, by MCU	S-VOL	The RCU received a request from the MCU to split the pair. P-VOL split type is <b>PSUS-P-VOL by Operator</b> or <b>PSUS-S-VOL by Operator</b> .
PSUS, Delete pair to RCU	P-VOL	The MCU detected the S-VOL status changed to <b>SMPL</b> because you deleted the pair (pairsplit-S) from the RCU. The pair cannot be resumed because the S-VOL does not have the <b>PSUS/PSUE</b> status.

[Table 99](#) describes the consistency status for split or suspended CA Async S-VOLs (consistency status is displayed only at the RCU).

**Table 99** Consistency status descriptions for split/suspended CA Async S-VOLs

Consistency Status (displayed at RCU)	Description
Volume	<p>CA Asynchronous volume pair was probably split or suspended alone. Update sequence consistency between this S-VOL and other S-VOLs in this consistency group is not ensured. This S-VOL cannot be used for disaster recovery at the secondary site. This status is indicated when:</p> <p>You split this pair using the <b>Suspend Range-LU</b> pairsplit-r option.</p> <p>This pair was suspended due to a failure that did not affect the entire consistency group, and the <b>Error Level</b> pair option for this pair is set to <b>LU</b>.</p>
Group	<p>CA Asynchronous volume pair was split or suspended with other pairs in its consistency group. Update sequence consistency between this S-VOL and other S-VOLs in this consistency group is ensured. This S-VOL can be used for disaster recovery at the secondary (remote) system (after deleting the CA Async pair from the RCU). This status is indicated when:</p> <p>You split this pair using the <b>Suspend Range-Group</b> pairsplit-r option.</p> <p>All pairs in this consistency group were suspended due to a failure that affected the entire consistency group, not just one pair (for example, MCU-RCU communication failure).</p> <p>One pair in the group was suspended due to a failure that did not affect the entire group, and the <b>Error Level</b> pair option for this pair is set to <b>Group</b>.</p>

## CA suspend types

[Table 100](#) describes CA suspend types, which indicate the reason for suspension. Only the MCU can suspend CA Synchronous pairs. The MCU or RCU can suspend CA Asynchronous pairs. For further information, see "[CA Asynchronous suspension conditions](#)" on page 503.

The MCU suspends a CA pair when it detects the following suspension conditions:

- The MCU detects that you deleted the volume pair from the RCU
- The MCU detects an error condition related to the RCU, S-VOL, or CA update copy operation
- The MCU cannot communicate with the RCU
- The MCU detects a CA Asynchronous suspension condition

When a CA Sync pair is suspended, the MCU stops performing update copy operations to the S-VOL and may or may not continue accepting write I/Os for the P-VOL, depending on the P-VOL fence level pair option. If a synchronous update copy operation fails, the MCU maintains exact synchronization by

reporting a unit check and decommitting the P-VOL update. The host system and application program regard that write operation to the P-VOL as failed. If the MCU accepts write I/Os for a suspended P-VOL, the MCU tracks P-VOL cylinders updated while the pair is suspended. When a suspended sync pair is resumed, the MCU copies out-of-sync P-VOL cylinders to the S-VOL. CA does not allow access to an S-VOL while the pair is suspended (only when split).

You must stop host I/Os before suspending CA Synchronous pairs with the Data fence level and following conditions:

- CA Synchronous and Asynchronous pairs exist in the same disk array
- There are host I/Os to the CA Asynchronous pairs

If you do not stop host I/Os, pairs might be forcibly suspended because of a time-out error, and host I/Os are rejected.

When a CA Asynchronous (CA Async) pair is suspended, the MCU stops performing CA Async recordset operations for the pair. The MCU continues accepting write I/Os for the suspended P-VOL and tracks P-VOL cylinders updated while the pair is suspended. The MCU and RCU also tracks recordsets discarded during the pair suspension. When a suspended CA Async pair is resumed, the RCU sends the S-VOL cylinder bitmap to the MCU, and the MCU merges the P-VOL and S-VOL bitmaps to determine which cylinders are out-of-sync. This method ensures that all cylinders containing recordsets discarded at the RCU are resynchronized at this time.

A suspended (or split) CA Async S-VOL has an additional status called consistency status. Consistency status is displayed only at the RCU and indicates the S-VOL's update sequence consistency with respect to other S-VOLs in the same group. See [Table 99](#) for a description of consistency status for suspended/split CA Async S-VOLs.

**Table 100** CA suspend types

Type	Applies to	Description
PSUE, by RCU	P-VOL, S-VOL	The MCU detected an error condition at the RCU causing the MCU to suspend the CA volume pair. S-VOL suspend type is <b>PSUE-S-VOL Failure</b> .
PSUE, S-VOL Failure	P-VOL, S-VOL	The MCU detected an error during RCU communications or update copy. In this case, S-VOL suspend type is usually <b>PSUE-S-VOL Failure</b> . This suspend type is also used when the number of paths falls below the minimum number of paths setting on the RCU Option pane.
PSUE, MCU IMPL	P-VOL, S-VOL	The MCU could not find valid control information in its nonvolatile memory during IMPL. This condition occurs only if the MCU is without power for more than 48 hours (power failure and fully discharged backup batteries).
PSUE, Initial Copy Failed	P-VOL, S-VOL	The CA pair was suspended before the initial copy operation was complete. Data on the S-VOL is not identical to data on the P-VOL.
PSUE, MCU P/S OFF	S-VOL (CA Async only)	The RCU received a request from the MCU to suspend the S-VOL due to MCU power-off. The RCU stops expecting recordsets from that MCU. The P-VOL status does not change due to MCU power-off.
PSUS, Sidefile overflow (CA Async only)	P-VOL, S-VOL	The amount of sidefile exceeds the specified "current pending update data rate," and the RCU data is not transferred within the specified "offloading timer."

## CA Asynchronous suspension conditions

CA Asynchronous operations involve additional suspension conditions related to recordset operations. The MCU and RCU detect CA Async suspension conditions and suspend CA Async pairs. When a CA Async pair is suspended, cylinders containing the following records are marked in the cylinder bitmap as modified (to be copied during the pairresync operation):

- Recordsets created by the MCU, but not yet sent to the RCU. After marking these P-VOL cylinders as modified, the MCU discards these recordsets.
- Recordsets sent to the RCU, but not acknowledged by the RCU. The MCU marks these P-VOL cylinders as modified and discards these recordsets, ensuring that recordsets lost during transmission to the RCU are identified and marked.
- Recordsets that reached the RCU, but have not yet been settled. After marking these S-VOL cylinders as modified, the RCU discards these recordsets.
- P-VOL records updated by host-requested write I/Os after the pair was suspended (same function as for CA Synchronous pairs).

If a recordset is lost in transmission from the MCU to the RCU, the MCU's cylinder bitmap ensures the missing recordset is marked. After the MCU sends the recordset to the RCU, the MCU does not remove the sidefile entry for the recordset from its cache until it receives an I/O completion signal (device end) from the RCU.

Table 101 describes CA Asynchronous suspension conditions and indicates which CU detects the condition and which pairs are suspended. The CA offloading timer option (see "[Asynchronous copy option](#)" on page 553) and timeout group options (see "[Modifying consistency group options \(CT Group Option\)](#)" on page 551) control CA Asynchronous suspension conditions. See Table 153 for troubleshooting CA Asynchronous suspension conditions.

**Table 101** CA Asynchronous suspension conditions

Suspension Condition	Detected by	CA ASYNC Pairs to be Suspended
The MCU could not send a pending recordset to the RCU before the offloading timer async option expired.	MCU	All CA ASYNC pairs with P-VOLs in the MCU.
During MCU power-on, the MCU could not establish communications with the RCU before the RCU ready timeout group option expired.	MCU	All CA ASYNC pairs with P-VOLs in the MCU.
The RCU could not settle a pending recordset before the copy pending timeout group option expired.	RCU	All CA ASYNC S-VOLs in the consistency group.
The RCU could not communicate with the MCU before the copy pending timeout group option expired (see " <a href="#">Modifying consistency group options (CT Group Option)</a> " on page 551).	RCU	All CA ASYNC S-VOLs in the consistency group.
The RCU could not receive the recordset successfully due to a hardware failure.	RCU	Only the affected S-VOL.
The RCU detected a logical error while selecting the recordset to be settled.	RCU	All CA ASYNC S-VOLs in the consistency group or only the affected S-VOL, depending on type of failure and error level CA ASYNC pair option.
The RCU could not settle the recordset due to a hardware failure, track condition, or logical error.	RCU	

---

# Preparing for CA operations

## System requirements

CA operations involve MCUs and RCUs containing primary and secondary volumes, remote copy connections between MCUs and RCUs, UNIX and/or PC server host(s) at primary and remote sites, CA, and Command View management station. CA system requirements are:

- **MCU:** Disk array with CA installed.
- **RCU:** Disk array with CA installed.
- **UNIX-based and/or PC server platforms:** The disk array supports CA operations for a variety of UNIX and PC-server platforms, including the Sun Solaris, IBM AIX, HP-UX, and Windows NT platforms. Contact your HP account support representative for the latest information on XP128/XP1024/XP12000 platform support for CA.
- **Remote copy connections – Fibre Channel:**
  - Multimode optical fibre cables at both the MCU and RCU
  - For distances from 0.5 km to 11 km, multimode shortwave Fibre Channel interface cables with up to two switches
  - For distances greater than 11 km, approved third-party channel extender (or DWDM) products and telecommunications lines
- **Remote copy connections – serial:**
  - Multimode serial interface (ESCON) cables at both the MCU and RCU.
  - For distances from 3 km to 43 km (1.9 to 26.7 miles), single-mode serial interface cables with ESCON directors (ESCDs) and/or ESCON repeaters.
  - For distances greater than 9 km (5.6 miles), extended distance facility (XDF) provided by the ESCDs and/or ESCON repeaters.
  - For distances greater than 43 km (26.7 miles), approved third-party channel extender products and telecommunications lines. Long-distance solutions are provided based on user requirements and workload characteristics. Usage of channel extenders may require additional disk array configuration.
- **Command View management station:** Web browser to operate Command View and CA, and CA license key codes. If you are using CA for disaster recovery, install a second Command View management station at the remote site.



**NOTE:** You must operate Command View in Modify mode to perform CA operations. In view mode, you can only view CA information.

---

## Requirements and restrictions

CA has the following requirements and restrictions:

- One-to-one volume copy operations
- Logical unit (LU) type (also called device emulation or type)
- Consistency groups

- Accessing CA P-VOLs and S-VOLs
- Cache and NVS
- Host failover software
- Duplicate volume
- Host system crash

## One-to-one volume copy operations

CA requires a one-to-one relationship between logical volumes of volume pairs. A volume (LU) can only be assigned to one CA pair at a time. CA does not support operations in which one P-VOL is copied to more than one S-VOL or more than one P-VOL is copied to one S-VOL. Because CA operates on logical volumes rather than files, multivolume files require special attention. For complete duplication and recovery of a multivolume file (such as a large database file spanning several volumes), ensure that all volumes of the file are copied to CA S-VOLs, and use CA Asynchronous to ensure update sequence consistency across this group of S-VOLs.

## Logical unit (LU) types

CA supports basic LU types that can be configured on the disk array. CA displays the LU type of P-VOLs and S-VOLs. A CA pair must consist of LUs of the same type and capacity (for example, OPEN-3 to OPEN-3). Mainframe volumes (for example, 3390-3A/B/C, 3380-KA/B/C) cannot be assigned to CA pairs.



**NOTE:** Contact your HP account support representative for the latest information on supported devices for your platform.

CA supports the LU Size Expansion (LUSE) feature of the disk array, which configures expanded LUs using two or more contiguous LDEVs (up to 36). If two LUSE volumes are paired with TrueCopy, a LUSE P-VOL must be paired with an S-VOL of the same size and structure. For example, if a LUSE P-VOL is connected with volumes of 1GB, 2GB, and 3GB in this order, you must specify the LUSE volume that has exactly the same size and connection order as the S-VOL. When LUSE volumes are assigned to a CA pair, the P-VOL and S-VOL must contain the same type and number of LDEVs (for example, OPEN-3\*6 to OPEN-3\*6). The number of LDEV pairs in a CA LUSE pair equals the number of LDEVs in each LUSE volume. When the status of all LDEV pairs within one CA LUSE pair is not the same (for example, one LDEV pair is suspended), the pair status of the CA LUSE pair changes to PDUB.

CA supports the VSC feature of the disk array, which configures custom-size LUs that are smaller than standard-size LUs. When custom-size LUs are assigned to a CA pair, the S-VOL must have the same capacity as the P-VOL.

## Consistency groups

CA Asynchronous consistency groups have the following requirements:

- Each CA Async pair must be assigned to one and only one consistency group.
- Maximum number of volume pairs in one consistency group is 4,096 (entire RCU) (4,095 when the RAID Manager command device is defined).
- Maximum number of consistency groups established for one MCU-RCU pair is 128 (00-7F). The RCU supports a maximum of 128 groups, which includes both CA Async groups and Mainframe mirroring Asynchronous groups (for example, 64 CA Async + 64 mainframe).
- Consists of only CA Async pairs (no mainframe pairs).
- Only CA Asynchronous pairs belonging to the same CLPR can be allocated to one CA consistency group. For more information about CLPRs, see ["Disk/Cache Partition for the XP12000"](#) on page 143.

## Accessing CA P-VOLs and S-VOLs

To ensure maximum data integrity during normal CA operations, the RCU rejects all write operations issued by a host to a CA S-VOL. If you need write access to a CA S-VOL, split the pair using the S-VOL write option (see “S-VOL write option” on page 493). When you resume (resync) the split pair, the RCU sends the S-VOL cylinder bitmap to the MCU to ensure proper resynchronization of the pair.

## Cache and nonvolatile storage (NVS)

Cache and nonvolatile storage (NVS) must be operable for both the MCU and RCU of a CA volume pair. If not, the CA paircreate operation fails. Configure the remote disk array cache to adequately support CA remote copy workloads and local workload activity.

## Host failover software

Host failover software is a critical component of any disaster recovery effort. When an MCU fails to maintain synchronization of a CA pair, the MCU generates sense information. This information **must** be transferred to the remote site via the host failover software for effective disaster recovery.

## Duplicate volumes

Because the contents of the P-VOL and S-VOL of a CA pair are identical, the S-VOL is considered a duplicate of the P-VOL. Because the host operating system does not allow duplicate volumes, the host system administrator must take precautions to prevent system problems related to duplicate volumes. You must define the CA S-VOLs so they do not auto-mount or come online to the same host at the same time as the P-VOLs (see the following **CAUTION**).

CA does not allow the S-VOL to be online (except when the pair is split). If the S-VOL is online, the CA paircreate operation fails.



**CAUTION:** If CA S-VOLs are physically attached to the same host server(s) as CA P-VOLs, a problem might occur. When a CA pair is deleted, the old S-VOL is usually offline. If the host is then restarted, the system administrator may be offered both volumes and asked which volume should be left offline. This can be confusing and is prone to error.

If CA S-VOLs and P-VOLs are connected to the same host(s), HP strongly recommends that you define S-VOLs to remain offline (or create them with the RAID Manager ‘no read’ option) to avoid this problem.

---

## Host system crash

Contents of the P-VOL and S-VOL of a CA pair may become inconsistent if the host system hangs (crashes) while a write operation is being performed on the CA P-VOL, and the write operation cannot be retried because of the following reasons:

- A check condition is reported to the host due to a failure in the disk array when the write command for the CA pair is issued.
- A reset command is issued from the host, and the write operation is stopped (write operation is incomplete).

If these conditions occur, retry the job to complete the write operation.

## Installing hardware

Initial installation of the CA hardware is performed by the user and the HP representative. Hardware configurations for CA Synchronous and CA Asynchronous are the same.

1. **User:** Identify locations of CA primary and secondary volumes (P-VOLs and S-VOLs), so Performance Advisor hardware can be installed and configured properly.



2. **User and HP representative:** Install the Command View management station near CA MCU(s), and connect the Command View management station to MCU(s) via the internal LAN. HP recommends you also install a Command View management station connected to RCUs at the remote site.
3. **HP representative:** Ensure that MCUs and RCUs are properly configured for CA operations (for example, cache or NVS) (see "Cache and nonvolatile storage (NVS)" on page 506). Ensure that adequate cache is installed and available for all open systems and mainframe asynchronous mirroring operations. Also consider the amount of HP Cache LUN XP data to be stored in cache when determining the required amount of cache.
4. **HP representative:** Ensure that MCUs are configured to report sense information to host(s). RCUs should also be attached to a host server to enable reporting of sense information if a problem with an S-VOL or RCU occurs. If the remote site is unattended, RCUs should be attached to a host server at the primary site, so the system administrator can monitor operational condition of RCUs.
5. **HP representative:** If power sequence control cables are used, set the power select switch for the cluster to LOCAL to prevent the host from powering off the MCU. Also ensure that the RCU will not be powered off during CA operations. See "Powering off and on CA components" on page 580 for further information.
6. **HP representative:** For Fibre Channel interface connections, install the Fibre Channel adapter features. For serial interface connections, install the serial port adapter features. If the MCU and RCU are multiplatform disk arrays, serial interfaces might be available, and additional serial port adapter features might not be required.
7. **HP representative:** Install the CA remote copy connections between MCU(s) and RCU(s). The user supplies this hardware (optical fibre cables, switches, ESCON cables, and so on). See "Fibre Channel remote copy connections" on page 507 for remote copy configurations. Distribute paths between different storage clusters and switches to provide maximum flexibility and availability. Logical paths between the MCU and RCU must be separate from logical paths between the host and RCU. For Fibre Channel and serial interface connections, only CA activities (Sync and Async) can share the same direct connect or switch zoned fibre remote copy connections (future support will eliminate this restriction).

## Fibre Channel remote copy connections

Figure 274 shows remote copy connection configurations for Fibre Channel interface CA operations. The MCU and RCU of each CA pair must be connected via multimode shortwave optical fibre cables. For multimode shortwave optical fibre cables, fibre cables up to 1.5 km in length and up to two switches are required for distances greater than 0.5 km. For single-mode longwave optical fibre cables between two switches, fibre cables up to 11 km in length can be used (.5km+10km+.5km). Using DWDM between two FC switches can allow a distance of 80km or more. Long-distance solutions are provided using approved channel extenders and communication lines.

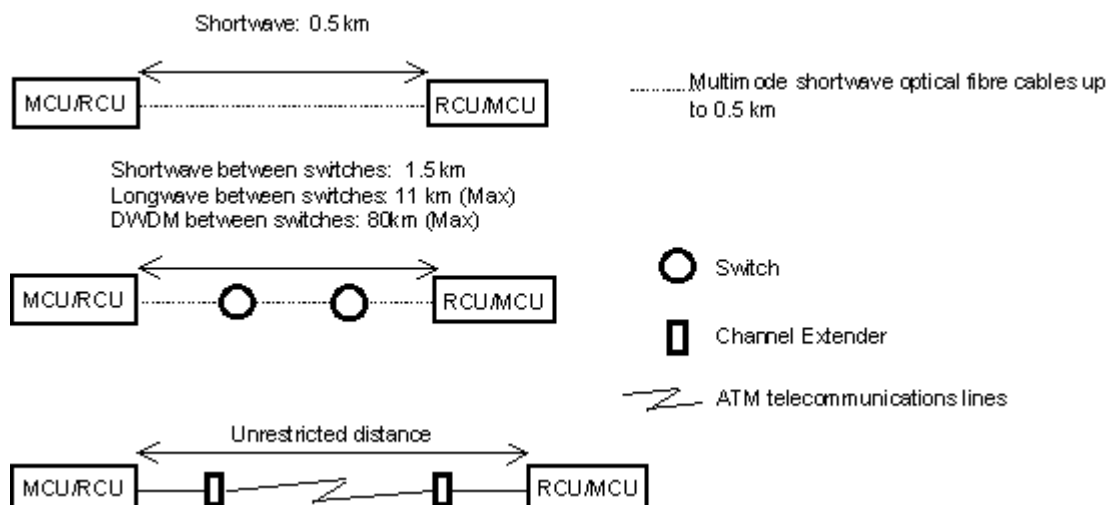

Figure 274 Fibre Channel remote copy connections



**NOTE:** For Fibre Channel interface connections, use the switches as ordinary switch connections. No special settings are required for the XP128/XP1024/XP12000.

Fibre Channel interface connection provides the following configurations:

- **Direct connection:** Two devices are connected directly.

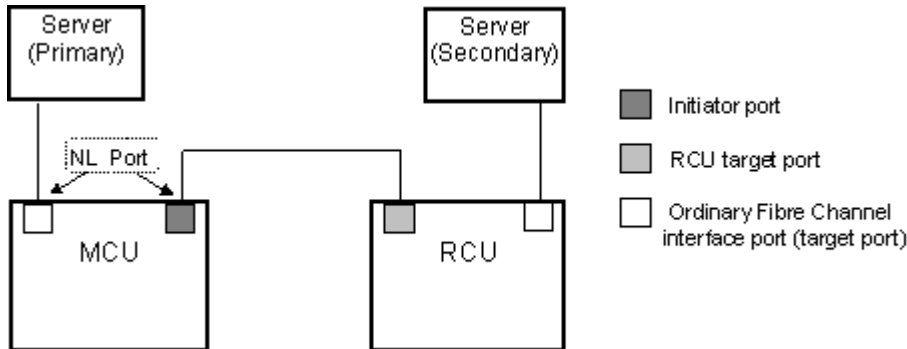

**Figure 275** Direct connection

- **Switch connection:** Up to three optical fibre cables (per hard zone) are connected via switches to connect the devices. Up to two switches can be used.

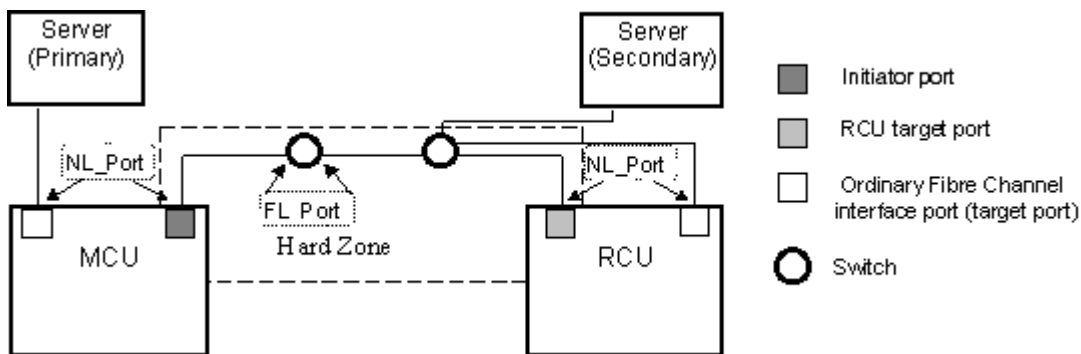

**Figure 276** Switch connection

- **Extender connection:** Protocol converters and switches are used to connect devices across large distances.

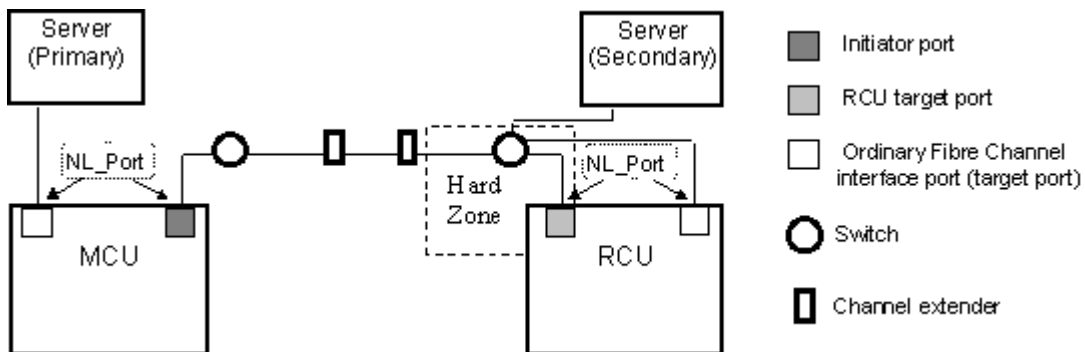

**Figure 277** Extender connection

## Serial remote copy connections

Figure 278 shows CA serial remote copy connection configurations. The MCU and RCU of each pair must be connected via multimode ESCON cables. For distances greater than 3 km, single-mode cables up to 20 km in length and ESCDs and/or ESCON repeaters are required. ESCDs support the extended distance facility (XDF), which uses single-mode ESCON cables up to 20 km. ESCON repeaters support single-mode-to-single-mode connections or single-mode-to-multimode connections. When disk arrays running CA are more than 9 km apart, XDF connections provided by ESCDs or ESCON repeaters are required. CA operations can be performed at distances of up to 43 km (26.7 miles) using standard ESCON support. Long-distance solutions are provided using approved channel extenders and communication lines.

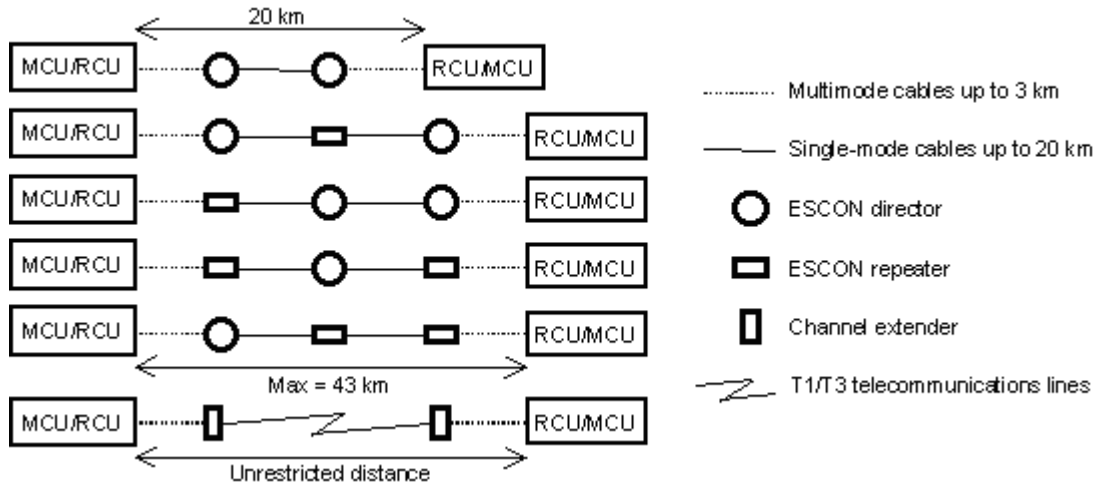

**Figure 278** Serial remote copy connections

You can install dedicated ESCON channels or use existing ESCON channels connected by ESCDs. Logical paths between the MCU and RCU must be separate from logical paths between the host and RCU. All remote copy activities between two XP disk arrays can share the same remote copy connections.

ESCDs can accommodate multiple MCU-RCU remote copy connections (Figure 279).

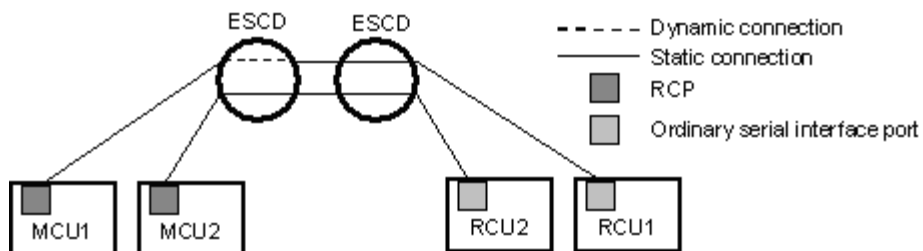

**Figure 279** N pairs of remote copy connections

You can configure n-to-1 or 1-to-n remote copy connections ( $n \neq 1$ ) using the dynamic switching capability of ESCDs to share physical interface cables between components (Figure 280).

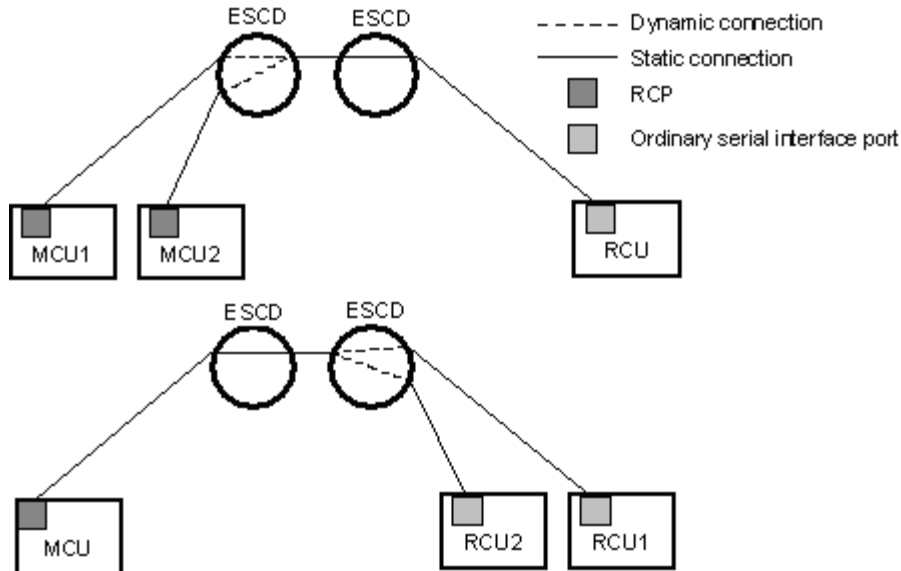

Figure 280 N-to-1 and 1-to-n remote copy connections ( $n \neq 1$ )



**NOTE:** 1-to-n configurations (one main disk array and multiple remote disk arrays) are valid for CA Asynchronous, as long as a consistency group does not span remote disk arrays.

ESCDs can accommodate channel-to-MCU and channel-to-RCU connections in addition to remote copy connections (see Figure 281).

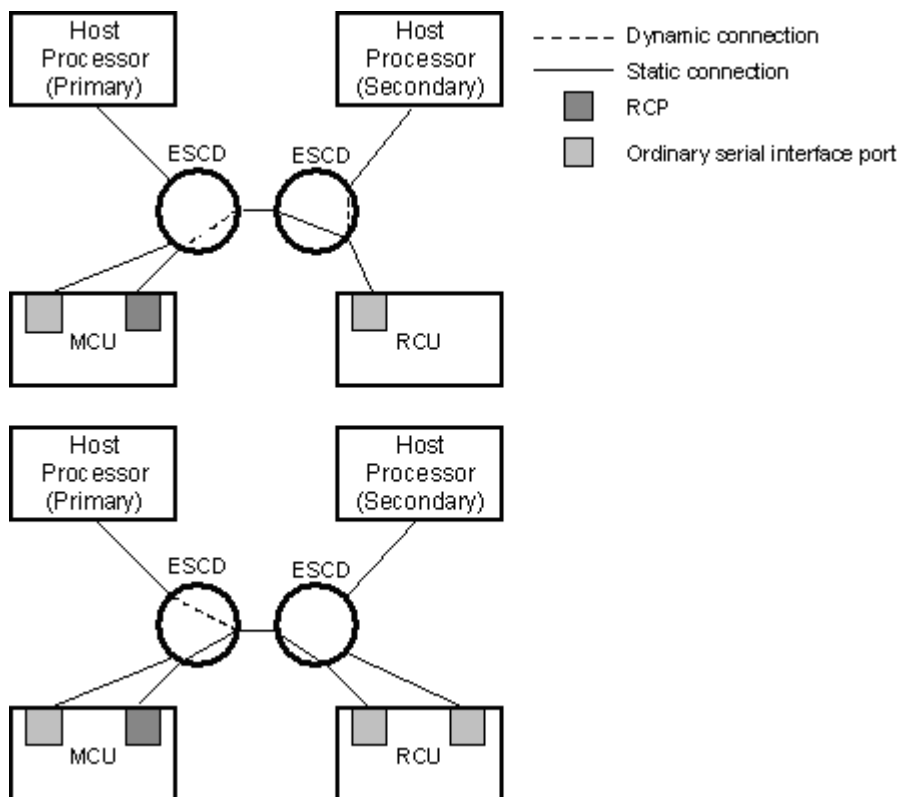

Figure 281 Remote copy connections shared with channel-to-RCU connections

# Configuring MCUs and RCUs for CA operations

After preparing the hardware and software, configure MCUs and RCUs for CA operations.

## Fibre Channel and serial interface configuration

1. Identify volumes that will become CA P-VOLs and S-VOLs. You must know the disk array S/N, SSID, and CU image of each CA volume, so you can configure MCUs and RCUs correctly for your pairs and async groups. When you create pairs, you must know the port, target ID, and LUN of each volume.
2. If Performance Advisor (PA) is connected to the disk array being configured as a CA MCU, disconnect PA to avoid contention on the internal LAN.
3. For FC configurations, at the RCUs, use CA to configure the Fibre Channel ports connected to MCUs as RCU target ports (see "Port change operation" on page 546 for instructions).
4. Connect to the disk array you want to configure as a CA MCU.



**NOTE:** You must operate Command View in Modify mode to perform CA operations. In view mode, you can only view CA information.

5. Click **CA** to start CA. The CA main pane appears (Figure 288).
6. For FC configurations, configure Fibre Channel ports connected to RCUs as initiator ports. For serial interface configurations, configure serial channel ports connected to RCUs as RCPs. For instructions, see "Port change operation" on page 546.
7. Register the RCU(s) to the current MCU CU image by using the Add RCU pane. Set the options for the registering RCU by using the RCU Option pane (see "Registering RCUs (Add RCU)" on page 536 for instructions).

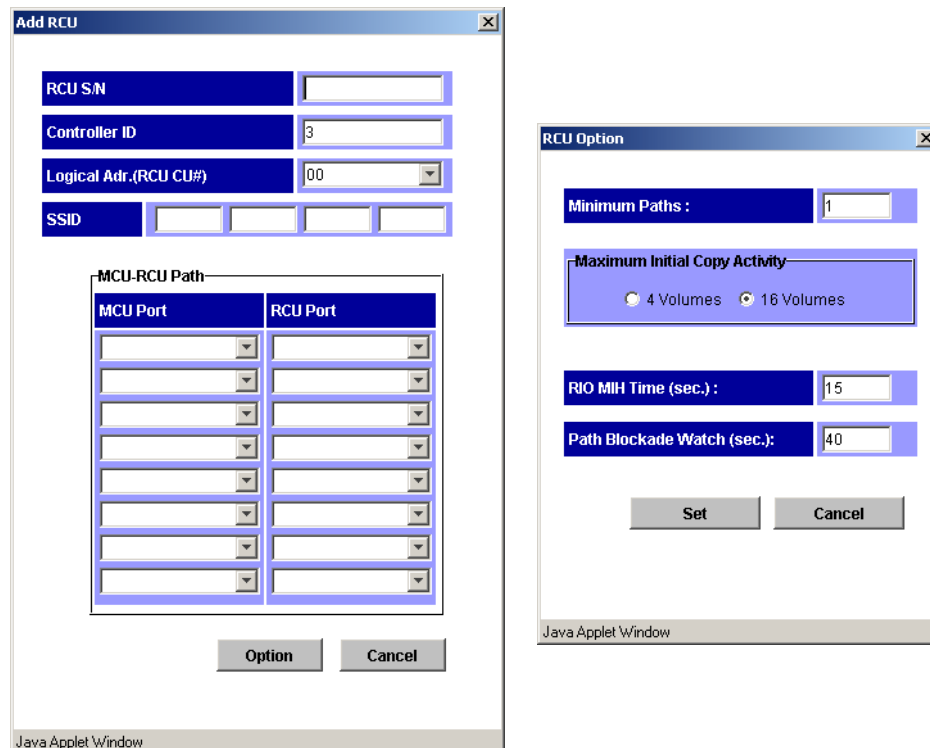

**Figure 282** Add RCU and RCU Option panes

8. If you plan to create CA Async pairs with P-VOLs in this MCU, configure Async options using the Async Option pane (see "Asynchronous copy option" on page 553 for instructions). Register the

consistency group(s) to the MCU using the Add CT Group pane (see “Adding consistency groups (Add CT Group)” on page 550 for instructions).

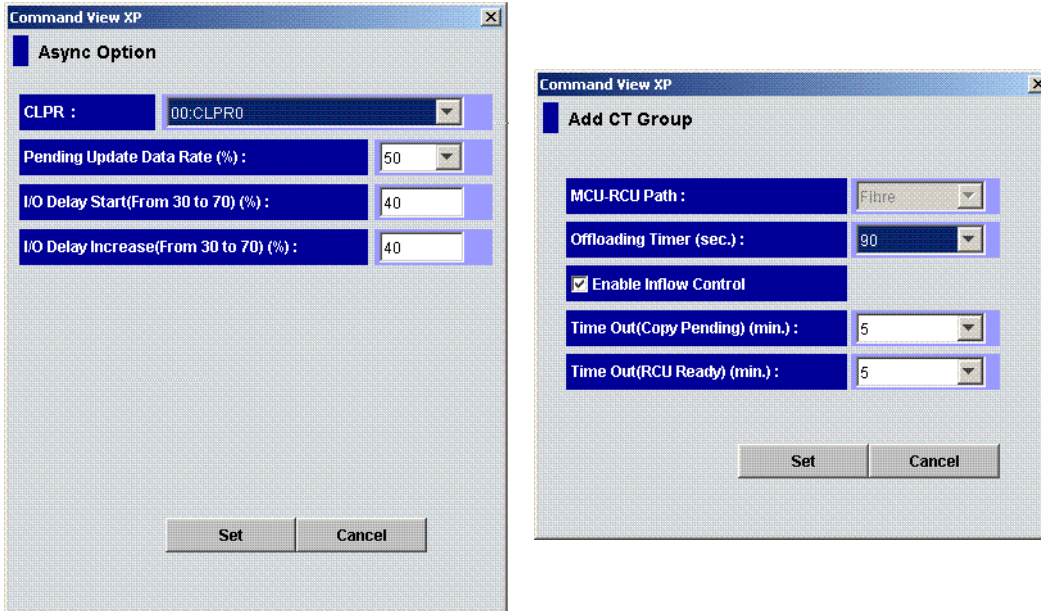

**Figure 283** Async Option and Add CT Group panes

9. When you are finished configuring this MCU, exit the CA main pane, and disconnect the Command View management station from the disk array.
10. If needed, reconnect Performance Advisor to this disk array (running PA at the same time is not supported).
11. Repeat [step 4](#) - [step 9](#) for each disk array that will function as a CA MCU. After you configure MCUs, register RCUs, and configure CA async options and consistency groups, you are ready to begin CA volume pair operations.

## Combining CA with other data management operations

CA supports concurrent operations with the following data management functions:

- **LU Size Expansion (LUSE).** LUSE volumes can be assigned to CA pairs, if the P-VOL and S-VOL have the same LU type and number of LDEVs. To perform LUSE operations on an existing CA P-VOL or S-VOL, delete the pair first to return the volume to SMPL status.
- **VSC.** Custom volumes can be assigned to CA pairs if the S-VOL has the same capacity as the P-VOL. If you need to perform VSC operations on an existing CA P-VOL or S-VOL, delete the pair first to return the volume to SMPL status.
- **HP Cache LUN XP.** HP Cache LUN XP volumes can be assigned to CA pairs, and HP Cache LUN XP operations can be performed on CA P-VOLs and S-VOLs.
- **LUN Security.** LUN Security operations do not affect CA operations. Volumes under secure ports and/or assigned to World Wide Name (WWN) groups and/or LUN groups can also be assigned to CA pairs. Volumes assigned to CA pairs can also be assigned to secure ports, WWN groups, and/or LUN groups for LUN Security.



**NOTE:** CA S-VOLs cannot be accessed by any UNIX/PC server host unless the pair is split.

- **BC.** BC volumes can be assigned to CA pairs, and CA volumes can be assigned to BC pairs. See “Combining CA and BC” on page 513 for more information.

BC is recommended for intra-disk array copy operations. If BC is not installed, use CA (Synchronous only) to copy within the same disk array. This configuration requires at least one external fibre cable or ESCON loop.

- **Prioritized Port Control.** Initiator ports in the MCU do not support the Prioritized Port/WWN Control option.

## Combining CA and BC

Use Continuous Access and Business Copy in the same disk array and on the same volumes to provide multiple copies of data at primary and/or remote sites. [Table 102](#) describes host pair status reporting for CA volumes, BC volumes, and CA/BC shared volumes. [Table 103](#) shows currency of data on a shared CA/BC volume based on CA and BC pair status.

- For shared CA/BC volumes, the CA pair status is reported to the host if you query the CA P-VOL or S-VOL. To obtain the BC pair status, query the P-VOL of the BC pair.
- BC supports multiple S-VOLs for each P-VOL. If you issue a pair status query to a BC P-VOL (for example, pairdisplay), the status for only one BC pair is reported (pair with the S-VOL with lowest LDEV ID). To obtain the pair status for BC pair(s) with other S-VOL(s), direct the host query to the specific S-VOL using the S-VOL's LDEV ID in the host command. The BC remote console software displays the LDEV ID and BC pair status of all S-VOLs associated with a P-VOL.

**Table 102** Host pair status reporting for CA, BC, and CA/BC shared volumes

Number of CA Pairs	Number of BC S-VOLs	Pair Status Reported by Disk Array
0	0	Simplex
0	1	BC pair status
0	2 or more	BC pair status for pair whose S-VOL has lowest LDEV ID
1	0	CA pair status
1	1	CA pair status
1	2 or more	CA pair status

**Table 103** Data Currency of a shared CA/BC volume

CA Pair Status	BC Pair Status					
	COPY (PD)	PAIR	COPY (SP)	PSUS	COPY (RS/RS-R)	PSUE
COPY	Not current	Not current	Not current	CURRENT	Not current	Not current
PAIR	Not current	Not current	Not current	CURRENT	Not current	Not current
PSUS/PSUE	Not current	CURRENT	CURRENT	CURRENT	CURRENT	Not current

The following figures show various CA/BC configurations that share volumes. CA supports synchronous and asynchronous operations for shared CA/BC volumes.

- **Figure 284** shows an example of a CA P-VOL that also functions as a BC P-VOL. With this configuration, use BC for on-site data backup if a CA failure occurs, and use CA to provide remote backup of the BC P-VOL if a BC failure occurs.

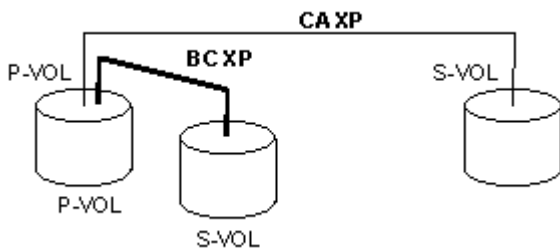

**Figure 284** Shared CA P-VOL and shared BC P-VOL

- **Figure 285** shows an example of a CA S-VOL that also functions as a BC P-VOL. With this configuration, use BC to provide multiple backup copies of a single CA P-VOL.

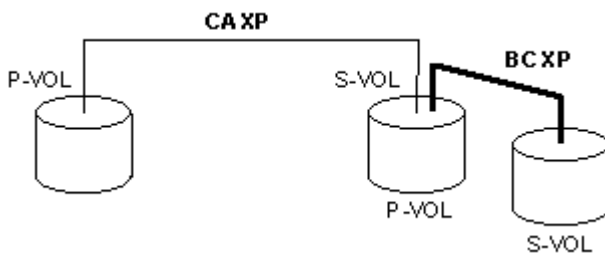

**Figure 285** Shared CA S-VOL and shared BC P-VOL

- **Figure 286** combines the configurations shown in the two previous figures. Within a single CA pair, the P-VOL and S-VOL function as BC P-VOLs, providing multiple copies at primary and remote sites.

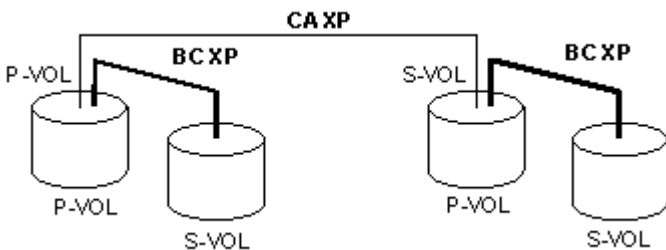

**Figure 286** Shared CA/BC P-VOL and shared CA S-VOL/BC P-VOL

- **Figure 287** shows an example of a BC S-VOL that is also used as a CA P-VOL.

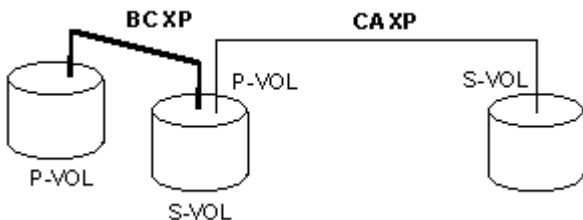

**Figure 287** Shared BC S-VOL/CA P-VOL



**CAUTION:** This configuration requires that the BC pair be established in duplex mode (PAIR) and then split (PSUS) before the CA pair is created (both BC and CA being in PAIR state at the same time is not allowed).

## Starting CA

You must operate Command View in Modify mode to perform CA operations. In view mode, you can only view CA information. For additional information about Modify and View modes, see “[Identity pane buttons and icons](#)” on page 98.

1. In the Device Launcher pane, click an XP128, XP1024 or XP12000 link.
2. Click **CA**. The CA main pane appears.

**NOTE:** Partition-level users in the StorageAdmins group cannot perform CA operations. For more information about limitations, see “[Security system](#)” on page 57.

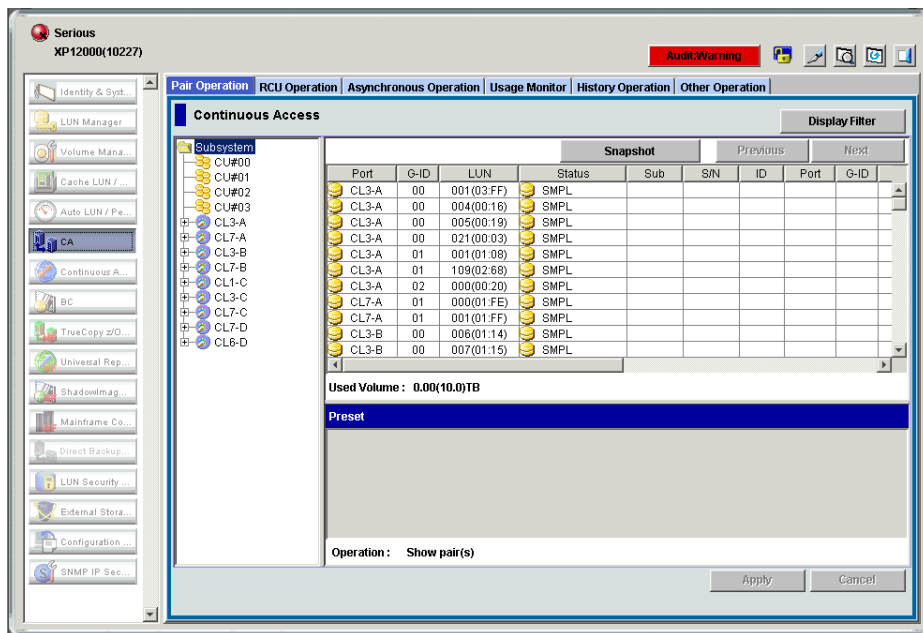

Figure 288 CA main pane

## CA panes

To access CA panes, click the following tabs: **Pair Operation**, **RCU Operation**, **Asynchronous Operation**, **Usage Monitor**, **History Operations**, or **Other Operation**.

**NOTE:** The **Other Operation** tab is visible only for XP12000.

The CA main pane (also known as the Pair Operation pane) is displayed by clicking the **Pair Operation** tab. This pane shows information for the selected CU image of the connected disk array and provides access to all CA functions.

Table 104 shows the CA functions of each tab. To apply settings on the CA function tabs, click **Apply**.

**Table 104** CA functions

Tab	Menu Command	Description
Pair Operation	Pairstatus	Displays CU information, path information, pair status, and settings information about CA pairs. Monitoring LDEV status is not supported.
	Paircreate > Synchronous	Sets new CA Synchronous pairs.
	Paircreate > Asynchronous	Sets new CA Asynchronous pairs.
	Pairsplit - S	Deletes CA pairs that are already set.
	Pairsplit - r	Splits or suspends CA pairs.
	Pairresync	Resumes CA pairs that are split or suspended. Resuming in LDEVs is not supported.
	Change Pair Option	Modifies pair options that were originally set (Fence level or Error level).
RCU Operation	RCU Status	Displays RCU status and CA port numbers that are already set.
	RCU Operation > Add RCU	Registers the RCU at the remote disk array. RCU controls the S-VOL of the CA volume pair.
	RCU Operation > Delete RCU	Deletes RCUs that are already registered.
	RCU Operation > Change RCU Option	Modifies options for RCUs that are already registered.
	Edit SSIS(s) & Path(s) > Add Path	Adds paths to RCUs.
	Edit SSIS(s) & Path(s) > Delete Path	Deletes paths to RCUs.
	Edit SSIS(s) & Path(s) > Add SSID	Adds SSIDs of RCUs that are connected to the MCU.
	Edit SSIS(s) & Path(s) > Delete SSID	Deletes SSIDs of RCUs that are already connected to the MCU.
	Port	Changes port types for the connected disk array.

**Table 104** CA functions (continued)

Tab	Menu Command	Description
Asynchronous Operation	CT Group Operation > CT Group Status	Displays information about consistency groups that are already registered.
	CT Group Operation > Add CT Group	Assigns CUs to consistency groups.
	CT Group Operation > CT Group Option	Modifies settings for consistency groups that are already assigned.
	CT Group Operation > Delete CT Group	Deletes consistency groups that are already assigned.
	Async Option	Sets and modifies asynchronous copy options.
Usage Monitor	--	Collects and displays I/O statistics using the Remote Copy Monitoring function.
History Operations	--	Displays operation history of CA volume pairs.
Other Operation		Changes option settings of the subsystem.



**NOTE:** The scripting function is not supported for this version.

## CA main pane (Pair Operation pane)

The first pane that appears after clicking the **CA** tab is the CA main pane, also known as the Pair Operation pane. To display this pane, click **Pair Operation** on other CA panes.

The CA main pane displays information about the selected CU image of the connected disk array. From this pane, you can configure volume pairs. This section describes components of the CA main pane. For information about CA volume pair configuration, see "[Performing CA pair operations](#)" on page 560.

Information displayed on the CA main pane is updated when the CA main pane is opened, the tab is switched from one to another, and **Refresh** (🔄) is clicked. The pair information is also updated by clicking **Apply**.

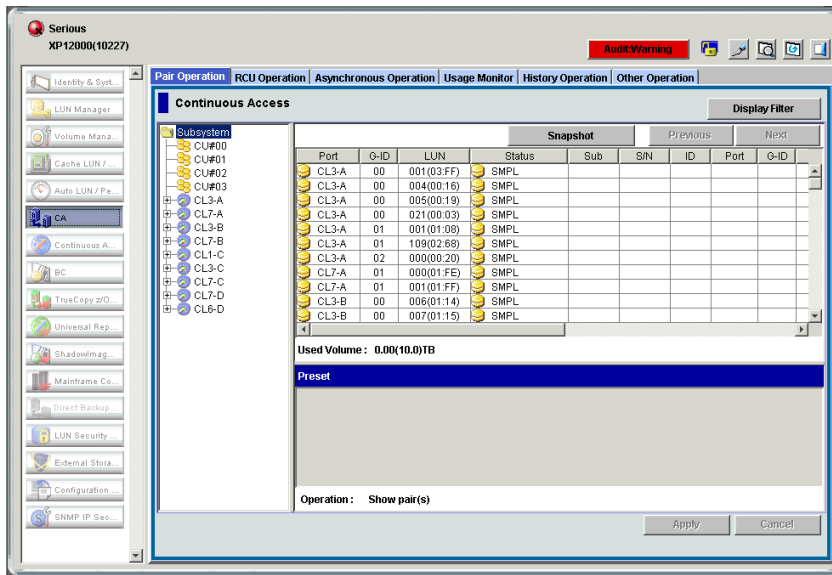

**Figure 289** CA main pane (Pair Operation pane)

The CA main pane contains the following items:

- **CU Number/Port Number tree:** Subsystem folder displays CUs, ports, and host groups. Only the CU/Port containing LUs is shown in the CU Number/Port Number tree. A CU number or port number can be selected in the CU Number/Port Number tree to specify information displayed in the Volume list. You cannot select more than one CU number or port number. When a CU includes a volume pair of error suspended status, an error icon (🚫) is shown on the CU number/port number.
- **Volume list:** Information for each volume (LU) of the connected disk array (see “Volume list” on page 518). Information displayed in this list is sorted in Port number order by default. Information about LUs defined for several paths is displayed in several rows (as many as the path defined).
- **Display Filter** button: Opens the Display Filter pane (see “Display Filter pane” on page 520), which you use to select volumes displayed on the Volume list. Select volumes by specifying pair status, pair type, and group number.
- **Snapshot** button: Writes the user-selected TrueCopy pair status information to a text file.
- **Previous** and **Next** buttons: In the Volume list, displays eight to twelve rows of LU information at one time. The 256 rows can be displayed using the scroll bar. The **Previous/Next** buttons switches the Volume list to the previous or next 256 rows.

## Volume list

This list displays information about each volume (LU) of the connected disk array. Information displayed in this list is sorted in Port number order by default. Each item can be sorted in ascending or descending order. To sort items, click the column heading (such as Status or Port). Not all items in the Volume list can be displayed at one time. To see all items in the list, use the scroll bar below the Volume list.



**NOTE:** To change the number of items that can be displayed without scrolling, change the font size.

Port	G-ID	LUN	Status	Sub	S/N	ID	Port	G-ID
CL3-A	00	001(03:FF)	SMPL					
CL3-A	00	004(00:16)	SMPL					
CL3-A	00	005(00:19)	SMPL					
CL3-A	00	021(00:03)	SMPL					
CL3-A	01	001(01:08)	SMPL					
CL3-A	01	109(02:68)	SMPL					
CL3-A	02	000(00:20)	SMPL					
CL7-A	01	000(01:FE)	SMPL					
CL7-A	01	001(01:FF)	SMPL					
CL3-B	00	006(01:14)	SMPL					
CL3-B	00	007(01:15)	SMPL					

**Figure 290** Volume list (partial view)

- **Volume icon:** Status of volumes. [Table 105](#) shows the icons.

**Table 105** Volume icons for CA operations

Icon	Explanation
	SMPL
	P-VOL
	S-VOL

- **Port, Group, and LUN:** Port number, LU Host Group number, and LU number (LUN).





**NOTE:** If # is added to the end of an LDEV number, such as 00:3C#, the LDEV is an external volume. For details about external volumes, see “[External storage for the XP12000](#)” on page 757.

- **Status:** See “[CA volume pair status](#)” on page 497 for further information about CA pair status. [Table 106](#) shows the icons.

**Table 106** Status icons for CA operations

Icon	Explanation
	SMPL. Volume is not currently assigned to a CA pair. When the paircreate operation starts the initial copy, the volume status changes to COPY.
	COPY. CA initial copy operation is in progress. Data on the pair is not fully identical. When the initial copy is complete, the status changes to PAIR.
	PAIR. Volume is currently assigned to a CA pair, and the pair is 100% synchronized. All updates from the host to the P-VOL are duplicated at the S-VOL.
	PSUE. Pair was suspended by the MCU or RCU due to an error condition. Volumes in this pair are not synchronized.
	PSUS. Pair was split by the user (pairsplit-r), or pair was deleted by the user from the RCU (pairsplit-S). Volumes in this pair are not synchronized.
	PDUB. CA LUSE pair is in the COPY or PAIR state, but at least one LDEV pair within the CA LUSE pair is in the SMPL or PSUE state.

**Table 106** Status icons for CA operations (continued)

Icon	Explanation
	Suspending. CA Asynchronous only. Pair is not synchronized, and is in transition from the PAIR or COPY state to the PSUS/PSUE state.
	Deleting. CA Asynchronous only. Pair is not synchronized, and is in transition from the PAIR, COPY, or PSUS/PSUE state to the SMPL state.

- **Sub:** Suspend Sub Status.
  - **Grp:** Sequence number of current volume is same as consistency group.
  - **LU:** Sequence number of current volume is not same as consistency group.
  - **OFF:** Suspended by the PS OFF by the MCU.
- **S/N** and **SSID:** Serial number and SSID of the other disk array (MCU or RCU) of the volume pair.
- **Port, Group,** and **LUN:** Port number, LU Host Group number, and LUN of the other volume of the volume pair. If the LU is set to more than one path, the LU specified at paircreate is displayed.
- **Type:** Pair mode: Synchronous or Asynchronous.
- **Fence:** P-VOL fence level of the CA volume pair: data, status, or never. See “[Considering the P-VOL fence-level setting](#)” on page 583 for a complete description of the CA P-VOL fence-level parameter.
- **Diff:** Information about differential data.
- **CTG:** Consistency group number of the pair (only for the Asynchronous pairs).
- **ErrLvl:** Error level of the pair (only for the Asynchronous pairs).
- **CLPR:** Number and name of the CLPR to which the volumes forming the pairs belong. For more information about CLPRs, see “[Disk/Cache Partition for the XP12000](#)” on page 143.



**NOTE:** The **S/N**, **SSID**, and **Fence** columns might be blank while the pair is in transition from a pair status to SMPL. To display the latest information in these columns, refresh the pane.



**NOTE:** The first LDEV number of the LU is not displayed.

## Display Filter pane

Click **Display Filter** to open the Display Filter pane, which you can use to select volumes to display on the Volume list. You can select Group number, Port number, CU number, Pair mode, Volume type, Consistency group number, Port type, and Pair status.

When you select the CU number or Port number on the CU Number/Port Number tree on the CA main pane, the selection in the CU Number/Port Number tree has precedence over the specification in the Display Filter pane. When you select the CU number or Group number in the tree, the specification on the

Display Filter pane for the CU number or Group number is not available. To make all settings on the Display Filter pane available, click **Subsystem** in the CU Number/Port Number tree.

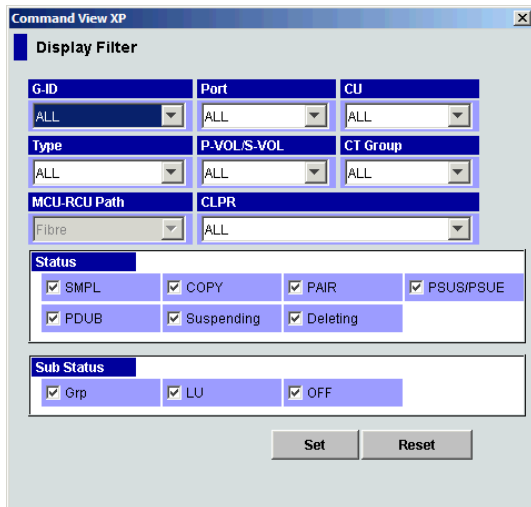

**Figure 291** Display Filter pane

The Display Filter pane contains the following drop-down lists:

- **G-ID**, **Port**, and **CU**: Number of group, port, and CU to be displayed.
- **Type**: Pair type: synchronous or asynchronous.
- **P-VOL/S-VOL**: Volume type: P-VOL or S-VOL.
- **CT Group**: Number of consistency group to be displayed. This is available only for Asynchronous pairs.
- **MCU-RCU Path**: Port type: fibre or serial.
- **CLPR**: Used to select the CLPR (or all CLPRs).

The Display Filter pane also contains the following items:

- **Status** area: Selecting check boxes in this area displays only volumes with the selected pair status: **SMPL**, **COPY**, **PAIR**, **PSUS/PSUE**, **PDUB** (LUSE only), **Suspending** (async only), and **Deleting** (async only). The **PDUB** check box displays only CA LUSE volumes with the **PDUB** status. When this check box is selected, simplex volumes are not displayed.
- **Sub Status** area: Used to select consistency status of Asynchronous pairs.
- **Set** button: Applies selections to the Volume list, and closes the Display Filter pane.
- **Reset** button: Clears selections, and displays default settings (**ALL**).

Settings on the Display Filter pane are available while using CA until you reset the settings.



**NOTE:** You cannot use other panes without closing the Display Filter pane.

## TrueCopy Snapshot function

This function writes user-selected TrueCopy pair status information to a text file on the array, which you can then download. Status information reported in this file is determined by selections on the Display Filter panel. Use this function to verify completion of TrueCopy operations.



**NOTE:** You can use the snapshot function only while client file access is enabled. When client file access is not enabled, the snapshot button is not displayed on the Pair Operations panel. [Table 107](#) describes the Snapshot function.

**Table 107** Snapshot functions

Item	Function
Data Format	Text file.
Target data	The TrueCopy pairs being reported are determined by selections on the Display Filter pane.
Initialization	Each time the Snapshot command is selected, previous status data is deleted and new data is written.



**NOTE:** If # is added to the end of an LDEV number, such as 00:3C#, the LDEV is an external volume. For details about external volumes, see "[External storage for the XP12000](#)" on page 757.

## Creating and exporting (downloading) TrueCopy snapshot files

1. After completing the desired TrueCopy operations, open the Display Filter pane, select desired options, and close the Display Filter pane.
2. Select **Snapshot** (to the left of **Prev** button). A confirmation message appears
3. Click **OK** to create a new snapshot file, or click **Cancel** to cancel your request to create a new snapshot file.
4. If you clicked **OK**, the TrueCopy snapshot file is created, and the panel for saving the snapshot file appears.
5. To save snapshot data, enter the name for the snapshot file, and click **OK**. A message appears stating that exporting the snapshot data is complete.
6. Click **OK** to close the message pane.

## RCU Operation pane

The RCU Operation pane displays RCU information and provides access to the CA RCU setting operations (see "[RCU operations](#)" on page 533).



The RCU Operation pane is updated when the tab is switched from one to another, **Refresh** is clicked, and settings for the RCU are applied. For the RCU settings operation, see “[RCU operations](#)” on page 533.

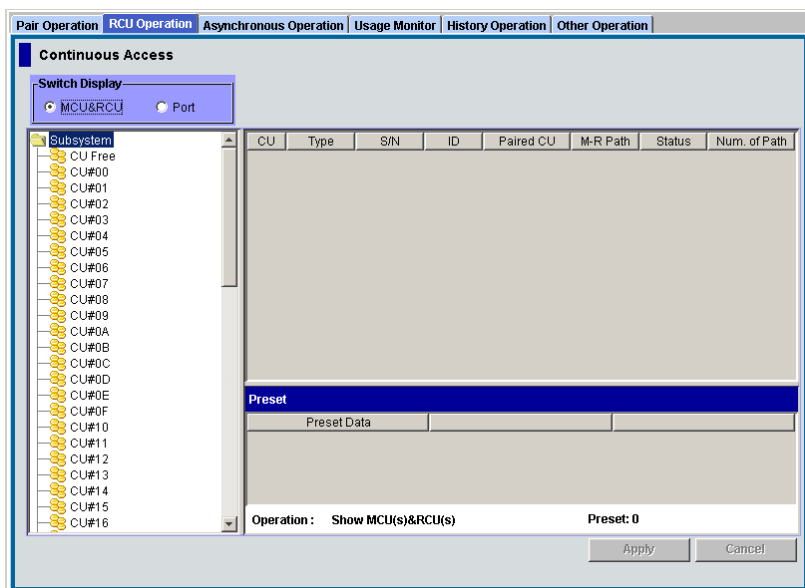

**Figure 292** RCU Operation pane

The RCU Operation pane contains the following items:

- **Switch Display** options:
  - **MCU&RCU**: Displays the CU Number tree and MCU/RCU list (see “[CU Number tree and MCU/RCU list](#)” on page 523). The MCU/RCU list is displayed by default.
  - **Port**: Displays the Package tree and Port list (see “[Port tree and Port list](#)” on page 525).
- **Operation**: Displays current operation performed by the RCU Operation pane.

## CU Number tree and MCU/RCU list

Click **MCU&RCU** in the Switch Display box to display the CU Number tree and MCU/RCU list. In the CU Number tree, only CU numbers, which include active MCUs or RCUs, are displayed. There is no branch under the CU Number tree. When the CU contains an RCU that has a failed path, the error icon (🔴) is shown for the CU number in the CU Number tree.

In the CU Number tree, select the CU number to display the specified information in the MCU/RCU list. You can select only one CU number on the CU Number tree.

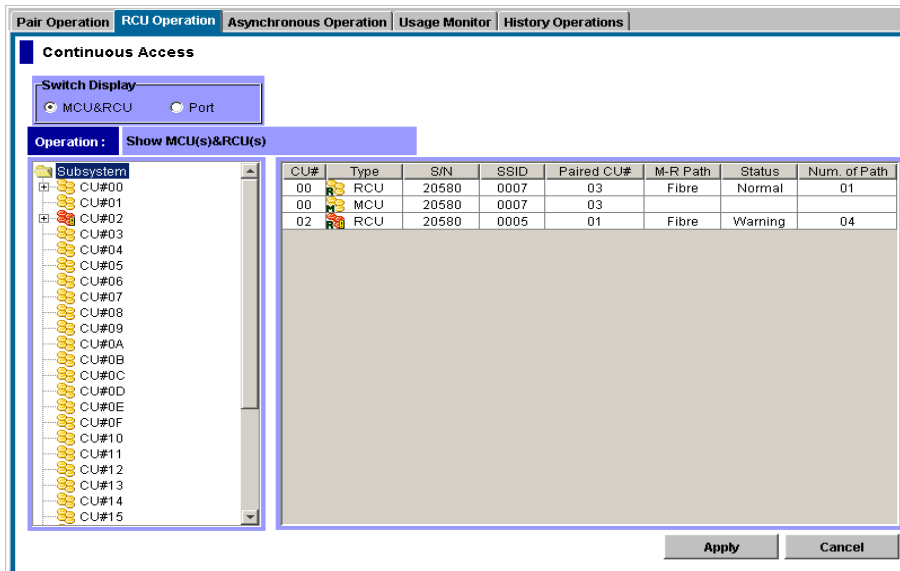
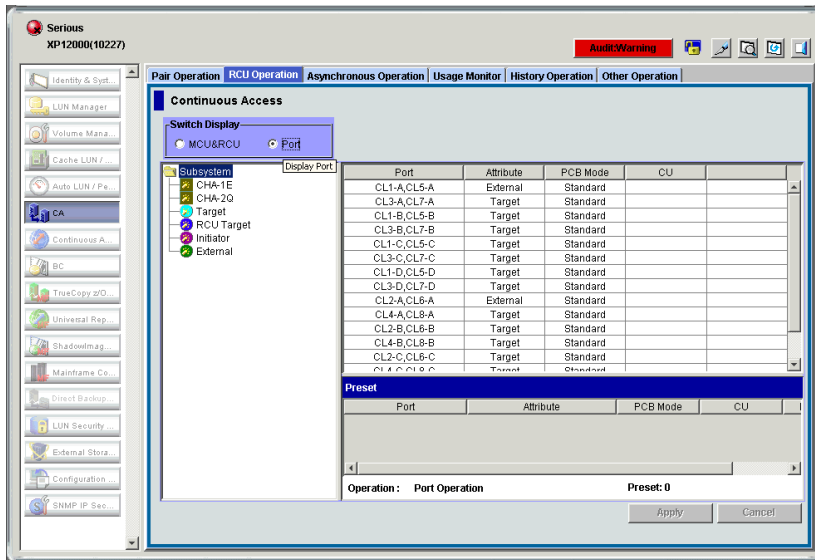

**Figure 293** RCU Operation pane with the MCU&RCU option button selected

- **CU#:** CU number selected on the tree.
- **Type:** MCU or RCU.
- **S/N** and **SSID:** Serial number and SSID of the other CU of the pair.
- **Paired CU#:** CU number of the other CU of the pair.
- **M-R Path:** Path channel type (fibre or serial) between the other CU of the pair.
- **Status:** **Normal** indicates no failure path between the RCU. **Failed** indicates there are failure paths between the RCU. This column is blank when the pair CU is MCU.
- **Num. of Path:** Number of paths. This column is blank when the pair CU is MCU.

## Port tree and Port list

Click **Port** in the Switch Display box to display the Port tree and Port list. The Port tree displays channel adapters and port types. Only ports that can be selected for remote copy operations are displayed.



**Figure 294** RCU Operation pane with the Port option button selected

- **Port:** Cluster and port number (1A-2R).

When the speed mode is standard, two port numbers are displayed in a row, and the speed mode can be modified on a two- port basis.

When the speed mode is high, the port number is displayed on a package basis, and the speed mode can be modified on a package basis.

- **Attribute:** Port type (Initiator, Target, RCU Target, External, RCP, or LCP).
- **PCB Mode:** Speed mode of the port (only for the fibre packages): standard, high-speed, or high-speed (2 port).
- **CU:** Range of CU images (00-0F or 10-1F), which is displayed only for serial ports.



**NOTE:** XP128/XP1024 only: High-speed (2 port) mode is available only if the XP disk array has firmware version 21.06.22 or later installed.

In the Port tree, port type can be selected to display specified information in the Port list. For example, when **Initiator** is selected in the Port tree, the system looks for ports of Initiator from all ports entered, and lists Initiator ports in the Port list. Only one port type can be selected in the tree.

## Asynchronous Operation pane

The Asynchronous Operation pane displays consistency group information for the connected disk array and provides access to the CA Asynchronous pair operation (see “CA Asynchronous operations” on page 547).

The Asynchronous Operation pane is updated when the tab is switched from one to another, **Refresh** is clicked, and settings are applied.

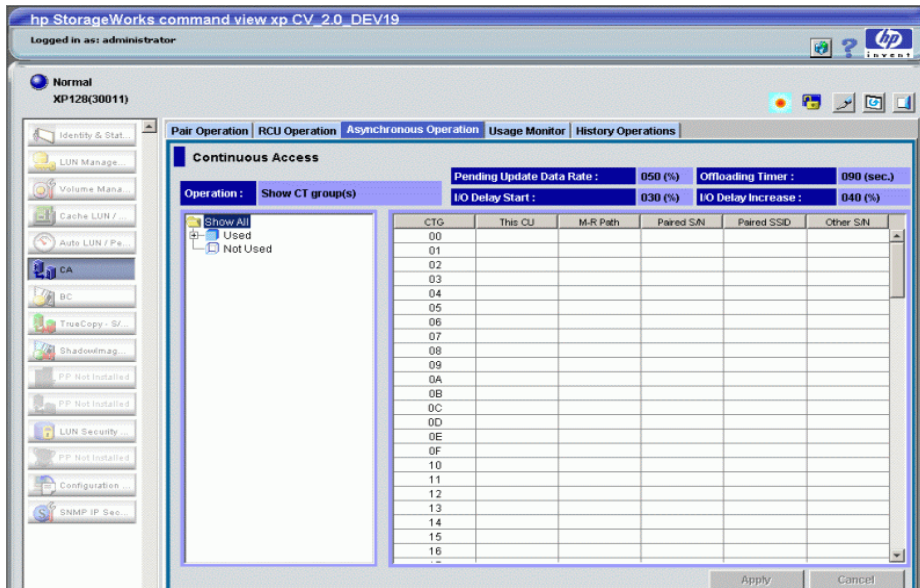

**Figure 295** Asynchronous Operation pane (XP128)

The Asynchronous Operation pane contains the following items:

- **Operation:** Current operation performed by the **Asynchronous Operation** tab.
- **Pending Update Data Rate:** Maximum cache % available for use by CA Async sidefiles.
- **Offloading Timer (sec):** Maximum time between CA Async recordset transfers. If the consistency group is not in use, this column is blank.
- **Inflow Control:** (XP12000) Indicates if inflow control is enabled. If the consistency group is not in use, this column is blank.
- **I/O Delay Start** (For XP128/XP1024, use firmware version 21.07.04 or later only): Threshold for starting the response delay to the host.
- **I/O Delay Increase** (For XP128/XP1024, use firmware version 21.07.04 or later only): Threshold for increasing the response delay to the host.
- **Consistency Group tree:** All consistency groups (default), only consistency groups already in use (Used), or consistency groups available for use (Not Used).
- **Consistency Group list:** Consists of the following items:
  - **CTG:** Consistency group number.
  - **This CU:** CU that initially registered the consistency group. When the consistency group is not registered, the column is blank. **MCU:** The local CU registered the consistency group. **RCU:** The consistency group is registered from the paired CU (the local CU is RCU). **M&R:** MCU and RCU are in the same disk array.
  - **M-R Path:** Fibre Channel or serial. When the consistency group is not registered, the column is blank.
  - **Paired S/N:** Serial number of the paired disk array (disk array with the lowest serial number). When the consistency group is not registered, the column is blank.
  - **Paired SSID:** SSID (Storage disk array ID) of the paired disk array (disk array with lowest SSID). When the consistency group is not registered, the column is blank.

- **Other S/N: Exist:** Indicates that there is an RCU other than the one with the lowest serial number. When there is no other RCU, the column is blank.
- **CLPR:** Number and name of the CLPR to which the volumes forming the pair belong. If the consistency group is not in use, this column is blank. For more information about CLPRs, see “Disk/Cache Partition for the XP12000” on page 143.

## Usage Monitor pane

The Usage Monitor pane displays user-selected remote copy I/O statistics and status of remote copy usage monitoring, and provides access to the CA usage monitor operations (see “Usage Monitor operations” on page 555).

The Usage Monitor pane is updated when the tab is switched from one to another, **Refresh** is clicked, and settings are applied.

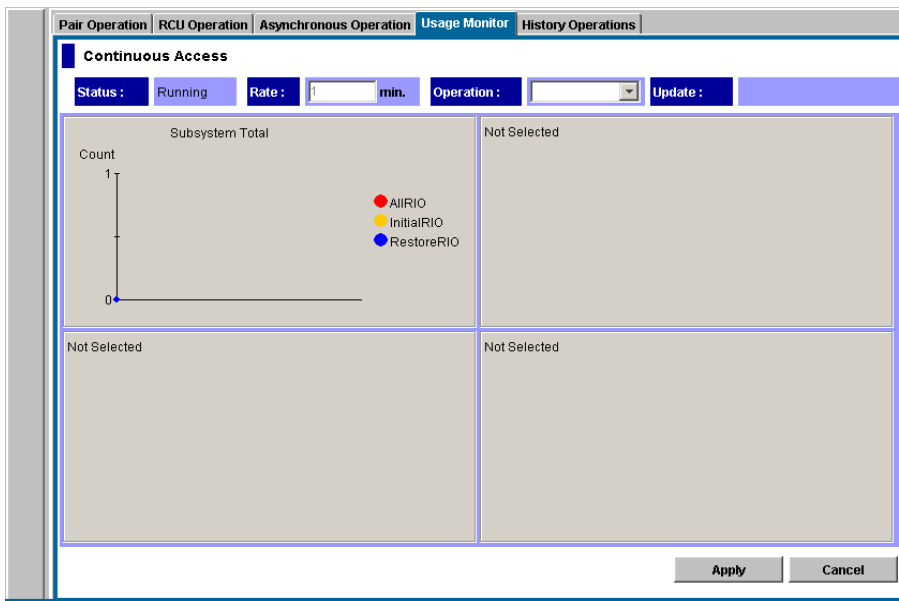

**Figure 296** Usage Monitor pane

The Usage Monitor pane contains the following items:

- **Status:** Displays **Running** when monitoring is on. Displays **Stop** when monitoring is off. When monitoring is stopped, the usage monitor graph is closed. The usage monitor graph can be displayed only when monitoring is running.
- **Rate:** Data collection rate for usage monitoring.
- **Operation:** Used to select a usage monitor operation.
- **Update:** Most recent data sample time of data on the graph.

## History Operations pane

The History Operations pane displays history information for CA pairs, including records of main status changes (such as pair creation, deletion, and so forth) of CA pairs.

The History Operations pane is updated when the tab is switched from one to another, **Refresh** is clicked, and settings are applied.

The screenshot shows a software interface with a tabbed menu at the top: Pair Operation, RCU Operation, Asynchronous Operation, Usage Monitor, and History Operations (selected). Below the tabs, the 'Continuous Access' section displays 'Status: Complete.' and 'Last Update: 2003/02/11 00:00:28'. The main area contains a table with the following columns: Operation Date/Time, Start Date/Time, Operation, VOL, Paired VOL, and Copy Time. The table lists 20 rows of 'Pair Resync' operations, alternating between 'Complete' and 'Start' statuses. At the bottom of the table are 'Previous' and 'Next' navigation buttons.

Operation Date/Time	Start Date/Time	Operation	VOL	Paired VOL	Copy Time
2003/02/06 16:57:51	2003/02/06 16:57:46	Pair Resync. Complete	02.B7	02.D1	000:00:05
2003/02/06 16:57:46		Pair Resync. Start	02.B7	02.D1	
2003/02/06 16:57:00	2003/02/06 16:56:52	Pair Resync. Complete	01.B9	01.D3	000:00:08
2003/02/06 16:56:52		Pair Resync. Start	01.B9	01.D3	
2003/02/06 16:56:52	2003/02/06 16:56:47	Pair Resync. Complete	01.B8	01.D2	000:00:05
2003/02/06 16:56:47		Pair Resync. Start	01.B8	01.D2	
2003/02/06 16:56:47	2003/02/06 16:56:43	Pair Resync. Complete	02.B9	02.D3	000:00:04
2003/02/06 16:56:43		Pair Resync. Start	02.B9	02.D3	
2003/02/06 16:56:43	2003/02/06 16:56:38	Pair Resync. Complete	02.B8	02.D2	000:00:05
2003/02/06 16:56:38		Pair Resync. Start	02.B8	02.D2	
2003/02/06 16:56:35	2003/02/06 16:56:22	Pair Resync. Complete	02.B5	02.CF	000:00:13
2003/02/06 16:56:31	2003/02/06 16:56:27	Pair Resync. Complete	02.B6	02.D0	000:00:04
2003/02/06 16:56:27		Pair Resync. Start	02.B6	02.D0	
2003/02/06 16:56:22		Pair Resync. Start	02.B5	02.CF	
2003/02/06 16:56:19	2003/02/06 16:56:15	Pair Resync. Complete	01.B7	01.D1	000:00:04
2003/02/06 16:56:15		Pair Resync. Start	01.B7	01.D1	
2003/02/06 16:56:15	2003/02/06 16:56:10	Pair Resync. Complete	01.B6	01.D0	000:00:05
2003/02/06 16:56:10		Pair Resync. Start	01.B6	01.D0	
2003/02/06 16:42:52	2003/02/06 16:42:48	Pair Resync. Complete	01.B5	01.CF	000:00:04
2003/02/06 16:42:48		Pair Resync. Start	01.B5	01.CF	
2003/02/06 16:29:42	2003/02/06 16:29:38	Pair Resync. Complete	02.0D	02.21	000:00:04

Figure 297 History Operations pane

The History Operations pane contains the following items:

- **Status:** Current status of history file. Possible values:
  - **No history file exist:** History file does not exist.
  - **Reading a history failed:** Failure occurred when referring to history file.
  - **Update history ... n (%):** History file update is in progress. "n (%)" indicates progress (in %) of updating process.
  - **Complete:** History file update is complete.

When the updating process is in progress, the checking process automatically continues until the updating process finishes. The updating process is checked at 10-second intervals.

- **Last Update:** Date and time history file was updated.
- **History List:** History information for CA pairs in the connected disk array. CA history information is saved for seven days, and maximum number of operations that can be saved is 65,535. By default, the list is in the order in which information is received from the disk array.

History information older than seven days is automatically deleted. However, if the number of operations exceeds 65,535, the oldest operations are deleted in chronological order to keep the number at 65,535, even if the operations occurred within the last week. The history file always contains the most recent operations up to a maximum of 65,535 operations. Maintenance information for an entire week might not always be available.

History information can be sorted by column in ascending or descending order.

The History List displays the following information:

- **Operation Date/Time:** Date and time operation was completed.
- **Start Date/Time:** Date and time operation was started.
- **Operation:** Operations are:
  - **Pairing Start:** Add pair operation was started.

- **Pairing Complete:** Add pair operation was completed.
- **Pair Delete:** Pair was deleted.
- **Suspend Operation:** Pair suspending operation was performed.
- **Pair Suspend (Failure):** Pair was suspended because of a failure.
- **Pair Resync. Start:** Resume pair operation was started.
- **Pair Resync. Complete:** Resume pair operation was completed.
- **VOL:** CU number and LDEV number of operated volume.
- **Paired VOL:** CU number and LDEV number of paired volume.
- **Copy Time:** Time taken for operation (from start of operation to end). Displayed only for **Pairing Complete** and **Pair Resync. Complete** operations.



**NOTE:** For CA pairs consisting of LUN Expansion (LUSE) volumes, number of **Pair Suspend (Failure)** rows in the history list does not correspond to number of LDEVs in the LUSE volume. For LUSE volumes with three or more LDEVs, only two rows showing **Pair Suspend (Failure)** are displayed.

- **Previous** and **Next** buttons: Displays up to a maximum of 16,384 operations at one time. Use these buttons to display the previous or next 16,384 operations.

Dates and times displayed on the History pane are the disk array's date and time, which may or may not correspond to the local time or host time.

## Other Operation pane

The Other Operation pane is used to change subsystem option settings. The **Other Operation** tab is visible only for XP 12000.

The Other Operation pane is updated when the tab is switched from one to another, **Refresh** is clicked, and settings are applied.

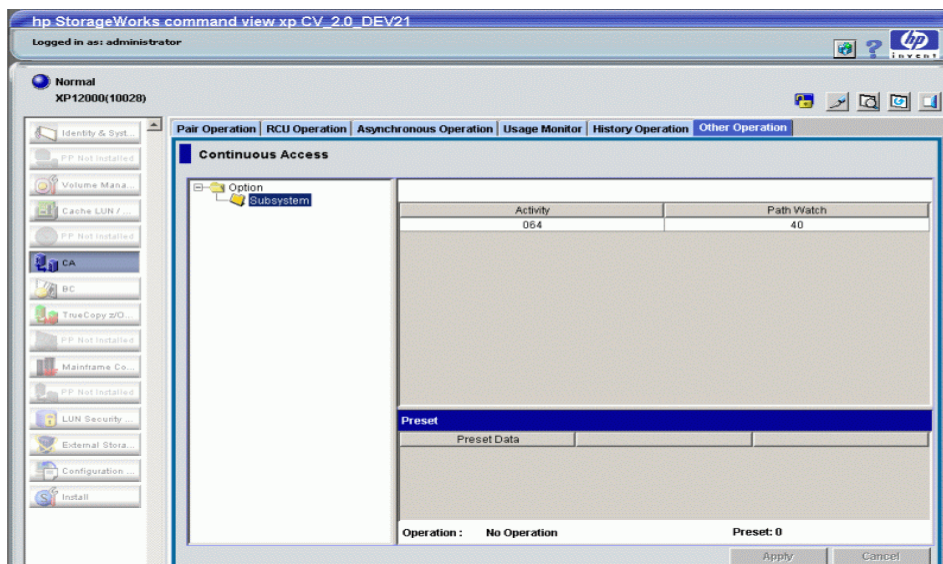

**Figure 298** Other Operation pane

The Other Operation pane contains the following items:

- **Tree:** Used to select the subsystem.



- **List:** Subsystem setting information.
- **Preset List:** Settings before you select **Apply** to change or delete settings. To change or delete settings, right-click the Preset List.
- **Operation:** Status of process in progress.
  - No Operation
  - Set the System Option
- **Apply** button: Applies settings to disk subsystems.
- **Reset** button: Clears specified settings.

## Changing subsystem settings

Use the **Other Operation** tab to change subsystem settings.

### Viewing subsystem settings

1. In the CA main pane, click **Other Operation**. The Other Operation pane displays the Tree.
2. Click a subsystem from the Tree. The Preset List displays subsystem settings.
  - **Activity:** Number of volumes in concurrent initial copy operations. It can be between 1 and 128.
  - **Path Watch:** Time interval to monitor blockade in paths on the MCU side. It can be between 0 and 45 seconds.

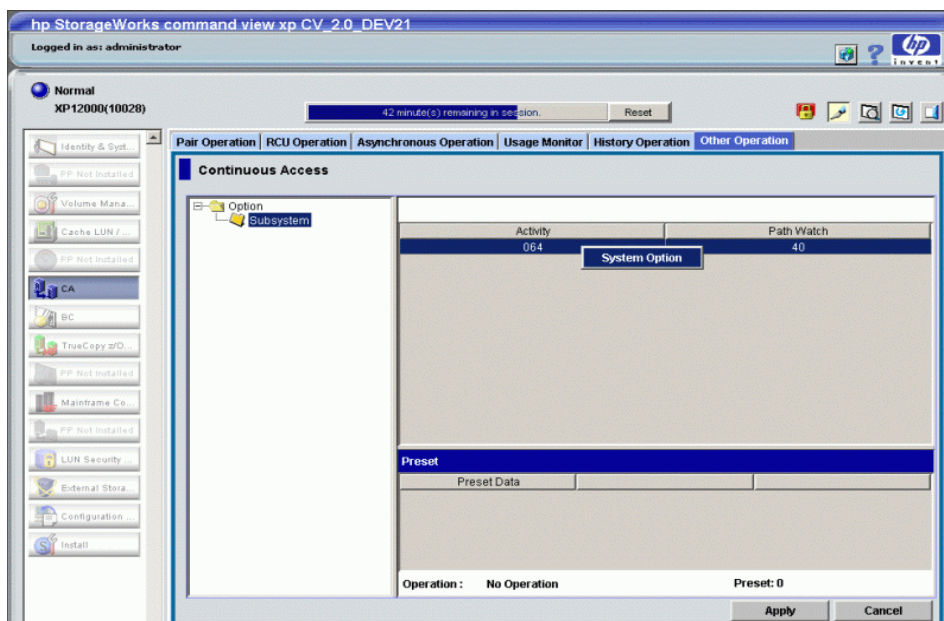
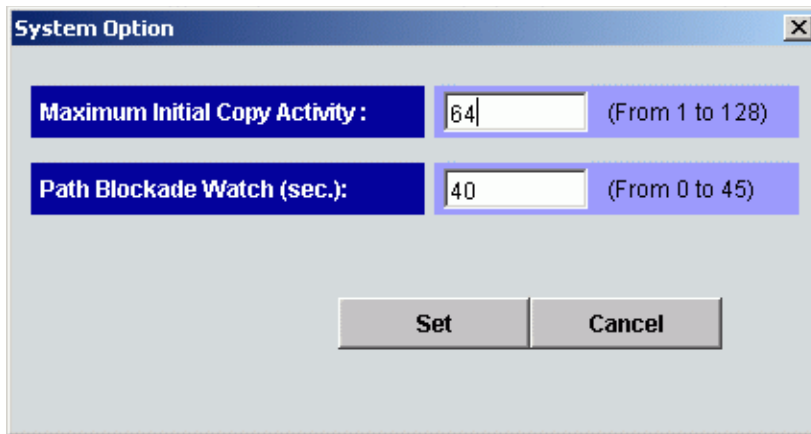

**Figure 299** Other Operation pane with subsystem settings

3. Right-click an item in the list, and select **System Option**. Current settings appear (see [Figure 300](#)).
  - **Maximum Initial Copy Activities:** Number of concurrent initial copy operations: 1 to 128 volumes. The default setting is 64 volumes. CA initial copy activities can impact performance of the main subsystem, depending on amount of I/O activity and number of pairs being registered at one time. The maximum initial copy activities setting of 64 volumes limits the impact of initial copy activities on subsystem performance. For example, if you set the maximum initial copy activities to 64 volumes and add 65 CA pairs at one time, the MCU starts the first 64 pairs, but does not start the 65th pair until one of the first four pairs is synchronized (Duplex status). When you change the maximum initial copy activities setting, the new setting applies to pairs created after the setting was changed, not to existing pairs.



- **Path Blockade Watch (sec.):** Time to monitor the blockade in paths on the MCU side. The path blockade watch value must be from 0 to 45 seconds. The default is 40 seconds.



**Figure 300** System Option pane

### Changing subsystem settings

1. In the CA main pane, click **Other Operation**. The Other Operation pane displays the Tree.
2. Click a subsystem from the Tree. The Preset List displays subsystem settings.
3. Right-click the list, and select **System Option**. Current settings appear.
4. Select **Set** to close the System Option panel. Changes appear in the Preset List.
5. Verify the change(s) in the Preset List.

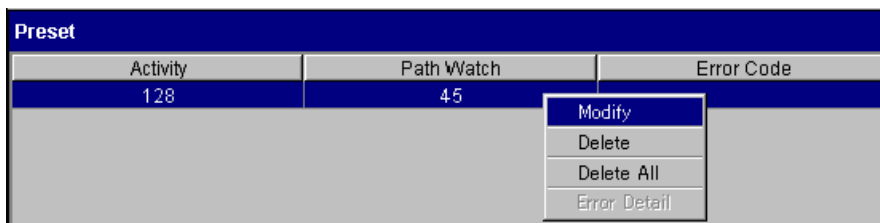

**Figure 301** Preset List pane

6. To change settings, right-click the Preset List, select **Modify**, make the changes, and close the panel. The Preset List displays updated information.
7. To omit settings, right-click the Preset List, and select **Delete**. Changes are cancelled.
8. To cancel changes, right-click the Preset List, and select **Delete All**.
9. To display error codes, right-click the Preset List, and select **Error Detail**. Error codes appear on the right of the Preset List.
10. To apply settings, select **Apply** (lower right of CA panel). To cancel the operation and return the list to its original display, select **Cancel**.

## Performing CA configuration operations

CA configuration operations include MCU operations, RCU operations, CA Asynchronous control operations, and discontinuing CA operations. The CA main pane (Figure 288) provides access to the following CA configuration operations:

- “MCU operations” on page 532 configure the MCUs for CA operations
  - “Configuring MCU ports” on page 532

- ["RCU operations"](#) on page 533 configure RCUs for CA operations
  - ["Viewing RCU Status \(RCU Status\)"](#) on page 534
  - ["Registering RCUs \(Add RCU\)"](#) on page 536
  - ["Modifying RCU options \(Change RCU Option\)"](#) on page 540
  - ["Adding and deleting logical paths for RCUs \(Add Path/Delete Path\)"](#) on page 543
  - ["Adding and deleting SSIDs for RCUs \(Add SSID/Delete SSID\)"](#) on page 544
  - ["Deleting RCUs \(Delete RCU\)"](#) on page 541
- ["CA Asynchronous operations"](#) on page 547 configure CA Asynchronous groups and options
  - ["Modifying parameters and deleting settings"](#) on page 547
  - ["Adding consistency groups \(Add CT Group\)"](#) on page 550
  - ["Modifying consistency group options \(CT Group Option\)"](#) on page 551
  - ["Viewing consistency group status \(CT Group Status\)"](#) on page 548
  - ["Deleting consistency groups \(Delete CT Group\)"](#) on page 552
- ["Usage Monitor operations"](#) on page 555 collect I/O statistics for LDEVs on a disk array
- History operations display CA history file
- ["Optimizing CA operations and disk array performance"](#) on page 558
- ["Discontinuing CA operations"](#) on page 560

The CA main pane provides access to all CA volume pair operations: creating pairs, splitting and resyncing pairs, and viewing pair status. ["Performing CA pair operations"](#) on page 560 provides instructions for performing the CA volume pair operations.

## MCU operations

MCUs are disk control units that control P-VOLs of CA volume pairs. Each disk array attached to the Command View management station on the internal LAN can function as an MCU. MCUs receive and process user-requested CA commands from the Command View management station, and send remote copy operations to RCUs. MCUs can also function as RCUs if remote copy connections are properly configured.

To set a disk array as an MCU, configure MCU ports.

### Configuring MCU ports

All Fibre Channel interface ports on the disk array have a default setting of Target port (CHF). Target mode is used for host processor channel interfaces. Fibre Channel ports used for CA communications to RCUs must be configured as Initiator ports. Fibre Channel interface ports in the RCU used to communicate with the MCU must be configured as RCU target ports. Initiator mode emulates a host channel, enabling the MCU to send write I/O operations directly to the RCU target port. Use CA to change the configuration of the ports as needed to accommodate host and CA communications paths. Two or more Initiator ports must be configured before you can register RCUs and create CA pairs. For further information, see ["Initiator ports and RCU target ports"](#) on page 490.

Use the Port tree and Port list on the RCU Operation pane to configure MCU ports. Clicking **Port** in the Switch Display box changes the tree to the Port tree and changes the list to the Port list.

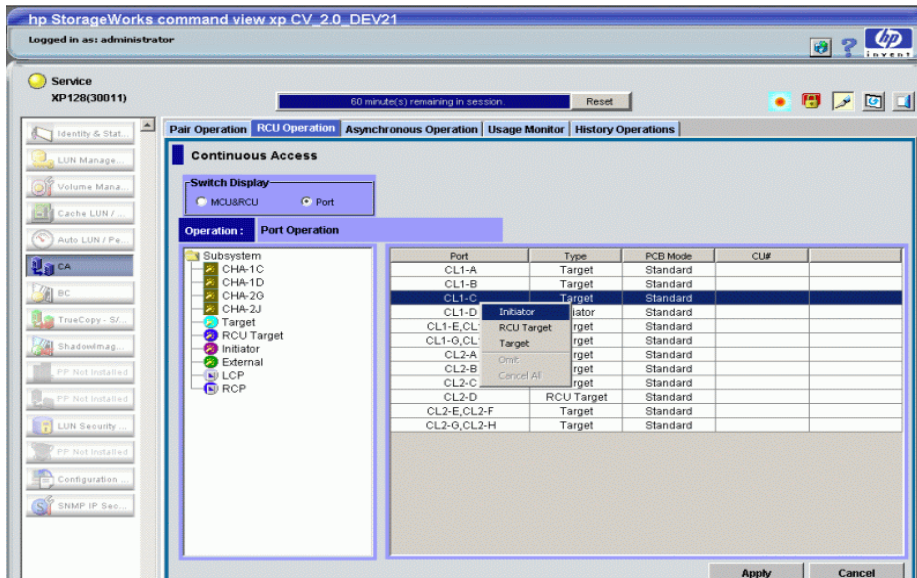

**Figure 302** Configuring MCU ports

1. In the CA main pane, click **RCU Operation**.
2. Click **Port** in the Switch Display box. The tree changes to the Port tree and the list changes to the Port list.
3. Click a package or port type from the Port tree. Only the selected package or port type appears in the Port list.
4. Click the ports of the CU you want to configure as MCU(s) from the Port list, right-click, and click **Initiator**.

For port change operations, there is no separate pane. The list keeps displaying the Port list. For more information about changing the port mode, see “[Port change operation](#)” on page 546.

## RCU operations

RCUs are control units that control S-VOLs of volume pairs. RCUs are connected to MCUs via remote copy connections, and receive and process commands from MCUs. For CA operations, the secondary Command View management station at the remote site should be connected to RCUs to allow CA commands to be issued directly to the RCU (for example, if a disaster or failure occurs at the primary site).

RCU operations are performed separately for each CU image of each MCU and RCU to provide maximum flexibility in CA configurations. The following are RCU operations:

- “[Viewing RCU Status \(RCU Status\)](#)” on page 534
- “[Registering RCUs \(Add RCU\)](#)” on page 536
- “[Registering RCUs \(Add RCU\)](#)” on page 536  
RCU options apply to all CU images of the MCU.
- “[Modifying RCU options \(Change RCU Option\)](#)” on page 540
- “[Deleting RCUs \(Delete RCU\)](#)” on page 541
- “[RCU path parameters](#)” on page 541
- “[Adding and deleting logical paths for RCUs \(Add Path/Delete Path\)](#)” on page 543

- ["Adding and deleting SSIDs for RCUs \(Add SSID/Delete SSID\)"](#) on page 544

Use the RCU Operation pane to perform RCU operations. All operations that can be performed from the RCU Operation pane have the following common procedure:

1. Click the CU number or Package number in the tree.
2. Click one or more RCUs or Packages in the list. For registering RCU operation, the RCU does not have to be selected. For this step, the list can be blank.
3. Right-click the list, and perform one of the following:
  - a. Click **MCU&RCU** in the Switch Display box to display the following commands:
    - **RCU Status**: Displays RCU status
    - **RCU Operation**: RCU settings operation
    - **Edit SSID(s)&Path(s)**: SSID and Path settings operation

When the list is blank, only the **RCU Operation** command can be activated.

- b. Click **Port** in the Switch Display box to display the following commands:
  - **Initiator**, **RCU Target**, and **Target** for fibre
  - **RCP** and **LCP** for serial (see ["Port change operation"](#) on page 546)
4. Click a command. When two or more RCUs are selected in [step 2](#), only the **RCU Operation** command can be selected.

There is no separate pane for the port change operation. Select the port type, and go to the Volume list (go to [step 6](#)).

5. Click **Set**. The pane closes, and the MCU/RCU list changes to the RCU Settings Parameter list. Only RCUs selected in [step 2](#) are listed, and items in the list depend on the selected command.



**NOTE:** After being set, options can be modified and canceled (see ["Modifying parameters and deleting settings"](#) on page 547).

---

6. Click **Apply** on the CA main pane. Settings are applied to the disk array.

The following sections describe each command and operation in detail.

## Viewing RCU Status (RCU Status)

Use the **RCU Status** command to display RCU status information.

1. In the RCU Operation pane, click **MCU&RCU** in the Switch Display box.
2. In the CU Number/Port tree, click a CU number that includes the RCU you want to display.
3. From the MCU/RCU list, select an RCU, and right-click.
4. Click **RCU Status**. The RCU Status pane appears.

If you select more than one RCU in [step 2](#), only the **RCU Operation** command can be selected. Select one RCU in [step 2](#) to display status information.

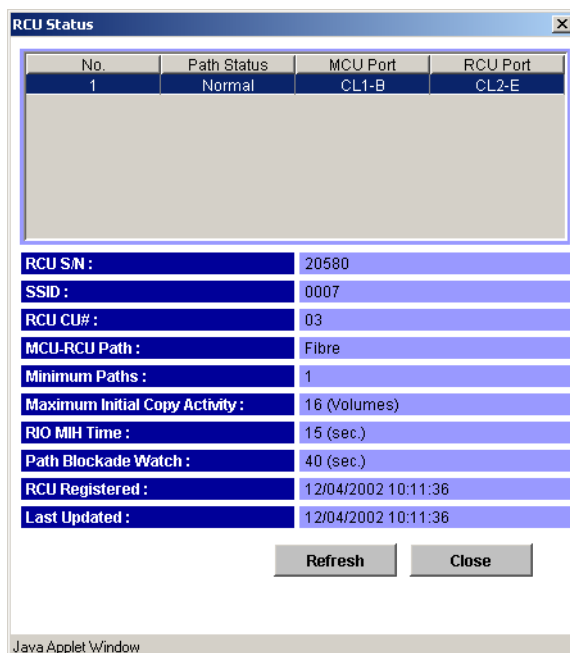

**Figure 303** RCU Status pane

- **Path list:**
  - **No.:** Path number (serial number of the list).
  - **Path Status:** Path status. **Normal** is displayed when path status is normal.
- **RCU S/N:** Serial number of RCU.
- **SSID:** SSID of RCU.
- **RCU CU#:** CU number of RCU.
- **MCU-RCU Path:** Channel type: fibre or serial.
- **Minimum Paths:** Minimum number of paths required for selected RCU connected to the MCU.
- **Maximum Initial Copy Activity:** Number of concurrent initial copy operations.
- **RIO MIH Time:** Time value for the remote I/O (RIO) missing interrupt handler (MIH), which is the wait time until data transfer from the MCU to RCU is complete.
- **Path Blockade Watch:** Time for monitoring blockade in the Fibre Channel paths on the MCU side.
- **RCU Registered:** Date and time the RCU was registered.
- **Last Updated:** Date and time the RCU was last updated.
- **Refresh** button: Refreshes information displayed on the pane.
- **Close** button: Closes the pane.

The **Path Status** field lists the path status. [Table 108](#) describes each status. For troubleshooting information about MCU-RCU paths, see “[CA Async Suspension Conditions](#)” on page 843.

**Table 108** Logical path status

Status Description	Condition
Normal	Logical path was successfully established and can be used for CA copy activities.
Initialization Failed	Link initialization procedure with the RCU failed because the physical path connection between the MCU and the RCU or the connection between the MCU and the host was missing.
Communication Timeout	Timeout error occurred between the MCU and RCU.
Resource Shortage	Establish logical path link function was rejected by the RCU. All logical path resources in the RCU might be used for other connections.
Serial Number Mismatch	Serial number of the control unit connected to this logical path does not match serial number specified by the Add RCU pane.
Invalid Port	Serial interface port specified is not in the RCP or Initiator mode.
RCU Port Number Mismatch	The following are possible factors: Specified port in the RCU is physically disconnected from the MCU. Port is not configured as an RCU target port. Specified port number is not available.
RCU Port Type Mismatch	Microprogram at the RCU side does not support the fibre remote copy function or specified port type is not RCU Target.
Communication Failed	Timeout error occurred on the path between the MCU and RCU.

## Registering RCUs (Add RCU)

You can register up to four RCUs to each MCU, and establish up to eight paths to each RCU. You must register each CU image as a separate RCU. Logical paths are established for CU images of the MCU and RCU separately. Maximum number of logical paths for each MCU is 32 (8 paths per RCU × 4 RCUs per MCU). Remote copy connections and MCU ports must be properly installed and configured before you can register an RCU. When registering an RCU, the current CU image of the MCU registers the specified CU image as a CA RCU and establishes the specified number of logical paths to the RCU. After registering an RCU (and path status is normal), create CA pairs with S-VOLs in the newly registered RCU.

Use the Add RCU pane to register RCU(s) to the current CU image of the connected MCU. When you select **Add RCU**, the Add RCU pane appears.



**NOTE:** If four RCUs (maximum number of RCUs you can register) are already registered, you cannot select **Add RCU**.

MCU Port	RCU Port

**Figure 304** Add RCU pane

- **RCU S/N:** Serial number of RCU being registered. S/N is five digits.
- **Controller ID:** Controller ID of RCU being registered.
- **Logical Atr. (RCU CU#):** CU number of RCU being registered. CU number is 0-1F.
- **Path Gr.ID:** Used to enter the path group ID for using CU Free. To enter the path group ID, clear the **Default** check box, and input the value in hexadecimal within the range of 1 to FF. To use the default ID, select the **Default** check box.
- **SSID:** SSID(s) of RCU being registered. The XP128/XP1024/XP12000 uses one SSID for each set of 256 volumes and four SSIDs per CU image. The SSID is 4-FFFE in hexadecimal.
- **MCU-RCU Path:** Includes:
  - **MCU Port:** MCU port number. Only Initiators are listed in the drop-down list. Select the MCU port from the list.
  - **RCU Port:** RCU port number. Select the RCU Target port.
  - **Link Address:** Link address from 0 - FD in hexadecimal numbers (serial only). For dynamic link of remote copy connections, enter destination port address on the ESCD. For static connections, enter 0.
- **Option** button: Opens the RCU Option pane.

- **Cancel** button: Cancels settings made on the Add RCU pane, and closes the pane.

**Figure 305** RCU Option pane

Use the RCU Option pane to set the options for the RCU.

- **Minimum Paths:** Minimum number of paths required for each RCU connected to the current MCU. The default is one. If you specify a number that is larger than the number of paths set on the Register RCU pane or the number of paths falls below this number (for example, failed path), an error occurs. When errors occur, the MCU suspends all affected CA (and any mainframe) pairs to prevent remote copy operations from adversely affecting performance due to the inadequate number of paths. If the MCU contains CA pairs, which contain critical data for disaster recovery, set minimum number of paths to one, so CA operations continue even if there is only one path to an RCU. If you need high performance at the MCU, set minimum number of paths to two or more (up to eight per CU image), depending on number of pairs managed by the MCU.



**CAUTION:** If CA volume pairs are suspended because number of paths dropped below this setting, the P-VOL fence-level pair option (see [“Creating CA volume pairs \(Paircreate\)”](#) on page 565) determines whether CA Synchronous P-VOLs are fenced (that is, all write operations are rejected).

- **Maximum Initial Copy Activity:** Number of concurrent initial copy operations: **4 Volumes** or **16 Volumes**. The default is **4 Volumes**. CA initial copy activities can impact performance of the main disk array, depending on amount of I/O activity and number of pairs registered at one time. The setting of **4 Volumes** limits impact of initial copy activities on disk array performance. For example, if you set maximum initial copy activity to **4 Volumes** and register five CA pairs at one time, the MCU starts the first four pairs and will not start the fifth pair until one of the first four pairs is synchronized (PAIR status). When you change the maximum initial copy activity setting, the new setting applies to pairs created after the setting was changed, not to existing pairs.
- **RIO MIH Time:** Time value for the remote I/O (RIO) missing interrupt handler (MIH), which is the wait time until data transfer from the MCU to RCU is complete. The RIO MIH time must be from 10 to 100 seconds. The default is 15 seconds. This setting is available for both serial and Fibre Channel interfaces.
- **Path Blockade Watch:** Time for monitoring blockade in Fibre Channel paths on the MCU side. The path blockade watch must be from 0 to 45 seconds. The default is 40 seconds. This setting is available for Fibre Channel interfaces only.
- **Cancel** button: Cancels the registering RCU operation.
- **Set** button: Sets the registering RCU operation with the option set on the RCU Option pane.



## Registering RCUs to the connected MCU

1. Ensure that remote copy connections and MCU ports are properly configured. Get the S/N of the RCU and the SSID(s) for the CU image in the RCU. The register RCU operation fails without this information. The disk array should have a label or tag indicating its S/N and SSIDs. The HP representative can also get the RCU S/N and SSIDs using the RCU's service processor (at the remote site).
2. In the RCU Operation pane, click **MCU&RCU** in the Switch Display box.
3. In the CU number/Port tree, click the correct CU image. For this step, the list can be blank. You must register and add RCUs to each CU image separately.
4. In the MCU/RCU list, right-click. For registering RCU operations, the RCU does not have to be selected on the list.
5. In the pop-up menu, click **RCU Operation**, and click **Add RCU**. The Add RCU pane appears.
6. Enter the RCU's S/N and the CU image's Controller ID, CU number, and SSID(s) or **Path Gr. ID**. Enter the value in hexadecimal within the range of 1 to FF for **Path Gr. ID** or use the default value. Up to 64 **Path Gr. IDs** can be registered per subsystem. The MCU verifies the S/N when paths are established, and verifies the SSIDs when volume pairs are created. If needed, add and delete SSIDs later using the Add SSID pane (see ["Adding and deleting SSIDs for RCUs \(Add SSID/Delete SSID\)"](#) on page 544).
7. Click the MCU and RCU ports from the drop-down lists. The MCU will not establish less than the minimum number of paths as specified on the RCU Option pane (see ["Modifying RCU options \(Change RCU Option\)"](#) on page 540). If needed, you can add and delete paths later by using the Add Path pane (see ["Adding and deleting logical paths for RCUs \(Add Path/Delete Path\)"](#) on page 543).
8. Click **Option** to open the RCU Option pane. Click **Cancel** to cancel settings made on the Add RCU pane.
9. From the RCU Option pane, enter or select the settings for **Minimum Paths**, **Maximum Initial Copy Activity**, and **RIO MIH Time**. For Fibre Channel interface, also specify the **Path Blockade Watch** setting.
10. In the RCU Option pane, click **Set** (even if you made no changes). Click **Cancel** to cancel the settings. The list changes to the RCU Settings Parameter list.
11. The new RCU is displayed in the RCU Settings Parameter list. To check the path status for this RCU, select the RCU, right-click, and click **RCU Status**. See ["Troubleshooting RCU path status problems"](#) on page 840 for detailed information about path status.



**NOTE:** After being set, options can be modified and canceled (see ["Modifying parameters and deleting settings"](#) on page 547).

When the pair option is set (the RCU Option pane is closed), the list changes to the RCU Settings Parameter list. [Figure 306](#) shows the items in the RCU Settings Parameter list.

S/N	SSID1	SSID2	SSID3	SSID4	M-R Path	Num. of Path
62492	0005				Fibre	01

MCU Port1	RCU Port1	MCU Port2	RCU Port2	MCU Port3	RCU Port3	MCU Port4	R
CL1-B	CL1-B						

MCU Port5	RCU Port5	MCU Port6	RCU Port6	MCU Port7	RCU Port7	MCU Port8	R

t7	RCU Port7	MCU Port8	RCU Port8	Min.Path	Activity	MIH Time	Path Watch
				01	04	015	40

**Figure 306** RCU Settings Parameter list

- **S/N:** RCU serial number
- **SSID 1 to SSID 4:** Selected SSID: SSID 1 to SSID 4
- **M-R Path:** Channel type
- **Num. of Path:** Number of the path(s) used
- **MCU Port 1 to MCU Port 8:** Port number on the MCU side: 1 to 8
- **RCU Port 1 to RCU Port 8:** Port number on the RCU side: 1 to 8
- **Min.Path:** Minimum number of paths required for each RCU connected to the current MCU
- **Activity:** Number of concurrent initial copy operations
- **MIH Time:** Time value for the remote I/O (RIO) missing interrupt handler (MIH)
- **Path Watch:** Time for monitoring blockade in the Fibre Channel paths on the MCU side

## Modifying RCU options (Change RCU Option)

Use the RCU Options pane to modify RCU options set when you registered the RCU. When the RCU Option pane is opened with the **Change RCU Option** command, all fields are blank. You must fill in the fields you need to modify; it is not necessary to fill in all fields. Fields left blank keep settings made for the registering RCU operation.

RCU options apply to all CU images of the current MCU and all RCUs connected to the MCU.

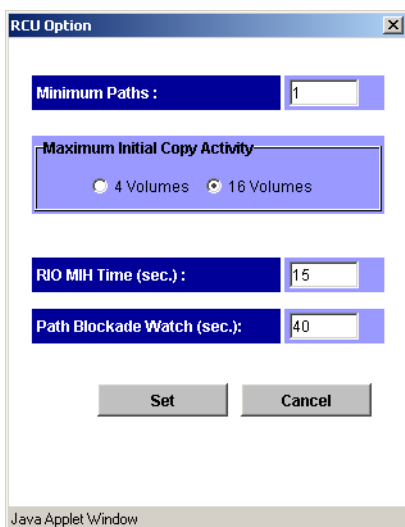

**Figure 307** RCU Option pane

For further information about the RCU Option pane, see “[Registering RCUs \(Add RCU\)](#)” on page 536.

1. In the CU number/Port tree on the RCU Operation pane, ensure that the correct CU image is selected.
2. From the MCU/RCU list, click the RCU you want to modify.
3. Right-click, click **RCU Operation**, and click **Change RCU Option**. The RCU Option pane appears.
4. Modify RCU options. When the RCU Option pane is open, all fields are blank. Fill in the fields you want to modify.
5. Click **Set** to set the modifications. The list changes to the RCU Settings Parameter list (RCU Option) view. Click **Cancel** to cancel all modifications you made.



**NOTE:** After being set, options can be modified and canceled (see “[Modifying parameters and deleting settings](#)” on page 547).

6. Click **Apply** on the CA main pane to apply the modification to the disk array.

When modifications are set (the RCU Option pane closes), the **MCU/RCU** list changes to the RCU Settings Parameter list (RCU Option). [Figure 308](#) shows the items on the RCU Settings Parameter list (RCU Option).

S/N	SSID	M-R Path	Min.Path	Activity	MIH Time	Path Watch
62492	0005	Fibre	01	16	015	40

**Figure 308** RCU Settings Parameter list (RCU Option)

- **S/N** and **SSID**: RCU serial number and SSID
- **M-R Path**: Channel type
- **Min.Path**: Minimum number of paths required for each RCU connected to the current MCU
- **Activity**: Number of concurrent initial copy operations
- **MIH Time**: Time value for the remote I/O (RIO) missing interrupt handler (MIH)
- **Path Watch**: Time for monitoring blockade in the Fibre Channel paths on the MCU side

## Deleting RCUs (Delete RCU)

You can delete an RCU from an MCU only after all CA volume pairs between the MCU CU image and RCU CU image are deleted. When you delete an RCU from an MCU, the MCU deletes all logical paths from the current MCU CU image to the selected RCU CU image. Deleting an RCU does not affect CA operations between other MCU CU images and that RCU. After an RCU is deleted, reconfigure remote copy connections to add another RCU to the MCU, or remove remote copy connections and reconfigure MCU ports (initiator ports to ordinary target ports for fibre, RCPs to LCPs for serial) to provide additional host channels for the MCU.

Use the **Delete RCU** command to delete selected RCU from the current MCU CU image. If all affected pairs are not deleted, the MCU rejects the delete RCU operation to prevent accidental deletion of CA pairs.

1. Connect to the MCU.
2. Ensure that all affected CA volume pairs are deleted. Volume pairs, which consist of a P-VOL in the connected MCU and CU image and an S-VOL in the selected RCU, must be deleted.
3. From the CU number/Port tree on the RCU Operation pane, ensure that the correct CU image is selected.
4. From the **MCU/RCU** list, click the RCU to be deleted.
5. Right-click, click **RCU Operation**, and click **Delete RCU**.
6. Click **Apply** on the CA main pane to apply the deletion to the disk array.

## RCU path parameters

For the Fibre Channel interface, two types of CHF P/K (Fibre Channel packages) are provided: 4-port and 2-port packages. The port mode depends on the package type. Also, each port might have a different PCB mode setting (standard or high-speed). Therefore, when you configure paths among initiator ports, target ports, and RCU target ports, study the port modes and specify the correct mode for

each port. [Figure 309](#) and [Figure 310](#) show Fibre Channel interface connections going through switches and the CA pane used for this configuration.

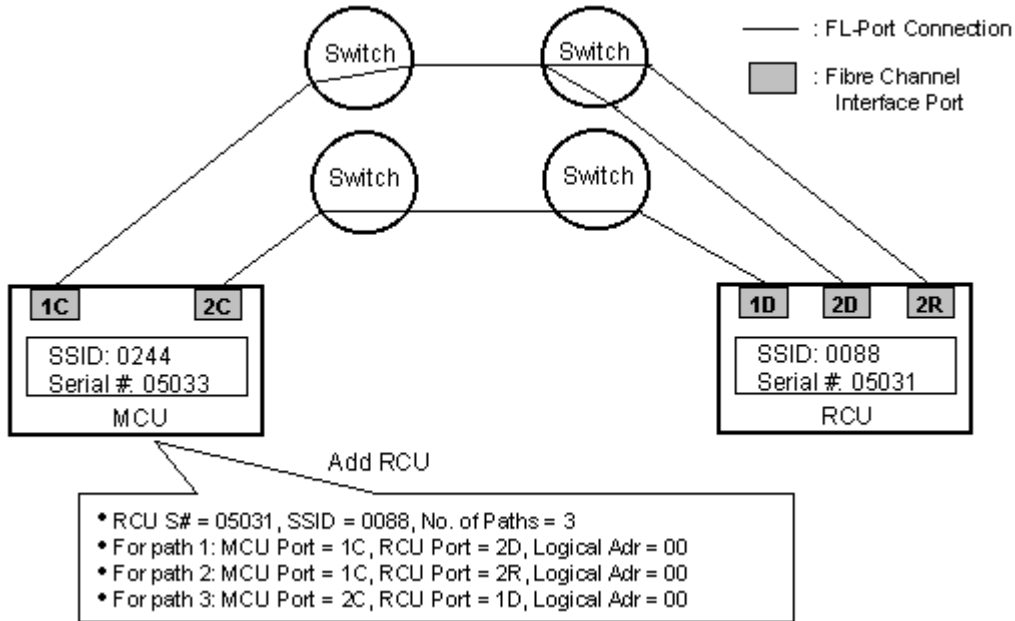

**Figure 309** Fibre Channel interface connections going through switches

**Add RCU**

RCU S/N: 05031  
 Controller ID: 3  
 Logical Adr.(RCU CU#): 00  
 SSID: 0088

MCU-RCU Path	
MCU Port	RCU Port
CL1-C	CL2-D
CL1-C	CL2-R
CL2-C	CL1-D

Option Cancel

Java Applet Window

**Figure 310** Add RCU pane used for configuration in [Figure 309](#)

## Adding and deleting logical paths for RCUs (Add Path/Delete Path)

Use the **Add Path** and **Delete Path** commands to add and delete paths for an RCU. When the **Add Path** command is selected, the Add Path pane appears.

MCU Port	RCU Port
CL1-B	CL2-E

Set Cancel

Java Applet Window

**Figure 311** Add Path pane

The **MCU-RCU Path** field includes:

- **MCU Port:** MCU port number. The Initiator and RCP are listed in the drop-down list and can be selected.
- **RCU Port:** RCU port number. The RCU Target port must be specified.
- **Link Address:** Link address (serial only). Destination port address on the ESCD (00-FD, 00 for static link to RCU).

The **Cancel** button cancels settings made. The **Set** button applies settings made and changes the list.



**NOTE:** Maximum number of paths is eight. Each item has seven fields to enter paths, but you cannot enter more than eight paths.

See [Table 108](#) for further information about path status.

### Adding new logical paths from the connected MCU to an existing RCU:

Before adding a path to an RCU, ensure that the remote copy connection is properly installed, appropriate MCU ports are configured as Initiator ports (fibre) or RCPs (serial), and appropriate MCU CU image is selected. You can add up to four RCUs to each MCU CU image and establish up to eight paths to each RCU. When you add a path to an RCU, CA automatically starts using the new path to perform CA copy activities.

1. From the CU Number/Port tree on the RCU Operation pane, ensure that the correct CU image is selected.
2. From the MCU/RCU list, click the RCU.
3. Right-click, and click **Edit SSID(s)&Path(s)**.
4. Right-click, and click **Add Path**. The Add Path pane appears.
5. Enter new path(s). Each item has seven fields to enter, but you can only enter the number of paths left (maximum number of paths is eight).

6. Click **Set** to set the paths. The list changes to the Path Settings Parameter list.



**NOTE:** After being set, options can be modified and canceled (see “[Modifying parameters and deleting settings](#)” on page 547).

7. Click **Apply** on the CA main pane to apply the settings to the disk array. The MCU automatically begins using the new logical path for CA activities.

### Deleting paths from the connected MCU to an existing RCU:

Before deleting a path to an RCU, ensure that remaining number of paths is equal to or greater than minimum number of paths setting (selected on the RCU Option pane). The delete path operation fails if number of remaining paths is less than minimum number of paths.

1. Open the RCU Option pane, and check the minimum number of paths setting. If the remaining number of paths is less than this value, the delete path operation will fail. If needed, change the minimum number of paths so you can delete the path.
2. From the CU Number/Port tree on the RCU Operation pane, ensure that the correct CU image is selected.
3. From the MCU/RCU list, click the RCU from which you want to delete the path.
4. Right-click, and click **Edit SSID(s)&Path(s)**.
5. Right-click, and click **Delete Path**. The list changes to the Path Settings Parameter list. Only selected RCUs are listed.



**NOTE:** After being set, options can be modified and canceled (see “[Modifying parameters and deleting settings](#)” on page 547).

6. Click **Apply** on the CA main pane to apply the deletion to the disk array.

## Adding and deleting SSIDs for RCUs (Add SSID/Delete SSID)

Before adding an SSID, ensure that the remote copy connection is properly installed. You can add three SSIDs to each RCU. Before deleting an SSID, ensure that the remaining SSIDs are valid, or the connection between the MCU and RCU may be lost.

Use the **Add SSID** and **Delete SSID** commands to add and delete SSIDs for an existing RCU. When the **Add SSID** command is selected, the Add SSID pane appears.

**Figure 312** Add SSID pane

The Add SSID pane displays three **SSID** fields. You can enter up to three SSIDs at one time with the Add SSID pane. You can add up to four SSIDs (maximum number of SSIDs).

The **Cancel** button cancels settings you made. The **Set** button applies settings you made, and changes the list.

1. From the CU Number/Port tree on the RCU Operation pane, ensure that the correct CU image is selected.
2. From the MCU/RCU list, click the RCU.
3. To add SSIDs:
  - a. Right-click, and click **Edit SSID(s)&Path(s)**.
  - b. Right-click, and click **Add SSID**. The Add SSID pane appears.
  - c. Enter new SSID(s) in the **SSID** fields. You can add up to four SSIDs to the RCU.
  - d. Click **Set** to add the SSIDs. The list changes to the SSID Settings Parameter list. The added SSIDs are listed.



**NOTE:** After being set, options can be modified and canceled (see “[Modifying parameters and deleting settings](#)” on page 547).

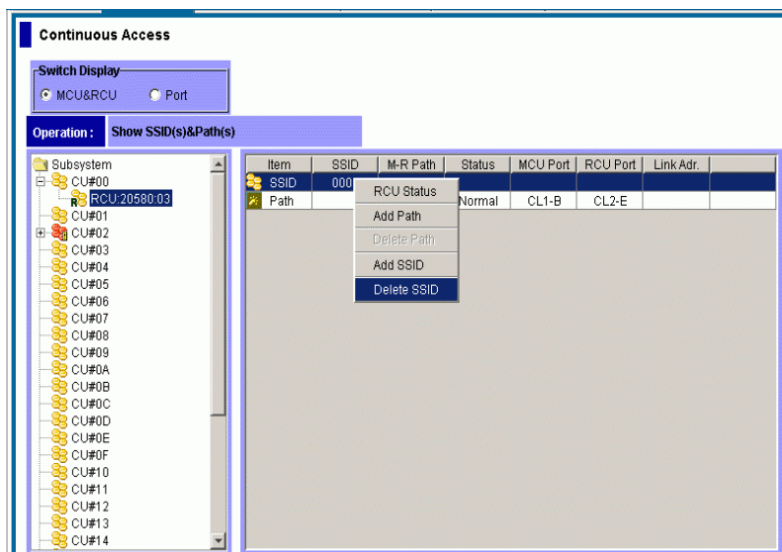

**Figure 313** Adding/deleting SSIDs for existing RCUs

4. To delete SSIDs:
  - a. Right-click, and click **Edit SSID(s)&Path(s)**.
  - b. Right-click, and click **Delete SSID** (see [Figure 313](#)). The list changes to the SSID Settings Parameter list. Only RCUs to be deleted are listed.



**NOTE:** After being set, options can be modified and canceled (see “[Modifying parameters and deleting settings](#)” on page 547).

5. Click **Apply** on the CA main pane to apply settings to the disk array.

## Port change operation

Use the **RCU Operation** tab to change the port mode. Clicking **Port** in the Switch Display box changes the tree to the Port tree and changes the list to the Port list. Use the Port tree and Port list to change the port type.

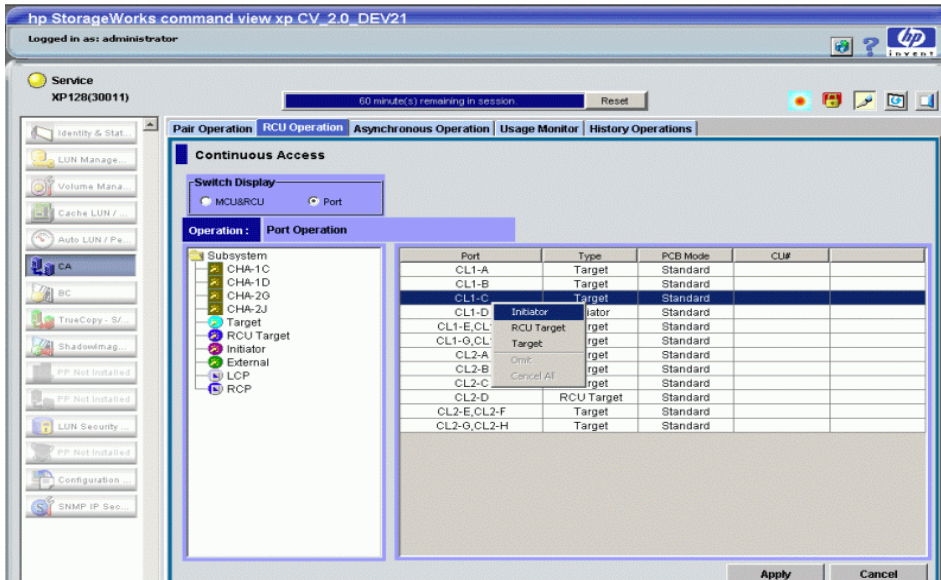

Figure 314 Changing port types

1. Click **Port** in the Switch Display box to change the tree to the Port tree and change the list to the Port list.
2. Click a port or a port type from the Port tree. Only the selected port or port type is displayed in the Port list.
3. Click the port(s) in the Port list.
4. Right-click, and select a port type.

For the port change operation, there is no separate pane. The list keeps displaying the Port list.



### NOTE:

- Before changing the operation type of a Fibre Channel port from **Target** or **RCU Target** to **Initiator**, disconnect the port from the host, delete all affected CA pairs, delete all paths from the port (if RCU target) to the MCU, and remove all channel paths to the port.
- Before changing the operation type of a Fibre Channel port from **Initiator** to **Target** or **RCU Target**, delete all affected CA pairs, delete all paths to the RCU from the initiator port, and delete the RCU from the MCU.
- Before changing the operation mode of a serial port from **LCP** to **RCP**, remove all channel paths to the specified port.
- Before changing the port mode from **RCP** to **LCP**, delete all affected CA pairs, delete all paths to the RCU from that RCP, and delete the RCU from the MCU.

Limit the number of hosts connected to an RCU target port to 128 or fewer. If more than 128 hosts are connected to an ordinary target, some hosts might be disconnected after changing the type from **Target** to **RCU Target**. For performance reasons, avoid using the same FC card for CA and host connect.



## Modifying parameters and deleting settings

After RCU, Path, and SSID operations, parameters can be modified individually. Also the RCUs, Paths, and/or SSIDs set by each operation can be deleted.

### Modifying parameters

1. Click the RCU, Path, or SSID on the list.
2. Right-click, and click **Modify**. A pane for each operation appears.
3. Modify parameters, and click **Set**.
4. Click **Apply** on the CA main pane to apply modifications.



**NOTE:** After the delete operation of the RCU, Path, and SSID operation, the **Modify** command is not available.

### Deleting RCUs, Paths, or SSIDs

1. Click the RCUs, Paths, or SSIDs on the list.
2. Right-click, and click **Omit**. Selected RCUs, Paths, or SSIDs are deleted from the list, and deleted RCUs, Paths, or SSIDs are out of the operations.
3. Click **Apply** on CA main pane to apply the deletions.

The **Cancel All** command deletes all RCUs, Paths, or SSIDs on the list, and all RCUs, Paths, or SSIDs removed from operations. All RCUs, Paths, or SSIDs can also be deleted using the **Omit** command and selecting all the RCUs, Paths, or SSIDs on the list. When all RCUs, Paths, or SSIDs are deleted (by the **Cancel All** or **Omit** command), the list status becomes the Volume list.

## CA Asynchronous operations

CA Asynchronous operations include:

- ["Viewing consistency group status \(CT Group Status\)"](#) on page 548
- ["Adding consistency groups \(Add CT Group\)"](#) on page 550
- ["Modifying consistency group options \(CT Group Option\)"](#) on page 551
- ["Deleting consistency groups \(Delete CT Group\)"](#) on page 552
- ["Asynchronous copy option"](#) on page 553

Use the Asynchronous Operation pane to perform asynchronous operations. For more information, see ["Asynchronous Operation pane"](#) on page 525. All operations that can be performed from the Asynchronous Operation pane have the following common procedure:

1. Click a consistency group mode (**Show ALL**, **Used**, or **Not Used**) to be operated in the Consistency Group tree.
2. Click one or more consistency group to be operated in the Consistency Group list.
3. Right-click. The pop-up menu consists of:
  - **CT Group Operation:** Performs the following consistency group operations:
    - **CT Group Status** (see ["Viewing consistency group status \(CT Group Status\)"](#) on page 548)
    - **Add CT Group** (see ["Adding consistency groups \(Add CT Group\)"](#) on page 550)
    - **CT Group Option** (see ["Modifying consistency group options \(CT Group Option\)"](#) on page 551)

- **Delete CT Group** (see “[Deleting consistency groups \(Delete CT Group\)](#)” on page 552)
- **Async Option**: Sets parameters for the asynchronous copy operation (see “[Asynchronous copy option](#)” on page 553).

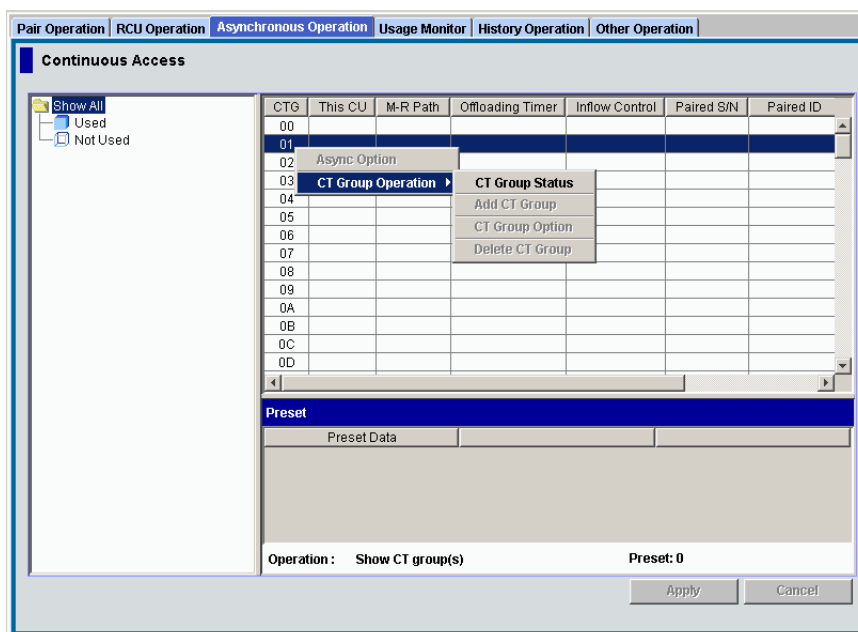

**Figure 315** Performing asynchronous operations

4. Click a command, and use the pane to make your settings.
5. Click **Set**. The Consistency Group list changes to the Consistency Group Settings Parameter list or Asynchronous Options Settings Parameter list. Only consistency groups selected in [step 2](#) are listed, and items in the list depend on the selected command.



**NOTE:** After being set, options can be modified and canceled (see “[Modifying parameters and deleting consistency groups](#)” on page 554).

6. Click **Apply** on the CA main pane to apply settings to the disk array.

## Viewing consistency group status (CT Group Status)

Use the **CT Group Status** command to display consistency group status information.

1. From the Consistency Group tree, click a consistency group mode that includes the consistency group you want to display.
2. From the Consistency Group list, click only one consistency group.

3. Right-click, click **CT Group Operation**, and click **CT Group Status**. The CT Group Status pane appears.

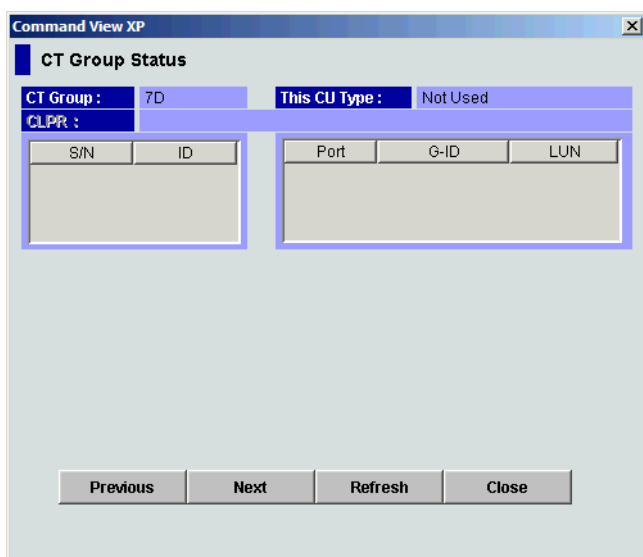

**Figure 316** CT Group Status pane

- **CT Group:** Consistency group number of selected consistency group in the list.
- **This CU Type:** Registering side (MCU or RCU) of consistency group.
- **CLPR:** Number and name of the CLPR to which the volumes forming the pair belong.
- **S/N, ID:** Serial number and SSID of CUs that are components of selected consistency group.
- **Port, G-ID, and LUN:** Pairs in the connected CU that are in selected consistency group. The Group column shows the host group name in parentheses. The LUN column shows the CU:LDEV in parentheses. For LUs with more than one path, only the first path is listed.



**NOTE:** If # is added to the end of the LDEV number, such as 00:3C#, the LDEV is an external volume. For details about external volumes, see "[External storage for the XP12000](#)" on page 757.

- **MCU-RCU Path:** Channel type: fibre or serial.
- **Time Out (Copy Pending):** Maximum delay allowed for CA Async copy (see "[Adding consistency groups \(Add CT Group\)](#)" on page 550).
- **Time Out (RCU Ready):** Maximum delay allowed for re-establishing MCU-RCU communications following MCU power-off (see "[Adding consistency groups \(Add CT Group\)](#)" on page 550).
- **Previous** button: Displays information about the consistency group before the current consistency group.
- **Next** button: Displays information about the consistency group after the current consistency group.
- **Refresh** button: Refreshes displayed information.
- **Close** button: Closes the CT Group Status pane.

## Adding consistency groups (Add CT Group)

Use the **Add CT Group** command to add a consistency group to the connected MCU. When the **Add CT Group** command is selected, the Add CT Group pane appears. Use the Add CT Group pane to select group options for the group.

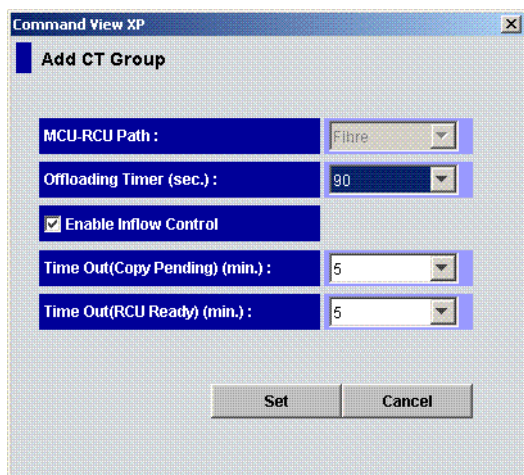

**Figure 317** Add CT Group pane

- **MCU-RCU Path:** Path type for remote copy connections.
- **Time Out (Copy Pending) (min.):** Maximum delay allowed for CA Async copy (none or from 1 to 15 minutes; none = no timeout for CA Async copy pending). The default is five minutes. If the delay between the CA Async P-VOL update and corresponding S-VOL update reaches the specified time, the RCU suspends all S-VOLs in the group. A timeout occurs when the RCU cannot settle a recordset within the specified time or has not had any communications from one of the MCUs in the group within the specified time.



**NOTE:** The copy pending timeout value should be less than the I/O timeout value of the host system.

- **Time Out (RCU ready) (min.):** Maximum delay allowed for re-establishing MCU-RCU communications following MCU power-off (none or from 1 to 10 minutes; none = no timeout for CA Async RCU ready). The default is five minutes. If the MCU cannot re-establish communications with the RCU within the specified time, the MCU suspends all P-VOLs in the group.
  - **Cancel** button: Cancels settings.
  - **Set** button: Sets consistency group options.
1. Connect to the MCU.
  2. Ensure that async options are configured as needed (see ["Asynchronous copy option"](#) on page 553).
  3. From the Consistency Group tree, click a consistency group mode that includes the consistency group to be added.
  4. From the Consistency Group list, click the consistency group(s) to add. Select more than one group that is not registered yet.
  5. Right-click, click **CT Group Operation**, and click Add CT Group. The Add CT Group pane appears.
  6. From the Add CT Group pane, click the port type (fibre) and group options: copy pending timeout and RCU ready timeout. Remember that you cannot modify the port type of the group after assigning a pair to the group.
  7. Click **Set** in the Add CT Group pane. The Add CT Group pane closes, and the list changes to the Consistency Group Settings Parameter list.



**NOTE:** After being set, options can be modified and canceled (see “[Modifying parameters and deleting consistency groups](#)” on page 554).

8. Click **Apply** on the CA main pane to apply settings to the disk array.

When the Add CT Group pane closes, the list changes to the Consistency Group Settings Parameter list. However, columns other than CTG are blank. For further information about the Consistency Group Settings Parameter list, see “[Modifying consistency group options \(CT Group Option\)](#)” on page 551.

## Modifying consistency group options (CT Group Option)

Use the **CT Group Option** command to modify consistency group options set when you added the consistency group. When the **CT Group Option** command is selected, the CT Group Option pane appears. The CT Group Option pane consists of the same fields as the Add CT Group pane (see “[Adding consistency groups \(Add CT Group\)](#)” on page 550).



**NOTE:** To change group options, split all pairs in the group first.

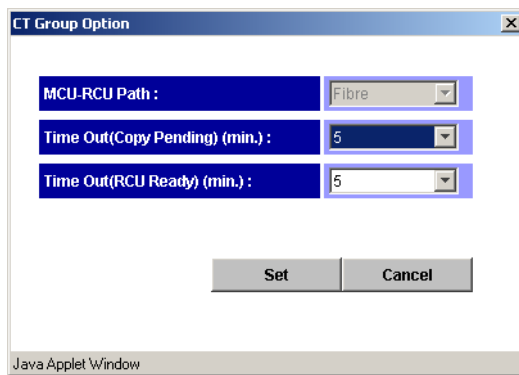

**Figure 318** CT Group Option pane

- **MCU-RCU Path:** Selected port type for remote copy connections. You cannot change the port type on the CT Group Option pane.
- **Time Out (Copy Pending) (min.):** Maximum delay (copy pending timeout) allowed for CA Async copy (none or from 1 to 15 minutes; none = no timeout for CA Async copy pending). The default is five minutes. If the delay between the CA Async P-VOL update and corresponding S-VOL update reaches the specified time, the RCU suspends all S-VOLs in the group. A timeout occurs when the RCU cannot settle a recordset within the specified time or has not had any communications from one of the MCUs in the group within the specified time.



**NOTE:** The copy pending timeout value should be less than the I/O timeout value of the host system.

- **Time Out (RCU Ready) (min.):** Maximum delay allowed for re-establishing MCU-RCU communications following MCU power-off (none or from 1 to 10 minutes; none = no timeout for CA Async RCU ready). The default is five minutes. If the MCU cannot re-establish communications with the RCU within the specified time, the MCU suspends all P-VOLs in the group.
- **Cancel** button: Cancels settings.
- **Set** button: Sets consistency group options.

1. Connect to the MCU.

2. Split all pairs in the group (Pairsplit-r).
3. From the Consistency Group tree, click a consistency group mode that includes the consistency group to be modified.
4. From the Consistency Group list, click the consistency group(s) to be modified. Select more than one consistency group with **MCU** in the **This CU** column.
5. Right-click, click **CT Group Operation**, and click **CT Group Option**. The CT Group Option pane appears. If the **CT Group Option** command is not enabled, split the remaining pairs in this consistency group.
6. Change group options as needed.
7. Click **Set** in the CT Group Option pane. The CT Group Option pane closes, and the list changes to the **Consistency Group Settings Parameter** list. Settings are applied to the list.



**NOTE:** After being set, options can be modified and canceled (see “[Modifying parameters and deleting consistency groups](#)” on page 554).

8. Click **Apply** on the CA main pane to apply settings to the disk array.
9. When you are finished changing group options, resync all pairs in the group (pairresync).

When the CT Group Option pane is closed, the list changes to the Consistency Group Settings Parameter list.

CTG	M-R Path	Time Out(Pending)	Time Out(Ready)
<b>00</b>	<b>Fibre</b>	<b>005</b>	<b>None</b>

**Figure 319** Consistency Group Settings Parameter list

- **CTG:** Consistency group number
- **M-R Path:** Channel type
- **Time Out (Pending):** Copy pending time out (maximum delay) allowed for CA Async copy (in minutes)
- **Time Out (Ready):** RCU ready timeout (maximum delay) allowed for re-establishing MCU-RCU communications following MCU power-off (in minute)

## Deleting consistency groups (Delete CT Group)

A consistency group can be deleted only from the MCU and only if the MCU does not contain P-VOLs still assigned to the group. Deleting a consistency group from an MCU does not affect consistency groups registered at other MCUs. The RCU automatically deletes a consistency group when the last volume pair in the group is deleted.

Use the **Delete CT Group** command to delete the selected group from the current MCU.

1. Connect to the MCU.
2. From the Consistency Group tree, click a consistency group mode that includes the consistency group to be deleted.
3. From the Consistency Group list, click the consistency group(s) to be deleted. Select more than one consistency group with **MCU** in the **This CU** column.
4. Right-click, click **CT Group Operation**, and click **Delete CT Group**. The list changes to the Consistency Group Settings Parameter list. If the **Delete CT Group** command is not enabled, the selected group still contains P-VOLs in this MCU.



**NOTE:** After being set, options can be modified and canceled (see “[Modifying parameters and deleting consistency groups](#)” on page 554).

5. Click **Apply** on the CA main pane to apply the deletion to the disk array.

## Asynchronous copy option

When the **Async Option** command is selected, the Async Option pane appears. Use the Async Option pane to specify CA asynchronous copy option parameters for the connected disk array. Async options apply to the entire physical control unit, including all CA P-VOLs and S-VOLs behind the control unit.

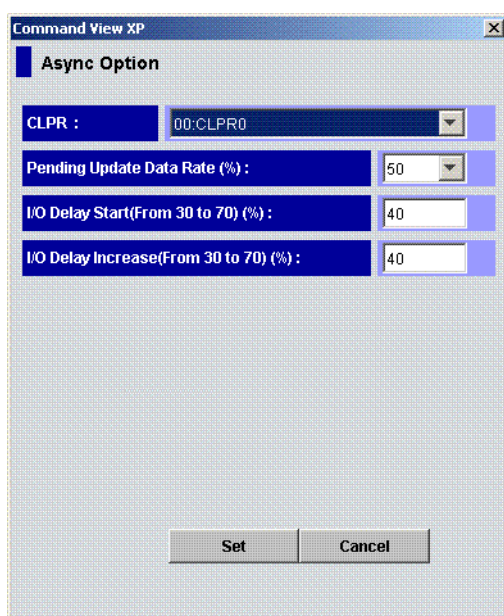

**Figure 320** Async Option pane

All default settings indicate the current settings.

- **Pending Update Data Rate (%):** CA Asynchronous sidefile threshold, which is maximum amount of cache that can be used for storing CA Async recordsets (sidefiles). Select any value between 30% and 70% (10% increments) (see “[Inflow control of recordsets](#)” on page 495).

The current pending update data rate is common to both CA and TC390 operations. The most recently entered value is applied to all TrueCopy Async operations.

If one or more consistency groups exist, this setting cannot be changed. This setting can only be changed when no CT groups are assigned.

You can specify the Pending Update Data Rate from the Async Option pane of TC390. If the specified Pending Update Data Rate is less than the I/O Delay Start or I/O Delay Increase specified from the Async Option pane of CA, the Pending Update Data Rate is available.

- **Offloading Timer (sec.):** Amount of time (0-255 seconds) the MCU waits to send a CA Async recordset to the RCU. The MCU suspends all affected CA Async volume pairs if it cannot offload a recordset to the RCU within the specified time (for example, the RCU is still responding channel-command-retry).

The offloading timer should be set to less than the HBA I/O timeout value.

When channel-extenders are used for CA Async, the offloading timer should be set to 35 seconds or less to avoid affecting host I/O performance.



**NOTE:** The following are available in firmware version 21.07.04 or later (XP128/XP1024).

- **I/O Delay Start:** Threshold (0-70%), which is maximum amount of cache for starting inflow control for the asynchronous copy. When amount of cache used for async recordsets reaches the specified threshold, the MCU controls the cache inflow.
- **I/O Delay Increase:** Threshold (0-70%), which is maximum amount of cache for starting to strengthen control over inflow for the asynchronous copy. When amount of cache used for async recordsets reaches the specified threshold, the MCU controls cache inflow.



**NOTE:** Specify a value not exceeding the I/O Delay Increase for the I/O Delay Start. Specify a value not exceeding the Pending Update Data Rate for the I/O Delay Increase. If sidefile threshold is set between 0 to 30%, influence to the I/O delay is kept low.

HP recommends that you change the I/O Delay Start and I/O Delay Increase when all CA asynchronous pairs are suspended, or host I/O and sidefiles do not exist. If you do not want to control inflow into a sidefile, specify the value same as the Pending Update Data Rate for the I/O Delay Start and I/O Delay Increase, and specify 0 second for the Offloading Timer.

1. From the Consistency Group list, right-click, and click **Async Option**. The Async Option pane appears.



**NOTE:** You do not have to select a consistency group on the list.

2. In the Async Option pane, select parameters.
3. Click **Set** to set parameters. The list changes to the Asynchronous Option Settings Parameter list.



**NOTE:** After being set, options can be modified and canceled (see “[Modifying parameters and deleting consistency groups](#)” on page 554).

4. Click **Apply** on the CA main pane to apply option settings to the disk array.

When the Async Option pane closes, the list changes to the Asynchronous Option Settings Parameter list.

Pending Rate	Offloading	Delay Start	Delay Increase
050	090	030	040

**Figure 321** Asynchronous Option Settings Parameter list

- **Pending Rate:** Sidefile allocation in %. Indicates sidefile threshold, which is maximum amount of cache used for storing CA asynchronous recordsets (sidefiles).
- **Offloading:** Offloading timer in seconds. Indicates that the MCU waits to send a CA Async recordset to the RCU.
- **Delay Start** (for XP128/XP1024, use firmware version 21.07.04 or later only): Maximum amount of cache for starting inflow control for the asynchronous copy.
- **Delay Increase** (for XP128/XP1024, use firmware version 21.07.04 or later only): Maximum amount of cache for starting to strengthen control over inflow for the asynchronous copy.

## Modifying parameters and deleting consistency groups

After the Consistency Group (CT Group) and Asynchronous Option operations, parameters can be modified individually, and consistency groups set by the operation can be deleted.



## Modifying parameters

1. After performing the CT Group operation, click a consistency group on the list. To modify parameters for Async Option operation, you do not have to select the row on the list.
2. Right-click, and click **Modify**. A pane for each operation appears.
3. Modify parameters, and click **Set**.
4. Click **Apply** on the CA main pane to apply modifications to the disk array.

## Deleting consistency groups

1. Click the consistency groups on the list.
2. Right-click, and click **Delete**. Selected consistency groups are deleted from the list, and the consistency groups are out of operations.
3. Click **Apply** on the CA main pane to apply the deletion to the disk array.

For the CT Group operation, the **Cancel All** command deletes all consistency groups on the list, and all consistency groups are removed from operations. All consistency groups can also be deleted using the **Delete** command and selecting all consistency groups on the list. When all consistency groups are deleted (by the **Cancel All** or **Delete** command), the list status becomes the **Volume** list.

For the Asynchronous Option operation, the **Delete** command is not available. You can modify options set or cancel all option settings made.



**NOTE:** After the delete operation of the **CT Group Operation** command, the **Modify** command is not available.

---

## Usage Monitor operations

Use the **Usage Monitor** tab to perform remote copy usage monitoring operations for the connected disk array. The usage monitoring function collects I/O statistics for all LDEVs on the connected disk array.

Usage monitor operations are:

- "Starting and stopping monitoring" on page 555
- "Displaying usage monitor graph" on page 556

## Starting and stopping monitoring

At each data sampling time interval, the usage monitoring function collects 480 pieces of data for each LDEV and up to 16,385 pieces of data for the entire disk array.

### Starting remote copy usage monitoring

1. Click the **Usage Monitor** tab.
2. Enter the sampling time interval (from 1 to 540 minutes) from the **Rate** field. A rate of five minutes or more is recommended.
3. Click **Run** in the **Operation** drop-down list.
4. Click **Apply**. A confirmation dialog box appears.
5. Click **OK** to confirm. The Status changes from Stop to Running. Click **Cancel** to cancel settings.

Monitoring data collect continues, even if the pane is closed, until you stop monitoring operations. Monitoring data collection continues even if the disk array is rebooted.

## Stopping remote copy usage monitoring

1. Click the **Usage Monitor** tab.
2. Click **Stop** in the **Operation** drop-down list.
3. Click **Apply**. A confirmation dialog box appears.
4. Click **OK** to confirm. The Status field changes from Running to Stop. Click **Cancel** to cancel settings.

## Displaying usage monitor graph

When usage monitoring is running, use the Usage Monitor tab to display user-selected remote copy I/O statistics in real time. I/O statistics data is collected according to data-sampling rate indicated in the **Rate** field.

The usage monitor graph plots user-selected I/O statistics (up to 65 data points) on an x-y graph. The x-axis displays time. The y-axis displays number of I/Os during the last sampling period. The legend to the right of the graph indicates data being displayed. If a value on the y-axis exceeds 10,000,000, the value is displayed in exponential notation. For example,  $1E7 = 1 \times 10^7 = 10,000,000$  and  $2E8 = 2 \times 10^8 = 200,000,000$ . The **Update** area displays the most recent data sample time for data on the graph.

1. Click the **Usage Monitor** tab.
2. Verify that usage monitoring is running (Status = Running). The usage monitor graph can be displayed only when monitoring is on.
3. Right-click the graph area, and click **Display Item**. The Display Item pane appears.

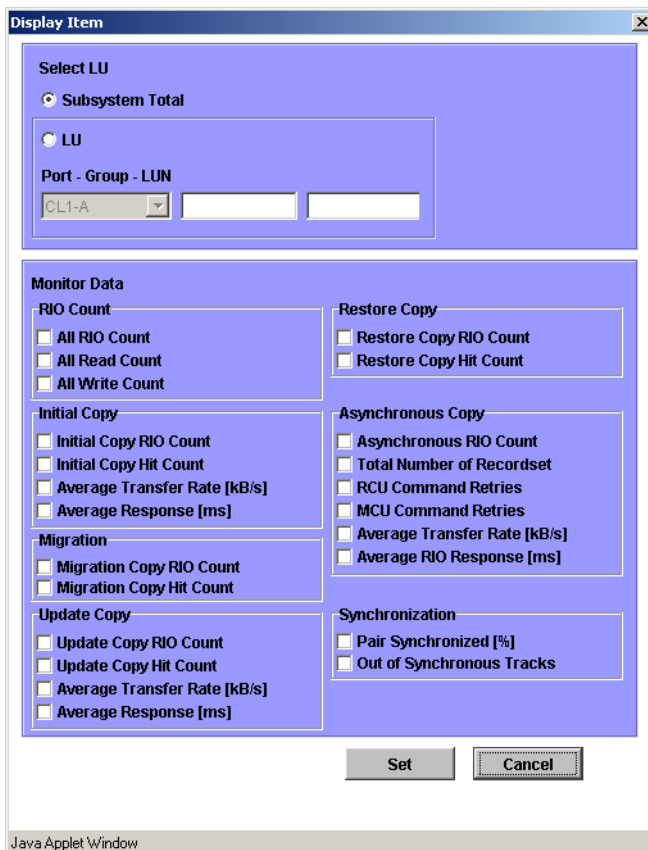

**Figure 322** Display Item pane

4. To display I/O statistics for all LDEVs in the subsystem, click **Subsystem Total**. To display I/O statistics for a specific LU, click **LU**, and enter the LU by selecting the port from the drop-down list and entering the group (00-7F) and LUN (00-FF).



**NOTE:** CU:LDEV is displayed on the top of the graph. If # is added to the end of the LDEV number, such as 00:3C#, the LDEV is an external volume. For details about external volumes, see “External storage for the XP12000” on page 757.

- In the Monitor Data area, select the I/O statistics data to display on the graph. Select at least two check boxes. Table 109 describes I/O statistics data.



**NOTE:** To display Average Transfer Rate, Average Response, or Pair Synchronized, do not select any other statistics at the same time. The graph can display only one type of data at a time: I/O count, rate, response time, or percent.

- Click **Set**. A graph showing selected I/O statistics data for the selected LU(s) appears.
- Complete the following tasks if needed:
  - To enlarge the displayed graph, right-click the graph, and click **Large Size**.
  - To return the graph to normal size, right-click the graph, and click **Normal Size**.
  - To stop displaying the usage monitor graph, right-click the graph, and click **Close**.
  - To stop displaying all graphs, click **Close All**.

**Table 109** Remote copy I/O statistics

Statistic	Description
<b>RIO count</b>	
All RIO count	Total number of remote I/Os.
All read count	Total number of remote read I/Os.
All write count	Total number of remote write I/Os.
<b>Initial copy</b>	
Initial copy RIO count	Number of initial copy remote I/Os.
Initial copy hit count	Number of initial copy hits.
Average transfer rate (kB/s)	Average transfer rate (kB/sec) for initial copy remote I/Os.
Average response (ms)	Average response time (msec) for initial copy remote I/Os.
<b>Migration Copy</b>	
Migration copy RIO count	Number of migration copy remote I/Os.
Migration copy hit count	Number of migration copy hits.
<b>Update Copy</b>	
Update copy RIO count	Number of update copy remote I/Os.
Update copy hit count	Number of update copy hits.
Average transfer rate (kB/s)	Average transfer rate (kB/sec) for update copy remote I/Os.

**Table 109** Remote copy I/O statistics (continued)

Statistic	Description
Average response (ms)	Average response time (msec) for update copy remote I/Os.
<b>Restore Copy</b>	
Restore copy RIO count	Number of restore copy remote I/Os.
Restore copy hit count	Number of restore copy hits.
<b>Asynchronous Copy</b>	
Asynchronous RIO count	Number of asynchronous update copy remote I/Os.
Total number of recordsets	Number of asynchronous recordsets.
RCU command retries	Number of command retries due to RCU channel-command-retry messages.
MCU command retries	Number of command retries due to MCU state-change-pending (SCP) messages.
Average transfer rate (kB/s)	Average transfer rate (kB/sec) for CA Async update copy remote I/Os.
Average RIO response (ms)	(Total RIO process time on subsystem or selected volume for a certain interval period) / (Asynchronous RIO count); where RIO process time = time between async data transfer request and actual transfer of the recordset(s) to the RCU.
<b>Synchronization</b>	
Pair Synchronized (%)	Percent completion of initial copy operations. For example, number of synchronized pairs/total number of pairs.
Out of Sync Tracks	Number of tracks that have not yet been copied by initial copy or resync copy operations. This applies only when suspended during initial copy or during resync copy.

The usage monitor graph closes automatically in the following cases:

- Stopping the usage monitoring function by clicking **Stop** in the **Operation** drop-down list, and clicking **Apply**.
- Clicking another tab.
- Exiting Command View.

## Optimizing CA operations and disk array performance

CA operations result in increased utilization of the disk array's channel resources because of additional write (remote copy) operations to secondary volumes. The CA update copy mode (synchronous or asynchronous) determines exactly how the remote copy operations impact disk array performance as follows:

- **Synchronous** copy mode has an additional effect on disk array performance: increased service and disconnect time for write I/Os to CA P-VOLs due to the delay between channel-end and device-end. The length of this delay increases as the distance between the P-VOL and S-VOL increases, so the longest delay occurs when primary and secondary volumes are the maximum distance apart.
- **Asynchronous** copy mode (CA Asynchronous) eliminates all delays associated with CA Synchronous operations while providing protection for write-dependent applications if a disaster occurs. Write I/Os for CA Async P-VOLs are processed the same way as writes for simplex volumes, without any

increase in service or disconnect time. Asynchronous S-VOL updates are performed completely independent of all host I/O processes at P-VOLs, and there are no restrictions on subsequent read and write operations to CA Async P-VOLs. The only performance concerns for CA Asynchronous are:

- Ensuring adequate cache resources are available for sidefiles used to store recordsets at MCUs and RCUs
- Ensuring sufficient Fibre Channel paths are defined for copy operations

In addition to CA update copy mode, several other factors can also affect disk array performance. You can optimize CA operations and I/O performance of disk arrays by analyzing workloads and addressing system-level conditions (for example, number of Fibre Channel paths) that can affect disk array performance. You can also control the impact of CA operations on disk array performance by selecting the appropriate RCU options for each MCU (see ["Registering RCUs \(Add RCU\)"](#) on page 536 and ["Modifying RCU options \(Change RCU Option\)"](#) on page 540) and the appropriate update copy mode (synchronous or asynchronous) and pair options (see ["Creating CA volume pairs \(Paircreate\)"](#) on page 565) for each CA pair. In addition, you can upgrade CA hardware components and adjust the configuration of components to improve disk array performance under a wide range of operating conditions.

[Table 110](#) lists conditions affecting disk array performance and provides recommendations for addressing these conditions.

**Table 110** Disk array performance conditions and recommendations

Condition	Description	Recommendation(s)
Write-intensive workloads	Write-intensive workloads, such as database logging volumes, can have a significant impact on disk array I/O response times.	Spread write-intensive data across several volumes to minimize queuing. Also consider increasing the duplex write line (DWL) of the disk array using Performance Advisor (Performance Advisor running at the same time is not supported).
Large block size	Workloads with large write block sizes, such as DB deferred writes, can impact performance.	Spread workloads with large write block sizes across several volumes.
High host channel demand	Demand on MCU's host channels can affect performance.	Spread workloads across several disk arrays to utilize additional channels.
Sequential write operations	CA operations can have a negative impact on workloads with a high percentage of sequential write operations, such as batch processing operations (for example, dump/restore, sort operations).	Avoid performing restore operations to volumes belonging to CA pairs. Instead, restore data to a scratch volume and then create the CA volume pair.
Cache size	<p>Large cache size improves read hit performance, which allows more disk array resources to be devoted to write operations. Resulting performance improvements can offset some or all performance losses due to CA remote copy operations.</p> <p>CA Asynchronous requires additional cache for sidefile data. Insufficient cache resources can result in command retries, state-change-pending (SCP) notifications, and puncture conditions.</p>	Consider increasing cache size of CA disk arrays to handle cache sidefile operations and improve overall disk array performance. For best results, cache and NVS capacity of primary and secondary disk arrays should be the same (for CA Asynchronous, RCU sidefile requirements are twice that of the MCU) to enable the remote site to function adequately during disaster recovery.

**Table 110** Disk array performance conditions and recommendations (continued)

Condition	Description	Recommendation(s)
RCU capacity	Performance of RCUs directly affects performance of MCUs. If an RCU is overloaded with heavy update activity, MCU and system performance can also be degraded.	Distribute CA remote copy operations among several remote disk arrays to avoid overloading any one RCU.
Paths	An inadequate number of paths may decrease disk array performance. Performing CA Synchronous operations over long distances can also degrade performance. CA Asynchronous is recommended for long distances.	Ensure an adequate number of paths between the primary and secondary disk arrays are installed. This is especially important for disk arrays containing both P-VOLs and S-VOLs.

## Discontinuing CA operations

If you plan to use CA for nondisruptive data migration or duplication (see [“Using CA for data migration and duplication”](#) on page 579), configure and establish CA operations, allow CA to synchronize volumes, redirect application I/Os (if migrating), and discontinue CA operations. When you are ready to discontinue CA operations, perform CA operations in the correct order to avoid error messages. For example, CA will not delete an RCU path until you delete all CA pairs still using that path, and you cannot delete a group until you delete all CA Asynchronous pairs in that group.

1. Delete all CA pairs from MCU(s) (pairsplit-S, see [“Deleting CA volume pairs \(Pairsplit-S\)”](#) on page 575). For CA Async pairs, use the **Delete Range-Group** option to delete all pairs in a group at one time. Verify that the pair status changed to SMPL for all CA volumes before continuing.
2. Delete CA Async group(s) from MCU(s) (see [“Deleting consistency groups \(Delete CT Group\)”](#) on page 552). The RCU automatically deletes a group when all pairs in the group are deleted.
3. Delete RCUs (see [“Deleting RCUs \(Delete RCU\)”](#) on page 541). Check each CU image of each MCU to ensure that all RCUs are deleted before continuing.
4. Remove remote copy connections (physical paths). If you are not familiar with the operation of remote copy hardware components, call HP technical support for assistance.
5. For Fibre Channel interface, reset initiator port(s) to ordinary target(s) at MCU(s) (see [“Port change operation”](#) on page 546).

## Performing CA pair operations

### Preparing for CA volume pair operations

Before starting CA operations, consider the relative importance of disk array I/O performance and disaster recovery preparation. As described in [“Optimizing CA operations and disk array performance”](#) on page 558, remote copy operations can affect I/O performance of MCUs and RCUs. CA provides many options (initial copy options, pair options, group options, async options) to control impact of CA operations on I/O performance. These options can be set separately for each pair, CA Async group, and MCU to provide maximum flexibility. You can select options that minimize impact of CA operations on disk array performance or options that maximize effectiveness of CA operations to ensure the best level of backup data integrity. System-level factors (for example, number of paths) can also affect CA operations and disk array performance (see [Table 110](#)).

For CA disaster recovery operations, ensure that RCUs are attached to a host server to enable sense information reporting and host failover information transferring. If the remote site is unattended, attach RCUs to a host server at the main site, so the system administrator can monitor operational condition of RCUs.

To prepare for CA volume pair operations, identify volumes (by port, TID, and LUN and/or by LDEV ID) for which you want to establish CA remote copy operations. Identify volumes required for system operations and volumes containing important data to be backed up (for example, DB log files). Copying these volumes to the remote site enables faster disaster recovery than maintaining a current version of these files at the remote site. For large databases spanning multiple volumes, plan to establish a CA Asynchronous consistency group for each database, so update sequence consistency of the database can be ensured at the remote site.

Start creating CA volume pairs as soon as you have:

- Identified volumes (LUs) that will become CA P-VOLs (and S-VOLs).
- Ensured that all system and CA requirements are met (see “[System requirements](#)” on page 504 and “[Requirements and restrictions](#)” on page 504).
- Completed hardware and software installation (see “[Installing hardware](#)” on page 506 and “[Fibre Channel remote copy connections](#)” on page 507).
- Configured MCUs and RCUs for CA operations (see “[Configuring MCUs and RCUs for CA operations](#)” on page 511).

If you will use CA to perform remote copy operations, the Command View management station must be LAN-attached to the MCU of each CA volume pair. You should also install and attach a Command View management station to RCUs at your remote site. If you will use RAID Manager commands instead of CA, contact your HP account support representative for information about CA configuration services.

## Common procedure for CA pair operations

Use the CA main pane to perform pair setting operations. All operations performed from the CA main pane have the following common procedure:

1. Click a CU number in the CU Number/Port Number tree.



**NOTE:** You must select a CU number in the tree. If you select a Port number, pair setting operations cannot be performed.

2. Click one or more LUs or pairs in the Volume list.
3. Right-click ([Figure 323](#)). The pop-up menu consists of:
  - **Pairdisplay:** Displays LU status (see “[Viewing CA pair status for LUs and LDEVs \(Pairdisplay\)](#)” on page 563).
  - **Paircreate:** Creates a volume pair using the **Synchronous** and **Asynchronous** commands (see “[Creating CA volume pairs \(Paircreate\)](#)” on page 565).
  - **Pairsplit-S:** Deletes pairs (see “[Deleting CA volume pairs \(Pairsplit-S\)](#)” on page 575).
  - **Pairsplit-r:** Splits (Suspends) pairs (see “[Splitting CA pairs \(Pairsplit-r\)](#)” on page 569).
  - **Pairresync:** Resumes pairs (see “[Resuming CA volume pairs \(Pairresync\)](#)” on page 572).

- **Change Pair Option:** Changes pair options (see “[Changing pair options \(Change Pair Option\)](#)” on page 578).

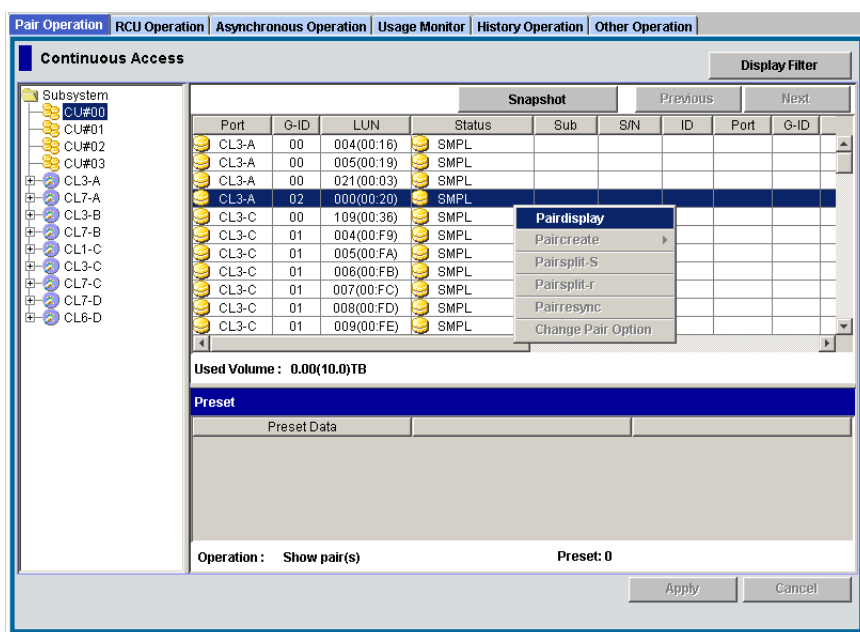

**Figure 323** Performing pair settings operations

4. Click a command, and use the pane to make your settings.
5. Click **Set** to set parameters. The **Cancel** button closes the pane, but does not set the settings. The **Cancel All** button returns to the Volume list.



**NOTE:** After being set, options can be modified and canceled (see “[Modifying parameters and deleting LUs](#)” on page 562).

6. Click **Apply** on the CA main pane to apply the settings to the disk array.

Active commands in the pop-up menu displayed in [step 3](#) are in black letters. Inactive commands are in gray letters. Whether commands are active or inactive depends on the status of LUs selected in the Volume list.

The following sections describe each command and operation in detail.

## List after command selection

After the pane closes, only LUs selected in [step 2](#) of the procedure described in the “[Common procedure for CA pair operations](#)” on page 561 are displayed in the list. Items of the list also change. The Volume list in this status is called the Pair Settings Parameter list. Items of the Pair Settings Parameter list depend on the command clicked from the pop-up menu and the operation performed. Items for each command are described in the following sections.

The **Set** button on each parameter pane presets parameters to the Pair Settings Parameter list. To apply parameters to the system, click **Apply** on the CA main pane.

The **Cancel** button closes the pane, but does not set parameters. The **Cancel All** button returns to the Volume list.

## Modifying parameters and deleting LUs

After pair settings operations, LU parameters can be modified individually. LUs selected to be the pairs can be deleted.



## Modifying LU parameters

1. Click the LU on the Pair Settings Parameter list.
2. Right-click, and click **Modify**. A pane appears.
3. Modify parameters, and click **Set**.
4. Click **Apply** on the CA main pane to apply modifications.

## Deleting LUs

1. Click the LUs on the Pair Settings Parameter list.
2. Right-click, and click **Omit**. LUs selected in [step 1](#) are deleted from the Pair Settings Parameter list, and deleted LUs are out of pair settings operations.
3. Click **Apply** on the CA main pane to apply the deletion.

The **Cancel All** command deletes all LUs listed on the Pair Settings Parameter list, and all LUs are removed from pair settings operations. LUs can also be deleted using the **Omit** command and selecting all LUs on the Pair Settings Parameter list. When all LUs are deleted (by the **Cancel All** or **Omit** command), the list status becomes the Volume list.

## Viewing CA pair status for LUs and LDEVs (Pairedisplay)

The **Pairedisplay** command displays detailed CA pair status information.

1. From the Volume list, click the LU.
2. Right-click, and click **Pairedisplay**. The Pairedisplay pane appears. The **Pairedisplay** command can be selected if **Subsystem**, **CU number**, or **Port number** is selected in the tree.



**Figure 324** Pairedisplay pane

- **P-VOL** and **S-VOL**:
  - Port - host group ID (host group name) - LUN (lowest LDEV number for a LUSE pair). Only the host group name of the primary site displays.
  - Device emulation name.
  - Capacity in MB (up to two decimal places).

- CLPR number and name. CLPR number and name are not displayed under S-VOL.



**NOTE:** If # is added to the end of the LDEV number, such as 00:3C#, the LDEV is an external volume. For details about external volumes, see ["External storage for the XP12000"](#) on page 757.

- **Pair Status:** SMPL, COPY, PAIR, PSUE, PSUS, PDUB, Suspending, or Deleting (see ["CA volume pair status"](#) on page 497 for further information about CA pair status). If the pair is split or suspended, the split/suspended type is also displayed.
- **Pair Synchronized:** How far the copy operation progressed in percentage and the progress bar.
- **RCU S/N and ID:** Serial number and SSID of the RCU (or MCU if S-VOL is selected).
- **MCU-RCU Path:** Channel type of path interface between disk arrays (fibre or serial).
- **Update Type:** Synchronous or Asynchronous.
- **Initial Copy Pace:** 1-15 tracks (disabled when status is PAIR).
- **Initial Copy Priority:** 1-256 (disabled when the status is PAIR).
- **P-VOL Fence Level:** Conditions under which the MCU rejects write operations to the P-VOL.
  - **Never:** Never fence the operation
  - **Data:** Fence when the MCU cannot successfully execute an update copy operation for any reason
  - **Status:** Fence only if the MCU cannot change the S-VOL status to the same status as the P-VOL.
- **S-VOL Write:** Enabled or disabled for this pair (enabled only when pair is split).
- **Pair Established:** Date and time volume pair was created.
- **Last Updated:** Date and time volume pair status was last updated.
- **Difference Management:** **Auto**, **Cylinder**, or **Track**.
- **Asynchronous Parameter:**
  - **CT Group:** Consistency group to which CA Async pair is assigned.
  - **Error Level:** Error level for CA Async pair(s).
  - **Suspended by:** Consistency status (group or LU) of split or suspended CA Async pair (see ["CA volume pair status"](#) on page 497) (displayed only at the RCU).
  - **Consistency time:** Consistency time of group to which CA Async pair is assigned.
- **Previous** button: Changes displayed pair status information to the previous LU on the Volume list (the LU of the row above).
- **Next** button: Changes displayed pair status information to the next LU on the Volume list (the LU of the row below).
- **Refresh** button: Refreshes pair status information.
- **Close** button: Closes the Pairedisplay pane.



**NOTE:** Display Filter settings can affect how the **Previous** or **Next** button is recognized. The Volume list can display 256 rows at one time. Use the **Previous** and **Next** buttons to display the previous or next 256 rows.

## Creating CA volume pairs (Paircreate)

Use the **Paircreate** command to create one or more CA pairs. When the **Paircreate** command is selected, the Paircreate pane appears. Use the Paircreate pane to select the S-VOL, RCU, and initial copy options for pair(s) being created.



**NOTE:** Select the appropriate CU image before creating CA pairs.

**Figure 325** Paircreate pane

- **Port - Group - LUN:**
  - **P-VOL:** Port - Group - LUN of the primary volume (P-VOL), CLPR number, and CLPR name.



**NOTE:** If # is added to the end of the LDEV number, such as 00:3C#, the LDEV is an external volume. For details about external volumes, see “[External storage for the XP12000](#)” on page 757

- **S-VOL:** Secondary volume (S-VOL). Specify each item as follows: Port: 1A-2R, Group: 00-7F, LUN: 00-FF. If you select two or more LUs as P-VOLs in the Volume list, select an S-VOL for the P-VOL of the lowest LUN. S-VOLs for the remainder of the P-VOLs are automatically assigned according to the LUN. For example, if you select three LUs on the Volume list and select LUN01 as S-VOL for the first P-VOL, S-VOLs of following P-VOLs are LUN02 and LUN03.



**NOTE:** Ensure that all assigned S-VOLs are available. If the automatically assigned S-VOLs are already used for other operations, modify the S-VOL individually (see “[Modifying parameters and deleting LUs](#)” on page 562 for instructions).

- **RCU:** RCU (serial number, CU number, SSID, and port type) for CA pair(s) being created. RCUs already registered can be selected from the drop-down list. The RCU must be the same for all pairs being created during this operation.

- **P-VOL Fence level:** Conditions under which the MCU rejects write operations to the P-VOL.
  - **Never:** Never fence the operation. When asynchronous pair(s) are created, **Never** is set automatically.
  - **Data:** Fence when the MCU cannot successfully execute an update copy operation for any reason.
  - **Status:** Fence only if the MCU cannot change the S-VOL status to the same status as the P-VOL. This option is only for synchronous mode.
- **Initial Copy Parameters:** Initial copy options.
  - **Initial Copy:** Initial copy mode. **Entire:** Copy all data. **No Copy:** Do not copy data. The default is **Entire**.
  - **Initial Copy Pace (From 1 to 15):** Number of tracks for initial copy. The default is 15.
  - **Priority (From 1 to 256):** Priority (scheduling order) of initial copy operation. The default is 32.
- **Difference Management:** Select **Auto**, **Cylinder**, or **Track**. The default is Auto. When you select Auto, either Cylinder or Track is selected depending on basic size of the logical unit (LU).
- **Asynchronous Parameters:** Only for Asynchronous pair(s).
  - **CT Group:** Consistency group already registered.



**NOTE:** Only CA Asynchronous pairs belonging to the same CLPR can be allocated to one consistency group. For more information about CLPRs, see ["Disk/Cache Partition for the XP12000"](#) on page 143.

- **Error Level:** Error level for CA Async pair(s), Group, or LU.
- **Cancel** button: Cancels settings made, and closes the Paircreate pane.
- **Set** button: Sets parameters, and closes the Paircreate pane.

When you create two or more pairs at one time, initial copy options are the same for all pairs. You can modify these initial copy options for individual pairs as needed. For instructions, see ["Modifying parameters and deleting LUs"](#) on page 562. For further information about initial copy options, see ["CA initial copy and pair options of the Paircreate pane"](#) on page 568.

The **Use Time-Saving Mode** option executes the specified paircreate operations quickly (that is, requests for multiple pairs are entered simultaneously).

1. Ensure that volumes that will be CA S-VOLs are offline from all hosts.
2. Connect to the disk array containing P-VOLs of the pair(s) you are creating, and start CA. RCPs or Initiator ports must be configured (see ["Configuring MCU ports"](#) on page 532), and RCU(s) must be already registered (see ["Registering RCUs \(Add RCU\)"](#) on page 536).
3. From the Volume list on the CA main pane, click the LU(s) that will be P-VOL(s) of the CA volume pair(s). You can select one or more volumes and establish one or more pairs at one time only if S-VOLs are in the same RCU and pairs will have the same copy mode (Sync or Async). You cannot start CA Sync and CA Async pairs at the same time.
4. Right-click, click **Paircreate**, and click the pair mode (**Synchronous** or **Asynchronous**). The Paircreate pane appears.

Pair mode specifies the update copy mode (see ["Update copy operations"](#) on page 492) for new pair(s): **Synchronous** or **Asynchronous**. The mode selected has the greatest impact on performance and must be considered carefully. Factors in mode selection include (but are not limited to) the use of CA (for disaster recovery or migration), number of pairs, and write I/O activity to P-VOLs.

5. From the Paircreate pane, enter the S-VOL for the pair, select the RCU, and select initial copy options for pair(s) being created (see "Creating CA volume pairs (Paircreate)" on page 565).
6. Click **Set** to close the Paircreate pane and set parameters.  
The list changes to the Pair Settings Parameter list (Paircreate). The Pair Settings Parameter list (Paircreate) is updated by parameter settings and displays all pairs being created. Initial copy options and pair options selected are applied to all pairs, but you can modify options for each pair individually as needed (see "Modifying parameters and deleting LUs" on page 562).
7. From the Pair Settings Parameter list (Paircreate), check the RCU S/N and SSID, S-VOL, and copy options for each pair. You can modify options as needed (see "Modifying parameters and deleting LUs" on page 562). Ensure that all CA options for each new pair are correct.
8. To execute the paircreate requests quickly, select the **Use Time-Saving Mode** check box above the Pair Settings Parameter list (Paircreate).
9. Click **Apply** on the CA main pane to create (start) specified CA pair(s). The MCU starts initial copy operations according to the initial copy priority and maximum initial copy activities setting of the RCU.
10. In the CA main pane, verify that new CA pairs are displayed correctly (COPY status) in the Volume list. To monitor the status of new pair(s), click **Refresh** to update information in the Volume list, or use the Pairedisplay pane (see "Viewing CA pair status for LUs and LDEVs (Pairedisplay)" on page 563) to monitor detailed status of each pair.

The Paircreate operation is rejected if the P-VOL is in the correction access or correction copy state. If this occurs, wait for the volume state to change and repeat this procedure. If the status is not displayed correctly, ensure that the correct CU image is selected.



**CAUTION:** If a timeout error occurs when the **Use Time-Saving Mode** option is selected, access the CA main pane, and confirm the volumes on which the paircreate operation could not be performed. Deselect the **Use Time-Saving Mode** option for failed volumes, and retry the paircreate operation.

After the Paircreate pane closes, the list changes to the Pair Settings Parameter list (Paircreate).

Port	Group	LUN	S/N	SSID	Port	Group
CL1-C	00	00	20580	0007	CL1-E	03

LUN	Type	Mode	Fence	Pace	Priority	Diff	Error Code
02	Sync	Entire	Never	15	032	Track	

**Figure 326** Pair Settings Parameter list (Paircreate)

- **Port, Group,** and **LUN** of the LU in the connected disk array.
- **S/N** and **SSID** of the RCU (MCU if you are connected to the RCU).
- **Port, Group,** and **LUN** of the LU to be the S-VOL.
- **Type:** **Synchronous** or **Asynchronous** of the pair created.
- **Mode:** **Entire:** Copy all cylinders. **No Copy:** Do not copy.
- **Fence:** Conditions under which the MCU rejects write operations to the P-VOL: **Never, Data,** or **Status.**
- **Pace:** Number of tracks (1-15) for initial copy.
- **Priority:** Priority (scheduling order) of initial copy operations.
- **Diff:** In the measurement of the **Cylinder** or the **Track**, CA manages differentials among data.
- **CTG:** Consistency group used for pair created (Asynchronous pairs only).

- **ErrLvl:** Error level, **Group** or **LU**. When a failure occurs, pairs in the same group or in an LU are suspended (Asynchronous pairs only).

## CA initial copy and pair options of the Paircreate pane

CA initial copy and pair options specify the fence level, initial copy parameters, and asynchronous parameters. Initial copy and pair options are selected on the Paircreate pane. While the initial copy operation is in progress, the initial copy options cannot be changed unless you delete (pairsplit-S) and then restart (paircreate) the pair. After the initial copy operation is complete, you can only change CA pair options (Fence Level and Error Level).

### Fence Level (CA Synchronous only)

**Fence Level:** Conditions under which the MCU rejects write operations to the P-VOL, which is known as “fencing.” This option is very important for disaster recovery planning (see “[Considering the P-VOL fence-level setting](#)” on page 583).

- **Never:** The P-VOL is never fenced. If the CA volume pair is split or suspended, write operations to the P-VOL are accepted.
- **Data:** The P-VOL is fenced when the MCU cannot successfully execute an update copy operation for any reason.
- **Status:** The P-VOL is fenced only if the MCU cannot change the S-VOL status to suspended when an update copy operation fails. If the MCU changes the S-VOL status to suspended, subsequent write operations to the P-VOL are accepted, and the MCU tracks all P-VOL updates while the pair is suspended.

### Initial Copy parameters

**Initial Copy:** Initial copy mode for new pair(s). The default is **Entire Volume**.

- **Entire Volume:** The initial copy operation copies all cylinders on the P-VOL (except diagnostic and unassigned alternate tracks) to the S-VOL.
- **No Copy:** The initial copy operation is not performed. The MCU performs update copy operations as needed.



**CAUTION:** Ensure that the P-VOL and S-VOL are already identical when using this setting.

---

**Initial Copy Pace:** Maximum number of tracks (**1-15**) that can be copied at one time by the CA initial copy operation before the MCU accepts another host request for that P-VOL. A high setting (for example, 15 tracks) speeds up the initial copy operation, but may affect the disk array’s I/O performance if the P-VOL experiences high write I/O activity. A lower setting (for example, 3 tracks) slows down the initial copy operation to minimize impact on the disk array’s I/O performance.

**Priority:** Order in which initial copy operations are performed if the number of requested initial copy operations is greater than the maximum initial copy activity setting on the RCU Option pane (see “[Registering RCUs \(Add RCU\)](#)” on page 536). The highest priority is 1, and the lowest priority is 256 (current default = 32). Use the CA initial copy priority option to spread initial copy operations across disk array groups and disk array domains (ACP pairs) to reduce initial copy time and host I/O contention.

For example, suppose the maximum initial copy activity setting is four, and you add six CA pairs at one time (for LUNs 00 through 05) with the initial copy priority set as follows:

P-VOL of pair	Priority	The MCU starts initial copy operations for LUNs 03, 05, 00, and 04 immediately, starts LUN 01 when one of the first four initial copy operations is complete, and starts LUN 02 when the next initial copy operation is complete. If more CA pairs are created, the MCU also prioritizes initial copy operations by time requested, so all pairs in the first group are started before any pair in the next group is started.
LUN 03	1	
LUN 05	2	
LUN 00	3	
LUN 04	4	
LUN 01, 02	5	

**Difference Management:** Measurement method CA uses to manage differential data for the pair: Auto, Cylinder, or Track. The default is Auto. When you select Auto, either Cylinder or Track is selected depending on basic size of the logical unit (LU).

### Asynchronous parameters

**C/T Group:** Consistency group for new pair(s) (Async only). All CA Asynchronous pairs must be assigned to a consistency group.

**Error level:** Error level for CA Async pair(s).

- **Group:** When the specified pair is suspended, all CA Async pairs in the same group are suspended, even if the failure affects only that pair and not the entire group.

Select **Group** for all CA Async volumes essential to disaster recovery.

- **LU:** If the failure affects only the specified pair, only that pair is suspended. A failure that affects an entire group always results in suspension of all pairs in the group and all other affected CA pairs.

Suspended CA Async S-VOLs with **LU** should not be used for disaster recovery.

## Splitting CA pairs (Pairsplit-r)

Use the **Pairsplit-r** command to split CA pairs. When the **Pairsplit-r** command is selected, the Pairsplit-r pane appears. Use the Pairsplit-r pane to select Pairsplit-r options for the pair(s). You can split a CA pair

only after the initial copy operation is complete. For further information about split CA pairs, see “CA split types (PSUS)” on page 500.

The screenshot shows a Java Applet window titled "Pairsplit-r". It contains the following fields and options:

- Volume :** CL1-D - 00 - 00
- S-VOL Write :** Disable
- Suspend Kind :** S-VOL
- Asynchronous Parameters** section:
  - Suspend Range :** Group
  - Pending Update :** Drain

At the bottom of the window are two buttons: "Set" and "Cancel". The footer of the window reads "Java Applet Window".

**Figure 327** Pairsplit-r pane

- **Volume:** Port - Host group - LUN of the selected volume.



**NOTE:** If # is added to the end of the LDEV number, such as 00:3C#, the LDEV is an external volume. For details about external volumes, see “External storage for the XP12000” on page 757

- **S-VOL Write:** Default is **Disable**.
  - **Enable:** The S-VOL of this CA pair is available to receive read and write I/Os while the CA pair is split. If you select **Enable** and you want to resync the pair later, select the **S-VOL** suspend kind option to ensure that P-VOL and S-VOL bitmaps are merged at the MCU. This option is available only when the selected volume is a CA P-VOL.
  - **Disable:** The S-VOL of this pair accepts I/Os only while the pair is split.
- **Suspend Kind:** Default is **S-VOL**.
  - **S-VOL:** The P-VOL accepts all subsequent write I/O operations, and the MCU tracks updates while the pair is split. Subsequent write I/O operations to the P-VOL are permitted or rejected, depending on fence-level of the pair. This setting is available from the MCU and RCU. Used this setting to keep the P-VOL online. All CA Asynchronous pairs have this setting.
  - **P-VOL Failure** (available only for CA Synchronous and only when connected to the MCU): The MCU rejects all write I/O operations to the P-VOL while the pair is split, regardless of the P-VOL fence-level setting. Use this setting to maintain synchronization of the CA pair.
- **Asynchronous Parameters:**
  - **Suspend Range:**
    - **Group:** The MCU and RCU splits all other CA Async pairs in the same consistency group as the specified pair(s). This option is available only when one pair is selected.



**LU:** The MCU and RCU splits only the specified CA Async pair(s) (even if error level of the pair is group).

- **Pending Update:**

**Drain:** The MCU changes the CA Async pair status from **Suspending** to **PSUS** only after the RCU accepts the pairsplit operation and completes the following steps:

- (a) Finishes settling all pending recordsets for the pair.
- (b) Completes negotiation with all MCUs (report ready-for-suspension to all MCUs and receive acknowledgements) without further recordsets generated.

If the RCU cannot complete these actions within the copy pending timeout setting, the RCU discontinues the original pairsplit-r request and forcibly suspends affected CA Async pairs. Thus, you can use the copy pending timeout parameter to limit the amount of time it takes to complete the split-drain operation.

**Purge:** The MCU changes CA Async pair status from **Suspending** to **PSUS** as soon as the RCU accepts the pairsplit operation. The MCU and RCU discard pending recordsets and mark cylinders containing discarded recordsets as modified in P-VOL and S-VOL bitmaps, respectively. When the pair is resumed (pairresync), the P-VOL and S-VOL bitmaps are merged at the MCU, and all cylinders marked as modified are copied to the S-VOL.

If the MCU does not receive acknowledgement of the pairsplit-r operation from the RCU within the copy pending timeout setting, the MCU forcibly suspends all affected CA Async pairs.

1. Connect to the MCU (or RCU) of the volume pair(s) to be split. You do not need to vary the P-VOL(s) offline. To use the S-VOL write enable option, connect to the MCU, and select the P-VOL of the pair.
2. From the CU Number/Port Number tree on the CA main pane, click the number of the correct CU image.
3. From the Volume list on the CA main pane, click the CA volume pair(s) to be split. Select either CA Synchronous or CA Asynchronous pairs, but not both. Pair status must be **PAIR**.
4. Right-click, and click **Pairsplit-r**. The Pairsplit-r pane appears.
5. Click the options for the pair(s), and click **Set** to close the Pairsplit-r pane and set parameters. The list changes to the Pair Settings Parameter list (Pairsplit-r). You can modify options as needed (see ["Modifying parameters and deleting LUs"](#) on page 562). Ensure that pairsplit options for each pair are correct. The suspend kind (**S-VOL** or **P-VOL failure**) and fence-level pair options determine whether the P-VOL accepts write I/O operations after the pair is split.

---

 **CAUTION:** If you need to split a pair and the P-VOL is required for system operation, do not use the P-VOL Failure suspend kind option. Use the S-VOL suspend kind option so the P-VOL continues accepting I/Os.

---

6. To execute the pairsplit requests quickly, select the **Use Time-Saving Mode** check box above the Pair Settings Parameter list (Pairsplit-r).
7. Click **Apply** on the CA main pane to split specified pair(s). For CA Synchronous pairs, the MCU completes all P-VOL write operations in progress and associated update copy operations at the S-VOL before splitting the pair, so the pair is synchronized at the time of pairsplit.
8. From the CA main pane, verify that CA pairs are displayed correctly (**PSUS** status) in the Volume list. Use the **Pairresync** command (see ["Resuming CA volume pairs \(Pairresync\)"](#) on page 572) to resync split CA volume pair(s).



**CAUTION:** If a timeout error occurs when the **Use Time-Saving Mode** option is selected, access the CA main pane, and confirm the volumes on which the pairsplit-r operation could not be performed. Deselect the **Use Time-Saving Mode** option for failed volumes, and retry the pairsplit-r operation.

When the Pairsplit-r pane closes, the list changes to the Pair Settings Parameter list (Pairsplit-r).

Port	Group	LUN	S/N	SSID	S-VOL Wrt
<i>CL1-D</i>	<i>00</i>	<i>00</i>	<i>20030</i>	<i>0005</i>	<i>Disable</i>

Kind	Range	Mode	Error Code
<i>S-VOL</i>	<i>Group</i>	<i>Drain</i>	

**Figure 328** Pair Settings Parameter list (Pairsplit-r)

The Pair Settings Parameter list (Pairsplit-r) displays the following information for selected pair(s):

- **Port**, **Group** (TID), and **LUN** of the LU in the connected disk array.
- **S/N** and **SSID** of the RCU (MCU if connected to the RCU).
- **S-VOL Wrt**: Disable or enable. Enable means the S-VOL is available to receive read and write I/Os.
- **Kind**: S-VOL or P-VOL Failure. Type of suspend operation.
- **Range**: Split pair(s) in what measure: Group or LU (Async only).
- **Mode**: Drain or purge pairsplit-r option (Async only).

## Resuming CA volume pairs (Pairresync)

While a CA pair is split or suspended, the MCU does not perform update copy operations to the S-VOL.

- For a split/suspended CA Synchronous pair, the MCU may or may not continue accepting write I/Os for the P-VOL, depending on the P-VOL fence level and pairsplit options (if user-requested) (see ["Creating CA volume pairs \(Paircreate\)"](#) on page 565 and ["Splitting CA pairs \(Pairsplit-r\)"](#) on page 569).
- For a split/suspended CA Async pair, the MCU and RCU tracks recordsets discarded during pairsplit/suspension, and the MCU continues accepting write I/Os for the P-VOL. The MCU tracks P-VOL cylinders updated while the pair is split/suspended.

If the RCU accepts write I/Os for a split S-VOL (S-VOL write enable), the RCU also tracks S-VOL cylinders updated. When the split/suspended pair is resumed, the MCU merges the P-VOL and S-VOL cylinder bitmaps to determine out-of-sync cylinders.

Use the **Pairresync** command to resume split/suspended CA pairs. When the **Pairresync** command is selected, the Pairresync pane appears. Use the Pairresync pane to change pair options, and select the resync range option (asynchronous) for selected pair(s).



**NOTE:** Resyncing suspended LDEV pairs within a CA LUSE pair is not supported.

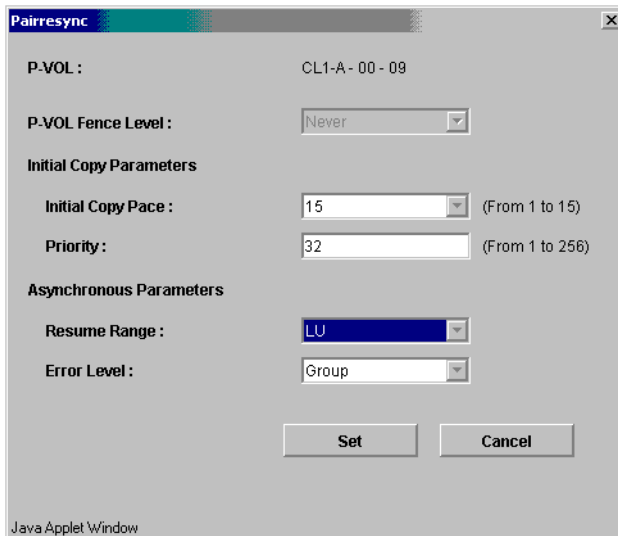

**Figure 329** Pairresync pane

- **P-VOL:** Port - Host group - LUN of the selected volume.



**NOTE:** If # is added to the end of the LDEV number, such as 00:3C#, the LDEV is an external volume. For details about external volumes, see “[External storage for the XP12000](#)” on page 757.

- **P-VOL Fence Level:** Fence level.
  - **Never:** Never fence the operation.
  - **Data:** Fence when the MCU cannot successfully execute an update copy operation for any reason.
  - **Status:** Fence only if the MCU cannot change the S-VOL status to the same status as the P-VOL. For synchronous mode only.

When asynchronous pair(s) are created, **Never** is set automatically.

- **Initial Copy Parameters:**
  - **Initial Copy Pace (From 1 to 15):** Number of tracks for resume copy. The default is 15.
  - **Priority (From 1 to 256):** Priority for resync operation, which determines order in which resync operations are performed.
- **Asynchronous Parameters:**
  - **Resume Range:** When **Group** is selected, resync all split or suspended CA Async pairs in the same group as the selected pair. When **LU** is selected, resync only the selected CA Async pair(s).
  - **Error Level:** Error level for the CA Async pair(s): Group or LU. This option is available only when **LU** is selected for the Resume Range.

For more information about option parameters, see “[CA initial copy and pair options of the Paircreate pane](#)” on page 568.



---

**NOTE:** If an MCU or RCU is powered off and its backup batteries are fully discharged while CA pairs are suspended, the P-VOL and S-VOL cylinder bitmaps are not retained. In this unlikely case, the MCU and RCU mark all cylinders of all split or suspended CA volumes as modified, so the MCU performs the equivalent of an entire initial copy operation when pairs are resynced.

---

1. If any pair was suspended due to an error condition (use the Pairdisplay pane to view suspend type), ensure that the error condition is removed (see “[CA error codes](#)” on page 588 for troubleshooting instructions). The MCU will not resync pair(s) until the error condition is removed.
  2. Connect to the MCU of pair(s) to be resynced, and start CA.
  3. From the CU number/Port Number tree on the CA main pane, click the number of the correct CU image.
  4. If you are resyncing split or suspended LUs, click the pair(s) on the **Volume** list on the CA main pane. Select PSUS or PSUE pairs (not both). Select either Sync or Async pairs (not both). If you plan to use the **Resume Range** option, select only one CA Async pair in the group.
- 



**NOTE:** Resyncing suspended LDEV pairs within a CA LUSE pair is not supported.

---

5. Right-click, and click **Pairresync**. The Pairresync pane appears.
  6. Click the pair options, and click **Set** to close the Pairresync pane and set parameters. The list changes to the Pair Settings Parameter list (Pairresync). Ensure that all resync and pair options for each pair are correct.
- 



**NOTE:** After being set, options can be modified and canceled (see “[Modifying parameters and deleting LUs](#)” on page 562).

---



**NOTE:** To resync all split/suspended CA Async pairs in a consistency group, ensure that the **Resume range** option on the Pairresync pane is set to **Group**.

---

7. To execute pairresync requests quickly, select the **Use Time-Saving Mode** check box above the Pair Settings Parameter list (Pairresync).
  8. Click **Apply** on the CA main pane to resync specified pair(s).
  9. From the CA main pane, verify that CA pairs are displayed correctly (**COPY** or **PAIR** status) in the Volume list.
- 



**CAUTION:** If a timeout error occurs when the **Use Time-Saving Mode** option is selected, access the CA main pane, and confirm the volumes on which the pairresync operation could not be performed. Deselect the **Use Time-Saving Mode** option for failed volumes, and retry the pairresync operation.

---

When the Pairresync pane closes, the list changes to the Pair Settings Parameter list (Pairresync).

Port	Group	LUN	S/N	SSID	Priority	Pace
CL2-A	0F	04	62492	0023	032	15

Fence	ErrLvl	Range	Error Code
Never	Group	Group	

**Figure 330** Pair Settings Parameter list (Pairresync)

The Pair Settings Parameter list (Pairresync) view displays the following information for selected pair(s):

- **Port**, **Group**, and **LUN** of the selected LU.
- **S/N** and **SSID** of the RCU (MCU if connected to the RCU).
- **Priority**: Initial copy priority (blank after initial copy operation is complete).
- **Pace**: Number of tracks (1-15) for the copy.
- **Fence**: Fence level.
  - **Never**: Never fence the operation.
  - **Data**: Fence when the MCU cannot successfully execute an update copy operation for any reason.
  - **Status**: Fence only if the MCU cannot change the S-VOL status to the same status as the P-VOL. For synchronous mode only.
- **ErrLvl**: Error level of pair (**Group** or **LU**) (Async LUs only).
- **Range**:
  - **Group**: Resync all split or suspended CA Async pairs in the same group as selected pair.
  - **LU**: Resync only selected CA Async pair(s).

## Deleting CA volume pairs (Pairsplit-S)

Delete a CA pair from the MCU only when it is no longer necessary to maintain a remote copy of the P-VOL. When a CA pair is deleted from the MCU, the MCU stops all CA copy operations for that pair and changes the pair status of the P-VOL and S-VOL to **SMPL**. After a CA pair is deleted, the MCU continues accepting all subsequent write I/O operations to the P-VOL and does not track P-VOL updates.

Delete a CA pair from the RCU only for disaster recovery (see “[CA disaster recovery operations](#)” on page 582). When a CA pair is deleted from the RCU, the RCU changes the S-VOL pair status to **SMPL**, but does not change the pair status of the corresponding P-VOL. When the MCU performs the next CA operation, the MCU detects that the S-VOL status changed, and changes the P-VOL status to **PSUS-pairsplit-S to RCU**. To restart a pair deleted from the RCU, delete the pair from the MCU, and create the pair from the MCU using the appropriate initial copy option (**Entire** or **No Copy**) to restart the pair.

To delete all CA Async pairs in a consistency group, delete pairs from the MCU. The CA pair status changes to **Deleting** when the pairsplit-S operation is accepted by the MCU and RCU, and changes to **SMPL** after the internal pairsplit-S process is complete. To delete CA Async pairs according to consistency status (for example, for disaster recovery), delete the pairs from the RCU.



**CAUTION:** When you delete a CA pair from the RCU, remember that the S-VOL and P-VOL are identical (for example, same volume label), and take appropriate precautions to prevent a system problem due to duplicate volumes.

Use the **Pairsplit-S** command to delete one or more CA pairs. When the **Pairsplit-S** command is selected, the Pairsplit-S pane appears. Use the Pairsplit-S pane to change Pairsplit-S options (by force, and CA Async delete range) for pair(s) selected on the Volume list on the CA main pane.

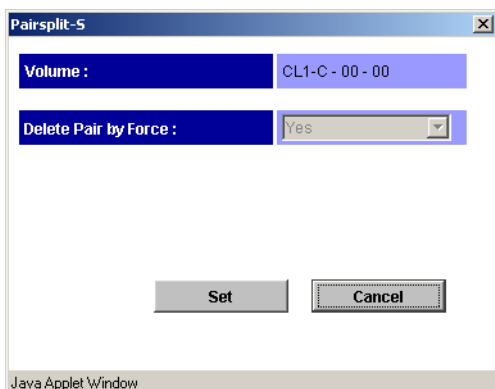

**Figure 331** Pairsplit-S pane

- **Volume:** Port - Host Group - LUN of the selected volume.



**NOTE:** If # is added to the end of the LDEV number, such as 00:3C#, the LDEV is an external volume. For details about external volumes, see ["External storage for the XP12000"](#) on page 757.

- **Delete Pair by Force:** Restriction on deleting a CA volume pair.
  - **Yes:** Pair(s) are deleted even if the MCU cannot communicate with the RCU. Use this option to free a host waiting for device-end from an MCU that cannot communicate with its RCU, thus allowing host operations to continue.
  - **No:** Pair(s) are deleted only if the MCU can change the pair status of the P-VOL and S-VOL to **SMPL**.

When the status of the pair is SMPL or Deleting, the default is **Yes** (cannot be changed). When the status of the pair is not SMPL or Deleting, the default is **No**.

- **Asynchronous Parameters: Delete Range:** Simplifies disaster recovery operations for CA Async consistency groups at the RCU (secondary (remote) disk array).

CA delete range options are:

- **Group** (MCU or RCU): The MCU/RCU deletes all CA Async pairs in the same consistency group as the specified pair, regardless of pair status and consistency status.



**CAUTION:** Do not use this option when deleting pairs at the RCU during disaster recovery. This option is available only when one pair is selected.

- **C/T** (RCU only): The RCU deletes all CA Async pairs with the same consistency time.
- **LU** (MCU or RCU): The MCU and RCU deletes only the specified CA Async pair(s). Use this option to remove individual volumes from consistency groups.

Defaults are as follows:

- More than one pair selected: LU.
- One pair selected and pair is P-VOL: Group.

- One pair selected and pair is S-VOL: C/T.



**NOTE:** When an asynchronous pair is forcibly deleted, the CA delete range option must be Group. Therefore, more than one pair cannot be forcibly deleted.

1. Connect to the MCU or RCU of the pair(s) to be deleted, and start CA. If you plan to use the CA Async C/T delete range option, connect to the RCU.
2. From the CU Number/Port Number tree on the CA main pane, click the number of the correct CU image.
3. From the Volume list, click the CA volume pair(s). Select either CA Sync or Async pairs, but not both. If you plan to use the CA Async **C/T** or **Group** delete range option, select only one CA Async pair in the group.
4. Right-click, and click **Pairsplit-S**. The Pairsplit-S pane appears.
5. Click the pairsplit-S options for selected pair(s), and click **Set** to close the Pairsplit-S pane and set parameters. The list changes to the Pair Settings Parameter list (Pairsplit-S). Repeat this step as needed to set pairsplit-S options for pair(s).



**NOTE:** After being set, options can be modified and canceled (see “[Modifying parameters and deleting LUs](#)” on page 562).

6. To execute the pairsplit-S requests quickly, select the **Use Time-Saving Mode** check box above the Pair Settings Parameter list (Pairsplit-S).
7. Click **Apply** on the CA main pane to delete the specified pair(s).
8. When deleting CA Asynchronous pairs, verify that the pairsplit-S request completed successfully by checking the detailed CA pair status information on the Pairdisplay pane (should be **SMPL**, not **Deleting** or **Suspended**).

When deleting CA Sync pairs, verify that the pairsplit-S request completed successfully by checking the pair status on the **Pair Operation** tab (**SMPL** status).

9. To restart a pair deleted from the RCU, delete the pair from the MCU, and use the **Paircreate** command with the appropriate CA initial copy option (**Entire** or **No Copy**) to restart the pair.



**CAUTION:** If a timeout error occurs when the **Use Time-Saving Mode** option is selected, access the CA main pane, and confirm the volumes on which the pairsplit-S operation could not be performed. Deselect the **Use Time-Saving Mode** option for failed volumes, and retry the pairsplit-S operation.

When the Pairsplit-S pane closes, the list changes to the Pair Settings Parameter list (Pairsplit-S).

Port	Group	LUN	S/N	SSID	Port	Group	LUN	Mode	Error Code
CL1-C	00	00						Yes	

**Figure 332** Pair Settings Parameter list (Pairsplit-S)

- **Port**, **Group**, and **LUN** of the selected LU number.
- **S/N** and **SSID** of the RCU (MCU if connected to the RCU).
- **Mode:** Yes (delete forcibly) or No (delete normally).
- **Range:** Range for deleting the asynchronous pair: **Group**, **LU**, or **C/T**.

## Changing pair options (Change Pair Option)

Use the **Change Pair Option** command to change pair options, **Fence level** and **Error level** (asynchronous pairs only). When the **Change Pair Option** command is selected, the Change Pair Option pane appears. From the Change Pair Option pane, change pair options.

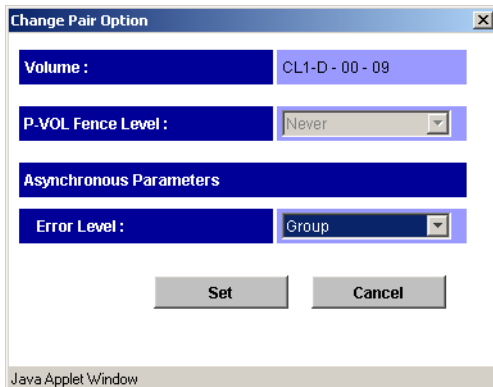

**Figure 333** Change Pair Option pane

- **Volume:** Port - Host group - LUN of the selected volume.



**NOTE:** If # is added to the end of the LDEV number, such as 00:3C#, the LDEV is an external volume. For details about external volumes, see ["External storage for the XP12000"](#) on page 757.

- **P-VOL Fence Level:** Select the fence level for the new pairs. The fence level determines the conditions under which the MCU rejects write operations to the P VOL. **Never** is automatically set for an asynchronous pair. See ["Considering the P-VOL fence-level setting"](#) on page 583 for more information about this option.
  - **Never:** P-VOL is never fenced.
  - **Data:** P-VOL is fenced when the MCU cannot successfully execute an update copy operation for any reason.
  - **Status:** P-VOL is fenced only if the MCU cannot change the S-VOL status to suspended when an update copy operation fails.
- **Asynchronous Parameters** (async only):
  - **Error Level:** Error level for the new pairs: **Group** or **LU**.



**NOTE:** To set parameters on multiple volumes at one time without changing individual parameters for each volume, set the parameter values you do not want to change to blank. Only the parameters you input are changed.

- **Cancel** button: Cancels settings made and closes the **Change Pair Option** panel.
  - **Set** button: Sets parameters and closes the **Change Pair Option** panel.
1. Connect to the MCU or RCU of the pairs to be changed, and start CA.
  2. From the CU Number/Port Number tree on the CA main pane, click the number of the correct CU image.
  3. From the Volume list, click the CA volume pair(s) to be modified. Select either CA Sync or Async pairs, but not both.



4. Right-click, and click **Change Pair Option**. The Change Pair Option pane appears.
5. Click the pair options for selected pair(s), and click **Set** to close the Change Pair Option pane and set parameters. The list changes to the Pair Settings Parameter list (Change Pair Option). Repeat this step as needed to change pair options for pair(s).



**NOTE:** After being set, options can be modified and canceled (see “[Modifying parameters and deleting LUs](#)” on page 562).

6. To execute pair option change requests quickly, select the **Use Time-Saving Model** check box above the Pair Settings Parameter list (Change Pair Option).
7. Click **Apply** on the CA main pane to change options for specified pair(s).
8. In the CA main pane, verify that the pair option change completed successfully.

When the Pair Option pane closes, the list changes to the Pair Settings Parameter list (Pair Option).

Port	Group	LUN	S/N	SSID	Fence	ErrLvl	Error Code
<i>CL1-D</i>	<i>00</i>	<i>09</i>	<i>20030</i>	<i>0005</i>	<i>Never</i>	<i>Group</i>	

**Figure 334** Pair Settings Parameter list (Pair Option)

- **Port**, **Group**, and **LUN** of the selected LU number.
- **S/N** and **SSID** of the RCU (MCU if connected to the RCU).
- **Fence:** Fence level.
  - **Never:** Never fence the operation.
  - **Data:** Fence when the MCU cannot successfully execute an update copy operation for any reason.
  - **Status:** Fence only if the MCU cannot change the S-VOL status to the same status as the P-VOL. For synchronous mode only.
- **ErrLvl:** Error level of the pair (**Group** or **LU**) (Async LUs only).

## Using CA for data migration and duplication

### Data migration using CA Synchronous

Use CA Synchronous for device or workload migration with minimal impact to host applications. You may need to migrate data from one volume to another for any of the following reasons:

- Load data onto new or scratch volumes (for example, new or upgraded disk array)
- Temporarily move data off volumes to accommodate other activities (for example, repair)
- Relocate volumes to balance workloads and distribute I/O activity evenly within and across disk arrays to improve disk array and system performance

The CA initial copy operation copies the entire contents of the P-VOL to the S-VOL. The P-VOL and S-VOL are identical and synchronized when the initial copy operation completes and the pair status changes from COPY to PAIR. The CA pair is then deleted to change the state of the devices to SMPL, and host high-availability (HA) software can be used to complete the data migration nondisruptively. To support host-based application automation, data migration using CA must be managed by integrating the RAID Manager software with CA operations and host HA software functions.



**NOTE:** To migrate data from other vendors' storage disk arrays onto the disk array, contact your HP account support representative.

1. Vary the S-VOL(s) offline from all attached hosts. S-VOLs are target volumes onto which you are migrating data. P-VOLs (source volumes) can remain online.
2. Connect to the disk array containing volume(s) to be migrated, and start CA. If not already done, install remote copy connections and configure ports (initiator ports for fibre, RCPs for serial) if migrating between disk arrays, and register RCUs.
3. In the CA main pane, click the CU image and LU(s) to be migrated, and start the CA Sync pair(s) by going to the CA main pane and using the **Paircreate** command (see "[Creating CA volume pairs \(Paircreate\)](#)" on page 565).
4. Monitor the progress of initial copy operation(s) and status of pair(s) on the **Pair Operation** tab of the CA main pane. Refresh the tab as needed. When the status changes from COPY to PAIR, the P-VOL and S-VOL are identical and synchronized.
5. If you are not using RAID Manager commands and host software to complete the migration, use the following procedure to stop using P-VOL(s) and switch to S-VOL(s):
  - a. Stop all host updates to P-VOL(s).
  - b. When all update activity to P-VOL(s) stops, connect to the MCU, click the correct CU image, and delete CA volume pair(s) (see "[Deleting CA volume pairs \(Pairsplit-S\)](#)" on page 575).
  - c. If P-VOL(s) and S-VOL(s) are attached to the same host, vary P-VOL(s) offline, and vary S-VOL(s) online. P-VOL(s) and S-VOL(s) have the same volume labels and cannot be online to the same host(s) at the same time.
  - d. To keep volumes synchronized, establish the same CA pair(s) in the reverse direction using the **No Copy** initial copy option (see "[CA initial copy and pair options of the Paircreate pane](#)" on page 568). If the original P-VOL(s) are temporarily unavailable for update copy operations, split the new pair(s) (pairsplit-r) so the new MCU tracks changes.
  - e. Start applications with S-VOL(s). When the original P-VOL(s) become available, resume pair(s) using the Pair List (Pairresync) pane (see "[Resuming CA volume pairs \(Pairresync\)](#)" on page 572).

## Point-in-Time data duplication using CA Asynchronous

Use CA Asynchronous (CA Async) to make Point-in-Time (PiT) duplicates of groups of volumes. Use the CA Async **Group** and **Drain** pairsplit-r options together to create a PiT copy, relative to an application, of an entire CA Async consistency group of volumes.

1. Stop all host updates to all CA Async P-VOLs in the group.
2. After all P-VOL updates are complete, split the CA Async group using the **Group** and **Drain** pairsplit-r options. If you are splitting the group at the main site, issue the pairsplit-r/group command to one P-VOL in the MCU. If you are splitting the group at the remote site, issue the pairsplit-r/group command to one S-VOL in the RCU.

The copy pending timeout setting for the group determines maximum amount of time the pairsplit-r/drain operation can take (see previous description of **Drain**).

3. When the status of all CA Async pairs in the group changes to **PSUS**, the duplicate set of volumes is complete. If needed, restart the application at the main site.

## Powering off and on CA components

You are responsible for controlling power-off activities for disk arrays involved in CA operations. If you need to power off the disk array, call your HP representative or HP technical support for assistance. The following sections provide instructions for performing planned outages of CA components.

If power is removed from an MCU while CA operations are in progress, CA pairs are not affected, but update sequence consistency of CA Async groups at the RCU may be affected (see [“Planned outage of MCUs”](#) on page 581 for further information). When power is restored to an MCU, the MCU communicates with its RCU(s) to confirm the pair status of the S-VOLs. Ensure that CA communications are fully restored (all paths have normal status) before beginning I/O operations to P-VOLs. If the MCU accepts a write I/O operation for a P-VOL before this confirmation is complete, the MCU suspends the pair and changes the status of the P-VOL to *suspended-by RCU* (the MCU cannot change the pair status of the S-VOL).

If power is removed from an RCU or remote copy connection while CA operations are in progress, the MCU detects the communications failure, suspends all affected pairs, and generates SIMs reporting the failures. The MCU changes the status of P-VOLs to *suspended-by RCU*, but cannot change the status of S-VOLs.

If an MCU or RCU is powered off and its backup batteries are fully discharged while CA pairs are suspended, the P-VOL and S-VOL cylinder maps are not retained. In this unlikely case, the MCU and RCU mark all cylinders of all suspended CA volumes as modified, so the MCU performs the equivalent of an entire initial copy operation when the pairs are resumed. (The S-VOL cylinder map is used for CA Async operations and CA S-VOL write enable option.)

## Planned outage of MCUs

A planned MCU outage does not affect CA Synchronous. For CA Asynchronous operations, the MCU must communicate with the RCU even when there are no P-VOL update I/Os from the primary system. During the power-off sequence, the MCU automatically suspends all CA Async pairs in the PAIR and COPY states (suspend type = MCU P/S-OFF). During the power-on-reset sequence, the MCU automatically resumes these suspended pairs (pairs with other suspend types are not automatically resumed).

## Planned outage of RCUs or remote copy connections

You must split all affected CA pairs prior to a planned outage of an RCU or remote copy connection component (for example, Fibre Channel switches). If you do not split the pairs first, the MCU detects the communications failure, suspends all affected pairs, and generates SIMs reporting the failures.

1. Identify all CA P-VOLs that will be affected by the equipment outage. You must know the MCU, CU image, and ID (port, GID, LUN) for each P-VOL.
  - a. For an RCU power-off, identify all P-VOLs paired with S-VOLs in the RCU to be powered off.
  - b. For a remote copy connection outage, identify all P-VOLs in all MCUs using the path and component to be powered off.
2. Connect to each MCU containing affected P-VOLs, and split all affected CA pairs. Confirm that the pair status changes (**Pair Operation** tab or Pairedisplay pane).
3. Perform the planned outage of the RCU or remote copy connection.
4. When the RCU is fully powered on and ready to resume operations, resume (pairresync) all CA pairs at each MCU. Confirm that the pair status changes.

## Planned outage of MCUs and RCUs

When you plan an outage of CA MCUs and RCUs at the same time, MCUs must be powered off before RCUs, and MCUs must be powered on after RCUs.

1. If RCU power-on will be difficult to control (for example, Power-Control-Interface setting), consider increasing or disabling the **RCU ready timeout** group option (see [“Group options”](#) on page 496) for each CA Async group with S-VOLs in RCU(s) to be powered off.
2. Perform the planned outage of MCUs (see [“Planned outage of MCUs”](#) on page 581). Do not power-on MCUs yet.
3. If an RCU to be powered off is connected to an MCU that is not powered off, split those CA pairs before powering off the RCU.

4. Perform the planned outage of the RCUs (see ["Planned outage of RCUs or remote copy connections"](#) on page 581).
5. Power on RCUs. Ensure that they are fully operational and ready to resume operations before powering on MCUs.
6. Power on MCUs, and ensure that they are ready to resume operations. If you split any pairs in [step 3](#), resume (pairresync) those pairs now.

---

## CA disaster recovery operations

### Preparing for disaster recovery

The type of disaster and status of CA volume pairs determines the best approach for disaster recovery. For example, if all CA volume pairs are in the **PAIR** state when a total system failure occurs at a single point in time, S-VOLs are current and recovery is straightforward. Unfortunately, some disasters are not so "orderly" and involve intermittent or gradual failures occurring over a longer period of time. You should anticipate and plan for all types of failures and disasters.

Major steps in preparing for disaster recovery are:

1. Identify volumes and volume groups containing important files and data for disaster recovery. In addition to supporting CA remote copy operations as well as RAID Manager commands, the disk array provides battery-backed nonvolatile duplexed cache, full hardware redundancy, dynamic sparing, and an advanced RAID-5 implementation to ensure full data integrity if a sudden power outage or other failure occurs.
2. Install the Command View management station and CA, and establish CA operations for volumes and groups identified in [step 1](#). Select the proper CU images to access the volumes. See ["Preparing for CA operations"](#) on page 504 for instructions on installing CA. See ["Performing CA configuration operations"](#) on page 531 for instructions on performing CA configuration operations. See ["Performing CA pair operations"](#) on page 560 for instructions on performing CA pair operations.
3. Use the appropriate combination of CA options for disaster recovery:
  - CA Async **offloading timer** option (see ["Asynchronous copy option"](#) on page 553) and **copy pending timeout** group option (see ["Modifying consistency group options \(CT Group Option\)"](#) on page 551). Use the copy pending timeout group option to limit the time duration during which updates may be lost.



**NOTE:** When channel-extenders are used for CA Async, set the offloading timer to 35 seconds or less to avoid affecting host I/O performance.

- 
- CA Async **Error Level** pair option and CA Synchronous **P-VOL Fence Level** pair option (see ["Creating CA volume pairs \(Paircreate\)"](#) on page 565).
4. Establish file and database recovery procedures. These procedures should already be established for recovering volumes that become inaccessible due to control unit failure.
  5. Ensure that the host system at the primary site is configured to receive sense information from MCUs (via RAID Manager or SNMP).
  6. Install and configure host failover software between the main and remote sites. Host failover capability is essential if you use the P-VOL fence-level setting of **S-VOL Status** or **Never** for any CA volume pairs.

## Considering the P-VOL fence-level setting

The P-VOL fence-level setting (see “[Creating CA volume pairs \(Paircreate\)](#)” on page 565) for each CA Synchronous volume pair determines whether the P-VOL is fenced when CA remote copy operations fail. [Table 111](#) summarizes the effect of the fence-level setting on a CA Sync P-VOL.



**NOTE:** The P-VOL fence-level setting does not apply to CA Asynchronous pairs. CA Async P-VOLs are never fenced due to suspension of the pair.

**Table 111** Fence-level settings on CA Sync P-VOLs

Type of Failure		Fence-level Setting		
		S-VOL Data	S-VOL Status	Never
Update copy operation failed, and the MCU changed the status of the S-VOL to PSUE.	Write I/O operations to the P-VOL will be:	REJECTED	Accepted	Accepted
Update copy operation failed, and the MCU could NOT change the status of the S-VOL to PSUE.	Write I/O operations to the P-VOL will be:	REJECTED	REJECTED	Accepted

**Data.** When **S-VOL Data** is selected, the P-VOL is fenced if an update copy operation fails. This P-VOL fence level setting ensures that the S-VOL remains identical to the P-VOL after the CA volume pair is synchronized, but makes the P-VOL inaccessible for updates whenever CA remote copy operations fail. This setting should be considered for the most critical volumes for disaster recovery. This setting reduces the amount of time required to analyze the currency of the S-VOL during disaster recovery efforts. This setting is also designed for applications that can continue operating with another device pair.

**Status.** When **S-VOL Status** is selected, the P-VOL is fenced only if the MCU cannot change the S-VOL pair status to **PSUE**. If the MCU successfully changes the S-VOL pair status to **PSUE**, subsequent write I/O operations to the P-VOL are accepted, and the MCU tracks updates to the P-VOL. This allows the volume pair to be resumed quickly using the pairresync operation (out-of-sync-cylinders only). This setting also reduces the amount of time required to analyze the S-VOL currency during disaster recovery.

**Never.** When **Never** is selected, the P-VOL is never fenced when the pair is suspended. This P-VOL fence-level setting ensures that the P-VOL remains available to applications for updates, even if all CA copy operations failed. The S-VOL might no longer be in sync with the P-VOL, but the MCU tracks updates to the P-VOL while the pair is suspended. Host failover capability is essential if this fence-level setting is used. For disaster recovery, the currency of the S-VOL is determined using sense information transferred via host failover or comparing the S-VOL contents with other files confirmed to be current.

## Setting the fence level

When a take-over by the S-VOL occurs as shown in [Figure 335](#) (two errors have already occurred), Data(V) remains in the rollback process at the secondary host, and full recovery cannot be performed. To avoid this situation, define the fence level of the Redo log file as **Data**, so the P-VOL returns an error if a data disagreement concerning a write request issued from the host is expected to occur. The **Data** fence-level setting maintains full consistency between the Redo log file and data file because no data is written to the data file due to the write error at the log file. However, when the fence level is defined as **Data**, a write I/O causes an error even when processing is suspended due to an error at the S-VOL. In this case, a take-over by the S-VOL occurs, and the significance of the duplex system is lost. Therefore, if you define the fence level as **Data**, applications must be able to handle write I/O errors. Systems

allowing disk errors by means of multiplication can function with the **Data** fence-level setting. For example, Oracle multiplies the Redo log file by itself (default = three times).

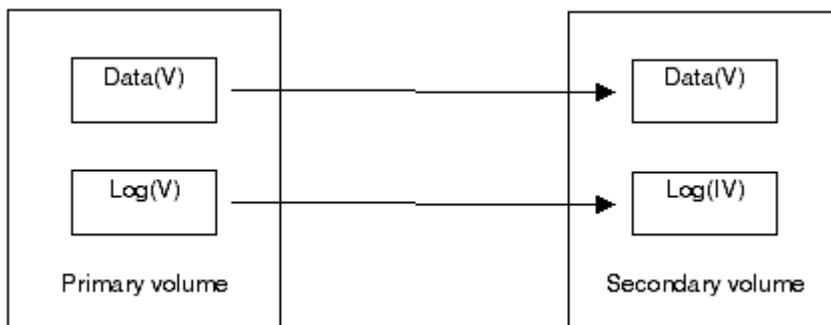

**Figure 335** Relationship between log file and data file in PAIR status

Because most UNIX file systems (excluding JFS and VxFS) have no journal files, the P-VOL fence level should be defined as **Never**. When a take-over by the S-VOL occurs, **fsck** is executed on the volume and the file system is cleaned up, even if the S-VOL is undefined at the secondary host. Data lost depends on how much differential data is contained in the P-VOL when the S-VOL is suspended. During operation, error recovery should be performed when the suspended status (PSUE) is detected (when one error occurs).

## Transferring sense information between sites

When the MCU (or RCU for CA Async) suspends a CA pair due to an error condition, the MCU/RCU sends sense information with unit check status to the appropriate host(s). This sense information is used during disaster recovery to determine currency of the S-VOL, and must be transferred to the remote site via the host failover software.

## File and database recovery procedures

When a CA Synchronous pair is suspended, or when the MCU fails due to a disaster, the S-VOL might contain in-process data. A data set could be open or transactions might not have completed. Even if you use the **S-VOL Data** fence level for all CA Sync pairs, you must establish file recovery procedures. These procedures should be the same as those used for recovering volumes that become inaccessible due to control unit failure. These procedures are more important if the **S-VOL Status** or **Never** fence-level settings are used.

CA Asynchronous does not provide procedures for detecting and retrieving lost updates. To detect and recreate lost updates, check other current information (for example, database journal log file active at the primary system when the disaster occurred). The CA Async group consistency time (C/T) (MCU disk array service processor time) can be useful when performing this detection and retrieval. Because this detection and retrieval process can take a while, your disaster recovery scenario should be designed so detecting and retrieving lost updates are performed after the application is started at the secondary system.

Prepare for file and database recovery using:

- Files for file recovery (such as database log files verified as current). To ensure currency of these files, use the **S-VOL Data** fence level setting for CA pairs containing these important files.
- Sense information with local time-stamp transferred via host failover.



**NOTE:** Remote copy and disaster recovery procedures are inherently complex. Consult your HP account team on sense-level settings and recovery procedures.

Remember that the CA Async time-stamp and C/T information indicates MCU service processor (SVP) time, not host system time.

See “[Pinned track recovery for CA volumes](#)” on page 589 for information about recovering a pinned track on a CA volume.

## Switching operations to remote sites

If a disaster or failure occurs at the primary site, the first disaster recovery activity is to switch operations to the secondary site. CA Synchronous S-VOLs are recovered individually based on the pair status and P-VOL fence-level information for each pair. CA Async S-VOLs are recovered based on pair status and consistency status (at the RCU).

Basic procedures for switching operations to the remote backup site are:

1. Analyze currency of CA Synchronous S-VOLs (see “[Analyzing currency of CA Synchronous S-VOLs](#)” on page 585) and consistency of CA Asynchronous S-VOLs (see “[Analyzing consistency of CA Asynchronous S-VOLs](#)” on page 586).
2. Record consistency time (C/T) of each CA Async group. Suspended CA Async S-VOLs with consistency status of *group* indicate the same C/T. Consistency status and consistency time are displayed only at the RCU.

Remember that the CA Async time-stamp and C/T information indicates MCU service processor time, not host system time.

3. Perform file recovery as needed (see “[File and database recovery procedures](#)” on page 584). Use the C/T of each CA Async group to retrieve lost updates.
4. At the remote site, connect to each RCU, and delete all CA Synchronous pairs. For CA Asynchronous pairs, delete all consistent pairs in a group at one time using the `pairsplit-S` command with the **C/T** delete range option. This option prevents you from accidentally using inconsistent pairs for disaster recovery.

---

 **CAUTION:** After an S-VOL changes to simplex, you cannot distinguish it from a non-CA simplex volume. The CA Async C/T is also discarded when the pair is deleted.

---

5. If necessary, use the logical volume manager to change volume labels of S-VOLs.
6. Ensure that all required file recovery procedures are complete before varying S-VOLs online.
7. At this point, start critical applications at the remote site with previous S-VOLs taking the place of their P-VOLs.

## Analyzing currency of CA Synchronous S-VOLs

[Table 112](#) shows how to determine currency of a CA Synchronous S-VOL based on its pair status and P-VOL fence-level setting. For CA Sync pairs with a P-VOL fence-level setting of **Never**, further analysis is required to determine currency of these S-VOLs. Determine currency of these S-VOLs using the sense information transferred via the host failover, or by comparing the contents of the S-VOL with other files confirmed to be current (such as database log files). These S-VOLs should be recovered using files confirmed to be current.





**NOTE:** Actual data recovery must be done using recovery point data in the database redo log.

**Table 112** Determining CA Synchronous S-VOL currency based on its pair status and P-VOL fence-level setting

Status of S-VOL	Fence Level	Currency of S-VOL
SMPL	Data Status Never	<b>Inconsistent.</b> This S-VOL does not belong to a CA volume pair.  Even if you established a CA pair for this volume, you must regard this volume as inconsistent.
COPY	Data Status Never	<b>Inconsistent.</b> This S-VOL is not synchronized because not all cylinders have been copied from the P-VOL yet. This S-VOL must be initialized (or copied from the P-VOL at a later time).
PAIR	Data Status	<b>Current.</b> This S-VOL is synchronized with its P-VOL.
	Never	<b>Needs to be analyzed.</b> This S-VOL requires further analysis to determine its level of currency.
PSUE - initial copy failed	Data Status Never	<b>Inconsistent.</b> This S-VOL is not synchronized because not all cylinders have been copied from the P-VOL yet. This S-VOL must be initialized (or copied from the P-VOL at a later time).
PSUS - S-VOL by operator	Data Status Never	<b>Suspect.</b> This S-VOL is not synchronized with its P-VOL if any write I/Os were issued to the P-VOL after the pair was split. This pair should be restarted using the <b>Entire Volume</b> initial copy option, but the <b>None</b> option can be used if you are sure no data on the P-VOL changed.
PSUS/PSUE - all other types	Data	<b>Current.</b> This S-VOL is synchronized with its P-VOL.
	Status Never	<b>Suspect.</b> This S-VOL is not synchronized with its P-VOL if any write I/Os were issued to the P-VOL after the pair was split or suspended. Restore consistency of this S-VOL and update it, if required. The time of suspension indicated on the Pairdisplay pane helps determine the last time this S-VOL was updated.

## Analyzing consistency of CA Asynchronous S-VOLs

Table 113 shows how to determine the consistency of a CA Async S-VOL based on its pair status and consistency status. For CA Async S-VOLs with a consistency status of **LU**, the volume is not consistent with other volumes in the same group, and further analysis is required to determine the currency of each of these S-VOLs. Determine currency of these S-VOLs using the sense information transferred via host failover software or comparing contents of the S-VOL with other files confirmed to be current (such as database log files). These S-VOLs should be recovered using files confirmed to be current.

Remember that the CA Async time-stamp and C/T information indicates MCU service processor time, not host system time.





**NOTE:** Actual data recovery must be done using recovery point data in the database redo log.

**Table 113** Determining CA Async S-VOL consistency based on its pair status and consistency status

Status of S-VOL	Usable for Recovery?	Description
PAIR COPY SMPL	No	<p>These states do not usually occur during CA Asynchronous disaster recovery because the RCU suspends all CA Async S-VOLs when communications with the MCU is lost. CA Async S-VOLs in these states should not be used for disaster recovery.</p> <p>Simplex volumes cannot be distinguished from S-VOLs already deleted by the pairsplit-S operation.</p>
PSUE-Group	Yes	<p>Update sequence consistency across these S-VOLs is ensured at the point in time indicated by the consistency time. These S-VOLs can be used for disaster recovery at the secondary system.</p> <p>Updates performed at the primary system after the indicated consistency time were probably lost.</p>
PSUE-LU	No	<p>Contents of this S-VOL might be behind other S-VOLs in the consistency group. If this volume must be consistent with other volumes in the same group, this S-VOL should not be used for disaster recovery.</p> <p>The cause for this status is:</p> <p>The CA Async <b>Error Level</b> pair option for this pair is <b>LU</b> (not <b>Group</b>).</p> <p>This pair was suspended before disaster or failure, at the beginning of the rolling disaster, or during the initial copy operation.</p>

## Transferring operations back to primary sites

After applications are running at the secondary (remote) site, the next activity is to restore the primary (main) site and transfer operations back to the primary site.

1. Bring up the host server(s) at the primary site, and ensure that all CA components are fully operational.
2. At the primary site, delete all CA pairs at MCUs. The **Delete Pair by Force** option must be **Yes** because previous S-VOLs are in the SMPL state at the secondary site.
3. At the main site, delete all CA Async consistency groups at MCUs.
4. At the main site, delete RCUs. Remember to connect with each MCU and each CU image to ensure that all RCUs are deleted.
5. At the main site, configure MCU ports as needed. If you plan to use the same remote copy connections to copy back, change existing RCPs to LCPs, or change existing initiator ports to ordinary target ports.
6. If you plan to use the same channel extenders, change the operating mode to the opposite direction. Boxes and nodes connected to MCUs must be set to channel-mode. Boxes and nodes connected to RCUs must be set to device-mode.
7. At the remote site, configure appropriate ports to enable CA operations in the reverse direction (change target ports to initiator ports for fibre, change LCPs to RCPs for serial). This enables the original RCUs to send CA remote copy operations to the original MCUs to bring the original P-VOLs up to date.

- At the remote site, establish the same CA Async groups and CA pairs in the reverse direction to synchronize the original P-VOLs with the S-VOLs. From the Paircreate parameter pane, select **Entire Volume** for the **Initial Copy** field for the **Initial copy parameters** option.

## Resuming normal operations at primary sites

After CA pairs are established in the reverse direction, you are ready to resume normal operations at the primary (main) site. Remember that the CA terminology is now reversed: original RCUs and S-VOLs (secondary site) are now MCUs and P-VOLs, and original MCUs and P-VOLs (primary site) are now RCUs and S-VOLs.

- At the secondary site, ensure that all CA pairs are in the PAIR (duplex) state. This indicates that CA initial copy operations are complete.
- Halt applications at the remote site, and vary P-VOLs (original S-VOLs) offline at the remote site. This maintains synchronization of CA Sync pairs.
- Split (pairsplit-r) all CA pairs at MCUs (original RCUs) to destage any pending data from cache. Confirm that pairs are split (PSUS) before proceeding. If an error occurs, resolve it before proceeding.
- Delete all CA pairs at MCUs (original RCUs). You do not need to use the **Delete Pair by Force** option. For CA Async pairs, the MCU and RCU complete all pending updates before changing the pair status to SMPL.
- Change CA settings at MCUs (original RCUs) to prepare for normal CA operations. Delete CA Async groups and RCUs (original MCUs). If you plan to use the same remote copy connections, reconfigure ports (change initiator ports back to ordinary target ports for fibre).
- If you plan to use the same channel extenders, change the operating mode back to the original direction. Boxes and nodes connected to MCUs must be set to channel-mode. Boxes and nodes connected to RCUs must be set to device-mode.
- At the primary site, configure RCPs or initiator ports, add RCUs, and add CA Async groups.
- At the primary site, establish all CA groups and pairs in the original direction. You can use the **None** initial copy option because all P-VOLs and S-VOLs are synchronized. If there is any possibility that volumes are not 100% synchronized, select **Entire Volume** for the **Initial Copy** field for the **Initial copy parameters** option to be safe.
- Vary the MCU and P-VOLs online, and start applications at the primary site.

---

## Error codes and messages

### CA error codes

CA displays error messages on the Command View management station when error conditions occur during CA operations. Error messages describe the error and can include an SVP error code. If you need to call HP technical support for assistance, report CA and SVP error codes.

### Service Information Messages (SIMs)

The disk array generates SIMs when it is necessary to notify you of a possible service requirement for the disk array. SIMs can be generated by the channel and storage path microprocessors and by the service processor (SVP) of the disk array. The SVP reports all SIMs related to CA operations. Each time a SIM is generated, the amber **Message** LED on the disk array's front operator pane (under the **Ready** and **Alarm** LEDs) turns on as an additional alert.

SIMs are classified according to severity for reporting and logging purposes: service, moderate, serious, or acute. All SIMs are logged on the SVP and reported to Command View (**Device Health** tab). During CA operations, the MCU and RCU generate a service SIM each time the pair status of the P-VOL or S-VOL changes for any reason, including normal status transitions (for example, COPY to PAIR). SIMs generated

by the MCU include the P-VOL device ID (byte 13). SIMs generated by the RCU include the S-VOL device ID (byte 13).

If SIM will result in an SNMP trap being sent to the appropriate hosts.

---

## Pinned track recovery for CA volumes

If a pinned track occurs on a CA P-VOL or S-VOL, the MCU suspends the pair (SIM reference code = DB1x).

To ensure full data integrity of the volume pair while recovering the pinned track, use the following procedure:

1. Connect to the MCU of the CA pair containing the volume with the pinned track, and select the correct CU image.
2. Delete the CA pair (pairsplit-S) containing the volume with the pinned track.



**NOTE:** If you delete the CA Asynchronous volume pair, delete only the pair containing the volume with the pinned track. To do this, select **LU** for **Asynchronous Parameters**, and click **Delete Range**.

3. If the volume is offline (for example, S-VOL has a pinned track), vary the volume online.
4. Perform your usual procedure for recovering data from a pinned track. See the pinned track recovery procedures for your operating system, or contact your HP account csupport representative for assistance in recovering the pinned track.
5. If the volume was previously offline (for example, S-VOL), vary the volume offline again.
6. Restart the volume pair using the **Paircreate** command from the **Pair Operation** tab of the CA main pane. From the Paircreate Parameter pane, select **Entire** for the **Method** field of the **Initial copy parameter** (see "[Creating CA volume pairs \(Paircreate\)](#)" on page 565).



# 25 Continuous Access XP Journal

This chapter covers the following topics:

- "Overview of copy solutions" on page 591
- "Overview of CA Journaling" on page 592
- "CA Journaling operations requirements and restrictions" on page 614
- "Configuring disk arrays and logical paths" on page 634
- "Using journal groups" on page 647
- "Performing CA Journaling pair operations" on page 662
- "Monitoring remote copy operations" on page 678
- "Viewing history of data volume pair operations" on page 682
- "Performing optional operations" on page 686
- "Disaster recovery operations" on page 689
- "Troubleshooting" on page 691
- "Power management for disk arrays and network relay devices" on page 698
- "Pinned track recovery for CA Journaling volumes" on page 701

---

## Overview of copy solutions

### Continuous Access XP Journal (CA Journaling)

You can use HP Continuous Access XP Journal (CA Journaling) to create and maintain duplicate copies of all user data stored on the distant local disk array for data duplication, backup, and disaster recovery purposes. This enables you to recover valuable data and protect it from the disaster, such as an earthquake, a fire, or system failure. CA Journaling for UNIX® or PC server uses an asynchronous copy mode to accommodate a wide variety of user requirements and data copy/movement scenarios. CA Journaling provides a superior hardware-based solution for data duplication, data migration, remote copy, and disaster recovery tasks.

CA Journaling operations are nondisruptive and allow the primary data volume of each CA Journaling volume pair to remain online to all hosts for both read and write I/O operations. Once established, CA Journaling continues unattended to provide continuous, real-time data backup. By establishing primary and secondary data volumes on different disk arrays, you can perform asynchronous operations remotely. For fibre-channel direct connections, you can perform CA Journaling operations across distances of up to 30 km (18.6 miles) using single-mode longwave optical fibre cables in a switch configuration.

When CA Journaling is used, data to be copied is temporarily stored in a journal volume, which is a type of logical volume. You can use CA Journaling to configure and manage highly reliable data replication systems using journal volumes to reduce the possibility of copy operations suspension. Copy operations can be suspended due to restrictions on data transfers from the primary site to the secondary site.

You can perform CA Journaling operations with Business Copy XP operations (see [“Business Copy XP and ShadowImage for z/OS”](#) on page 592) to provide multiple internal copies of CA Journaling volumes. CA Journaling also supports the local disk array’s custom volume and HP Cache LUN XP features, allowing CA Journaling to meet a variety of user needs and facilitates data copying and migration. See [“Combining CA Journaling with other data management operations”](#) on page 627 for more information.

Command View XP displays detailed CA Journaling information and provides options for configuring and performing CA Journaling operations. Command View XP communicates with the local disk array’s SVP through defined TCP/IP connections. If a system failure or disaster occurs at the primary site, Command View XP simplifies and expedites disaster recovery procedures.

This chapter describes and provides instructions for using the licensed Command View XP to perform CA Journaling operations. You can also use RAID Manager to perform CA Journaling operations from the UNIX or PC server host.

## Business Copy XP and ShadowImage for z/OS

You can use Business Copy XP and ShadowImage for z/OS data duplication features to set up and maintain multiple copies of logical volumes within the same local disk array. Business Copy XP operations for UNIX/PC server-based data can be performed using the licensed Business Copy XP or RAID Manager on the UNIX/PC server host. ShadowImage for z/OS operations can be performed using the ShadowImage for z/OS and can also be managed using TSO and/or ICKDSF commands.

RAID-protected Business Copy XP duplicates are created within the same local disk array at hardware speeds. You can use Business Copy XP with CA Journaling to maintain multiple copies of critical data at primary and/or secondary sites and provide maximum flexibility in data backup and duplication activities. See [“Combining CA Journaling and Business Copy XP”](#) on page 628 for more information.

This chapter does not cover Business Copy XP operations. For information and instructions on performing Business Copy XP operations, see [“Business Copy \(BC\) for the XP128/XP1024/XP12000”](#) on page 413 or contact your HP account support representative.

## Continuous Access XP and TrueCopy for z/OS

You can use the Continuous Access XP and TrueCopy for z/OS data duplication features to create copies of logical volumes in two different disk arrays at remote locations. Continuous Access XP operations for UNIX/PC server-based data can be performed using the licensed Continuous Access XP or RAID Manager on UNIX/PC server host. TrueCopy for z/OS operations can be performed using TrueCopy for z/OS and can also be managed using TSO and/or ICKDSF commands.

Continuous Access XP provides synchronous (Continuous Access XP) and asynchronous (Continuous Access XP Extension) copy modes. Continuous Access XP (synchronous) provides volume-based, real-time data backup. Continuous Access XP Extension (asynchronous) provides volume-based, data backup at another time from the host-requested write operation to prevent an increase in the response time to the host. Continuous Access XP (synchronous) operations support the disaster recovery system by a three data center (3DC) configuration with CA Journaling operations. See [“Combining CA Journaling with Continuous Access XP \(3DC configuration\)”](#) on page 630 for more information.

This chapter does not cover Continuous Access XP operations. For information and instructions on performing Continuous Access XP operations, see [“Continuous Access \(CA\) for the XP128/XP1024/XP12000”](#) on page 485 or contact your HP account support representative.

---

## Overview of CA Journaling

CA Journaling provides a RAID storage-based hardware solution for disaster recovery that enables fast and accurate system recovery. After CA Journaling operations are established, duplicate copies of data are automatically maintained for backup and disaster recovery purposes. During normal CA Journaling operations, primary data volumes remain online to all hosts and continue processing read and write I/O

operations. If a disaster or system failure occurs, the secondary copy of data can be rapidly invoked to allow recovery with a very high level of data integrity. You can also use CA Journaling for data duplication and migration tasks.

CA Journaling represents a unique and outstanding disaster recovery solution for large amounts of data spanning multiple volumes. CA Journaling's group-based, update sequence consistency solution enables fast and accurate database recovery, even after a "rolling" disaster, without requiring time-consuming data recovery procedures. You can recover CA Journaling's journal groups (volume groups) at the secondary site with full update sequence consistency, but updates are behind the primary site due to asynchronous remote copy operations.

CA Journaling provides update sequence consistency for user-defined journal groups (for example, large databases) and protection for write-dependent applications if a disaster occurs.

When CA Journaling is used, data to be copied is temporarily stored in a journal volume, which is a type of logical volume. You can use CA Journaling to configure and manage highly reliable data replication systems using journal volumes to reduce the possibility of copy operations suspension. Copy operations can be suspended due to restrictions on data transfers from the primary site to the secondary site.

## Functionality

You can use CA Journaling to create duplicate volumes by copying data from primary data volumes in the primary disk array to secondary data volumes in the secondary disk array at the remote location. To duplicate volumes, perform the following steps sequentially with the primary and secondary data volumes and the journal volumes:

- journal obtain function at the primary site
- journal copy function between the primary and secondary sites
- journal restore function at the secondary site

Write sequence consistency for the primary data volume at the primary site is also maintained for the secondary data volume at the secondary site by the write sequence number assigned for the journal data with the journal obtain function. Data integrity is maintained; concurrency is not maintained. CA Journaling reduces the occurrence of pair suspended status as a result of restrictions of data transfer from the primary site to the secondary site by storing write data from the host in the master and restore journal volumes and provides the high reliable duplication system.

Figure 336 provides an overview of CA Journaling operations.

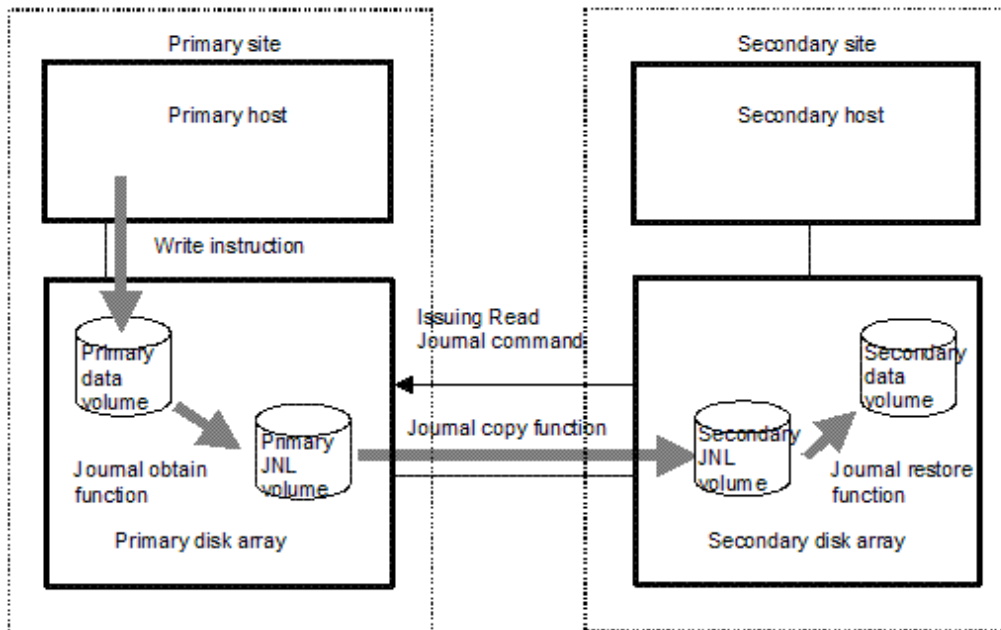

Figure 336 CA Journaling components for fibre-channel connections

## Journal obtain function

This function stores existing data in the primary data volume as a base-journal in the journal volume at the primary site. Then this function stores the write data as journal data in the journal volume every time the primary data volume is updated according to the write instruction from the host. The journal obtain operation is performed when a paircreate or pairresync operation command is issued from the primary site. The write sequence number from the host is assigned to the journal data. According to this information, the write sequence consistency at the secondary site can be maintained. The update data from the host is kept in cache. Therefore, the journal obtain function for the update data is performed at a different time than data from the host is received or data is stored on the data volume.

## Journal copy function

This function copies data in the master journal volume at the primary site to the restore journal volume at the secondary site. The secondary disk array issues the read journal command to the primary disk array to request a transfer of data stored in the master journal volume when a paircreate or pairresync operation command is issued on the primary site. The primary disk array transfers data in the journal volume to the secondary site according to the read journal command if it has journal data that should be sent. If the primary disk array does not have journal data, the information is sent. The secondary disk array stores the journal volume data sent from the primary site in the restore journal volume at the secondary site. Read journal commands are issued repeatedly and regularly from the secondary site to the primary site until the journal operation is stopped. After data is restored, its journal sequence numbers are returned from the secondary site to the primary site when the read journal command is issued. Based on this information, the journal data at the primary site is then discarded.

## Journal restore function

This function applies stored data in the restore journal volume to the secondary data volume at the secondary site. Data in the restore journal volume is restored to the secondary data volume according to the write sequence number. This ensures write sequence consistency between primary and secondary data volumes. After journal data is restored to the secondary data volume, journal data is discarded at the secondary site.



# Components

CA Journaling operations involve XP12000 disk arrays at the primary and secondary sites, physical communications paths between these disk arrays, and Command View XP. CA Journaling copies the original online data at the primary site to backup volumes at the secondary site through dedicated fibre-channel remote copy connections using a journal volume. You can operate CA Journaling with the user-friendly GUI environment using Command View XP.



**NOTE:** Host failover software is required for effective disaster recovery with CA Journaling.

Figure 337 shows CA Journaling components and their functions:

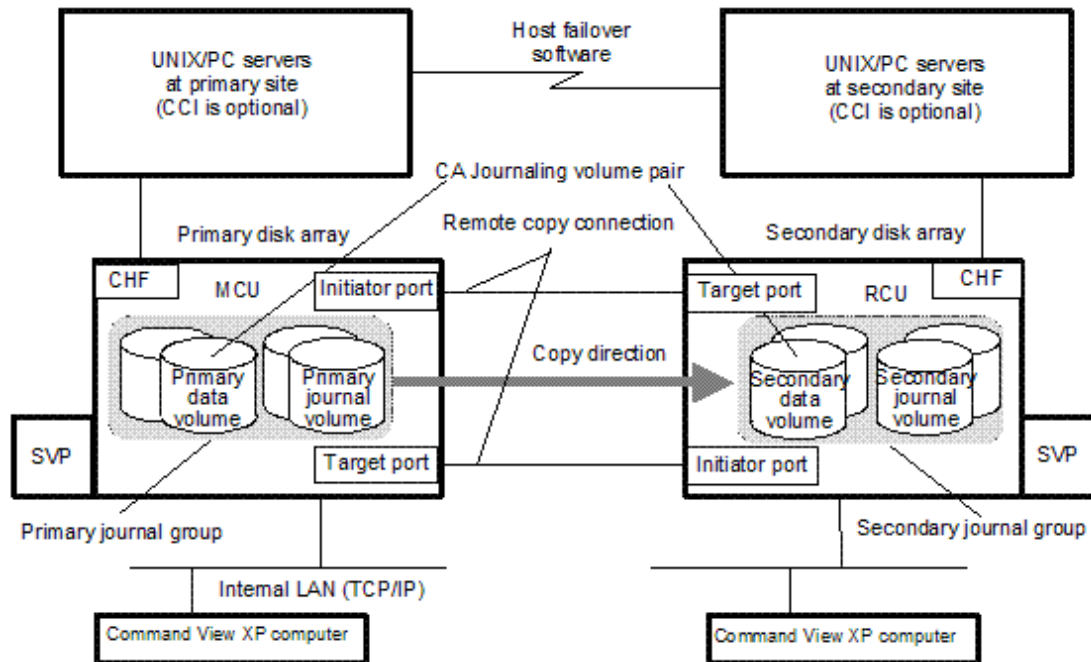

Figure 337 CA Journaling components

Figure 338 shows CA Journaling's connection configuration for multiple secondary disk arrays. By connecting one primary disk array with more than one secondary disk arrays, you can create a volume pair that has a one-to-one relationship for each journal group.

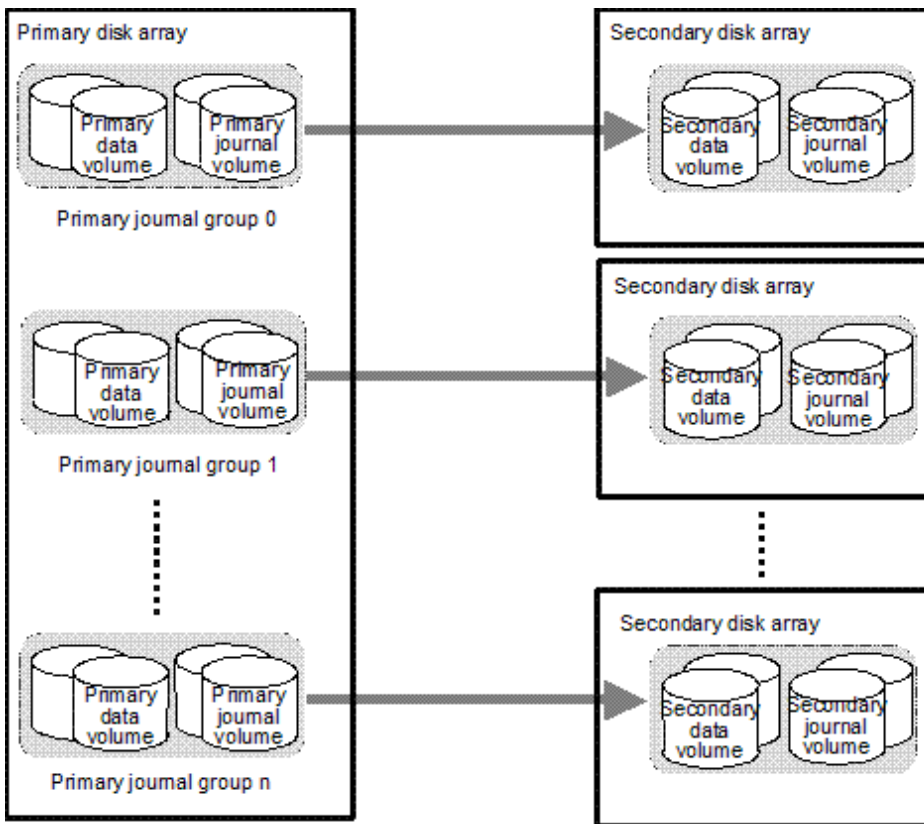

Figure 338 Connection configuration for multiple secondary disk arrays

## Local disk arrays

CA Journaling operations involve local disk arrays at the primary and secondary sites. The primary disk array consists of the main control unit (primary disk array) and SVP. The secondary disk array consists of the remote control unit (secondary disk array) and SVP.

Operational parameters, or optional modes, are available for the local disk array to provide greater flexibility and allow the XP12000 to be tailored to unique customer operating requirements. At installation, the XP12000 modes are set to their default values, so discuss these settings with your HP team. Only your HP representative can change the XP12000 modes.

## Main and remote control units (primary and secondary disk arrays)

The main control unit (primary disk array) and remote control unit (secondary disk array) control CA Journaling operations:

- The primary disk array is the control unit in the primary disk array that controls the primary data volume of the CA Journaling pairs and master journal volume. The Command View PC must be LAN-attached to the primary disk array. The primary disk array communicates with the secondary disk array through dedicated remote copy connections. The primary disk array controls host I/O operations to the CA Journaling primary data volume and the obtaining journal operation of the master journal volume as well as the CA Journaling initial copy and update copy operations between the primary data volumes and the secondary data volumes.
- The secondary disk array is the control unit in the secondary disk array that controls the secondary data volume of the CA Journaling pairs and restore journal volume. The secondary disk array controls copying of journals and restoring of journals to secondary data volumes. The secondary disk array assists in managing the CA Journaling pair status and configuration (for example, rejects write I/Os

to CA Journaling secondary data volumes). The secondary disk array issues the read journal command to the primary disk array and copies journals. The secondary Command View XP PC should be connected to the secondary disk arrays at the secondary site on a separate LAN. The secondary disk arrays should also be attached to a host system to report sense information if a problem with a secondary data volume or secondary disk array occurs and provide disaster recovery capabilities.

The XP12000 can function simultaneously as a primary disk array for one or more primary data volumes and as an secondary disk array for one or more secondary data volumes if the remote copy connections and fibre-channel interface ports are properly configured. You can use CA Journaling to specify the secondary disk array from the connected primary disk array. CA Journaling operations can be performed XP12000 Command View XP command device, see ["RAID Manager command devices"](#) on page 188



**NOTE:** When you configure a CA Journaling journal group pair, you must specify the serial numbers of the primary and secondary disk arrays. You must specify different serial numbers for the primary disk array and secondary disk array for the same CA Journaling journal group pair. If you must specify the same serial number, contact your HP account support representative.

---

## Journal groups

A journal group consists of two or more data volumes and journal volumes. You can use a journal group to tailor CA Journaling for your unique business content. The journal volume in the primary disk array is referred to as the master journal volume. The journal volume in the secondary disk array is referred to as the restore journal volume. The data volume in the master journal group is also called the primary data volume. The journal volume in the master journal group is called the master journal volume. The data volume in the restore journal group is similarly called the secondary data volume. The journal volume in the restore journal group is called the restore journal volume.

The data update sequence from the host is managed based on the journal group. The data update sequence consistency between the master and restore journal groups to be paired is maintained and ensured. The master and restore journal groups are managed based on the journal group number. The journal numbers of master and restore journal groups that are paired can be different. One data volume and one journal volume can belong to only one journal group.

## Data volume pairs

CA Journaling performs remote copy operations for data volume pairs that you create. Each CA Journaling pair consists of one primary data volume and one secondary data volume, which can be located in different disk arrays. CA Journaling primary data volumes are the primary volumes (LUs) containing the original data. CA Journaling secondary volumes are the secondary volumes (LUs) containing the backup or duplicate data. During normal CA Journaling operations, the primary data volume remains available to all hosts at all times for read and write I/O operations. During normal CA Journaling operations, the secondary disk array rejects all host-requested write I/Os for the secondary data volume. The secondary data volume write enable option allows write access to a secondary data volume while the pair is split and uses the secondary data volume and primary data volume track maps to resynchronize the pair (see ["Secondary data volume write option"](#) on page 604).

CA Journaling also supports custom volume and HP Cache LUN XP, which allows CA Journaling to meet a variety of user needs and allows data copying and data migration. This ensures that all user data can be backed up or duplicated. See ["Logical unit \(LU\) types"](#) on page 616 for more information about LU requirements and support.

## Journal volumes

When you use CA Journaling, updates to primary data volumes can be stored in other volumes, which are called journal volumes. Updates (which are sometimes referred to as update data) that will be stored in journal volumes are called journal data.

Because journal data will be stored in journal volumes, you can perform and manage highly reliable remote copy operations without suspension of remote copy operations. For example, even if a communications path between the primary disk array and secondary disk array fails temporarily, remote copy operations continue after the communications path is recovered.

If data transfer from hosts to the primary disk array is temporarily faster than data transfer between the primary disk array and secondary disk array, remote copy operations between the primary disk array and secondary disk array continue. Because journal volumes can contain more update data than cache memory can contain, remote copy operations continue if data transfer from hosts to the primary disk array is faster than data transfer between the primary and the secondary disk array for a relatively long period of time.

## Number of journal volumes

One journal group can contain up to 16 journal volumes. Each journal volume can have different volume sizes and RAID configurations. Journal data is stored sequentially and separately into each journal volume in the same journal group, and each journal volume is used equally.

## Journal volume specifications

- Logical units (LUs) types

The only DKU emulation type allowed for journal volumes is OPEN-V.

- Volumes and capacities

You can use custom volumes for journal volumes.

Journal volumes in the same journal group can have different capacities. A master journal volume and the corresponding restore journal volume can have different capacities.

A journal volume consists of two areas: one area is used to store journal data and the other area is used to store metadata for remote copy.

- RAID configurations

Journal volumes support all of the RAID configurations and physical volumes that the XP12000 supports.

Volumes in parity groups of RAID-5 (7D+1P) configuration are usually used as journal volumes.

- Support for option programs

You can use HP Cache LUN XP volumes for journal volumes.

### Journal volume restrictions on

- Registering and deleting journal volumes



**CAUTION:** You must register journal volumes in a journal group before you create a data volume pair for the first time.

---

You can register journal volumes in a journal group or delete journal volumes from a journal group only in one of the following occasions:

- When the journal group does not contain data volumes (for example, before you create a data volume pair for the first time in the journal group or after all data volume pairs are deleted)
- When all data volume pairs in the journal group are suspended

This means you cannot register or delete journal volumes when data copying is in progress (for example, when one or more data volume pairs exist).



**NOTE:** If a path is defined from a host to a volume, you cannot register the volume as a journal volume.

---

You can use Command View XP computers to register or delete journal volumes.

- Access from hosts to journal volumes

If a path is defined from a host to a volume, you cannot register the volume as a journal volume.

You cannot define paths from hosts to journal volumes. This means that hosts cannot read from and write to journal volumes.

### Journal volume areas

A journal volume consists of a metadata area and a journal data area. The ratio of the metadata area to the journal data area is the same on all journal volumes within the journal group.

Metadata that manages the journal data is stored in the metadata area. For more information about the metadata area, see [Table 114](#). Journal data that the metadata manages is stored in the journal data area.



**NOTE:** If the metadata or journal data cannot be stored for a given length of time because the metadata or journal data areas are full with metadata or journal data that has not been discarded, the pair is suspended. You can use Command View XP to specify this timeout period (Data overflow watch) as the parameter for the journal group (90 seconds is the default).

---

## Consistency groups

CA Journaling consistency group numbers are equivalent to Continuous Access XP Extension (asynchronous) consistency group numbers. Therefore, you can create an CA Journaling pair with consistency group numbers from RAID Manager as is the case with Continuous Access XP (asynchronous). In CA Journaling operations, consistency group numbers specified from RAID Manager are assigned to the journal group numbers.

Consistency group number specifications are different from journal group number specifications. One disk array has a total of 128 consistency groups for the primary and secondary data volumes (No. 0 to 127 are assigned).



**NOTE:** The consistency group number of the primary and secondary data volumes to be paired must be the same.



**NOTE:** When CA Journaling and Universal Replicator for z/OS coexist in the same local disk array, the consistency group number must be different than the Continuous Access XP Extension (asynchronous) consistency group number.

Figure 339 shows the corresponding numbers of a consistency group and journal group.

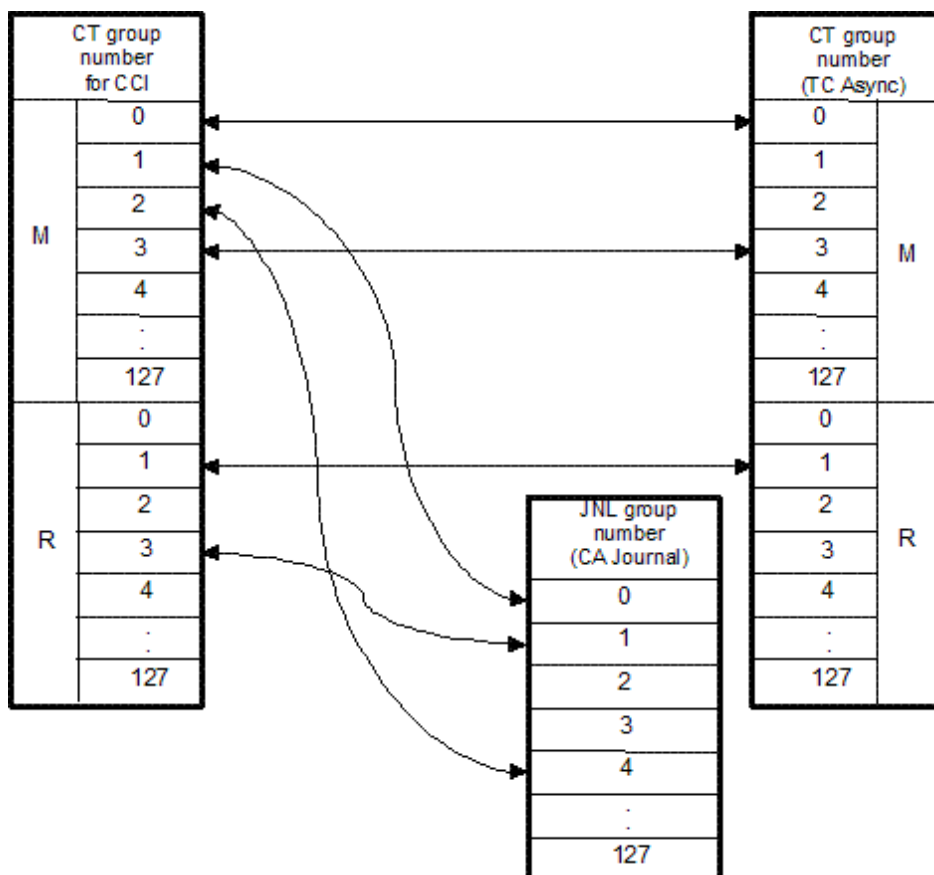

**Figure 339** Corresponding consistency group and journal group numbers

## Remote copy connections

Remote copy connections are the physical paths that primary disk arrays use to communicate with secondary disk arrays. Primary and secondary disk arrays are connected through fibre-channel interface cables. The maximum number of physical paths between disk arrays is 256.

When fibre-channel interface (optical multimode shortwave) connections are used, two switches are required for distances greater than 0.5 km (1,640 feet), and distances up to 1.5 km (4,920 feet, 0.93 miles) are supported. If the distance between primary and secondary sites is greater than 1.5 km, optical single-mode longwave interface connections are required. When fibre-channel interface (single-mode longwave) connections are used, two switches are required for distances greater than 10 km (6.2 miles), and distances up to 30 km (18.6 miles) are supported.

For long-distance connections support, see the *SAN Design Guide*.

See "[Remote copy connections](#)" on page 621 for more information about installing and configuring FC remote copy connections.

CA Journaling supports a 1-to-1 remote copy connection in one journal group pair. In one journal group pair, one primary disk array can be connected to only one secondary disk array. This configuration ensures the backup data consistency of two or more volumes (for example, large databases) within the same disk array. Connections must be established in a bidirectional fashion.



**NOTE:** HP strongly recommends you establish at least two independent remote copy connections (one per cluster) in each direction between each primary and secondary disk array to provide hardware redundancy for this critical communications path.

---

## Initiator ports and RCU target ports

Initiator and RCU target ports are required at the primary and secondary disk arrays. The initiator port at the primary disk array is connected to the RCU target port at the secondary disk array through the fibre channel interface. The initiator port at the secondary disk array is connected to the RCU target port at the primary disk array. The initiator port at the secondary disk array issues a read journal command to the primary disk array. In response to the read journal command, the RCU target port at the primary disk array sends journal data to the secondary disk array.

Any fibre-channel interface port of the XP12000 can be configured as an initiator port. Initiator ports cannot communicate with host HBAs. HBA paths must be connected to a fibre-channel interface port other than the initiator port.



**NOTE:** Two or more initiator ports must be configured before you can add secondary disk arrays and create CA Journaling volume pairs.

---

Fibre-channel interface ports assigned for RCU target ports can be connected to host HBAs through a fibre channel switch.

See "[Configuring port attributes](#)" on page 638 for more information about configuring host interface ports.

## CA Journaling Graphical User Interface

The Command View XP Java applet program product includes CA Journaling for the local disk array. The Command View software communicates with the each local disk array's SVP through defined TCP/IP connections.

The Command View XP PC at the primary site must be attached to the primary disk array. You should also attach a Command View XP PC at the secondary site to all secondary disk arrays. You can use the Command View XP PC at the secondary site to change the secondary disk array's CA Journaling parameter and access the CA Journaling secondary data volume (for example, for media maintenance). If you need to perform CA Journaling operations in the reverse direction from the remote site to the primary site (for example, disaster recovery), the Command View XP software simplifies and expedites this process.



**NOTE:** If the Command View PC is not installed, contact your HP account support representative for information about CA Journaling configuration services.

## Host failover software

Host failover software, which transfers applications between host servers at the primary and remote sites, is a critical component of any disaster recovery effort. Host failover is configured using the desired host failover software product for the platform (for example, HP Serviceguard), depending on your installation requirements and standards.

If you use CA Journaling as a data migration tool, host failover is recommended but not required. If you use CA Journaling as a disaster recovery tool, host failover is required to ensure effective disaster recovery operations. When a CA Journaling pair is suspended due to an error condition, the primary disk array generates sense information that should be transferred to the remote site using the host failover software for effective disaster detection and recovery.

## Remote copy operations

Figure 340 illustrates the types of CA Journaling remote copy operations: initial copy and update copy.

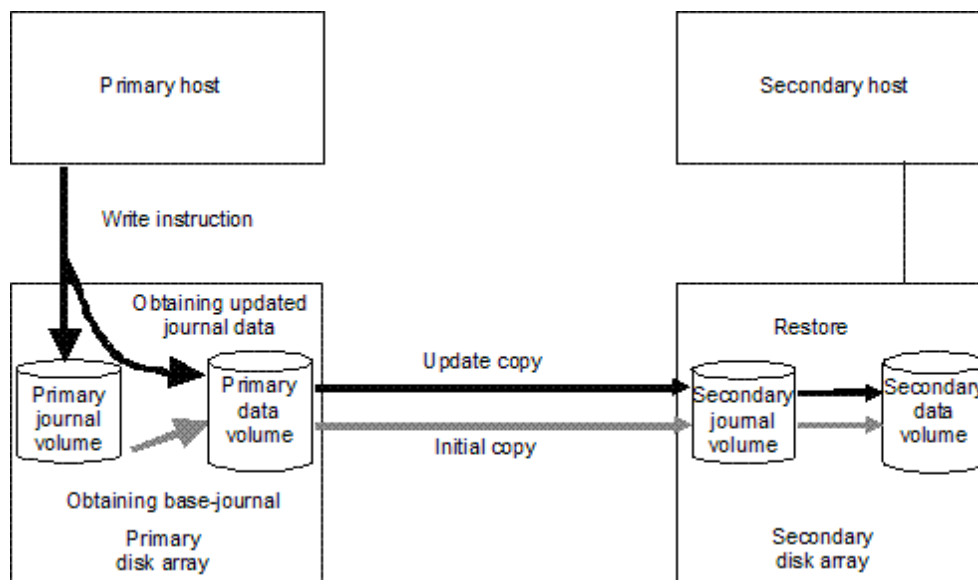

**Figure 340** Remote copy operations

## Initial copy operations

Initial copy operations synchronize data in the primary data volume and data in the secondary data volume. Initial copy operations are performed independently from host I/Os when you create a data volume pair or resynchronize a suspended pair. The initial copy operation copies base-journal data obtained from the primary data volume at the primary disk array to the secondary disk array, and then restores the base-journal to the secondary data volume.

If the journal-obtain operation starts at the primary data volume, the primary disk array obtains all data of the primary data volume as the base-journal data, in sequence. The base-journal contains a replica of the entire data volume or a replica of data volume updates. The base-journal is copied from the primary disk array to the secondary disk array after the secondary disk array issues a read-journal command. After a base-journal is copied to the secondary disk array, the base-journal is stored in a restore journal volume in a restore journal group to which the secondary data volume belongs. After that, data in the restore journal volume is restored to the secondary data volume, so data in the secondary data volume is synchronized with data in the primary data volume.



The base-journal data is stored in the entire data volume or the area for the difference. The area for the difference is used during differential resynchronization operation. The journal data for the entire data volume is created when the data volume pair is created. The difference journal data is obtained when the pair status of the data volume changes from **Suspending** to **Pairresync**. Merging the difference bitmaps recorded on the primary and secondary data volumes allows you to obtain differential journal data for only. When a data volume pair is suspended, the status of data that is updated from the host to the primary and secondary data volumes is recorded to the difference bitmap.

The base-journal data of the primary disk array is sent to the secondary disk array journal volume after a read command has been issued from the secondary disk array. After that, the base-journal data is restored from the journal volume to the secondary data volume. The initial copy operation finishes when all base-journals are restored.



**NOTE:** If you manipulate volumes (not journal groups) to create or resynchronize two or more data volume pairs within the same journal group, the base journal of one pair is stored in the restore journal volume, and then the base journal of another pair is stored in the restore journal volume. Therefore, the operation for restoring the latter base journal is delayed.



**NOTE:** You can specify **None** as the copy mode for initial copy operations. If the **None** mode is selected, initial copy operations are not performed. You are responsible for using the **None** mode only when you are sure that data in the primary data volume is exactly the same as data in the secondary data volumes.

---

## Update copy operation

The primary disk array obtains update data that the host writes to the primary data volume as *update journals*. Update journals are stored in journal volumes in the journal group to which the primary data volume belongs. When the secondary disk array issues read journal commands, update journals are copied from the primary disk array to the secondary disk array asynchronously with completion of write I/Os by the host. Update journals copied to the secondary disk array are stored in journal volumes in the journal group to which the secondary data volume belongs. The secondary disk array restores the update journals to the secondary data volumes in the order write I/Os are made, so the secondary data volumes are updated just like the primary data volumes are updated.

## Read and write I/O operations during CA Journaling operations

When a primary disk array receives a read I/O for a CA Journaling primary data volume, the primary disk array performs the read from the primary data volume. If the read fails, the redundancy provided by RAID-1 or RAID-5 technology recovers the failure. The primary disk array does not read the CA Journaling secondary data volume for recovery.

When a primary disk array receives a write I/O for a primary data volume with PAIR status, the primary disk array performs the update copy operation and writes to the primary volume.

The primary disk array completes the primary data volume write operations independently of the update copy operations at the secondary data volume. The secondary disk array updates data in the secondary data volume according to the write sequence number of journal data. This maintains data consistency between the primary and secondary data volumes. If the primary data volume write operation fails, the primary disk array reports a unit check and does not create journal data for the operation. If the update copy operation fails, the secondary disk array suspends either the affected pair or all CA Journaling pairs in the journal group, depending on the failure type. When the suspended CA Journaling pair or journal group is resumed (pairresync), the primary and secondary disk arrays negotiate the pair resynchronization. See "[CA Journaling suspend types](#)" on page 612 for more information.

The secondary disk array does not allow a CA Journaling secondary data volume to be online (mounted) during normal CA Journaling operations and rejects all host-requested write I/O operations for a

secondary data volume. The CA Journaling secondary data volume write enable option allows write access to a secondary data volume while the pair is split (see “[Secondary data volume write option](#)” on page 604). The secondary data volume write option can only be enabled when you split the pair from the primary disk array.



**NOTE:** To reduce the overhead associated with remote copy activities and maximize data transfer, the local disk array uses a special write command that is allowed only for CA Journaling initial and update copy operations. This command transfers control parameters and FBA-format data for consecutive updated records in a track using a single write operation. The special CA Journaling write command eliminates the overhead required for performing FBA-to-CKD and CKD-to-FBA conversions.

## Secondary data volume write option

For additional flexibility, CA Journaling provides a secondary data volume write option (S-Vol. Write) that enables write I/Os to the secondary data volume of a split CA Journaling pair. You can select the secondary data volume write option during the pairsplit-r operation, and it applies only to the selected pairs. The secondary data volume write option can be accessed only when you are connected to the primary disk array. When you resync a split CA Journaling pair that has the secondary data volume write option enabled, the secondary disk array sends the secondary data volume track bitmap to the primary disk array, and the primary disk array merges the primary and secondary data volume bitmaps to determine which tracks are out-of sync. This ensures proper pair resynchronization.

## Difference management

Differential data (updated by write I/Os during split or suspension) between the primary and secondary data volumes is stored in each track bitmap. When a split/suspended pair is resumed (pairresync), the primary disk array merges the primary and secondary data volume bitmaps, and differential data is copied to the secondary data volume.



**NOTE:** The number of bitmap areas affects the maximum number of pairs that can be created in the disk array. For more information, see “[Maximum number of pairs](#)” on page 617.

## Journal processing

CA Journaling journal data contains primary data volume updates and metadata information (associated control information), which enables the secondary disk array to maintain update consistency of the CA Journaling secondary data volumes.

### Creating and storing journals at primary disk arrays

When a primary disk array performs an update (host-requested write I/O) on a CA Journaling primary data volume, the primary disk array creates journal data that is transferred to that secondary disk array. Journal data is stored in CA Journaling cache as journal cache or journal data depending on the amount of data in cache. If available CA Journaling cache memory is low, journal data is stored in the journal volume. Metadata information is attached to journal data (see [Table 114](#)). When the base-journal is obtained, only metadata information is created and stored in CA Journaling cache or the journal volume.

**Table 114** Metadata information

Type	Description
Journal type	Journal type (for example, base-journal or update journal)
LDEV No. (data)	Number of the primary data volume that stores the original data

**Table 114** Metadata information (continued)

Type	Description
Original data storing position	Primary data volume's slot number and start and end of sub-block number (data length)
LDEV No. (journal)	Volume number of the master journal volume that stores the journal data
Journal data storing position	Master journal volume's slot number of master journal volume, and start sub-block number
Journal sequence number	Sequence number assigned when the journal is obtained
Timestamp	Time when journal data is obtained

The journal sequence number indicates the primary data volume write sequence that the primary disk array created for each journal group. Journal data is transferred to the secondary disk array asynchronously with the host I/O. The secondary disk array updates the secondary data volume in the same order as the primary data volume according to the sequence number information in the journal.



**NOTE:** CA Journaling processing continues uninterrupted if the SVP reboots or fails.

### Copying journals to secondary disk arrays

When a primary disk array receives a read journal command from a secondary disk array, the primary disk array sends journal data to the secondary disk array. The secondary disk array's initiator ports act as host and issue special I/O operations, called remote I/Os (RIOs), to the primary disk array. The RIO transfers journal data in FBA format (not CKD) using a single channel command, eliminating the overhead associated with FBA-CKD conversion and, therefore, efficiently transferring journal data. The primary disk array can send several journal data using a single RIO, even if their sequence numbers are not contiguous. Therefore, journal data is usually sent to the secondary disk array in a different order than arrivals at the primary disk array. The secondary disk array ensures that journal data is applied to the secondary data volume in the correct sequence. This method of remote I/O provides the most efficient use of primary disk array-to-secondary disk array link resources.



**NOTE:** Ensure that the channel extenders are capable of supporting remote I/O. For more information, contact your HP account support representative.

### Storing journals at secondary disk arrays

A secondary disk array receives journal data transferred from a primary disk array according to the read journal command. Received journal data is stored in CA Journaling cache as the journal cache or journal data depending on the amount of data in cache. If available CA Journaling cache memory is low, journal data is stored in the restore journal volume.



**NOTE:** The primary disk array does not remove target journal data from its master journal volume until it receives the sequence numbers of the restored journal. The sequence numbers of restored journals are sent to the primary disk array as part of the read journal command from the secondary disk array. This is true even if the primary and secondary disk arrays are connected through a channel extender product.

## Selecting and restoring journals at secondary disk arrays

The secondary disk array selects journal data to be promoted to formal data (or restored) as follows:

1. The secondary disk array uses a number as management information to distinguish the journal data arrival from the primary disk array. If the number is 1, journal data arrived at the secondary disk array. If the number is 0, journal data has not arrived yet. The secondary disk array determines whether or not journal data should be settled according to this number. If journal data has not arrived yet, the secondary disk array waits for the journal data.
2. When the top of the journal group queue indicates journal data has arrived, the secondary disk array selects the journal data that has the lowest sequence number, and settles that journal data.
3. The secondary disk array repeats [step 1](#) and [step 2](#) to select and settle journal data.

[Figure 341](#) illustrates journal data selection and settling at the secondary disk array. This diagram shows that journal data S1 arrived at the secondary disk array because the management information indicates 1. The secondary disk array selects journal data S1 to be settled, because S1 is the lowest sequence number. When S1 is removed from the sequence number queue, journal data S2 becomes the top entry, but it has not arrived yet. The management information of journal data S2 is 0. The secondary disk array waits for journal data S2. When journal data S2 arrives, the secondary disk array selects S2 as the next journal data to be settled. The journal data the secondary disk array selects is marked as “host-dirty” and treated as formal data.

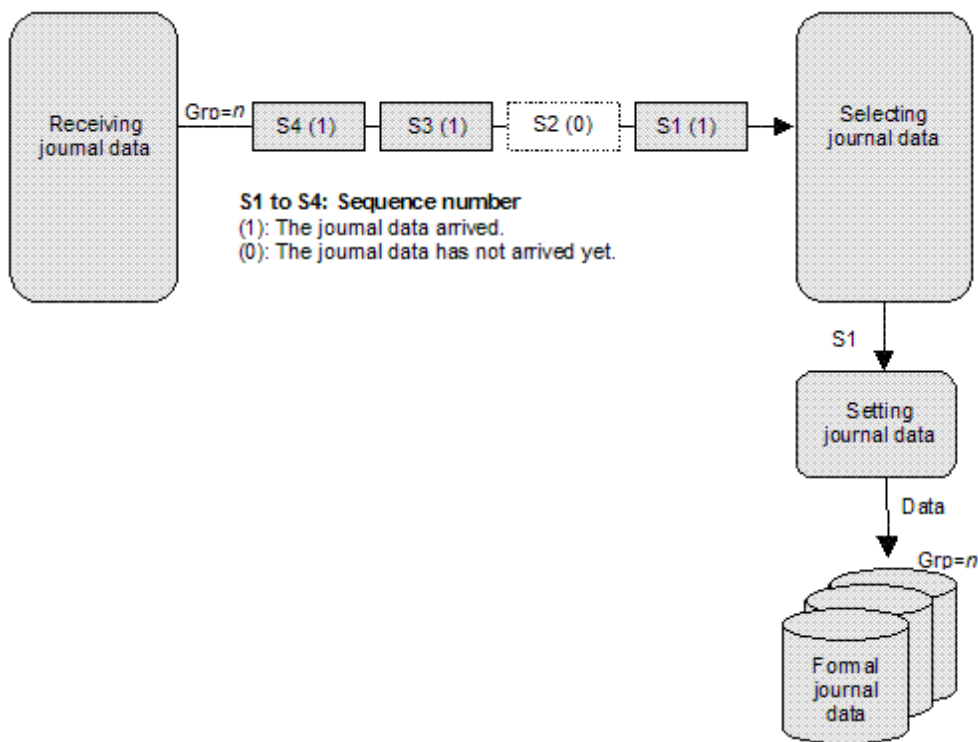

**Figure 341** Selecting and settling journal at secondary disk array

The secondary disk array settles and restores journal data to the secondary data volume as follows:

- Journal data stored in the journal cache of journal cache
  - If the corresponding track is in cache (track-hit), the journal cache is copied to the corresponding cached track and promoted to formal data. Cache space for the journal cache is released.
  - If the corresponding track is not in cache (track-miss), the secondary disk array changes the cache designation of journal cache to formal data. Data is not physically moved.

- Journal data stored in the restore journal volume

Journal data is read from the restore journal volume to cache. Journal data that is read to cache is copied to the existing cache track and promoted to formal data. After that, the space for the restore journal volume is released.

## Journal types

In addition to journal data for updating, the primary disk array sends control information to the secondary disk array. This control information indicates when volume pair status changes and when a primary disk array power-off sequence is initiated, and maintains sequence numbers in periods of low host activities.

## Inflow control for journal cache

You can use CA Journaling to specify the usage rate of *journal cache*, which is used for CA Journaling processing. Journal cache stores journal data to be transferred to the secondary disk array asynchronously with host write I/Os to primary data volumes. Usually, journal data is stored in journal volumes before journal cache becomes full. If hosts transfer excessively increasing amounts of data, journal cache might become full. If journal cache remains full for a specified time period, the journal group is suspended due to a failure. You can specify the time period using the **Cache Overflow Watch** option.

The disk array uses the following parameters to control data inflow into journal cache:

- **Journal cache capacity:** Indicates maximum usage rate for cache that can be used for CA Journaling processing and is installed in the primary or secondary disk array. This parameter can be 0 to 50 percent for primary disk arrays, and 0 to 100 percent for secondary disk arrays.
- **Cache overflow watch:** If journal cache remains full for the time period specified by the **cache overflow watch** parameter, the journal group is suspended due to a failure. This parameter can be 0 to 90 seconds.

If the amount of data in journal cache in the primary disk array reaches the specified **journal cache capacity**, disk array I/Os are delayed. If journal cache remains full for the time period specified by the **cache overflow watch** parameter, the primary disk array suspends the affected journal groups due to a failure.

If the amount of data in journal cache in the secondary disk array reaches the specified **journal cache capacity**, the secondary disk array stores received journal data in the restore journal volume, and issues the next read-journal command to the primary disk array. This prevents an increase in the cache usage rate.

## Journal group operations

CA Journaling journal groups maintains update sequence consistency across a journal group of volumes. The primary and secondary data volumes of the pairs in a journal group must be located within one physical primary disk array and one physical secondary disk array (1-to-1 requirement).

When more than one data volume is updated, the order data volumes are updated is managed within the journal group to which the data volumes belong. Data update consistency is maintained among paired journal groups. CA Journaling uses journal groups to maintain data consistency among data volumes.

CA Journaling provides the following group-based operations to simplify and expedite disaster or failure recovery procedures:

- Group operations at the primary disk array
  - Split all pairs in a journal group. See "[Splitting mirrors \(Pairsplit-r: suspending copy operations\)](#)" on page 659 for a description of the **Suspend Range-Group** pairsplit option.
  - Resume all suspended pairs in a journal group. See "[Restoring mirrors \(Pairresync: resuming copy operations\)](#)" on page 660 for a description of the **Resume Range-Group** pairresync option.

- Delete all pairs in a journal group. See “[Deleting data volumes from mirrors \(Pairsplit-S: ending copy operations\)](#)” on page 661 for a description of the **Delete Range-Group** pairdelete option.
- Group operations at the secondary disk array
  - Split (pairsplit-r) all pairs in a journal group. See “[Splitting mirrors \(Pairsplit-r: suspending copy operations\)](#)” on page 659 for a description of the **Suspend Range-Group** pairsplit-r option.
  - Delete (pairsplit-S) all pairs in a journal group regardless of their consistency status. See “[Deleting data volumes from mirrors \(Pairsplit-S: ending copy operations\)](#)” on page 661 for a description of the **Delete Range-Group** pairsplit-S option.

## CA Journaling data volume pair status

CA Journaling displays the pair status for each data volume of a specified CU Image (CUI) in the connected local disk array. [Table 115](#) lists and describes the CA Journaling data volume pair statuses. The primary disk array maintains the primary data volume’s status and can change the pair status of the primary and secondary data volumes. The secondary disk array maintains the secondary data volume’s status and can change the pair status of the primary and secondary data volumes, but not the primary data volume. The primary disk array detects when the secondary disk array changes the secondary data volume’s status (if the path status is normal) and changes the primary data volume’s status accordingly. You can display detailed pair status information at the Command View PC (CA Journaling Pairdisplay pane) or UNIX/PC server host (RAID Manager Pairdisplay command).

A volume that is not assigned to a CA Journaling data volume pair has the status **SMPL**. When a CA Journaling data volume pair is started, the primary disk array changes the status of the primary and secondary data volumes to **COPY**. When the initial copy operation is complete, the primary disk array changes the status of both data volumes to **PAIR**. When a pair is suspended due to an error condition, the primary disk array changes the status of the primary and secondary data volumes to **PSUE** (if the path status is normal). When you split a CA Journaling pair (pairsplit-r), the primary disk array or secondary disk array changes the status of the primary and secondary data volumes to **PSUS** (if the path status is normal). When a pair is split from the secondary disk array, the secondary disk array changes the secondary data volume’s status to **PSUS**, and the primary disk array detects the pair deletion (if path status is normal) and changes the primary data volume’s status to **PSUS**. When a pair is deleted from the primary disk array, the primary disk array changes the status of both data volumes to **SMPL**. When a pair is deleted from the secondary disk array, the secondary disk array changes the secondary data volume’s status to **SMPL**, and the primary disk array detects the pair deletion (if path status is normal) and changes the primary data volume’s status to **PSUS**.

When a CA Journaling data volume pair is split or suspended, the primary disk array generates a service information message (SIM) to notify the hosts. If SNMP is installed and operational for Command View XP, this SIM results in an SNMP trap indicating the reason for the suspension.

- CA Journaling pair status

The CA Journaling Suspending and Deleting transitional states occur when a request to change CA Journaling pair status has been accepted, but the requested status change (PSUS, PSUE, or SMPL) is not complete yet. These states are not reported to the host. For Suspending, either you or the primary disk array can request the status change. For Deleting, only you can request the status change. If you requested the status change, the final status is reported at the end of the transition. If an error caused the status to change to PSUE, the suspended status is reported at the beginning of the transition.

After a disk array receives a request to split or delete a pair in **Flush** mode, the status of the pair remains **Suspending** or **Deleting** until the journal in the master journal group is restored in the restore journal group and the pair is completely split or deleted. To calculate the time during which the pair remains **Suspending** or **Deleting**, use the following equation:

$$C \times (u \div 100) \times 1,024 \div V \text{ (The unit is seconds)}$$

where:

- **C** is the total capacity (in megabytes) of the master journal volume.

- **u** is the data usage rate (as a percentage) in the master journal volume.
- **V** is the data transfer speed between the primary and secondary disk array. The unit is MB/s (megabytes per second).

To find the usage rate of a journal volume, use the monitoring feature (see “[Monitoring remote copy operations](#)” on page 678).

**Table 115** CA Journaling data volume pair status

Pair Status	Description	Primary Data Volume Access	Secondary Data Volume Access
SMPL (simplex)	Volume is not currently assigned to a CA Journaling data volume pair and does not belong in the journal group. When this volume is added to a CA Journaling data volume pair, its status changes to COPY.	Read / Write	Read / Write
COPY	Initial copy operation for pair is in progress. Data volume pair is not yet synchronized. When the initial copy is complete, the status changes to PAIR.	Read / Write	Read Only
PAIR	Data volume pair is synchronized. Updates to the primary data volume are duplicated on the secondary data volume.	Read / Write	Read Only
PSUS (pair suspended-split) (see <a href="#">Table 116</a> for split types)	<p>Data volume pair is not synchronized because you split this pair (pairsplit-r) or deleted this pair from the secondary disk array (pairsplit-S). For CA Journaling pairs, the primary and secondary disk arrays keep track of any journal data discarded during the pairsplit-r operation. While a pair is split, the primary and secondary disk arrays keep track of the updated primary and secondary data volume tracks.</p> <p>When you split a pair from the primary disk array, the primary disk array changes the status of the primary and secondary data volumes to PSUS. When you split a pair from the secondary disk array, the secondary disk array changes the secondary data volume’s status to PSUS. The primary disk array detects this (if path status is normal) and changes the primary data volume’s status to PSUS.</p> <p>When you delete a pair from the secondary disk array, the secondary disk array changes the secondary data volume’s status to SMPL. The primary disk array detects this (if path status is normal) and changes the primary data volume’s status to PSUS. You must delete the pair from the primary disk array to change the primary data volume’s status to SMPL.</p>	Read / Write	Read Only; Read / Write, if write option is enabled (“Disable” is the default).

**Table 115** CA Journaling data volume pair status (continued)

Pair Status	Description	Primary Data Volume Access	Secondary Data Volume Access
<p>PSUE (pair suspended-error) (see <a href="#">Table 118</a> for suspend types)</p>	<p>Data volume pair is not synchronized because the primary or secondary disk array suspended the pair due to an error condition. For CA Journaling pairs, the primary and secondary disk arrays keep track of any journal data discarded during the suspension operation. The primary disk array keeps track of updated primary data volume tracks while the pair is suspended.</p> <p>For CA Journaling pairs, if the primary disk array detects a CA Journaling suspension condition (see "<a href="#">CA Journaling suspension condition</a>" on page 613), the primary disk array changes the secondary data volume's status to PSUE.</p> <p>For CA Journaling pairs, if the primary disk array detects a CA Journaling suspension condition (see "<a href="#">CA Journaling suspension condition</a>" on page 613), the secondary disk array changes the secondary data volume's status to PSUE. The primary disk array detects this (if path status is normal) and changes primary data volume's status to PSUS.</p>	<p>Read/write; Read only if fenced.</p>	<p>Read Only</p>
<p>PFUL</p>	<p>CA Journaling monitors the total amount of data in the journal volume. If the amount of data exceeds the threshold (95% to 99%), the pair status changes from COPY or PAIR to PFUL. The write data that inflows is monitored during the specified time (Data Overflow Watch). You can use Command View XP to set the monitoring time period (the default is 90 seconds).</p>	<p>Read / Write</p>	<p>Read Only</p>
<p>PFUS</p>	<p>If the time period exceeds the specified monitoring time period, the pair status changes from PFUL to PFUS, and the pair is suspended.</p>	<p>Read / Write</p>	<p>Read Only; Read / Write, if write option is enabled ("Disable" is the default).</p>
<p>SSWS</p>	<p>Data can be written to the secondary data volume that is reassigned from the primary data volume during resynchronization processing (Takeover).</p>	<p>Read Only</p>	<p>Read / Write</p>
<p>Suspending</p>	<p>Pair is not synchronized and is in transition from PAIR or COPY to PSUS/PSUE. When the split/suspend pair operation is requested, the status of all affected pairs changes to <b>Suspending</b>. When the split/suspend operation is complete, the status changes to PSUS/PSUE.</p>	<p>Read / Write</p>	<p>Read Only</p>
<p>Deleting</p>	<p>Pair is not synchronized and is in transition from PAIR, COPY, or PSUS/PSUE to SMPL. When the pairsplit-S operation is requested, the status of all affected pairs changes to <b>Deleting</b>. When the pairsplit-S operation is complete, the status changes to SMPL.</p>	<p>Read / Write</p>	<p>Read Only</p>



## CA Journaling split types (PSUS)

Table 116 describes CA Journaling split types. You can split a CA Journaling pair at any time after the initial copy operation is complete. You must split a CA Journaling pair to perform media maintenance on the primary data volume or access the secondary data volume (secondary data volume write enable).

When you split a CA Journaling pair, the primary and secondary disk arrays ensure synchronization by completing or discarding pending update copy operations according to the user-specified pending update option (purge/flush). The primary and secondary disk arrays keep track of journal data discarded during the pairsplit operation. After the pair status changes to PSUS, the primary disk array stops performing journal obtain operations for the pair, continues accepting write I/Os for the split CA Journaling primary data volume, and keeps track of primary data volume tracks that are updated while the pair status is split. If you enabled the secondary data volume write option when you split the pair, the secondary disk array keeps track of the secondary volume tracks that are updated while the pair is split. When the pair is resumed (pairsync), the secondary disk array sends the secondary data volume's track bitmap to the primary disk array, and the primary disk array merges the primary and secondary data volume bitmaps to determine which tracks are out-of-sync.

A split (or suspended) CA Journaling secondary data volume has an additional status called the consistency status. The consistency status is displayed only at the secondary disk array and indicates the update sequence consistency of the secondary data volume with respect to the other secondary data volume in the same group. Table 117 describes consistency statuses for split or suspended CA Journaling secondary data volumes (the consistency status is displayed only at the secondary disk array).

**Table 116** CA Journaling split types (PSUS)

Type	Applies to	Description
PSUS, P-VOL by Operator	Primary data volume	The secondary data volume's split type is <b>PSUS-by MCU</b> .
PSUS, S-VOL by Operator	Primary data volume, Secondary data volume	You split the pair from the primary or secondary disk array using the secondary data volume option.
PSUS, by MCU	Secondary data volume	The secondary disk array received a request from the primary disk array to split the pair. The primary data volume's split type is <b>PSUS-P-VOL by Operator</b> or <b>PSUS-S-VOL by Operator</b> .
PSUS, Delete pair to secondary disk array	Primary data volume	The primary disk array detected that the secondary data volume's status changed to <b>SMPL</b> because you deleted the pair (pairsplit-S) from the secondary disk array. The pair cannot be resumed because the secondary data volume does not have the <b>PSUS/PSUE</b> status.

**Table 117** Consistency status for split/suspended CA Journaling secondary data volumes

Consistency Status (displayed at secondary disk array)	Description
Volume	<p>The CA Journaling data volume pair was split or suspended alone. Update sequence consistency between the secondary data volume and other secondary data volume in this journal group is not ensured. You cannot use the secondary data volume for disaster recovery at the secondary site. This status is indicated when:</p> <ul style="list-style-type: none"> <li>You split the pair using the <b>Suspend Range-Volume (LU)</b> pairsplit option.</li> <li>The pair was suspended due to a failure that did not affect the entire journal group.</li> </ul>

**Table 117** Consistency status for split/suspended CA Journaling secondary data volumes (continued)

<b>Consistency Status (displayed at secondary disk array)</b>	<b>Description</b>
Group	<p>The CA Journaling data volume pair was split or suspended with the other pairs in its journal group. Update sequence consistency between the secondary data volume and other secondary data volume in the journal group is ensured. You can use the secondary data volume for disaster recovery at the secondary system (after deleting the CA Journaling data volume pair from the secondary disk array). This status is indicated when:</p> <ul style="list-style-type: none"><li>• You split the pair using the <b>Suspend Range-Group</b> pairsplit option.</li><li>• All pairs in this journal group were suspended due to a failure that affected the entire journal group, not just one pair (for example, a primary disk array-secondary disk array communication failure).</li><li>• One pair in the group was suspended due to a failure that did not affect the entire group.</li></ul>

## CA Journaling suspend types

Table 118 describes the CA Journaling suspend types, which indicate the reason for the suspension. CA Journaling pairs can be suspended by the primary or secondary disk array. For more information, see ["CA Journaling suspension condition" on page 613](#).

The primary disk array suspends a CA Journaling pair when it detects any of the following suspension conditions:

- You deleted the data volume pair from the secondary disk array
- An error condition related to the secondary disk array, secondary data volume, or CA Journaling update copy operation
- The primary disk array cannot communicate with the secondary disk array
- A CA Journaling suspension condition

When a CA Journaling pair is suspended, the primary disk array stops performing journal obtain operations for the pair. The primary disk array continues accepting write I/Os for the suspended primary data volume and keeps track of the primary data volume cylinders/tracks that are updated while the pair is suspended. The primary and secondary disk arrays also keep track of any recordsets discarded during the pair suspension. When the suspended CA Journaling pair is resumed (pairresync), the secondary disk array sends the secondary data volume's bitmap to the primary disk array, and the primary disk array merges the primary and secondary data volumes' bitmaps to determine which cylinders/tracks are out-of-sync. The primary disk array merges the primary and secondary data volumes' bitmaps to identify out-of-sync cylinders/tracks. This method ensures that all cylinders/tracks containing recordsets discarded at the secondary disk array are resynchronized at this time.

A split (or suspended) CA Journaling secondary data volume has an additional status called the consistency status. The consistency status is displayed only at the secondary disk array and indicates the update sequence consistency of the secondary data volume with respect to the other secondary data

volume in the same group. [Table 117](#) describes consistency statuses for split or suspended CA Journaling secondary data volumes (the consistency status is displayed only at the secondary disk array).

**Table 118** Suspend types (PSUE)

Type	Applies to	Description
PSUE by RCU	Primary data volume, Secondary data volume	The primary disk array detected an error condition at the secondary disk array that caused the primary disk array to suspend the CA Journaling data volume pair. The secondary data volume suspend type is PSUE-S-VOL Failure.
PSUE, S-VOL Failure	Primary data volume, Secondary data volume	The primary disk array detected an error during secondary disk array communications or during update copy. In this case, the secondary data volume suspend type is usually PSUE-S-VOL Failure.
PSUE, MCU IMPL	Primary data volume, Secondary data volume	The primary disk array could not find valid control information in its nonvolatile memory during IMPL. This condition occurs only if the primary disk array is without power for more than 48 hours (for example, a power failure and fully discharged backup batteries).
PSUE Initial Copy Failed	Primary data volume, Secondary data volume	The CA Journaling pair was suspended before the initial copy operation was complete. Data on the secondary data volume is not identical to data on the primary data volume.

## CA Journaling suspension condition

CA Journaling operations involve additional suspension conditions related to asynchronous journal operations. The primary and secondary disk arrays can detect CA Journaling suspension conditions and suspend CA Journaling pairs. The primary disk array stores the track bitmap per CA Journaling primary data volume in cache. The secondary disk array stores the track bitmap per CA Journaling secondary data volume in cache. When a CA Journaling pair is suspended, the tracks containing the following journal are marked in the track bitmap as modified (to be copied during the pairresync operation):

- Journal data the primary disk array has created, but has not sent to the secondary disk array yet  
After marking these primary data volume tracks as modified, the primary disk array discards the journal data.
- Journal data that has been sent to the secondary disk array, but the secondary disk array has not acknowledged  
After marking these primary data volume tracks as modified, the primary disk array discards the journal data. This ensures that journal data lost during transmission to the secondary disk array is identified and marked.
- Journal data that has reached the secondary disk array, but has not been restored yet  
After marking these primary data volume tracks as modified, the primary disk array discards the journal data. Therefore, the secondary disk array can check and mark journal data that has not been restored.  
  
The primary disk array does not discard journal data from the master journal volume until the primary disk array receives the restored journal volumes' sequence numbers, which are included in read journal commands from the secondary disk array.
- Primary data volume records updated by host-requested write I/Os after the pair was suspended

Table 119 describes CA Journaling suspension conditions and indicates which CU detects the condition and which pairs are suspended. See “[Displaying the History Operation pane](#)” on page 682 for troubleshooting information for CA Journaling suspension conditions.

**Table 119** CA Journaling suspension conditions

Suspension Condition	Detected by	CA Journaling Pairs to be Suspended
The secondary disk array could not copy the journal data successfully due to a hardware failure or logic error.	RCU	All CA Journaling secondary data volumes in the journal groups, or the affected secondary data volume
The secondary disk array detected a logical error while selecting the journal data to be restored.	RCU	All CA Journaling secondary data volumes in the journal group, or only the affected secondary volume
The secondary disk array could not restore the journal data due to a hardware failure, track condition, or logical error.	RCU	All CA Journaling secondary data volumes in the journal groups, or the affected secondary data volume

## CA Journaling operations requirements and restrictions

### System requirements

CA Journaling operations involve XP12000 primary and secondary disk arrays containing the primary and secondary volumes, the remote copy connections between the primary and secondary disk arrays, the hosts at the primary and remote sites, and the licensed CA Journaling. The CA Journaling system requirements are:

- Primary disk array: local disk array with CA Journaling installed
- Secondary disk array: local disk array with CA Journaling installed



**NOTE:** CA Journaling can coexist with Universal Replicator for z/OS in the same local disk array.



**NOTE:** The remote copy connection with the NAS interface is not supported.

- Remote copy connections: fibre channel (see “[Remote copy connections](#)” on page 600)
  - Multimode or single-mode optical fibre cables are required at the primary and secondary disk arrays.
  - For distance up to 0.5 km, multimode optical shortwave fiber cables are required between the primary and secondary disk arrays.
  - For distances from 0.5 km to 1.5 km (1,640 to 4,920 feet), multimode shortwave fibre-channel interface cables with up to two switches are required.
  - For distance up to 10 km, single optical longwave fiber cables are required between the primary and secondary disk arrays.

- For distances from 10 km to 30 km (6.2 to 18.6 miles), single-mode longwave fibre-channel interface cables with up to two switches are required.
  - For distances greater than 30 km (18.6 miles), approved third-party channel extender products and telecommunications lines are required. Long-distance CA Journaling solutions are provided based on user requirements and workload characteristics.
- Host platforms
- The XP12000 supports CA Journaling operations for a variety of UNIX-based and PC server platforms, including HP-UX 11.0, HP-UX 11i, Sun® Solaris® 9, Windows® 2000, Windows® 2003, and IBM® AIX® 5.1 platforms.
- Contact your HP account support representative for the latest information on platform support for CA Journaling.
- Command View XP software and CA Journaling license codes
- Command View XP is required for the CA Journaling graphical user interface. CA Journaling is a component of Command View XP. The CA Journaling license key codes are required to enable CA Journaling's options on the local disk array (see "[Enabling CA Journaling options](#)" on page 622). Separate license codes are required for each local disk array.



**NOTE:** Administrator or CA Journaling write access to Command View XP is required to perform CA Journaling operations. Users without Administrator or CA Journaling write access can only view CA Journaling information.

---

## One-to-one volume copy operations

CA Journaling requires a one-to-one relationship between the logical volumes of the volume pairs. A volume (LU) can only be assigned to one CA Journaling pair at a time.

---



**NOTE:** CA Journaling does not support operations in which one primary data volume is copied to more than one secondary data volume, or more than one primary data volume is copied to one secondary data volume.

---

Because CA Journaling operates on logical volumes rather than on files, multivolume files require special attention. For complete duplication and recovery of a multivolume file (for example, a large database file spanning several volumes), ensure that all volumes of the file are copied to CA Journaling secondary data volume, and use CA Journaling to ensure update sequence consistency across this group of secondary data volume.

## Logical unit (LU) types

Table 120 lists the DKC and DKU emulation types that can be used for CA Journaling.

**Table 120** Supported emulation types

Emulation	Support type
DKC	3990-6E, 2105, H-6591-C3
DKU (Drive)	Open-V
	<b>NOTE:</b> Only Open-V can be used for journal volumes.

CA Journaling displays emulation types of primary and secondary data volumes.

Table 121 lists the volumes and volume capacities that can be used for CA Journaling data volumes and journal volumes.



**NOTE:** The capacity of a journal volume is not included in the accounting capacity.

**Table 121** Supported Data Volume and Journal Volume

Type	Support specifications	
	Data Volume	Journal Volume
Custom volume	Available	
HP Cache LUN XP volume	Available	
Maximum volume capacity	Maximum capacity of volume for each emulation type	
Minimum volume capacity	Minimum capacity of a custom volume.	Minimum capacity of a custom volume.
		<b>NOTE:</b> A journal groups consists of areas containing journal data and an area containing metadata for remote copy.



**NOTE:**

- Only the volumes assigned to CLPR 0 can be used as data volumes or journal volumes.
- Specify a port in SLPR 0 when you use LUN Manager to define an LU path to a data volume. It is possible, but not recommended, that you specify a port in another SLPR when you define an LU path.
- For more information about CLPR 0 and SLPR 0, see ["Disk/Cache Partition for the XP12000"](#) on page 143.

Table 122 lists emulation types and capacities of logical volumes that can form pairs. For more information, see “Maximum number of pairs” on page 617.

**Table 122** Specifications for logical volumes that can form pairs

Item	Support specification
Emulation type	Same type of pair can be created for OPEN-V
Volume capacity	Same capacity

CA Journaling also supports the local disk array’s custom volume feature, which allows you to configure custom-size LUs that are smaller than standard-size LUs. When custom-size LUs are assigned to a CA Journaling pair, the secondary data volume must have the same capacity as the primary data volume.

Table 123 lists the emulation types and capacities of the master and restore journal volumes that can be used for CA Journaling.

**Table 123** Journal volume specifications

Item	Support specifications
Emulation type	Same  <b>NOTE:</b> Only Open-V can be used for journal volumes.
Volume capacity	Same or different amount of capacity is available

Table 124 list the RAID-level combination of data volume and journal volume in the journal group that can be used for CA Journaling.

**Table 124** RAID-level configuration of CA Journaling

Item	Support specifications
RAID configuration of data volume and journal volume	RAID5 and RAID1 can coexist

RAID5 and RAID1 can coexist in the same journal group.

## Maximum number of pairs



**NOTE:** The number of pairs that can be created in a disk array is limited.

Use the number of cylinders and bitmap areas to calculate the maximum number of pairs that can be created in a disk array.

- Number of cylinders

The number of pairs of a primary and a secondary data volume is limited. The number of pairs depends on the volume capacity (that is, the number of cylinders in the volumes that form pairs). If custom volumes are used, the number of pairs depends on the number of cylinders specified by Volume Manager. A limit on the number of pairs is applied to the primary and secondary disk arrays. Use the following formula to calculate the number of cylinders for different emulation types:

- For OPEN-V

$$\text{Number of cylinders} = (\uparrow ((\uparrow (\text{Max. LBA}/512) \uparrow) / 15) \uparrow) + 1$$

The  $\uparrow \dots \uparrow$  symbols around a value indicate the value should be rounded up to the nearest integer.

- Number of bitmap areas

The number of bitmap areas to be used by all data volumes that form pairs can be calculated out of the number of cylinders. If one pair of extended shared memories is used, 11,605 bitmap areas can be used in a disk array. If two pairs of extended shared memories are used, 28,671 bitmap areas can be used in a disk array.



**NOTE:** If the calculated number of bitmap areas exceeds the total number of bitmap areas in the disk array, the number of pairs that can be created is limited.

Use the following formula to calculate the number of bitmap areas to be used for each volume:

$$\text{Number of bitmap areas} = (\uparrow ((\text{Number of cylinders} \times 15) / 122,752) \uparrow)$$

The  $\uparrow \dots \uparrow$  symbols around a value indicate the value should be rounded up to the nearest integer.

- Maximum number of pairs that can be created

Use the following formulas to calculate the maximum number of pairs that can be created:

- When one pair of extended shared cache memories is used

$$\text{Maximum number of pairs you can create} = (\downarrow (11,605 / \text{Number of bitmap areas}) \downarrow)$$

The  $\downarrow \dots \downarrow$  symbols around a value indicate the value should be rounded down to the nearest integer.

- When two pairs of extended shared cache memories are used

$$\text{Maximum number of pairs you can create} = (\downarrow (28,671 / \text{Number of bitmap areas}) \downarrow)$$

The  $\downarrow \dots \downarrow$  symbols around a value indicate the value should be rounded down to the nearest integer.



**NOTE:** If the calculated maximum number of pairs exceeds 16,384, the actual maximum number of pairs is limited to 16,384.



**NOTE:** The capacity of OPEN-V is variable. To calculate the maximum number of pairs of OPEN-V, use the formula.



**CAUTION:** The bitmap areas used for CA Journaling are also used for Continuous Access XP. If you use Continuous Access XP and CA Journaling, use the total number of both pairs.

## Journal groups

CA Journaling journal groups have the following requirements:

- Each CA Journaling pair must be assigned to one and only one journal group.



- [Table 125](#) lists journal group specifications.

**Table 125** Journal group specifications

Item	Support specifications
Numbers of journal group	Up to 256,
Numbers of data volume in journal group	Up to 4,096
Numbers of journal volume in journal group	Up to 16
Number of Mirror IDs	Up to 4 (ID No.: 0 to 3)  <b>NOTE:</b> If Continuous Access XP (synchronous) uses No. 0, No. 1 to 3 are available for CA Journaling.

The same number of journal volumes is not required in the master journal group and the restore journal group that are paired.

Mirror ID is required for a configuration that will be supported in the future as 3-data center (3DC) configuration. In the future, HP might support setting two or more restore journal group for one master journal group. Each pair relationship in a journal group is called "Mirror." The Mirror ID identifies two or more mirrors for one journal group. The same Mirror ID is applied for the data volume pair. See "[Combining CA Journaling with Continuous Access XP \(3DC configuration\)](#)" on page 630 for more information.

- [Table 126](#) describes the relationship between data volumes, between journal volumes, and between the data volume and journal volume in a journal group.

**Table 126** Volume Specifications in Journal Group

Item	Support specification
Emulation type	Same or different emulation types are available  <b>NOTE:</b> Only Open-V can be used for journal volumes.
Volume capacity	Same or different capacity is available

 **CAUTION:** When a pair is created, the disk array stores information about the remote disk array and connection paths for the journal group. This information remains stored even after the pair is deleted. Therefore, to delete a pair and then use the journal group to create a new pair with another remote disk array, you must first delete the journal group and then create the same journal group again.

## Accessing CA Journaling primary and secondary data volumes

To ensure maximum data integrity during normal CA Journaling operations, the secondary disk array rejects all write operations issued by a host to a CA Journaling secondary data volume. If you need a write operation to a CA Journaling secondary data volume, you must set the secondary data volume write

option (see ["Secondary data volume write option"](#) on page 604). When you resume (Pairresync) the split pair, the secondary disk array sends the secondary data volume's track bitmap to the primary disk array to ensure proper pair resynchronization.

## Cache and nonvolatile storage (NVS)

Cache and nonvolatile storage (NVS) must be operable for the primary and secondary disk arrays of a CA Journaling data volume pair. If not, the CA Journaling paircreate operation fails. The remote disk array cache should be configured to adequately support CA Journaling remote copy workloads and local workload activity.

## Duplicate volumes

Because the contents of the primary data volume and secondary data volume of a CA Journaling pair are identical, the secondary data volume can be considered a duplicate of the primary data volume. Because the host operating system does not allow duplicate volumes, the host system administrator must take precautions to prevent system problems related to duplicate volumes. You must define the CA Journaling secondary data volume so they do not auto-mount or come online to the same host at the same time as the primary data volume.

CA Journaling does not allow the secondary data volume to be online (except while the pair is split). If the secondary data volume is online, the CA Journaling paircreate operation will fail.



**WARNING!** If the CA Journaling secondary data volume is physically attached to the same host servers as the CA Journaling primary data volumes, the old secondary data volume is usually offline when a CA Journaling pair is deleted. If the host is then restarted, the system administrator might be offered both volumes and asked which volume should be left offline. This can be confusing and is prone to error.

If the CA Journaling secondary data volumes and primary data volumes are connected to the same hosts, HP strongly recommends that secondary data volumes are defined to remain offline to avoid this problem.

---

## Installing hardware

You and the HP representative initially install the CA Journaling hardware. To install the hardware required for CA Journaling operations:

- 1. User:** Identify the locations of CA Journaling's primary and secondary data volumes (primary data volumes and secondary data volumes), so the CA Journaling hardware can be installed and configured properly.
- 2. HP Representative:** Ensure that the primary and secondary disk arrays are configured for Command View XP operations (for example, SVP is connected to the LAN).
- 3. HP Representative:** Ensure that the primary and secondary disk arrays are properly configured for CA Journaling operations (for example, cache and NVS) (see ["Cache and nonvolatile storage \(NVS\)"](#) on page 620). Ensure that the desired SVP modes are enabled (see [Table 114](#)). Ensure that adequate cache is installed and available for CA Journaling operations. You must also consider the amount of HP Cache LUN XP data to be stored in cache when determining the required amount of cache.
- 4. HP Representative:** Ensure that the primary disk arrays are configured to report sense information to the hosts. The secondary disk arrays should also be attached to a host server to enable sense information reporting if a problem with an secondary data volume or secondary disk array occurs. If the remote site is unattended, the secondary disk arrays should be attached to a host server at the primary site, so the system administrator can monitor the operational condition of the secondary disk arrays.
- 5. HP Representative:** If power sequence control cables are used, set the power select switch for the cluster to LOCAL to prevent the host from powering off the primary disk array. Also ensure that the

secondary disk array will not be powered off during CA Journaling operations. See [“Power management for disk arrays and network relay devices”](#) on page 698 for more information about powering off and on the primary and secondary disk arrays.

- HP Representative:** Install CA Journaling remote copy connections between the primary and secondary disk arrays. The user supplies this hardware (optical fibre cables, switches, and so on).

See [“Remote copy connections”](#) on page 621 for remote copy configurations. Distribute the paths between different storage clusters and switches to provide maximum flexibility and availability. The logical paths between the primary and secondary disk arrays must be separate from the logical paths between the host and secondary disk array.

## Remote copy connections

Figure 342 shows remote copy connection configurations for CA Journaling operations. The primary and secondary disk arrays of each CA Journaling pair must be connected using optical fiber cables. If you use multimode shortwave optical fiber cables, fibre cables up to 1.5 km in length and up to two switches are required for distances greater than 0.5 km. If you use single-mode longwave optical fiber cables, fibre cables up to 30 km in length and up to two switches are required for distances greater than 10 km. CA Journaling operations can be performed at distances of up to 30 km (18.6 miles) using standard single-mode longwave support. For greater distances, channel extender connections are required. CA Journaling operations can be performed at distances of up to 30 km (18.6 miles) using standard single-mode longwave support. For distances greater than 43 km (26.7 miles), approved channel extender products and telecommunications lines are required.

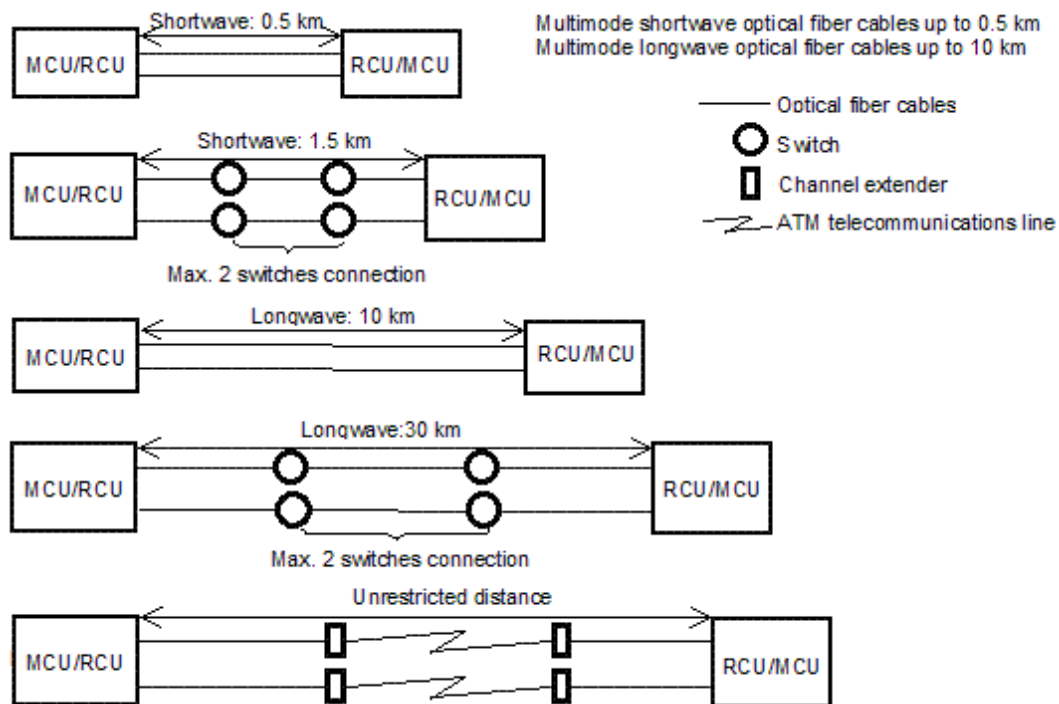

**Figure 342** CA Journaling remote copy connection configuration

The remote copy connection between primary disk array and secondary disk array provides three different configurations:

- Direct connections

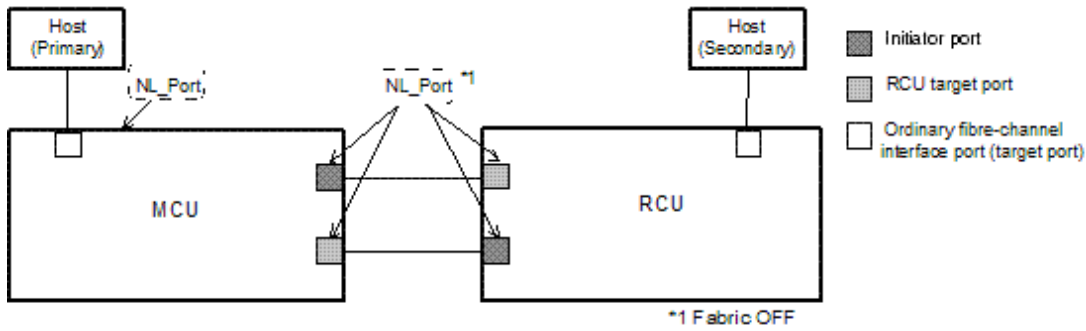

**Figure 343** Direct remote copy connections

- Switch connections

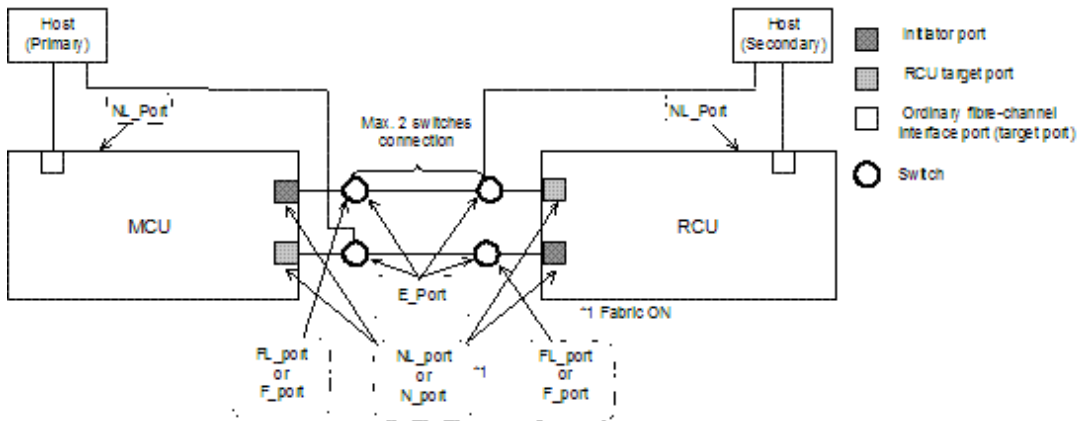

**Figure 344** Switch remote copy connections

- Extender connections

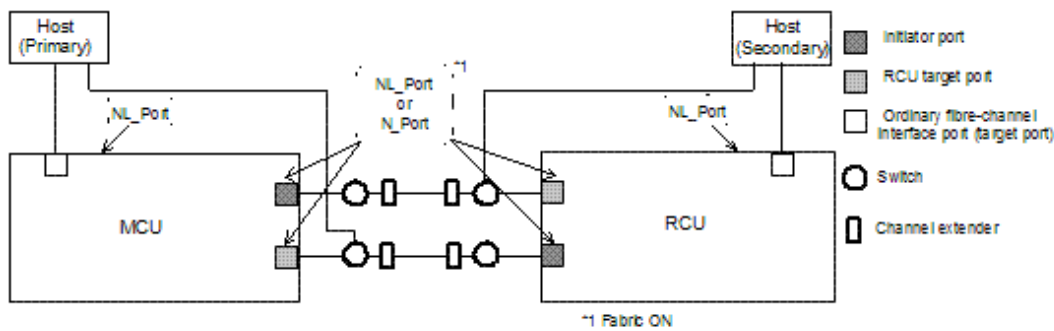

**Figure 345** Extender remote copy connections

## Enabling CA Journaling options

To operate CA Journaling, a PC for Command View XP is required. For more information about Command View XP operations, see ["Getting started"](#) on page 39 or contact your HP account support representative.

## Planning for journal volumes

The data transfer speed for journal groups is affected by the journal volume specifications of the journal group's use. Therefore, to achieve the desired transfer speed, you must consider these journal volume specifications.

## Considerations

The following factors affect the speed of writing to and reading from journal volumes, particularly when a temporary communications path failure occurs between the primary and the secondary disk arrays or when the amount of data transferred from hosts to the primary disk array increases:

- RAID configuration of the RAID groups that will contain journal volumes
- Types of physical volumes in the RAID groups that will contain journal volumes
- Frequency of access to non-journal volumes in the RAID groups that will contain journal volumes
- Data transfer speed required for the non-journal volumes
- Disk usage rate for RAID groups

The capacity of the journal volumes affects the time during which data transfer with hosts can continue without being influenced by a temporary communications path failure between the primary and secondary disk arrays or an increase in the data to be transferred from hosts to the primary disk array.

## Planning process

### Data transfer speed required for journal volumes

Figure 346 illustrates how the data transfer speed (that is, the amount of data to be transferred per unit of time) changes as time elapses, showing different types of data transfer speeds with CA Journaling. Data transfer speed between hosts and the primary disk array goes through two phases. In one phase the data transfer speed remains almost unchanged. In the other phase the data transfer speed increases temporarily.

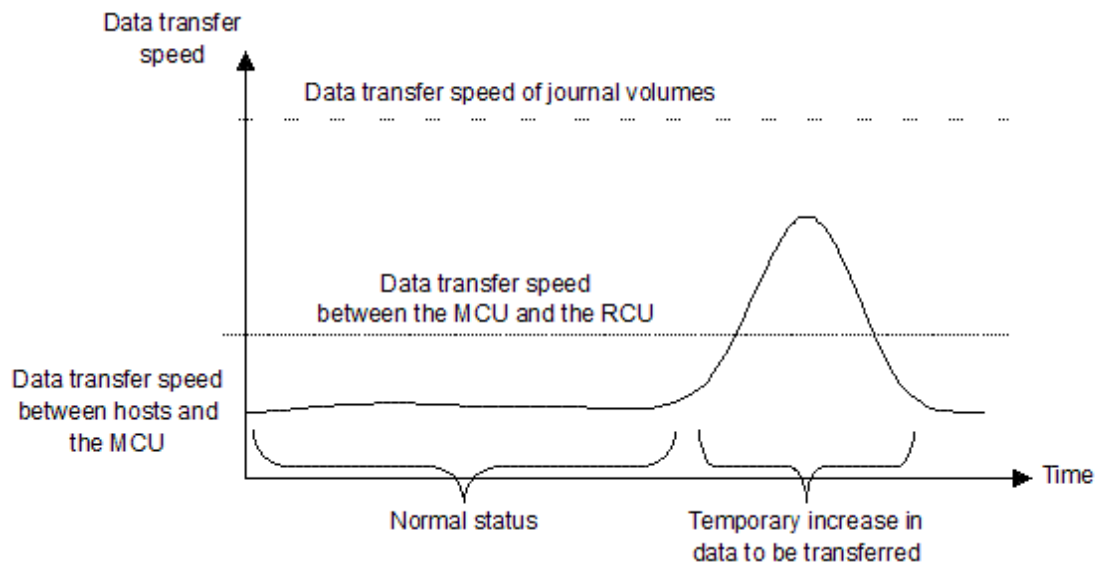

**Figure 346** Data transfer speed of journal volumes

As illustrated in Figure 346, the data transfer speed (that is, the speed for reading and writing) of journal volumes in the master journal group must exceed the amount of temporary increase in data to be transferred. If the data transfer speed of journal volumes is below the amount of temporary increase in data to be transferred, the journal data for the temporary increase in data to be transferred will not be stored into journal volumes in a timely manner.

In Figure 346, the data transfer speed between the primary and the secondary disk arrays indicates the transfer speed of journal data between the primary and secondary disk arrays. For more information, see “[Journal volumes in restore journal groups](#)” on page 625.

## RAID group configuration and journal group configuration

A RAID group can consist of physical volumes of different number of revolutions, physical volumes of different capacity, and physical volumes of different RAID configurations (for example, RAID-1 and RAID-5). The data transfer speed of RAID groups is affected by the physical volumes and RAID configurations.

The data transfer speed of a journal volume depends on the data transfer speed of the RAID group to which the journal volume belongs. One RAID group can consist of one or more logical volumes, including journal volumes. Therefore, if frequent accesses are made to non-journal volumes in a RAID group, relatively fewer accesses can be made to journal volumes in the same RAID group, which can cause a drop in the data transfer speed of the journal volumes. To avoid this drop, you should consider, for example, relocating the journal volumes and the frequently accessed non-journal volumes (that is, placing the journal groups in one RAID group and placing the frequently accessed non-journal volumes in another RAID group).

## Arranging journal volumes

If a host attempts to write data of  $aa$  kilobytes and the number of write I/Os per second is  $bb$ , the data transfer speed required for journal volumes is calculated as follows:

$$\text{Data transfer speed of journal volumes} > aa \times bb \div 1,024 \text{ (MB/sec)}$$

The data transfer speed of journal volumes must exceed the data transfer speed from hosts to the primary disk array. You must consider the data transfer speed (that is, the speed for writing and reading) required for journal volumes, determine the physical volume configuration and RAID configuration of RAID groups, and create journal volumes in the RAID groups.

## Journal volume capacity

In [Figure 347](#), the size of the shaded area indicates the amount of journal data to be stored in journal volumes as a result of a temporary increase in data transferred.

If a temporary communications path failure occurs between the primary and secondary disk arrays, journal transfers between the primary and secondary disk arrays stops temporarily. If hosts transfer data to the primary disk array while journal transfers between the primary and secondary disk array are stopped temporarily, all data transferred from the hosts to the primary disk array is stored as journal data in journal volumes.

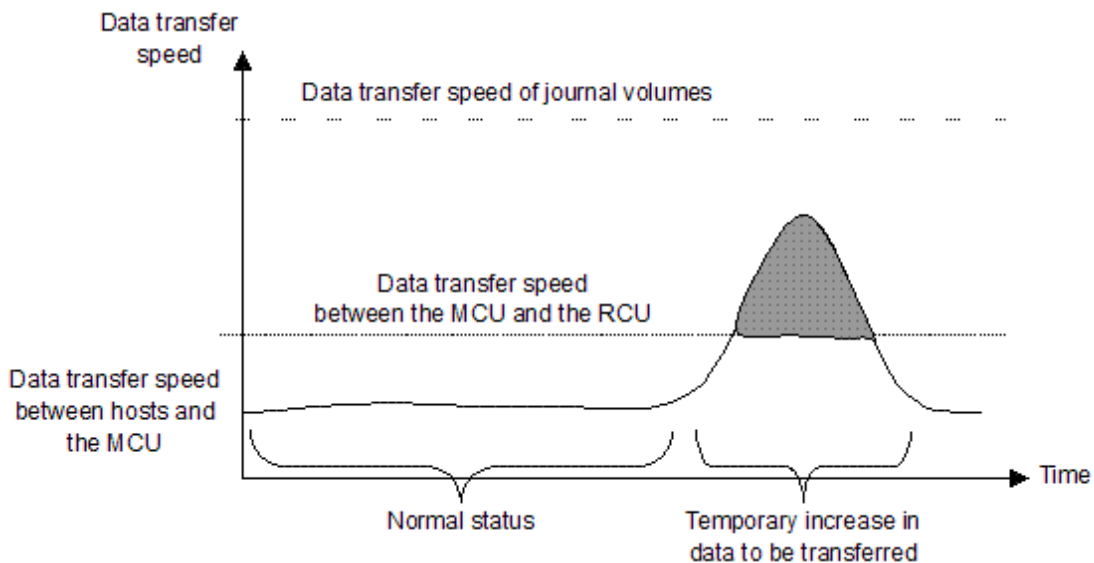

**Figure 347** Influence of data transfer speed on journal volume capacity

To determine the journal volume capacity, use the following formula:

$$\text{Journal volume capacity} > V_{H-M} - V_{M-R} \times t$$

where:

- $V_{H-M}$  is the data transfer speed between the hosts and primary disk array
- $V_{M-R}$  is the data transfer speed between the primary and secondary disk arrays
- $t$  is the length of time during which data transfer can continue

To calculate the journal volume capacity required when a communications path failure occurs between the primary and secondary disk arrays, assign 0 (zero) to  $V_{M-R}$ .

The total capacity of the journal volumes in each journal group must exceed the value illustrated above.

### Journal volumes in restore journal groups

When a failure occurs at a host, one failure recovery measure is to reverse the primary and secondary data volumes (that is, change the copy direction). To reverse the primary and secondary data volumes, you must ensure that the data transfer speed is the same before and after you reverse the data volumes. Therefore, when you plan for master journal volumes and restore journal volumes, you must apply the same scheme to the master and restore journal volumes.

If you do not want to reverse the primary and secondary data volumes, you can cope with a temporary increase in data transfers and a communications path failure between the primary and secondary disk arrays if the master journal volume satisfies the conditions mentioned earlier. Therefore, the data transfer speed and volume capacity required for restore journal volumes are smaller than those required for master journal volumes. The data transfer speed for journal volumes must exceed the data transfer speed in "normal status."

## Factors that determine the data transfer speed between the primary and Secondary disk arrays

The speed of data transfer between the primary and secondary disk arrays depends on the following factors:

- Bandwidth of the data transfer paths
- DKC's journal transfer speed

The data transfer speed between the primary and secondary disk arrays must exceed the data transfer speed in "normal status" shown in [Figure 348](#). If a temporary increase in transferred data occurs and the

data transfer speed between the primary and secondary disk arrays is exceeded, excess data is stored temporarily in journal volumes.

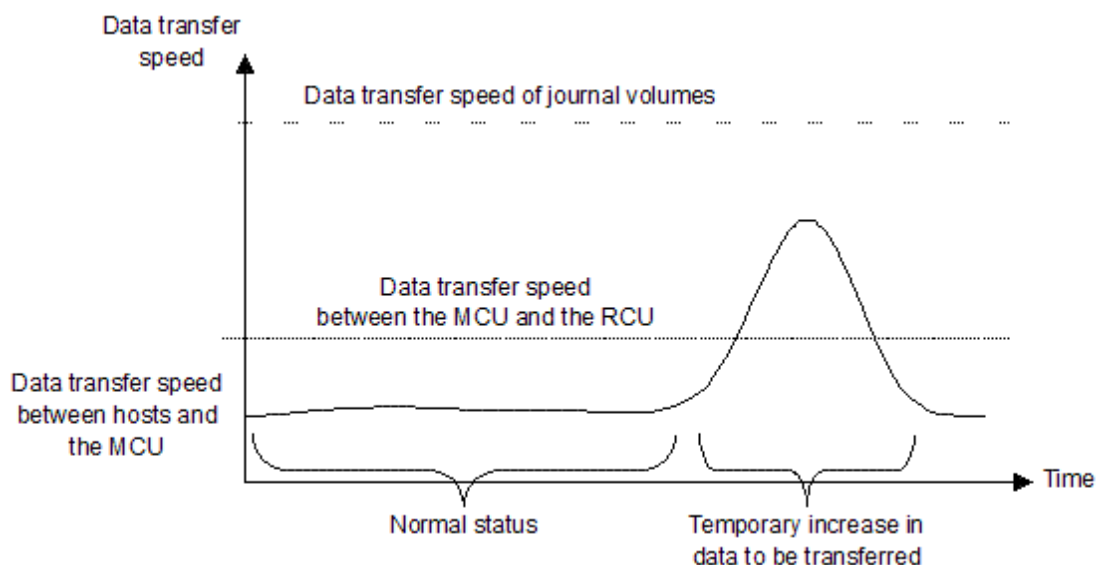

**Figure 348** Data transfer speed between primary and secondary disk arrays

### Bandwidth of data transfer paths

The bandwidth (that is, the data transfer speed) of data transfer paths between the primary and secondary disk arrays depends on your environment. The bandwidth must exceed the data transfer speed in “normal status” mentioned previously.

### Journal transfer speed of DKCs

The journal transfer speed of a DKC depends on the number of paths used for transferring journals. The number of paths for transferring journals must be large enough that the journal transfer speed exceeds the data transfer speed in the “normal status” mentioned previously. The maximum number of paths for each pair of a primary DKC and a secondary DKC is 8.



**NOTE:** If the journal transfer speed falls short of the desired speed, check the usage rate of channel processors. If the usage rate of some channel processors is high, the journal transfer speed may be increased if you add channel processors.

## Configuring primary and secondary disk arrays for CA Journaling operations

After you install the CA Journaling hardware and software, you can configure the primary and secondary disk arrays for CA Journaling operations.

1. Identify the CA Journaling data volumes and journal volumes in the primary and secondary disk arrays. You must know the disk array’s S/N and port ID, so you can configure the primary and secondary disk arrays correctly for the desired pairs. When you create the pairs, you must know each volume’s port, target ID, and LUN.
2. Connect to the local disk array you want to use. For more information about Command View XP installation and operations, see “[Getting started](#)” on page 39 or contact your HP account support representative.





---

**NOTE:** You must log in with Administrator or CA Journaling write access, and you must be in Modify mode. If you are in the View mode, you can view the CA Journaling pair status, but you cannot modify the settings.

---

3. Click the **Continuous Access XP Journal** button (). The Journal Operations pane appears.
  4. Click the **DKC Operation** tab.
  5. Select **Port**, and set the initiator and RCU target ports (see "[Configuring port attributes](#)" on page 638).
  6. In the DKC Operations pane, select **DKC**. The Add DKC pane appears.
  7. Set the S/N of the disk array to be connected, controller ID, path group ID, initiator port in this disk array, and RCU target port in the disk array to be connected (see "[Associating primary and remote disk arrays and configuring logical paths \(Add DKC\)](#)" on page 640).
  8. In the Add DKC pane, click **Option**, and set the local disk array's options (see "[Associating primary and remote disk arrays and configuring logical paths \(Add DKC\)](#)" on page 640).
  9. In the Journal Operation pane, specify the journal group number.
  10. In the Edit JNL Volumes pane, register the journal volumes (see "[Deleting journal volumes from journal groups](#)" on page 653).
  11. In the Paircreate pane of the Pair Operation tab, register the primary and secondary data volumes and the journal groups that are paired (see "[Creating a pair of data volumes \(Paircreate\)](#)" on page 667).
- 



**NOTE:** CA Journaling pairs can only be registered by the primary disk array.

---

12. Exit the CA Journaling, and disconnect from the disk array.
  13. Repeat [step 3](#) through [step 9](#) for each disk array that will function as a CA Journaling primary disk array. After you configure the primary disk arrays, add the secondary disk arrays, and configure the CA Journaling options and journal groups, you can begin CA Journaling volume pair operations.
- 

## Combining CA Journaling with other data management operations

CA Journaling supports concurrent operations with the following data management functions:

- **Volume Manager.** LUSE volumes can be assigned to CA Journaling pairs if the secondary data volume has the same capacity than the primary data volume. To perform Volume Management operations on an existing CA Journaling primary or secondary data volume, you must delete the pair first to return the volume to SMPL status.
- **HP Cache LUN XP.** HP Cache LUN XP volumes can be assigned to CA Journaling pairs, and HP Cache LUN XP operations can be performed on existing CA Journaling primary and secondary data volumes.
- **Hitachi SANtinel.** Hitachi SANtinel operations do not affect CA Journaling operations. Volumes that are under secure ports and/or assigned to World Wide Name (WWN) groups and/or LUN groups can also be assigned to CA Journaling pairs. Volumes that are assigned to CA Journaling pairs can also be assigned to secure ports, WWN groups, and/or LUN groups for Hitachi SANtinel.



**NOTE:** A UNIX or PC server cannot access CA Journaling secondary data volumes unless the pair is split.

- **HP Performance Control XP.** Initiator ports in the primary disk array do not support the HP Performance Control XP option.

## Combining CA Journaling and Business Copy XP

You can use CA Journaling and Business Copy XP together in the same disk array and on the same volumes to provide multiple copies of data at the primary and/or remote sites. [Table 127](#) describes the host pair status reporting for CA Journaling volumes, Business Copy XP volumes, and CA Journaling/Business Copy XP shared volumes. [Table 128](#) shows the currency of the data on a shared CA Journaling/Business Copy XP volume based on CA Journaling and Business Copy XP pair status.

- For shared CA Journaling/Business Copy XP volumes, the CA Journaling pair status is reported to the host if you query the CA Journaling primary or secondary data volume. To obtain the Business Copy XP pair status, query the Business Copy XP pair's P-VOL.
- Business Copy XP supports multiple S-VOLs for each P-VOL. If you issue a pair status query to a Business Copy XP P-VOL (for example, pairdisplay), the status of only one Business Copy XP pair is reported (the pair with the S-VOL with the lowest LDEV ID). To obtain the pair status for the Business Copy XP pairs with the other S-VOLs, you must direct the host query to the specific S-VOL using the S-VOL's LDEV ID in the host command. The Business Copy XP displays the port, TID, LUN, LDEV ID and Business Copy XP pair status of all S-VOLs associated with a P-VOL.

**Table 127** Host pair status reporting for CA Journaling/Business Copy XP shared volumes

Number of CA Journaling Pairs	Number of Business Copy XP S-VOLs	Pair Status Reported by Command View XP
0	0	Simplex
0	1	ShadowImage pair status
0	2 or more	Business Copy XP pair status for the pair whose S-VOL has the lowest LDEV ID
1	0	CA Journaling pair status
1	1	CA Journaling pair status
1	2 or more	CA Journaling pair status

**Table 128** Data currency of a shared CA Journaling/Business Copy XP volume

CA Journaling pair status	Business Copy XP Pair Status					
	COPY (PD)	PAIR	COPY (SP)	PSUS	COPY (RS/RS-R)	PSUE
COPY	Not current	Not current	Not current	CURRENT	Not current	Not current
PAIR	Not current	Not current	Not current	CURRENT	Not current	Not current
PSUS/PSUE	Not current	CURRENT	CURRENT	CURRENT	CURRENT	Not current

Figure 349 through Figure 352 show the various CA Journaling/Business Copy XP configurations that share volumes.

- **CA Journaling/Business Copy XP configurations that share the CA Journaling primary data volume and Business Copy XP P-VOL**

Figure 349 shows an example of a CA Journaling primary data volume that also functions as a Business Copy XP P-VOL. You can use this configuration to use Business Copy XP for on-site data backup if a CA Journaling failure occurs and use CA Journaling to provide remote backup of the Business Copy XP P-VOL if a Business Copy XP failure occurs.

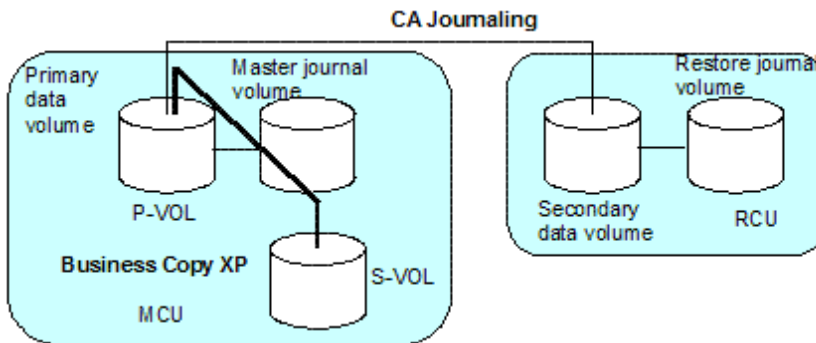

**Figure 349** Shared CA Journaling secondary data volume and Business Copy XP P-VOL

- CA Journaling/Business Copy XP configurations that share the CA Journaling secondary data volume and Business Copy XP P-VOL

Figure 350 shows an example of a CA Journaling secondary data volume that also functions as a Business Copy XP P-VOL. You can use this configuration to use Business Copy XP to provide multiple backup copies of a single CA Journaling primary data volume.

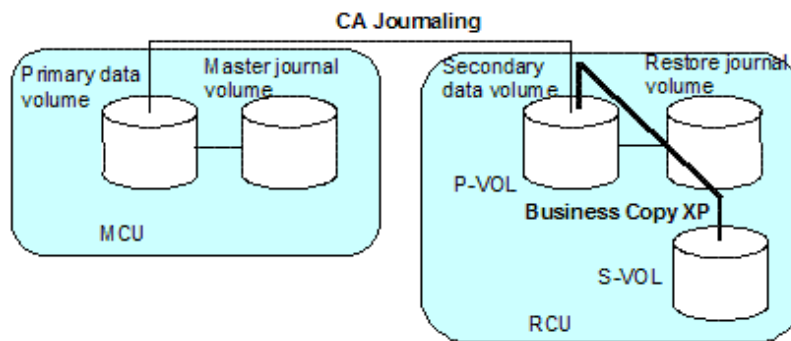

**Figure 350** Shared CA Journaling secondary data volume and Business Copy XP P-VOL

- **CA Journaling/Business Copy XP configuration that shares the CA Journaling primary data volume and Business Copy XP P-VOL, and CA Journaling secondary data volume and Business Copy XP P-VOL**

Figure 351 combines the configurations shown in Table 349 and Table 350. Within a single CA Journaling pair, the primary and secondary data volumes function as Business Copy XP P-VOLs, providing multiple copies at the primary and remote sites.

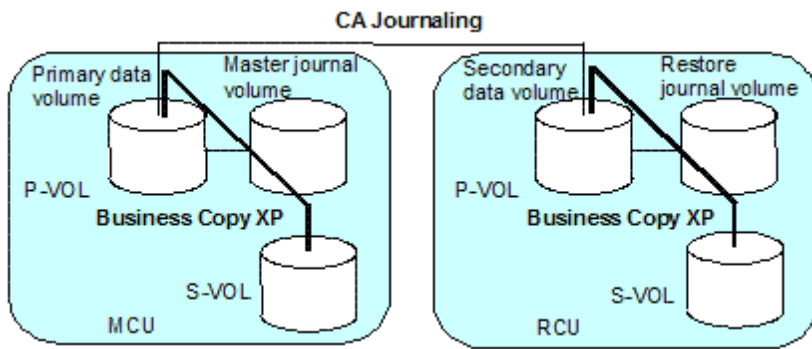

**Figure 351** Shared CA Journaling primary data volume and Business Copy XP P-VOL, and CA Journaling secondary data volume and Business Copy XP P-VOL

- **CA Journaling/Business Copy XP configurations that share the Business Copy XP S-VOL and CA Journaling primary data volume**

Figure 352 shows an example of a Business Copy XP S-VOL that is used as a CA Journaling primary data volume.



**CAUTION:** This configuration requires that the Business Copy XP pair be established in duplex mode (PAIR) and then split (PSUS) before the CA Journaling pair is created.

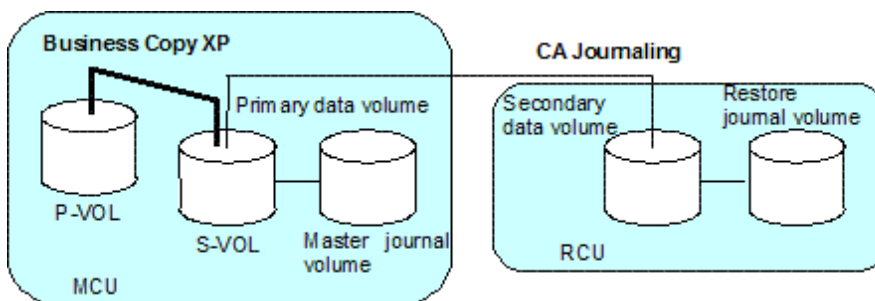

**Figure 352** Shared Business Copy XP S-VOL and CA Journaling primary data volume

## Combining CA Journaling with Continuous Access XP (3DC configuration)

The local disk array allows CA Journaling and Continuous Access XP (synchronous) to be combined. This combination is intended to ensure that the response time against host I/Os is comparable, regardless of whether the distance between the primary and secondary sites is short or long. This combination is also intended to ensure that the secondary site stores data that has been stored in the primary site even if a failure occurs in the primary site. These intentions are fulfilled if remote copy operations are performed using cascading connections and a three data center (3DC) configuration. In a 3DC configuration, an intermediate site is located between the primary and secondary sites.

Figure 353 shows an example of a 3DC cascading configuration in which CA Journaling and Continuous Access XP (synchronous) are combined. In this configuration, the volume in the primary site is a Continuous Access XP (synchronous) primary volume (P-VOL). The corresponding Continuous Access XP secondary volume (S-VOL) is the volume in the intermediate site, which is a short distance from the primary site. This Continuous Access XP (synchronous) secondary volume is also used as a CA Journaling primary data volume. The corresponding CA Journaling secondary data volume is the volume in the secondary site, which is a long distance from the intermediate site. If a host issues an I/O to the Continuous Access XP (synchronous) primary volume in the primary site, data is transferred using

Continuous Access XP (synchronous) and CA Journaling to the secondary site and is restored to the secondary data volume.

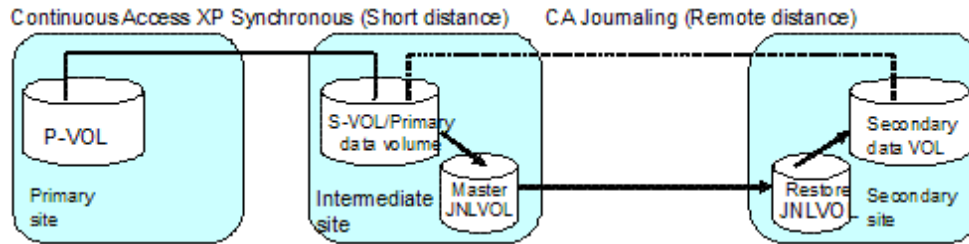

**Figure 353** 3DC cascading configuration (combining CA Journaling with Continuous Access XP [synchronous])

Data that Continuous Access XP (synchronous) copies is stored in the CA Journaling primary data volume. If a failure occurs at the Continuous Access XP (synchronous) P-VOL, you can continue business tasks by using data in the CA Journaling secondary data volume, which contains data in the Continuous Access XP (synchronous) P-VOL. Data in the Continuous Access XP (synchronous) P-VOL is restored through CA Journaling to the secondary data volume in the secondary site, with update sequence integrity ensured. If a failure occurs at both the Continuous Access XP (synchronous) P-VOL and S-VOL due to a disaster or any other reason, disaster recovery can be performed using the CA Journaling secondary data volume.



**NOTE:** A Continuous Access XP (synchronous) P-VOL must be created in a local disk array. The fence level of the Continuous Access XP (synchronous) P-VOL must be Data.

## Basic behavior

This section explains the basic behavior of a 3DC cascading configuration under the following conditions:

- The status of the Continuous Access XP (synchronous) pair is **PAIR**. The status of the CA Journaling pair is also **PAIR**.
- A host in the primary site issues an I/O request to the Continuous Access XP (synchronous) P-VOL

As illustrated in [Figure 354](#), if a host in the primary site issues an I/O request, data is stored in the Continuous Access XP (synchronous) P-VOL. Data is also stored in the Continuous Access XP (synchronous) S-VOL (that is, the CA Journaling primary data volume). After that, the fact that data has been stored is reported to the primary site, and the fact that I/O has been finished is reported to the host. Also, data in the CA Journaling primary data volume (that is, Continuous Access XP (synchronous) S-VOL) is stored as journal data in the master journal volume in the intermediate site. Sequence numbers, which indicate the order data is written, are added to the journal data. Also, journal data in the master journal volume in the intermediate site is transferred, independently from and asynchronously with the behavior mentioned above, to the restore journal volume in the secondary site. Next, journal data in the restore journal volume is restored to the CA Journaling secondary data volume in the secondary site; journal data is restored in the order of sequence numbers added to the journal data. These sequence numbers ensure that updates to CA Journaling secondary data volumes in the secondary site are made in the same order that updates to Continuous Access XP (synchronous) P-VOL in the primary site are made.

As explained previously, when the host in the primary site issues an I/O request to the Continuous Access XP Synchronous P-VOL, the data is restored asynchronously to the CA Journaling secondary data volume in the secondary site in a remote location.

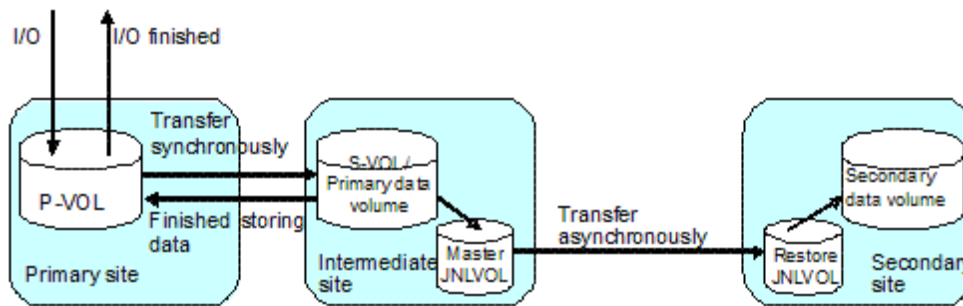

**Figure 354** Basic behavior in 3DC cascading configuration

If a Continuous Access XP (synchronous) pair is suspended in a 3DC cascading configuration, you can resynchronize the pair using a differential copy. If a CA Journaling pair is suspended, you can resynchronize the pair using a differential copy.



**NOTE:** To perform disaster recovery from a failure in the primary site in a 3DC cascading configuration, ensure that the fence level of the Continuous Access XP (synchronous) P-VOL is **Data**. If this fence level is specified, you can perform disaster recovery using the CA Journaling secondary data volume containing data stored in the Continuous Access XP (synchronous) P-VOL.

## Hardware configuration

This section explains the hardware configuration for a 3DC cascading configuration using Continuous Access XP (synchronous) and CA Journaling. In a 3DC cascading configuration, three disk arrays are required. HP recommends that you install RAID Manager on hosts in the primary, intermediate, and secondary sites. Command View XP computers are required for these sites. The following explains hardware configuration for these sites.

- Local disk array at the primary site
  - Continuous Access XP must be installed.
  - Must have a Continuous Access XP (synchronous) P-VOL.
- Local disk array at the Intermediate site
  - Continuous Access XP must be installed.
  - CA Journaling must be installed.
  - Must have a volume used as a Continuous Access XP (synchronous) S-VOL and a CA Journaling primary data volume.
  - Must have a CA Journaling master journal volume.
- Local disk array at the remote site
  - CA Journaling must be installed.
  - Must have a CA Journaling secondary data volume.
  - Must have a CA Journaling restore journal volume.

## Setup procedure

This section explains the procedure for setting up a 3DC cascading configuration using Continuous Access XP (synchronous) and CA Journaling.

1. Install Continuous Access XP and CA Journaling. Configure ports and journal groups.
2. Issue a request for creating a Continuous Access XP (synchronous) pair to the primary disk array where Continuous Access XP is installed.
3. Wait until the status of the Continuous Access XP (synchronous) pair becomes **PAIR**.
4. Issue a request for creating a CA Journaling pair to the CA Journaling primary disk array.
5. Wait until the status of the CA Journaling pair becomes **PAIR**.



**NOTE:** Ensure that the Continuous Access XP (synchronous) pair status changes to **PAIR** before the CA Journaling pair status changes to **PAIR**. If you made a request to change the CA Journaling pair status to **PAIR** before the Continuous Access XP (synchronous) pair status changes to **PAIR**, you must suspend the CA Journaling journal group to change the CA Journaling pair status to **PSUS**, and then retry the operation.

For detailed information about CA Journaling journal group configuration, see "[Journal group operations](#)" on page 607. For detailed information about port configuration, see "[Configuring port attributes](#)" on page 638.

## Disaster recovery

If a disaster or failure occurs in the primary site in a 3DC cascading configuration, you can use CA Journaling secondary volumes in the secondary site to enable the secondary site to take over your business tasks. If a disaster or failure occurs in the primary site, you must first transfer your business tasks from the primary site to the secondary site.

To transfer your business tasks to the secondary site:

1. Check the consistency of the CA Journaling secondary data volume in the secondary site.
2. Use RAID Manager to suspend the journal group that exists between the intermediate and secondary sites. Be sure to use the flush option when suspending the journal group.
3. Wait until the status of the CA Journaling secondary data volume in the secondary site changes.
4. Use RAID Manager to execute **horctakeover** onto the CA Journaling pair that exists between the intermediate and secondary sites.
5. Use the CA Journaling secondary data volume in the secondary site to resume your business tasks.

When a disaster or failure occurs, this procedure enables you to resume your business tasks using CA Journaling secondary data volumes in the secondary site. The CA Journaling secondary data volumes contain the same data that is stored in the Continuous Access XP (synchronous) P-VOLs (only when the fence level is **Data**).

In [step 3](#) of this procedure, it is possible that the pair status of the suspended data volume does not become **PSUS** due to a path failure between the intermediate and secondary sites. If this happens, move on to [step 4](#). If this happens, the CA Journaling primary data volume might contain data, but some of the data might not have been transferred to the secondary site. In this case, the update sequence for CA Journaling secondary data volumes in secondary site remains consistent.

For more information, see "[CA Journaling data volume pair status](#)" on page 608.

---

# Configuring disk arrays and logical paths

To introduce CA Journaling into your system and configure your system for remote copy operations, consider what data should be copied from which disk array to which disk array. The disk array containing data to be copied to another disk array is referred to as the *primary disk array*. The disk array to which data is copied from another disk array is referred to as the *secondary disk array*. The location of the primary disk array is referred to as the *primary site*. The location of the secondary disk array is referred to as the *secondary site*.

When performing system configurations for remote copy operations, the primary and secondary site administrators must do the following:

- The primary site administrator must configure some ports on the primary disk array to connect hosts and configure other ports on the primary disk array to communicate with remote disk arrays.
- The secondary site administrator must configure some ports on the secondary disk array to communicate with the primary disk array.
- After finishing the port configurations, the primary and secondary site administrators must configure logical paths between the communications ports on the primary site and the communication ports on the secondary site, so the two disk arrays can communicate with each other.

When performing system configurations, the administrators must do the following:

- ["Displaying the DKC Operation pane"](#) on page 634
- ["Configuring port attributes"](#) on page 638
- ["Associating primary and remote disk arrays and configuring logical paths \(Add DKC\)"](#) on page 640

When performing system configurations, the administrator should do the following when necessary:

- ["Changing options for logical paths and disk arrays"](#) on page 641
- ["Adding logical paths"](#) on page 643
- ["Deleting logical paths"](#) on page 644)
- ["Viewing the status of logical paths"](#) on page 644
- ["Removing the relationship between primary and secondary disk arrays"](#) on page 646



**NOTE:** Throughout this chapter, the primary and secondary disk arrays are sometimes referred to as local and remote disk arrays. If you are logged into the primary disk array and are using CA Journaling, the primary disk array is a local disk array and the secondary disk array is a remote disk array. If you are logged into the secondary disk array and are using CA Journaling, the secondary disk array is a local disk array and the primary disk array is a remote disk array.



**NOTE:** When performing system configuration, the administrator must also configure journal groups. For more information about configuring journal groups, see ["Using journal groups"](#) on page 647.

---

## Displaying the DKC Operation pane

To configure disk arrays and logical paths, use the DKC Operation pane.



## CA Journaling has not been started

1. Use your Web browser to display the storage device list. In the storage device list, select the disk array to log into. Enter a user name and the password, and click **OK**. The Command View XP main pane appears. For more information, see "[Getting started](#)" on page 39.
2. On the Command View XP main pane, click the **Continuous Access XP Journal** button (). CA Journaling starts.
3. Select the **DKC Operation** tab. The DKC Operation pane appears.

## CA Journaling has already been started

1. Select the **DKC Operation** tab. The DKC Operation pane appears.



**NOTE:** DKC is an acronym for disk controller, which controls an entire disk array. CA Journaling panes use the word DKC to indicate a disk array.

## DKC Operation pane components

The DKC Operation pane displays the following:

- **Display:** Changes information in the DKC Operation pane.
  - **DKC:** Displays information about remote disk arrays and logical paths.
  - **Port:** Displays information about ports on the local disk array.
- **Tree:** Lists one of the following:
  - Remote disk arrays (see "[Displaying information about remote disk arrays](#)" on page 636)
  - Channel adapters on the local disk array and port attributes (see "[Displaying information about logical paths](#)" on page 637)
- **List:** Displays one of the following:
  - Detailed information about remote disk arrays (see "[Displaying information about remote disk arrays](#)" on page 636)
  - Detailed information about logical paths (see "[Displaying information about logical paths](#)" on page 637)
  - Detailed information about ports on the local disk array (see "[Displaying information about ports on local disk arrays](#)" on page 638)
  - **Preset:** Displays changes made in the pane. When you change settings in the pane, the changes are displayed in the **Preset** list before the changes are applied to the disk arrays. If you are sure that information in the **Preset** is correct, click **Apply** to apply the settings you made.
- **Operation:** Displays the operation in progress in the DKC Operation pane.
- **Apply:** Applies settings in the **Preset** box to the disk arrays.
- **Cancel:** Cancels settings displayed in the **Preset** box.



**NOTE:** Information on the DKC Operation pane is updated when you do one of the following:

- Select another tab, and reselect the DKC Operation tab.
- Click **Refresh** (top right of Command View XP pane).

- Click **Apply**.
  - Select Modify mode when you are in View mode.
  - Open or close the DKC Status pane.
  - Click **Refresh** on the DKC Status pane.
- 



## Displaying information about remote disk arrays

1. Display the DKC Operation pane.
2. In the **Display** box, select **DKC**.



The tree and the list display remote disk arrays.

- **Tree:** Lists remote disk arrays. The following information appears to the right of the icon.
  - Remote disk array's controller ID (disk array family ID)
  - Remote disk array's serial number
  - Path group ID

The icon indicates the status of logical paths between the local and remote disk arrays.

	All logical paths are in a normal status.
	A failure occurred at some logical paths.

- **List:** Displays information about remote disk arrays.
  - **Controller ID:** Remote disk array's controller ID. The controller ID is a disk array's family ID. The icon indicates the status of logical paths between the local and remote disk arrays.

	All logical paths are in normal status.
	A failure occurred at some logical paths.



**NOTE:** The controller ID for an XP12000 disk array is **4**.

- **S/N:** Remote disk array's five-digit serial number.
- **Path Gr. ID:** Path group ID.



**NOTE:** In the current version, the path group ID is set to the default value.

- **M-R Path:** Channel type of the logical paths between the local and remote disk arrays. This column always displays **Fibre**.
- **Status:** Indicates whether logical paths failed.
  - **Normal:** No failure occurred at the logical paths
  - **Failed:** All logical paths failed
  - **Warning:** Some logical paths failed
- **Num of Path:** Number of logical paths.



## Displaying information about logical paths

*Logical paths* are communication paths that connect local disk array ports and remote disk array ports.

1. In the **Display** box, select **DKC**.
2. Select a remote disk array from below **Subsystem** in the tree. The list displays logical paths. Each row in the list indicates one logical path.

The list displays the following:

- **Path Gr. ID:** Path group ID. The icon indicates the status of the path:

	The logical path is in a normal status
	A failure occurred at the logical path





- **M-R Path:** Channel type of the logical paths between the local and remote disk arrays. This column always displays **Fibre**.
- **Status:** Indicates whether the logical path is in a normal status.
  - **Normal:** The logical path is in a normal status. No failure occurred at the logical path.
  - **Failed:** A failure occurred at the logical path.
- **Port:** Local disk array's port number.

- **Pair-Port:** Remote disk array's port number.

## Displaying information about ports on local disk arrays

Use the DKC Operation pane to display information about ports on the local disk array.

1. In the **Display** box, select **Port**. The tree displays a list of channel adapters and port attributes.
  2. Do one of the following in the tree:
    - Select **Subsystem**. The list displays all ports on the local disk array.
    - Select a channel adapter. The list displays ports on the channel adapter.
    - Select a port attribute. The list displays ports that have the selected port attribute.
- **Tree:** Lists channel adapters and ports on the local disk array.

	channel adapter (Fibre Channel interface)
	target port
	RCU target port
	initiator port
	external port

- **List:** Displays ports on the local disk array.
  - **Port:** Port number.
  - **Attribute:** Port attribute (initiator, target, RCU target, or external).
  - **PCB Mode:** Port mode. The mode is either **Standard** or **High**.
  - **CU#:** Currently, displays nothing.
  - **Error Code:** Error code.

## Configuring port attributes

The administrator at the primary and secondary sites must configure ports on the primary disk array and the secondary disk array in the following ways:

- The administrator at the primary site must configure target ports, initiator ports, and RCU target ports on the primary disk array.
- The administrator at the secondary site must configure initiator ports and RCU target ports on the secondary disk array.

Ports on XP12000 disk arrays have the *target* attribute by default. If you are configuring XP12000 disk arrays, you must determine which ports should be initiator ports or RCU target ports, and then change the ports' attributes from *target* to *initiator* or *RCU target*.

- **Target:** A target port is a Fibre Channel port used to connect a disk array and a host. When the host issues a write request, the request is sent to a volume through a target port on the disk array. Target ports must be configured on primary disk arrays for CA Journaling operations.
- **Initiator:** An initiator port is a Fibre Channel port that sends commands to a remote disk array. Initiator ports must be configured on the primary and remote disk arrays for CA Journaling operations.

- **RCU target:** An initiator port is a Fibre Channel port that receives commands from a remote disk array. RCU target ports must be configured on the primary and remote disk arrays for CA Journaling operations.



**NOTE:** If initiator ports and RCU target ports are not configured on the primary and remote disk arrays, the following problems occur and remote copy operations are not performed:

- The administrator at the primary site cannot create any pair of a primary and secondary volume.
- The secondary disk array cannot read data from journal volumes in the primary disk array.



**WARNING!** Before changing a Fibre Channel port to an initiator port, disconnect the port from the host, delete all affected data volume pairs, delete all logical paths from the initiator port to the remote disk array, and remove all channel paths to the port.



**WARNING!** Before changing a Fibre Channel port from initiator to target or RCU target, delete all affected data volume pairs, delete all logical paths from the initiator port to the remote disk array, and disconnect the local and remote disk arrays.



**CAUTION:** Limit the number of hosts connected to a target port to 128 or fewer to avoid mistaken disconnection. If more than 128 hosts are connected to a target port, some hosts may be disconnected after changing the type from target to RCU target.

---

The primary and remote disk array administrators must perform the following procedure:

1. Ensure that the Command View XP main pane is in Modify mode. For more information, see [Table 9](#) on page 98.
2. Ensure that the DKC Operation pane is displayed (see “[Displaying the DKC Operation pane](#)” on page 634).
3. In the **Display** box, select **Port**. The tree displays channel adapters in the local disk array and port attributes.
4. Do one of the following:
  - Select a channel adapter from the tree.
  - Select a port attribute (target, RCU target or initiator) from the tree.
5. Select and right-click the port you want to configure.
6. Select the port type (initiator, RCU target, or target).

The rightmost column of the list displays **Modified** to indicate you are modifying the port attribute.

The **Preset** list displays the changes you made. These changes are not applied to the disk array yet.

7. In the **Preset** list, check the settings.
  - To change the port attribute, select and right-click the port from the upper-right list, and select the new attribute.
  - To cancel a change in the port attribute, select and right-click the port in the **Preset** list, and click **Cancel**.



---

**WARNING!** Read and follow the important warnings and caution above before applying the port attribute changes.

---

8. Click **Apply** to apply port attribute changes to the disk array.

## Associating primary and remote disk arrays and configuring logical paths (Add DKC)

Use the Add DKC pane to associate the primary and secondary disk arrays and establish logical paths between the two disk arrays. *Logical paths* connect the primary and secondary disk arrays. The primary and secondary disk arrays use logical paths to communicate with each other.

One primary disk array can be associated with up to 64 secondary disk arrays. Up to eight logical paths can be configured between one primary disk array and one secondary disk array. Therefore, one primary disk array can have up to 512 logical paths to secondary disk arrays.

The primary and secondary disk array administrators must perform the following procedure:

1. Ensure that the remote copy connections and ports are properly configured. Also, obtain the remote disk array's serial number.



---

**NOTE:** To get the remote disk array's serial number, ask the remote disk array's administrator. The serial number is displayed in the Command View XP main pane when logging into the disk array.

---

2. Ensure that the Command View XP main pane is in Modify mode. For more information, see [Table 9](#) on page 98.

3. Ensure that the DKC Operation pane is displayed (see "[Displaying the DKC Operation pane](#)" on page 634.)

4. In the **Display** box, select **DKC**.

5. Select **Subsystem** from the tree.

6. Right-click the upper-right list, and select **DKC Operations** and **Add DKC**. The Add DKC pane appears.

7. In the Add DKC pane, enter the following:

- Remote disk array's serial number.
- Remote disk array's controller ID.



---

**NOTE:** The controller ID for an XP12000 disk array is **4**.

---

- Path group ID. The path group ID is within the range of 1-FF (hexadecimal). Up to 64 path group IDs can be registered per disk array.



---

**NOTE:** In the current version, the path group IDs always take the default values and cannot be changed.

---

8. In the Add DKC pane, select a primary and remote disk array port to configure a logical path.

9. Click **Option**.

10. In the DKC Option pane, configure logical path and disk array options. For more information about the options, see "[Changing options for logical paths and disk arrays](#)" on page 641.

11. Click **Set** to close the DKC Option pane.

12. In the **Preset** list, check the settings you made.

- To modify a setting, select and right-click the setting from the **Preset** list, and select **Modify**. A pane appears where you can modify the setting.
- To cancel a setting, select and right-click the setting in the **Preset** list, and select **Cancel**.

13. Click **Apply** to apply the settings.



**NOTE:** If an error occurs, the rightmost column of the **Preset** list displays the error code. To view detailed information about the error, right-click the error code, and select **Error Detail**. An error message appears providing detailed information about the error.

The Add DKC pane displays the following:

- **DKC S/N:** Enter the remote disk array's five-digit serial number.
- **Controller ID:** Enter the remote disk array's controller ID (that is, disk array family ID).



**NOTE:** The controller ID for an XP12000 disk array is **4**.

- **Path Gr. ID:** Enter the path group ID. Path group IDs are used for identifying groups of logical paths. One path group can contain up to eight logical paths. Path group IDs are within the range of 0-FF (hexadecimal). If you select the **Default** check box, the default path group IDs is set.



**NOTE:** In the current version, you cannot enter path group IDs. Also, you cannot clear the **Default** check box. The number of path group per one remote disk array is always 1.

- **M-R Path:** Specify logical paths from initiator ports on the local disk array to RCU target ports on the remote disk array.
  - **Port:** Displays a list of initiator ports on the local disk array. Select an initiator port from this drop-down list.
  - **Pair-Port:** Displays a list of all ports on the remote disk array. Select an RCU target port on the remote disk array from this drop-down list.



**NOTE:** When specifying a port, use the keyboard to enter the port number. When you enter the port number, you can abbreviate the port number into two characters. For example, you can enter **1A** instead of **CL1-A**. You can use uppercase and lowercase letters.

- **Option:** Displays the DKC Option pane (see "[Changing options for logical paths and disk arrays](#)" on page 641).
- **Cancel:** Cancels the settings made on the Add DKC pane and closes the pane.

## Changing options for logical paths and disk arrays

Use the DKC Option pane to set logical path and disk array options. These options apply to the local disk array.



---

**NOTE:** DKC is an acronym for disk controller, which controls an entire disk array. CA Journaling panes use the word DKC to indicate a disk array.

---

The primary and secondary disk array administrators can perform the following procedure:

1. Ensure that the Command View XP main pane is in Modify mode. For more information, see [Table 9](#) on page 98.
2. Ensure that the DKC Operation pane is displayed ("[Displaying the DKC Operation pane](#)" on page 634).
3. In the **Display** box, select **DKC**.
4. Select **Subsystem** from the tree. The list displays a list of remote disk arrays.
5. From the list, select and right-click the remote disk array.
6. Select **DKC Operations** and **Change DKC Option**. The DKC Option pane appears.
7. On the DKC Option pane, change the options as needed.
8. Click **Set** to close the DKC Option pane.
9. In the **Preset** list, check the settings you made.
  - To modify a setting, select and right-click the setting from the **Preset** list, and select **Modify**. A pane appears where you can modify the setting.
  - To cancel a setting, select and right-click the setting in the **Preset** list, and select **Cancel**.
10. Click **Apply** to apply the settings.



---

**NOTE:** If an error occurs, the rightmost column of the **Preset** list displays the error code. To view detailed information about the error, right-click the error code, and select **Error Detail**. An error message appears providing detailed information about the error.

---

The DKC Option pane displays the following:

- **Minimum Paths:** Specify the minimum number of paths required for each remote disk array connected to the local disk array (default = 1).

An error occurs if you enter a larger number than the number of paths already set on the Add DKC pane, or if the number of paths falls below this number (for example, due to path failures). When an error occurs, the local disk array suspends all affected CA Journaling (and Universal Replicator for z/OS) pairs to prevent remote copy operations from adversely affecting performance due to the inadequate number of paths.

If the local disk array contains CA Journaling pairs that contain critical data for disaster recovery, set the minimum number of paths to one, so CA Journaling operations continue even if there is only one path to a remote disk array.

If you need high performance at the local disk array, set the minimum number of paths to two or more, depending on the number of pairs the local disk array manages.

- **RIO MIH Time:** Specify the RIO MIH timer value, which is the wait time until data transfer from the local to remote disk array is complete. The RIO MIH time value must be from 10 to 100 seconds. The default setting is 15 seconds.





---

**NOTE:** RIO MIH is an acronym for remote I/O missing interrupt handler.

---

## Adding logical paths

Use the Add Path pane to add one or more logical paths between the local and remote disk arrays.

One primary disk array can be associated with up to 64 secondary disk arrays. Up to eight logical paths can be configured between one primary disk array and one secondary disk array. When you add a logical path, CA Journaling automatically starts using the new logical path to perform CA Journaling copy activities.

The primary and secondary disk array administrators can perform the following procedure.

1. Ensure that the remote copy connections are properly configured.
2. Ensure that the Command View XP main pane is in Modify mode. For more information, see [Table 9](#) on page 98.
3. Ensure that the DKC Operation pane is displayed (“[Displaying the DKC Operation pane](#)” on page 634).
4. In the **Display** box, select **DKC**.
5. Do one of the following:
  - In the tree, select a remote disk array.
  - In the list, select and right-click a remote disk array, and select **Edit Path(s)**. The list displays information about logical paths.
6. Right-click the list, and select **Add Path**. The Add Path pane appears.
7. Use the Add Path pane to configure up to eight new logical paths.
8. Click **Set** to close the Add Path pane.
9. In the **Preset** list, check the settings you made.
  - To modify a setting, select and right-click the setting from the **Preset** list, and select **Modify**. A pane appears where you can modify the setting.
  - To cancel a setting, select and right-click the setting in the **Preset** list, and select **Cancel**.
10. Click **Apply** to apply the settings.



---

**NOTE:** If an error occurs, the rightmost column of the **Preset** list displays the error code. To view detailed information about the error, right-click the error code, and select **Error Detail**. An error message appears providing detailed information about the error.

---

The Add Path pane displays the following:

- **Port:** Select an initiator port on the local disk array.



---

**NOTE:** When specifying a port, use the keyboard to enter the port number. When you enter the port number, you can abbreviate the port number into two characters. For example, you can enter **1A** instead of **CL1-A**. You can use uppercase and lowercase letters.

---

- **Pair-Port:** Select an RCU target port on the remote disk array.



---

**NOTE:** When specifying a port, use the keyboard to enter the port number. When you enter the port number, you can abbreviate the port number into two characters. For example, you can enter **1A** instead of **CL1-A**. You can use uppercase and lowercase letters.

---

- **Set:** Closes the Add Path pane, and adds settings to the **Preset** list.
- **Cancel:** Cancels settings.

## Deleting logical paths

Before deleting logical paths, ensure that the remaining number of logical paths will be greater than the minimum number of paths setting (see “[Changing options for logical paths and disk arrays](#)” on page 641). The delete path operation fails if the number of remaining paths is equal to or less than the minimum number of paths.

The primary and secondary disk array administrators can perform the following procedure:

1. Ensure that the Command View XP main pane is in Modify mode. For more information, see [Table 9](#) on page 98.
2. Ensure that the DKC Operation pane is displayed (“[Displaying the DKC Operation pane](#)” on page 634).
3. In the **Display** box, select **DKC**.
4. Do one of the following:
  - In the tree, select a remote disk array.
  - In the list, select and right-click a remote disk array, and select **Edit Path(s)**. The list displays information about logical paths.
5. In the list, select the logical paths you want to delete.
6. Right-click the list, and select **Delete Path**. A confirmation message appears.
7. Click **OK** to close the message.
8. In the DKC Operation pane, locate the upper-right list and the **Preset** list, and check the settings you made.
  - The right-most column of the upper-right list displays **Delete** to indicate logical paths to be deleted.
  - The **Preset** list displays logical paths to be deleted.
  - To cancel deleting logical paths, select and right-click the logical paths in the **Preset** list, and select **Cancel**.
9. Click **Apply** to delete the logical paths.



---

**NOTE:** If an error occurs, the rightmost column of the **Preset** list displays the error code. To view detailed information about the error, right-click the error code, and select **Error Detail**. An error message appears providing detailed information about the error.

---

## Viewing the status of logical paths

The DKC Status pane displays the status of logical paths.

The primary and secondary disk array administrators can perform the following procedure:

1. Ensure that the DKC Operation pane is displayed.

2. In the **Display** box, select **DKC**.
3. In the upper-right list, select and right-click a remote disk array or logical path.
  - To display remote disk arrays in the list, select **Subsystem** from the tree.
  - To display logical paths between the local and remote disk arrays, select the remote disk array from the tree.
4. Select **DKC Status**. The DKC Status pane appears.
  - If a remote disk array is selected in the list, the DKC status pane displays all logical paths between the local and remote disk arrays and shows the status of each path.
  - If a logical path is selected in the list, the DKC status pane displays only the status of the selected logical path.
5. Check the status of the logical paths, and click **Close** to close the DKC status pane.

The DKC Status pane displays the following:

- **List:**
  - **No.:** Serial numbers used for rows in the list.
  - **Path Status:** Status of a logical path (see [Table 129](#)).
  - **Port:** Indicates a port on the local disk array.
  - **Pair-Port:** Indicates a port on the remote disk array.
- **DKC S/N:** Remote disk array's serial number.
- **Path Gr. ID:** Path group ID.
- **M-R Path:** Type of channel interface between the local and remote disk arrays. This column displays **fibre**.
- **Minimum Paths:** Minimum possible number of paths between the local and remote disk arrays.
- **RIO MIH Time:** RIO MIH timer value, which is the wait time until data transfer from the local to remote disk array is complete.



**NOTE:** RIO MIH is an acronym for remote I/O missing interrupt handler.

- **DKC Registered:** Date and time when the local and remote disk arrays are associated to each other.
- **Last Updated:** Date and time when the last operation on a logical path to the remote disk array was performed.
- **Refresh the DKC Operations tab after this panel is closed:** If selected, information in the DKC Operation pane is refreshed after you close the DKC Status pane.
- **Refresh:** Refreshes the information in the DKC Status pane.
- **Close:** Closes the DKC Status pane.

**Table 129** Logical path status

Status	Remarks
Normal	This path was successfully established and can be used for CA Journaling remote copy activities.

**Table 129** Logical path status (continued)

Status	Remarks
Nothing	An operation for configuring or deleting this logical path is in progress.
Initialization Failed	An error occurred with initialization of connection between the local and remote disk array. The probable causes are: <ul style="list-style-type: none"> <li>• No cable is connected to the local disk array.</li> <li>• No cable is connected to the remote disk array.</li> <li>• No cable is connected to the network device that comes between the local and remote disk arrays.</li> </ul>
Communication Time Out	This status indicates one of the following: <ul style="list-style-type: none"> <li>• A timeout error occurred between the primary and secondary disk arrays.</li> <li>• A logic error was detected between the primary and secondary disk arrays.</li> </ul>
Resource Shortage (Port)	The local disk array rejected the function for configuring logical path connection. All logical path resources in the local disk array might be used for other connections.
Resource Shortage (Pair-Port)	The remote disk array rejected the function for configuring logical path connection. All logical path resources in the remote disk array might be used for other connections.
Serial Number Mismatch	The serial number of the disk array connected to this logical path does not match the serial number specified by the Add DKC pane.
Invalid Port	The port is not an initiator port.
Pair-Port Number Mismatch	This status indicates one of the following: <ul style="list-style-type: none"> <li>• The specified port number is incorrect.</li> <li>• The port in the remote disk array is physically disconnected from the local disk array.</li> </ul>
Pair-Port Type Mismatch	The port on the remote disk array is not an RCU target port.
Communication Failed	A communication timeout error has occurred on the path between the primary and the secondary disk arrays.

## Removing the relationship between primary and secondary disk arrays

Use the DKC Operations pane to remove the relationship between the primary and secondary disk arrays and then remove all logical paths between the two disk arrays. The primary and secondary disk array administrators must perform the following procedure:

1. Ensure that all affected CA Journaling volume pairs have been deleted.
2. Ensure that the Command View XP main pane is in Modify mode. For more information, see [Table 9](#) on page 98.
3. Ensure that the DKC Operation pane is displayed.
4. In the **Display** box, select **DKC**.
5. Select **Subsystem** from the tree. The list displays remote disk arrays.
6. Select and right-click the remote disk arrays from the list.

7. Select **DKC Operations** and **Delete DKC**. A confirmation message appears.
8. Click **OK** to close the message.
9. In the **Preset** list, check the settings you made.
  - The **Preset** list displays the specified remote disk arrays. One row indicates one remote disk array.
  - To cancel removal of the relationship, select and right-click the remote disk array in the **Preset** list, and select **Cancel**.
10. Click **Apply** to remove the relationship.

---

## Using journal groups

To introduce CA Journaling in your system and configure your system for remote copy operations, the primary and secondary site administrators must configure *journal groups*, ports, and logical paths. Also, these administrators must register journal volumes in journal groups. During CA Journaling remote copy operations, data in primary volumes are copied by journal volumes to secondary volumes.

When configuring journal groups, the administrators must do the following:

- ["Displaying the Journal Operation pane"](#) on page 647
- ["Registering journal volumes in journal groups"](#) on page 651

When configuring journal groups, the administrator should do the following when necessary:

- ["Deleting journal volumes from journal groups"](#) on page 653
- ["Displaying detailed information about journal groups"](#) on page 654
- ["Changing options for journal groups"](#) on page 657
- ["Deleting journal groups"](#) on page 658

When CA Journaling is used for remote copy operations, the administrator should do the following when necessary:

- ["Splitting mirrors \(Pairsplit-r: suspending copy operations\)"](#) on page 659
- ["Restoring mirrors \(Pairresync: resuming copy operations\)"](#) on page 660
- ["Deleting data volumes from mirrors \(Pairsplit-S: ending copy operations\)"](#) on page 661



**NOTE:** Throughout this chapter, the primary and secondary disk arrays are sometimes referred to as *local disk arrays* and *remote disk arrays*. If you are logged into the primary disk array and are using CA Journaling, the primary disk array is a *local* disk array and the secondary disk array is a *remote* disk array. If you are logged into the secondary disk array and are using CA Journaling, the secondary disk array is a *local* disk array and the primary disk array is a *remote* disk array.

---

## Displaying the Journal Operation pane

To configure journal groups, use the Journal Operation pane of CA Journaling.

### CA Journaling has not been started

1. Use your Web browser to display the storage device list. In the storage device list, select the disk array to log into. Enter a user name and the password, and click **OK**. The Command View XP main pane appears. For more information, see ["Getting started"](#) on page 39.

2. On the Command View XP main pane, select the **Continuous Access XP Journal** button (). CA Journaling starts.
3. Select the **Journal Operation** tab. The Journal Operation pane appears.

## CA Journaling has already been started

1. Select the **Journal Operation** tab. The Journal Operation pane appears.

## Journal Operation pane components

The Journal Operation pane displays the following:

- **Tree:** Lists journal groups in the local disk array you are logged into.





**NOTE:** The tree displays journal groups used with CA Journaling, and does not display journal groups used with UR390 (Universal Replicator for z/OS).

- **Journal Groups:** Located at the top of the tree. When selected, the upper-right list displays journal groups in the local disk array.
- **Registered:** When selected, the upper-right list displays the journal groups in which journal volumes are registered.

When you double-click this item, the tree displays journal groups in which journal volumes are registered. When you select a journal group in the tree, information about the journal group appears in the upper-right list.

The journal group icons are:

 <b>Initial</b>	A journal group in initial status.  Journal volumes are registered in this journal group, but no data volumes (primary or secondary volumes) are registered in this journal group.
 <b>Master</b>	A master journal group.  Journal groups and primary volumes are registered in this journal group.
 <b>Restore</b>	A restore journal group.  Journal groups and secondary volumes are registered in this journal group.

- **Free:** When selected, the upper-right list displays the journal groups in which no journal volumes are registered.

When you double-click this item, the tree displays the journal groups in which no journal volumes are registered.

For more information, see ["Registering journal volumes in journal groups"](#) on page 651.



- **Upper-right list:** If a master journal group or a restore journal group is selected in the tree, the upper-right list displays a list of *mirrors*. A mirror is a combination of a master journal group and a restore journal group.

If another journal group is selected in the tree, the upper-list displays information about the selected journal group.







One row in this list represents one mirror (or one journal group).

- **JNLG:** Number of a journal group in the local disk array.

- **Attribute:** Attribute of a journal group in the local disk array.

 <b>Initial</b>	A journal group in initial status. Journal volumes are registered in this journal group, but no data volumes (primary nor secondary volumes) are registered in this journal group.
 <b>Master</b>	A master journal group. Journal groups and primary volumes are registered in this journal group.
 <b>Restore</b>	A restore journal group. Journal groups and secondary volumes are registered in this journal group.
<b>Blank</b>	Journal and data volumes are not registered in this journal group.

- **Status:** Status of a journal group in the local disk array.

 <b>Initial</b>	A journal group in initial status. Journal volumes are registered in this journal group, but no data volumes (primary nor secondary volumes) are registered in this journal group.  When you create a CA Journaling volume pair, data volumes are registered in a journal group. The status of the journal group changes to <b>Active</b> .
 <b>Active</b>	Either of the following: <ul style="list-style-type: none"> <li>• Initial copy is in progress. The primary and secondary volumes are not synchronized.</li> <li>• Initial copy is finished. The primary and secondary volumes are synchronized.</li> </ul>
 <b>HaltAccept</b>	An operation for splitting the mirror has been started. The status of the journal group immediately changes to <b>Halting</b> .  <b>NOTE:</b> <b>HaltAccept</b> can indicate the status of restore journal groups, but cannot indicate the status of master journal groups.
 <b>Halting</b>	An operation for splitting or deleting the mirror is in progress. The primary and secondary volumes are not synchronized.  When you split a mirror, the status changes in the following order: <b>Halting, Halt, Stopping</b> , and finally <b>Stop</b> .  When you delete a mirror, the status changes in the following order: <b>Halting, Halt, Stopping, Stop</b> , and finally <b>Initial</b> .
 <b>Halt</b>	An operation for splitting or deleting the mirror is in progress. The primary and secondary volumes are not synchronized.
 <b>Stopping</b>	An operation for splitting or deleting the mirror is in progress. The primary and secondary volumes are not synchronized.

 <b>Stop</b>	<p>Either of the following:</p> <ul style="list-style-type: none"> <li>• The operation for splitting the mirror is finished.</li> <li>• The operation for deleting the mirror is in progress.</li> </ul> <p>The primary and secondary volumes are not synchronized.</p>
Blank	No data volumes are registered in this journal group.

- **Mirror ID:** Mirror ID. This column is blank if the journal group's attribute is neither **Master** nor **Restore**.
- **S/N:** Remote disk array's serial number. This column is blank if the journal group's attribute is neither **Master** nor **Restore**.
- **Pair JNLG:** Number of a journal group in the remote disk array. This column is blank if the journal group's attribute is neither **Master** nor **Restore**.
- **Controller ID:** Remote disk array's controller ID (that is, disk array family ID). This column is blank if the journal group's attribute is neither **Master** nor **Restore**.



**NOTE:** The controller ID for an XP12000 disk array is **4**.

- **Path Gr. ID:** Path group IDs, which are used to identify path groups (that is, groups of logical paths). Up to eight logical paths can be registered in one path group. This column is blank if the journal group's attribute is neither **Master** nor **Restore**.
- **CTG:** Number of a consistency group to which the mirror belongs. This column is blank if the journal group does not have any volume pair.
- **Preset:** Detailed information about operations that will occur when you click **Apply**.
- **List:** Displays changes made in the pane. When you change settings in the pane, the changes are displayed in the **Preset** list before the changes are applied to the disk arrays. If you are sure that information in the **Preset** is correct, click **Apply** to apply the settings.



**NOTE:** When the **Preset** list displays changes made, you can only perform the same type of operation that you have been doing, and cannot perform most other operations. You can only view detailed information about journal groups even when the **Preset** list displays changes. For example, if you are trying to delete journal groups and the **Preset** list displays the journal groups you want to delete, you cannot perform other operations, such as splitting or restoring mirrors.

- **Operation:** Indicates the operation that will occur when you click **Apply**.
  - **Edit JNL Volumes:** Register or delete journal volumes
  - **Change JNL Option:** Change journal group options
  - **Delete JNL Groups:** Delete journal group
  - **Pairsplit -r:** Split a mirror
  - **Pairresync:** Restore a mirror
  - **Pairsplit -S:** Delete a mirror
  - Blank: Nothing occurs when you click **Apply**



- **Preset:** The number to the left of the slash (/) is the number of items displayed in the **Preset** list. The number to the right of the slash is the maximum number of items that can be displayed in the **Preset** list. For example, if **Preset 010/256** is displayed, you can add another 246 items to the **Preset** list.
- **Apply:** Applies settings in the **Preset** list to the disk arrays.
- **Cancel:** Cancels settings in the **Preset** list.



**NOTE:** Information on the Journal Operation pane is updated when you do one of the following:

- Select another tab, and reselect the Journal Operation tab.
  - Click **Refresh** (top right of Command View XP pane).
  - Click **Apply**.
  - Select Modify mode when you are in View mode.
- 

## Registering journal volumes in journal groups

To perform remote copy operations with CA Journaling, the primary site administrator must register journal volumes in journal groups in the primary disk array. Also, the secondary site administrator must register journal volume in journal groups in the secondary disk array. One journal group can contain up to 16 journal volumes.

The primary and remote disk array administrators must perform the following procedure:

1. Ensure that the Command View XP main pane is in Modify mode. For more information, see [Table 9](#) on page 98.
2. Ensure that the Journal Operation pane is displayed (“[Displaying the Journal Operation pane](#)” on page 647.)
3. In the tree of the Journal Operation pane, do one of the following:
  - To register new volumes to a journal group in which journal groups are already registered, select the journal group from below **Registered**.



**CAUTION:** You can register volumes only when the attribute of the journal group is Initial or when the status of the journal group is Stop.

- To register volumes to a journal group in which journal groups have not been registered, select the journal group from below **Free**.
- 



**NOTE:** You cannot select more than one journal group.

4. Do one of the following:
  - In the tree, right-click the selected journal group, and select **Edit JNL Volumes**.
  - In the upper-right list, right-click the desired journal group, and select **Edit JNL Volumes**.
5. In the **Free Volumes** list of the **Edit JNL Volumes** pane, select the volumes you want to register.

In the **Free Volumes** list, one row represents one volume. If you cannot find the volumes you want to register, do one of the following:

- Select **Parity Group**, enter a parity group number in the text boxes to the right, and click **Show**. The list displays volumes in the specified parity group. Select the volumes you want to register.
- Select **CU**, and select a CU number from the drop-down list to the right. The list displays volumes in the specified CU. Select the volumes you want to register.



**NOTE:** The **Free Volume** list only displays OPEN-V volumes belonging to CLPRO (that is, the CLPR numbered 00), and does not display external volumes. For more information about CLPRO, see “[Disk/Cache Partition for the XP12000](#)” on page 143.

6. Click **Add**. The **JNL Volumes** list displays the volumes you want to register. The **Operation** column of the list displays **Add**.
7. Click **Set** to close the Edit JNL Volumes pane.
8. In the **Preset** list, check the settings you made.
  - To add volumes to register, select and right-click a volume in the **Preset** list, and select **Modify**. A pane appears where you can add volumes.
  - To cancel registering a volume, select and right-click the volume, and select **Cancel**.
  - If necessary, repeat steps [step 3](#) through [step 8](#) to add volumes to other journal groups.
9. Click **Apply** to register journal volumes. After volumes are registered, the journal groups are displayed below **Registered** in the tree.



**NOTE:** If an error occurs, the rightmost column of the **Preset** list displays the error code. To view detailed information about the error, right-click the error code, and select **Error Detail**. An error message appears providing detailed information about the error.

The Edit JNL Volumes pane displays the following:

- **JNL Volumes:** Information about journal volumes.
- **Parity Group:** Parity group or external volume group where a journal volume belongs.



**NOTE:** If **E** is displayed at the beginning of a group, the group is an external volume group. Currently, however, the pane does not display external volumes.

- **CU:LDEV:** Journal volume’s CU and LDEV numbers. The CU number is displayed to the left of the colon (:). The LDEV number is displayed to the right of the colon.



**NOTE:** If **#** is displayed at the end of a volume, the volume is an external volume. Currently, however, the pane does not display external volumes.

- **Capacity:** Journal volume’s capacity in gigabytes.
- **Emulation:** Journal volume’s emulation type.
- **Operation:** Displays one of the following:
  - **Blank:** This column is usually blank.
  - **Add:** Volume to be added to a journal group.

- **Delete:** Volume to be deleted from a journal group.
- **Add:** Registers volumes in a journal group. When registering volumes, select the volumes from **Free Volumes**, and click **Add** to add the volumes to **JNL Volumes**.
- **Delete:** Deletes volumes from a journal group. When deleting volumes, select the volumes from **JNL Volumes**, and click **Delete**.
- **Free Volumes:** Information about free volumes, which are not registered in journal groups.
  - **Parity Group:** Parity group or external volume group where a volume belongs.



**NOTE:** If **E** is displayed at the beginning of a group, the group is an external volume group. Currently, however, the pane does not display external volumes.

- **CU:LDEV:** Volume's CU and LDEV numbers. The CU number is displayed to the left of the colon (:). The LDEV number is displayed to the right of the colon.



**NOTE:** If **#** is displayed at the end of a volume, the volume is an external volume. Currently, however, the pane does not display external volumes.

- **Capacity:** Volume's capacity in gigabytes.
- **Emulation:** Volume's emulation type.
- **Operation:** Displays one of the following:
  - **Blank:** This column is usually blank.
  - **Add:** Volume to be added to a journal group.
  - **Delete:** Journal volume to be deleted from a journal group.
- **Parity Group/CU change:** Change the information displayed in the **Free Volumes** list.
  - **Parity Group:** Displays volumes belonging to a parity group. If selected, specify a parity group number in the text boxes to the right, and click **Show**.
  - **CU:** Displays volumes belonging to a CU. If selected, select a CU from the drop-down list to the right.
- **JNL Group:** Journal group's number.
- **Current:** Number and capacity of journal volumes that currently exist in the journal group.
- **Total:** Estimates the number and capacity of journal volumes after addition or deletion, and displays the estimated number and capacity.
- **Set:** Applies settings in the pane to the Journal Operation pane.
- **Cancel:** Cancels settings.

## Deleting journal volumes from journal groups

To delete journal volumes from the primary disk array, log into the primary disk array.

To delete journal volumes from the secondary disk array, log into the secondary disk array.

1. Ensure that the Command View XP main pane is in Modify mode. For more information, see [Table 9](#) on page 98.

2. Ensure that the Journal Operation pane is displayed (see “[Displaying the Journal Operation pane](#)” on page 647).
3. Select a journal group from below **Registered** in the tree.



**NOTE:** You cannot select more than one journal group.

4. Do one of the following:
  - In the tree, right-click the selected journal group, and select **JNL Volumes**.
  - In the upper-right list, select and right-click the desired journal group, and select **JNL Volumes**.



**CAUTION:** You can delete volumes only when the journal group’s attribute is Initial or the journal group’s status is **Stop**.

5. In the **JNL Volumes** list of the Edit JNL Volumes pane, select the volumes you want to delete. In the **JNL Volumes** list, one row represents one volume.
6. Click **Delete**. The volumes you want to delete are displayed in blue italics. The **Operation** column of the list displays **Delete**.
7. Click **Set** to close the Edit JNL Volumes pane.
8. In the **Preset** list, check the volumes you want to delete.
  - To add volumes to delete, select and right-click a volume in the **Preset** list, and select **Modify**. A pane appears where you can specify volumes to delete.
  - To cancel deleting a volume, select and right-click the volume, and select **Cancel**.
  - If necessary, repeat [step 3](#) through [step 8](#) to specify volumes that should be deleted from other journal groups.
9. Click **Apply** to delete journal volumes.



**NOTE:** If an error occurs, the rightmost column of the **Preset** list displays the error code. To view detailed information about the error, right-click the error code, and select **Error Detail**. An error message appears providing detailed information about the error.

## Displaying detailed information about journal groups

To display detailed information about journal groups in the primary disk array, log into the primary disk array.

To display detailed information about journal groups in the secondary disk array, log into the secondary disk array.

1. Ensure that the Journal Operation pane is displayed (see “[Displaying the Journal Operation pane](#)” on page 647).
2. Select a journal group in the tree.



**NOTE:** You cannot select more than one journal group.

3. Do one of the following:
  - In the tree, right-click the selected journal group, and select **JNL Groups** and **JNL Status**.
  - In the upper-right list, right-click the desired journal group, and select **JNL Groups** and **JNL Status**.
4. In the JNL Group Detail pane, view detailed information about the journal group.
5. Select **Close** to close the JNL Group Detail pane.

The JNL Group Detail pane displays the following:

- **JNL Group:** Journal group's number.
- **Attribute:** Journal group's attribute.
  - **Initial:** A journal group in initial status. Journal volumes are registered in this journal group, but no data volumes (primary or secondary volumes) are registered in this journal group.
  - **Master:** A master journal group. Journal groups and primary volumes are registered in this journal group.
  - **Restore:** A restore journal group. Journal groups and secondary volumes are registered in this journal group.
  - Blank: Journal volumes and data volumes are not registered in this journal group.
- **JNL Volumes:** Number of journal volumes registered in the journal group.
- **JNL Capacity:** Total capacity of all registered journal volumes.
- **Data Volumes:** Number of data volumes associated with the journal group.
- **Data Capacity:** Total capacity of all data volumes.
- **Meta/Data Ratio:** Ratio of metadata area to journal data area. For example, if 16 is displayed, the ratio of metadata area to journal data area is 1:16. If 32 is displayed, the ratio of metadata area to journal data area is 1:32.
- **Extent:** Number of extents.
- **Inflow Control:** Indicates whether inflow of update I/Os to the journal cache is restricted (in other words, whether to slow delay response to hosts).
  - **Yes:** Inflow is restricted.
  - **No:** Inflow is not restricted.

**Inflow Control** displays nothing if the journal group is a restore journal group.

- **Data Overflow Watch:** Time (in seconds) for monitoring whether metadata and journal data are full.

**Data Overflow Watch** displays nothing when one of the following conditions is satisfied:

- **Inflow Control** is **No**.
- The journal group is a restore journal group.
- **Cache Overflow Watch:** Time (in seconds) for monitoring whether the journal cache is full.

**Cache Overflow Watch** displays nothing when one of the following conditions is satisfied:

- **Inflow Control** is **No**.
- The journal group is a restore journal group.

- **Copy Pace:** Pace for an initial copy activity for one volume: **High**, **Medium**, or **Low**.  
**Copy Pace** displays nothing if the journal group is a restore journal group.
- **JNL Volumes:** List of registered journal volumes.
  - **Parity Group:** Parity group where a journal volume belongs.
  - **CU:LDEV:** Journal volume's CU and LDEV number. The CU number is displayed to the left of the colon (:). The LDEV number is displayed to the right of the colon.
  - **Capacity:** Journal volume's capacity in gigabytes.
  - **Emulation:** Journal volume's emulation type.
- **Mirrors:** List of mirrors.
  - **Mirror ID:** Mirror ID. This column is blank if the journal group's attribute is neither **Master** nor **Restore**.
  - **Status:** Status of a journal group (or a mirror) in the local disk array.

<b>Initial</b>	<p>A journal group in initial status.</p> <p>Journal volumes are registered in this journal group, but no data volumes (primary or secondary) are registered in this journal group.</p> <p>When you create a CA Journaling volume pair, data volumes are registered in a journal group. The status of the journal group changes to <b>Active</b>.</p>
<b>Active</b>	<p>Either of the following:</p> <ul style="list-style-type: none"> <li>• Initial copy is in progress. The primary and secondary volumes are not synchronized.</li> <li>• Initial copy is finished. The primary and secondary volumes are synchronized.</li> </ul>
<b>HaltAccept</b>	<p>An operation for splitting the mirror has started. The status of the mirror immediately changes to <b>Halting</b>.</p> <hr/> <p><b>NOTE:</b> <b>HaltAccept</b> can indicate the status of restore journal groups, but cannot indicate the status of master journal groups.</p> <hr/>
<b>Halting</b>	<p>An operation for splitting or deleting the mirror is in progress. The primary and secondary volumes are not synchronized.</p> <p>When you split a mirror, the status changes in the following order: <b>Halting</b>, <b>Halt</b>, <b>Stopping</b>, and finally <b>Stop</b>.</p> <p>When you delete a mirror, the status changes in the following order: <b>Halting</b>, <b>Halt</b>, <b>Stopping</b>, <b>Stop</b>, and finally <b>Initial</b>.</p>
<b>Halt</b>	<p>An operation for splitting or deleting the mirror is in progress. The primary and secondary volumes are not synchronized.</p>
<b>Stopping</b>	<p>An operation for splitting or deleting the mirror is in progress. The primary and secondary volumes are not synchronized.</p>

<b>Stop</b>	<p>Either of the following:</p> <ul style="list-style-type: none"> <li>• The operation for splitting the mirror is finished.</li> <li>• The operation for deleting the mirror is in progress.</li> </ul> <p>The primary and secondary volumes are not synchronized.</p>
<b>Blank</b>	The journal volumes and data volumes are not registered in this journal group.

- **CTG:** Number of a consistency group to which the mirror belongs. This column is blank if there is no consistency group.
- **S/N:** Remote disk array's serial number.
- **Pair JNLG:** Number of a journal group in the remote disk array.
- **Controller ID:** Remote disk array's controller ID (that is, disk array family ID).



**NOTE:** The controller ID for an XP12000 disk array is **4**.

- **Path Watch Threshold:** Threshold for monitoring blockade of paths to the remote disk array.
- **Path Watch Time:** Time for monitoring blockade of paths to the remote disk array.
- **Previous:** Displays detailed information about the previous journal group.
- **Next:** Displays detailed information about the next journal group.
- **Close:** Closes the JNL Group Detail pane.

## Changing options for journal groups

To change options for a journal group, log into the primary disk array.

1. Ensure that the Command View XP main pane is in Modify mode. For more information, see [Table 9](#) on page 98.
2. Ensure that the Journal Operation pane is displayed (see "Displaying the Journal Operation pane" on page 647).
3. Do one of the following:
  - In the tree, right-click a journal group from below **Registered**, and select **JNL Groups** and **Change JNL Option**.
  - In the upper-right list, right-click the desired journal group, and select **JNL Groups** and **Change JNL Option**.



**CAUTION:** You can select **Change JNL Option** only when one of the following conditions is satisfied:

- The journal group's attribute is **Initial**.
- The journal group's attribute is **Master**, and the journal group's status is **Stop**.

4. In the Change JNL Option pane, change journal group options, and click **Set**.
5. In the **Preset** list, check the settings you made.
  - To modify a setting, select and right-click the setting in the **Preset** list, and select **Modify**.

- To cancel a setting, select and right-click the setting, and select **Cancel**.

6. Click **Apply** to apply the settings.



**NOTE:** If an error occurs, the rightmost column of the **Preset** list displays the error code. To view detailed information about the error, right-click the error code, and select **Error Detail**. An error message appears providing detailed information about the error.

---

The Change JNL Option pane displays the following:

- **Meta/Data Ratio:** Specify the ratio of metadata area to journal data area. For example, if you select 16, the ratio of metadata area to journal data area is 1:16. If you select 32, the ratio of metadata area to journal data area is 1:32.



**NOTE:** Currently, you cannot change the ratio of metadata area to journal data area.

---

- **Extent:** Specify the number of extents.



**NOTE:** Currently, the number of extents is always 32 and cannot be changed.

---

- **Inflow Control:** Specify whether inflow of update I/Os to the journal cache is restricted (in other words, whether to slow delay response to hosts).
  - **Yes:** Inflow is restricted.
  - **No:** Inflow is not restricted.
- **Data Overflow Watch:** Time (in seconds) for monitoring whether metadata and journal data are full. This value must be within the range of 0 to 600 seconds.



**NOTE:** Currently, the value of **Data Overflow Watch** is predefined and cannot be changed. If **Inflow Control** is **No**, **Data Overflow Watch** does not take effect and does not display anything.

---

- **Cache Overflow Watch:** Time (in seconds) for monitoring whether the journal cache is full. This value must be within the range of 0 to 600 seconds.



**NOTE:** Currently, the value of **Cache Overflow Watch** is predefined and cannot be changed. If **Inflow Control** is **No**, **Cache Overflow Watch** does not take effect and does not display anything.

---

- **Copy Pace:** Pace for an initial copy activity for one volume: **High**, **Medium**, or **Low**.
- **Set:** Applies settings in the pane to the Journal Operation pane ("[Displaying the Journal Operation pane](#)" on page 647).
- **Cancel:** Cancels settings.

## Deleting journal groups

To delete a journal group from the primary disk array, log into the primary disk array.

To delete a journal group from the secondary disk array, log into the secondary disk array.





---

**NOTE:** You cannot delete master and restore journal groups. You can only delete journal groups whose attribute is **Initial**.

---

1. Ensure that the Command View XP main pane is in Modify mode. For more information, see [Table 9](#) on page 98.
2. Ensure that the Journal Operation pane is displayed (see “[Displaying the Journal Operation pane](#)” on page 647).
3. Do one of the following:
  - In the upper-right list, right-click a journal group whose attribute is **Initial**.
  - In the tree, select and right-click a journal group in initial status.
4. Select **JNL Groups** and **Delete JNL**.
5. In the **Preset** list, check the journal groups you want to delete.
  - To cancel deleting a journal group, select and right-click the journal group, and select **Cancel**.
  - If necessary, repeat [step 3](#) through [step 5](#) to specify other journal groups.
6. Click **Apply**.



---

**NOTE:** If an error occurs, the rightmost column of the **Preset** list displays the error code. To view detailed information about the error, right-click the error code, and select **Error Detail**. An error message appears providing detailed information about the error.

---

## Splitting mirrors (Pairsplit-r: suspending copy operations)

A mirror is a combination of a master journal group and a restore journal group. If you split a mirror, copying data from the master journal group to the restore journal group is suspended.

The primary and secondary disk array administrators can perform the following procedure:

1. Ensure that the Command View XP main pane is in Modify mode. For more information, see [Table 9](#) on page 98.
2. Ensure that the Journal Operation pane is displayed (see “[Displaying the Journal Operation pane](#)” on page 647).
3. Do one of the following:
  - In the tree, select a master or restore journal group from below **Registered**.
  - In the tree, select **Subsystem** or **Registered**, and select a master or restore journal group from the list to the right.

A list of mirrors is displayed. One row in the list represents one mirror.

4. Locate mirrors that are in **Active** status.
5. From the mirrors, select and right-click the mirrors you want to split.
6. Select **JNL Groups** and **Pairsplit-r**.
7. In the Pairsplit-r pane, specify parameters, and click **Set**.
8. In the **Preset** list, check the mirrors you want to split.
  - To modify a mirror’s parameters, select and right-click the mirror, and select **Modify**.

- To cancel splitting a mirror, select and right-click the mirror, and select **Cancel**.
- If necessary, repeat [step 3](#) through [step 8](#) to specify other mirrors.

9. Click **Apply**.



**NOTE:** If an error occurs, the rightmost column of the **Preset** list displays the error code. To view detailed information about the error, right-click the error code, and select **Error Detail**. An error message appears providing detailed information about the error.

The Pairsplit-r pane displays the following:

- **S-VOL Write:** Specify whether hosts can issue read I/O and write I/O to the secondary volume after the mirror is split.
  - **Enable:** Hosts can issue read I/O and write I/O to the secondary volume after you split the mirror.
  - **Disable:** Hosts cannot issue read I/O and write I/O to the secondary volume after you split the mirror. This is the default.

This parameter takes effect only when the selected volume is a master journal group.

- **Range:** Split range. This is always set to **Group** and cannot be changed.
- **Suspend Mode:** Specify how to handle update data that is not reflected to the secondary volume.
  - **Flush:** Update data is reflected to the secondary volume when you split the mirror. This is the default.
  - **Purge:** Update data is not reflected to the secondary volume when you split the mirror. If you restore the mirror, update data is reflected to the secondary volume.

## Restoring mirrors (Pairresync: resuming copy operations)

A mirror is a combination of a master journal group and a restore journal group. If you split a mirror, copying data from the master journal group to the restore journal group is suspended. To restart data copying, restore the mirror.

Only the primary disk array administrator can perform the following procedure:

1. Ensure that the Command View XP main pane is in Modify mode. For more information, see [Table 9](#) on page 98.
2. Ensure that the Journal Operation pane is displayed (see “[Displaying the Journal Operation pane](#)” on page 647).
3. Do one of the following:
  - In the tree, select a master or restore journal group from below **Registered**.
  - In the tree, select **Journal Groups** or **Registered**, and select a master journal group from the list to the right.

A list of mirrors displays. One row in the list represents one mirror.

4. Locate mirrors that are in **Stop** status.
5. From the mirrors, select and right-click the mirrors you want to restore.
6. Select **JNL Groups** and **Pairresync**.
7. In the **Preset** list, check the mirrors you want to restore.
  - To cancel restoring a mirror, select and right-click the mirror, and select **Cancel**.

- If necessary, repeat [step 3](#) through [step 7](#) to specify other mirrors.

8. Click **Apply** to restore the mirrors.



**NOTE:** If an error occurs, the rightmost column of the **Preset** list displays the error code. To view detailed information about the error, right-click the error code, and select **Error Detail**. An error message appears providing detailed information about the error.

---



**NOTE:** The **Range** column indicates the unit used for splitting the mirror, and always displays **Group**. The **Base Start** column indicates whether copying of base-journal starts after you restore the mirror, and always displays **Yes**.

---

## Deleting data volumes from mirrors (Pairsplit-S: ending copy operations)

A mirror is a combination of a master journal group and a restore journal group. If you delete data volumes (that is, the primary and secondary volume) from a mirror, copying data from the master journal group to the restore journal group ends.

The primary and secondary disk array administrators can perform the following procedure:

1. Ensure that the Command View XP main pane is in Modify mode. For more information, see [Table 9](#) on page 98.
2. Ensure that the Journal Operation pane is displayed (see “[Displaying the Journal Operation pane](#)” on page 647).
3. Do one of the following:
  - In the tree, select a master or restore journal group from below **Registered**.
  - In the tree, select **Journal Groups** or **Registered**, and select a master or restore journal group from the list to the right.

A list of mirrors displays. One row in the list represents one mirror.

4. Locate mirrors that are not in **Initial** status.
5. Select and right-click the mirrors from which you want to delete data volumes.
6. Select **JNL Groups** and **Pairsplit-S**.
7. In the **Preset** list, check the settings you made.
  - To cancel a setting, select and right-click the setting, and select **Cancel**.
  - If necessary, repeat [step 3](#) through [step 7](#) to specify other mirrors.
8. Click **Apply** to delete data volumes from the mirrors.



**NOTE:** If an error occurs, the rightmost column of the **Preset** list displays the error code. To view detailed information about the error, right-click the error code, and select **Error Detail**. An error message appears providing detailed information about the error.

---



---

**NOTE:** The **Range** column indicates the unit used for splitting the mirror, and always displays **Group**. The **Mode** column indicates how the data volumes are deleted, and always displays **Normal** (normal deletion, not forced deletion).

---

## Performing CA Journaling pair operations

To perform remote copy operations with CA Journaling, you must create pairs of a *primary volume* and a *secondary volume*. A primary volume is a data volume to be copied. A secondary volume is a data volume that is the copy destination for a primary volume. To manipulate pairs of these data volumes, use the Pair Operation pane of CA Journaling.



---

**NOTE:** This manual sometimes uses the term “volume pair” when referring to a pair of a primary volume and a secondary volume.

---

## Displaying the Pair Operation pane

To manipulate pairs of primary and secondary volumes, use the Pair Operation pane.

To display the Pair Operation pane, do one of the following:

### CA Journaling has not been started

1. Use your Web browser to display the storage device list. In the storage device list, select the disk array to log into. Enter a user name and the password, and click **OK**. The Command View XP main pane appears. For more information, see “[Getting started](#)” on page 39.
2. On the Command View XP main pane, click the **Continuous Access XP Journal** button (). CA Journaling starts.
3. Click the **Pair Operation** tab. The Pair Operation pane appears.

### CA Journaling has already been started

1. Click the **Pair Operation** tab. The Pair Operation pane appears.

## Pair Operation pane components

The Pair Operation pane displays the following:

- **Tree:** Lists ports in the local disk array. Below each port appear host groups. If you select a port or a host group, the list displays volumes for the port or the host group. You can select only one port or one host group at one time and cannot select two or more simultaneously.
- **Upper-right buttons:** The following buttons appear at the upper-right corner of the pane:
  - **Display Filter:** Displays the Display Filter pane. Use this pane to narrow information in the list, so the list displays only the volumes that satisfy certain conditions. For more information, see “[Filtering information in the list in the Pair Operation pane](#)” on page 666.
  - **Snapshot:** Saves information about volume pairs in a text file. For more information, see “[Saving pair status information to a text file](#)” on page 666.
  - **Previous:** The list can display up to 1,024 volume pairs simultaneously. If the number of volume pairs exceeds 1,024, use the **Previous** button to display the previous 1,024 volume pairs in the list.

- **Next:** The list can display up to 1,024 volume pairs simultaneously. If the number of volume pairs exceeds 1,024, use the **Next** button to display the next 1,024 volume pairs in the list.
- **List:** Displays volumes in the local disk array. One row represents one volume.

By default, information in the list is arranged in order of port numbers. For volumes with more than one path, each path is displayed in a separate row.



**NOTE:** Use the vertical and horizontal scroll bar if the information you want to view is hidden and invisible.

Currently, the list can only display volumes belonging to CLPRO (that is, the CLPR numbered 00). For more information about CLPRO, see ["Disk/Cache Partition for the XP12000"](#) on page 143.

- **Port-G-ID-LUN:** Logical volumes in the local disk array. The icons are:

	This volume not paired with any other volume. This volume is not a primary or secondary volume.
	This volume is a primary volume.
	This volume is a secondary volume.

To the right of the icon appears information about a LU path, which is a path from hosts to the logical volume.

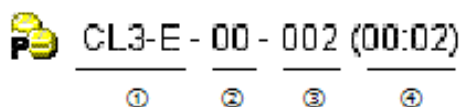

**Figure 355** Information in **Port-G-ID-LUN** column in Pair Operation pane





1	Port that receives read and write requests from hosts. In <a href="#">Figure 355</a> , read and write requests are sent to the logical volume via the CL3-E port.
2	Host group number. A host group is a group of hosts that issue read and write requests.
3	LUN (logical unit number).
4	Logical volume ID. The number on the left of the colon is a CU number. The number on the right of the colon is an LDEV number.



**NOTE:** If a logical volume is an external volume, the symbol # appears after the LDEV number. Currently, however, external volumes are not displayed.

- **Status:** Status of volume pairs.

	<b>SMPL</b> The volume is not currently assigned to a pair. When the initial copy is started by a paircreate operation, the volume status changes to COPY.
	<b>COPY</b> The initial copy operation is in progress. Data in the primary volume is not synchronized with data in the secondary volume. When the initial copy is complete, the status changes to PAIR.

 <b>PAIR</b>	The volume is paired with another volume. The two volumes are fully synchronized. All updates from the host to the primary volume are duplicated at the secondary volume.
 <b>PSUS</b>	You split the pair (pairsplit-r) or deleted the pair from the secondary disk array (pairsplit-S). The primary and secondary volumes are not synchronized.
 <b>PSUE</b>	The pair was split by the primary or secondary disk array due to an error or failure. The primary and secondary volumes are not synchronized.
 <b>Suspending</b>	The primary and secondary volumes are not synchronized. This pair is in transition from the PAIR or COPY status to the PSUS/PSUE status.
 <b>Deleting</b>	The primary and secondary volumes are not synchronized. This pair is in transition from the PAIR, COPY, or PSUS/PSUE status to the SMPL status.

- **JNIG-MirrorID:** Journal group number and mirror ID. The number on the left of the hyphen (-) is a journal group number. The number on the right of the hyphen is a mirror ID.

This column is blank if the volume in the local disk array is not a primary or secondary volume.

- **S/N (CTRLID):** Remote disk array's serial number and controller ID. The controller ID is enclosed by parentheses.

This column is blank if the volume in the local disk array is not a primary nor secondary volume.



**NOTE:** The controller ID for an XP 12000 disk array is **4**.

This column can be blank while the pair is in transition to the SMPL status. To display the latest information in this column, refresh the screen.

- **Pair Port-G-ID-LUN:** Remote disk array's data volume.

This column indicates a primary volume if the remote disk array is a primary disk array.

This column indicates a secondary volume if the remote disk array is a secondary volume.

The following is an example of an entry in this column:

CL3-E - 00 - 002 (00:02)

①            ②            ③            ④

**Figure 356** Information in pair Port-G-ID-LUN column in Pair Operation pane

1	Port
2	Host group number
3	LUN (logical unit number)
4	Logical volume ID

This column is blank if the volume in the local disk array is not a primary or secondary volume.

- **Pair JNIG:** Remote disk array's journal group number. This column is blank if the volume in the local disk array is not a primary or secondary volume.

- **CTG:** Consistency group number. This column is blank if the volume in the local disk array is not a primary or secondary volume.
- **Progress:** Copy operation progress. This column is blank if the volume in the local disk array is not a primary or secondary volume.
- **Used Volume:** Size of used volumes and licensed capacity. For example, if **12.34 (15.00) (TB)** is displayed, the licensed capacity for CA Journaling is 15.0 terabytes, and 12.34 terabytes of volumes are used.

If the licensed capacity is unlimited, **Unlimited** is displayed, but the size of used volumes is not displayed.

- **Total Pairs:** Current total number of data volume pairs.
- **Preset:** Detailed information about operations that will occur when you click **Apply**.
  - **List:** Displays changes made in the pane. When you change settings in the pane, the changes are displayed in the **Preset** list before the changes are applied to disk arrays. If you are sure that information in the **Preset** list is correct, click **Apply** to apply the settings you made.



**NOTE:** When the **Preset** list displays changes made, you can only perform the same type of operation you have been doing. You can only view detailed information about pairs even when the **Preset** list displays changes. For example, if you are trying to delete pairs and the **Preset** list displays the pairs you want to delete, you cannot perform any other operations, such as splitting or restoring pairs.

- **Operation:** Operation that will occur when you click **Apply**.
  - **Paircreate:** Create pairs
  - **Pairsplit-r:** Split pairs
  - **Pairresync:** Restore pairs
  - **Pairsplit -S:** Delete pairs
  - Blank: Nothing occurs when you click **Apply**.
- **Preset:** The number to the left of the slash (/) indicates the number of items displayed in the **Preset** list. The number to the right of the slash indicates the maximum number of items that can be displayed in the **Preset** list. For example, if **Preset 010/1096** is displayed, you can add another 4,086 items to the **Preset** list.
- **Apply:** Applies settings in the **Preset** list to the disk arrays.
- **Cancel:** Cancels settings in the **Preset** list.



**NOTE:** Information on the Pair Operation pane is updated when you do one of the following:

- Select another tab, and reselect the **Pair Operation** tab.
- Click **Refresh** (top right of Command View XP pane).
- Click **Apply**.
- Select Modify mode when you are in View mode.

## Filtering information in the list in the Pair Operation pane

Use the Display Filter pane to filter information in the list in the Pair Operation pane. The list displays only volumes that satisfy certain conditions.

1. In the Pair Operation pane, click **Display Filter**.
2. In the Display Filter pane, specify information you want to display in the list.
3. Click **Set** to close the Display Filter pane.



### NOTE:

- To restore the list to the default status (that is, the status before filtering), click **Reset** in the Display Filter pane, and click **Set** in the same pane.
- If you change settings in the Display Filter pane, the changes remain in effect during the CA Journaling session until you reset the settings.

---

The Display Filter pane displays the following:

- **Port:** Select the port to be displayed. To display all ports, select **ALL**.



**NOTE:** You can specify the port number with two characters. For instance, you can abbreviate **CL1-A** to **1A**. You can also enter the port number in both lowercase and uppercase characters.

- **Host Group:** Select the host group to be displayed. To display all host groups, select **ALL**.
- **JNL Group:** Select the journal group to be displayed. To display all journal groups, select **ALL**.
- **Mirror:** Select the mirror to be displayed. To display all mirrors, select **ALL**.
- **P-VOL/S-VOL:** Select the type of volumes to be displayed.
  - To display all primary volumes, select **P-VOL**.
  - To display all secondary volumes, select **S-VOL**.
  - To display all primary and secondary volumes, select **ALL**.
- **Status:** Specify pair statuses. The volumes of the specified statuses are displayed in the list.
- **Set:** Applies settings in the Display Filter pane to the list.
- **Reset:** Restores all options in the Display Filter pane to the default state. All drop-down lists display **ALL**. All check boxes are selected.

## Saving pair status information to a text file

Use the CA Journaling snapshot function to save information about pair status into a text file. This text file is called a *snapshot* file.



**NOTE:** You can use the snapshot function only while the client file access is enabled. When the client file access is not enabled, the **Snapshot** button is not displayed on the Pair Operation pane.

---



The following is an example of a snapshot file.

```
<Pair Status at 30/04/2004 12:34:56>
Port Gr (Name) LUN Vol Status JNG Mr S/N(CNTL) Port Gr LUN Vol JNG Type CTG Sync
CL3-E 00(3E-G00 ) 000 00:00 PAIR 01 02 11111(04) CLG-R FF 1FF 3F:FF F6 P-VOL 09 100
CL3-E 00(3E-G00 ) 008 00:08 SMPL 10 02 11111(04) CLG-R FF 1F6 3F:F6 ED P-VOL 12 80
CL3-E 00(3E-G00 ) 009 00:09 PSUS
```

(1) (2) (3) (4) (5) (6) (7) (8) (9) (10) (11) (12) (13) (14) (15) (16)

1	Port in the local disk array
2	Host group number and name in the local disk array
3	LU number in the local disk array
4	CU and LDEV numbers in the local disk array
5	Status of the pair
6	Journal group number in the local disk array
7	Mirror ID
8	Remote disk array's serial number and controller ID
9	Port number in the remote disk array
10	Host group number in the remote disk array
11	LU number in the remote disk array
12	CU and LDEV numbers in the remote disk array
13	Journal group number in the remote disk array
14	Type of volumes in the local disk array
15	Consistency group number
16	Progress of copy operation

To save information in a snapshot file:

1. To filter the list, see ["Filtering information in the list in the Pair Operation pane"](#) on page 666.
2. In the Pair Operation pane, click **Snapshot**. A message appears asking if you want to save volume pair information in a snapshot file.
3. Click **OK** to close the message. A pane appears prompting you to save a snapshot file.
4. Enter the snapshot file name, and click **Save**. A message appears when CA Journaling finishes saving the snapshot file.
5. Click **OK** to close the message.

## Creating a pair of data volumes (Paircreate)

Using the Paircreate pane, the administrator of the primary disk array must create pairs of a primary and secondary volume. When creating a pair, the administrator can specify options for initial copy activities.

Before creating one or more pairs, the administrator must make sure that:

- Volumes to be used as secondary volumes are offline to all hosts.

- Ports have already been configured (see “[Configuring port attributes](#)” on page 638).
- Primary disk array is associated with the secondary disk array (see “[Associating primary and remote disk arrays and configuring logical paths \(Add DKC\)](#)” on page 640).

After all these points are confirmed, the administrator of the primary disk array can use the following procedure to create a pair of a primary and secondary volume. The administrator of the secondary disk array cannot perform this operation.

1. Ensure that the Command View XP main pane is in Modify mode. For more information, see [Table 9](#) on page 98.
2. Ensure that the Pair Operation pane is displayed.
3. In the tree, select a port or host group.
4. In the list, select and right-click the volume you want to use as a primary volume.



**NOTE:**

- Volumes with the  icon are already used as primary volumes.
- You can select and right-click more than one volume to create more than one pair at one time. You must choose all the secondary volumes from the same secondary disk array.

5. Select **Paircreate**. The Paircreate pane appears.
6. In the **DKC** box, specify the secondary disk array.
7. In the **S-VOL** box, specify the secondary volume.
  - Use the leftmost drop-down list to specify a port.
  - Use the drop-down list in the middle to specify a host group.
  - Use the rightmost drop-down list to specify a LUN.



**NOTE:** If more than one primary volume is specified in the list, you can specify secondary volumes in three ways. For more information, see the explanation for the **Select Other S-VOL(s)** option later in this section.

8. Use the **Mirror** drop-down lists to specify the following items sequentially:
  - Master journal group
  - Mirror ID
  - Restore journal group
9. In the **CTG** box, specify a consistency group number.
10. Do one of the following to make settings on the initial copy operation:
  - To start the initial copy operation immediately after the pair is created, select **Entire**.
  - To not start the initial copy operation immediately after the pair is created, select **None**.
11. Use **Error Level** to specify the range used for splitting a pair when a failure occurs.
12. Click **Set** to close the Paircreate pane.
13. In the **Preset** list in the Pair Operation pane, check the settings you made.
  - To modify a setting, select and right-click the setting, and select **Modify**.

- To cancel a setting, select and right-click the setting, and select **Cancel**.

14. Click **Apply** to start the pair creation and initial copy operations.



**NOTE:** If an error occurs, the rightmost column of the **Preset** list displays the error code. To view detailed information about the error, right-click the error code, and select **Error Detail**. An error message appears providing detailed information about the error.

15. In the list of the Pair Operations pane, verify that the status of the pair is **COPY**. To monitor the progress of the paircreate operations, click **Refresh** to update the information in the list or use the Pairedisplay pane to monitor the detailed status of each pair.

The Paircreate pane displays the following:

- **P-VOL:** Primary volume. The numbers indicates the primary volume's port number, host group number, and LUN.



**NOTE:** **P-VOL** displays only one primary volume even when two or more primary volumes are selected in the Pair Operation pane. **P-VOL** only displays the primary volume that has the smallest LUN (LUN number).

- **S-VOL:** Select a secondary volume. When specifying a secondary volume, use the three drop-down lists to select the secondary volume's port, host group, and LUN.



**NOTE:** You can select only one secondary volume even when two or more primary volumes are selected in the Pair Operation pane. CA Journaling automatically specifies the other secondary volumes. For more information, see the explanation for the **Select Other S-VOL(s)** option later in this section.

If you selected more than one primary volume, select the secondary volume for the primary volume being displayed. Secondary volumes for the rest of the primary volumes are automatically assigned according to the LUN. For example, if you select three primary volumes and select LUN01 as the S-VOL for the first primary volume, the secondary volumes for the two other primary volumes are LUN02 and LUN03.

When creating more than one pair at a time, ensure that the S-VOLs to be assigned automatically are available. If an S-VOL is not available, you must select the S-VOL individually.

You can specify the port number with two characters. For instance, you can abbreviate **CL1-A** to **1A**. You can also enter the port number in both lowercase and uppercase characters.

- **Select Other S-VOL(s):** Specify how CA Journaling automatically assigns secondary volumes if two or more primary volumes are selected in the Pair Operation pane.
  - **Increment:** CA Journaling increments the LUNs of the resulting secondary volumes one by one. For example, if the LUNs of the three primary volumes are 001, 002, and 003, the LUNs of the resulting secondary volumes are 011, 012, and 013 if you select LUN 011 with the **S-VOL** drop-down list.
  - **Input Next:** You can specify a LUN for each primary volume. For example, if two primary volumes are selected, you must select **Input Next**, specify the secondary volume for the first primary volume with S-VOL, and click **Set**. Next, you must specify the secondary volume for the second primary volume with S-VOL, and click **Set**.
  - **Relative to P-VOL:** CA Journaling calculates the difference between LUNs of two adjacent primary volumes, and determines LUNs of secondary volumes. For example, if the LUNs of the three

primary volumes are 001, 005, and 006, the LUNs of the resulting secondary volumes are 002, 006, and 007 if you select LUN 002 with the **S-VOL** drop-down list.



**NOTE:** If you select and right-click more than one volume in the **Preset** list, and select **Modify**, the Paircreate pane appears and the **Select Other S-VOL(s)** drop-down list displays **No Change**. To change the setting with this drop-down list, select another item from the drop-down list.

- **Mirror:** Assign a master journal group to the primary volume, assign a restore journal group to the secondary volume, and assign a mirror ID to the volume pair.
  - **M-JNL:** Assigns a master journal group to the primary volume.



**NOTE:** **M-JNL** does not display journal group numbers used by Universal Replicator for z/OS.

- **Mirror ID:** Assigns a mirror ID to the volume pair.
- **R-JNL:** Assigns a restore journal group to the secondary volume.



**NOTE:** **R-JNL** does not display journal group numbers used by Universal Replicator for z/OS.

- **CT Group:** Specify a consistency group.



**NOTE:** This option cannot be changed after a pair has been created.

- **DKC:** Select the secondary disk array's serial number and controller ID. You can also specify the path type (for example, channel type).



**NOTE:** The secondary disk array must be the same for all pairs being created during one operation.

- **Initial Copy:** Specify whether to start the initial copy operation after the volume pair is created.
  - **Entire:** The initial copy operation starts after the volume pair is created. When the initial copy operation executes, all data on the primary volume is copied to the secondary volume. This is the default.
  - **None:** The initial copy operation does not start after the volume pair is created. The primary disk array starts copying of update data as needed.



**CAUTION:** Ensure that the primary volume and secondary volume are already identical when using **None**.

- **Priority:** Specify priority (scheduling order) of the initial copy operations (1-256). The default is **32**.



**NOTE:** If a timeout error occurs during the Paircreate operation, the copy operation might not be executed correctly in the order you set with the **Priority** parameter. The timeout error might be caused by the CU configuration or a remote copy path error. Review the error, delete the pair with the error, and retry the Paircreate operation.

---

- **Error Level:** Specify the range used for splitting a pair when a failure occurs.
  - **Group:** If a failure occurs with a pair, all pairs in the consistency group where the pair belongs are split. This is the default.
  - **LU:** If a failure occurs with a pair, only the pair is split.
- **M-JNL Information:** Displays information about the master journal.
  - **Current Mirror(s):** Number of mirrors registered in the master journal.
  - **Total Mirror(s):** Sum of the following:
    - (1) Number of mirrors registered in the master journal.
    - (2) Number of mirrors to be added by the Paircreate pane
    - (3) Number of mirrors for volumes in the **Preset** list in the Pair Operation pane.
- **Set:** Applies settings to the **Preset** list in the Pair Operation pane.
- **Cancel:** Discards settings.

## Displaying detailed information about a pair of data volumes

Use the Pairedisplay pane to view detailed information about a pair of data volumes.

The primary and secondary disk array administrators can perform the following procedure:

1. Ensure that the Pair Operation pane is displayed ("[Displaying the Pair Operation pane](#)" on page 662).
2. In the tree of the Pair Operation pane, select and right-click a pair.



---

**NOTE:** You cannot select more than one pair.

---

3. Select **Pairedisplay**.
4. In the Pairedisplay pane, view detailed information about the pair.
5. Click **Close** to close the Pairedisplay pane.

The Pairedisplay pane displays the following:

- **Status:** Status of the pair.
- **Alternative Path:** Alternate path.
- **Progress:** Initial copy operation progress.
- **P-VOL:** Primary volume.
  - The first line displays the primary volume's port number, host group ID, and LUN.
  - The second line displays the device emulation type.
  - The third line displays the volume capacity.
- **S-VOL:** Secondary volume.
  - The first line displays the secondary volume's port number, host group ID, and LUN.
  - The second line displays the device emulation type.
  - The third line displays the volume capacity.

- **M-JNL Group:** Master journal group.
- **R-JNL Group:** Restore journal group.
- **Mirror ID:** Mirror ID.
- **CT Group:** Consistency group number.
- **DKC S/N (CTRL ID):** Secondary disk array's serial number and controller ID. The controller ID is enclosed by parentheses.
- **Path Type:** Channel type of the path interface between the disk arrays (fibre).



**NOTE:** In the current version, the channel type is always displayed as **Fibre**.

- **Initial Copy Priority:** Initial copy operations priority (scheduling order). The value can be within the range of 1 to 256 (disabled when the status becomes PAIR).
- **Error Level:** Range used for splitting a pair when a failure occurs.
  - **Group:** If a failure occurs with a pair, all pairs in the consistency group where the pair belongs are split.
  - **LU:** If a failure occurs with a pair, only the pair is split.
- **S-VOL Write:** Indicates whether write I/O to the secondary volume is enabled or disabled (enabled only when the pair is split).
- **Other Information:** Displays the following:
  - **Established Time:** Date and time when the volume pair was created.
  - **Updated Time:** Date and time when the volume pair status was last updated.
- **Refresh the Pair Operation tab after this window is closed:** If selected, the Pair Operation pane is updated when the Pairdisplay pane closes.
- **Previous:** Displays the pair status information for the previous pair in the list (the pair in the row above).
- **Next:** Displays the pair status information for the next pair in the list (the pair in the row below).



**NOTE:**

- The Display Filter settings (see "[Filtering information in the list in the Pair Operation pane](#)" on page 666) can affect how **Previous** or **Next** is recognized.
  - The list displays a maximum of 1,024 rows at once. The **Previous** and **Next** buttons on the Pairdisplay pane can only be used for the currently displayed 1,024 rows.
- 
- **Refresh:** Updates the pair status information.
  - **Close:** Closes the Pairdisplay pane.

## Splitting a pair of data volumes

After the initial copy operation finishes, use the Pairsplit-r pane to split the pair of data volumes.

The primary and secondary disk array administrators can perform the following procedure:

1. Ensure that the Command View XP main pane is in Modify mode. For more information, see [Table 9](#) on page 98.
2. Ensure that the Pair Operation pane is displayed (see “[Displaying the Pair Operation pane](#)” on page 662).
3. In the tree, select **Subsystem** or a port.
4. In the list, select and right-click the pair you want to split. The pair status must be COPY or PAIR.
5. Select **Pairsplit-r**. The Pairsplit-r pane appears.
6. In the Pairsplit-r pane, select the desired pairsplit options for the pairs.
7. Click **Set** to close the Pairsplit-r pane.
8. In the **Preset** list in the Pair Operation pane, check the settings you made.
  - To modify a setting, select and right-click the setting, and select **Modify**.
  - To cancel a setting, select and right-click the setting, and select **Cancel**.
9. Click **Apply** to split pairs.



**NOTE:** If an error occurs, the rightmost column of the **Preset** list displays the error code. To view detailed information about the error, right-click the error code, and select **Error Detail**. An error message appears providing detailed information about the error.

- 
10. In the list of the Pair Operations pane, verify that the pair was split successfully. If the pair was split, the status of the pair is PSUS.



**NOTE:** To restore a pair that has already been split, use the Pairresync command (see “[Restoring a pair of data volumes](#)” on page 675).

---

The Pairsplit-r pane displays the following:

- **S-VOL Write:** Specify whether hosts can write data to the secondary volume.
  - **Disable:** Hosts cannot write data to the secondary volume while the pair is split.
  - **Enable:** Hosts can write data to the secondary volume while the pair is split. This option is available only when the selected volume is a primary volume.
- **Range:** Specify the split range. If you select two or more pairs in the same consistency group, the default is **LU**. Otherwise, the default is **Group**.
  - **LU:** Only the specified pairs are split.



**NOTE:** If you select pairs with PAIR status and other than PAIR status in the same consistency group, an unexpected suspension might occur during the pair operations (Pairsplit-r, Pairsplit-S, and Pairresync) under heavy I/O load conditions. You can estimate whether the I/O load is heavy or not from the rate of journal cache (around 30%), or if you cannot see the journal cache rate from the frequency of host I/O. The suspend pair operations should be performed under light I/O load conditions.

- 
- **Group:** All pairs in the same consistency groups as the selected pairs are split.





---

**NOTE:** If the following conditions are satisfied and you click **Apply**, a warning message appears and processing cannot continue:

- The **Preset** list contains two or more pairs belonging to the same consistency group.
- The **Range** column displays **Group** for at least one of the above pairs.

To continue processing, do one of the following:

- Ensure that the **Range** column displays **LU** for all pairs in the same consistency group.
- In the **Preset** list, select all but one pair in the same consistency group, right click the selected pairs, and select **Delete**.

- 
- **Suspend Mode:** Specify how to deal with update data that was not copied to the secondary volume.
    - **Flush:** When you split the pair, update data is copied to the secondary volume. This is the default.
    - **Purge:** When you split the pair, update data is not copied to the secondary volume. If you restore the pair later, update data is copied to the secondary volume.
  - **Set:** Applies settings to the **Preset** list in the Pair Operation pane.
  - **Cancel:** Discards settings.

## Restoring a pair of data volumes

Use the Pairresync pane to restore a pair that was split.



---

**NOTE:** If the primary or secondary disk array is powered off and its backup batteries are fully discharged while pairs are suspended, the P-VOL/S-VOL bitmaps are not retained. In this unlikely case, the primary/secondary disk array marks all cylinders/tracks of all suspended volumes as modified, so the primary disk array performs the equivalent of an entire initial copy operation when the pairs are resumed.

---

The administrator of the primary disk array can use the following procedure to restore one or more pairs that were split. The administrator of the secondary disk array cannot perform this procedure.

1. Ensure that the Command View XP main pane is in Modify mode. For more information, see [Table 9](#) on page 98.
2. Ensure that the Pair Operation pane is displayed ("[Displaying the Pair Operation pane](#)" on page 662).
3. If any pair was suspended due to an error condition (use the Pairstatus pane to view the suspend type), ensure that the error condition has been removed. The primary disk array will not resume the pairs until the error condition has been removed.
4. In the tree, select **Subsystem** or a port.
5. In the list, select and right-click the pair you want to restore. The pair status must be PSUS or PSUE.
6. Select **Pairresync**. The Pairresync pane appears.
7. In the Pairresync pane, select the desired options for the pairs.
8. Click **Set** to close the Pairresync pane.
9. In the Preset list in the Pair Operation pane, check the settings you made.
  - To modify a setting, select and right-click the setting, and select **Modify**.

- To cancel a setting, select and right-click the setting, and select **Cancel**.

10. Click **Apply** to restore pairs.



**NOTE:** If an error occurs, the rightmost column of the **Preset** list displays the error code. To view detailed information about the error, right-click the error code, and select **Error Detail**. An error message appears providing detailed information about the error.

11. In the list of the Pair Operations pane, verify that the pairs were restored successfully. If the pair was restored, the status of the pair is COPY or PAIR.

To monitor the progress of restoring pairs, click **Refresh** to update the information in the list or use the Pairedisplay pane (see “[Displaying detailed information about journal groups](#)” on page 654) to monitor the detailed status of each pair.

The Pairesync pane displays the following:

- **Range:** Specify the restore range. If you select two or more pairs in the same consistency group, the default is **LU**. Otherwise, the default is **Group**.
  - **LU:** Only the specified pairs are restored.
  - **Group:** All pairs in the same consistency groups as the selected pairs are restored.



**NOTE:** If the following two conditions are satisfied and you click **Apply**, a warning message is displayed and processing cannot continue:

- The **Preset** list contains two or more pairs belonging to the same consistency group.
- The **Range** column displays **Group** for at least one of the above pairs.

To continue processing, do one of the following:

- Ensure that the **Range** column displays **LU** for all pairs in the same consistency group.
- In the **Preset** list, select all but one pair in the same consistency group, right click the selected pairs, and select **Delete**.

- **Priority:** Specify the desired priority (1-256) (scheduling order) for the pair-restoring operations.
- **DKC:** Disk array.
- **Error Level:** Specify the range used for splitting a pair when a failure occurs.
  - **Group:** If a failure occurs with a pair, all pairs in the consistency group where the pair belongs are split.
  - **LU:** If a failure occurs with a pair, only the pair is split.
- **Set:** Applies settings to the **Preset** list in the Pair Operation pane.
- **Cancel:** Discards settings.

## Deleting a pair of data volumes

Use the Pairsplit-S pane to delete a pair of data volumes.

The primary and secondary disk array administrator can use the following procedure:

1. Ensure that the Command View XP main pane is in Modify mode. For more information, see [Table 9](#) on page 98.

2. Ensure that the Pair Operation pane is displayed (see “[Displaying the Pair Operation pane](#)” on page 662).
3. In the tree, select **Subsystem** or a port.
4. In the list, select and right-click the pair you want to delete.
5. Select **Pairsplit-S**. The Pairsplit-S pane appears.
6. In the Pairsplit-S pane, select the options for the pairs.
7. Click **Set** to close the Pairsplit-S pane.
8. In the **Preset** list in the Pair Operation pane, to check the settings you made.
  - To modify a setting, select and right-click the setting, and select **Modify**.
  - To cancel a setting, select and right-click the setting, and select **Cancel**.
9. Click **Apply** to restore pair(s).



**NOTE:** If an error occurs, the rightmost column of the **Preset** list displays the error code. To view detailed information about the error, right-click the error code, and select **Error Detail**. An error message appears providing detailed information about the error.

10. In the list of the Pair Operations pane, verify that the pairs has been deleted successfully. If the pair has been deleted, the status of the pair is **SMPL**.

To monitor the progress of deleting pairs, click **Refresh** to update the information in the list, or use the Pairedisplay pane (see “[Displaying detailed information about a pair of data volumes](#)” on page 672) to monitor the detailed status of each pair.



**NOTE:** To restore a pair that was deleted from the secondary disk array, delete the pair from the primary disk array, and restore the pair using the appropriate initial copy option.

The Pairsplit-S pane displays the following:

- **Range:** Specify the delete range. If you select two or more pairs in the same consistency group, the default is **LU**. Otherwise, the default is **Group**.
  - **LU:** Only the specified pairs are deleted. If the pair status is **SMPL**, **Range** is set to **LU**.



**NOTE:** If you select pairs with PAIR status and other than PAIR status in the same consistency group, an unexpected suspension might occur during the pair operations (Pairsplit-r, Pairsplit-S, and Pairresync) under heavy I/O load conditions. You can estimate whether the I/O load is heavy or not from the rate of journal cache (around 30%), or if you cannot see the journal cache rate from the frequency of host I/O. The pair operations should be performed under light I/O load conditions.

- **Group:** All pairs in the same consistency groups as the selected pairs are deleted. If the pair status is **Deleting** or **Suspending**, **Range** is set to **Group**.



**CAUTION:** Do not use this option when deleting pairs at the secondary disk array during disaster recovery.



---

**NOTE:** If the following two conditions are satisfied and you click **Apply**, a warning message is displayed and processing cannot continue:

- The **Preset** list contains two or more pairs belonging to the same consistency group.
- The **Range** column displays **Group** for at least one of the above pairs.

To continue processing, do one of the following:

- Ensure that the **Range** column displays **LU** for all pairs in the same consistency group.
- In the **Preset** list, select all but one pair in the same consistency group, right click the selected pairs, and select **Delete**.

- 
- **Delete Mode:** Specify whether pairs are forcibly deleted. When the status of the pairs to be deleted is **SMPL** or **Deleting**, the default is **Force**. Otherwise, the default is **Normal**.
    - **Force:** Pairs are forcibly deleted even if the primary disk array cannot communicate with the secondary disk array. Use this to free a host waiting for device-end from a primary disk array that cannot communicate with its the secondary disk array, allowing host operations to continue.  
  
If you specify **Force** when the pair status is other than **SMPL**, **Range** is set to **Group**.
    - **Normal:** Pairs are deleted only if the primary disk array can change the pair status of the primary and secondary volumes to **SMPL**.
  - **Set:** Applies settings in the **Preset** list in the Pair Operation pane.
  - **Cancel:** Discards settings.

## Creating a Point-in-Time copy of data volumes

Use CA Journaling to make Point-in-Time (PiT) duplicates of groups of volumes. The term “Point-in-Time (PiT)” refers the process of copying data immediately when you want to obtain it. Use CA Journaling to create a PiT copy of data volumes belonging to a journal group.

1. Stop all write I/Os from hosts to primary data volumes in the journal group.
2. After all write I/Os to primary data volume have stopped, split the mirror (that is, a pair of the master and restore journal group (see “[Splitting mirrors \(Pairsplit-r: suspending copy operations\)](#)” on page 659. On the Pairsplit-r pane, specify **Group** for **Range**, and specify **Flush** for **Suspend Mode**.
3. When the status of all data volume pairs in the journal group is changed to **PSUS**, the duplicate set of volumes is complete. If desired, restart your business application at the primary site to resume business activities.

---

## Monitoring remote copy operations

Use the Usage Monitor pane to perform remote copy usage monitoring operations for the connected local disk array. The usage monitoring function collects I/O statistics for all volumes on the connected disk array.

The usage monitor operations are:

- “[Displaying the Usage Monitor pane](#)” on page 679
- “[Starting and stopping usage monitoring](#)” on page 679
- “[Displaying the usage monitor graph](#)” on page 680

- “Saving monitoring data in text files” on page 682

## Displaying the Usage Monitor pane

The Usage Monitor pane displays user-selected remote copy I/O statistics and status of remote copy usage monitoring.



**NOTE:** To use the Usage Monitor pane, ensure that Command View XP is in Modify mode. If Command View XP is in View mode, you can only view information in this pane, and cannot make any settings in this pane.

### CA Journaling has not been started

1. Use your Web browser to display the storage device list. In the storage device list, select the disk array to log into. Enter a user name and the password, and click **OK**. The Command View XP main pane appears. For more information, see “Getting started” on page 39.
2. On the Command View XP main pane, click the Continuous Access XP Journal button (). CA Journaling starts.
3. Select the **Usage Monitor** tab. The Usage Monitor pane appears.

### CA Journaling has already been started

1. Select the **Usage Monitor** tab. The Usage Monitor pane appears.

The Usage Monitoring pane displays the following:

- **Monitoring Switch:** Select the usage monitor operation (see “Starting and stopping usage monitoring” on page 679).
  - **Enable:** Displayed when monitoring is on
  - **Disable:** Displayed when monitoring is off.



**NOTE:** When monitoring is stopped, the usage monitor graph is closed. The usage monitor graph can only be displayed when monitoring is running.

- **Gathering Interval:** Specify the data collection interval for usage monitoring between 1 and 15 minutes in one minute increment. The default is 1.



**NOTE:** When monitoring is stopped, the default (1) is displayed in the **Gathering Interval** box.

- **Update:** Displays the most recent data sample time of the data on the graph.
- **Graph:** Displays remote I/O statistic information and status of remote copy monitor.
- **Apply:** Applies settings in the Usage Monitor pane to the disk array.
- **Cancel:** Cancels settings in the Usage Monitor pane.

## Starting and stopping usage monitoring

At each data sampling time interval, the usage monitoring function collects 1,440 pieces of data for each LDEV and up to 1,440 pieces of data for the entire disk array.

## Starting usage monitoring

1. On the connected local disk array, select the **Usage Monitor** tab.
2. In the **Monitoring Switch** box, select **Enable**.
3. Select the sampling time interval (in minutes) from the drop-down list in the **Gathering Interval** box. If the desired value is not listed in the drop-down list, enter the time interval directly. You can enter from 1 to 15 minutes. The default is 1 minute.



**NOTE:** If you set 1 minute for **Gathering Interval**, the sampling data is held one day. If you set 15 minutes for **Gathering Interval**, the sampling data is held 15 days. When **Gathering Interval** is changed, data obtained before the change is deleted.

4. To start monitoring, click **Apply**.

## Stopping usage monitoring

1. On the connected local disk array, select the **Usage Monitor** tab.
2. In the **Monitoring Switch** box, select **Disable**.
3. To stop monitoring, click **Apply**.



**NOTE:**

- Depending on the SVP's load status, you might not be able to stop monitoring. If you cannot stop monitoring immediately, wait for a while, and **Refresh** (top right of Command View XP pane) to check the status of the monitor.
- Monitoring data collection continues, even if the pane is closed, until you stop monitoring operations. Monitoring data collection continues even if the SVP is rebooted.

## Displaying the usage monitor graph

When usage monitoring is running, the Usage Monitor pane displays user-selected remote copy I/O statistics in real time. I/O statistics data is collected according to the data-sampling rate selected in the **Gathering Interval** box.

The usage monitor graph plots user-selected I/O statistics (up to 65 data points) on an x-y graph. The x-axis displays time. The y-axis displays the number of I/Os during the last sampling period. The legend (right side of the graph) indicates data being displayed. A value on the y-axis varies according to the maximum value of the statistical data displayed. If the value on the y-axis exceeds 10,000,000, the value is displayed in exponential notation (for example,  $1E7 = 1 \times 10^7 = 10,000,000$ ;  $2E8 = 2 \times 10^8 = 200,000,000$ ).

1. Ensure that usage monitoring is running. The usage monitor graph can only be displayed when monitoring is on.
2. Right-click the graph area of the Usage Operations pane, and click **Display Item** to open the Display Item pane.
3. Do one of the following:
  - To display I/O statistics for all LDEVs in the disk array, select **Subsystem**.
  - To display I/O statistics for a specific journal group, select **JNL Group**, and enter a journal group number (00-FF).

---

**NOTE:** If you specify an unused journal group, the graph is not displayed.

---

- To display I/O statistics for a specific LU, select **Device**, and select a port (CL1-A to CLG-R) enter the G-ID (00-FE) and LUN (00-3FF).
- 

**NOTE:** If you specify the unmounted LU, the graph is not displayed.

---

4. In the **Monitor Data** box, select the I/O statistics data you want to display on the graph. You must select at least one box. [Table 130](#) describes I/O statistics data.
5. Click **Set** to close the Display Item pane. The Usage Operations pane now displays a graph showing the selected I/O statistics data for the selected LUs.

To enlarge the displayed graph, right-click the graph, and select **Large Size**.

To return the graph to normal size, right-click the graph, and select **Normal Size**.

---



**NOTE:** To stop displaying the usage monitor graph, right-click the graph, and select **Close**. To stop displaying all graphs, select **Close All**. The usage monitor graph closes automatically in the following cases:

- Select another tab.
  - Select another program product.
  - Exit Command View XP.
  - Stop the usage monitoring function by selecting **Disable** in the **Monitoring Switch** box, and clicking **Apply**.
- 

**Table 130** Remote Copy I/O Statistics

Statistic		Description
Host I/O	Read Record Count	Number of read I/Os per second.
	Read Hit Record Count	Number of read hit records per second.
	Write Record Count	Number of write I/Os per second.
	Write Hit Record Count	Number of write hit records per second.
	Read Transfer Rate	Amount of data read per second. The unit is kilobytes per second.
	Write Transfer Rate	Amount of data written per second. The unit is kilobytes per second.
Initial Copy	Initial Copy Hit Rate	Initial copy hit rate. The unit is percent.
	Average Transfer Rate	Average transfer rate for initial copy operations. The unit is kilobytes per second.

**Table 130** Remote Copy I/O Statistics

Statistic		Description
<b>Asynchronous Copy</b>	M-JNL Asynchronous RIO count	Number of asynchronous remote I/Os per second at the primary disk array.
	M-JNL Total Number of Journal	Number of journals at the primary disk array.
	M-JNL Average Transfer Rate	Average transfer rate for journals in the primary disk array. The unit is kilobytes per second.
	M-JNL Average RIO Response	Remote I/O process time on the primary disk array. The unit is milliseconds
	R-JNL Asynchronous RIO count	Number of asynchronous remote I/Os per second at the secondary disk array.
	R-JNL Total Number of Journal	Number of journals at the secondary disk array.
	R-JNL Average Transfer Rate	Average transfer rate for journals in the secondary disk array. The unit is kilobytes per second.
	R-JNL Average RIO Response	Remote I/O process time on the secondary disk array. The unit is milliseconds.
<b>M-JNL</b>	Used JNL Cache	Amount of used journal cache for master journals. The unit is % (percent)
	Data Used Rate	Data usage rate for master journals. The unit is percent.
	Meta Data Used Rate	Metadata usage rate for master journals. The unit is percent.
<b>R-JNL</b>	Used JNL Cache	Amount of used journal cache for restore journals. The unit is % (percent).
	Data Used Rate	Data usage rate for restore journals. The unit is percent.
	Meta Data Used Rate	Metadata usage rate for restore journals. The unit is percent.

## Saving monitoring data in text files

To save monitoring data in text files, use the Auto LUN Export Tool. For more information, see the *HP StorageWorks Performance Control Export Tool Reference Guide*.

## Viewing history of data volume pair operations

Use the History Operation pane to view a history of operations for data volume pairs. For example, you can check the date and time when data volume pairs are created or deleted. You can also save operation history in a text file.

## Displaying the History Operation pane

Use the History Operation pane display history of pf operations for data volume pairs, such as the date and time when data volume pairs are created or deleted.



## CA Journaling has not been started

1. Use your Web browser to display the storage device list. In the storage device list, select the disk array to log into. Enter a user name and the password, and click **OK**. The Command View XP main pane appears. For more information, see "[Getting started](#)" on page 39.
2. On the Command View XP main pane, click the **Continuous Access XP Journal** () button. CA Journaling starts.
3. Select the **History Operation** tab. The History Operation pane appears.
4. Click **Refresh** to update the operation history.

## CA Journaling has already been started

1. Select the **History Operation** tab. The History Operation pane appears.
2. Click **Refresh** to update the operation history.

## History Operation pane components

The History Operation pane displays the following:

- **Status:** Current status of operation history.
  - **No history file exists.:** Operation history does not exist.
  - **Reading a history file failed.:** An attempt to read operation history failed.
  - **Updating ... n (%).:** Operation history update is in progress, where **n (%)** indicates the progress.
  - **Complete.:** Operation history update is complete.



**NOTE:** When the update is in progress, the checking process automatically continues until the update process completes. The update process is checked at 10-second intervals.

- **Last Update:** Date and time when operation history was last updated.
- **Snapshot:** Saves operation history in a text file. For more information, see "[Saving operation history in a text file](#)" on page 685.



**NOTE:** You cannot save the history file while operation history is being updated. Save operation history in a text file after operation history is updated.

- **List:** Displays operation history for data volume pairs in the connected disk array.
  - **Operation Date/Time:** Date and time when the operation was completed.
  - **Copy Time:** Time taken for the operation. Displayed only for Paircreate Complete and Pairresync Complete operations.
  - **JNL Group:** Journal group number.
  - **Mirror ID:** Mirror ID.
  - **VOL:** Volume manipulated during the operation. This volume is located in the local disk array. The number to the left of the colon (:) is the CU number. The number to the right of the colon is the LDEV number.

- **Paired VOL:** Volume paired with the manipulated volume. This volume is located in the remote disk array. The number to the left of the colon (:) is the CU number. The number to the right of the colon is the LDEV number.
- **Operation:** Operation performed.
  - **Pair definition:** Data volume pair was defined.
  - **Paircreate Start:** Creation of data volume pair was started.
  - **Paircreate Complete:** Creation of data volume pair was finished.
  - **Pairresync Start:** Restoring data volume pair was started.
  - **Pairresync Complete:** Restoring data volume pair was finished.
  - **Pairsplit-r Start:** Splitting (Suspending) data volume pair was started.
  - **Pairsplit-r Complete:** Splitting (Suspending) data volume pair was finished.
  - **Pairsplit-r(Failure):** Data volume pair was split (suspended) because of a failure.
  - **Pairsplit-S Start:** Deleting data volume pair was started.
  - **Pairsplit-S Complete:** Deleting data volume pair was finished.
  - **Status Change by MCU(SMPL to COPY):** Status of data volume pair was changed from SMPL to COPY because of an operation from the primary disk array.
  - **Status Change by MCU(SMPL to PAIR):** Status of data volume pair was changed from SMPL to PAIR because of an operation from the primary disk array.
  - **Status Change by MCU(COPY to PAIR):** Status of data volume pair was changed from COPY to PAIR because of an operation from the primary disk array.
  - **Status Change by MCU(COPY to PSUS/PSUE):** Status of data volume pair was changed from COPY to PSUS or PSUE because of an operation from the primary disk array.
  - **Status Change by MCU(PAIR to PSUS/PSUE):** Status of data volume pair was changed from PAIR to PSUS or PSUE because of an operation from the primary disk array.
  - **Status Change by MCU(PAIR to SMPL):** Status of data volume pair was changed from PAIR to SMPL because of an operation from the primary disk array.
  - **Status Change by MCU(COPY to SMPL):** Status of data volume pair was changed from COPY to SMPL because of an operation from the primary disk array.
  - **Status Change by MCU(PSUS/PSUE to SMPL):** Status of data volume pair was changed from PSUS or PSUE to SMPL because of an operation from the primary disk array.
  - **Status Change by MCU(PSUS/PSUE to COPY):** Status of data volume pair was changed from PSUS or PSUE to COPY because of an operation from the primary disk array.
  - **Status Change by RCU(Pairsplit-r Start):** Status of data volume pair was changed because an operation for splitting a pair started at the secondary disk array.
  - **Status Change by RCU(Pairsplit-r Complete):** Status of data volume pair was changed because an operation for splitting a pair finished at the secondary disk array.
  - **Status Change by RCU(PSUS/PSUE to SMPL, Pairsplit-S Start):** Operation for deleting a pair was started at the secondary disk array. Status of data volume pair changes from PSUS or PSUE to SMPL.
  - **Status Change by RCU(COPY to SMPL, Pairsplit-S Start):** Operation for deleting a pair was started at the secondary disk array. Status of data volume pair changes from COPY to SMPL.

- **Status Change by RCU(PAIR to SMPL, Pairsplit-S Start):** Operation for deleting a pair was started at the secondary disk array. Status of the data volume pair changes from PAIR to SMPL.
- **Status Change by RCU(Pairsplit-S Complete):** Status of data volume pair was changed because an operation for deleting a pair finished at the secondary disk array.
- **Unknown:** Disk array could not identify the operation.

**NOTE:**

- The history information might not be displayed in chronological descending order. To sort the information in descending (or ascending) order, click a header in the list.
  - The History Operation pane can display history information for up to 65,535 operations. However, the pane can only display up to 16,384 operations at one time. To display the remaining operations, click **Previous** or **Next**.
  - The History Operation pane does not display history information older than seven days. If the number of operations exceeds 65,535, the oldest operations are deleted in chronological order to keep the number at 65,535, even if the operations occurred within the last week. The history file always contains the most recent operations up to a maximum of 65,535 operations. The history information for an entire week might not always be available.
  - Even if a failure causes two or more data volume pairs to be split (suspended) at the same time, only two rows showing **Pairsplit-r(Failure)** are displayed.
  - If a data volume pair consisting of LUN Expansion (LUSE) volumes is split (suspended) due to a failure, only two rows showing **Pairsplit-r(Failure)** are displayed. Even if the LUSE volume consists of three volumes, only two rows showing **Pairsplit-r(Failure)** are displayed.
- 
- **Previous:** The list displays up to a maximum of 16,384 operations at a time. If the number of operations exceeds 16,384, click **Previous** to display the previous 16,384 operations.
  - **Next:** The list displays up to a maximum of 16,384 operations at a time. If the number of operations exceeds 16,384, click **Next** to display the next 16,384 operations.

## Saving operation history in a text file

Use the snapshot function to save operation history into a text file. This text file is called a *snapshot* file.



**NOTE:** You can use the snapshot function only when the client file's access is enabled. When the client file's access is not enabled, the **Snapshot** button is not displayed on the History Operation pane.

---

The following is an example of a snapshot file.

Operation	Date/Time	Copy Time	JNL Group	Mirror ID	VOL	Paired VOL	Operation	
	2004/07/10	17:20:00	DD	03	00:00	1F:FF	Pair definition	
	2004/07/10	17:23:39	DD	03	01:01	1E:FE	Paircreate Start	
	2004/12/31	23:58:14	002:33:44	DD	03	02:02	1D:FD	Paircreate Complete
(1)		(2)	(3)	(4)	(5)	(6)	(7)	

1	Data and time when the operation finished.
2	Time taken for copying. This is displayed only when the operation is <b>Paircreate Complete</b> or <b>Pairresync Complete</b> .
3	Journal group number.
4	Mirror ID.
5	CU and LDEV numbers of volume in the local disk array. CU number is on the left of the colon (:). LDEV number is on the right of the colon.
6	CU and LDEV numbers of volume in the remote disk array. CU number is on the left of the colon (:). LDEV number is on the right of the colon.
7	Operation.

1. In the History Operation pane, click **Snapshot**. A message appears asking if you want to save operation history in a snapshot file.
2. Click **OK** to close the message. A pane appears prompting you to save a snapshot file.
3. Enter the name of the snapshot file, and click **Save**. A message appears when CA Journaling finishes saving the snapshot file.
4. Click **OK** to close the message.

## Performing optional operations

Use the Optional Operations pane to perform the following procedures:

- ["Displaying the Optional Operation pane"](#) on page 686
- ["Changing disk array options"](#) on page 687
- ["Displaying CLPR options"](#) on page 688

For more information about CLPR, see ["Disk/Cache Partition for the XP12000"](#) on page 143.

## Displaying the Optional Operation pane

Use the Optional Operation pane to set options.

### CA Journaling has not been started

1. Use your Web browser to display the storage device list. In the storage device list, select the disk array to log into. Enter a user name and the password, and click **OK**. The Command View XP main pane appears. For more information, see ["Getting started"](#) on page 39.
2. On the Command View XP main pane, click the **Continuous Access XP Journal** button (). CA Journaling starts.
3. Select the **Optional Operation** tab. The Optional Operation pane appears.

## CA Journaling has already been started

1. Select the **Optional Operation** tab. The Optional Operation pane appears.

## Optional Operation pane components

- **Tree:** Select **Subsystem** or **CLPR**.
- **List:** Displays one of the following:
  - Disk array option settings (see “[Changing disk array options](#)” on page 687).
  - CLPR option settings (see “[Displaying CLPR options](#)” on page 688).
- **Preset:** When you change settings in the Optional Operation pane, the **Preset** list displays the changes. Changes are not applied to the disk array until you click **Apply**.
- **Operation:** Operation that occurs when you click **Apply**.
  - **Change system option:** Changes disk array option.
  - Blank: Nothing occurs when you click **Apply**.
- **Preset:** The number to the left of the slash (/) indicates the number of items displayed in the **Preset** list. The number to the right of the slash indicates the maximum number of items that can be displayed in the **Preset** list.
- **Apply:** Applies settings in the **Preset** list to the disk array.
- **Cancel:** Cancels settings in the **Preset** list.



**NOTE:** Information on the Optional Operation pane is updated when you do one of the following:

- Select another tab, and reselect the **Optional Operation** tab.
  - Click **Refresh**.
  - Click **Apply**.
  - Select Modify mode when you are in View mode.
- 

## Changing disk array options

Use the Optional Operations pane to change disk array option settings

1. Ensure that the Command View XP main pane is in Modify mode. For more information, see [Table 9](#) on page 98.
2. Ensure that the Optional Operation pane is displayed (see “[Displaying the Optional Operation pane](#)” on page 686).
3. Select **Subsystem** in the tree. The list displays disk array options (see “[Changing disk array options](#)” on page 687).
4. Do one of the following:
  - Right-click **Subsystem** in the tree, and select **Change System Option**.
  - Right-click information in the list, and select **Change System Option**.
5. In the System Option pane, change disk array options.
6. Click **Set**.

7. In the **Preset** list, verify the changes you made.
  - To modify a change, right-click the change, and select **Modify**. A pane appears where you can modify the change.
  - To cancel a change, right-click the change, and select **Cancel**.
8. Click **Apply** to apply the changes.



**NOTE:** If an error occurs, the rightmost column of the **Preset** list displays the error code. To view detailed information about the error, right-click the error code, and select **Error Detail**. An error message appears providing detailed information about the error.

- **Max Initial Copy:** Number of volumes that can be copied concurrently during an initial copy operation.
- **Maximum Initial Copy Activities:** Number volumes that can be copied concurrently during an initial copy operation. A value within the range of 1 to 128 can be specified. The default is 64 volumes.

**Maximum Initial Copy Activities** can impact the performance of the primary disk array, depending on amount of I/O activity and number of pairs being registered at the same time. If **Maximum Initial Copy Activities** is 64 volumes, you can limit the impact of initial copy activities on disk array performance. For example, if you set the maximum initial copy activities to 64 volumes and add 65 pairs at the same time, the primary disk array starts the first 64 pairs and does not start the 65th pair until one of the pairs is synchronized. When you change the maximum initial copy activities setting, the new setting applies to pairs created after the setting was changed, not to existing pairs.

- **Set:** Closes the System Option pane, and adds settings to the **Preset** list.
- **Cancel:** Cancels settings.
- **Max Initial Copy:** Number of volumes that can be copied concurrently during an initial copy operation.
- **Error Code:** Displays an error code if an error occurs when you click **Apply**.

## Displaying CLPR options

Use the Optional Operations pane to view CLPR option settings. Currently, you cannot change CLPR option settings. For more information, see ["Disk/Cache Partition for the XP12000"](#) on page 143.

1. Ensure that the Optional Operation pane is displayed.
2. Select **CLPR** in the tree. The list displays CLPR options.
  - **CLPR:** CLPR number and name. The CLPR number is on the left of the colon (:), and the CLPR name is on the right of the colon.



**NOTE:** Currently, only CLPRO is displayed.

- **M-JNL Cache:** Ratio of cache areas for master journal groups to cache areas for CLPR.
- **R-JNL Cache:** Ratio of cache areas for restore journal groups to cache areas for CLPR.
- **Async JNL Start:** Threshold indicating when creation of asynchronous journal starts. Specify a value within the range of 0 to 100 percent. Creation of asynchronous journal starts when the ratio of journal data to cache capacity of the CLPR reaches this threshold.

---

# Disaster recovery operations

## Preparing for disaster recovery

The type of disaster and the status of the CA Journaling volume pairs determines the best approach for disaster recovery. Unfortunately, some disasters are not so “orderly” and involve intermittent or gradual failures occurring over a longer period of time. You should anticipate and plan for all types of failures and disasters.

The major steps in preparing for disaster recovery are:

1. Identify the journal groups and data volumes containing important files and data for disaster recovery.
2. Install the Command View XP management station and CA Journaling hardware and software, and establish CA Journaling operations for the journal groups and data volumes identified in [step 1](#).
3. Establish file and database recovery procedures. These procedures should already be established for recovering data volumes that become inaccessible due to some failure.
4. Install and configure host failover software between the primary and secondary sites.

## File and database recovery procedures

When the primary or secondary disk array suspends a CA Journaling pair due to a disaster, the secondary data volume might contain in-process data. A data set could be open or transactions might not have completed. Therefore, you must establish file recovery procedures. These procedures should be the same as those used for recovering data volume that becomes inaccessible due to control unit failure.

CA Journaling does not provide procedures for detecting and retrieving lost updates. To detect and recreate lost updates, you must check other current information (for example, database log file) that was active at the primary site when the disaster occurred. Since this detection/retrieval process can take a while, your disaster recovery scenario should be designed so that detection/retrieval of lost updates is performed after the application has started at the secondary site.

To prepare for file and database recovery, use the files for file recovery (for example, database log files that have been verified as current).



**IMPORTANT:** Remote copy and disaster recovery procedures are inherently complex. Consult your HP account support representative on recovery procedures.

---



**NOTE:** See “Power management for disk arrays and network relay devices” on page 698 for information on recovering a pinned track on a CA Journaling volume.

---

## Switching operations to the secondary site

If a disaster or failure occurs at the primary site, the first disaster recovery activity is to switch your operations to the secondary site. Executing the RAID Manager **horctakeover** command on CA Journaling pairs enables your business tasks to be taken over to the secondary site, using secondary data volumes in the secondary site. The **horctakeover** command checks the pair status of secondary data volumes and splits journal groups that will become a CA Journaling pair. This ensures consistency of secondary data volumes and makes the secondary data volumes usable. If possible, the **horctakeover** command attempts to restore pairs to reverse primary and secondary data volumes. If the **horctakeover** command executes successfully, your business tasks will be taken over to (or your business application will be started at) the secondary site, using secondary data volumes.

## Transferring operations back to the primary site

After the disaster recovery procedure is finished and your business applications are running at the secondary site, the next activity is to restore the primary site and make arrangements for copying data from the secondary site back to the primary site. The following procedure explains how to use RAID Manager to copy data from the secondary site to the primary site.

1. Restore the primary disk array and remote copy connections, bring up the host servers at the primary site, and ensure that all CA Journaling components are fully operational.
2. At the primary site, locate primary data volumes whose pair status is COPY or PAIR, and locate corresponding secondary data volumes whose pair status is SSWs. If such volume pairs are found, issue a request for splitting the pairs to the primary data volumes.
3. At the primary site, locate primary data volumes whose pair status is not SMPL, and locate corresponding secondary data volumes whose pair status is SMPL. If such volume pairs are found, issue a request for deleting the pairs to the primary data volumes.
4. At the primary site, locate data volume pairs whose pair status is SMPL, and issue a request for deleting the pairs to the secondary data volumes.
5. Execute the **pairresync -swaps** command on secondary data volumes whose pair status is SSWs (**pairresync** is the RAID Manager command for resynchronizing pair and **-swaps** is a swap option). This reverses primary and secondary data volumes to resynchronize pairs.
6. Create pairs, specifying secondary data volumes whose pair status is SMPL as primary data volumes. This creates pairs in which primary and secondary data volumes are reversed.
7. Verify that pair status of all secondary data volumes (which were originally primary data volumes) changes from COPY to PAIR. If the pair status is changed to PAIR, initial copy operations are finished and consistency is maintained.

This procedure enables copying of data from the secondary site to the primary site. Data in the secondary site is reflected on the primary site.

For more information about status of data volumes, see ["CA Journaling data volume pair status"](#) on page 608.

## Resuming normal operations at the primary site

After the CA Journaling volume pairs have been established in the reverse direction, you are ready to resume normal operations at the primary site. The following procedure explains how to use RAID Manager to resume normal operations at the primary site. Remember that the CA Journaling terminology is now reversed: the original primary data volumes are now secondary data volumes, and the original secondary data volumes are now primary data volumes.

1. At the primary and secondary sites, ensure that all CA Journaling components are fully operational and are free from failures.
2. Ensure that pair status of primary and secondary data volumes in all CA Journaling pairs is PAIR. This indicates that the CA Journaling initial copy operations are complete and consistency is maintained.
3. Stop the applications at the secondary site.
4. Issue a request for splitting pairs to master journal groups (which were originally restore journal groups); use the **Flush** option when splitting pairs. If an error occurs when splitting pairs, remove the error cause and go back to [step 1](#) after resuming your business task at the secondary site.
5. If no error occurs in [step 4](#), wait until suspension finishes. After suspension finishes, check whether there is a secondary data volume (which was originally a primary data volume) whose pair status is other than PSUS. If such a pair exists, remove the error cause and go back to [step 1](#) after resuming your business task at the secondary site.
6. If there is no secondary data volume (which was originally a primary data volume) whose pair status is other than PSUS, data in primary data volumes is the same as data in secondary data volumes, and



the secondary data volume (which was originally primary data volume) is usable. Resume applications at the primary site.

7. Execute the **pairresync -swaps** command (**pairresync** is the RAID Manager command for resynchronizing pair and **-swaps** is a swap option). This reverses primary and secondary data volumes to resynchronize pairs.

For more information about status of data volumes, see ["CA Journaling data volume pair status"](#) on page 608.

---

## Troubleshooting

You are responsible for the operation and normal maintenance of the Command View XP computer. For troubleshooting information on Command View, see ["Troubleshooting"](#) on page 835.

The following are guidelines for troubleshooting the Command View XP computer:

- Check the cabling and the LAN. Verify that both the computer and LAN cabling are firmly attached.
- Reboot the computer. Close any programs that are not responding. If necessary, reboot the computer and restart Command View XP.
- Check error codes.
- Check the status lamp on the Command View XP main pane. If the color of the lamp is yellow or red, check the status of the disk array on the Status pane (see ["Status monitoring XP48/XP512"](#) on page 127 or ["Status monitoring for the XP128/XP1024/XP12000"](#) on page 139). If you are unable to resolve an error condition, contact the HP Technical Support Center.
- Download the Command View XP trace files using the FD Dump Tool. If you are unable to resolve an error condition, copy the Command View XP configuration information onto floppy disks using the FD Dump Tool. Contact the HP Technical Support Center (see ["Calling the Support Center"](#) on page 698), and give the information on the floppy disks to the HP service personnel.

## Troubleshooting Command View XP operations

[Table 131](#) provides general troubleshooting information for CA Journaling. [Table 132](#) provides troubleshooting information for logical paths between disk arrays. [Table 133](#) and [Table 134](#) provide troubleshooting information for suspended CA Journaling pairs.

See ["CA Journaling error codes"](#) on page 697 for a description of the CA Journaling error messages displayed on the Command View XP computer. See ["Service Information Messages \(SIMs\)"](#) on page 698 for a brief description of the local disk array service information messages (SIMs).

**Table 131** General troubleshooting information for CA Journaling

Error	Corrective Action
The Command View computer hangs, or CA Journaling operations do not function properly.	<p>Ensure that the problem is not caused by the computer or Ethernet hardware or software, and restart the computer. Restarting the Command View XP computer does not affect CA Journaling operations in progress.</p> <p>Ensure that all CA Journaling requirements and restrictions are met. See <a href="#">"CA Journaling operations requirements and restrictions"</a> on page 614.</p> <p>Ensure that the primary disk array, secondary disk array, and remote copy connections are powered on, and NVS and cache are fully operational.</p> <p>Check all entered values and parameters to ensure you entered the correct information on the Command View XP computer (for example, secondary disk array S/N, path parameters, primary data volume IDs, and secondary data volume IDs).</p> <p>Ensure you are not using Auto LUN.</p>
An initiator or RCP channel-enable LED indicator (on the Command View control pane) is off or flashing.	Call the HP Support Center for assistance.
Status of pairs and/or logical paths is not displayed correctly.	Check if you selected correct items or options in CA Journaling panes, such as the DKC Operation pane, Pair Operation pane, and Display Filter pane.
A CA Journaling error message is displayed on the Command View XP computer.	Remove the error cause, and retry the CA Journaling operation.
The status of a logical path is not normal.	Check the path status in the DKC Status pane, and see <a href="#">Table 132</a> .
The pair status is <i>suspended</i> .	Check the pair status in the Pairedisplay pane, and see <a href="#">Table 133</a> .
Paircreate or pairresync operation resulted in a timeout error.	<p>If the timeout error was caused by a hardware failure, a SIM is generated. If this occurs, call the HP Support Center, and retry CA Journaling operations after the problem is solved.</p> <p>If no SIM was generated, wait for 5 or 6 minutes, and check the pair status of the pairs being created or resumed. If the pair status changed correctly, the failed operation completed after the timeout message was issued. If the pair status did not change as expected, heavy workload might have prevented the CA Journaling operation from being completed. In this case, retry the CA Journaling operation when the disk array has a lighter workload.</p>
There is a pinned track on a CA journaling volume.	See <a href="#">"Pinned track recovery for CA Journaling volumes"</a> on page 701 for instructions.

**Table 132** Troubleshooting problems with status of logical paths

Pair Status	Description	Corrective Action
Initialization Failed	Link initialization procedure for the remote disk array failed.	<p>Ensure that the local and remote disk arrays are connected correctly via cables.</p> <p>Ensure that you entered the correct serial number (S/N) of the remote disk array and the correct path parameters (for example, local disk array port, remote disk array port, and controller ID).</p> <p>Ensure that the topology settings of the local and remote disk array ports are correct.</p>
Communication Time Out	Communication between the local and remote disk arrays timed out.	<p>Ensure that the remote disk array is powered on, and NVS and cache are fully functional.</p> <p>Ensure that the network relay devices (cables, connectors, switches, ESCDs, extender devices, communication lines, and all other devices connected to the extenders) are properly configured and functional.</p> <p>Delete the failed path. You might need to change the minimum paths setting or delete the remote disk array to delete the path. After deletion finishes, add the path or remote disk array.</p>
Resource Shortage (Port) or Resource Shortage (Pair-Port)	Disk array rejected the request for establishing a logical path because all resources in the local and remote disk arrays are being used for other connections.	<p>Delete the failed path and all paths and remote disk arrays not currently in use. The local disk array can be connected to up to 64 remote disk arrays with up to eight paths to each remote disk array.</p> <p>Ensure that all ports on the local and remote disk arrays are properly configured: ordinary target ports or RCU target ports for hosts, RCU target ports for remote disk arrays, initiator ports for local disk arrays.</p> <p>If necessary, connect to the remote disk array to delete paths or remote disk arrays and reconfigure ports, and reconnect to the local disk array. After that, add the path and remote disk array again.</p>

**Table 132** Troubleshooting problems with status of logical paths (continued)

Pair Status	Description	Corrective Action
Serial Number Mismatch	Remote disk array's serial number (S/N) does not match the specified serial number (S/N).	<p>Ensure that you entered the correct remote disk array S/N and path parameters (for example, local disk array port, remote disk array port, and controller ID). After that, delete the failed path. You might need to change the minimum paths setting or delete the remote disk array to delete the path. After deletion finishes, add the path and the remote disk array.</p> <p>Ensure that you entered the correct controller ID. Ensure that the topology settings of the local and remote disk array ports are correct.</p>
Invalid Port	Specified port is not configured as an initiator port, or this path already exists.	<p>Ensure that the topology settings of the local and remote disk array ports are correct.</p> <p>Ensure that you entered the correct remote disk array S/N and path parameters (for example, local disk array port, remote disk array port, and controller ID). After that, delete the failed path. You might need to change the minimum paths setting or delete the remote disk array to delete the path. After deletion finishes, add the path and the remote disk array again.</p>
Port number invalid	Specified port number is invalid. The cable is not connected to the specified port.	Delete the failed path. Check the specified port number or cable connection, and retry.
Communication error	Timeout error occurred in the fibre path between the local and remote disk arrays.	Delete the failed path, and retry.
Pair-Port Number Mismatch	Specified port in the remote disk array is physically disconnected from the local disk array.	<p>Ensure that you specified the correct remote disk array port. Correct the port number if necessary.</p> <p>Ensure that the local and remote disk arrays are connected by cables to each other. If the disk arrays are not by cables, and retry the operation.</p> <p>Ensure that the topology settings of ports on the local and remote disk arrays are correct.</p>
Pair-Port Type Mismatch	Specified remote disk array port is not configured as an RCU target port.	Ensure that the remote disk array port is configured as an RCU target port.

**Table 132** Troubleshooting problems with status of logical paths (continued)

<b>Pair Status</b>	<b>Description</b>	<b>Corrective Action</b>
Communication Failed	Local disk array is connected to the remote disk array successfully, but a logical communication timeout occurred.	Ensure that the remote disk array port and network relay devices (for example, cables and switches) are properly configured and functioning.
Logical Blockade	Failure occurred at a local disk array port.	Repair the port status on the local disk array.
	Failure occurred at a remote disk array port.	Repair the port status on the remote disk array. After that, delete the path using the Delete Path or Delete DKC command, and add the path and remote disk array again using the Add Path or Add DKC command.
	Failure occurred in the path relay equipment.	Repair the path relay equipment. After that, delete the path using the Delete Path or Delete DKC command, and add the path and remote disk array again using the Add Path or Add DKC command.
	Connection cable is physically broken.	Replace the broken cable. After that, delete the path using the Delete Path or Delete DKC command, and add the path and remote disk array again using the Add Path or Add DKC command.
Program Error	Program error detected.	Delete the path using the Delete Path or Delete DKC command, and add the path and remote disk array again using the Add Path or Add DKC command.
<blank>	Path was not established.	Delete the failed path. You might need to change the minimum paths setting or delete the remote disk array to delete the path. After deletion finishes, add the path and remote disk array using the Add Path or Add DKC command.

**Table 133** Troubleshooting Suspended CA Journaling pairs

Suspend Type	Applies to	Description	Corrective Action
PSUE, by RCU	Primary data volume	Primary disk array suspended a pair because the primary disk array detected an error condition at the secondary disk array. The suspend type for the secondary data volume is by MCU.	Clear the error condition at the secondary disk array or secondary data volume. To access the secondary data volume, delete the pair from the primary disk array. If data in the secondary data volume has been changed, delete the pair from the primary disk array, and recreate the pair using the Paircreate pane. If data in the secondary data volume has not been changed, restore the pair from the primary disk array.
PSUE, S-VOL Failure	Primary data volume	Primary disk array detected an error during communication with the secondary disk array or detected an I/O error during update copy. In this case, the suspend type for the secondary data volume is usually by MCU.	Check the path status on the DKC Status pane (see <a href="#">Table 132</a> ).  Clear any error conditions at the secondary disk array and secondary data volume. To access the secondary data volume, delete the pair from the secondary disk array. If data in the secondary data volume has been changed, delete the pair from the primary disk array, and recreate the pair using the Paircreate pane. If data in the secondary data volume has not been changed, restore the pair from the primary disk array.
PSUE, MCU IMPL	Primary data volume, secondary data volume	Primary disk array could not find valid control information in its nonvolatile memory during the IMPL procedure. This error occurs only if the primary disk array is without power for more than 48 hours (power failure and fully discharged batteries).	Restore the pair (pairresync) from the primary disk array. The primary disk array performs an initial copy operation in response to the pairresync request, so the entire primary data volume is copied to the secondary data volume.
PSUE, Initial Copy Failed	Primary data volume, secondary data volume	Primary disk array suspended this pair during the initial copy operation. Data on the secondary data volume is not identical to data on the primary data volume.	Delete the pair from the primary disk array. Clear all error conditions at the primary disk array, primary data volume, secondary disk array, and secondary data volume. Restart the initial copy operation using the Paircreate pane.
PSUE, MCU P/S-OFF	Secondary data volume	Primary disk array suspended all CA Journaling pairs because the primary disk array was powered off.	None. Primary disk array automatically restores these CA Journaling pairs when the primary disk array is powered on.
PSUS, Journal Cache Overflow	Primary data volume, secondary data volume	Journal cache remains full over the timeout period.	Add cache memory, increase the number of paths between the primary and secondary disk arrays, or decrease the number of CA Journaling pairs or host I/Os.

Table 134 provides troubleshooting instructions for CA Journaling pair suspension. Hardware failures affecting cache memory and shared memory of the primary or secondary disk array might also cause CA Journaling pairs to be suspended.

**Table 134** Resolving CA Journaling pair suspension

Classification	Causes of Suspension	SIM	Recovery procedure
Primary disk array hardware or secondary disk array hardware	<p>Hardware redundancy was lost due to some blockade condition. As a result, one of the following could not complete: primary-secondary disk array communication, journal creation, copy operation, restore operation, staging process, or de-staging process.</p> <p>Journals cannot be retained because some portion of cache memory or shared memory was blocked due to hardware failure.</p> <p>Primary disk array failed to create and transfer journals due to unrecoverable hardware failure.</p> <p>Secondary disk array failed to receive and restore journals due to unrecoverable hardware failure.</p> <p>Drive parity group was in correction-access status while the CA Journaling was in COPY status.</p>	DC0x DC1x DC2x	<p>According to SIM, remove the hardware blockade or failure.</p> <p>Restore the failed volume pairs (pairresync).</p>
Communication between the primary and secondary disk arrays	<p>Communication between disk arrays failed because the secondary disk array or network relay devices were not running.</p> <p>Journal volumes or journal cache remained full even after the timeout period elapsed.</p>	DC0x DC1x	<p>Remove the failure from the primary and secondary disk arrays or network relay devices.</p> <p>If necessary, increase resources as needed (for example, amount of cache, number of paths between primary and secondary disk arrays, and parity groups for journal volumes).</p> <p>Restore the failed pairs (pairresync).</p>
RIO overload or RIO failure	<p>Unrecoverable RIO (remote I/O) timeout occurred because the disk array or networks relay devices were overloaded.</p> <p>RIO could not be finished due to a failure in the disk array.</p>	DC2x	<p>Delete failed pairs (pairsplit-S).</p> <p>If necessary, increase resources as needed (for example, amount of cache, number of paths between primary and secondary disk arrays, and parity groups for journal volumes).</p> <p>Re-establish failed pairs (paircreate).</p>
Planned power outage to the primary disk array	CA Journaling pairs were temporarily suspended due to a planned power outage to the primary disk array.	DC8x	None. Primary disk array automatically removes the suspension condition when the disk array is powered on.

## CA Journaling error codes

Command View XP computers display an error message when an error occurs during CA Journaling operations. The error message describes the error and displays an error code consisting of four digits.

The error message might also include a local disk array SVP error code. If you need to call the HP Support Center for assistance, report the error codes.

## Service Information Messages (SIMs)

The local disk array reports SIMs to hosts when it is necessary to notify you of possible service requirements for the disk array. SIMs can be generated by the disk array's channel and storage path microprocessors and service processor (SVP). The SVP reports all SIMs related to CA Journaling processing. Each time a SIM is generated, the amber Message LED on the local disk array control panel (under the Ready and Alarm LEDs) turns on as an additional alert.

SIMs are classified into four categories according to severity for reporting and logging purposes: *service*, *moderate*, *serious*, or *acute*. All SIMs are recorded on the local disk array SVP and displayed on Command View XP computers. During CA Journaling processing, the primary and secondary disk arrays generate a SIM each time the pair status of the primary or secondary data volume changes for any reason, including normal status transitions (for example, COPY to PAIR). SIMs generated by the primary disk array include the primary data volume's device ID (byte 13). SIMs generated by the secondary disk array include the secondary data volume's device ID (byte 13).

If SNMP is installed and operational for the local disk array, each SIM results in an SNMP trap being sent to the appropriate hosts.

## Calling the Support Center

If you need to call the HP Support Center, provide as much information about the problem as possible, including:

- Command View XP configuration information saved on disk using the FD Dump Tool
- Circumstances surrounding the error or failure
- Exact content of any error messages displayed on the host systems
- CA Journaling (or other) error codes displayed by Command View
- Reference codes and severity levels of recent service information messages (SIMs)

---

## Power management for disk arrays and network relay devices

This section explains power management for disk arrays and network relay devices during remote copy operations. In particular, this section discusses the following:

- What happens when power is removed from disk arrays or network relay devices due to an unexpected reason (see ["When power is removed due to an unexpected reason"](#) on page 698)
- What should be noted when you power off disk arrays or network relay devices intentionally (see ["When you turn power off intentionally"](#) on page 699)

The term "network relay devices" refers to hardware used for connecting primary and secondary disk arrays, such as ESCON directors, channel extenders, and switches.

### When power is removed due to an unexpected reason

This section explains what happens when power is removed from disk arrays or network relay devices due to an unexpected reason.



## When power is removed from primary disk arrays

If power is removed from the primary disk array during remote copy operations, the primary disk array assumes a failure occurred, and splits all data volume pairs. If the primary disk array splits data volume pairs, the secondary disk array also assumes a failure occurred, and splits all data volume pairs.

If power is removed from the primary or secondary disk array and its backup batteries are fully discharged while data volume pairs are split, differential data (that is, update data) is not retained. In this unlikely case, the primary or secondary disk array assumes all suspended data volumes are updated. If you restore data volume pairs at the primary site, all primary data volumes are copied to the secondary data volumes.

## When power is removed from secondary disk arrays

If power is removed from the secondary disk array during remote copy operations, the secondary disk array assumes a failure occurred, and splits all data volume pairs. If the secondary disk array splits data volume pairs, the primary disk array also assumes a failure occurred, and splits all data volume pairs.

If power is removed from the primary or secondary disk array and its backup batteries are fully discharged while data volume pairs are split, differential data (that is, update data) is not retained. In this unlikely case, the primary or secondary disk array assumes all suspended data volumes are updated. If you restore data volume pairs at the primary site, all primary data volumes are copied to the secondary data volumes.

## When power is removed from network relay devices

If power is removed from a network relay device during remote copy operations, the primary and secondary disk arrays assume a failure occurred, and split all data volume pairs.

## When you turn power off intentionally

This section explains what you should note when you power off disk arrays or network relay devices intentionally.

## When you power off primary disk arrays

To power off the primary disk array during remote copy operations, first ensure that all data volume pairs or mirrors (that is, pairs of journal groups) are split and the status of all data volume pairs is PSUS.



**CAUTION:** To power off the primary disk array, contact your HP account support representative and ask them to power off the disk array.

---

If data volume pairs are split and the primary disk array is powered off as mentioned above, use the following procedure to resume remote copy operations:

1. Power on the primary disk array.
2. If the primary disk array is ready to resume remote copy operations, restore data volume pairs that were split, and confirm that the status of the data volume pairs is COPY or PAIR. This operation must be performed at the primary site.

After taking these steps, remote copy operations resume. The primary disk array can respond to *read journal commands* issued by the secondary disk array.



**NOTE:** To power off the primary and secondary disk arrays at the same time, see [“When you power off primary and secondary disk arrays at the same time”](#) on page 700.

---

## When you power off secondary disk arrays

To power off the secondary disk array during remote copy operations, first ensure that all data volume pairs or mirrors (that is, pairs of journal groups) are split and the status of all data volume pairs is PSUS.



**CAUTION:** To power off the secondary disk array, contact your HP account support representative and ask them to power off the disk array.

---

If data volume pairs are split and the secondary disk array is powered off as mentioned above, use the following procedures to resume remote copy operations:

1. Power on the secondary disk array.
2. If the secondary disk array is ready to resume remote copy operations, restore data volume pairs that were split, and confirm that the status of the data volume pairs is COPY or PAIR. This operation must be performed at the primary site.

After taking these steps, remote copy operations resume. The secondary disk array can issue *read journal commands* to the primary disk array.



**NOTE:** To power off the primary and secondary disk arrays at the same time, see “[When you power off primary and secondary disk arrays at the same time](#)” on page 700.

---

## When you power off primary and secondary disk arrays at the same time

To power off the primary and secondary disk arrays at the same time, the primary disk array must be powered off before the secondary disk array is powered off. To power on the primary and secondary disk arrays again, the secondary disk array must be powered off before the primary disk array is powered off.

1. Split data volume pairs that are affected by powering off the primary and secondary disk arrays. For example, if two primary disk arrays and one secondary disk arrays are connected to each other and you want to power off one of the primary disk arrays and the secondary disk array, split data volume pairs defined between the remaining one primary disk array and primary disk array, because these data volume pairs are affected by powering off of the disk arrays.
2. After splitting the pairs finishes, confirm that the status of all pairs is changed to PSUS at the primary disk array.
3. Power off the primary disk array as described in “[When you power off primary disk arrays](#)” on page 699. Do not power on the primary disk array yet.
4. Power off the secondary disk array as described in “[When you power off secondary disk arrays](#)” on page 700.
5. Power on the secondary disk array.
6. If the secondary disk array is ready to resume remote copy operations, power on the primary disk array.
7. If the primary disk array is ready to resume remote copy operations, resume data volume pairs that were split at the primary disk array. Confirm that the status of data volume pairs is changed to COPY or PAIR.

## When you power off network relay devices

To power off a network relay device during remote copy operations, first ensure that all data volume pairs or mirrors (that is, pairs of journal groups) are split and the status of all data volume pairs is PSUS.

If data volume pairs are split and the network relay device is powered off as mentioned above, use the following procedure to resume remote copy operations:

1. Power on the network relay device.
2. If the network relay device is ready for remote copy operations, restore data volume pairs that were split, and confirm that the status of data volume pairs is COPY or PAIR. This operation must be performed at the primary site.

---

## Pinned track recovery for CA Journaling volumes

If a hardware failure occurs when the disk array is in operation, some data in the disk array's cache memory might not be written to disk drives and might remain in cache memory. Data remaining in cache memory due to such a reason is referred to as "pinned track."

If a pinned track occurs on a CA Journaling primary or secondary data volume, the primary disk array suspends the data volume pair (SIM reference code = D41x, D42x, DB1x, DB2x). Use the following procedure to ensure full data integrity of the data volume pair while recovering the pinned track:

1. Connect to the primary disk array.
2. Delete the data volume pair containing the volume with the pinned track (see ["Deleting a pair of data volumes"](#) on page 676).
3. If the volume is offline (for example, secondary data volume has pinned track), vary the volume online.
4. Perform your usual procedure for recovering data from a pinned track. See the pinned track recovery procedures for your operating system, or contact your HP representative for assistance in recovering the pinned track.
5. If the volume was previously offline (for example, secondary data volume, see [step 3](#)), vary the volume offline again.
6. Use the Paircreate command in the Pair Operation pane (see ["Creating a pair of data volumes \(Paircreate\)"](#) on page 667) to recover the data volume pair. Select the **Entire** initial copy option in the Paircreate pane.

If a pinned track occurs on a CA Journaling master or restore journal volume, use the following procedure to recover the pinned track:

1. Identify the journal group containing the journal volume where a pinned track occurs. Split the mirror where the journal group belongs (see ["Splitting mirrors \(Pairsplit-r: suspending copy operations\)"](#) on page 659).
2. Delete the journal volume containing the pinned track from the journal group (see ["Deleting journal volumes from journal groups"](#) on page 653).
3. Format the journal volume using the LDEV format function of Volume Management. For instructions on formatting the volume, see ["Volume Management for the XP128/XP1024/XP12000"](#) on page 241.
4. Register the formatted volume (or another volume that can be used instead of the formatted volume) in the journal group (see ["Registering journal volumes in journal groups"](#) on page 651).
  - If you do not need to resume copying, the procedure is finished.
  - To resume copying, continue to restore the mirror to which the journal group belongs (see ["Restoring mirrors \(Pairresync: resuming copy operations\)"](#) on page 660)



# 26 Flex Copy for the XP128/XP1024/XP12000

Use Flex Copy to copy data in both directions between HP StorageWorks XP128/XP1024/XP12000 Disk Arrays and external disk arrays. For example, the HP StorageWorks Modular Smart Array 1000 disk array can be used as an intermediate backup repository between the local disk array and a tape backup facility, thereby substantially reducing data restore time during backup/restore operations.

External Storage XP is another HP StorageWorks product for managing external storage devices. For more information, see "[Comparison of Flex Copy with External Storage XP](#)" on page 706.

This chapter describes Flex Copy operations and provides instructions for performing them on disk arrays.



**NOTE:** Unlike Business Copy XP, Flex Copy does not maintain any degree of data concurrency or perform any "delta-update" operations. Instead, Flex Copy completes one full copy to/from the data source and the copy destination. Therefore, you must pause or stop all write activity on the Flex Copy source LU before initiating a Flex Copy copy to/from external storage to ensure that data copied is in a viable state.

## Flex Copy features

If you use Flex Copy to connect an HP StorageWorks XP128/XP1024/XP12000 disk array to an external disk array, you can copy data between the local disk array and external disk array. As you copy data, you can, for example, gather and compile data from several external disk arrays to one XP array and then distribute compiled data back to the external disk arrays. Use Flex Copy to easily back up data in an XP128/XP1024/XP12000 disk array to an external disk array and then restore the backed-up data to the local disk array.

In this chapter, the term *local disk array* refers to the XP128/XP1024/XP12000 disk array. The connected disk array is called the *external disk array* (elsewhere it may be referred to as the "Flex Copy device"). A Logical Unit (LU) managed in the local disk array is called an *internal LU*, while an LU in an external disk array is called an *external LU*.



**NOTE:** Currently the MSA1000 is the only external disk array supported by Flex Copy.



**NOTE:** An external LU mapped for Flex Copy operations cannot be accessed from the host connected to the local disk array. For Flex Copy operations, set the host **I/O Suppression** mode to **Enable** when you map an external LU to an internal LU. For detailed information on attributes for mapped volumes, see "[External LU attributes set by mapping](#)" on page 773.

## Flex Copy pairs

Use Flex Copy to create a pair containing a source LU and destination LU, and then copy data from the source LU to the destination LU. The source LU is called *P-VOL* (*primary volume*). The destination LU is called *S-VOL* (*secondary volume*).

## Mapping

*Mapping* means assigning CU:LDEV numbers of internal LUs to external LUs. By assigning the numbers of internal LUs to external LUs, you can make copies of data in the local disk array to the external LUs as if the copies were created in the internal LUs. By mapping an external LU as an internal LU, you can:

- Specify the external LU as if it were the local disk array LU. Note that this external LU cannot be used by the host attached to the local disk array.
- Create a copy of the XP128/XP1024/XP12000 LU in the external LU.
- Copy data from an external disk array (external LU) to a local disk array LU.

For instance, you can easily migrate data to a local disk array when you remove the external disk array: you simply copy all the data in the external LUs to the XP LUs.



**NOTE:** Hosts connecting to the local disk array cannot access external LUs, even when external LUs are mapped to internal LUs.

---



**NOTE:** The capacity of the LU on the HP StorageWorks XP local disk array and that of the external disk array are usually different. Therefore, be careful when specifying the copy source LU and copy destination LU. If one LU capacity is smaller than the other, Flex Copy uses the smaller capacity to determine the copy range. If the capacity of the destination LU is smaller than that of the source LU, some of the data in the source LU might not be copied to the destination LU. For detailed information on the relationship between LU capacity and copy range, see "[Required volume capacity for each emulation type](#)" on page 819.

---

**Figure 357** illustrates a connection between a local disk array and an external disk array interconnected with the Flex Copy function. In this figure, the external disk array is connected to the external port of the

local disk array via a switch (or hub) using a Fibre Channel interface. The external port is a kind of port attribute used for Flex Copy. In the figure, external LUs are mapped as local disk array LUs.

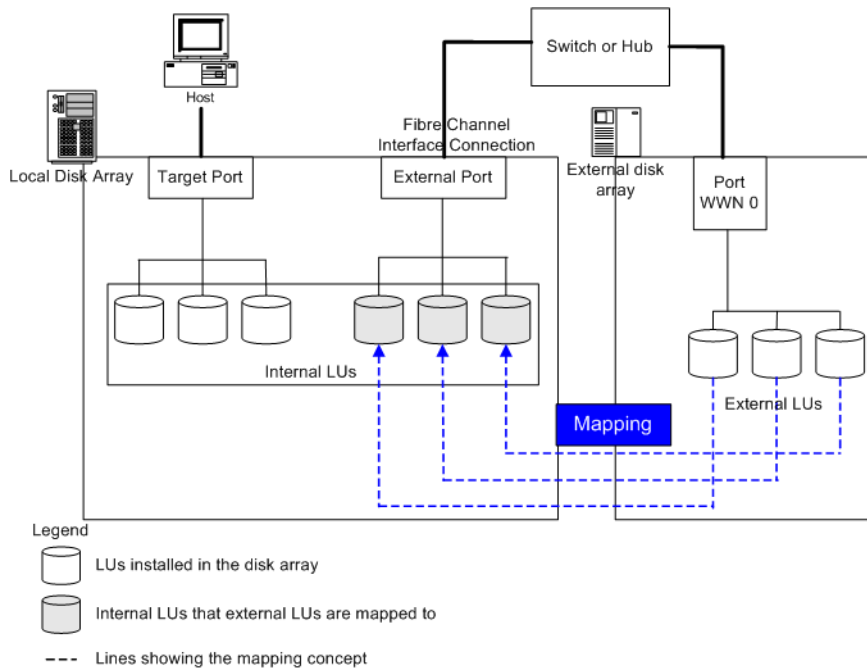

**Figure 357** Flex Copy concept

**Figure 358** illustrates the concept of copying data from an external LU to a local disk array LU. In the figure, the LU in the external disk array (labelled A) is mapped as an internal LU in the local disk array. In addition, data in the external LU is copied to the local disk array LU using the copy feature of Flex Copy. Note that when the Flex Copy operation is in progress, the host cannot have read/write access to the internal LU.

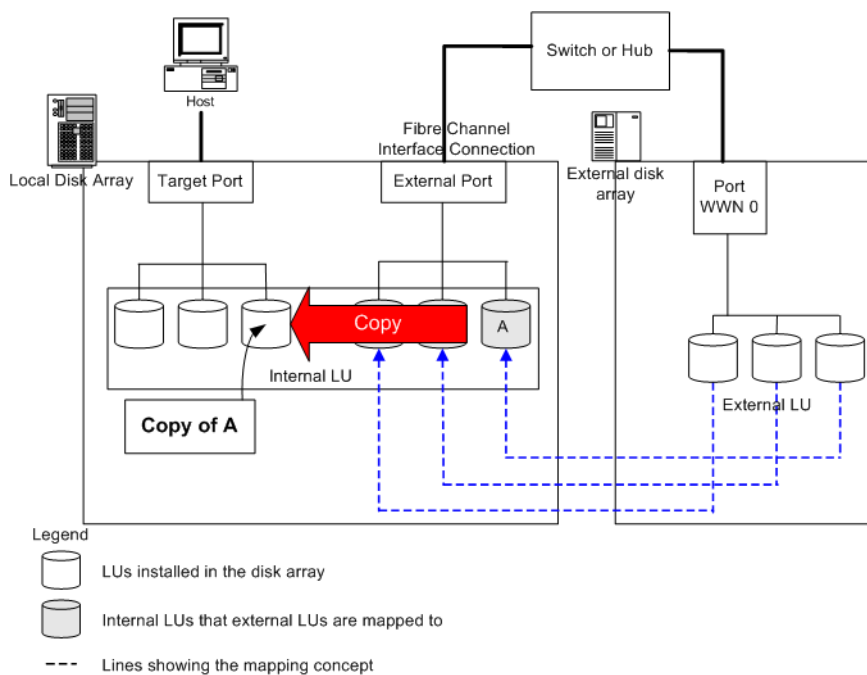

**Figure 358** Copying data from an external LU to the local disk array LU

Figure 359 shows the concept of copying data in an internal LU to an external LU. The LU in the local disk array (B) is copied to the mapped external LU using Flex Copy. Note that during the Flex Copy copy operation, the host cannot access the internal LU B.

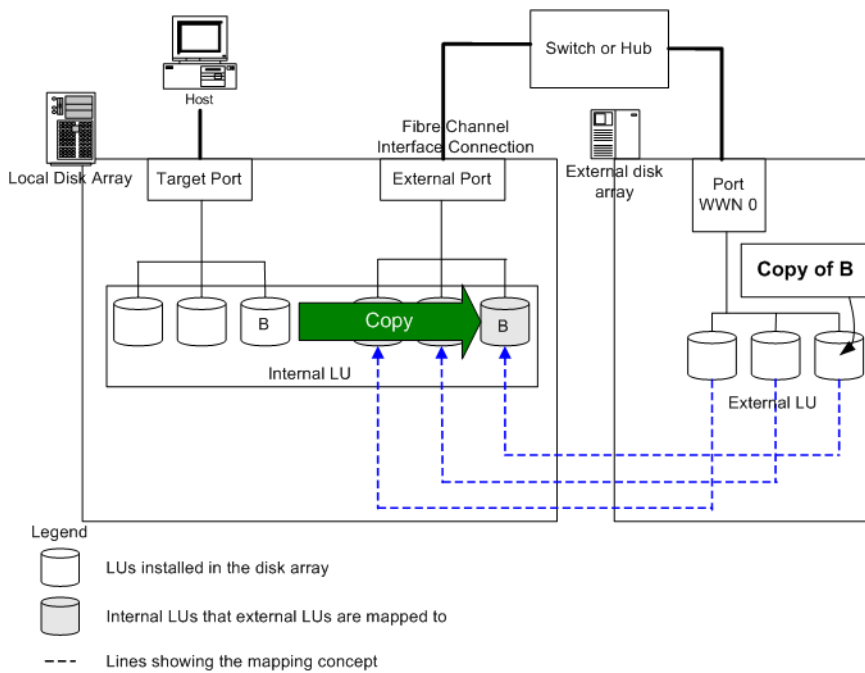

Figure 359 Copying data from a local disk array to an external LU

## Comparison of Flex Copy with External Storage XP

HP StorageWorks offers two products to work with external storage devices: Flex Copy and External Storage XP. Table 135 compares the features and constraints of both products.

Table 135 Comparison of Flex Copy with External Storage XP

Flex Copy features	External Storage XP features
A one-time, point-in-time copy of data from the local disk array to or from the external disk array	Real-time usage of external storage devices as additional local disk array storage, providing a total capacity of up to 32 peta-bytes and thousands of external LUs
Host access to the external array LU must be <b>by direct connection to the external storage device</b> —it cannot be via the local disk array	Host access to the external storage LU must be <b>via the local disk array</b> —it cannot be by direct connection to the external disk array LU
All Flex Copy LDEVs on the local disk array imported from external storage must have OPEN-V emulation type	For external array LUs not involved with External Storage XP, direct access from a host is allowed with external XP disk arrays and disallowed with external HP StorageWorks Modular Smart Array (MSA) 1000 disk arrays



**Table 135** Comparison of Flex Copy with External Storage XP (continued)

Flex Copy features	External Storage XP features
Local disk arrays supported: for XP128/XP1024/XP12000	Local disk array supported: XP12000 only
	Difference bitmaps for any BC XP volumes located on external storage reside within the XP12000
	Local disk array LDEVs imported from external storage can be mapped in (from the XP12000's perspective) as any standard XP emulation type (with a few limitations, as described in " <a href="#">External storage for the XP12000</a> " on page 757.

---

## Combining Flex Copy with other HP StorageWorks products

For a list of products you can use to manage external LUs mapped with Flex Copy, see "[Combining External Storage XP with other HP StorageWorks products](#)" on page 764.

---

## Requirements and restrictions

This section describes requirements and restrictions for Flex Copy operations. Topics include:

- "[System requirements](#)" on page 707
- "[Storage devices that can be connected as external disk arrays](#)" on page 708
- "[Flex Copy capacities](#)" on page 708
- "[Requirements for LUs used for copy pairs](#)" on page 709
- "[Adjusting LU capacity when setting copy pairs](#)" on page 710
- "[Maximum number of copy pairs](#)" on page 711
- "[Precautions for copy operations](#)" on page 716

### System requirements

Flex Copy operations involve the XP128/XP1024/XP12000 disk array, an external disk array, and the Flex Copy license key. The system requirements for Flex Copy are:

- Local disk array (first disk array)

All hardware and microcode required for Flex Copy operations must be installed and enabled.

- External disk array (second disk array)

You also need a second disk array (*external disk array*). For a list of external storage devices supported by Flex Copy, see "[Storage devices that can be connected as external disk arrays](#)" on page 708.

- HP StorageWorks Command View for local disk arrays (running on a Command View management station)

See the *HP StorageWorks Command View XP Installation Guide* for instructions on installing Command View.



**NOTE:** You must run Command View in Modify mode to perform Flex Copy operations. Users in View mode can only view Flex Copy information.

- Flex Copy

The licensed Flex Copy feature must be enabled in Command View.

## Storage devices that can be connected as external disk arrays

Currently the MSA1000 is the only external disk array supported by Flex Copy.

## Flex Copy capacities

Flex Copy has the following capacities:

**Table 136** Flex Copy capacities

Item	Requirement
Kinds of disk arrays that can be connected as local disk arrays	XP128/XP1024/XP12000
Maximum number of pairs	8,192. However, if a large-capacity LU is used for the pair, the maximum number of pairs becomes smaller. For information about calculating maximum number of pairs, see " <a href="#">Maximum number of copy pairs</a> " on page 711.
Capacity of LUs to be set for copy pair	The capacity of source and destination LUs must be identical.  When you set LUSE volumes in a Flex Copy pair, note the following:  Both source and destination volumes must be LUSE volumes.  Number of LDEVs comprising LUSE volumes must be the same for both source and destination volumes.  LDEVs placed in the corresponding location in each LUSE volume must have the same capacity.
Maximum number of concurrent copies	64 copy pairs
Copying method	Always copies all data from source volume to destination volume.
Number of destination volumes	Flex Copy pairs must be configured with one source volume and one destination volume.



**NOTE:** On the external LU used for Flex Copy operations, you must select **IO Suppression** mode when you map the external volume to an internal volume. For information on **IO Suppression** mode, see "[External port attributes](#)" on page 773. For information on mapping operations, see "[Mapping external LUs](#)" on page 791.

# Requirements for LUs used for copy pairs

This section explains requirements for LUs that can be set as copy source (P-VOL) and copy destination (S-VOL) LUs in Flex Copy pairs. To see how to adjust the LU capacity to set the LU as the P-VOL or S-VOL of the Flex Copy pair, see ["Adjusting LU capacity when setting copy pairs"](#) on page 710.

- When specifying the P-VOL and S-VOL of a Flex Copy copy pair, you must specify an LU in your local disk array and an external LU mapped to an LU in your local disk array.
- If you use a mapped external LU as the P-VOL or S-VOL in a Flex Copy pair, when you map the LU, you must:
  - set emulation type to **OPEN-V**
  - set **IO Suppression** mode to **Enable**
- Both the P-VOL and S-VOL must be offline from the host.
- To use the S-VOL for operations other than Flex Copy operations, you must first cancel the copy pair.
- Status of the P-VOL and S-VOL must be **Normal**.
- Capacity of the P-VOL and S-VOL must be the same.
- Total capacity of the P-VOL and S-VOL must not exceed the capacity licensed for Flex Copy.
- LU capacity must be within the range of about 47 MB (96,000 blocks) and 2 TB (4,294,967,296 blocks).
- LUs set for Auto LUN XP or Business Copy XP cannot be used as copy pair LUs for Flex Copy operations.
- LUs set as reserve LUs for Auto LUN XP or Business Copy XP cannot be used as copy pair LUs for Flex Copy operations.
- NAS system volumes cannot be specified as Flex Copy S-VOLs.
- LUs configured as command devices, which are reserved for use by hosts, cannot be specified as Flex Copy P-VOLs or S-VOLs
- If an LU is already specified as the P-VOL or S-VOL in one Flex Copy copy pair, it cannot be specified as the P-VOL or S-VOL of another Flex Copy copy pair.

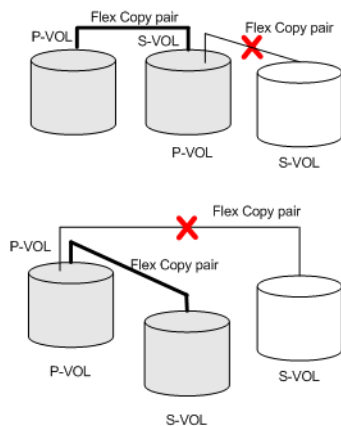

**Figure 360** Examples of LUs that cannot be shared by Flex Copy pairs

- Configuration of LUSE volumes for the P-VOL and S-VOL must be identical. To do this, first map the external LU (used as a copy pair LU) as an internal LU. Then set the LU as a LUSE volume with the same configuration as the local disk array LU that will be the copy pair with the mapped external volume.

- If LUN Security XP Extension is used to prevent LUs from being specified as S-VOLs, the LUs cannot be specified as Flex Copy S-VOLs.
- You cannot cancel all LU paths to an LU that is a member of a copy pair.
- If you attempt to set a Flex Copy pair and fail, delete the pair (using the **Delete Pair** command) and retry the pair setting operation (using the **Create Pair** command).

## Adjusting LU capacity when setting copy pairs

When you set a Flex Copy copy pair, the capacity of the S-VOL must be equal to that of the P-VOL. To set a desired volume to a copy pair, you may need to adjust the LU capacity. This section describes the procedures for adjusting LU capacity.

## Copying data from external disk arrays to local disk arrays

When you copy data from an external disk array to a local disk array, LU capacity of the local array must equal that of the external array. To create a copy pair using a local disk array LU that is larger than the corresponding external LU, however, first use the Volume Size Configuration process (VSC) to create a CV with the same capacity as the external LU out of the local disk array LU. For further information on VSC, see “[Volume Size Configuration \(VSC\)](#)” on page 243.



**NOTE:** When an external disk array LU is mapped as an internal LU of a local disk array, the displayed capacity of the external LU is corrected to equal the capacity of the mapped internal LU. In Command View operation panes, the corrected capacity appears as if the external LU had the displayed capacity. The actual available capacity is the original capacity of the external LU, however.

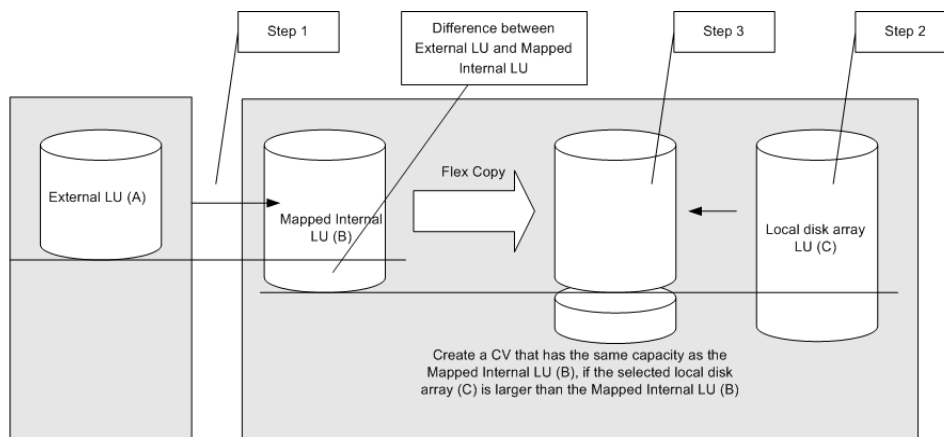

**Figure 361** Copying data from an external disk array to a local disk array

The LUs A, B, and C in the following procedure refer to [Figure 361](#).

### To adjust the capacity of the local disk array LU (C)

1. Map the external LU (A) as an internal LU (B) on the local disk array.
2. Select a local disk array LU (C) with capacity either:
  - a. equal to that of the mapped internal LU (B)
  - b. greater than that of the mapped internal LU (B)
3. If you select a local disk array LU (C) with capacity greater than that of the mapped internal LU (B), use the VSC process to create a CV with the same capacity as the mapped internal LU out of the local disk array LU (C).



**NOTE:** When you use the VSC process to create a CV with the same capacity as the mapped internal LU (B), set the CV capacity according to the **Blocks** capacity appearing in the **Capacity** column on the Flex Copy LDEV Information window (see “[Checking External Storage XP volume status \(LDEV Information\)](#)” on page 806).

## Copying data from local disk arrays to external disk arrays

When you copy data from a local disk array to an external disk array, the LU capacity of the external array must equal that of the local array. To create a copy pair using an external LU that is larger than the local disk array LU, however, first use the Volume Size Configuration (VSC) process to create a CV with the same capacity as the local disk array LU out of the external LU. For further information on the VSC process, see “[Volume Size Configuration \(VSC\)](#)” on page 243.

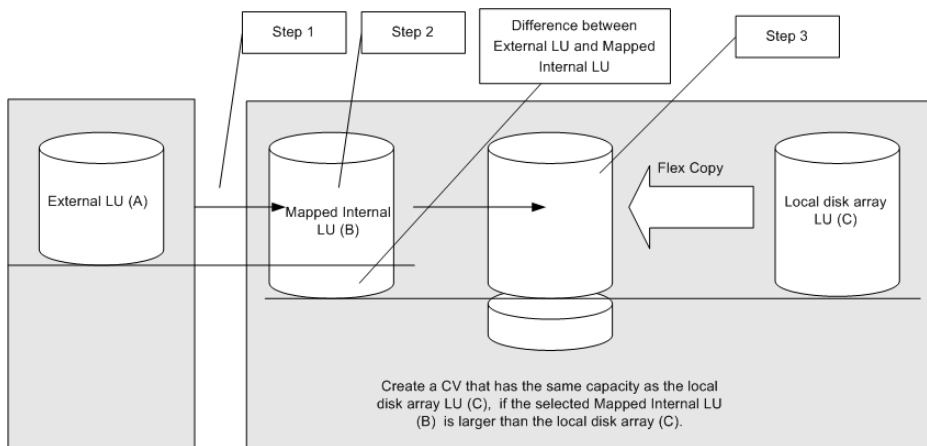

**Figure 362** Copying data from a local disk array to an external disk array

The LUs A, B, and C in the following procedure refer to [Figure 362](#).

### To adjust the capacity of the external LU (A)

1. Map the external LU (A) as an internal LU (B) on the local disk array.
2. Select a mapped internal LU (B) with capacity either:
  - a. equal to that of the local disk array LU (C)
  - b. greater than that of the local disk array LU (C)
3. If you select a mapped internal LU (B) with capacity greater than that of the local disk array volume (C), use the VSC process to create a CV with the same capacity as the local disk array LU out of the mapped internal LU.



**NOTE:** When you use the VSC process to create a CV with the same capacity as the LU (C), set the CV capacity according to the **Blocks** capacity appearing in the **Capacity** column on the Flex Copy LDEV Information window (see “[Checking External Storage XP volume status \(LDEV Information\)](#)” on page 806).

## Maximum number of copy pairs

The maximum number of copy pairs you can create is 8,192. However, the maximum number of copy pairs can be smaller than 8,192 if you use large-sized LUs to create pairs.

The number of copy pairs you can create depends on the emulation type and capacity of the paired volumes. To find out how many pairs you can create, perform calculations using the following equations, where:

- $\Sigma(\alpha)$  is total number of differential tables ( $\alpha$ ) required to create a copy pair. To find out the value of  $\Sigma(\alpha)$ , see [Table 137](#) and [Table 138](#). These tables list number of differential tables required to create a copy pair according to volume emulation type and capacity.
- ( $\beta$ ) is number of differential tables available in the local disk array.
  - ( $\beta$ ) = 13,652 when additional shared memory for differential tables is not installed.
  - ( $\beta$ ) = 30,718 when additional shared memory for differential tables is installed. (To install additional shared memory for differential tables, contact your HP account support representative.)
- If one LU consists of one volume (when LUSE is not used)

The maximum number of pairs you can create is the largest number that complies with the following equation:

$$\Sigma(\alpha) \leq \beta$$

For example, to create 10 pairs of OPEN-3 volumes and 20 pairs of OPEN-V (60GB) volumes, this equation is as follows:

$$(1 \times 10) + (5 \times 20) = 110 \leq 13,652 \text{ or } 30,718$$

Since this equation is true, you can create as many pairs as you want.

- If one LU consists of more than one volume (when LUSE is used)

The maximum number of pairs you can create is the largest number that complies with the following equation:

$$[\Sigma(\alpha) \times (\text{number of volumes that configure a LUSE volume})] \leq \beta$$

For example, to create 10 pairs of LUSE volumes consisting of three OPEN-3 volumes and 20 pairs of LUSE volumes consisting of five OPEN-V (60GB) volumes, this equation is as follows:

$$(1 \times 3 \times 10) + (5 \times 5 \times 20) = 530 \leq 13,652 \text{ or } 30,718$$

Since this equation is true, you can create as many pairs as you want.

Differential tables are used to create a copy pair. These tables are XP12000 resources shared by Flex Copy, Business Copy XP, Hitachi ShadowImage for z/OS®, Hitachi FlashCopy® Mirroring, and Auto LUN XP. Therefore, the maximum number of differential tables Flex Copy can use is the total number of differential tables in the disk array minus the number used by other programs.

The previous discussion only considered the number of differential tables used by Flex Copy. In fact, the total number of differential tables used by Business Copy XP, Hitachi ShadowImage for z/OS® (for XP12000), ShadowImage - S/390 (for XP1024), Hitachi FlashCopy® Mirroring, Auto LUN XP, and Flex Copy must be included in the value of ( $\beta$ ). For details on calculating the number of differential tables used by programs other than Flex Copy, see their respective documentation.

For Hitachi ShadowImage for z/OS® or Hitachi FlashCopy® Mirroring, see the *Hitachi ShadowImage for z/OS User's Guide*.

**Table 137** Relationship between emulation type, capacity, and differential tables

Emulation type	Capacity	Differential Tables per Pair (a)
OPEN-3	Does not depend on capacity	
OPEN-8	Up to 2.7GB	1
	Up to 5.5GB	2
	Up to 6.8GB	3
OPEN-9	Up to 2.7GB	1
	Up to 5.5GB	2
	Up to 6.8GB	3
OPEN-E	Up to 2.7GB	1
	Up to 5.5GB	2
	Up to 8.4GB	3
	Up to 11.2GB	4
	Up to 13.5GB	5
OPEN-L	Up to 2.8GB	1
	Up to 5.6GB	2
	Up to 8.4GB	3
	Up to 11.2GB	4
	Up to 14.0GB	5
	Up to 16.8GB	6
	Up to 19.6GB	7
	Up to 22.4GB	8
	Up to 25.2GB	9
	Up to 28.0GB	10
	Up to 30.8GB	11
	Up to 33.6GB	12
	Up to 33.9GB	13
OPEN-F	Does not depend on capacity	1
OPEN-V	See <a href="#">Table 138</a>	

1 GB = 1024<sup>3</sup> bytes

**Table 138** Number of differential tables used in OPEN-V

Capacity	Differential Tables per Pair	Capacity	Differential Tables per Pair	Capacity	Differential Tables per Pair
Up to 14.9GB	1	Up to 464.0GB	31	Up to 913.0GB	61
Up to 29.9GB	2	Up to 478.9GB	32	Up to 928.0GB	62
Up to 44.9GB	3	Up to 493.9GB	33	Up to 943.0GB	63
Up to 59.8GB	4	Up to 508.9GB	34	Up to 957.9GB	64
Up to 74.8GB	5	Up to 523.9GB	35	Up to 972.9GB	65
Up to 89.8GB	6	Up to 538.8GB	36	Up to 987.9GB	66
Up to 104.7GB	7	Up to 553.8GB	37	Up to 1,002.8GB	67
Up to 119.7GB	8	Up to 568.8GB	38	Up to 1,017.8GB	68
Up to 134.7GB	9	Up to 583.7GB	39	Up to 1,032.8GB	69
Up to 149.6GB	10	Up to 598.7GB	40	Up to 1,047.8GB	70
Up to 164.6GB	11	Up to 613.7GB	41	Up to 1,062.7GB	71
Up to 179.6GB	12	Up to 628.7GB	42	Up to 1,077.7GB	72
Up to 194.5GB	13	Up to 643.6GB	43	Up to 1,092.7GB	73
Up to 209.5GB	14	Up to 658.6GB	44	Up to 1,107.6GB	74
Up to 224.5GB	15	Up to 673.5GB	45	Up to 1,122.6GB	75
Up to 239.4GB	16	Up to 688.6GB	46	Up to 1,137.6GB	76
Up to 254.4GB	17	Up to 703.5GB	47	Up to 1,152.5GB	77
Up to 269.4GB	18	Up to 718.4GB	48	Up to 1,167.6GB	78
Up to 284.3GB	19	Up to 733.4GB	49	Up to 1,182.5GB	79
Up to 299.3GB	20	Up to 748.4GB	50	Up to 1,197.4GB	80
Up to 314.3GB	21	Up to 763.4GB	51	Up to 1,212.4GB	81
Up to 329.3GB	22	Up to 778.3GB	52	Up to 1,227.4GB	82
Up to 344.2GB	23	Up to 793.3GB	53	Up to 1,242.5GB	83
Up to 359.2GB	24	Up to 803.3GB	54	Up to 1,257.3GB	84
Up to 374.2GB	25	Up to 823.2GB	55	Up to 1,272.3GB	85
Up to 389.1GB	26	Up to 838.2GB	56	Up to 1,287.3GB	86
Up to 404.1GB	27	Up to 853.2GB	57	Up to 1,302.2GB	87



**Table 138** Number of differential tables used in OPEN-V (continued)

Capacity	Differential Tables per Pair	Capacity	Differential Tables per Pair	Capacity	Differential Tables per Pair
Up to 419.1GB	28	Up to 868.1GB	58	Up to 1,317.2GB	88
Up to 434.0GB	29	Up to 883.1GB	59	Up to 1,332.2GB	89
Up to 449.0GB	30	Up to 898.1GB	60	Up to 1,347.1GB	90
Up to 1,362.1GB	91	Up to 1,811.2GB	121	Up to 2,260.2GB	151
Up to 1,377.1GB	92	Up to 1,826.1GB	122	Up to 2,275.2GB	152
Up to 1,392.0GB	93	Up to 1,841.1GB	123	Up to 2,290.2GB	153
Up to 1,407.0GB	94	Up to 1,856.1GB	124	Up to 2,305.1GB	154
Up to 1,422.0GB	95	Up to 1,871.0GB	125	Up to 2,320.1GB	155
Up to 1,436.9GB	96	Up to 1,886.0GB	126	Up to 2,335.1GB	156
Up to 1,451.9GB	97	Up to 1,901.0GB	127	Up to 2,350.0GB	157
Up to 1,466.9GB	98	Up to 1,915.9GB	128	Up to 2,365.0GB	158
Up to 1,481.8GB	99	Up to 1,930.9GB	129	Up to 2,380.0GB	159
Up to 1,496.8GB	100	Up to 1,945.9GB	130	Up to 2,394.9GB	160
Up to 1,511.8GB	101	Up to 1,960.9GB	131	Up to 2,409.9GB	161
Up to 1,526.8GB	102	Up to 1,975.8GB	132	Up to 2,424.9GB	162
Up to 1,541.7GB	103	Up to 1,990.8GB	133	Up to 2,439.9GB	163
Up to 1,556.7GB	104	Up to 2,005.8GB	134	Up to 2,454.8GB	164
Up to 1,571.7GB	105	Up to 2,020.7GB	135	Up to 2,469.8GB	165
Up to 1,586.6GB	106	Up to 2,035.7GB	136	Up to 2,484.8GB	166
Up to 1,601.6GB	107	Up to 2,050.7GB	137	Up to 2,499.7GB	167
Up to 1,616.6GB	108	Up to 2,065.6GB	138	Up to 2,514.7GB	168
Up to 1,631.5GB	109	Up to 2,080.7GB	139	Up to 2,529.7GB	169
Up to 1,646.5GB	110	Up to 2,095.6GB	140	Up to 2,544.6GB	170
Up to 1,661.5GB	111	Up to 2,110.5GB	141	Up to 2,559.6GB	171
Up to 1,676.4GB	112	Up to 2,125.5GB	142	Up to 2,574.6GB	172
Up to 1,691.4GB	113	Up to 2,140.5GB	143	Up to 2,589.5GB	173
Up to 1,706.4GB	114	Up to 2,155.4GB	144	Up to 2,604.5GB	174
Up to 1,721.4GB	115	Up to 2,170.4GB	145	Up to 2,619.5GB	175

**Table 138** Number of differential tables used in OPEN-V (continued)

Capacity	Differential Tables per Pair	Capacity	Differential Tables per Pair	Capacity	Differential Tables per Pair
Up to 1,736.3GB	116	Up to 2,185.4GB	146	Up to 2,634.4GB	176
Up to 1,751.3GB	117	Up to 2,200.4GB	147	Up to 2,649.4GB	177
Up to 1,766.3GB	118	Up to 2,215.3GB	148	Up to 2,664.4GB	178
Up to 1,781.2GB	119	Up to 2,230.3GB	149	Up to 2,679.3GB	179
Up to 1,796.2GB	120	Up to 2,245.3GB	150	Up to 2,694.3GB	180
Up to 2,709.3GB	181	Up to 2,784.1GB	186	Up to 2,859.0GB	191
Up to 2,724.3GB	182	Up to 2,799.1GB	187	Up to 2,873.9GB	192
Up to 2,739.2GB	183	Up to 2,814.1GB	188	Up to 2,880.0GB	193
Up to 2,754.2GB	184	Up to 2,829.0GB	189		
Up to 2,769.2GB	185	Up to 2,844.0GB	190		

## Precautions for copy operations

Use Flex Copy to create a copy pair consisting of a local disk array LU and an external LU mapped to an internal LU, and then perform copy operations using that pair.

Once you mapped external LUs using Flex Copy, you can also use RAID Manager XP to perform copy operations on a copy pair consisting of an internal LU and an external LU mapped by Flex Copy.

Topics in this section include:

- ["General precautions and tips for more efficient copy operations"](#) on page 716
- ["Precautions concerning Flex Copy pair volumes"](#) on page 717
- ["Status of copy pairs"](#) on page 722
- ["Copy operations using Command View"](#) on page 725
- ["Copy operations using RAID Manager XP"](#) on page 725

## General precautions and tips for more efficient copy operations

Note the following precautions concerning Flex Copy copy operations:



### CAUTION:

- When creating copy pairs, ensure that hosts do not access external LUs mapped as internal LUs.

If host access occurs during copy operations, consistency of backup data may not be guaranteed. HP recommends that you unmount volumes mapped as internal LUs from hosts connecting to the external disk array, and ensure that volumes are used exclusively for Flex Copy.

- Once you create a copy pair with Flex Copy, hosts connecting to the local disk array cannot access the internal LU until you delete the copy pair with Flex Copy.

---

Copy operations proceed more efficiently if you remember the following:

- Before you perform copy operations, ensure that you have all required data on the disk you want to replicate.
- If a host uses middleware such as Volume Manager, data in the destination LU (S-VOL) will not match data in the host until data in the source LU (P-VOL) is exported from the host and applied to the disk array.

When copying data from an external disk array to a local disk array, first export data from Volume Manager on the host connecting to the external disk array, and apply it to the external disk array. Then perform a copy operation with Flex Copy. After the copy is complete, cancel the copy pair. By importing the copied data from Volume Manager on the host connecting to the local disk array, you ensure that data in the external disk array is usable on the local disk array.

- If copy operations are performed concurrently on two or more pairs, ensure that the pairs are located in separate parity groups (for example, separate RAID groups). If two or more Flex Copy pairs are in the same parity group, I/O performance on the host server may suffer. The following remedies are recommended for reducing the risk of impaired I/O performance:
  - Reduce the number of pairs in the parity group on which simultaneous copy operations are performed. For example, to create several pairs in a single parity group, do not create a new pair until the copy operation on the previous pair is finished.
  - Ensure that external disk array LUs mapped by Flex Copy are in separate parity groups.
  - Add cache memory, disk adapters (DKAs), and parity groups if the local disk array is overloaded. Host I/O performance may suffer if you use Flex Copy when the disk array is overloaded.
- Flex Copy enables up to 64 concurrent copy operations. If the number of copy requests exceeds 64, the 65th and subsequent requests will not be processed until a copy operation in progress has completed.
- If Flex Copy copy operations are performed concurrently with Business Copy XP or Auto LUN XP copy operations, the performance of all copy operations decreases (that is, each copy operation is slower).

Performance of a Flex Copy copy operation on a volume decreases if the ECC group containing that volume also contains a volume being used by a Business Copy XP or Auto LUN XP copy operation.

- The local disk array does not force the external disk array to reserve the mapped external LU. Therefore, do not write from the external disk array side to a mapped external LU that has **IO Suppression** mode set to **Disable**. Furthermore, Flex Copy operations may be in progress for the volume with **IO Suppression** mode set to **Enable**. Therefore, be careful with updating data in that external volume from the external subsystem side.
- Command View must be in **Modify** mode when you perform the Discovery operation; otherwise, the Discovery operation is not available.

## Precautions concerning Flex Copy pair volumes

When you start the Flex Copy pair operation and during Flex Copy processing, use certain precautions in handling Flex Copy volumes. If volumes are not handled properly, copy processing might fail (for example, it might be terminated abnormally or data might be copied incorrectly).

The following sections provide parallel sample configuration patterns to illustrate these precautions: first when starting Flex Copy operations, and then during Flex Copy processing.

## Starting Flex Copy operations

- Configuration pattern example 1

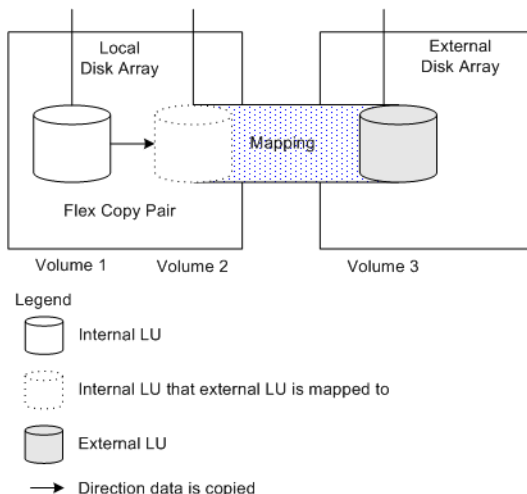

**Figure 363** Configuration pattern example 1

In a configuration like the one in [Figure 363](#), note the following precautions when starting Flex Copy operations:

- Volumes 1, 2, and 3 must be offline.
  - If Flex Copy V2 is not installed, Volume 1 must be offline and must not be a Business Copy P-VOL or S-VOL.
  - If Flex Copy V2 is installed, Volume 1 must be offline and must not be a Business Copy P-VOL. If Volume 1 is an S-VOL for Business Copy, it must be in PSUS status.
  - If Volume 1 is an S-VOL for Business Copy, Volume 1 must be in PSUS status.
  - For Volume 2, **S-VOL Disable** mode must not be set using the LUN Security XP Extension function.
  - Volume 3 must not be the Business Copy S-VOL.
  - Volume 3 must not be set to reject access using the LUN Security XP Extension function.
- Configuration pattern example 2

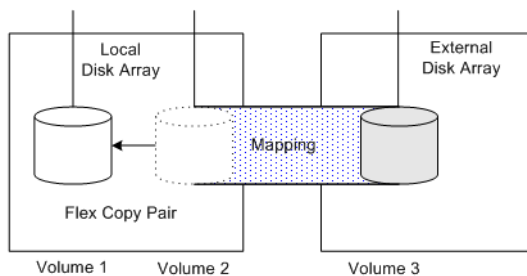

Legend: refer to the first figure in this section

**Figure 364** Configuration pattern example 2

In a configuration like the one in [Figure 364](#), note the following precautions when starting Flex Copy operations:

- Volumes 1, 2, and 3 must be offline.
- If Flex Copy V2 is not installed, Volume 1 must be offline and must not be a Business Copy P-VOL or S-VOL.

- If Flex Copy V2 is installed, Volume 1 must be offline and must not be a Business Copy P-VOL. If Volume 1 is a Business Copy S-VOL, it must be in PSUS status.
  - Volume 1 must not be either the Business Copy P-VOL or S-VOL.
  - For Volume 1, **S-VOL Disable** mode must not be set using the LUN Security XP Extension function.
  - Volume 3 must not be set to reject access using the LUN Security XP Extension function.
- Configuration pattern example 3

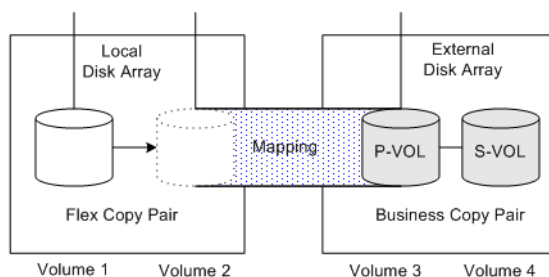

Legend: refer to the first figure in this section

**Figure 365** Configuration pattern example 3

In a configuration like the one in [Figure 365](#), note the following precautions when starting Flex Copy operations:

- Volumes 1, 2, and 3 must be offline.
  - Volume 1 must not be either the Business Copy P-VOL or S-VOL.
  - For Volume 2, **S-VOL Disable** mode must not be set using the LUN Security XP Extension feature.
  - Volume 3 must not be set to reject access using the LUN Security XP Extension function.
  - For Volumes 3 and 4, the status of the Business Copy pair must not be RCPY (a copy must not be in progress from S-VOL to P-VOL).
- Configuration pattern example 4

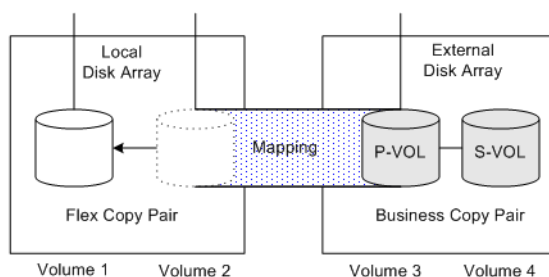

Legend: refer to the first figure in this section

**Figure 366** Configuration pattern example 4

In a configuration like the one in [Figure 366](#), note the following precautions when starting Flex Copy operations:

- Volumes 1, 2, and 3 must be offline.
- Do not perform a Business Copy operation specifying Volume 1 or 2 as the P-VOL or S-VOL for the Business Copy pair.
- If Volume 3 is specified as the S-VOL for a Business Copy pair, pair status must be SSUS.
- Volume 3 must not be set to reject access using the LUN Security XP Extension function.

## During flex copy processing

- Configuration pattern example 1

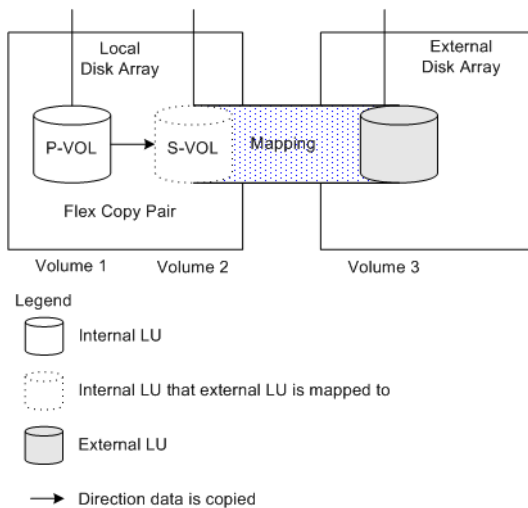

**Figure 367** Configuration pattern example 1 (during processing)

In a configuration like the one in [Figure 367](#), note the following precautions during Flex Copy processing:

- Volumes 1, 2, and 3 must be offline.
  - Do not perform a Business Copy operation specifying Volume 1 or 2 as the Business Copy P-VOL or S-VOL.
  - Do not perform a Business Copy operation specifying Volume 3 as the S-VOL for Business Copy.
  - Volume 3 must not be set to reject access using the LUN Security XP Extension function.
- Configuration pattern example 2

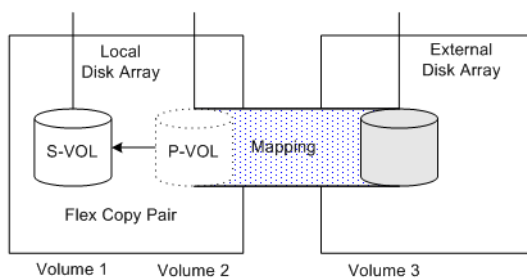

Legend: refer to the first figure in this section

**Figure 368** Configuration pattern example 2 (during processing)

In a configuration like the one in [Figure 368](#), note the following precautions during Flex Copy processing:

- Volumes 1, 2, and 3 must be offline.
- Do not perform a Business Copy operation specifying Volume 1 or 2 as the Business Copy P-VOL or S-VOL.
- Do not perform a Business Copy operation specifying Volume 3 as the S-VOL for Business Copy.
- Volume 3 must not be set to reject access using the LUN Security XP Extension function.

- Configuration pattern example 3

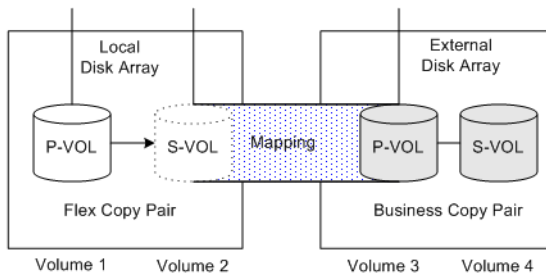

Legend: refer to the first figure in this section

**Figure 369** Configuration pattern example 3 (during processing)

In a configuration like the one in [Figure 369](#), note the following precautions during Flex Copy processing:

- Volumes 1, 2, and 3 must be offline.
  - Do not perform a Business Copy operation specifying Volume 1 or 2 as the Business Copy P-VOL or S-VOL.
  - For Volume 3, do not perform the **pairresync-restore** operation, which copies from the S-VOL to the P-VOL.
  - Volume 3 must not be set to reject access using the LUN Security XP Extension function.
- Configuration pattern example 4

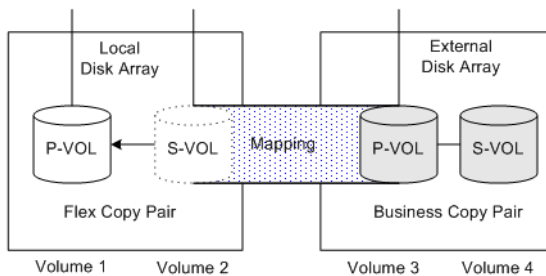

Legend: refer to the first figure in this section

**Figure 370** Configuration pattern example 4 (during processing)

In a configuration like the one in [Figure 370](#), note the following precautions during Flex Copy processing:

- Volumes 1, 2, and 3 must be offline.
- Do not perform a Business Copy operation specifying Volume 1 or 2 as the Business Copy P-VOL or S-VOL.
- For Volume 3, do not perform Business Copy **pairsplit** or **pairresync** operations.
- If Volume 3 is specified as the S-VOL in a Business Copy pair, pair status must be SSUS.
- Volume 3 must not be set to reject access using the LUN Security XP Extension function.

## Status of copy pairs

The Flex Copy pane displays the status of Flex Copy copy pairs (see "Pair List" on page 742). The following figure illustrates the relationships between pair status and both Flex Copy operations and RAID Manager XP operations.

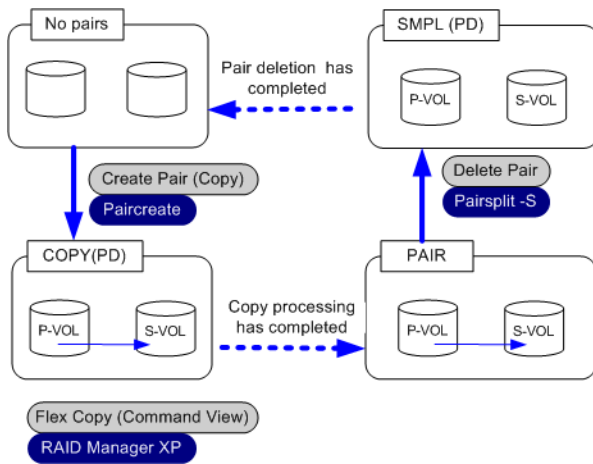

**Figure 371** Transitions of Flex Copy pair status

This figure shows the pair status transition for only the most common use of Flex Copy. Note the following additional information on pair status transitions:

- When you perform the Flex Copy Create Pair (No Copy) operation using Command View, pair status becomes PAIR (NOCOPY).
- When you perform operations on the copy pair using RAID Manager XP, additional pair status values may occur that do not appear in [Figure 371](#). This is because those operations correspond to Business Copy XP operations.
- If copy processing terminates abnormally due to a failure, pair status is set to PSUE.

[Figure 139](#) provides a detailed list of transitions of the Flex Copy pair status.

### Legend:

- A: pair status before pair operation
- B: pair status while processing



- C: pair status after pair operation

**Table 139** Transitions of Flex Copy pair status

Operation		No Pair	COPY (PD)	PAIR	PAIR (NOCOPY)	COPY (SP)	PSUS	COPY (RS)	COPY (RS-R)	PSUE	
Operations using Command View	CreatePair (Copy)	A	B	C							
	CreatePair (No Copy)	A	B		C						
	Delete Pair	B, C	A								
		B, C		A							
		B, C			A						
		B, C					A				
		B, C						A			
		B, C							A		
		B, C								A	
B, C										A	
Operations using RAID Manager	paircreate	A	B	C							
	paircreate-split	A					C				
		A				B	C				
	pairsplit		A				C				
			A			B	C				
				A		B	C				
					A	B	C				
	pairsplit-S	B, C	A								
		B, C		A							
		B, C			A						
		B, C					A				
		B, C						A			
		B, C							A		
		B, C								A	
B, C										A	

**Table 139** Transitions of Flex Copy pair status (continued)

Operation		No Pair	COPY (PD)	PAIR	PAIR (NOCOPY)	COPY (SP)	PSUS	COPY (RS)	COPY (RS-R)	PSUE
pairsplit-E			A							B,C
				A						B,C
					A					B,C
										B,C
						A				B,C
							A			B,C
								A		B,C
									A	B,C
pairresync				C				B		
				C			A	B		
				C				B		A
pairresync-restore			C			A		B		



**CAUTION:**

- If you use the **Create Pair** command, click **Apply**, and click **No Copy** in the Copy Type Setting window, copy processing will not execute and pair status will be PAIR (NOCOPY) for Flex Copy or PAIR for RAID Manager. Therefore, data in the P-VOL will not match data in the S-VOL. For information on the procedure for creating a copy pair, see [“Copying data from external LUs to local disk array LUs”](#) on page 747 and [“Copying data from local disk array LUs to external LUs”](#) on page 749.
- If you create a copy pair using the **Create Pair** command and the **No Copy** button (pair status changes to PAIR (NOCOPY) for Flex Copy or PAIR for RAID Manager XP), and then use RAID Manager XP to execute **Pairsplit** on the copy pair, copy processing will not execute and pair status will be PSUS. Therefore, data in the P-VOL will not match data in the S-VOL.

Table 140 describes the pair status displayed by RAID Manager XP.

**Table 140** Pair status displayed by RAID Manager XP

Flex Copy (Command View)	RAID Manager XP Status	
	P-VOL	S-VOL
No pairs	SMPL	SMPL
PAIR	PAIR	PAIR
PAIR (NOCOPY)	PAIR	PAIR

**Table 140** Pair status displayed by RAID Manager XP (continued)

Flex Copy (Command View)	RAID Manager XP Status	
	P-VOL	S-VOL
COPY (PD)	COPY	COPY
COPY (SP)	COPY	COPY
PSUS	PSUS	SSUS
PSUS (SP)	PSUS	COPY
COPY (RS)	COPY	COPY
COPY (RS-R)	RCPY	RCPY
PSUE	PSUE	PSUE

## Copy operations using Command View

After you map external LUs, you can set a copy pair from the Flex Copy pane and perform copy processing. For detailed information on using Flex Copy for copy operations, see ["Flex Copy operations panes"](#) on page 740.



**CAUTION:** You cannot cancel a copy pair if pair status is PSUS (SP). Wait until copy processing finishes or set pair status to PSUE from RAID Manager XP, and cancel the copy pair. For information on canceling a copy pair, see ["Canceling copy pairs \(Delete Pair\)"](#) on page 752.

## Copy operations using RAID Manager XP

Use the Business Copy XP commands in RAID Manager XP to manipulate and check the status of Flex Copy pairs. RAID Manager XP and Business Copy XP use the same method for writing configuration definition files and using commands.

For detailed information on general use of RAID Manager XP, see the *HP StorageWorks RAID Manager XP User's Guide*. For detailed information on configuration definition files and commands used for operating Flex Copy pairs and checking status of Flex Copy pairs, see the description on Business Copy XP (HOMRCF) in that guide.

The following sections provide:

- ["Requirements for Flex Copy and Business Copy XP operations from RAID Manager XP"](#) on page 726
- ["Preparing for RAID Manager XP operations"](#) on page 730
- ["Examples of RAID Manager XP commands"](#) on page 733
- ["Example of system backup operations"](#) on page 735

## Requirements for Flex Copy and Business Copy XP operations from RAID Manager XP

The following table describes requirements for Flex Copy and Business Copy XP operations. Notes on Flex Copy operations from RAID Manager XP appear following the table.

**Table 141** Requirements for Flex Copy and Business Copy XP operations

Installed Program Product		P-VOL			S-VOL			Program Product to Run
Flex Copy	Business Copy XP	Local Disk Array LU	External LU		Local Disk Array LU	External LU		
			IO Suppression Disable	IO Suppression Enable		IO Suppression Disable	IO Suppression Enable	
x	x	x			x			Business Copy XP
x	x	x				x		Business Copy XP
x	x	x					x	Flex Copy
x	x		x		x			Business Copy XP
x	x		x			x		Business Copy XP
x	x		x				x	-
x	x			x	x			Flex Copy
x	x			x		x		-
x	x			x			x	-
x		x			x			-
x		x				x		-
x		x					x	Flex Copy
x			x		x			-
x			x			x		-
x			x				x	-
x				x	x			Flex Copy
x				x		x		-
x				x			x	-
	x	x			x			Business Copy XP
	x	x				x		Business Copy XP

**Table 141** Requirements for Flex Copy and Business Copy XP operations (continued)

Installed Program Product		P-VOL			S-VOL			Program Product to Run
Flex Copy	Business Copy XP	Local Disk Array LU	External LU		Local Disk Array LU	External LU		
			IO Suppression Disable	IO Suppression Enable		IO Suppression Disable	IO Suppression Enable	
	x	x					x	-
	x		x		x			Business Copy XP
	x		x			x		Business Copy XP
	x		x				x	-
	x			x	x			-
	x			x		x		-
	x			x			x	-
		x			x			-
		x				x		-
		x					x	-
			x		x			-
			x			x		-
			x				x	-
				x	x			-
				x		x		-
				x			x	-

In the table, rows containing shaded cells indicate conditions for performing copy operations. An x in the P-VOL/S-VOL columns indicates the type of LU to be used. A hyphen in the last column indicates that neither Flex Copy nor Business Copy XP will run.

You can cancel copy pairs even if the program products are not installed.



Note the following limitations when using RAID Manager XP to perform Flex Copy operations:

- Flex Copy does not support the following command modes, options, and functions:
  - **-m** (noread) option of `paircreate` command
  - quick resync mode of `pairresync` command
  - quick restore mode of `pairresync -restore` command
  - At-Time Split function

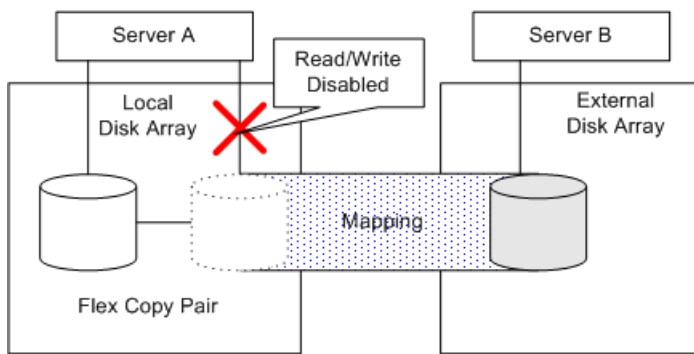
- Write operations cannot be performed on a P-VOL when the P-VOL status is PSUS and the S-VOL status is either COPY or SSUS. However, if the `pairdisplay` command is executed from RAID Manager XP, the “M” column displays “W” for the P-VOL (“W” means “read/write enabled”).
- If you execute the `raidscan` command for volumes that configure the Flex Copy pair, and if paths are not set for those volumes, the status of the P-VOL and S-VOL is displayed as SMPL. When you use RAID Manager XP for the Flex Copy pair operation, you must set the paths for the volumes.
- If the copy range capacity of P-VOL is greater than the capacity of the S-VOL, a caution message appears during the Command View operation, but no message appears during the RAID Manager XP operation. See “[Relationship between LU capacity and copy range](#)” on page 755 and carefully configure the Flex Copy copy pair.
- If you create a pair using an external LU mapped as an internal LU, the local disk array automatically decides whether to use Flex Copy or ShadowImage depending on attributes of the mapped LU. Since Flex Copy and Business Copy XP use different configurations to connect servers and disk arrays, be careful when defining attributes of the Flex Copy pair LUs.



#### Legend

-  Internal LU
-  Internal LU that external LU is mapped to
-  External LU

**Figure 372** Connection configuration using Flex Copy

Figure 372 illustrates the configuration of a Flex Copy pair. Server B is connected to the external disk array, and read and write I/O operations from Server B to the mapped external LU are available. However, read and write I/O operations from Server A (connected to the local disk array) to the

mapped external LU are not available, even though it is mapped as an internal volume of the local disk array.

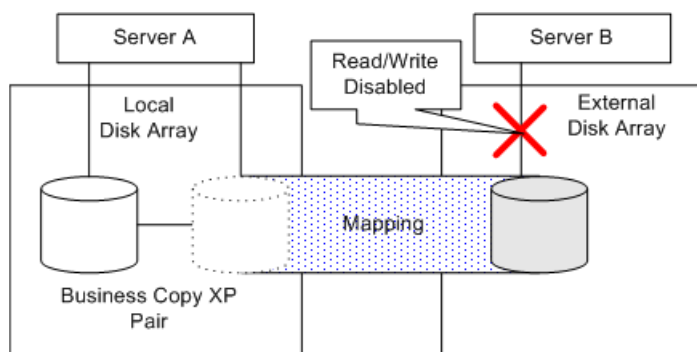

#### Legend



Internal LU



Internal LU that external LU is mapped to



External LU

**Figure 373** Connection configuration using Business Copy XP

Figure 373 illustrates the configuration with a Business Copy XP pair. Server A is connected to the local disk array, and read and write I/O operations from Server A to the external LU mapped as an internal LU are available. However, direct read and write I/O operations from Server B (connected to the external disk array) to the external LU are not available.

When you create the configuration definition file for RAID Manager XP, check the LU attributes and ensure that you can create the desired kind of copy pair (Flex Copy pair or Business Copy XP pair).

## Preparing for RAID Manager XP operations

This section describes the procedure required before you start operating the Flex Copy pair using RAID Manager XP commands, after you mapped an external LU as an internal LU.

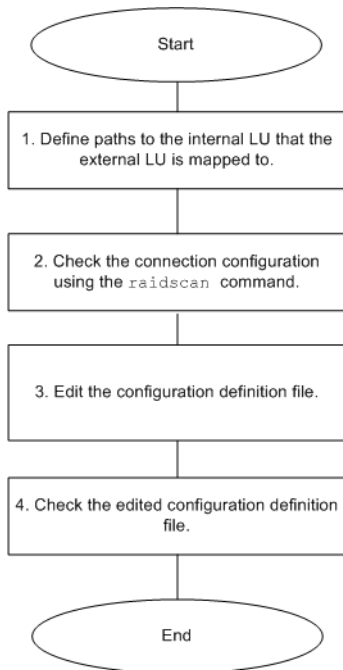

**Figure 374** Procedure required before performing Flex Copy operations using RAID Manager XP

**Figure 374** shows the steps of the procedure and **Figure 375** shows a sample configuration used in the procedure description following the figure.

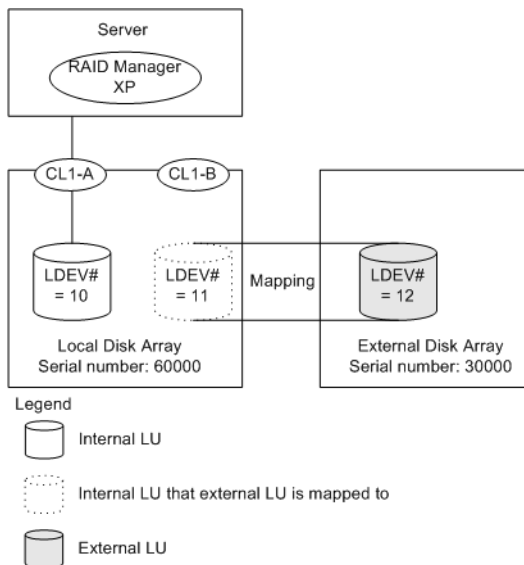

**Figure 375** Sample configuration using RAID Manager XP

The following procedure shows steps required to edit the configuration definition file. After you perform this procedure, you can create or delete Flex Copy pairs using the `paircreate` command or the `pairsplit-S` command.

1. Define paths to the internal LU to which the external LU is mapped.

The procedure to set the LU paths to the internal LU, where the external LU is mapped, is the same as the procedure for the current local disk array LU. For detailed information on the procedure for setting paths, see "[Alternate paths](#)" on page 758.





**NOTE:** The current release of Flex Copy does not support alternate paths for the MSA1000 external disk array. Therefore you do not need to set an alternate path to the MSA1000 external LU.

As shown in [Figure 375](#), LDEV# = 11 is set to CL1-B.

**2.** Check the connection configuration using the `raidscan` command.

- Create the configuration definition file without `HORCM_DEV` and `HORCM_INST` as follows:

`horcm0.conf`

```
HORCM_MON
#ip_address      service      poll(10ms)    timeout(10ms)
127.0.0.1        52050        1000           3000

HORCM_CMD
#dev_name        dev_name      dev_name
/dev/rdisk/c1t2d3
```

- Start RAID Manager XP and check that the connection configuration is as follows:

```
# horcmstart.sh 0
starting HORCM inst 0
HORCM inst 0 starts successfully.
# HORCMINST=0
# export HORCMINST
# HORCC_MRCF=1
# export HORCC_MRCF
# raidscan -p CL1-A -CLI
PORT# /ALPA/C TID# LU# Seq# Num LDEV# P/S Status P-Seq# P-LDEV#
CL1-A b2 2 0 0 0 60000 1 10 SMPL - - -
CL1-A b2 2 0 0 1 60000 1 10 SMPL - - -
CL1-A b2 2 0 0 2 60000 1 10 SMPL - - -

# raidscan -p CL1-B -CLI -fe
PORT# /ALPA/C TID# LU# Seq# Num LDEV# P/S Status E-Seq# E-LDEV#
CL1-B b2 2 0 0 0 60000 1 11 SMPL - 30000 12
CL1-B b2 2 0 0 1 60000 1 11 SMPL - 30000 12
CL1-B b2 2 0 0 2 60000 1 11 SMPL - 30000 12

# horcmshutdown.sh 0
inst 0:
HORCM Shutdown inst 0 !!!
```

**3.** Edit the configuration definition file.

Edit the configuration definition file using `TID#` and `LU#`, which are obtained by executing the `raidscan` command, as follows:

horcm0.conf

```
HORCM_MON
#ip_address      service      poll(10ms)    timeout(10ms)
127.0.0.1        52050        1000          3000

HORCM_CMD
#dev_name        dev_name      dev_name
/dev/rdisk/c1t2d3

HORCM_DEV
#dev_group       dev_name      port#         TargetID      LU#          MU#
hicp             hicpdev1     CL1-A        0             0           0

HORCM_INST
#dev_group       ip_address    service
hicp             127.0.0.1    52051
```

horcm1.conf

```
HORCM_MON
#ip_address      service      poll(10ms)    timeout(10ms)
127.0.0.1        52051        1000          3000

HORCM_CMD
#dev_name        dev_name      dev_name
/dev/rdisk/c1t2d3

HORCM_DEV
#dev_group       dev_name      port#         TargetID      LU#          MU#
hicp             hicpdev1     CL1-B        0             0           0

HORCM_INST
#dev_group       ip_address    service
hicp             127.0.0.1    52050
```

4. Check the edited configuration definition file as follows:

```
# horcmstart.sh 0 1
starting HORCM inst 0
HORCM inst 0 starts successfully.
starting HORCM inst 1
HORCM inst 1 starts successfully.

# HORCMINST=0
# export HORCMINST
# HORCC_MRCF=1
# export HORCC_MRCF
# pairdisplay -g hicp
# pairdisplay -g hicp
Group   PairVol(L/R) (Port#,TID, LU-M) ,Seq#,LDEV#.P/S,Status, Seq#,P-LDEV# M
hicp    hicpdev1(L) (CL1-A , 0, 1-0 ) 60000 10.SMPL ----,----- -----
hicp    hicpdev1(R) (CL1-B , 0, 2-0 ) 60000 11.SMPL ----,----- -----
```

5. Restart the RAID Manager instance(s).

Note that this step is necessary only if you are modifying RAID Manager configuration files while the instances are running. Your changes will not take effect until you restart the RAID Manager instances.

### Examples of RAID Manager XP commands

The following table shows examples of RAID Manager XP commands that can be used to operate and check the status of Flex Copy pairs

**Table 142** Examples of RAID Manager XP command

RAID Manager XP Command	Operation
paircreate  (see <a href="#">Figure 371</a> for the relationship between the command and the pair status)	Creates Flex Copy pairs.  Executes copy processing from P-VOL to S-VOL.  You can specify the copy pace using the <code>-c &lt;size&gt;</code> option. Possible values: <b>1 or 2: Slower</b> ; <b>3: Medium</b> ; <b>4 - 15: Faster</b>  If you specify Slower, Flex Copy's impact on host I/O decreases because of the slow pace of copy processing. If you specify Faster, copy processing completes more quickly. If you omit this option, Medium pace is used.

**Table 142** Examples of RAID Manager XP command (continued)

RAID Manager XP Command	Operation
<p>pairsplit</p> <p>(see <a href="#">Figure 371</a> for the relationship between the command and the pair status)</p>	<p>When you do not specify the -S or -E options, the status of the P-VOL changes to PSUS and the status of the S-VOL changes to SSUS. If you execute the <code>pairsplit</code> command on the pair when the status of the P-VOL and S-VOL is COPY, the status changes after copy processing is complete. If you execute the <code>pairsplit</code> command on the pair when the status of the P-VOL and S-VOL is PAIR, the status changes immediately.</p> <p>When you specify the <code>-S</code> option parameter, copy processing is not executed and the Flex Copy pair is canceled. The status for the P-VOL and S-VOL changes to SMPL.</p> <p>When you specify the <code>-E</code> option parameter, copy processing is not executed and the status for the P-VOL and S-VOL changes to PSUE.</p> <p>You can specify the copy pace using the <code>-C &lt;size&gt;</code> option. Possible values: <b>1 or 2: Slower; 3: Medium; 4 - 15: Faster</b></p> <p>If you specify Slower, Flex Copy's impact on host I/O decreases because of the slow pace of copy processing. If you specify Faster, copy processing completes more quickly. If you omit this option, Medium pace is used.</p>
<p>raidscan (see <a href="#">Figure 371</a> for the relationship between the command and the pair status)</p>	<ul style="list-style-type: none"> <li>• When you do not specify any option parameters, copy processing from the P-VOL to the S-VOL is executed. After copy processing is complete, the status for the P-VOL and S-VOL changes to PAIR.</li> <li>• When you specify the <code>raidscan</code> option parameter, copy processing from the S-VOL to P-VOL is executed. After copy processing is complete, the status for the P-VOL and S-VOL changes to PAIR.</li> <li>• You can specify the copy pace using the <code>-c &lt;size&gt;</code> option. Possible values: <b>1 or 2: Slower; 3: Medium; 4 - 15: Faster</b></li> </ul> <p>If you specify Slower, Flex Copy's impact on the host I/O decreases because of the slow pace of copy processing. If you specify Faster, copy processing completes more quickly. If you omit this option, Medium pace is used.</p>
<p>pairevwait</p>	<p>Waits for completion of pair processing and checks the status.</p>
<p>pairmon</p>	<p>Obtains pair status transition of each pair and errors.</p>
<p>pairvolchk</p>	<p>Acquires volume attribute.</p>
<p>raidscan</p>	<p>Checks connection configuration of the local disk array and external subsystem.</p>

## Example of system backup operations

Figure 376 shows an example of the data backup system operation using Flex Copy. In the figure, data in the MSA1000 disk array (the external array) in the branch office is backed up to the local disk array installed in the head office.

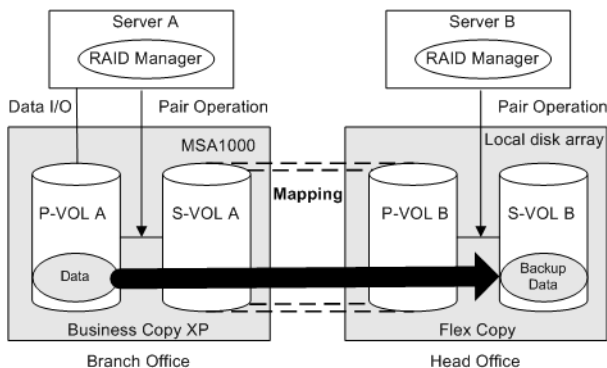

**Figure 376** Backing up data from a Branch Office to the Head Office

You can perform an online backup system operation using XP Flex Copy with MSA1000 Business Copy XP. You can also use a concentrating backup system configuration by connecting several MSA1000 disk arrays to one local disk array.

The following procedure outlines the backup system described in the previous figure. The operations in the procedure can be executed using RAID Manager XP commands. Furthermore, the operations can be automated. Sample configuration definition files and script files appear after the procedure.

1. < MSA1000 Business Copy XP pair operation >  
Execute the `pairresync` command to resynchronize the MSA1000 pair.
2. < MSA1000 Business Copy XP pair operation >  
Execute the `pairsplit` command to obtain an unaffected copy of the latest data in the S-VOL of the MSA1000 disk array.
3. < local disk array Flex Copy pair operation >  
Execute the `paircreate` command to obtain backup data in the S-VOL of the local disk array.
4. < local disk array Flex Copy pair operation >  
When the backup data operation is completed, cancel the Flex Copy pair.

The following are examples of the configuration definition files required for the RAID Manager XP operation to set up the backup system described in Figure 376:

- **Examples for the Branch Office**

The following are examples of the definition files that should be prepared in Server A. First check the connection configuration using the `raidscan` command. Then create the configuration definition files to operate the Business Copy XP pair, which consists of P-VOL A and S-VOL A.

- Check the connection configuration from Server A

```
# raidscan -p cl1-a -CLI
PORT# /ALPA/C TID# LU# Seq# Num LDEV# P/S Status Fence P-Seq# P-LDEV#
CL1-A e8 0 1 1 62468 1 256 PVOL PSUS - - -

# raidscan -p cl1-b -CLI
PORT# /ALPA/C TID# LU# Seq# Num LDEV# P/S Status Fence P-Seq# P-LDEV#
CL1-B e4 0 2 1 62468 1 257 SVOL SSUS - - -
```

- Configuration definition file for P-VOL A:

```
HORCM_MON
#ip_address      service      poll(10ms)    timeout(10ms)
127.0.0.1       52050       1000          3000

HORCM_CMD
#dev_name        dev_name     dev_name
/dev/rdisk/clt0d2

HORCM_DEV
#dev_group       dev_name     port#         TargetID      LU#          MU#
si-pairs        dev1        CL1-A         1             1            0

HORCM_INST
#dev_group       ip_address   service
si-pairs        127.0.0.1  52051
```

- Configuration definition file for S-VOL A:

```
HORCM_MON
#ip_address      service      poll(10ms)    timeout(10ms)
127.0.0.1       52051       1000          3000

HORCM_CMD
#dev_name        dev_name     dev_name
/dev/rdisk/clt0d2

HORCM_DEV
#dev_group       dev_name     port#         TargetID      LU#          MU#
si-pairs        dev1        CL1-B         2             1            0

HORCM_INST
#dev_group       ip_address   service
si-pairs        127.0.0.1  52050
```

- **Examples for the Head Office**

The following are examples of the configuration definition files that should be prepared in Server B. First check the connection configuration using the `raidscan` command. However, because P-VOL B is an internal LU mapped by an external LU, add the `-fe` option to the `raidscan` command to display that the volume is actually in the local disk array. After checking the connection configuration, create the configuration definition files to operate the Flex Copy pair, which consists of P-VOL B and S-VOL B.

- Check the connection configuration from Server B:

```
# raidscan -p cl1-c -fe -CLI
PORT# /ALPA/C TID# LU# Seq# Num LDEV# P/S Status Fence E-Seq# E-LDEV#
CL1-C e4 0 3 1 30053 1 16 SMPL - - 62468 257

# raidscan -p cl1-d -CLI
PORT# /ALPA/C TID# LU# Seq# Num LDEV# P/S Status Fence P-Seq# P-LDEV#
CL1-D e2 0 4 1 30053 1 17 SMPL - - - -
```

- Configuration definition file for P-VOL B:

```
HORCM_MON
#ip_address      service      poll(10ms)    timeout(10ms)
127.0.0.1        52050       1000          3000

HORCM_CMD
#dev_name        dev_name     dev_name
/dev/rdsk/c1t0d2

HORCM_DEV
#dev_group       dev_name     port#         TargetID      LU#          MU#
h1cp-pairs       dev1         CL1-C         3             1            0

HORCM_INST
#dev_group       ip_address   service
h1cp-pairs       127.0.0.1   52051
```

- Configuration definition file for S-VOL B:

```

HORCM_MON
#ip_address      service      poll(10ms)    timeout(10ms)
127.0.0.1       52051       1000          3000

HORCM_CMD
#dev_name        dev_name      dev_name
/dev/rdsk/c1t0d2

HORCM_DEV
#dev_group      dev_name      port#          TargetID       LU#           MU#
hicp-pairs      dev1          CL1-D          4              1             0

HORCM_INST
#dev_group      ip_address    service
hicp-pairs      127.0.0.1    52050

```

- **Examples of script files**

You must execute script file A on the Server A first. After script file A completes normally, you must execute script file B on Server B.

- Script file A:

```

#
# Resync the Business Copy pair
#
pairresync -g si-pairs
pairevtwait -g si-pairs -s pair -t 1000

#
# Split the Business Copy pair
#
pairsplit -g si-pairs

```

- Script file B:

```

#
# Create the Flex Copy pair
#
paircreate -g hicp-pairs -vl
pairevtwait -g hicp-pairs -s pair -t 1000

#
# Delete the Flex Copy pair
#
pairsplit -S -g hicp-pairs

```



For more detailed information on the procedure and the configuration definition files, contact your HP account support representative.

---

## Preparing for Flex Copy operations

This section describes the requirements and limitations for Flex Copy operations. Topics include:

- ["Configuring external disk arrays"](#) on page 739
- ["Installing Flex Copy"](#) on page 739
- ["Uninstalling Flex Copy"](#) on page 739
- ["Preparing Flex Copy settings"](#) on page 739

## Configuring external disk arrays

For information on configuring external disk arrays, see ["Configuring MSA1000/1500 as external disk arrays"](#) on page 769.



**NOTE:** The current release of Flex Copy does not support alternate paths for the MSA1000 external disk array. Therefore, you do not need to set an alternate path to the MSA1000 external LU when you configure it as an external disk array.

---

## Installing Flex Copy

To perform Flex Copy operations with Command View, you must install a Flex Copy license key. For further information, see ["Managing license keys"](#) on page 75.

## Uninstalling Flex Copy

To uninstall Flex Copy, you must cancel all Flex Copy copy pairs and delete external LU mapping, as described in the following procedure.

1. Log in to Command View.

For detailed information about the logon procedure, see ["Starting Command View from a browser"](#) on page 42.

2. Click the link for the disk array. The disk array Identity pane appears.

3. Click **Flex Copy**.

4. Cancel the Flex Copy copy pairs.

For instructions on canceling Flex Copy copy pairs, see ["Canceling copy pairs \(Delete Pair\)"](#) on page 752.

5. Delete external LU mapping.

For instructions, see ["Deleting external LU mappings \(Delete LU\)"](#) on page 813.

6. Uninstall the Flex Copy license. For further information, see ["Uninstalling a license key"](#) on page 79.

## Preparing Flex Copy settings

Before using Flex Copy, you must prepare information necessary for its settings. This information is identical to that described in the External Storage XP chapter.

You must define the following:

- Ports that can be set to external ports (see [“External port attributes”](#) on page 773)
- External disk array and its LUs to be mapped to the internal LUs (see [“Mapping external LU information”](#) on page 773)
- External LU groups (see [“Using external LU groups”](#) on page 773)
- External volume attributes (see [“External LU attributes set by mapping”](#) on page 773)

---

## Flex Copy operations panes

To use Flex Copy, you work with the **LU Operation**, **Port Operation**, and **Flex Copy** tabs in the External Storage XP operations panes. Selecting any of these tabs displays its corresponding pane.

Topics in this section include:

- [“Starting Flex Copy operations”](#) on page 740
- [“LU Operation pane”](#) on page 740
- [“Port Operation pane”](#) on page 740
- [“Flex Copy pane”](#) on page 741



**NOTE:** Many Flex Copy operations are identical to those for External Storage XP.

---

## Starting Flex Copy operations

1. Log in to Command View. For detailed information about the logon procedure, see [“Starting Command View from a browser”](#) on page 42.
2. In the Device Launcher, select an XP12000 disk array. The disk array Identity pane appears.
3. Change to Modify mode (for details, see [“Identity pane buttons and icons”](#) on page 98).
4. Click the **External Storage/Flex Copy** button (  ) in the left-hand pane.

The LU Operation pane appears.

## LU Operation pane

For a description of this pane, see [“LU Operation pane”](#) on page 777.

## Port Operation pane

For a description of this pane, see [“Port Operation pane”](#) on page 784.

---

## Setting external LUs

Copy operations using Flex Copy consist of the following steps:

1. Set an external LU

Before performing copy operations between a local disk array LU and an external LU, enable the connection to the external LU. This may involve setting the external port for Flex Copy operation or mapping external LUs as internal LUs, for example.

For a description of how to set an external LU, see “[Configuring external LUs](#)” on page 788.



**NOTE:** The current release of Flex Copy does not support alternate paths for the MSA1000 external disk array. Therefore, you do not need to set an alternate path to the MSA1000 external LU.

## 2. Perform the copy operation

The next section (“[Copying data](#)” on page 741) describes how to copy data in both directions between a local disk array and an external LU.

# Copying data

After mapping an external LU as an internal LU, you can copy data in both directions between the external LU and local disk array. This section describes the panes and procedures for the copy operation.

Topics in this chapter include:

- “[Flex Copy pane](#)” on page 741
- “[Panels for setting copy pairs](#)” on page 745
- “[Copying data from external LUs to local disk array LUs](#)” on page 747
- “[Copying data from local disk array LUs to external LUs](#)” on page 749
- “[Displaying history of Flex Copy operations](#)” on page 750
- “[Canceling copy pairs \(Delete Pair\)](#)” on page 752

## Flex Copy pane

The Flex Copy pane displays the status of copy operations using the external LU mapped by Flex Copy. You can start copy operations by using the internal LU and external LU from this tab.

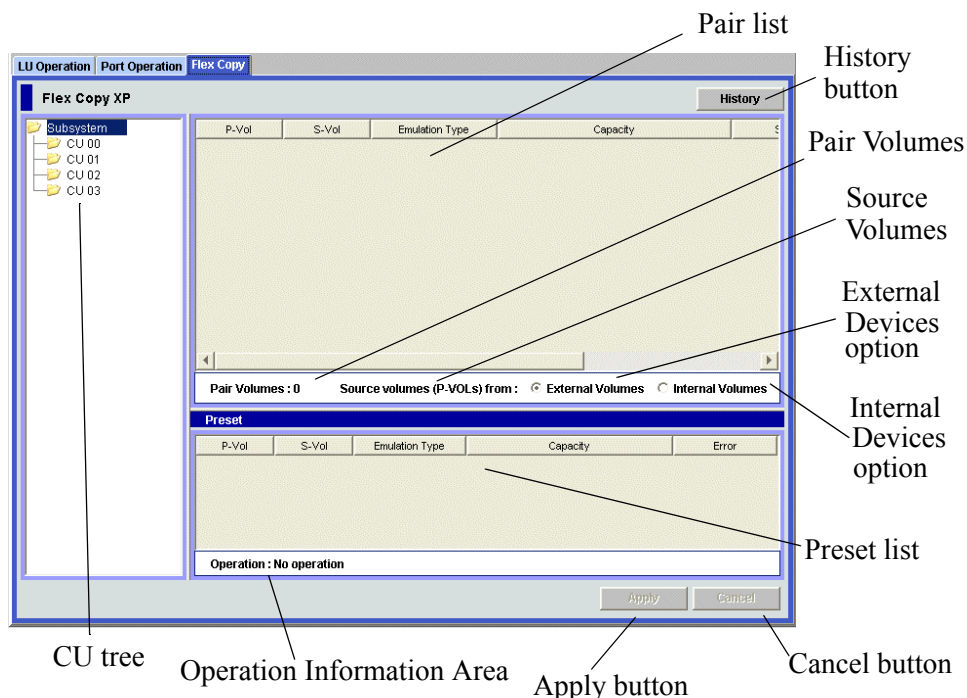

**Figure 377** Flex Copy pane

The Flex Copy pane consists of the following items:

- **CU Tree**

CU numbers appear in the CU tree. When you select a CU number, information on the LU of the selected CU appears in the Pair List.

- **History** button

Displays the History panel showing the history of Flex Copy operations. For detailed information, see ["Displaying history of Flex Copy operations"](#) on page 750.

- **Pair List**

Displays information on the P-VOLs and S-VOLs that can be used for copy operations. After you set the copy pair, information on the specified copy pair is also displayed. For detailed information, see ["Pair List"](#) on page 742.

- **Pair Volumes**

Displays the number of copy pairs currently set.

- **Source volumes (P-VOLs) from:**

You can select the copy source volume from the following options:

- **External Volumes:** Copy data by setting the external LU as the source (P-VOL) and the internal LU as the target (S-VOL)
- **Internal Volumes:** Copy data by setting the internal LU as the source (P-VOL) and the external LU as the target (S-VOL)

- **Preset** list

Displays contents of settings set by the operation started from the Pair List. Contents displayed in the **Preset** list have not yet been applied to the local disk array. They are applied when you click **Apply**. For detailed information, see ["Preset List \(Flex Copy pane\)"](#) on page 744.

- **Operation Information Area**

Displays operation information on the settings displayed in the **Preset** list, including the following:

- **Operation:** Name of setting operation
- **Number of Objects in Preset:** Number of settings displayed in the **Preset** list

- **Apply** button

Applies settings displayed in the **Preset** list to the local disk array. When settings are applied normally, they are removed from the **Preset** list. If errors occur, settings are not applied, error messages appear, and incorrect settings remain in the **Preset** list.

- **Cancel** button

Cancels all settings in the **Preset** list.

`Pair_List`

## Pair List

Displays information on volumes available for the copy operation and copy pairs. You can sort the list by displayed items. For instance, to sort the list in the order of the CU:LDEV numbers in the P-VOL column, click **P-Vol** in the list header.

When the setting operation has been executed (but not yet applied to the disk array), contents of the setting appear in the **Preset** list, and the row of that copy pair in the Pair List appears in blue and italics.

P-Vol	S-Vol	Emulation Type	Capacity	Status	Progress	Copy Pace
00.00	-	OPEN-V	56MB	-	-	-
00.02	-	OPEN-V* 6	18776MB	-	-	-
00.09	-	OPEN-V	9390MB	-	-	-
<i>00.0B</i>	<i>00.0B #</i>	<i>OPEN-V</i>	<i>9390MB</i>	-	-	-
<i>00.0D</i>	<i>00.0C #</i>	<i>OPEN-V</i>	<i>9390MB</i>	-	-	-
00.0F	-	OPEN-V	9390MB	-	-	-
00.11	-	OPEN-V	56MB	-	-	-
00.13	-	OPEN-V	56MB	-	-	-
00.15	-	OPEN-V	56MB	-	-	-
00.17	-	OPEN-V	56MB	-	-	-
00.19	-	OPEN-V	80MB	-	-	-
00.1B	-	OPEN-V	56MB	-	-	-

**Figure 378** Sample Pair List

The following items appear in the Pair List:

- **P-Vol**

CU:LDEV number of the source volume of the copy pair. For the external LU, the CU:LDEV number of the mapped internal LU appears, and “#” is added to the end of the number.

- **S-Vol**

CU:LDEV number of the target volume of the copy pair. For the external LU, the CU:LDEV number of the mapped internal LU appears, and “#” is added to the end of the number.

- **Emulation Type**

Emulation type of the LU.

- **Capacity**

Capacity of the external LU. When an Open System emulation type is used for mapped external LUs, capacity is displayed in blocks.

- **Status**

Status of the copy pair. This column displays status values for copy pairs managed from the Flex Copy pane and RAID Manager XP. A “-” appears in this column for volumes that are not specified for the copy pair, and for copy pairs that do not have any other status values. To display the latest status during the copy operation, click Refresh (  ) in the Command View main window.

When you manage the copy pair from the Flex Copy pane, the following status values may appear:

- **COPY (PD)**: Copy processing of all the data in the P-VOL to the S-VOL is in progress (COPY Pending).
- **PAIR**: Copy processing is complete.
- **PAIR (NOCOPY)**: Copy pair is set by Flex Copy, but copy processing has not been executed yet. To start copy processing, operate the copy pair using RAID Manager XP.
- **SMPL (PD)**: Deletion of the copy pair is in progress. **SMPL (PD)** status indicates the status is changing from Pair to no pairs.

When you manage the copy pair using RAID Manager XP, the following status values may also appear:

- **COPY (SP)**: Copy processing of all data in the P-VOL to the S-VOL is in progress. This status value appears when you execute the RAID Manager XP `paircreate -split` command (Steady SPLIT) or `pairsplit` command (Steady SPLIT).

- **PSUS (SP)**: Copy processing of all data in the P-VOL to the S-VOL is in progress. This status value appears when you execute the RAID Manager XP `paircreate -split` command (Quick SPLIT) or `pairsplit` command (Quick SPLIT).
  - **COPY (RS)**: Copy processing of all data in the P-VOL to the S-VOL is in progress. This status value appears when you execute the RAID Manager XP `pairresync` command.
  - **COPY (RS-R)**: Copy processing of all data in the S-VOL to the P-VOL is in progress. This status value appears when you execute the RAID Manager XP `pairresync` command.
  - **PSUE**: The P-VOL and S-VOL do not match. Copy processing is terminated because the RAID Manager XP `pairsplit -E` command was executed, or an error that terminated the copy processing occurred.
  - **PSUS**: Copy processing is complete.
- **Progress**  
Displays copy processing progress as a percentage. To display the most recent status during the copy operation, click Refresh () in the Command View main window.
  - **Copy Pace**  
Displays the copy pace specified when the copy pair was set. Possible values: **Medium**, **Slow**, or **Faster**.

If you select one or more rows in the Pair List and right-click, the **Create Pair** (see “Copying data from local disk array LUs to external LUs” on page 749) and **Delete Pair** (see “Canceling copy pairs (Delete Pair)” on page 752) commands appear in the pop-up menu.

## Preset List (Flex Copy pane)

This list displays settings of the operations that were performed from the Pair List, but have not yet been applied to the disk array. Before applying these settings to the local disk array, verify their contents in the **Preset** list. The contents displayed in the **Preset** list appear in blue and italics in the Pair List. If you click **Apply** in the Flex Copy pane, the contents displayed in the **Preset** list are applied to the local disk array. When settings are applied, the contents of the **Preset** list disappear, and the Pair List appears normally. If you click **Cancel** in the Flex Copy pane, all settings in the **Preset** list are cancelled.

If settings in the **Preset** list contain errors, they are not applied to the local disk array even if you click **Apply** in the Flex Copy pane. In that case, error messages appear, incorrect settings remain in the **Preset** list, and error codes appear in the **Preset** list.

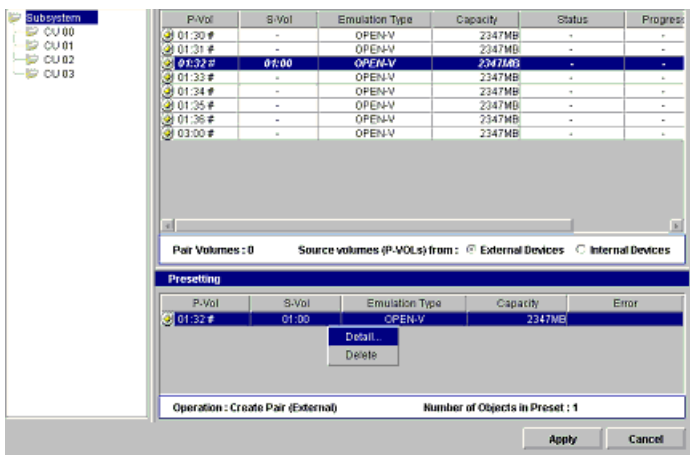

**Figure 379** Preset Status of Flex Copy pane

If you select a setting in the **Preset** list and right-click, the **Detail** and **Delete** commands appear in a pop-up menu (see [Figure 379](#)). You can perform the following operations using those commands:

- **Detail** command

Displays the Preset Detail pane (see [Figure 380](#)) providing detailed information about settings selected in the **Preset** list. If error codes appear in the **Preset** list, the Preset Detail pane displays error messages corresponding to the Flex Copy.

- **Modify** command

Displays the Pair Volume Setting pane. This command is available only when the creating pair operation is in the preset status. You can change the preset value of the copy pair from that pane. The procedures for setting a copy pair are described in ["Copying data from external LUs to local disk array LUs"](#) on page 747 and ["Copying data from local disk array LUs to external LUs"](#) on page 749.

- **Delete** command

Cancels settings selected in the **Preset** list.

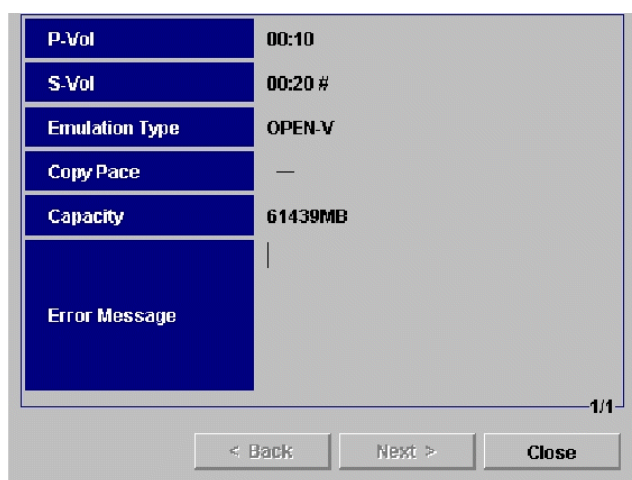

**Figure 380** Sample Preset Detail pane (Copy Pair is Set)

## Panes for setting copy pairs

Use the Pair Volume Setting and Copy Type Setting panes to set the copy pair, which consists of an LU of a local disk array and an external LU.

This section describes:

- ["Pair Volume Setting pane"](#) on page 746
- ["Copy Type Setting pane"](#) on page 747

For detailed information about setting a copy pair, see ["Copying data from external LUs to local disk array LUs"](#) on page 747 and ["Copying data from local disk array LUs to external LUs"](#) on page 749.



## Pair Volume Setting pane

To set a copy pair consisting of a local disk array LU and an external LU, use the Pair Volume Setting pane. To display the Pair Volume Setting pane, in the Flex Copy pane select the P-VOL from the Pair List, right click, and select **Create Pair**.

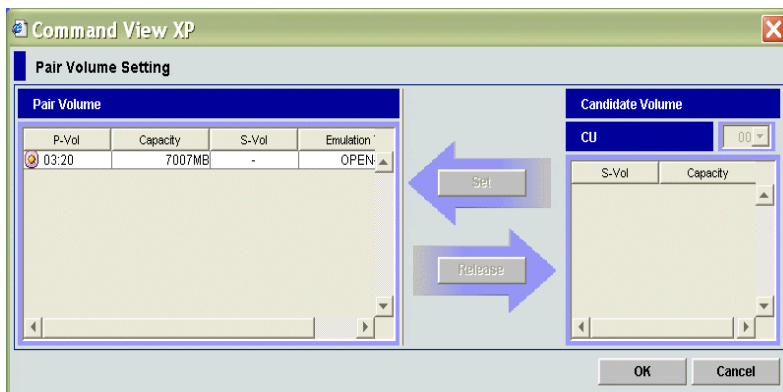

**Figure 381** Pair Volume Setting pane

The Pair Volume Setting pane consists of the following items:

- **Pair Volume** list (left of the pane)

Displays CU:LDEV numbers, capacities, and emulation types of the P-VOLs and S-VOLs. Before the copy pair is set, this list displays only the information of the P-VOL selected in the Pair List in the Flex Copy pane. The S-VOL number is added to the **Pair Volume** list when the copy pair is set.

For the external LU, the CU:LDEV number of the mapped internal LU appears, and “#” is added to the end of the number.

- **Candidate Volume** list (right of the pane)

Displays CU:LDEV numbers and capacities of LUs that can be set as S-VOLs. Only the volumes that have the same emulation type as the P-VOL are displayed. To display the LU you want to specify as the S-VOL in the **Candidate Volume** list, select the CU number in the **CU** list box.

For the external LU, the CU:LDEV number of the mapped internal LU appears, and “#” is added to the end of the number.

- **CU** list box

Used to select the CU number for the LU you want to specify as the S-VOL. The number of CUs that appear in the list depends on the number of CUs that are set. Up to 32 CUs can be displayed.

- **Set** button

Sets a copy pair. Select an LU to be the P-VOL from the **Pair Volume** list, select an LU to be the S-VOL from the **Candidate Volume** list, and click **Set**. The S-VOL selected is added to the S-VOL column in the **Pair Volume** list, and the row appears in blue and italics, indicating that the copy pair is set. For detailed information about setting a copy pair, see [“Copying data from local disk array LUs to external LUs”](#) on page 749 and [“Canceling copy pairs \(Delete Pair\)”](#) on page 752.

- **Release** button

Cancels the copy pair setting. The button becomes available after the copy pair is set in the **Pair Volume** list. If you select the copy pair in the **Pair Volume** list and click **Release**, the selected copy pair is released. The LU that was displayed in the S-VOL column is deleted from the **Pair Volume** list, and reappears in the **Candidate Volume** list.



- **OK** button

Closes the Pair Volume Setting pane and returns to the Flex Copy pane. Settings specified in the Pair Volume Setting pane appear in the Flex Copy pane.

- **Cancel** button

Cancels settings specified in the Pair Volume Setting pane and returns to the Flex Copy pane.

## Copy Type Setting pane

The Copy Type Setting pane appears when you set the copy pair on the Pair Volume Setting pane, and click **Apply** in the Flex Copy pane. Use the Copy Type Setting pane to set the copy type and copy pace.

Only one Copy Type Setting pane appears when you click **Apply**, even if multiple copy pair settings are defined in the **Preset** list (for further information, see “[Preset List \(Flex Copy pane\)](#)” on page 744). The settings defined in the Copy Type Setting pane are applied to all copy pairs selected in the **Preset** list. To make the setting different for each copy pair, apply the setting each time you set a copy pair and complete the copy pair setting operation.

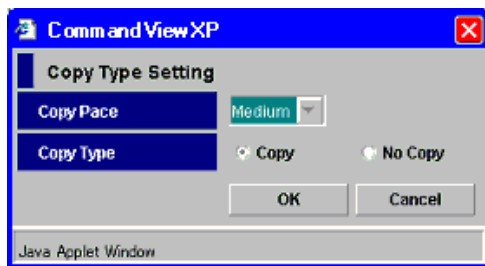

**Figure 382** Copy Type Setting pane

The Copy Type Setting pane consists of the following items:

- **Copy Pace**

Select the copy pace from the list: **Medium**, **Slow**, or **Faster**. If you select **Slow**, you minimize the impact of Flex Copy operations on I/O performance. If you select **Faster**, copy processing finishes more quickly.

- **Copy Type**

Select the following copy types for the copy pair:

- **Copy**: Copy processing for the copy pair starts as soon as you click **OK** in the Copy Type Setting pane.
- **No Copy**: Copy processing for the copy pair does not start when you click **OK** in the Copy Type Setting pane. The setting of the copy pair becomes available. To start copy processing, use RAID Manager XP to operate the copy pair.

## Copying data from external LUs to local disk array LUs

Before starting the copy operation, map the external LU to be copied as an internal LU. The procedure for setting the external LU is described on “[Setting external LUs](#)” on page 740.



### NOTE:

- While copy processing is in progress, do not perform Read/Write operations on the LU set as the P-VOL of the copy pair

- If you must perform Read/Write operations on the LU set as the S-VOL after you set the copy pair, cancel the copy pair.

1. In the External Storage XP operations pane, select **Flex Copy**. The Flex Copy pane appears.
2. Select the **External Volumes** option (lower right in the Pair List).
3. Select the CU number of the external LU to be the P-VOL (source volume) in the CU tree.

The LU of the selected CU appears in the P-VOL column of the Pair List, and “#” appears next to the internal LU number where the external LU is mapped.

4. In the P-VOL column of the Pair List, select one or more external LUs that are not set as part of a copy pair, right-click, and select **Create Pair**. The Pair Volume Setting pane appears.

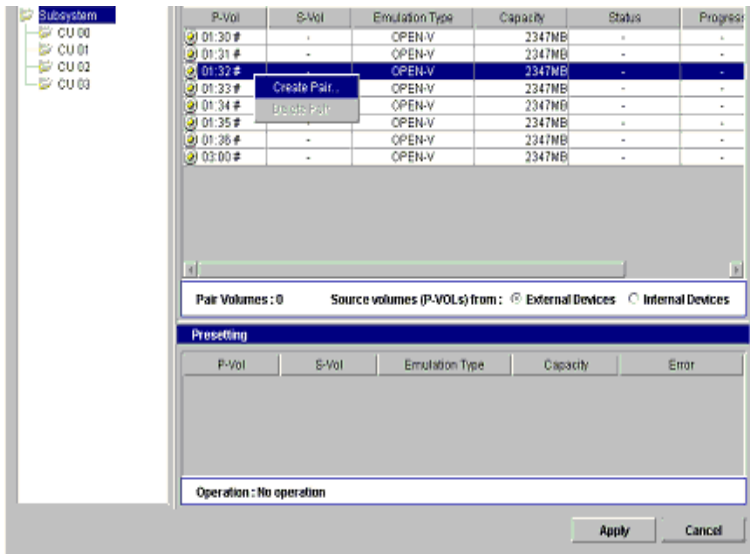

**Figure 383** Flex Copy pane (Create Pair command)



**NOTE:** In the Pair List, you can select several external disk array LUs. The ones you select appear in the **Pair Volume** list on the Pair Volume Setting pane.

5. In the **Pair Volume** list, select the external LU(s) to be copied to the local disk array LU. You can select several external LUs.
6. In **Candidate Volume** list on the right, select the local disk array LU you want to set as the target volume (S-VOL).

The capacity of the S-VOL (local disk array LU) must be the same as that of the P-VOL selected in the **Pair Volume** list. If you select multiple external LUs as P-VOLs in the **Pair Volume** list, you must select the same number of S-VOLs in the **Candidate Volume** list.

7. Click **Set** (arrow pointing left).

LUs selected in the **Candidate Volume** list appear in the S-VOL column in the **Pair Volume** list. If several LUs are selected, they appear in the S-VOL column in the same order as in the **Candidate Volume** list. If the number of LUs selected in the **Pair Volume** list is different than the number selected in the **Candidate Volume** list, the **Set** button is not available.

8. Click **OK** in the Pair Volume Setting pane to close the pane and return to the Flex Copy pane.

Settings appear in blue and italics in the Pair List, and the contents appear in the **Preset** list. To check setting details, select the setting in the **Preset** list, right-click, and select **Detail**. To modify settings of the copy pair, select the setting in the Preset list, right-click, and select **Modify**. To cancel settings, select the setting in the **Preset** list, right-click, and select **Delete**.

9. Click **Apply** in the Flex Copy pane. The Copy Type Setting pane appears.
10. Set the **Copy Type** and **Copy Pace**, and click **OK**. A confirmation message appears.
11. Click **OK** to close the message.

The copy pair is set and the status of the copy pair appears in the **Status** column of the Pair List. To refresh the displayed status while the copy processing is in progress, click the Refresh button () in the Command View main window.

If errors occur during copy operations, failed settings appear in the **Preset** list and error codes appear. To check error messages, select the failed setting, right-click, and select **Detail**.

## Copying data from local disk array LUs to external LUs

Before starting copy operations, map the external LU you want to set for the S-VOL as an internal LU. The procedure for setting the external LU is described in “[Setting external LUs](#)” on page 740.

1. In the External Storage XP operations pane, select **Flex Copy**. The Flex Copy pane appears.
2. Select the **Internal Volumes** option (lower right in the Pair List).
3. Select the CU number of the local disk array LU to be the P-VOL (source volume) in the CU tree.  
The LU of the selected CU appears in the **P-VOL** column of the Pair List, and “#” appears next to the internal LU number where the external LU is mapped.
4. In the **P-VOL** column of the Pair List, select one or more local disk array LUs that are not already set as a copy pair, right-click, and select **Create Pair** (see [Figure 383](#) on page 748). The Pair Volume Setting pane appears (see [Figure 381](#) on page 746).



**NOTE:** In the Pair List, you can select several local disk array LUs. The ones you select appear in the **Pair Volume** list on the Pair Volume Setting pane.

5. In the **P-VOL** column of the **Pair Volume** list on the left of the Pair Volume Setting pane, select the local disk array LU to be copied to the external LU. You can select several external LUs.
6. In the **Candidate Volume** list on the right, select the local disk array LU you want to set as the target volume (S-VOL).

The capacity of the S-VOL (local disk array LU) must be the same as that of the P-VOL selected in the **Pair Volume** list. If you select several external LUs as P-VOLs in the **Pair Volume** list, you must select the same number of S-VOLs in the **Candidate Volume** list.



**NOTE:** A message appears when the copy range of the P-VOL is greater than the capacity of the S-VOL. (No message appears, however, if you are using RAID Manager commands.) This message appears because Flex Copy determines the copy range according to smallest capacity of the LU pair. This means some of the copy source LU might not be copied to the copy destination LU if the copy destination LU has a smaller capacity than the copy source LU. See “[Relationship between LU capacity and copy range](#)” on page 755 and check the copy range.

7. Click **Set** (arrow pointing left).

LUs selected in the **Candidate Volume** list appear in the S-VOL column in the **Pair Volume** list. If several LUs are selected, they appear in the S-VOL column in the same order as in the **Candidate Volume** list. If the number of LUs selected in the **Pair Volume** list is different than the number of LUs selected in the **Candidate Volume** list, the **Set** button is not available.

8. Click **OK** in the Pair Volume Setting pane to close the pane and return to the Flex Copy pane.

Settings appear in blue and italics in the Pair List. The contents of the setting appear in the **Preset** list. To check setting details, select the setting in the **Preset** list, right-click, and select **Detail**. To modify

settings, select the setting in the Preset list, right-click, and select **Modify**. To cancel settings, select the setting in the **Preset** list, right-click, and select **Delete**.

9. Click **Apply** in the Flex Copy pane. The Copy Type Setting pane (see [Figure 382](#) on page 747) appears.
10. Set the **Copy Type** and the **Copy Pace**, and click **OK**. A confirmation message appears.
11. Click **OK** to close the message.

The copy pair is set and the status of the copy pair appears in the **Status** column of the Pair List. To refresh the displayed status while copy processing is in progress, click Refresh (  ) in the Command View main window.

If errors occur during copy operations, failed settings appear in the **Preset** list and error codes appear. To check error messages, select the failed setting, right-click, and select **Detail**.

## Displaying history of Flex Copy operations

Click **History** in the upper right of the Flex Copy pane to display the Flex Copy History pane, showing the history of Flex Copy operations.

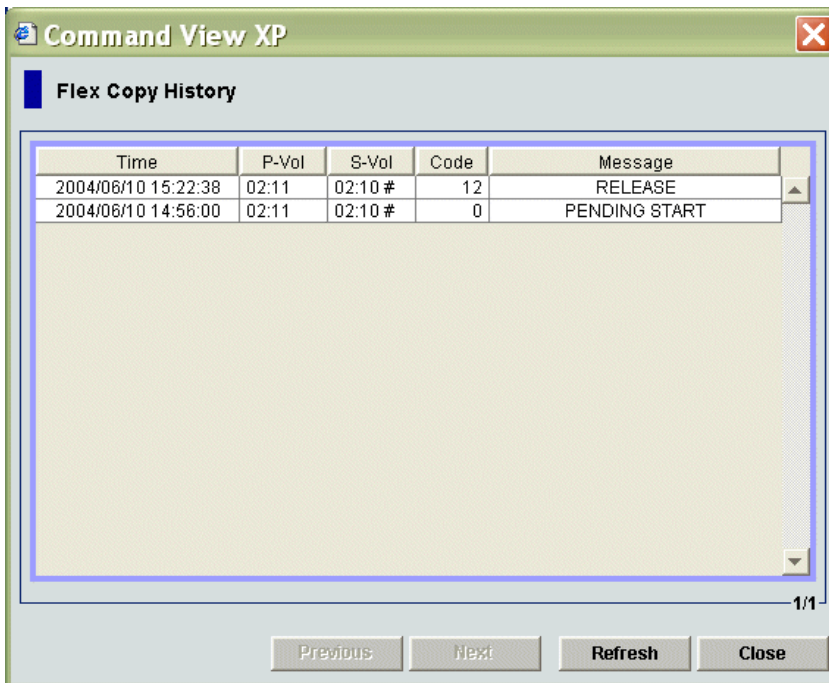

**Figure 384** Flex Copy History pane

This pane can display up to 8,192 operations. To sort the list, click a column heading.

The Flex Copy History pane displays the following items:

- **Time**  
Date and time (YYYY/MM/DD hour/min/sec) when a Flex Copy pair or volume operation was performed. If acquired information is not appropriate, "\*" is displayed.
- **P-Vol**  
CU:LDEV number of the P-VOLs used for previous Flex Copy pair operations.



**NOTE:** An LDEV number ending with “#” indicates the LDEV is an external volume (for example, 00:01#). If acquired information is not appropriate, “\*” is displayed.

- **S-Vol**

CU:LDEV number of the S-VOLs used for pair operations in the past.



**NOTE:** An LDEV number ending with “#” indicates the LDEV is an external volume (for example, 00:01#). If acquired information is not appropriate, “\*” is displayed.

- **Code**

Flex Copy reference code.

- **Message**

Messages describing conditions of previous Flex Copy pair operations according to the code (see [Table 143](#)).

- **Previous** button

Displays the previous page of the history list. This button is available only when the number of records exceeds 1,024.

- **Next** button

Displays the next page of the history list. This button is available only when the number of records exceeds 1,024. The list can obtain up to 8,192 operations.

- **Refresh** button

Updates displayed records.

- **Close** button

Closes the Flex Copy History pane.

[Table 143](#) lists the Flex Copy reference codes and messages displayed in the Flex Copy History pane.

**Table 143** Flex Copy reference codes

Code	Message	Attributes	Description
0	PENDING START	Starting copy processing	Copy processing was started from the PENDING status.
1	SP-PEND START		Copy processing was started from the SP-PEND status.
2	RESYNC[P->S] START		Copy processing from P-VOL to S-VOL was started from the RESYNC status.
3	RESYNC[S->P] START		Copy processing from S-VOL to P-VOL was started from the RESYNC status.
4	PENDING FINISH	Normal termination of copy processing	Copy processing started with the PENDING status was terminated normally.

**Table 143** Flex Copy reference codes (continued)

Code	Message	Attributes	Description
5	SP-PEND FINISH		Copy processing started with the SP-PEND status was terminated normally.
6	RESYNC[P->S] FINISH		Copy processing from P-VOL to S-VOL started with the RESYNC status was terminated normally.
7	RESYNC[S->P] FINISH		Copy processing from S-VOL to P-VOL started with the RESYNC status was terminated normally.
8	PENDING ERROR	Abnormal termination of copy processing	Copy processing started with the PENDING status was terminated abnormally.
9	SP-PEND ERROR		Copy processing started with the SP-PEND status was terminated abnormally.
10	RESYNC[P->S] ERROR		Copy processing from P-VOL to S-VOL started with the RESYNC status was terminated abnormally.
11	RESYNC[S->P] ERROR		Copy processing from S-VOL to P-VOL started with the RESYNC status was terminated abnormally.
12	RELEASE	Release	Copy processing is released.
13	STOP	Stop	Copy processing is stopped. When Flex Copy is operated with CCI, this message indicates the pairsplit-E status.
14-30	-	(Reserve)	Reserved for future use.
31	SP-PEND SKIP	Debug information	SP-PEND status was skipped.



**NOTE:** SP-PEND status means the copy pair status is moving towards the Split status. Copy processing is in progress in the background.

## Canceling copy pairs (Delete Pair)

Use the **Delete Pair** command to cancel a copy pair.



**CAUTION:** You cannot cancel a copy pair if pair status is **PSUS (SP)**. In that case, wait until copy processing finishes, or set pair status to **PSUE** from RAID Manager XP and cancel the copy pair.

1. In the External Storage XP operations pane, select **Flex Copy**. The Flex Copy pane appears.
2. Select the CU number of the P-VOL of the copy pair you want cancel in the CU tree.

The LUs of the selected CU appear in the **P-VOL** column of the Pair List, and “#” appears next to the internal LU number where the external LU is mapped.

- Click the **External Volumes** or **Internal Volumes** option (lower right in the Pair List) according to the copy pair you want to cancel.

Status values of the copy pair appear in the Pair List corresponding to the selected button.

- Select the row of the copy pair you want to cancel, right-click, and select **Delete Pair**.

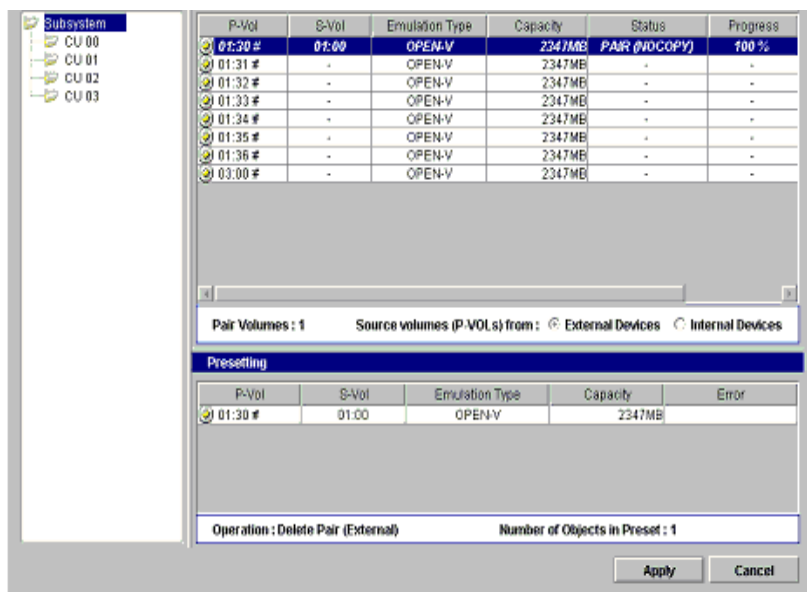

**Figure 385** Preset Status of Canceling Copy Pair Operation

The selected row appears in blue and italics in the Pair List. The selected copy pair also appears in the **Preset** list. To check setting details, select the setting in the **Preset** list, right-click, and select **Detail**. To cancel settings, select the setting in the **Preset** list, right-click, and select **Delete**.

- Click **Apply** in the Flex Copy pane. A confirmation message appears.
- Click **OK** to close the message.

The copy pair selected in the Pair List is canceled.

If errors occur during cancel operations, failed settings appear in the **Preset** list, and error codes appear. To check error messages, select the failed setting, right-click, and select **Detail**.

## Troubleshooting Flex Copy

Table 144 provides general troubleshooting instructions for Flex Copy operations.

- For problems concerning the LU Operation and Port Operation tabs or External Storage XP in general, see ["Troubleshooting External Storage XP"](#) on page 814=.
- If you have a problem with the local disk array Command View computer or Command View software, see ["Troubleshooting"](#) on page 835 for more information.
- If you need additional assistance, contact your HP Account Support Representative

**Table 144** General Flex Copy troubleshooting

Error	Corrective Action
Pair operation cannot be performed from Command View (operation is rejected).	React according to the error message.

**Table 144** General Flex Copy troubleshooting (continued)

<b>Error</b>	<b>Corrective Action</b>	
Pair operation cannot be performed from RAID Manager XP (operation is rejected).	Check the error message concerning the command, and react according to the log file and the <i>HP StorageWorks RAID Manager XP User's Guide</i> .	
Pair operation cannot be performed from RAID Manager XP (operation is rejected) and the following error message appears:  An order to the control/command device was rejected.	The following problems may have caused the error. Take the action required to resolve the problem. If you need further assistance, contact your HP account support representative.	
	<b>Problem</b>	<b>Error Number</b>
	License for Flex Copy is not installed.	8500
	Create Pair operation was rejected because licensed capacity was exceeded.	8592
	Capacities of selected P-VOL and S-VOL are not the same.	8519
	Specified copy pair does not consist of a local disk array LU and the internal LU to which an external LU is mapped.	8672
	Emulation type of specified LU is not OPEN-V.	8673
	I/O operation from the host to the specified P-VOL or S-VOL is in progress.	8675
	Copy processing from S-VOL to P-VOL was rejected because the LUN Security XP Extension setting of S-VOL Disable is set to the P-VOL.	5821
	LUN Security XP Extension setting of S-VOL Disable is set to the S-VOL.	5821
	Specified P-VOL is not implemented.	8549
	Specified P-VOL is blockaded.	8550
	Specified P-VOL is being formatted.	8551
	Specified P-VOL is a command device.	8552
	The P-VOL or S-VOL specified for Flex Copy pair was used as another Flex Copy pair.	8681
	Specified S-VOL is not implemented.	8553



**Table 144** General Flex Copy troubleshooting (continued)

Error	Corrective Action	
	Specified S-VOL is blockaded.	8554
	Specified S-VOL is being formatted.	8555
	Specified S-VOL is a command device.	8556
	Specified S-VOL is a NAS system volume.	5624
	Specified P-VOL or S-VOL is the P-VOL for Continuous Access XP.	8689
	Specified P-VOL or S-VOL is the S-VOL for Continuous Access XP.	8690
	Specified P-VOL or S-VOL is the P-VOL for Business Copy XP.	8691
	Specified P-VOL or S-VOL is the S-VOL for Business Copy XP.	8692
	Specified P-VOL or S-VOL is being used for Auto LUN XP.	8593 or 8594
The copy processing of Flex Copy terminates abnormally, and the pair status becomes PSUE (suspended).	<p>Error factor could be on the MSA1000 settings. Possible factors are as follows:</p> <ul style="list-style-type: none"> <li>• Read or Write operation is not permitted.</li> <li>• After the mapping operation (Add LU operation) of the external LU, capacity of the external LU is reduced.</li> <li>• Reserve attribute is set.</li> </ul> <p>If the error factor does not match any of these factors and if this problem persists, contact your HP Account Support Representative.</p>	

## Relationship between LU capacity and copy range

For the Flex Copy copy operation, you must create a pair consisting of an XP disk array LU and an external LU mapped as an internal LU of an XP disk array.

The capacity of the real LU of the XP disk array and that of the real LU of the external disk array are usually different. Therefore, be careful when specifying the copy source LU and copy target LU for Flex Copy. If the capacity of the real LU of the XP disk array is different from that of the real LU of the external disk array, Flex Copy applies a copy range equal to the smaller capacity.

Figure 386 shows the range of data copied when the capacity of the real LU of the external disk array is less than that of the XP disk array. In this case, Flex Copy uses the capacity (A) of the external LU as the data copy range for copy processing. Data stored in the range above the capacity (B) of the real external LU is not copied.

In the example shown in Figure 386, if you copy data from the external disk array to the XP disk array, all data (A) in the external disk array is copied to the XP disk array. However, if you try to copy data in the reverse direction (that is, all the data (A + B) in the XP disk array to the external disk array), some XP disk array data (B) cannot be copied.

Consequently, the capacity of the copy target LU must always be the greater than or equal to the capacity of the copy source LU.

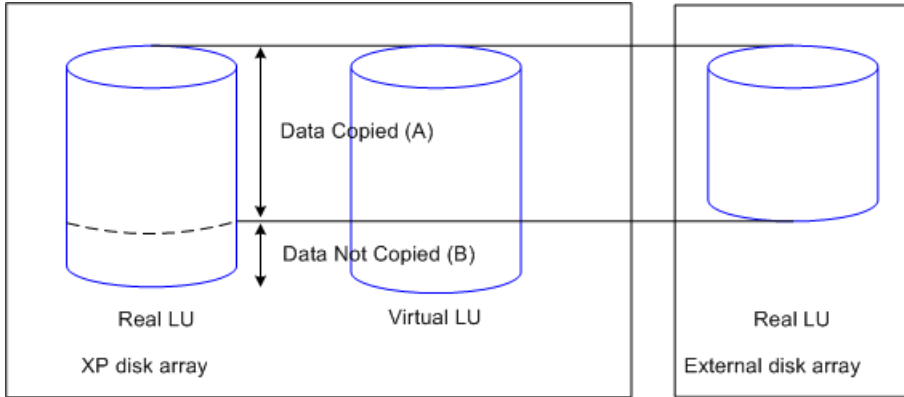

**Figure 386** Data copy range of copy processing for Flex Copy

**Figure 387** shows an example where the copy source LU is completely copied to the copy target LU. In **Figure 387**, data in the external disk array is copied to the XP disk array. In the XP disk array, a real LU with capacity greater than the copy source LU is selected. This means the copy target LU has enough capacity to accept a complete copy of data in the external LU, so the Flex Copy copy operation is successfully completed.

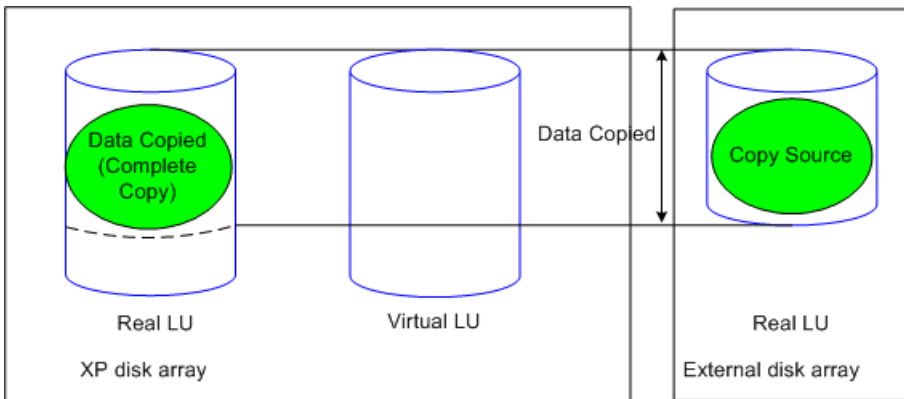

**Figure 387** Example of a complete copy

**Figure 388** shows an example where the copy source is not copied completely to the copy target LU. In this example, data in the XP disk array is copied to the external disk array. In the external disk array, a real LU with capacity smaller than the copy source LU is selected. To copy all source data (A + B) in the XP disk array, the target LU selected in the external disk array is too small, so some copy source data (B) is not copied. This means the Flex Copy copy operation is unsuccessful.

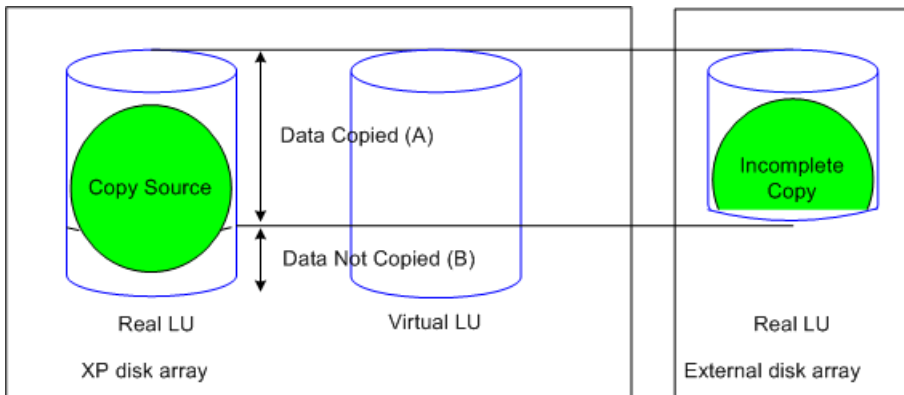

**Figure 388** Example of an incomplete copy

---

# 27 External storage for the XP12000

Use External Storage XP to connect different types of HP or non-HP external storage devices to an HP StorageWorks XP12000 disk array, and map and access Logical Units (LUs) on external devices as if they were part of the XP12000 array. You can create a “virtual” disk array, and use Command View to easily administer and manage petabytes of external address space via a single XP controller.

External Storage XP supports external storage LDEVs of any standard XP emulation type, such as OPEN-3, OPEN-8, OPEN-9, OPEN-L, OPEN-K, or OPEN-V.

You may also use External Storage XP for offline data migration, providing a point-in-time copy of data between an external device and the XP12000 disk array.

Flex Copy is another StorageWorks XP product that copies user data between an existing LU on an XP128 or XP1024 and an LU on an external storage device. For a detailed description of Flex Copy, see “[Flex Copy for the XP128/XP1024/XP12000](#)” on page 703.

In this chapter, the original XP12000 disk array is called the *local disk array* and the connected disk array is called the *external disk array*. A volume managed in the local disk array is called an *internal XP LDEV*, while an LU in an external disk array is called an *external LU*.



**NOTE:** Currently only the XP12000 disk array can be used as the local disk array with External Storage XP.

---

---

## Mapping

Mapping means assigning XP12000 Virtual Devices (VDEVs) and, consequently, Logical Devices (LDEVs) and host port LUs to external LUs. If you map external LUs as internal XP12000 VDEVs, you can use

Command View XP to then assign the VDEV to an internal CU:LDEV and a port/LU address. This allows you to operate an external LU as if it were an LDEV in the local disk array.

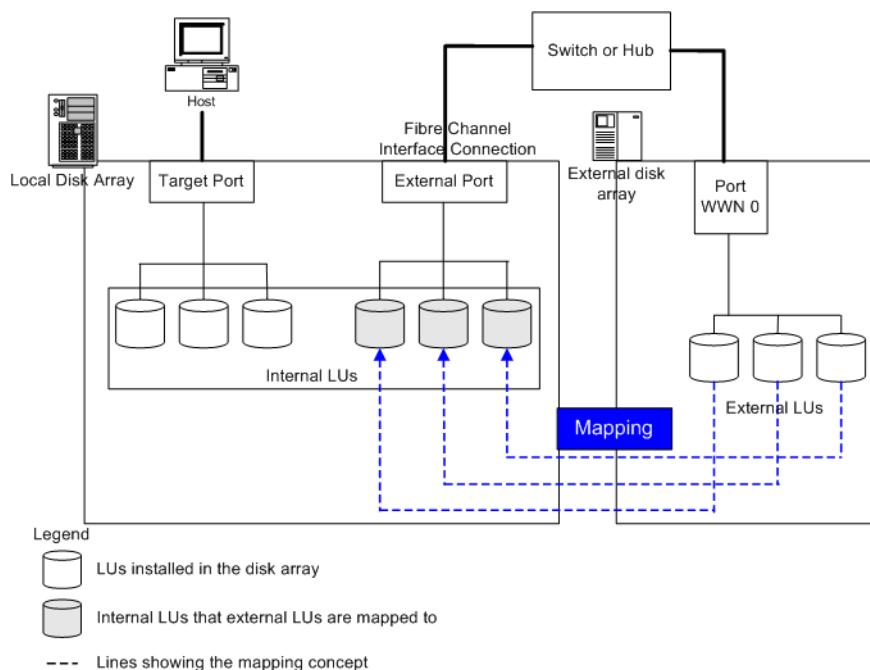

**Figure 389** External Storage XP concept

**Figure 389** illustrates a connection between a local disk array and an external disk array interconnected using External Storage XP software and fibre channel hardware. In this figure, the external disk array is connected to the external port of the local disk array via a switch (or hub) using a Fibre Channel interface. *External* is a kind of XP12000 port attribute used for External Storage XP. In the figure, external LUs are mapped as local disk array VDEVs and LDEVs and, consequently as an LU.



**NOTE:** The phrases “mapped as an internal LU” or “mapped as an internal LDEV” should be interpreted to mean that the external LU is specifically mapped into the XP12000 as a unique VDEV (Virtual Device), which is then associated with an XP12000 CU:LDEV (Control Unit:Logical Device), which is then typically associated with a unique host port/LU combination. Since an XP12000 LU number is only unique within the name space of a host port (e.g. CL1-A), references to “XP LU” should be interpreted as references to either the unique port/LUN combination, or the unique CU:LDEV combination.

## Alternate paths

When you map an external LU as an internal XP LDEV, a path (called a *mapped path*) is set from the internal XP LDEV to the external LU. In addition to the original path, you can set additional paths to the external LU, called *alternate paths*.

You can set up to eight paths to the external LU (including paths set automatically). Among the paths to the external LU, the path with the highest priority is called the *primary path*, and other paths are *alternate paths*.

When an external LU is mapped to an internal XP LDEV using External Storage XP, host I/O operations to an external LU via the XP12000 are normally enabled using the mapped path. However, if the mapped path is not available (for instance, during disk array maintenance or following a failure in the channel processor), the path is switched automatically to the alternate path (if available). As long as an alternate path is available, host I/O operations continue as usual, even when an error occurs in the original path.



**NOTE:** When the original path cannot be used for three consecutive minutes, the path is switched to an alternate path. A GUI 'Disconnect' operation applied to the priority path will also cause a failover to an alternate path.

If you have not configured any alternate paths, host I/O operations are suspended when the primary path becomes unavailable (such as during disk array maintenance operations or following a failure in the channel processor).

HP recommends configuring alternate paths for safer operation and increased bandwidth. For instructions on setting alternate paths, see page 800.

Figure 390 shows an example of alternate path settings. In the figure, the external disk array ports WWN A and WWN B are connected to CL1-A and CL2-A, respectively, which are designated as **External** ports in the local disk array. You must specify the port of a different cluster in the local disk array for the alternate path, as ports CL1 and CL2 are specified in the figure.

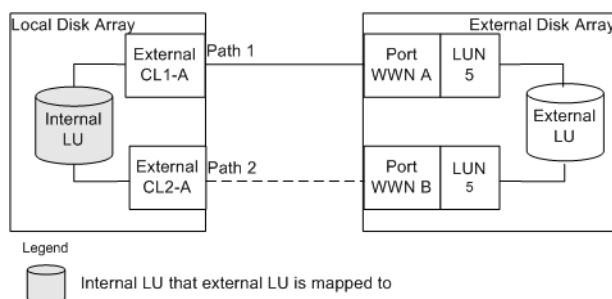

**Figure 390** Example of alternate path settings

Figure 391 shows another example of alternate path settings. Here two ports are specified in the local disk array and connected to ports in the external disk array via switches. In this example, ports from different XP12000 clusters are specified in the local disk array, thereby making it possible to configure an alternate path.

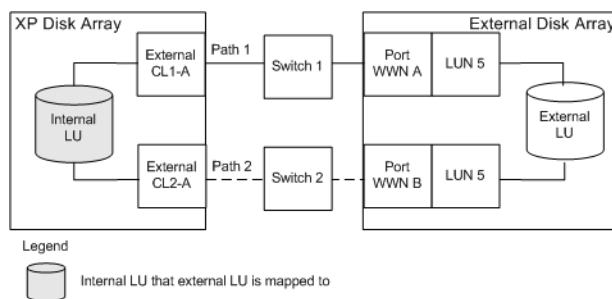

**Figure 391** Example of alternate path configuration using two switches

Figure 392 also shows two paths configured between the external XP LDEV and external LU. However, only one port is specified in the local disk array, while two ports are specified in the external disk arrays

via the switch. Since two ports of different clusters must be set in the local disk array for External Storage XP to use alternate path settings, HP does not recommend the configuration shown in [Figure 392](#).

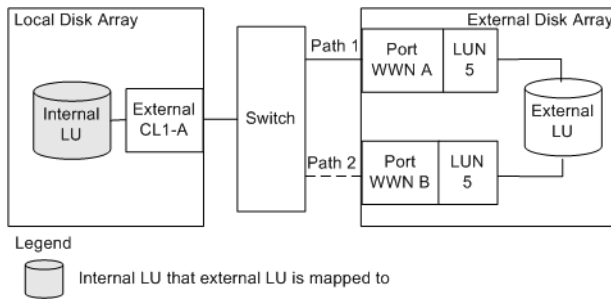

**Figure 392** Incorrect example of alternate path configurations

## External Storage XP uses

Use External Storage XP to perform the following tasks for managing external disk arrays:

- "Writing new data to mapped external LUs" on page 760
- "Using existing data in mapped external LUs" on page 761
- "Using external LUs for Volume Migration under Auto LUN XP" on page 762
- "Using external LUs for Business Copy operations" on page 763

## Writing new data to mapped external LUs

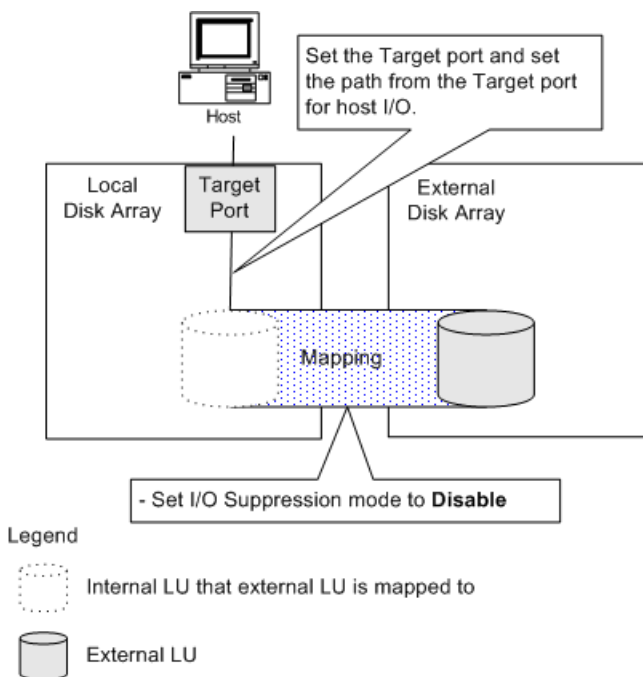

**Figure 393** Writing new data to mapped external LUs

[Figure 393](#) shows an example of writing new data from a host connected to the local disk array to a mapped external LU. In this case, use the following procedure:

1. Use the External Storage XP Command View GUI to map the LU in the external disk array as an internal XP LDEV of the local disk array.



**NOTE:** You must set **IO Suppression** mode to **Disable**.

2. Choose the emulation type of the mapped LDEV.

- For XP12000 open systems emulation types (such as OPEN-V), the status of the mapped LDEV is set automatically to **Normal** and is not formatted automatically. To format the mapped LU, use Volume Management (page 241).
- For mainframe system emulation types (for example, 3390-XX), the status of the mapped LU is set to **Blockade**, pending resizing and formatting. Format the volume using Volume Management (page 241).

3. Map the Target port LU to the mapped LDEV.

The mapped LDEV is available for host I/O operations.

## Using existing data in mapped external LUs

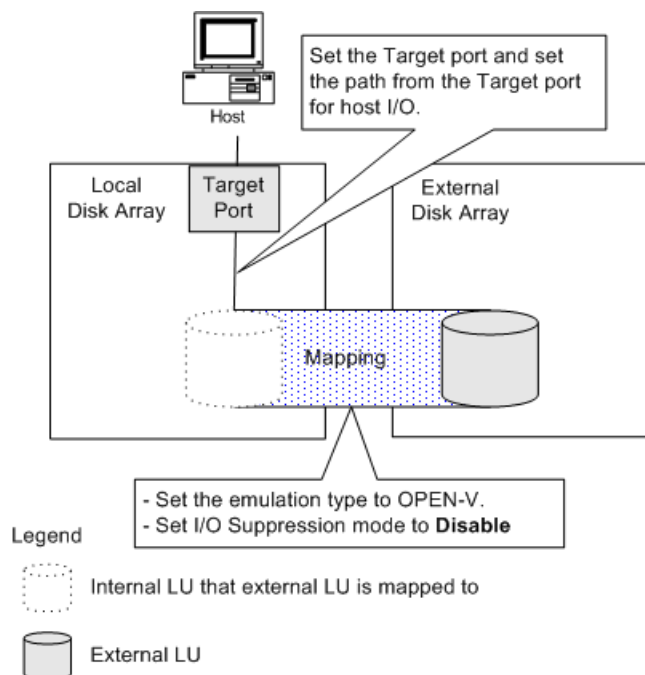

**Figure 394** Using existing data in mapped external LUs (without formatting)

**Figure 394** shows an example of using existing data in a mapped external LU from the host connected to the local disk array. In this case, use the following procedure:

1. From a host connected directly to the external disk array, write data to the LU in the external disk array.
2. Use External Storage XP to map the LU in the external disk array containing data as an internal XP LDEV of the local disk array.

When mapping the external LU, set the following attributes for the mapped LU:

- Emulation type: **OPEN-V**
- **IO Suppression** mode: **Disable**

For information about mapping external LUs, see page 791.



**NOTE:** To read existing data in the mapped external LU using the local disk array, set the emulation type to **OPEN-V**. Other emulation modes require that the data space be resized, which in effect destroys existing data. Once an external LU is mapped to the local disk array for use by External Storage XP, direct host access to that LU is no longer allowed.

3. Configure the path from the Target port to the mapped LU.

The mapped LU is available for host I/O operations.

## Using external LUs for Volume Migration under Auto LUN XP

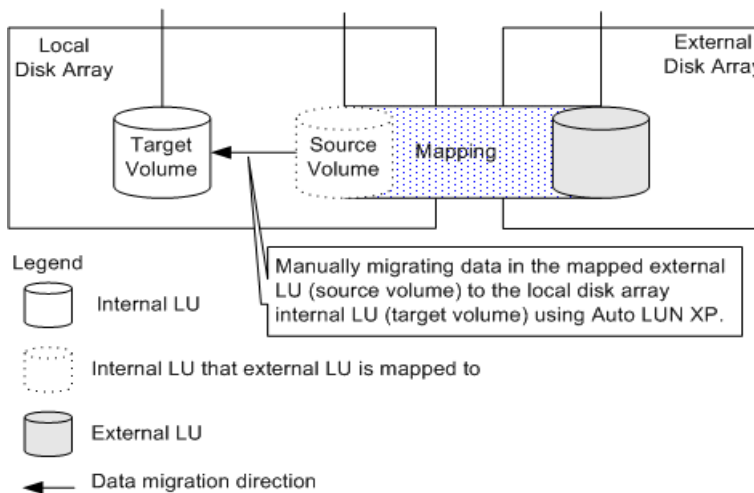

**Figure 395** Volume Migration using external LUs

Figure 395 shows an example using an external LU for the Auto LUN XP Volume Migration operation. The mapped external LU is set as the source volume. The local disk array internal XP LDEV is set as the target volume. Existing data in the external LU is (in effect) migrated manually to the internal XP LDEV on the local disk array using Auto LUN XP volume migration. For detailed information, see page 345.

To perform this operation, follow these steps:

1. Use External Storage XP to map the LU in the external disk array as an internal XP LDEV of the local disk array.

For this example, set the following attributes for the mapped LU:

- Emulation type: **OPEN-V**
- **IO Suppression** mode: **Disable**

For details about mapping operations, see page 791.



**CAUTION:** To migrate existing data in the mapped external LU to a local disk array volume using Auto LUN XP volume migration or BC XP, as shown here, set the XP12000 emulation type to OPEN-V. Only OPEN-V emulation can be used to read existing data in the external LU from the local disk array side.

2. Prepare a local disk array internal XP LDEV with the same capacity as the mapped external LU. Adjust the capacity of the internal XP LDEV as required using the LUSE and Volume Management functions. For details, see ["Volume Management for the XP128/XP1024/XP12000"](#) on page 241.





**CAUTION:** The emulation type of the XP12000 prepared internal XP LDEV must be OPEN-V.

3. Set the mapped external LU as the source volume, and set the local disk array internal LU as the target volume.
4. Use Auto LUN XP to manually migrate the existing data in the mapped external LU to the local disk array internal XP LDEV (and any associated port/LU).

## Using external LUs for Business Copy operations

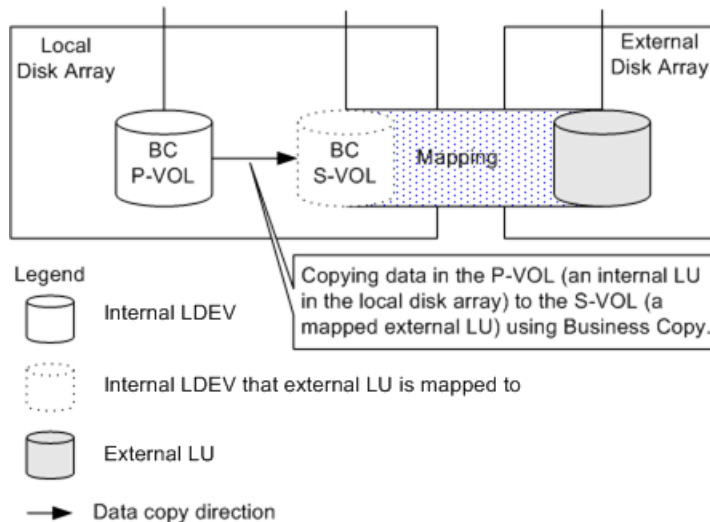

**Figure 396** Business Copy operations using an external LU

Figure 396 shows an example using an external LU for Business Copy (BC) operations. The mapped external LU is set as the S-VOL of the BC pair. The local disk array internal XP LDEV is set as the P-VOL of the BC pair. For detailed information about Business Copy operations, see page 413.

To perform this operation, follow these steps:

1. Use External Storage XP to map the LU in the external disk array as an internal XP LDEV of the local disk array. For details, see page 791.



**CAUTION:** Set the **IO Suppression** mode to **Disable**.

2. Choose the emulation type of the mapped LU.
  - For the OPEN-V emulation type, the status of the mapped LU is set automatically to **Normal**, and the volume is not automatically formatted. To format the mapped LU, use Volume Management (page 241).
  - For non-open systems emulation types (for example, 3390-XX), the status of the mapped LU is set to **Blockade**, pending resizing. Format the volume using Volume Management (page 241)
3. Set the P-VOL and S-VOL of the Business Copy pair using BC.



**NOTE:** If the number of FC links to the external LU does not allow for adequate P-vol high availability and bandwidth, place the BC XP P-VOL on internal storage.

---

# Combining External Storage XP with other HP StorageWorks products

Use the following products to manage external LUs mapped using External Storage XP:

- LUN Expansion (LUSE) and Volume Management
- Cache LUN XP
- Auto LUN XP (manual mode, only)

Use Auto LUN XP to display monitoring information concerning external volumes. For an example of using Auto LUN XP with External Storage XP, see page 761.

- TrueCopy - S/390®
- Business Copy XP

For an example of using Business Copy XP with External Storage XP, see page 763.

- ShadowImage for z/OS®
- Hitachi Parallel Access Volume (HPAV)
- Hitachi SANtinel - S/390®

You must set the **IO Suppression** mode to **Disable** to use a mapped external LU for Hitachi SANtinel - S/390® operations.

- Hitachi SANtinel - S/390®
- LUN Security XP Extension
- SNMP

Information about the mapped external LU and external port is displayed.

- Configuration File Loader
  - Set the path definition for external LUs (add, delete, or change paths)
  - Add or delete command devices on external LUs



**NOTE:** Continuous Access XP is not yet supported with External Storage XP.



**NOTE:** Some mainframe products may be marketed under different HP names, and are not supported at this time.

---

[System\\_Requirements](#)

---

# Requirements and restrictions

## System requirements

- Local disk array (first disk array)

Install and enable all hardware and microcode required for External Storage XP operations in the local disk array.



**NOTE:** Currently only an XP12000 can be used as a local disk array. XP firmware 50-02-14 (or greater) is required to support the external storage devices. For a list of all external storage devices that can be used as an external disk array, see ["Storage devices that can be connected as external disk arrays"](#)

- 
- External disk array (second disk array)

You will also need a second storage device, called the external disk array in this document. For a list of all external storage devices that can be used as an external disk array, see ["Storage devices that can be connected as external disk arrays"](#)

- HP StorageWorks Command View XP for the local disk arrays (running on a user-supplied Windows®-based PC)

See the *HP StorageWorks Command View XP Installation Guide* for instructions on installing the Command View XP Web GUI.



**NOTE:** You must run Command View XP in Modify mode to perform External Storage XP operations. In View mode, you can only view External Storage XP information.

- 
- External Storage XP

Enable the licensed External Storage XP feature in Command View XP.

## Storage devices that can be connected as external disk arrays

- HP StorageWorks XP256, XP48/XP512, XP128/XP1024/XP12000
- HP StorageWorks MSA1000/1500
- IBM ESS series
- EMC DMX and Symmetrix series
- HDS 7700, 9900, 9900V series; 2000, 9500V series
- Sun SET3, SE6120

## Fibre Channel switches supported

- HP Core Switch 2/64 (Brocade 12000)
- HP SAN Director 2/128 (Brocade 24000)
- HP SAN Switch 2/8V, 2/16V, 2/16N, 2/32 (Brocade 3250, 3850, 3900)
- HP SAN Switch 2/8 -EL, 2/16 -EL, 2/16 (Brocade 3200, 3800, 3600)

- HP Director 2/64 (McData 6064), HP Director 2/140 (McData 6140)
- HP Edge Switch 2/16, 2/32, 2/12, 2/24 (McData 3216, ES 3232, ES4300, ES 4500)

## External Storage XP requirements

**Table 145** External Storage XP requirements

Item	Requirement
Required software products	LUN Expansion (LUSE) / CVS HP StorageWorks Command View XP version 2.0 or later LUN Configuration and Security Manager (for setup) HP StorageWorks RAID Manager XP version 01.12.06 or later (if Flex Copy or BC XP is used)
Maximum number of external LUs addressable per XP12000 port	1,024 per XP12000 port
Maximum number of external LUs that can be connected	15,360 for entire XP12000
Maximum number of FC paths that can exist to one external LU	8
Maximum capacity of an external LU	2 TB per external LU (OPEN-V) If you specify an external LU that is larger than 2 TB, you can only access data stored in the field up to 2 TB.
Minimum capacity of an external LU	35 MB per external LU (non-OPEN-V) When the emulation type of the volume is OPEN-V, minimum capacity is 46.86 MB per external LU.

## Limitations concerning External Storage XP operations

### General limitations

- Mapping operations cannot be performed if some parts of the local disk array are blocked. In this case, restore blocked parts of the local disk array, and retry the operation.
- External LUs can be used immediately after performing mapping operations. To optionally initialize the data area for the LU, format the LU using Volume Management (page 241). An external LU can be used for manual Auto LUN XP operations, but not for automatic Auto LUN XP operations.
- For External Storage XP, IO Suppression mode is typically set to **Disable**. A mapped external LU with **IO Suppression** mode set to **Enable** cannot be used for the pair copy operations of Continuous Access XP, TrueCopy - S/390®, Business Copy XP, and ShadowImage - S/390®.
- Host access to the external storage LU must be via the XP12000, and must **not** be via a direct physical connection to the external storage device LU. For external array LUs not involved with External Storage XP, direct access from a host is allowed.

## LU mapping compared to emulation type

- When you map you map in an external disk and specify OPEN-V emulation, the LU is defined as an internal XP LDEV with the same capacity as the mapped external LU. That is, no space is forfeited for management space, and no formatting of that data occurs. Therefore, Open-V is recommended.

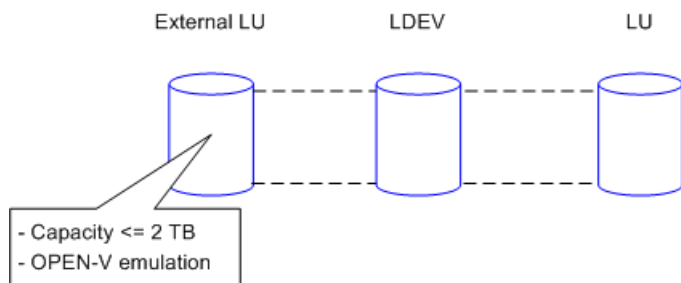

**Figure 397** Example of external LUs <= 2 TB

- When you map an external LU as internal XP LDEV(s) and use emulation types other than OPEN-V, the number of volumes and the volume capacity of the mapped internal XP LDEV(s) depends on the capacity of the original external LU and normal size of each emulation type. When an external LU is mapped using emulation types other than OPEN-V, an XP array management information area is required in the mapped LU. This means that the capacity available after mapping is slightly smaller than the actual external LU capacity. Available capacity decreases by the size of the XP array management information area, and all prior data must be considered lost. For further information, see page 755.

Figure 398 shows an example where capacity of the external LU is larger than (or a multiple of) the normal size of the XP12000 emulation type (OPEN-3 in this example). Therefore, in this example, the XP12000 can realize two fully-sized OPEN-3 LDEVs, with some space (insufficient to create a full Open-3) left over.

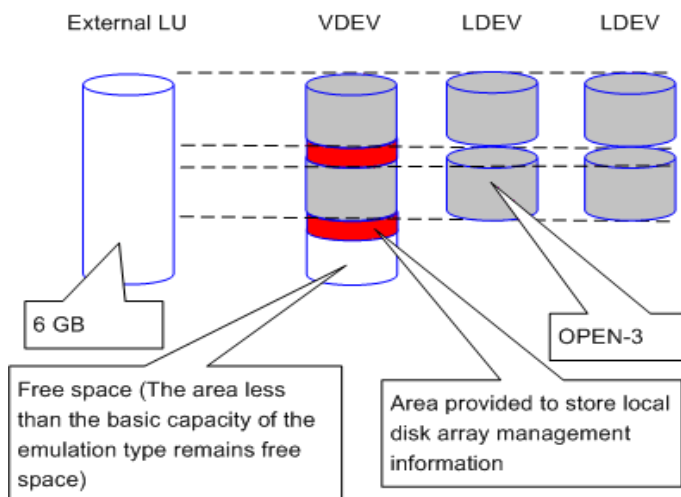

**Figure 398** External LU capacity is larger than capacity of specified emulation type

- Figure 399 shows an example where the original capacity of the external LU is smaller than the normal size of the XP12000 emulation type. In this example, since the resulting space is insufficient to create an XP12000 OPEN-3 LDEV, you can designate it as either an XP12000 OPEN-V or as an “OPEN-3 CVS” LDEV. If the external LU were an XP of OPEN-3 emulation type, the forfeiting of a

small amount of management space would also result in either an “OPEN-3 CVS”, XP12000 volume or an OPEN-V.

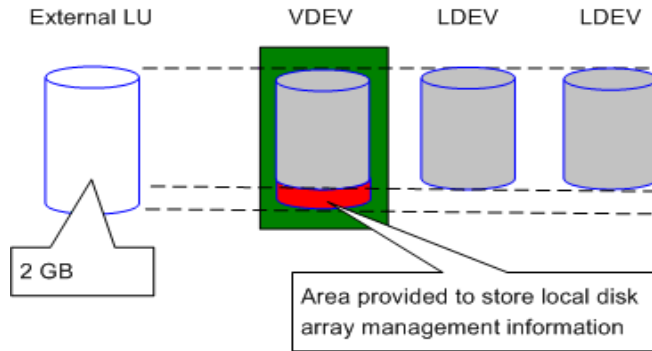

**Figure 399** External LU capacity is smaller than basic capacity of specified emulation type

## IO Suppression mode and Cache Mode

- **IO Suppression** mode can only be set to **Enable** when OPEN-V emulation is set for the volume being mapped. If a different emulation type is set, **IO Suppression** mode is set automatically to **Disable**.
- When accessing a mapped external LU from a host connected to the local disk array, set the **IO Suppression** mode to **Disable**. For External Storage XP, select **Disable**. For Flex Copy XP, select **Enable**.
- The local disk array does not force the external disk array to reserve the mapped external LU. Therefore, do not write directly to an external disk array LU with **IO Suppression** mode set to **Disable**.
- **IO Suppression** mode and **Cache Mode** are set automatically to the same status for all LDEVs in a given external LU.

## Attributes

- External LU attributes (emulation type, **IO Suppression** mode, and **Cache Mode**) set when the LU is mapped cannot be changed while the LU is mapped. To change these attributes, delete the external LU mapping (Delete LU operation), and remap the LU with different attributes (Add LU operation).
- External LU attributes for all LDEVs created in an external LU are set to the same values. Those attributes are modified when the LDEVs are reconfigured using Volume Management.
- Mapped LUs with different external LU attributes or reside on different arrays cannot be used to create one LUSE volume.
- Attributes originally set for an LU on an XP external disk array (such as port security, LUN security, and LDEV Guard attributes) are not recognized by the local disk array when the external XP LU is mapped as a local disk array internal XP LDEV. To keep the original attributes, set those attributes on the mapped external LU from the local disk array side.

## Cache LUN XP

- A mapped external LU with **IO Suppression** mode set to **Enable** (such as for Flex Copy XP) cannot be used for XP12000 Cache LUN operations.
- For a mapped external LU with **IO Suppression** mode set to **Disable** (such as for External Storage XP), Cache LUN Bind mode is not available.

## LUSE and External Storage XP

- Do not combine LDEVs from multiple external LUs to create an XP12000 LUSE volume.
- A local disk array internal XP LDEV and an external LU cannot be combined to form a LUSE volume.

- External volumes with different **IO Suppression** modes or different **Cache Modes** cannot be combined to form a LUSE volume.

## LUN management

A mapped external LU cannot be used as a NAS system volume, but it can be used as a NAS user volume.

## Hitachi Parallel Access Volume (HPAV)

To use the mapped external LU with Hitachi Parallel Access Volume operations, set the **IO Suppression** mode to **Disable**.

## Hitachi SANtinel - S/390®

To use the mapped external LU with LDEV Security operations, set the **IO Suppression** mode to **Disable**.

## LUN Security XP Extension

To use a mapped external LU with LUN Security XP Extension operations, set the **IO Suppression** mode to **Disable**.

## Configuration File Loader function

You cannot set the CHA mode, port, host group, or WWN for the external LU.

---

# Preparing for External Storage XP operations

This section describes preparations required before using External Storage XP. Topics include:

- ["Configuring MSA1000/1500 as external disk arrays"](#) on page 769
- ["Installing External Storage XP"](#) on page 772
- ["Uninstalling External Storage XP"](#) on page 772
- ["Preparations for External Storage XP settings"](#) on page 772
- ["Powering on and off disk arrays"](#) on page 774

## Configuring MSA1000/1500 as external disk arrays

### Connecting MSA1000/1500

If you connect an HP StorageWorks Modular Smart Array (MSA) with two controllers as an external disk array (highly recommended), set the port's host mode to Tru64 and use Selective Storage Presentation.



**NOTE:** If only a single MSA controller will be known to the XP12000, then the use of Selective Storage Presentation in the MSA ACU is optional and the host mode may be set to Windows. For the purposes of this document, it will be assumed that two MSA controllers are in use, which greatly improves its degree of High Availability and allows for the storage of primary copies of important data to reside on the MSA.

---

See the following documents for information about configuring MSA:

- *HP StorageWorks Modular SAN Array QuickSpecs*
- *HP StorageWorks Modular SAN Array User Guide*



**NOTE:** References to MSA generally refer to both the MSA1000 and the MSA1500 (both with an active/passive controller). Although the standby MSA controller may connect to the same XP12000 port as the active MSA controller (shown below), HP recommends that it connect to an XP port on a different XP cluster.

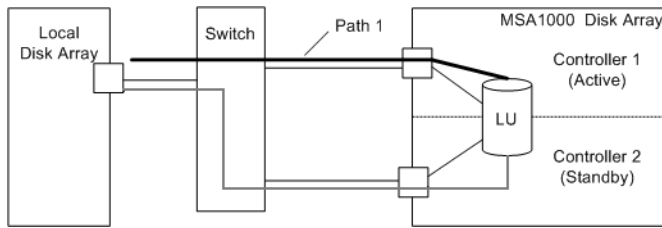

**Figure 400** Example: Connecting an MSA disk array

The following is a summary of the port setting status of the local disk array when you connect the MSA external disk array.

Topology	Fabric ON	Fabric OFF
Loop	Supported	Supported
Point-to-Point	Supported	Not supported

## Setting up the MSA

To set up the MSA for use as an external disk array connected to the XP12000, perform the following steps:

1. Define the MSA Array Object.
2. Define the MSA LU.
3. Use Selective Storage Presentation to institute LUN security.

After defining the MSA array object, specify individual storage LUs within the array object. At this point, institute LUN security on the MSA using the ACU Selective Storage Presentation (SSP) functionality.

Use the HP StorageWorks Array Configuration Utility (ACU) to configure the MSA for its role as an external array. ACU runs from a server attached to the MSA via a Fibre Channel path.

The MSA Disk Array does not require any special firmware level or hardware additive to be usable by External Storage XP as long as the firmware level in use supports the appropriate host mode setting (for example, Windows or Tru64).



**NOTE:** Download the ACU and *ACU Online User's Guide* from the following address:  
<http://h18004.www1.hp.com/products/servers/proliantstorage/software-management/acumatrix/index.html>



## Defining MSA array objects

Use the Array Configuration Utility (ACU) to define at least one internal MSA array object (for instance, "A") when first setting up the array. After defining an array object, specify LUs within that array object.

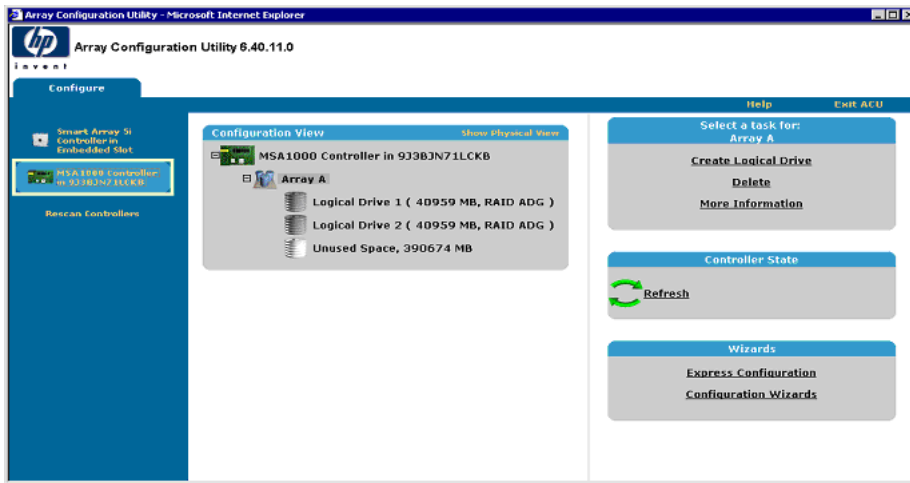

Figure 401 Defining MSA array objects with the ACU

## Calculating MSA LU size and defining LUs

The ACU used for configuring the MSA uses an optimization algorithm to calculate the user size of a new LU given a user-specified size in MB (Figure 402). Because you cannot bypass or disable the optimization algorithm, you must compensate for this optimization so that MSA LUs are created at the correct size. When requesting a new LU through the ACU, make the request 2 to 3 MB larger than needed for presentation to the XP12000. For example, suppose you want to create a 40 GB (40960 MB) LU on the MSA for use as XP12000 external storage. If you request only the exact size needed, the ACU optimizes the LU to a size of 40959 MB, which is 1 MB smaller than needed. In this case, the optimization algorithm the ACU uses can be compensated for by specifying a size of 40963 MB, which results in the correct size of 40960 MB (40 GB).

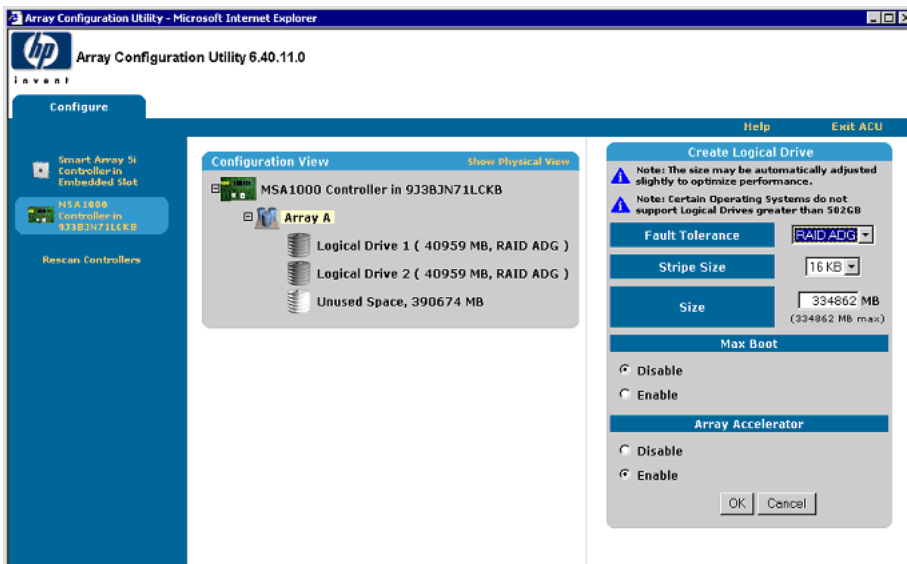

Figure 402 Defining MSA LUs with ACU

## Selective Storage Presentation

You must institute LUN security on MSAs using the ACU Selective Storage Presentation (SSP) feature (Figure 403). Use SSP to limit access to individual MSA LUs (in this case, logical drives 1 and 2) by selected host (or XP12000) HBA world wide names. When using SSP, set the operating system mode

corresponding to the XP12000 array port WWN to TRU64. For more information about configuring the MSA using the ACU, see the ACU Online User's Guide.

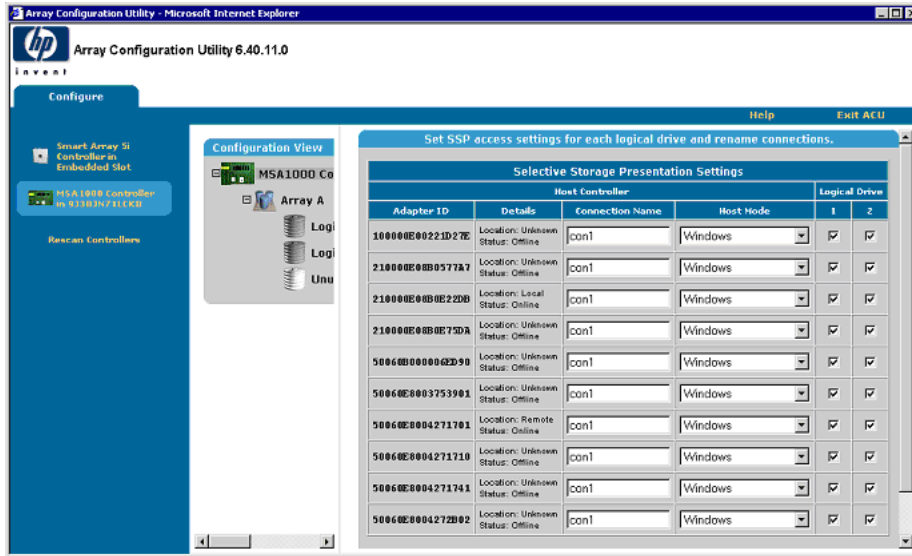

Figure 403 Configuring SSP with ACU

## Installing External Storage XP

To perform External Storage XP operations with Command View, install an External Storage XP license key. For further information, see page 75.

## Uninstalling External Storage XP

To uninstall External Storage XP, cancel any existing Flex Copy copy pairs, and delete any external LU mappings using the following procedure:

1. Log in to Command View. For instructions, see page 39.
2. In the Device Launcher pane, select the disk array. The disk array Identity pane appears. Ensure that you are in Modify mode (for details, see page 98).
3. Cancel any existing Flex Copy pairs (for instructions, see page 752).
4. Delete any external LU mapping (for instructions, see page 813).
5. Use the Command View XP Licensing module to remove the Flex Copy license key.
6. For XP12000, use the Command View XP Licensing module to remove the External Storage license key.

## Preparations for External Storage XP settings

Before using External Storage XP, collect information necessary for defining its settings. You must define the following:

- XP12000 ports that can be set to an **External** designation (page 773)
- External disk array(s) and the LUs to be mapped to the internal XP LDEVs (page 773)
- External LU groups (page 773)
- Configuration of external LU attributes (page 773)
- Alternate paths (page 758)

## External port attributes

The local disk array port(s) used for External Storage XP must be set to a designation of **External**. When the external disk array is connected to the port of the local disk array via Fibre Channel, you can view information about the external disk array from Command View XP on the XP12000. The external disk array can be connected only to ports designated as **External**.

To set the port attribute to **External**, release any existing paths currently configured for the port. (If any paths are still set to a port, its attribute cannot be changed to **External**.) Before starting External Storage XP operations, you must know which ports you can change to **External**.



**NOTE:** Ports with attributes set for remote copy software (such as **RCU Target** or **Initiator**) or other features cannot be used as external ports for External Storage XP. If the port attribute is set to something other than **External**, change its attribute to **External**. Flex Copy XP and External Storage XP can share an XP12000 port with an attribute of **External**.

For instructions on setting attributes, see “[Setting port attributes on the local disk arrays](#)” on page 790.

## Mapping external LU information

When connecting an external disk array to a port with an External designation, LUs in the external disk array can be mapped as LDEVs in the local disk array. Verify which LUs in which external disk array may be mapped as internal XP LDEVs.

You can map only one external LU to a given internal LDEV and map up to 1,024 external LUs per local disk array port.

For instructions on mapping external LUs, see page 791.

## Using external LU groups

When mapping an external LU as an internal XP LDEV, register the external LU in an external LU group.

You can classify external LUs into groups according to their use. These groups are called *external LU groups* (**ExG**). For example, register several LUs in an external disk array in one external LU group. Or, if data you want to manage in a chunk is stored in LUs in various external disk arrays, register those LUs in a single external LU group and manage them as a block.

You must assign a number from 1 to 16,384 to each external LU group. You can create up to 16,384 external LU groups and register up to 256 external LUs in a single external group.

For instructions on mapping external LUs as internal XP LDEVs, see page 791.

## External LU attributes set by mapping

When mapping an external LU as an internal XP LDEV, set the attributes of the external LU using the Add LU panel in External Storage XP. For instructions, see page 791.

The following are the attributes of the external LU:

- Emulation type

Set the emulation type of the mapped LU by selecting any emulation type from the drop-down list. However, if you plan to use the mapped LU for Flex Copy operations, or you plan to access existing data in the external LU, select the OPEN-V emulation type to avoid data resizing.

If you select an emulation type other than OPEN-V, additional space is taken for XP management information. This means that after mapping, LU capacity is less than the actual external LU capacity (and the original data must be considered lost). For detailed information on volume capacity, see page 767.

- **IO Suppression mode (Enable or Disable)**

When mapping an LU, determine whether to suppress I/O operations from hosts (via the XP12000) to the mapped external LU.

- If you select **Enable**, the mapped LU can be used for Flex Copy operations only.
- If you select **Disable**, a host connected to the XP12000 can use the mapped external LU as if it were an LU inside the local disk array, but you cannot use the LU for Flex Copy operations.

- **Cache Mode (Enable or Disable)**

Determines whether host I/O operations use cache.

- If you select **Enable** (recommended for External Storage XP), host write I/O operations go to the XP12000 cache and then to the LU, if necessary.
- If you select **Disable**, host write I/O operations go directly to the external LU cache (they do not use the XP12000 cache).
- When **IO Suppression** mode is set to **Enable**, **Cache Mode** changes by default to **Disable**.
- If you use an external LU and set **Cache Mode** to **Disable** for Cache LUN XP operations, you cannot use the XP12000 Cache LUN XP Bind mode.



**NOTE:** While the longer data path for External Storage XP potentially exacts a performance toll on reads from external storage, you may be able to construct 'bursty' write scenarios in which writes to external LU cache actually complete quicker than writes to regular internal XP12000 disks.

---

## Powering on and off disk arrays

This section describes procedures for turning the power on or off at the local disk array and the external disk array after External Storage XP operations have begun.



**CAUTION:** The **Disconnect Subsystem** command is not supported for this version. Wherever this section mentions execution of the **Disconnect Subsystem** command, please execute the **Disconnect Volume** command for each volume of the external subsystem.

---

- To power off both the local disk array and external disk array, power off the local disk array, and then power off the external disk array.
- To power on both the local disk array and external disk array, power on the external disk array, and then power on the local disk array.

These procedures use the following commands:

- **Disconnect Subsystem**

Use the **Disconnect Subsystem** command when you need to perform maintenance or stop the local disk array or external disk array. This command cancels acceptance of all host I/O operations to the external LU mapped as the internal XP LDEV. All outstanding data in cache memory on the local disk array intended for the external LU is written (de-staged) to the external LU.

For instructions on executing the **Disconnect Subsystem** command, see page 810.



---

**NOTE:** The maximum number of volumes that can be operated by the **Disconnect Subsystem** command or the **Disconnect Volume** command is 256.

---



**NOTE:** Whereas the **Re-prioritize** command can be used to redirect IO between multiple FC paths to the same external array controller, the **Disconnect Paths** command should be used to redirect IO from one external controller to another (within the same array).

---



**NOTE:** To disconnect an individual LU, use the **Disconnect Volume** command. To cancel the mapping of a single external LU, use the **Disconnect Volume** command and then the **Delete LU** command. For instructions on deleting external LU mappings, see page 813.

---

- **Check Paths & Restore Vol.**

This command verifies that the saved information regarding the mapped external LU matches the actual external LU status. If it is verified that the external LU can still be used as the mapped local disk array LDEV, the external LU is then allowed to accept I/O operations, and you can resume using the external LU as a mapped LU.

Use this command to re-enable host I/O operations to a mapped external LU after disabling those operations using either the **Disconnect Subsystem** or **Disconnect Volume** command. You may use the **Check Paths & Restore Vol.** command to reestablish I/O traffic to an entire disk array or an individual LU.

If an error occurs in the external storage path such that the command fails, correct the error so the path can be restored, and execute the **Check Paths & Restore Vol.** command again.

For instructions on executing the **Check Paths & Restore Vol.** command, see page 812.

---



**NOTE:** When executing the **Check Paths & Restore Vol.** command, if the external LU is ready to be restored as the mapped LU, the external LU is set to **Available**. However, if the external LU is not ready to be restored, the external LU status remains as **Blocked**.

---



**NOTE:** When executing the **Check Paths & Restore Vol.** command, if the external LU is ready to be restored as the mapped LU, the external LU is set to accept the I/Os and you can resume using the external LU as a mapped LU. However, if the external LU is not ready to be restored, the external LU status remains as **Blocked**.

---



**CAUTION:** To use the mapped external LU again after executing the **Disconnect Subsystem** command, execute the **Check Paths & Restore Vol.** command.

---

## Powering off the local disk arrays



**CAUTION:** The **Disconnect Subsystem** command is not supported for this version. Wherever this section mentions execution of the **Disconnect Subsystem** command, please execute the **Disconnect Volume** command for each volume of the external subsystem.

1. Stop all read and write I/O operations to external LUs.
2. Execute the **Disconnect Subsystem** command for the external disk array containing the mapped external LU (page 810).  
All subsequent I/O operations to the external LU are stopped and all data in the local disk array cache memory is written (de-staged) to the external LU.
3. Perform any other operations that are required before turning off the local disk array.
4. Turn off the local disk array power supply.

## Powering off external disk arrays

1. Stop all read and write I/O operations to external LUs mapped as a local disk array internal XP LDEV and located in the external disk array you want to turn off.
2. Execute the **Disconnect Subsystem** command for the external disk array (page 810).  
All subsequent I/O operations to the external LU are stopped and all data in the local disk array cache memory is written (de-staged) to the external LU (all data is destaged).
3. Perform any other operations that are required before turning off the external disk array.
4. Turn off the external disk array power supply.

## Powering on local disk arrays or external disk arrays

1. Power on the external disk array.
2. Power on the local disk array.
3. Execute the **Check Paths & Restore Vol.** command (page 812) to resume using an external LU that has been disconnected using the **Disconnect Subsystem** command but where mapping information still exists.

---

## External Storage XP operations

To use External Storage XP, you may also need to work with the **LU Operation**, **Port Operation**, and **Flex Copy** tabs. Selecting a tab displays its corresponding pane.

This section includes the following topics:

- ["Starting External Storage XP operations"](#) on page 776
- ["LU Operation pane"](#) on page 777
- ["Port Operation pane"](#) on page 784
- ["Flex Copy for the XP128/XP1024/XP12000"](#) on page 703.

## Starting External Storage XP operations

1. Log in to Command View. For instructions, see page 39.
2. In the Device Launcher pane, select an XP12000 disk array. The disk array Identity pane appears.

3. Change to Modify mode (for instructions, see page 98).
4. Click the **External Storage** button (  ). The LU Operation pane appears.

## LU Operation pane

This pane, which appears when you start External Storage XP, displays information about external storage devices. From this tab, you can start operations such as mapping external LUs and setting alternate paths.

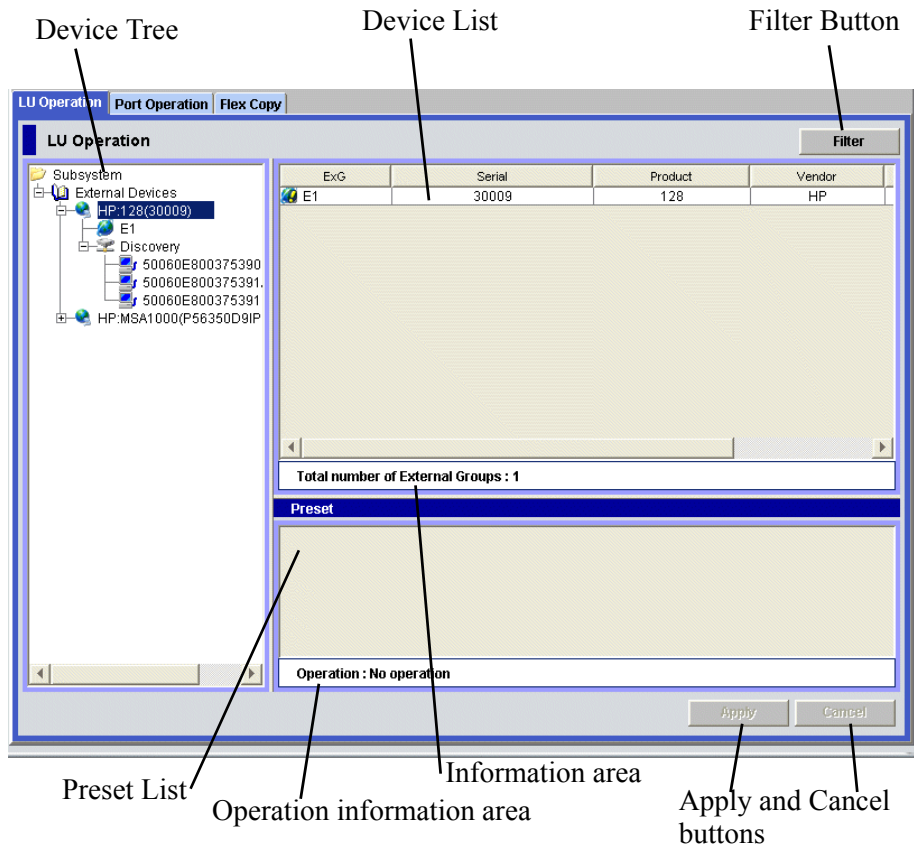

**Figure 404** LU Operation pane

The **LU Operation** pane consists of the following items:

- **Device Tree**

The Device List (right pane) changes according to items selected in the Device Tree (left pane), including **Subsystems**, **External Devices**, device names of connected external disk arrays, external LU group numbers, **Discovery**, and external disk array WWNs. For detailed information, see page 778.
- **Filter** button
 

Displays the Filter window, where you can restrict items displayed in the Device List. For detailed information, see page 781.
- **Device List**

Displays information about the external disk array corresponding to item selected in the Device Tree. For detailed information, see page 779.
- **Information Area**

Displays information according to the contents of the Device List, including:

  - **Total Number of External LUs:** Number of external LUs connected.

- **Found WWNs:** WWNs found when you clicked **Discovery** in the Device Tree (left pane).
  - **Remain LUs:** Number of external LU numbers available (out of 15,360), other than those that have already been used.
  - **WWN Entry:** Number of LUs that are currently used in the external disk array out of the maximum theoretically possible (15,360).
- **Preset List**  
Displays the rows from the Device List that are about to be operated on. Contents displayed in the **Preset** list have not yet been applied to the local disk array. They are applied when you click **Apply**. For detailed information, see page 787.
  - **Operation Information Area**  
Displays operation information about settings shown in the **Preset** list, including:
    - **Operation:** Name of setting operation
    - **Number of Objects in Preset:** Number of rows displayed in the **Preset** list
  - **Apply** button  
Applies pending operations on rows displayed in the **Preset** list to the local disk array. When settings are applied successfully, they are removed from the **Preset** list. Otherwise, error messages appear and error settings remain displayed in the **Preset** list.
  - **Cancel** button  
Cancels all settings in the **Preset** list.

## Device Tree

The Device Tree (left pane) displays information about the external devices connected to the external port. The Device List (right pane) changes according to the item selected in the Device Tree.

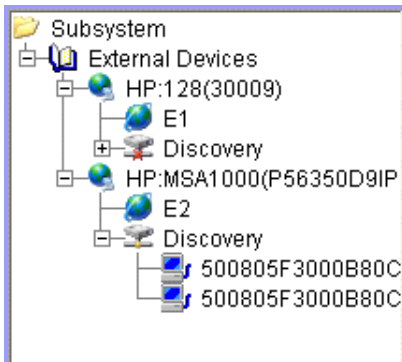

**Figure 405** Device Tree



**NOTE:** For a description of information displayed in the Device List, see page 779.

The Device Tree displays the following items:

- **Subsystem**  
When selected, the Device List displays the **External Devices** branch of the tree. **Subsystem** is selected when you start External Storage XP and display the **LU Operation** pane.



- **External Devices**

When selected, the Device List displays information about external disk arrays connected to external ports which have been detected.



**NOTE:** Not all types of detected external arrays are supported.

- Product name of connected external disk array

The name of the external disk array that can be connected using External Storage XP appears in the tree under **External Devices**. When you select the product name of the external disk array, the Device List displays detailed product information.

- **External LU group number**

These user-assigned numbers appear in the branch under the product name of an external disk array. When you click on the external LU group number, the Device List displays information about external LUs which you have predefined as being included in the selected group.

- **Discovery**

Appears in the branch under the product name of the external disk array connected to the local disk array. When you select Discovery, External Storage XP searches external disk array ports that can be connected, and displays their WWNs.

- **WWN of the external disk array port**

If (in the Device Tree) you click on the WWN of the external array port found by selecting **Discovery** in the Device Tree, the Device List displays information about external LUs that can be seen by way of that external array port.

## Device List

The Device List displays information about external disk arrays corresponding to the item selected in the Device Tree. You can sort the list by displayed items. For instance, to sort by LUN numbers, click **LUN** in the column header.

When performing setting operations, the settings appear in the Preset list and the corresponding row in the Device List appears in blue italics. For detailed information, see page 787.

WWN	LUN	Characteristic	Device	Capacity
<i>50060E8003F40B03</i>	00	00	DF600	0
<i>50060E8003F40B03</i>	01	01	DF600	0
<i>50060E8003F40B03</i>	02	02	DF600	0
<i>50060E8003F40B03</i>	03	03	DF600	0

**Figure 406** Sample Device List (WWNs of external array ports selected in the Device Tree)

The Device List varies according to items selected in the Device Tree.

**Table 146** Items appearing in the Device List

Item selected in Device Tree	Information displayed in Device List
Subsystem	Nothing. Subsystem is automatically selected when you start External Storage XP.
External Devices  (For example, the external storage group numbers currently defined for that external device.)	<p><b>Serial:</b> Product serial number.</p> <p><b>Product:</b> Product name.</p> <p><b>Vendor:</b> Vendor name.</p> <p><b>Status:</b> Status of external disk array. Possible values: <b>Warning, Checking, Cache Destage, Format, and Disconnect</b>. For a description of these values, see page 781.</p>
Product name of connected external disk array	<p><b>ExG:</b> External LU group number. This appears when you group the LUs from one or more external arrays under a common number.</p> <p><b>Serial:</b> Serial number of the storage product.</p> <p><b>Product:</b> Storage product name.</p> <p><b>Vendor:</b> Storage vendor name.</p> <p><b>Status:</b> Status of external disk array. Possible values: <b>Warning, Checking, Cache Destage, and Disconnect</b>. For a description of these values, see page 781.</p>
External LU group number	<p><b>Characteristics:</b> Identification number of external LU.</p> <p><b>Device:</b> Device name of external LU.</p> <p><b>Capacity:</b> Capacity of external LU, in 512-byte blocks.</p> <p><b>Alter. Path:</b> Number of configured paths, displayed in the format “The number of valid paths (the number of primary alternate paths)”.</p> <p><b>IO Suppression:</b> Status of IO Suppression mode: <b>Enable</b> or <b>Disable</b>. For details, see page 773.</p> <p><b>Cache Mode:</b> Status of Cache Mode: <b>Enable</b> or <b>Disable</b>. For details, see page 773.</p> <p><b>Path:</b> “*” indicates paths are set.</p> <p><b>Group:</b> External LU group number and reference number assigned to each LU in the external LU group. External Storage XP automatically assigns reference numbers of LUs in the group when external LUs are mapped. This appears in the following format: “external LU group number - reference number of the LU in the group”.</p> <p><b>Status:</b> Status of external disk array. Possible values: <b>Normal, Unknown, Blockade, Warning, Checking, Cache Destage, Format, and Disconnect</b>. For a description of these values, see <a href="#">Table 147</a>.</p> <p><b>Progress:</b> Displayed when Status is <b>Cache Destage</b>. Shows progress of destaging process, from 1% to 100%.</p>

**Table 146** Items appearing in the Device List (continued)

Item selected in Device Tree	Information displayed in Device List
Discovery	<p><b>WWN:</b> World Wide Name of a recognized external array port.</p> <p><b>Serial:</b> Serial number of the storage product.</p> <p><b>Product:</b> Storage product name.</p> <p><b>Vendor:</b> Storage vendor name.</p>
WWN of external disk array port	<p><b>LUN:</b> LU number.</p> <p><b>Characteristic:</b> ID number of external LU.</p> <p><b>Device:</b> Device name of external LU.</p> <p><b>Ex-Dev. info.:</b> Information about external disk array. When the external disk array is an SATA/FATA drive, "*" is displayed.</p> <p><b>Capacity:</b> Capacity of the external LU.</p>

**Table 147** Possible values of LU status

LU Status	Description
Warning	Some alternate FC paths are blocked.
Checking	External Storage XP is verifying configuration information defined for FC paths.
Cache Destage	External Storage XP is writing all data in the XP12000 cache memory to the LU.
Disconnect	Connection to external disk array or external LU was interrupted intentionally using the <b>Disconnect Subsystem</b> or <b>Disconnect Volume</b> command.
Format	LU is in the process of being formatted.

## Filter button

Displays the Filter window where you can restrict LUs displayed in the Device List.

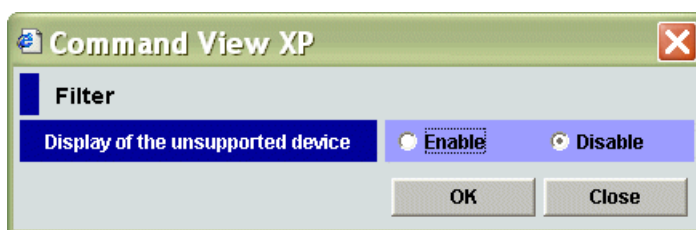

**Figure 407** Filter window

This window contains **Enable** and **Disable** options that control the display of unsupported devices. When you select **Enable**, information about unsupported disk arrays appears in the Device Tree and Device List. Unsupported disk arrays are indicated by **Unknown Devices** in the Device Tree and Device List.

The **Disable** option is selected by default.

## Preset List (LU Operation pane)

This list displays the Device List rows which are about to be acted upon. You can apply settings to the local disk array after checking the contents in the **Preset** list. Information displayed in the **Preset** list appears in blue italics in the Device List. If you click **Apply** in the **LU Operation** pane, settings displayed in the **Preset** list are applied to the local disk array. At that point, the contents of the **Preset** list disappear and the Device List appears normally.

If you click **Cancel** in the **LU Operation** pane, all settings in the **Preset** list are canceled.

If settings in the **Preset** list contain errors, they are not applied to the local disk array even if you click **Apply**. In that case, error messages appear and incorrect settings appear in the **Preset** list. In addition, error codes appear in the **Preset** list.



**NOTE:** Depending on the type of errors that occur, identical error codes might be displayed for all errors listed in the **Preset** list. In this case, check the status of settings to identify the source of the error.

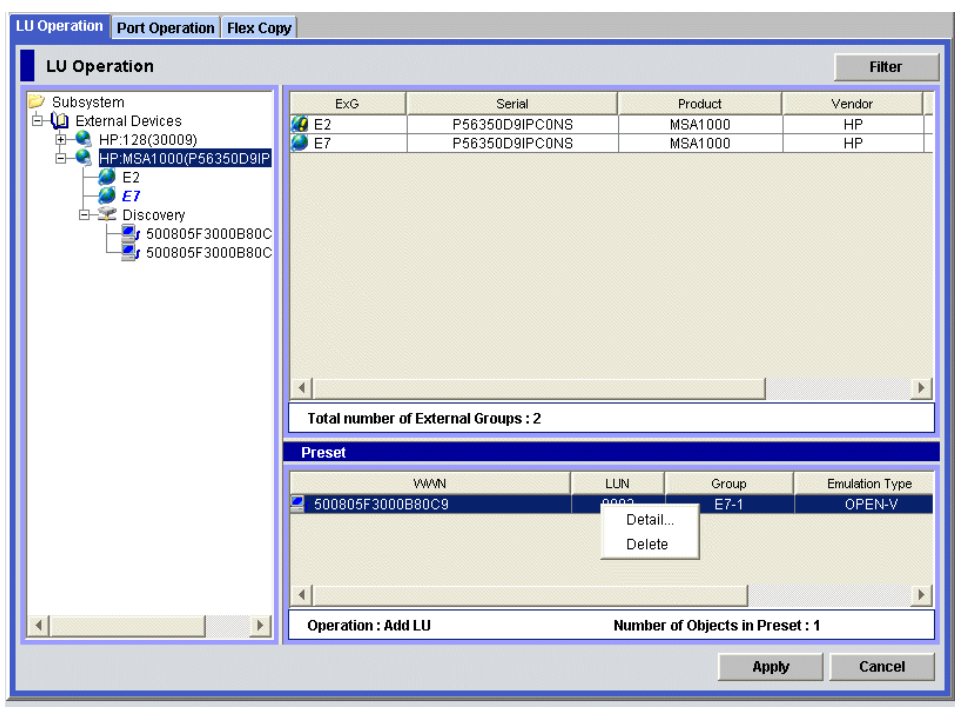
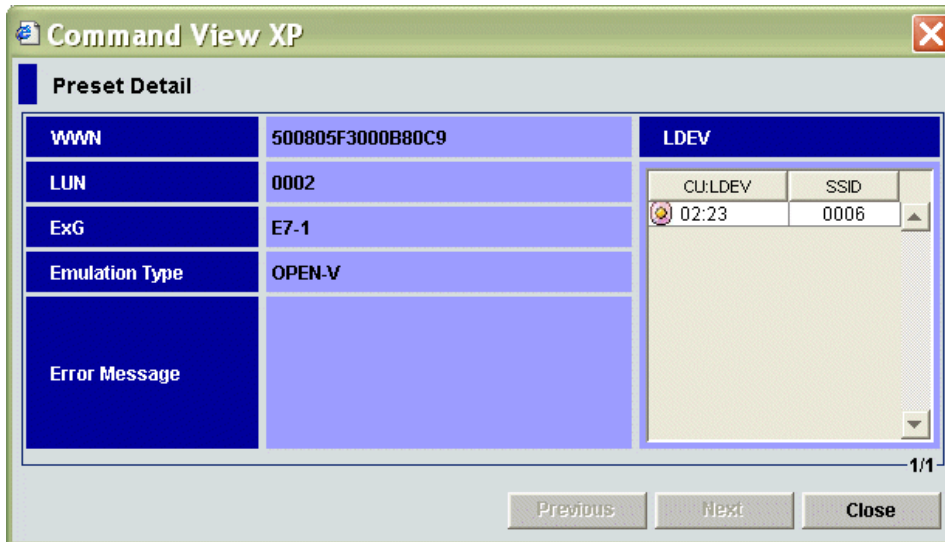

Figure 408 Preset status of the LU Operation pane

When you select and right-click an item in the **Preset** list, the following commands appear:

- **Detail**

Displays the Preset Detail window with further information about settings selected in the **Preset** list. When an error code appears in the **Preset** list, a corresponding error message appears in this window.



**Figure 409** Preset Detail window (Mapping Operation)

- **Delete**

Settings selected in the **Preset** list are canceled.

## Port Operation pane

Use this pane to check port settings and set port attributes. This section describes items displayed in the pane. For instructions on setting port attributes, see page 790.

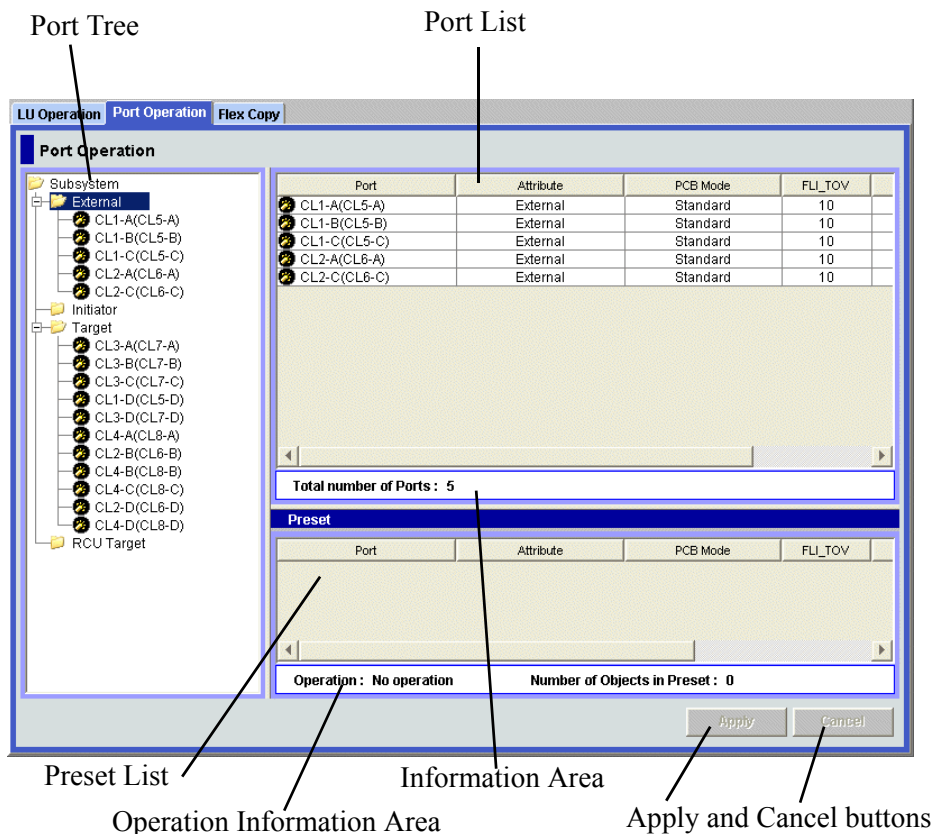

**Figure 410** Port Operation pane

The Port Operation pane consists of the following items:

- **Port Tree**

When you select a port in the Port Tree (left pane), the corresponding port information is displayed in the Port List (right pane). You can select Subsystem, a port attribute, or a port number. For detailed information, see page 785.

- **Port List**

Displays detailed information about the port or port(s) selected in the Port Tree. For detailed information, see page 786.

- **Information Area**

Displays the total number of ports currently detailed in the Port List (**Total Number of Ports**).

- **Preset List**

Displays the rows corresponding to the ports which are about to be acted upon. If you click **Apply** on the Port Operation pane, of the actions designated in the **Preset** list are applied to the local disk array. For detailed information, see page 787.

- **Operation Information Area**

Displays operation information about settings displayed in the **Preset** list.

- **Apply** button

Applies actions designated in the **Preset** list to the local disk array. When actions are applied without error, they are removed from the **Preset** list. If errors occur, settings are not applied, error messages appear, and error settings remain in the **Preset** list.

- **Cancel** button

Cancels all settings in the **Preset** list.

## Port Tree

This tree displays ports in the local disk array. Contents displayed in the Port List (right pane) vary according to the item selected in the Port Tree (left pane).

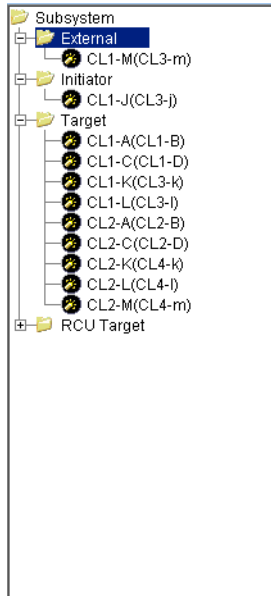

**Figure 411** Port Tree

The Port Tree displays the following:

- **Subsystem**

When selected, displays information about all ports under Subsystem (the local array).

- **External**

When selected, displays ports designated as external, which is the port attribute used for External Storage XP. Ports designated as **External** do not have High Speed mode.

- **Initiator**

When selected, displays ports designated as an initiator (sending) port (used for Continuous Access XP (CA), TrueCopy - S/390, and so on).

- **Target**

When selected, displays ports designated as host target ports (used for host connect).

- **RCU Target**

When selected, displays ports designated as an RCU target (receiving) port (used for Continuous Access XP (CA), TrueCopy - S/390, and so on).

- **Port number**

Ports, which are assigned to each port attribute, appear in the branch below each port attribute. External Storage XP utilizes ports set to external.

## Port List

This list displays port information corresponding to the item selected in the Port Tree. You can sort the list by attribute. For instance, to sort by port numbers, click **Port** on the list.

The rows corresponding to the ports that are about to be acted upon appear in the **Preset** list and the corresponding row in the Port List appears in blue italics.

Port	Attribute	PCB Mode	FLI_TOV	PLI_TOV	Margin
<i>CL1-G</i>	<i>External</i>	<i>Standard</i>	-	-	-
CL2-E	External	Standard	10	5	0
CL2-F	External	Standard	10	5	0
CL2-H	External	Standard	10	5	0

**Figure 412** Port List

The Port List displays the following items:

- **Port**

Port number.

- **Attribute**

Port attribute. External ports are used for connecting to the external disk array.

- **PCB Mode**

PCB mode of the port. Ports designated as **External** do not have High Speed mode.

- **FLI\_TOV (Fabric Login Timeout Value)**

Maximum time allowed (in seconds) for an external array to perform a fabric login after being connected to a switch. This value is preset and cannot be changed.

- **PLI\_TOV (Port Login Timeout Value)**

Maximum time allowed (in seconds) for the external array to perform a port login after being connected. This value is preset and cannot be changed.

- **Margin**

The sum of the FLI\_TOV and PLI\_TOV values.



## Preset List (Port Operation pane)

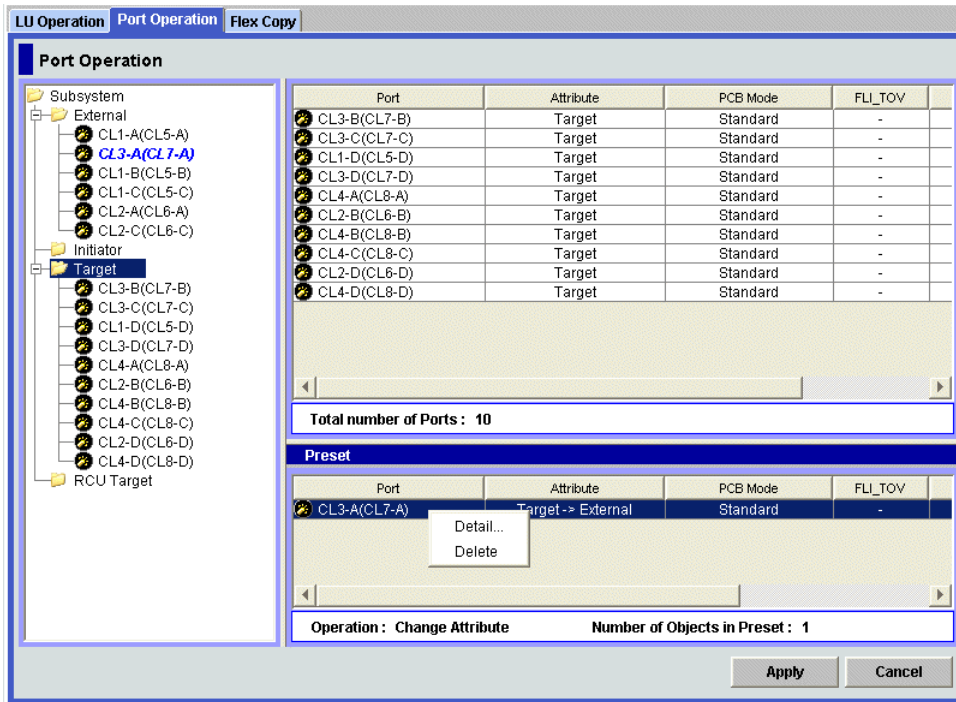

**Figure 413** Preset status of the Port Operation pane

This list displays rows from the Port List that are about to be acted on. Check the contents of the **Preset** list before applying them to the local disk array. Contents displayed in the **Preset** list appear in blue and italics in the Port List. When you click **Apply** in the Port Operation pane, actions designated in the **Preset** list are applied and the contents of the **Preset** list disappear.

If you click **Cancel** in the Port Operation pane, all designated actions in the **Preset** list are canceled.

If settings in the **Preset** list contain errors, actions are not applied to the local disk array even if you click **Apply**. In that case, error messages appear, incorrect settings appear in the **Preset** list, and error codes appear in the **Preset** list.

When you select and then right-click a setting in the **Preset** list, the following commands appear:

- **Detail**

Displays the Preset Detail window with detailed information about actions selected in the **Preset** list. When an error code appears in the **Preset** list, a corresponding error message appears in the Preset Detail window.

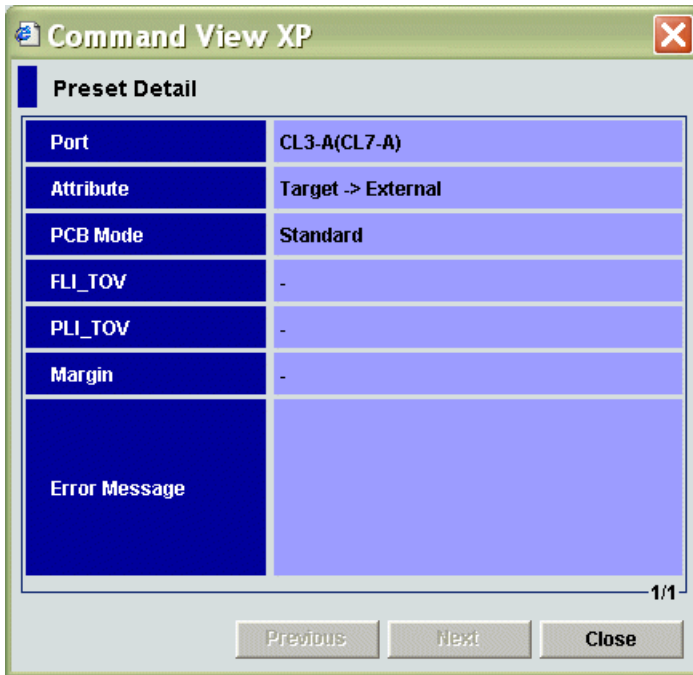

**Figure 414** Preset Detail window (changing port attribute)

- **Delete**

Cancels actions selected in the **Preset** list.

---

## Configuring external LUs

To use external storage devices connected to the local disk array, configure the connection to the external LU. This involves setting port attributes on the local and/or external arrays, mapping external LUs, and setting alternate paths. This section describes these operations, including:

- ["Overview of steps required to define external LUs"](#) on page 789
- ["Configuring external disk array LUs, host mode, and ports"](#) on page 790
- ["Setting port attributes on the local disk arrays"](#) on page 790
- ["Mapping external LUs"](#) on page 791
- ["Setting alternate paths"](#) on page 800
- ["Checking External Storage XP volume status \(LDEV Information\)"](#) on page 806
- ["Disconnecting external disk arrays or external LUs"](#) on page 810
- ["Checking connection status and resuming external LU operations \(Check Paths & Restore Vol.\)"](#) on page 812
- ["Deleting external LU mappings \(Delete LU\)"](#) on page 813

# Overview of steps required to define external LUs

Before using External Storage XP, define the external LUs and internal XP LDEVs.

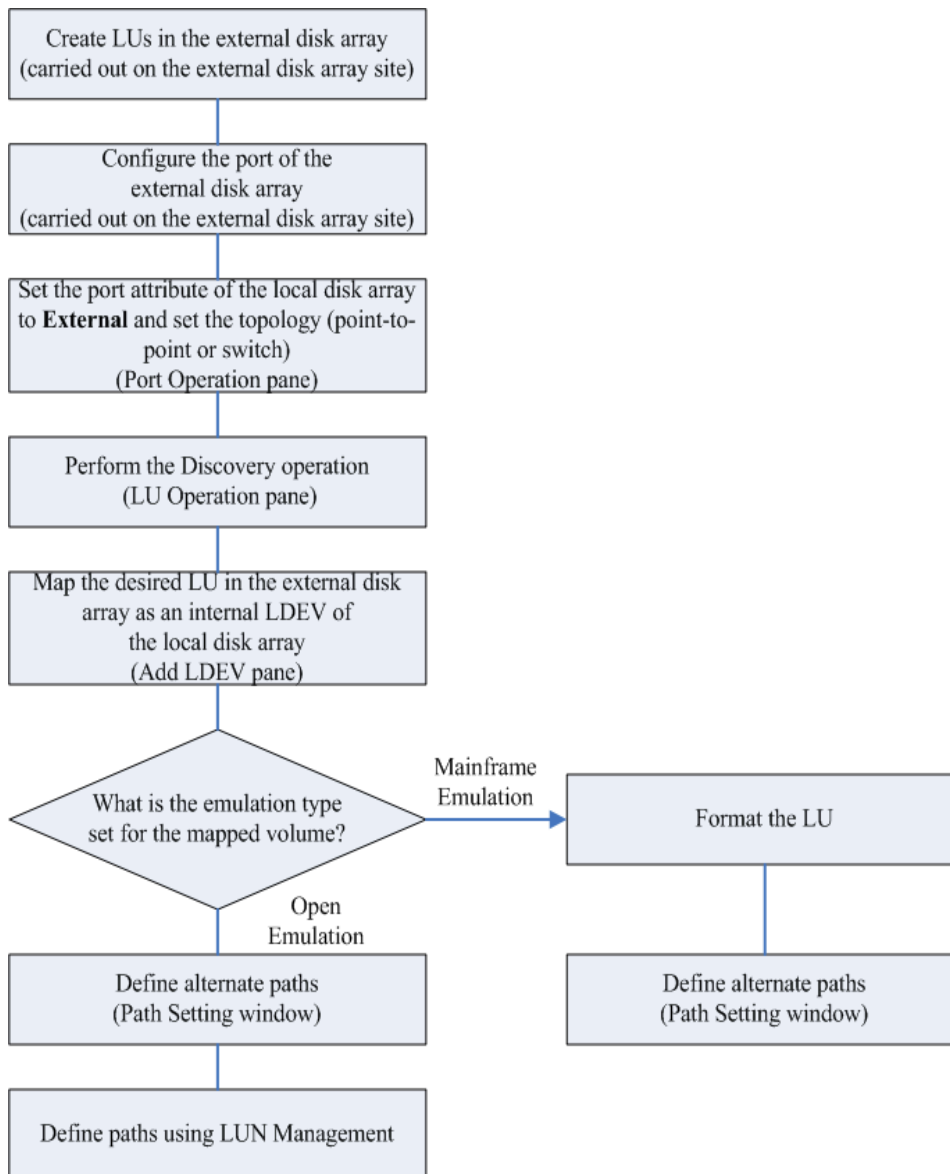

**Figure 415** Tasks required before using external LUs

The following is the general procedure for tasks required before performing External Storage XP operations. For detailed instructions see subsequent sections.

1. Configure LUs, ports, and host modes on the external disk array (page 790).
2. Start External Storage XP operations (page 776).
3. Set the external disk array port attribute to **External** (page 790).
4. Perform the **Discovery** operation on an external disk array (page 791).



**NOTE:** To perform the Discovery operation, Command View XP must be in **Modify** mode.

5. Map the external LU as an internal XP LDEV (page 791).
6. For mainframe emulation types, use CVS to resize the volume (page 241).

7. Define alternate paths between the external disk array and the local disk array (page 803).
8. Use LUN Management to define paths (page 179).

## Configuring external disk array LUs, host mode, and ports

This section describes how to configure the MSA external disk array. For other disk arrays, see the documentation for that external disk array. For further information on configuring the MSA as an external disk array, see page 769.

You do not need to configure the SAN topology parameters on the MSA disk array. The MSA automatically detects whether it is connected to the local disk array via a switch or point-to-point connection, and adjusts its parameters accordingly.

If no LUNs are available on the MSA, you must create them.

1. Set the channel transfer speed according to the configuration.  
Generally, select **Auto Negotiation**.
2. Use Selective Storage Presentation to configure the MSA LUs involved with External Storage XP.

## Setting port attributes on the local disk arrays

The attribute of any port used for External Storage XP must be set to **External**.

1. Click the **Port Operation** tab on the XP12000.
2. In the Port List, select the port.  
To set several ports at one time to **External**, select all the ports.
3. Right-click, and select **Change to External**.

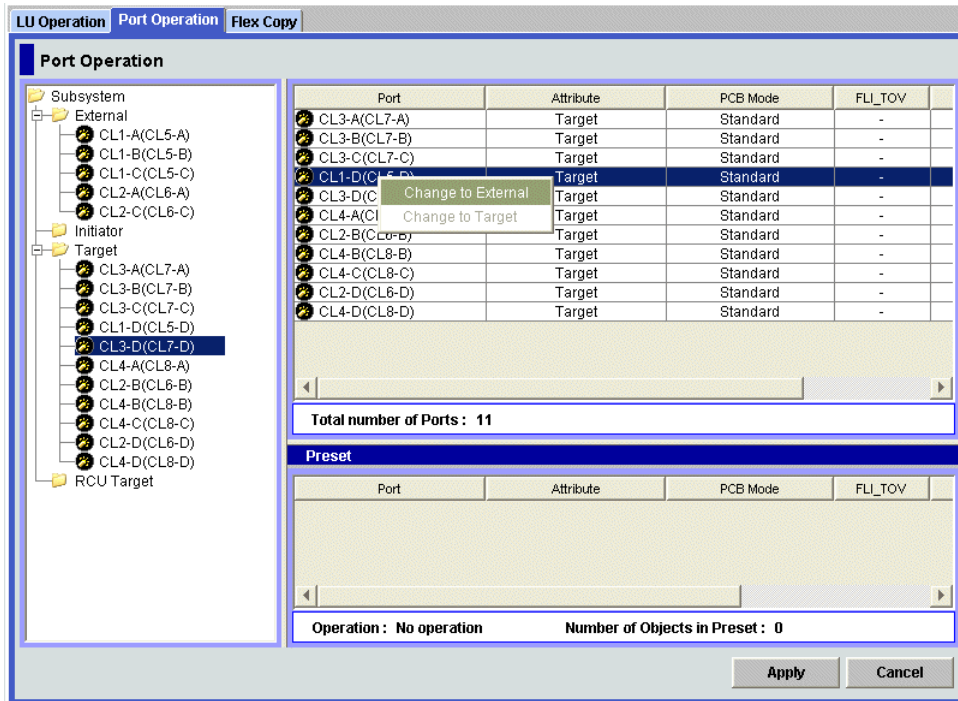

**Figure 416** Change to External Operation

In the Port List, the attribute of the selected port changes to **External**, and the row of the selected port appears in blue italics. The rows to be affected appear in the **Preset** list. To check setting details, select the setting in the **Preset** list, right-click, and select **Detail**. To cancel settings, select the setting in the **Preset** list, right-click, and select **Delete**.

4. Click **Apply**. A confirmation message appears.

5. Click **OK**.

The setting of the port attribute is applied to the local disk array, and the new setting appears in the Port List.

If an error occurs, the failed setting appears in the **Preset** list and an error code appears.

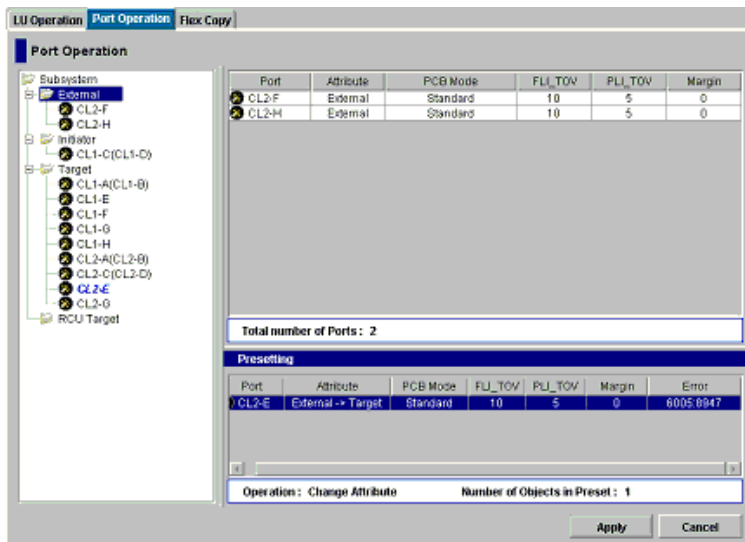

**Figure 417** Error when changing port attribute

To view error messages, select the failed row, right-click, and select **Detail**.

6. Set the topology according to the connection type.

- When a switch is connected, set the topology to Fabric ON + Point to Point.
- When a point-to-point connection is used, set the topology to FC\_AL and AL\_PA.

For further information, see "[Setting the Fibre Channel Topology](#)" on page 219.

7. Set the channel transfer speed to **Auto Negotiation**.

## Mapping external LUs

After setting the port used for External Storage XP to **External**, map the external LU as an internal XP LDEV. There are two ways to map external LUs:

- Manually via the **Add LU** command (page 797). This method displays the Add LU window (page 792).
- Automatically map several external LUs at one time via the **Add LU (AUTO)** command. This method displays the Auto Map Setting window (page 794) and the Select LDEV window (page 796).

## Add LU window

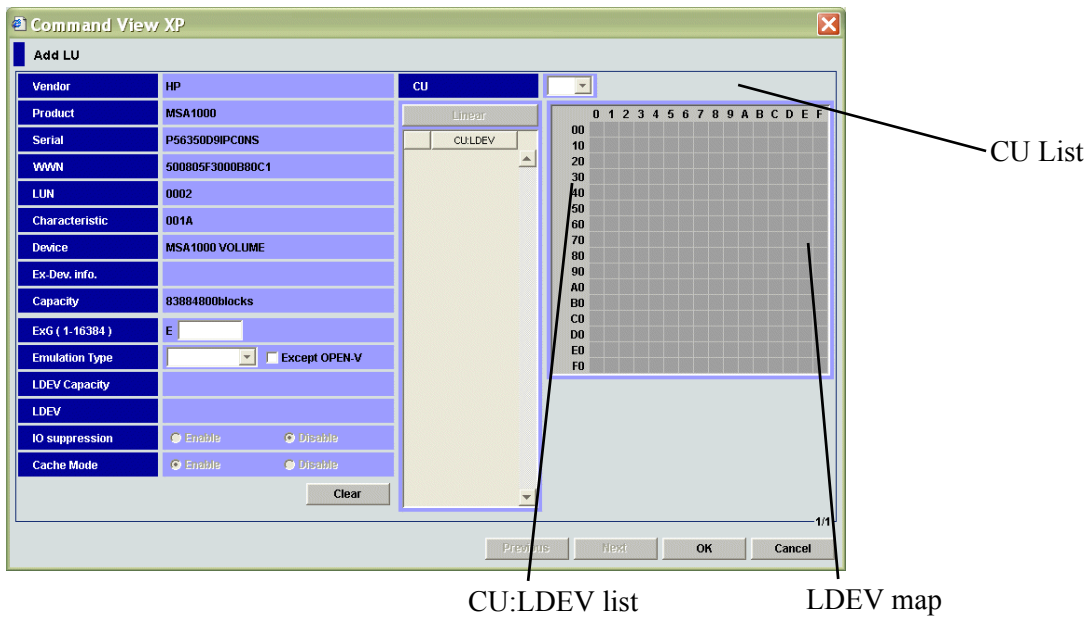

**Figure 418** Add LU window

The Add LU window presents the following information:

- **Vendor**  
External disk array vendor
- **Product**  
External disk array product name
- **Serial**  
External disk array serial number
- **WWN**  
Worldwide name of the external array port used for connecting to the local disk array
- **LUN**  
LU number of the external volume
- **Characteristic**  
External LU identification number
- **Device**  
External LU device name
- **Ex-Dev. info.**  
External disk array information. When the external disk array is a SATA/FATA drive, "\*" is displayed.
- **Capacity**  
Capacity of the external LU, in blocks

- **ExG (1-16384)**

Group number of connected external LUs. You can specify any decimal value from 1 to 16384. The **E** displayed outside the text box is the capital letter of the external LU group.

- **Emulation Type**

The emulation type of connected external LU (from the XP12000 perspective). To map the external LU as an open system volume, define the emulation type to use for the mapped LU as **OPEN-V** or another type. To map the external LU as an open system LU using an emulation type other than **OPEN-V**, select the **Except OPEN-V** check box. Other emulation types appear in the list.

If you plan to use the mapped external LU as part of a Flex Copy pair, you must specify **OPEN-V**.

- **LDEV Capacity**

Default capacity of emulation type selected in the **Emulation Type** box. When capacity of the external LU is larger than capacity displayed in **LDEV Capacity**, the external LU is divided into an appropriate multiple of LDEVs equal to the size displayed.

- **LDEV**

Number of LDEVs created based on the capacity supported by the emulation type specified in the **Emulation Type** box.

- **IO Suppression**

**IO Suppression** mode of mapped external LU (for **OPEN-V** emulation only). To suppress I/O operations from hosts (by way of the XP12000) to the mapped external LU or use the mapped external LU as part of a Flex Copy pair, select **Enable**.

If you do not want to suppress I/O from hosts to the mapped external LU, select **Disable** (for example, for use with External Storage XP). If you set emulation type to something different than **OPEN-V**, **I/O Suppression** mode is set to **Disable** automatically.

- **Cache Mode**

Specifies whether I/O operations use the XP12000 cache memory when host I/O is performed. If you select **Enable**, the host I/O goes to the XP12000 cache and then to the external LU cache (if necessary). If you select **Disable**, the host I/O goes directly to the external LU and ignores the XP12000 cache.

If you set the **IO Suppression** mode to **Enable**, the **Cache Mode** is set to **Disable** automatically. For External Storage XP, it is recommended to set **Cache Mode** to **Enable**.

- **CU list**

CU number of the local disk array to which the external LU is mapped. Select the CU number from the list.

- **Linear** button

Maps all external LUs listed in the **CU:LDEV** list at one time. When you click this button and then select an internal XP LDEV on the LDEV map, the system selects in the LDEV map the same number of internal XP LDEVs as the number of external LUs listed in the **CU:LDEV** list, starting at the internal XP LDEV you selected. The LDEV numbers of the selected internal XP LDEVs are sequential. If you want to map one external LU to another internal XP LDEV after having mapped the external LU automatically using the **Linear** button, first release the **Linear** button, and then map the external LU individually.

**CU:LDEV** list

Displays the XP12000 **CU:LDEV** numbers of the external LUs mapped as internal XP LDEVs. **"(N/A)"** (Not Assigned) means the external LUs are not yet mapped as internal XP LDEVs. To map an external

LU as an internal LDEV, select an external LU with **(N/A)** in the **CU:LDEV** list. To map all external LUs in the **CU:LDEV** list at one time, use the **Linear** button.

- **LDEV** map

Each cell in the map represents an internal XP LDEV. Select a cell for the internal XP LDEV on the map. The selected cell turns blue, and the selected LDEV is mapped to the external LU. Internal XP LDEVs that have been mapped appear in gray, while those not yet mapped appear in white.

- **Previous** and **Next** buttons

If you select several external LUs in the Device List, click **Previous** to map the external LU in the row just *above* the currently selected external LU. Click **Next** to map the external LU in the row just *below* the currently selected external LU.

- **OK** button

Displays the SSID window, where you can continue with the next step of the mapping operation. When the SSID setting is not necessary, the Add LU window closes, and the **LU Operation** pane appears.

The **OK** button is available when mapping on the Add LU window is complete.

- **Cancel** button

Cancels all mapping operations, closes the Add LU window, and returns to the **LU Operation** pane.

- **Clear** button

Resets all external LU attributes.

## Auto Map Setting window

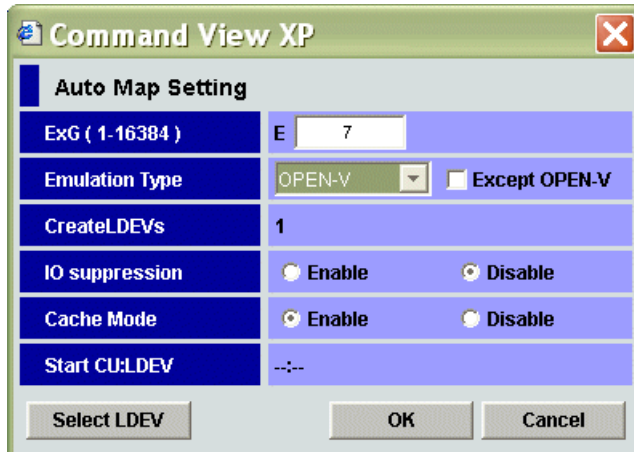

**Figure 419** Auto Map Setting window

- **ExG (1-16384)**

Group number containing the specified external LU. Specify any decimal value from 1 to 16384. The **E** displayed outside of the text box is the capital letter of the external LU group.

- **Emulation Type**

Emulation type of the external LU from the perspective of the XP12000.

To map the external LU as an open system volume, select the emulation type from the list. As you clear the **Except OPEN-V** check box, OPEN-V and available mainframe emulation types are displayed in the list. As you select the **Except OPEN-V** check box, the emulation types for the open systems other than OPEN-V are also displayed in the list. To map the external LU as an open system LU using an



emulation type other than **OPEN-V**, select the **Except OPEN-V** check box. Other emulation types then appear in the list.

If you plan to use the mapped external LU as part of a Flex Copy pair, specify **OPEN-V**. Due to the advantages of the Open-V emulation type, it is recommended to be the default type for use with External Storage XP.

- **Create LDEVs**

Number of LDEVs created based on capacity supported by the emulation type specified in the **Emulation Type** box.

- **IO Suppression**

For **OPEN-V** emulation only. To suppress I/O operations from hosts (by way of the XP12000) to the mapped external LU or use the mapped external LU as part of a Flex Copy pair, select **Enable**. If you do not want to suppress I/O from hosts to the mapped external LU, select **Disable** (for example, for External Storage XP).

If you set the emulation type to something different than OPEN-V, **I/O Suppression** mode is set to **Disable** automatically.

---

 **CAUTION:** If you want to use the mapped external LU for products other than Flex Copy XP, such as Cache LUN XP, Continuous Access XP, and Business Copy XP, set the **I/O Suppression** mode to **Disable**. To set the **I/O Suppression** mode to **Disable**, Volume Manager XP must be installed.

---

---

 **CAUTION:** To set the IO Suppression mode to **Enable**, Flex Copy XP must be installed.

---

- **Cache Mode**

Specifies whether I/O operations use the XP12000 cache memory when host I/O is performed. If you select **Enable** (the recommended setting for External Storage XP), the host I/O first goes to the XP12000 cache and then to the external LU. If you select **Disable**, host I/O goes directly to the external LU cache, bypassing XP12000 cache.

If you set **IO Suppression** mode to **Enable**, **Cache Mode** is set to **Disable** automatically.

---

 **CAUTION:** If you set **Disable**, the bind mode of Cache LUN XP cannot be set.

---

---

 **CAUTION:** If you have set the emulation type of the mainframe system for the mapped LU, the host I/O is always propagated asynchronously to the external LU regardless of the setting of the Cache Mode.

---

- **Start CU:LDEV**

Displays the first CU:LDEV number of the series of mapped destination internal XP LDEVs. The default is "- : -".

To have External Storage XP select the first CU:LDEV number for the mapped internal XP LDEV, leave the default ("- : -"). External Storage XP searches for an available CU:LDEV number starting with 00:00, and selects the first one it finds.

To specify the first CU:LDEV number, click **Select LDEV**.

- **Select LDEV** button

Displays the **Select LDEV** window, where you can select the first CU:LDEV number in the series.

- **OK** button

Starts mapping internal CU:LDEV numbers to external volumes. When mapping is complete, the SSID window appears if the SSID settings are necessary. If the SSID settings are not necessary, the **Auto Map Setting** window closes, and the **LU Operation** pane appears.

- **Cancel** button

Cancels all mapping operations, closes the **Auto Map Setting** window, and returns to the **LU Operation** pane.

## Select LDEV window

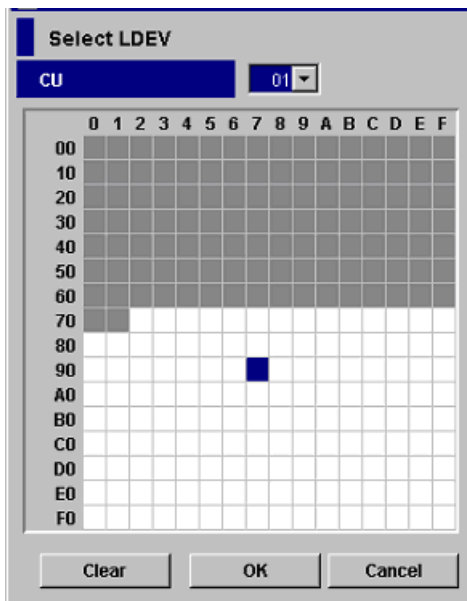

**Figure 420** Select LDEV window

- **CU** list

Select the CU number of the local subsystem to which you want to map the external LU.

- **LDEV Map**

Each cell in the map represents an internal XP CU and LDEV number. Select a cell for the internal XP LDEV on the map. The selected cell turns blue, and the volume of the selected cell becomes the first CU:LDEV number of the mapped destination LUs. Defined (in use) internal XP LDEVs appear in gray, and internal volumes to be mapped appear in white.

- **Clear** button

Clears selection on the LDEV map.

- **OK** button

Closes the **Select LDEV** window, and returns to the **Auto Map Setting** window.

- **Cancel** button

Cancels all settings in the **Select LDEV** window, and returns to the **Auto Map Setting** window.

## Manually mapping external LDEVs (Add LU)

This operation uses the Add LU, SSID, and Set SSID windows to map an external LU to an internal CU:LDEV:

1. In the External Storage XP operations window, click **LU Operation**. The LU Operation window appears.
2. In the Device Tree, select **Discovery**.  
WWNs appear in the tree indicating external disk array ports that can be connected.
3. Select the port (WWN) you want to connect from the WWNs listed in the Device Tree.  
External LUs that can be connected from the external array port (WWN) selected in the tree appear in the Device List.
4. Select the external LU you want to map as an internal XP LDEV in the Device List, right-click, and select **Add LU**.

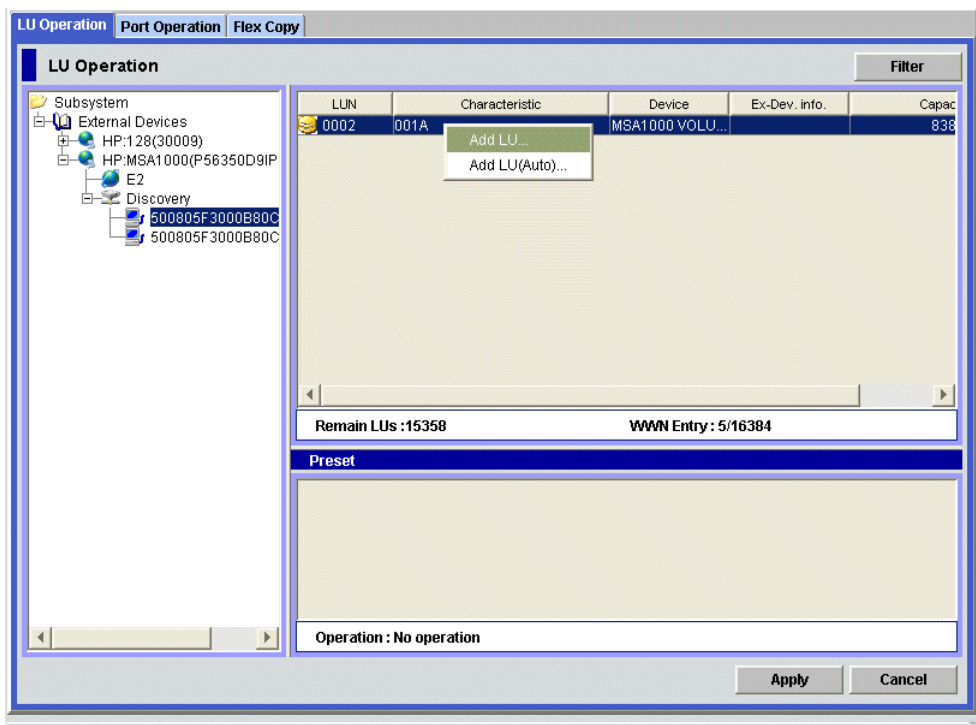

**Figure 421** Add LU (LDEV) command in the LU Operation pane

The Add LU window appears.

5. Enter the following items in the Add LU window:
  - a. Select an external LU group number in the **ExG** box.
  - b. Select an emulation type from the **Emulation Type** list.
  - c. Select the **IO Suppression** mode.
  - d. Select the **Cache Mode**.
  - e. Select the CU number in the **CU#** list box.

Now you can select the internal XP LDEV you want mapped to the external LU selected in the Device List.

6. Map external LUs individually, or map all external LUs shown in the **CU:LDEV** list at one time.

- To map external LUs individually: In the LU Operation pane, select an external LU whose number in the **CU:LDEV** list is **(N/A)**. In the Add LU window, click the cell representing the internal XP LDEV in the LDEV map.
- To map all the external LUs displayed in the **CU:LDEV** list at one time: In the Add LU window, click **Linear**, and click an internal XP LDEV in the LDEV map. External Storage XP automatically selects the same number of internal XP LDEVs in the LDEV map as the number of external LUs shown in the **CU:LDEV** list, mapping them sequentially starting with the internal LU selected (cells appear in blue in the LDEV map).

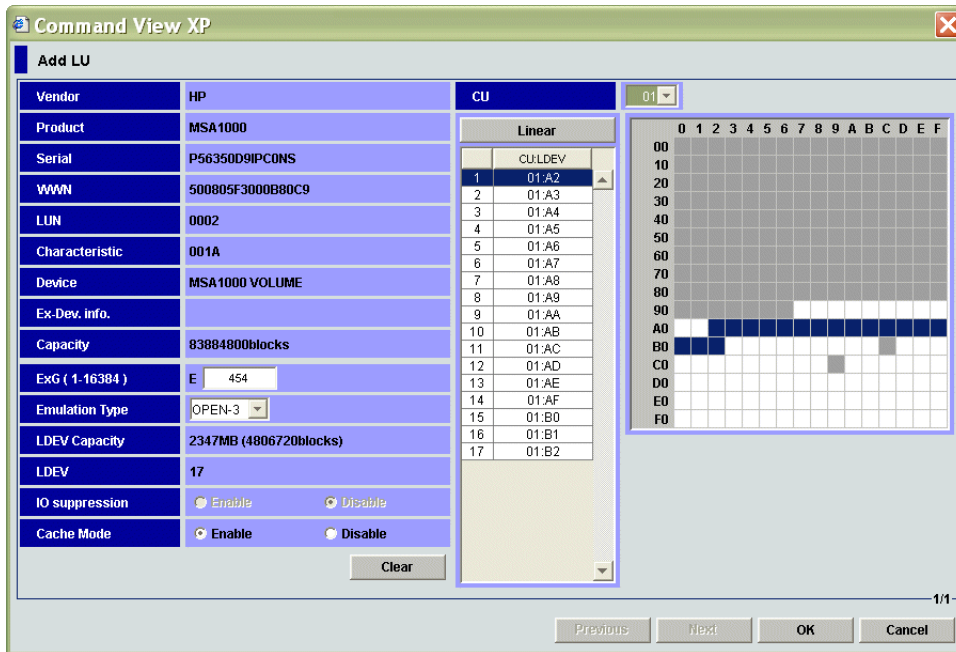

**Figure 422** Mapping all external LUs to internal LDEVs at once

- To map one external LU in the series to a different internal XP LDEV: Map the external LU automatically using the **Linear** button. Release the **Linear** button, and map the external LU individually.

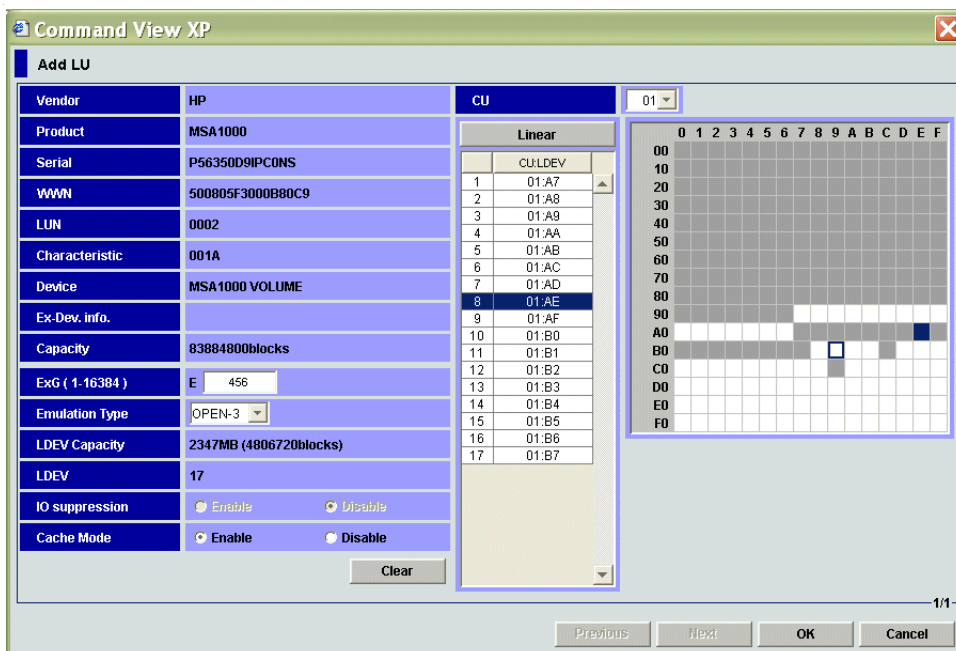

**Figure 423** Mapping one external LU in a series to a different (non-sequential) internal XP LDEV

7. When all settings are complete on the Add LU window, click **OK**.
  - If you need to set the SSID, the SSID window appears.



**Figure 424** SSID window

Go to the [step 8](#).

- If you do not need to set the SSID, the Add LU window closes, and the **LU Operation** pane appears. Settings appear in blue italics in the Device Tree and Device List. Contents specified in the Add LU window appear in the **Preset** list. To check details of settings, select the setting in the **Preset** list, right-click, and select **Detail**. To cancel settings, select the setting in the **Preset** list, right-click, and select **Delete**. Go to [step 11](#).

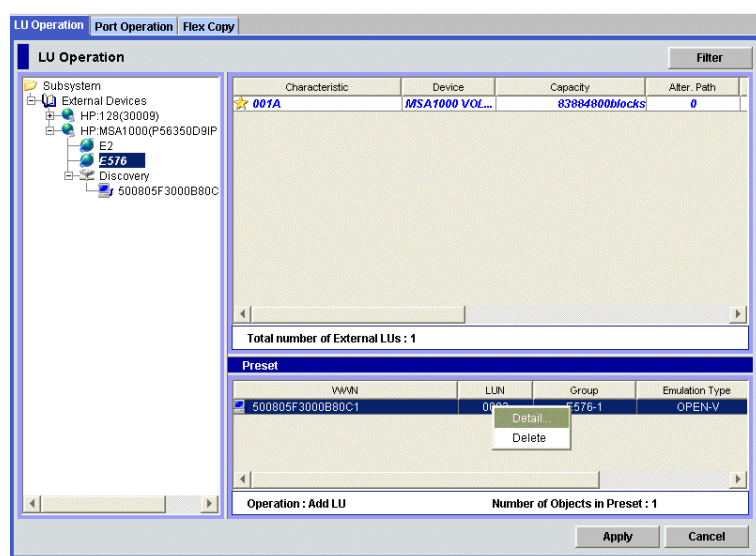

**Figure 425** Preset Status of the Add LU Operation

8. If you need to set an SSID to the mapped internal XP LDEV, select the **CU:LDEV** number on the SSID window, right-click, and select **Set SSID**. The Set SSID window appears.



**Figure 426** Set SSID window

9. Enter the SSID on the Set SSID window. You can enter values from 0x0004 to 0xFFFF.
10. Click **OK** on the Set SSID window.

The Set SSID window closes, and the LU Operation pane appears.

Settings appear in blue italics in the Device Tree and Device List and also appear in the **Preset** list. To check details of settings, select the setting in the **Preset** list, right-click, and select **Detail**. To cancel settings, select the setting in the **Preset** list, right-click, and select **Delete**.

11. Click **Apply** on the LU Operation pane. A confirmation message appears.
12. Click **OK**.

The mapping set in the Add LU window is applied to the local disk array, and the specified contents appear in the Device List.

If errors occur during the external LU mapping operation, failed settings appear in the **Preset** list and error codes appear. To check error messages, select the failed setting, right-click, and select **Detail**.

## Setting alternate paths

Before you can use the external LU mapped as an internal XP LDEV, set at least one alternate path from the internal XP LDEV to the external LU (likely by way of an alternate controller). For detailed information, see "[Alternate paths](#)" on page 758.



**CAUTION:** If the number of alternate paths specified is out of range (for example, too few), an error is displayed in the **Preset** list.

---

Use the **Path Setting** window to define alternate paths.

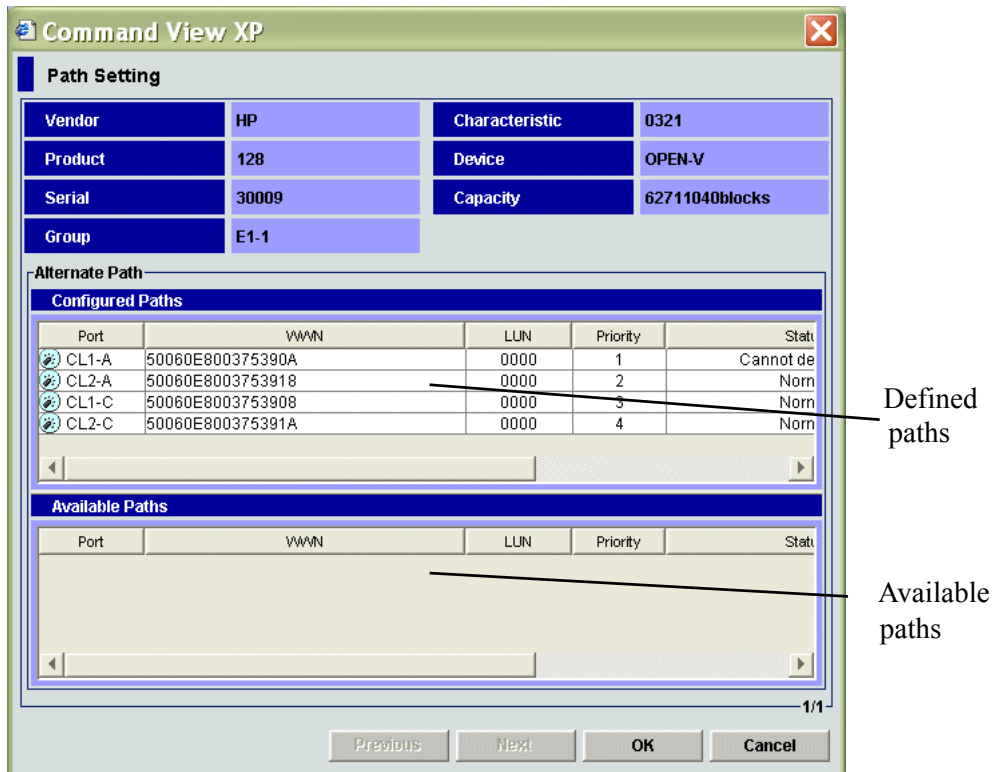

**Figure 427** Path Setting window

You can perform the following operations from the Path Setting window:

- "Defining alternate paths" on page 803
- "Changing the priority of alternate paths" on page 804
- "Canceling defined alternate paths" on page 805
- "Changing alternate paths" on page 806

The **Path Setting** window displays information about external disk arrays and condition of paths set from the internal XP LDEV to the external LU.

## Path Setting window

- **Vendor**  
The external disk array vendor
- **Product**  
The external disk array product name
- **Serial**  
The external disk array serial number
- **Group**  
The external LU group and reference number
- **Characteristic**  
Identification number of external LU.

- **Device**

The external LU device type

- **Capacity**

Capacity of external LU

- **Alternate Path List**

Status of alternate paths. The **Alternate Path** list consists of two tables. The **Configured Paths** table displays previously defined paths. The **Available Paths** table displays available paths. The **Alternate Path** list displays the following information:

- **Port:** The local disk array port number
- **WWN:** Identification number of the external disk array port.
- **LUN:** The external LU number.
- **Priority:** Priority of paths connecting to external LU. A **1** indicates the path with the highest priority.
- **Status:** Status of path to external LU. For information on reacting to status displayed, see page 814. Possible values:
  - **Normal:** Path status is normal
  - **Unknown:** Path status is unknown.
  - **Blockade:** I/O traffic is blocked.
  - **External device setting changed:** Something about the external disk array has changed. For example, a path definition was deleted or the external disk array was replaced.
  - **LDEV size reduced:** The volume capacity of the external disk array has changed (volume capacity was reduced)
  - **Not ready:** The reply of the external subsystem was NOTREADY.
  - **Illegal request:** The external disk array replied ILLEGALREQUEST
  - **Command aborted:** External disk array replied ABORTEDCOMMAND
  - **Busy:** The external disk array status is BUSY
  - **LDEV reserved:** The external disk array status is Reserve
  - **Response error:** The status of the external disk array is blocked because of an abnormal reply (Response)
  - **Initiator port:** The port attribute of the external disk array changed to initiator
  - **RCU target port:** The port attribute of the external disk array changed to RCU target
  - **Unknown port:** The port attribute of external disk array is unknown
  - **Cannot detect port:** The path was removed or the external disk array port cannot be found
  - **Internal error:** A program error occurred, or there is a logical contradiction
  - **Timeout:** Processing was retried because of an abnormal reply, but a timeout has occurred
  - **Checking:** External Storage XP is checking defined configuration information of paths
  - **Disconnect:** The connection to the external disk array or LU was stopped using the **Disconnect Subsystem** or **Disconnect Volume** command



- **I/O TOV:** Specified timeout value regarding I/O to the external LU
- **Qdepth:** Number of Read/Write commands that can be issued (queued) to an external LU at one time
- **Mode:** How the local disk array manages alternate path(s) when defined. There are two possible values:
  - **Multi:** Use several ports (alternate paths) at one time to distribute the workload. That is, the external array contains Symmetrical Active/Active controllers (for example, XP).
  - **Single:** Use only one port for one operation. If selected, the alternate path is enabled only in case of a maintenance operation or a failure effecting the primary path. That is, the external array contains Active/Passive (for example, MSA) or Asymmetrical Active/Active controllers (for example, Hitachi 9500V).
- **Previous** and **Next** buttons

If you select several external LUs in the Device List in the LU Operations pane, click **Previous** to change the Alternate Path list to the external LU appearing just *above* the currently displayed LU. Click **Next** to change the Alternate Path list to the external LU appearing just *below* the currently displayed LU.

- **OK** button

Closes the **Path Setting** window, and returns to the LU Operation pane. Contents specified in the **Path Setting** window appear in blue italics in the Device List, and settings appear in the **Preset** list.

- **Cancel** button

Cancels all alternate path setting operations, closes the **Path Setting** window, and returns to the LU Operation pane.

## Defining alternate paths

1. In the External Storage XP operations window, click **LU Operation**. The LU Operation pane appears.
2. Select the external LU group number in the Device Tree (left pane).  
Information about the external LU mapped as an internal XP LDEV appears in the Device List (right pane).
3. In the Device List, select the desired external LU, right-click, and select **Path Setting**.

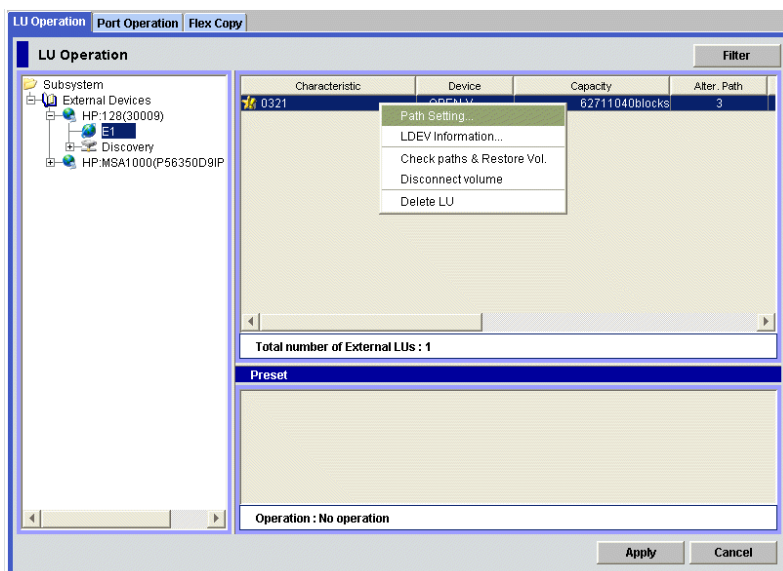

**Figure 428** Defining alternate paths in the LU Operation pane

The **Path Setting** window appears. The **Configured Paths** table in the **Alternate Path** list displays detailed information about one currently defined path. The **Available Paths** table displays paths that can be set as alternate paths.

4. Select the row of the path to be defined as an alternate path in the **Available Paths** table in the **Alternate Path** list, right-click, and select **Add**.

The selected path is defined as an alternate path, and detailed information appears in the **Configured Paths** table of the **Alternate Path** list.

5. Click **OK** in the **Path Setting** window.

The **Path Setting** window closes, and the LU Operation pane appears.

Specified contents appear in blue italics in the Device List, and also appear in the **Preset** list. To check details on intended operations, select the setting in the **Preset** list, right-click, and select **Detail**. To cancel settings, select the setting in the **Preset** list, right-click, and select **Delete**.

6. Click **Apply** in the LU Operation pane. A confirmation message appears.
7. Click **OK**.

The alternate path defined in the **Path Setting** window is applied to the local disk array, and specified contents appear in the Device List.

If errors occur during alternate path operations, failed settings appear in the **Preset** list, and error codes appear. To check error messages, select the failed setting, right-click, and select **Detail**.

## Changing the priority of alternate paths

To change the priority of alternate paths, use the **Priority Up** and **Priority Down** commands displayed in the **Path Setting** window (Figure 429). **Priority Up** raises the priority of the path selected in the Alternate Path list. **Priority Down** lowers its priority.

As long as both paths go to the same external controller, or the external array uses symmetrical active/active controllers (for example, XP), change an alternate path to the currently used path by simply raising the priority of the alternate path or lowering the priority of the currently used path.



**NOTE:** If the two paths connect to different controllers on the external array (for example, MSA), do not use a path priority change to attempt to force a controller failover. Instead, use either a manual cable disconnect or a **Disconnect Paths** GUI operation on the active controller WWN in the device list. In other words, while the XP firmware may respond to a cable disconnect leading to the primary path and active controller as a reason to activate the passive controller and path and continue I/Os, a simple change in path priorities may not have the same effect, and I/Os may become blocked.

1. In the External Storage XP operations window, click **LU Operation**. The LU Operation pane appears.
2. Select the external LU group number in the Device Tree (left pane).  
Information about the external LU mapped as an internal XP LDEV appears in the Device List (right pane).
3. In the Device List, select the desired external LU, right-click, and select **Path Setting**.

4. Select the row of the path defined as the alternate path in the **Configured Paths** table, right-click, and select **Priority Up**.

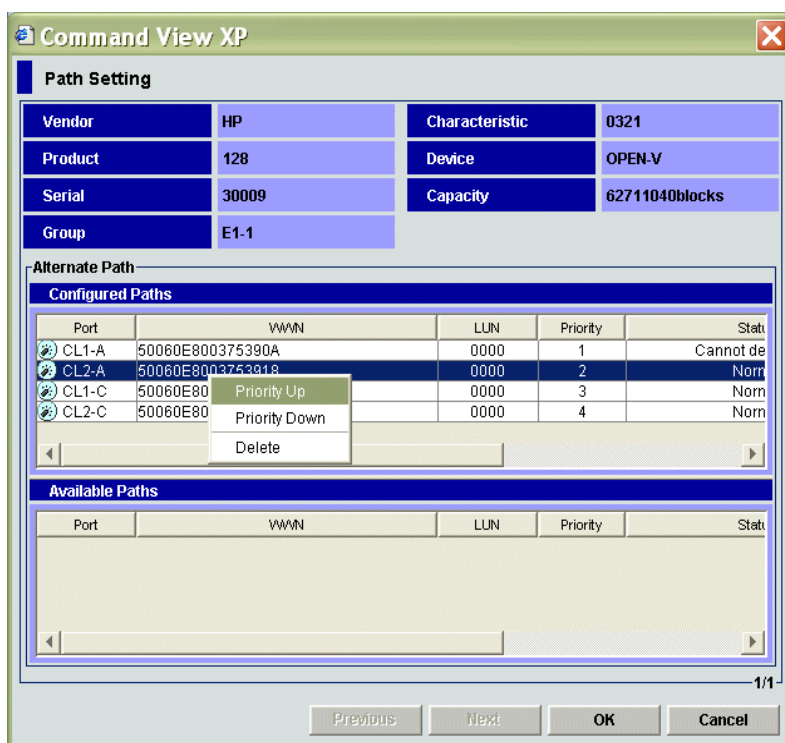

**Figure 429** Using Priority Up to raise defined alternate paths in the LU Operation pane

The selected row appears at the top of the Alternate Path list, and text in the Priority column changes from **2** to **1**. The priority of the alternate path is raised, and the path is set as the currently used path.

5. Click **OK** in the **Path Setting** window.

The **Path Setting** window closes, and the LU Operation pane appears.

Specified contents appear in blue italics in the Device List, and also appear in the **Preset** list. To check details on intended operations, select the setting in the **Preset** list, right-click, and select **Detail**. To cancel settings, select the setting in the **Preset** list, right-click, and select **Delete**.

6. Click **Apply** in the LU Operation pane. A confirmation message appears.
7. Click **OK**.

The alternate path defined in the **Path Setting** window is applied to the local disk array, and specified contents appear in the Device List.

8. If errors occur during alternate path operations, failed settings appear in the **Preset** list, and error codes appear. To check error messages, select the failed setting, right-click, and select **Detail**.

## Canceling defined alternate paths

1. Follow [step 1](#) to [step 3](#) in “Defining alternate paths” on page 803.
2. Select the row of the alternate path in the **Configured Paths** table, right-click, and select **Delete**.

The definition of the selected alternate path is canceled, and detailed information about the path is deleted from the upper table of the list.

3. Follow [step 5](#) to [step 7](#) in “Defining alternate paths” on page 803.

## Changing alternate paths

To change the alternate path, cancel the current alternate path, and then define another path as a new alternate path.

1. Follow [step 1](#) to [step 3](#) in “[Defining alternate paths](#)” on page 803.

2. Select the row of the path currently defined as the alternate path in the **Configured Paths** table, right-click, and select **Delete**.

The definition of the selected alternate path is canceled, and detailed information about the path is deleted from the upper table of the list.

3. Select the row of the path to be defined as the new alternate path in the **Available Paths** table, right-click, and select **Add**.

The specified path is defined as the alternate path, and detailed information about the path is displayed in the **Configured Paths** table of the list.

4. Follow [step 5](#) to [step 7](#) in “[Defining alternate paths](#)” on page 803.

## Checking External Storage XP volume status (LDEV Information)

When mapping an LU on an external disk array as a local disk array LDEV, the LU on the external array becomes available for External Storage XP operations, Flex Copy operations, and other operations by other Command View programs that support mapped external volumes.

However, when errors occur in the paths between the local disk array and the external device, the local disk array blocks the status of the External Storage XP volume (status is **Blockade**). Use the **LDEV Information** window to restore the state of an External Storage XP volume with **Blockade** status.

You can perform the following operations using the **LDEV Information** window:

- “[Obtaining information about external LUs](#)” on page 807
- “[Restoring external LUs \(Restore\)](#)” on page 808
- “[Displaying configuration information for external LUs \(Volume Detail\)](#)” on page 809

## Obtaining information about external LUs

The **LDEV Information** window displays information about external disk arrays and external LUs mapped as internal XP LDEVs. To display this window, select the external LU group number in the device list, click the LU you want to display in the device list, right-click, select **LDEV Information**.

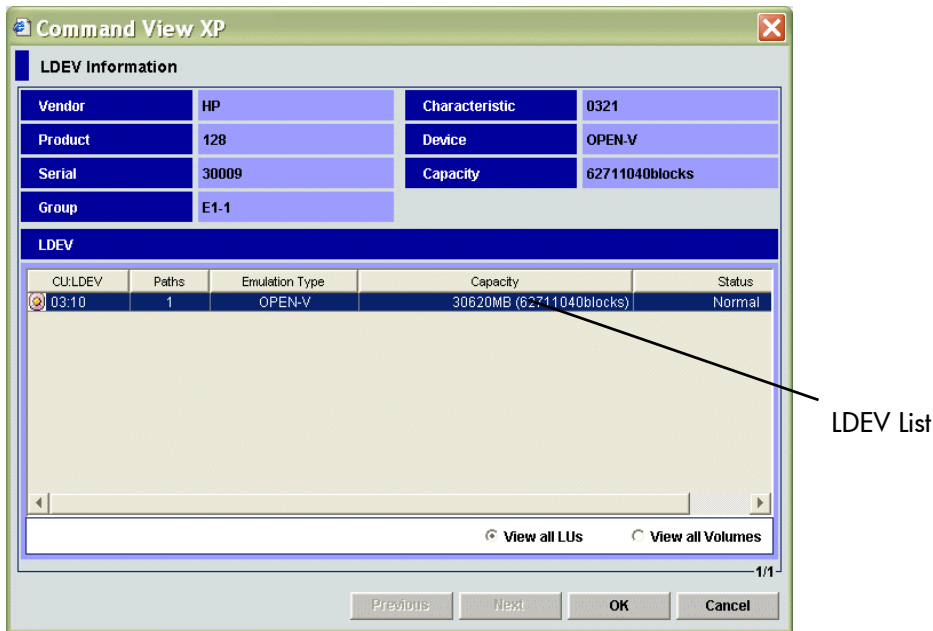

**Figure 430** LDEV Information window

The **LDEV Information** window displays the following:

- **Vendor**  
The external disk array vendor
- **Product**  
The external disk array product name
- **Serial**  
The external disk array serial number
- **Group**  
External LU group and reference number
- **Characteristic**  
The external LU identification number
- **Device**  
Device name of external LU
- **Capacity**  
The capacity of the external LU. When an open system emulation type is set for the mapped external LU, capacity is displayed in 512-byte Blocks. When a mainframe system emulation type is set, capacity is displayed in Cylinders.
- **LDEV List**  
The status of external LUs mapped as internal XP LDEVs, including the following:

- **CU:LDEV:** The internal CU:LDEV number to which the external LU is mapped
- **Path:** Number of set paths
- **Emulation Type:** The emulation type of the external LU (which was set when it was mapped)
- **Capacity:** The capacity of the external LU
- **Status:** Status of external LU. Possible values: **Normal**, **Unknown**, **Blockade**, **Warning**, and **Format**. **Warning** indicates that some alternate paths are blocked. **Format** indicates the external LU is currently being formatted.
- **View all LUs** button  
Displays information about all the external LUs in the LDEV list.
- **View all Volumes** button  
When the external LU is part of a LUSE volume, the **LDEV** list displays all LDEVs that make up the LUSE volume. LDEVs in other external LUs are not displayed, however, even though those LDEVs may be part of the LUSE volume. To check all LDEVs configuring a LUSE volume, use the **Volume Detail** command (page 809).
- **Previous** and **Next** buttons  
If you select several external LUs in the Device List in the LU Operation pane, click **Previous** to change the **LDEV** list to the external LU appearing just *above* the currently displayed LU. Click **Next** to change the **LDEV** list to the external LU appearing just *below* the currently displayed LU.
- **OK** button  
Closes the **LDEV Information** window and returns to the LU Operation pane. Contents specified in the **LDEV Information** window appear in blue italics in the Device List, and settings appear in the **Preset** list.
- **Cancel** button  
Cancels all setting operations, closes the **LDEV Information** window, and returns to the LU Operation pane.

## Restoring external LUs (Restore)

When errors occur in all the paths between the local disk array and external disk array, the local disk array changes the status of the external LU to **Blockade**. To restore an External Storage XP volume with **Blockade** status to **Operational** status, use the **Restore** command in the **LDEV Information** window.

To operate the external LU in Command View XP, map it as an internal XP LDEV and set an alternate path, and then make the external LU available (enabled). To enable an external LU, use the **Restore** command in the **LDEV Information** window.

1. In the External Storage XP operations window, click **LU Operation**. The LU Operation pane appears.
2. Select the external LU group number in the Device Tree (left pane).  
Information about the external LU mapped as an internal XP LDEV appears in the Device List (right pane).
3. In the Device List, select the External Storage XP volume, right-click, and select **LDEV Information**.  
The **LDEV Information** window appears. The **LDEV** list shows information about the external LU selected in the Device List on the **LU Operation** pane.
4. Click **View all LUs**.

- Click the row of the External Storage XP volume in the **LDEV** list, right-click, and select **Restore**.

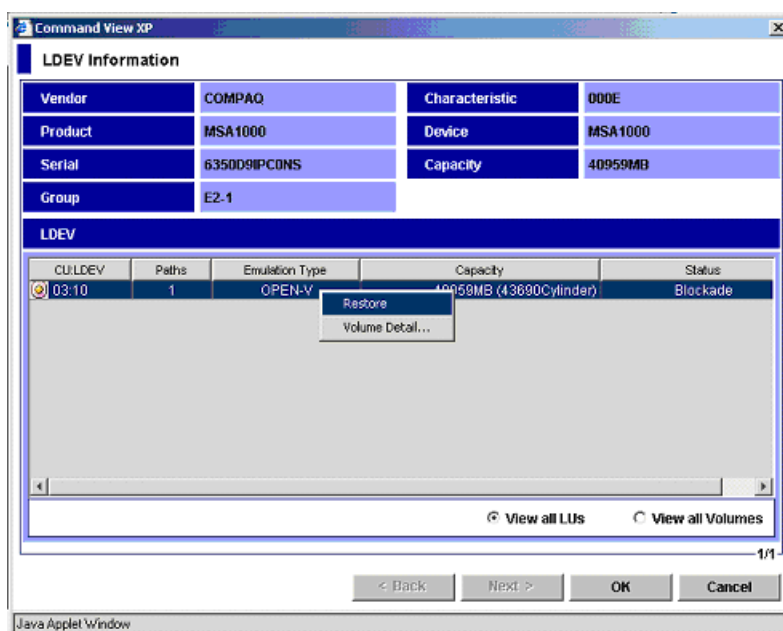

**Figure 431** Shortcut menu of the LDEV Information window

The **Status** column in the selected external LU row changes to **Restore**.

- Click **OK**.

The **LDEV Information** window closes, and the **LU Operation** pane appears.

Specified contents appear in blue italics in the Device List and appear in the **Preset** list. To check details of settings, select the setting in the **Preset** list, right-click, and select **Detail**. To cancel settings, select the setting in the **Preset** list, right-click, and select **Delete**.

- Click **Apply** on the **LU Operation** pane. A confirmation message appears

- Click **OK**.

The status of the external LU set in the **LDEV Information** window changes to **Restore** (restored), and the external LU can be operated in Command View.

If errors occur when changing the status of the external LU, failed settings appear in the **Preset** list, and error codes appear. To check error messages, select the failed setting, right-click, and select **Detail**.

## Displaying configuration information for external LUs (Volume Detail)

To display the **Volume Detail** window, select a row with an external LU from the **LDEV** list in the **LDEV Information** window, right-click, and select **Volume Detail**. If you select an external LU that is a LUSE volume in the **LDEV** list, the **Volume Detail** window displays a list of all LDEVs that make up the LUSE volume.

You can also check the LDEVs making up a LUSE volume by selecting **View all Volumes** at the bottom of the **LDEV Information** window. This option displays only the LDEVs emanating from the specified external LU. The **Volume Detail** window lists all LDEVs, including those of other external LUs.



**NOTE:** The **Volume Detail** command is available after you restore the External Storage XP volume using the **Restore** command.

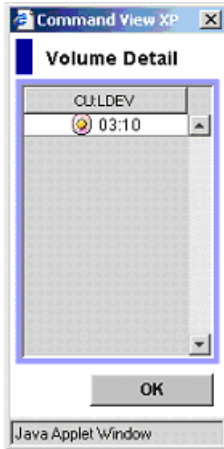

**Figure 432** Volume Detail window

## Disconnecting external disk arrays or external LUs

Use the **Disconnect Subsystem** and **Disconnect Volume** commands to disconnect external LUs. This is necessary, for example, before you turn off the power supply of the local disk arrays or external disk arrays for maintenance or before deleting an external LU's mapping.

When you execute the **Disconnect Subsystem** or **Disconnect Volume** command, External Storage XP stops all host I/O to the mapped external LU, and all data in the XP12000 cache memory is written to the external LU (all data is destaged).

Mapping settings are preserved, even though the external LU is disconnected. Therefore, you can resume using the external LU as a mapped LDEV with the former settings. For instructions on resuming use of disconnected external LUs, see page 812.



**CAUTION:** Executing the **Disconnect Subsystem** or **Disconnect Volume** command forcibly stops all host I/O operations to the specified LU. For I/Os from a mainframe host, an **INTERVENTION REQUIRED** message is sent to the host. Therefore, stop all host I/O operations before using the **Disconnect Subsystem** or **Disconnect Volume** command.

There are two ways to disconnect external LUs:

- "[Disconnecting all external LUs in external disk arrays \(Disconnect Subsystem\)](#)" on page 810
- "[Disconnecting single external LUs \(Disconnect Volume\)](#)" on page 811

## Disconnecting all external LUs in external disk arrays (Disconnect Subsystem)

1. In the **LU Operation** tab, click **External Devices** in the Device Tree.

Connected external subsystems appear in the Device List.



- Click the external disk array you want to disconnect from the local disk array in the Device List, right-click, and select **Disconnect Subsystem**.

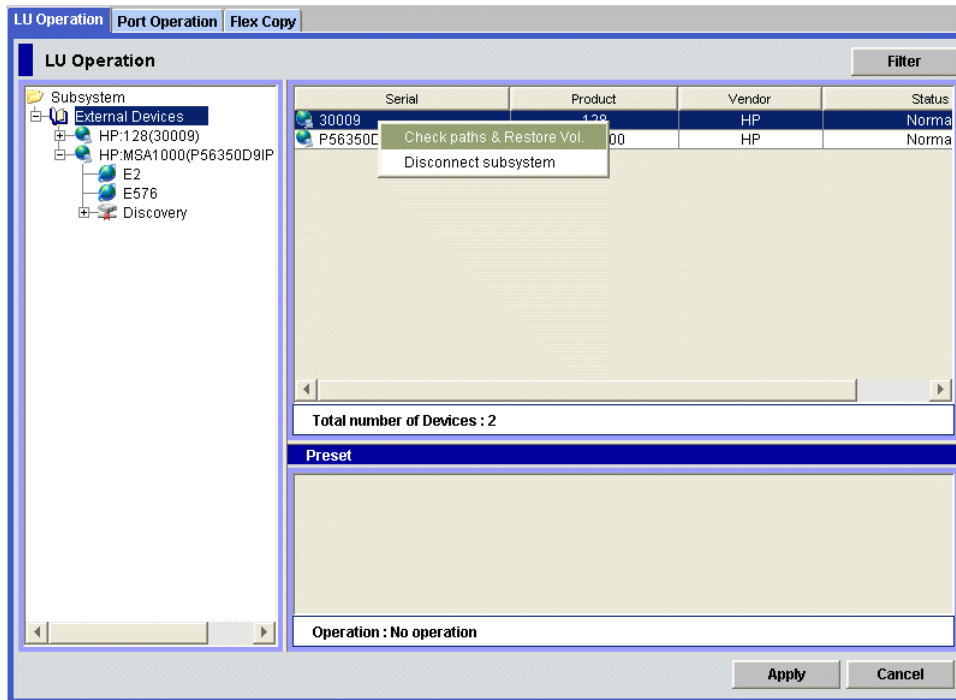

**Figure 433** Disconnect Subsystem and Check Paths & Restore Vol. Commands

The selected external disk array appears in blue italics in the LU List and Device List, and appears in the **Preset** list. To check details of the intended operations, select the setting in the **Preset** list, right-click, and select **Detail**. To cancel settings, select the setting in the **Preset** list, right-click, and select **Delete**.

- Click **Apply** in the **LU Operation** pane.

A confirmation message appears.

- Click **OK**.

The **Status** column in the Device List changes to **Cache Destaging**. When External Storage XP finishes writing data from cache to the external LU, the **Status** column changes to **Disconnect**.

If errors occur during disconnect operations, failed settings appear in the **Preset** list, and error codes appear. To check error messages, click the failed setting, right-click, and select **Detail**.



**CAUTION:** To access the external disk array after executing the **Disconnect Subsystem** command, execute the **Check Paths & Restore Vol.** command.

## Disconnecting single external LUs (Disconnect Volume)

- In the LU Operation tab, select an external LU group number in the Device Tree (left pane)

Information about external LUs in the selected external LU group appears in the Device List (right pane).

- Select the external LU in the device list, right-click, and select **Disconnect Volume**.

The selected external LU group number in the Device Tree and the selected external LU in the Device List appear in blue italics. It also appears in the **Preset** list. To check details of the intended operation,

select the row in the **Preset** list, right-click, and select **Detail**. To cancel settings, select the row in the **Preset** list, right-click, and select **Delete**.

3. Click **Apply** in the **LU Operation** pane.

A confirmation message appears.

4. Click **OK**.

The **Status** column in the Device List changes to **Cache Destaging**. When External Storage XP finishes writing data from cache to the external LU, the **Status** column changes to **Disconnect**.

If errors occur during disconnect operations, failed operations appear in the **Preset** list, and error codes appear. To check error messages, click the failed operation row, right-click, and select **Detail**.



**CAUTION:** To access the external LU after executing the **Disconnect Subsystem** command, execute the **Check Paths & Restore Vol.** command.

---

## Checking connection status and resuming external LU operations (Check Paths & Restore Vol.)

Use the **Check Paths & Restore Vol.** command to resume using an external LU that has been disconnected using the Disconnect Subsystem command but whose mapping settings have been preserved. This command checks the external LU's defined mapping and current status against the path status if the external LU is usable; otherwise, the status remains as Blockade.

There are two ways to restore disconnected external LUs:

- "Restoring single external LUs (Check Paths & Restore Vol.)" on page 812
- "Restoring all external LUs in an external disk array (Check Paths & Restore Vol.)" on page 813

### Restoring single external LUs (Check Paths & Restore Vol.)

1. In the **LU Operation** tab, select an external LU group number in the Device Tree.

Information about external LUs in the selected external LU group appears in the Device List.

2. Click the external LU in the Device List, right-click, and select **Check Paths & Restore Vol.**



**NOTE:** After you have executed the **Check Paths & Restore Vol.** command, click the **Refresh** button in the Command View main window to update the information and check the current progress status.

---

The selected external group number in the Device Tree and the selected external LU in the Device List appear in blue italics. Rows with operations to be performed on appear in the **Preset** list. To check details of settings, select the setting in the **Preset** list, right-click, and select **Detail**. To cancel settings, select the setting in the **Preset** list, right-click, and select **Delete**.

3. Click **Apply** in the **LU Operation** pane.

A confirmation message appears.

4. Click **OK**.

The path status displayed in the **Path Setting** pane changes to **Checking**. When External Storage XP finishes checking path status and the external LU can be restored, the **Status** column changes to **Normal**. If the external disk array cannot be restored, the status changes to **Blockade**.

## Restoring all external LUs in an external disk array (Check Paths & Restore Vol.)

1. In the **LU Operation** tab, click **External Devices** in the Device Tree (left pane).  
Physically connected external subsystems appear in the Device List (right pane).
2. Click the external disk array in the Device List, right-click, and select **Check Paths & Restore Vol.**  
The selected external disk array appears in blue italics in the LU List and Device List. It also appears in the **Preset** list. To check details of settings, select the setting in the **Preset** list, right-click, and select **Detail**. To cancel settings, select the setting in the **Preset** list, right-click, and select **Delete**.
3. Click **Apply** in the **LU Operation** pane.  
A confirmation message appears.
4. Click **OK**.  
The path status in the **Path Setting** pane changes to **Checking**. When External Storage XP finishes checking path status and the external disk array can be restored, the **Status** column changes to **Normal**. If the external disk array cannot be restored, the status changes to **Blockade**.

## Deleting external LU mappings (Delete LU)

Although you can use the **Delete LU** command to delete the mapping between an internal XP LDEV and external LU, you cannot reliably delete data in the external or internal XP LDEV using this command.

Before deleting the external LU mapping, execute the **Disconnect Subsystem** or **Disconnect Volume** command. All data in the XP12000 cache memory must be written to the mapped external LU using one of these commands before deleting the LU. For detailed information about the **Disconnect Subsystem** and **Disconnect Volume** commands, see page 810.

Before deleting the external LU mapping, notice if any of the following are true:

- The LDEV is part of a LUSE volume
- A path to the external device exists
- The LDEV is configured as part of a Business Copy pair
- The LDEV is set as the reserved LU for Business Copy or Auto LUN XP

If any of these conditions are true, you cannot delete the external LU mapping.

1. In the External Storage XP operations window, click **LU Operation**. The LU Operation pane appears.
2. Select the external LU group number in the Device Tree (left pane).  
Information about the external LU mapped as an internal XP LDEV appears in the Device List (right pane).
3. In the Device List, select the external LU, right-click, and select **Delete LU**.  
Settings appear in blue italics in the Device List, and they appear in the **Preset** list. To check details regarding intended changes, select the setting in the **Preset** list, right-click, and select **Detail**. To cancel settings, select the setting in the **Preset** list, right-click, and select **Delete**.
4. Click **Apply** in the **LU Operation** pane.  
A message appears asking whether you have performed the Disconnect (subsystem or volume) operation.
5. Click **Yes** or **No**.
  - If you click **Yes**, a confirmation message appears. To cancel the operation, click **Cancel**. Otherwise go to [step 7](#).

- If you click **No**, a warning message appears asking if you really want to execute the **Delete LU** operation without first flushing data in XP12000 cache memory to the external LU. To cancel the operation, click **Cancel**.



**NOTE:** If you click **OK** in response to the warning, the Delete LU operation is performed, but data in the XP12000 cache memory that is not yet written to the external volume might be lost.

6. Click **OK** in response to the warning message. A confirmation message appears.
7. Click **OK**.

The external LU whose mapping is deleted is removed from the Device List.

If errors occur during deletions of external LU mappings, failed settings appear in the **Preset** list, and error codes appear. To check error messages, select the failed setting, right-click, and select **Detail**.

## Troubleshooting External Storage XP

Table 148 provides general troubleshooting instructions for External Storage XP operations.



**NOTE:**

- For a problem with the local disk array Command View management station or Command View software, see “[Troubleshooting](#)” on page 835.
- For additional assistance, contact your HP Account Support Representative.

**Table 148** General External Storage XP troubleshooting

Error	Corrective Action
The Command View XP management station cannot access the external LU.	<p>Correct the error and retry the operation.</p> <p>The reason for the error could be one of the following:</p> <ul style="list-style-type: none"> <li>The Fibre Channel switch is off or an error occurred in the switch.</li> <li>The FC cables are not properly connected.</li> <li>The configuration of the external disk array changed, and the external LU has been deleted.</li> <li>An error occurred with the external LU in the external disk array.</li> <li>The path between the local disk array and external disk array was changed.</li> <li>The port attribute of the local disk array is no longer external.</li> </ul> <p>If none of these are the problem, disconnect the cable between the local disk array and external disk array, and reconnect it. Retry the operation after 30 seconds.</p>

**Table 148** General External Storage XP troubleshooting (continued)

<b>Error</b>	<b>Corrective Action</b>	
<p>The external LU cannot be mapped as an internal XP LDEV of the local disk array.</p>	<p>Correct the error and retry the operation.</p> <p>The source of the error could be any of the following:</p> <p>The number of mapped external LUs exceeds the maximum number (15,360 LUs) available for the local disk array.</p> <p>There are not enough CU:LDEV numbers available for external LU mapping.</p>	
<p>The path to the external LU is blocked.</p>	<p>An error in the first row of this table (Error: The Command View XP management station cannot access the external LU) could be the reason for this error. Check the reasons in the first row, correct the error, and retry the operation. If the error persists, try step 2.</p> <p>Try the following procedures. If they do not work and the path is not restored, save the HP disk array configuration information using <b>FD Dump</b> and contact your HP account support representative.</p> <p>Verify that the cable between the local disk array and external disk array is connected properly.</p> <p>If the cable between the local disk array and external disk array is connected properly, disconnect and reconnect it. After 30 seconds, check the path status from Command View.</p>	
<p>The path status that requires the action is displayed in the Alternate Path list on the <b>Path Setting</b> window (see <a href="#">"Setting alternate paths"</a> on page 800).</p>	<p>The following rows describe path status values displayed in the Alternate Path list and how to react to each status value.</p>	
	<p>External device setting changed</p>	<p><b>Status:</b> The configuration of the external disk array changed. For example, the path definition was deleted, or the external disk array itself was replaced by another device.</p> <p><b>Corrective action:</b> The port of the external disk array is still recognized. Check the configuration of the external disk array.</p>
	<p>LDEV size reduced</p>	<p><b>Status:</b> The volume capacity setting of the external disk array changed (was reduced).</p> <p><b>Corrective action:</b> Check the volume capacity of the external disk array's LU. Execute the Delete LU operation, and execute the Add LU operation.</p>
<p>Not ready</p>	<p><b>Status:</b> The external disk array's LU is currently being formatted.</p> <p><b>Corrective action:</b> Wait until the formatting finishes. If the external LU is blocked, perform a restore operation.</p>	

**Table 148** General External Storage XP troubleshooting (continued)

Error	Corrective Action	
	Illegal request	<p><b>Status:</b> The reply from the external disk array was ILLEGAL REQUEST.</p> <p><b>Corrective action:</b> The port of the external disk array is still recognized. Check the external disk array's configuration. If you cannot restore the path, contact your HP Account Support Representative.</p>
	Command aborted	<p><b>Status:</b> The reply of the external disk array was ABORTED COMMAND.</p> <p><b>Corrective action:</b> The port of the external disk array is still recognized. Check the external disk array's configuration and the connection to the external disk array (for example, cables, switches). If you cannot restore the path, contact your HP Account Support Representative.</p>
	Busy	<p><b>Status:</b> The external disk array status is BUSY.</p> <p><b>Corrective action:</b> The port of the external disk array is still recognized. Check the external disk array's settings and the load on the external disk array (for example, check whether the configuration assigns too much load on the external disk array). If you cannot restore the path, contact your HP Account Support Representative.</p>
	LDEV reserved	<p><b>Status:</b> The status of the external disk array is Reserved.</p> <p><b>Corrective action:</b> Remove the Reserve status on the external disk array's LU.</p>
	Response error	<p><b>Status:</b> The external disk array's status is Blocked due to an abnormal reply.</p> <p><b>Corrective action:</b> The port of the external disk array is still recognized. Check the external disk array's configuration and status. If you cannot restore the path, contact your HP Account Support Representative.</p>

**Table 148** General External Storage XP troubleshooting (continued)

Error	Corrective Action	
	Initiator port	<p><b>Status:</b> The port attribute of the external (for example, XP) disk array was changed to <b>Initiator</b>.</p> <p><b>Corrective action:</b> Set the port attribute of the external disk array back to target. If you cannot restore the path, contact your HP Account Support Representative.</p>
	RCU target port	<p><b>Status:</b> The port attribute of the external disk array changed to <b>RCU target</b>.</p> <p><b>Corrective action:</b> Set the port attribute of the external disk array to <b>Target</b>. If you cannot restore the path, contact your HP Account Support Representative.</p>
	Unknown port	<p><b>Status:</b> The port attribute of the external disk array is unknown.</p> <p><b>Corrective action:</b> The port of the external disk array is still recognized. Check the condition of the connection (for example, cables and switches) to the external disk array. If you cannot restore the path, contact your HP Account Support Representative.</p>
	Cannot detect port	<p><b>Status:</b> The path was removed or the external disk array port cannot be found.</p> <p><b>Corrective action:</b> Check the condition of the connection to the external disk array. If you cannot restore the path, contact your HP Account Support Representative.</p>
	Internal error	<p><b>Status:</b> A program error occurred, or there is a logical contradiction.</p> <p><b>Corrective action:</b> Contact your HP Account Support Representative.</p>
	Timeout	<p><b>Status:</b> The processing was retried because an abnormal reply was returned, but retries have been stopped due to a timeout.</p> <p><b>Corrective action:</b> The port of the external disk array is still recognized. Check the condition of the connection (for example, cables and switches) to the external disk array. If you cannot restore the path, contact your HP Account Support Representative.</p>

**Table 148** General External Storage XP troubleshooting (continued)

<b>Error</b>	<b>Corrective Action</b>
<p>The <b>Discovery</b> operation cannot be performed.</p>	<p>Correct the error and retry the operation.</p> <p>The source of the error could be one of the following:</p> <p>Command View is not in <b>Modify</b> mode.</p> <p>The local disk array port and external disk array port are not connected using FC cables.</p> <p>Port security is improperly set on the external disk array.</p> <p>The status of the device in the external disk array is not <b>Normal</b>.</p> <p>The external disk array is not connected to a local disk array port set to <b>External</b>.</p> <p>The external LUN of the local disk array does not have a status of <b>Normal</b>.</p> <p>The external LU capacity is insufficient (less than 46.86 MB).</p> <p>The cable to the switch is not properly connected.</p> <p>The zoning for the switch is not set properly.</p> <p>If none of these correct the problem, disconnect and then reconnect the cable between the local disk array and external disk array. After 30 seconds, retry the operation.</p>
<p>The external LU is blockaded.</p>	<p>Correct the error and retry the operation.</p> <p>The source of the error could be any one of the following:</p> <p>All set paths are blockaded (or not connected).</p> <p>The attribute of the external LU is not set to Read/Write.</p> <p>The external LU is blockaded by an error.</p>



# Required volume capacity for each emulation type

When you map an external LU as a local disk array internal XP LDEV, you must specify the XP12000 emulation type for the mapped LU. [Figure 434](#) shows how to calculate the LU capacity for an OPEN-3 emulation. For Open Systems, the most used emulation type is expected to be Open-V.

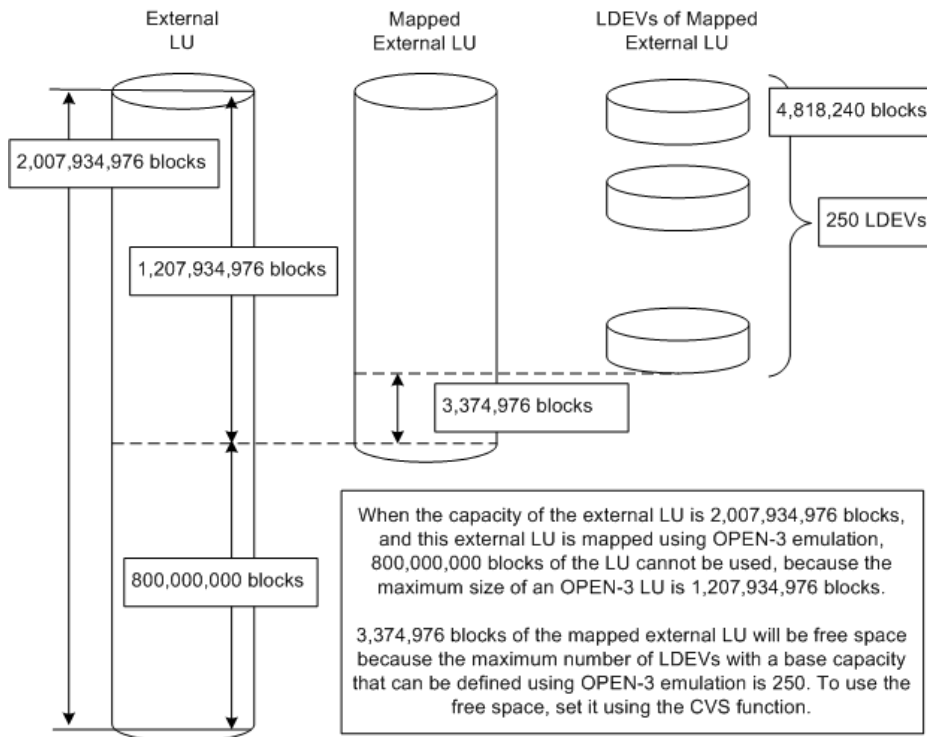

**Figure 434** Calculating LU capacity (OPEN-3 example)

As shown in [Table 149](#), each emulation type has certain minimum and maximum capacities:

- Minimum external LU capacity (83,520 blocks in our OPEN-3 example). When the capacity of the external LU is less than the defined minimum for the emulation type, the emulation type cannot be specified. Each block is 512 bytes.
- Maximum capacity for external LUs (1,207,934,976 blocks in our OPEN-3 example). When the capacity of the mapped external LU is greater than the defined maximum for the specified emulation type ([Figure 434](#)), part of the LU space cannot be used in the external LU.
- Base LDEV capacity (4,818,240 in our OPEN-3 example). When the capacity of the external LU is less than the base capacity of the specified emulation type, a Customized Volume (CV) is created when you map the volume. When the capacity of the external LU is more than base capacity of the specified XP12000 emulation type, the external LU is divided into multiple LDEVs, each having the base capacity. However, with OPEN-V emulation there is no concept of base LDEV capacity.
- Maximum number of LDEVs created when the maximum capacity of an external LU is mapped (256 in our OPEN-3 example). If you use the CVS function within the XP12000, you can further divide an XP12000 VDEV mapped to an external LU into up to 256 smaller LDEVs of a particular emulation type (except for OPEN-L and OPEN-M, which cannot be used with CVS).

As shown in [Table 149](#), base and minimum LDEV capacity are the same for OPEN-L and OPEN-M emulation types because CVs cannot be created. For OPEN-V emulation type, base LDEV capacity is not listed because that concept does not exist in OPEN-V.

**Table 149** Volume capacity information for each emulation type

<b>Emulation Type</b>	<b>Base LDEV Capacity (Blocks)</b>	<b>Minimum LDEV Capacity (Blocks)</b>	<b>Maximum Capacity of External LU (Blocks)</b>	<b>Maximum Number of LDEVs when Maximum Capacity of External LU is Mapped</b>
3380-J	1,280,160	77,760	327,720,960	256
6586-J	1,280,160	77,760	327,720,960	256
3380-E	2,556,000	79,200	654,336,000	256
6586-G	2,556,000	79,200	654,336,000	256
3380-K	3,833,280	82,080	981,319,680	256
6586-K	3,833,280	82,080	981,319,680	256
3380-F	5,767,200	103,680	1,207,934,976	209
3390-1	1,945,320	95,700	498,001,920	256
6588-1	1,945,320	95,700	498,001,920	256
3390-2	3,883,680	97,440	994,222,080	256
3390-3	5,820,300	97,440	1,459,588,096	250
6588-3	6,006,480	114,840	1,459,588,096	243
3390-9	17,473,080	130,500	1,459,588,096	83
3390-L	57,042,420	127,020	1,459,588,096	25
BL90-E	29,186,760	111,360	1,459,588,096	50
3380-KB	3,833,280	82,080	981,319,680	256
6586-KB	3,833,280	82,080	981,319,680	256
3390-3B	5,820,300	97,440	1,459,588,096	250
6588-3B	6,006,480	114,840	1,459,588,096	243
OPEN-L	71,202,240	71,202,240	1,139,235,840	16
OPEN-M	92,168,640	92,168,640	1,198,192,320	13
OPEN-V	-	96,000	4,294,967,296	1
OPEN-K	3,674,880	84,960	940,769,280	256

**Table 149** Volume capacity information for each emulation type (continued)

<b>Emulation Type</b>	<b>Base LDEV Capacity (Blocks)</b>	<b>Minimum LDEV Capacity (Blocks)</b>	<b>Maximum Capacity of External LU (Blocks)</b>	<b>Maximum Number of LDEVs when Maximum Capacity of External LU is Mapped</b>
OPEN-3	4,818,240	83,520	1,207,934,976	250
OPEN-E	28,480,320	99,360	1,207,934,976	42
OPEN-8	14,389,920	110,880	1,207,934,976	83
OPEN-9	14,461,920	110,880	1,207,934,976	83
3380-KA	3,833,280	82,080	981,319,680	256
6586-KA	3,833,280	82,080	981,319,680	256
3390-3A	5,820,300	97,440	1,459,588,096	250
6588-3A	6,006,480	114,840	1,459,588,096	243
3380-KC	3,833,280	82,080	981,319,680	256
6586-KC	3,833,280	82,080	981,319,680	256
3390-3C	5,820,300	97,440	1,459,588,096	250
6588-3C	6,006,480	114,840	1,459,588,096	243
NF80-J	1,280,160	77,760	327,720,960	256
NF80-E	2,556,000	79,200	654,336,000	256
NF80-K	3,833,280	82,080	981,319,680	256
NF80-KB	3,833,280	82,080	981,319,680	256
NFOP-K	3,674,880	84,960	940,769,280	256
NF80-KA	3,833,280	82,080	981,319,680	256
NF80-KC	3,833,280	82,080	981,319,680	256
3390-3R	5,820,300	97,440	1,459,588,096	250
3380-3	4,818,240	82,080	1,207,934,976	250
3380-3B	4,818,240	82,080	1,207,934,976	250
3380-3A	4,818,240	82,080	1,207,934,976	250
3380-3C	4,818,240	82,080	1,207,934,976	250
3390-LA	57,042,420	127,020	1,459,588,096	25

**Table 149** Volume capacity information for each emulation type (continued)

<b>Emulation Type</b>	<b>Base LDEV Capacity (Blocks)</b>	<b>Minimum LDEV Capacity (Blocks)</b>	<b>Maximum Capacity of External LU (Blocks)</b>	<b>Maximum Number of LDEVs when Maximum Capacity of External LU is Mapped</b>
3390-LB	57,042,420	127,020	1,459,588,096	25
3390-LC	57,042,420	127,020	1,459,588,096	25
3390-9A	17,473,080	130,500	1,459,588,096	83
3390-9B	17,473,080	130,500	1,459,588,096	83
3390-9C	17,473,080	130,500	1,459,588,096	83
6588-9	17,473,080	130,500	1,459,588,096	83
6588-9A	17,473,080	130,500	1,459,588,096	83
6588-9B	17,473,080	130,500	1,459,588,096	83
6588-9C	17,473,080	130,500	1,459,588,096	83

## 28 Direct Backup Engine for the XP128/XP1024/XP12000

Direct Backup Engine provides server-free backup between an XP disk array and the backup devices connected to a host server. Server-free backup is non-disruptive backup, with data going directly from disk to tape (or disk to disk) in a storage area network (SAN) environment. Direct Backup Engine is optional software. You must purchase and install a license key for HP StorageWorks Direct Backup Engine XP. The current version of Direct Backup Engine supports VERITAS NetBackup 4.5, which currently supports only tape devices.

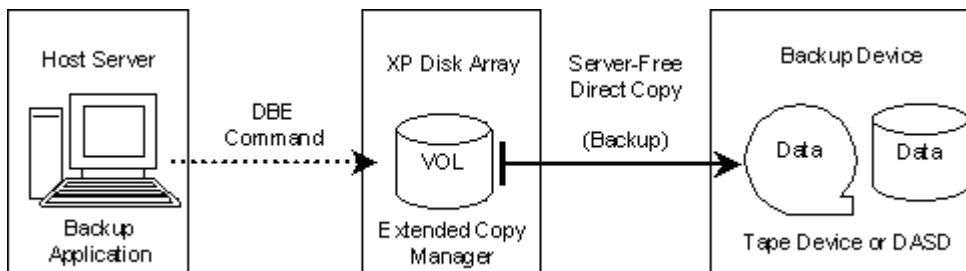

**Figure 435** Direct Backup Engine overview

## Direct Backup Engine commands

You can execute Direct Backup Engine commands from a host server that has NetBackup installed. When a *host group* on a *target port* on the disk array receives Direct Backup Engine commands from the host, specified data is copied to a tape drive or library device connected to an *initiator port* on the disk array.

The host remains online while data moves from device to device. The host's CPU and I/O resources are always available to other operations and applications.

## System requirements

### Host server requirements

**Operating system:** For backup servers, Sun Solaris 8 is required. For backup clients, Sun Solaris 8 or HP-UX 11.0 is required.

**Backup application:** VERITAS NetBackup 4.5 (including ServerFree Agent) or later.

### Supported backup devices

Direct Backup Engine supports the following backup devices:

- HP SureStore Tape Library 2/20 (DLT8000 and LTO Ultrium-1)
- HP SureStore Tape Library 4/40 (DLT8000 and LTO Ultrium-1)
- HP SureStore Tape Library 6/60 (DLT8000 and LTO Ultrium-1)
- StorageTek L180 Tape Library (LTO Ultrium-1)

- StorageTek L700 Tape Library (LTO Ultrium-1, T9940B)

For more information about these devices, see the vendor’s documentation.

## Disk array requirements

Direct Backup Engine supports all physical disk drive options and RAID level configurations of the disk array. The disk array must contain at least one port group, consisting of a target port for receiving Direct Backup Engine commands from the host server and an initiator port for copying data to the backup device.

Any installed Fibre Channel interface ports (packages) on the disk array can be set as target ports.

Initiator ports are dedicated Fibre Channel interface ports on the disk array that are connected to the backup devices. Fibre Channel interface ports (packages) supported by Continuous Access (CA) can be set as initiator ports.

## Starting Direct Backup Engine

1. In the Device Launcher pane, click an XP128, XP1024, or XP12000 link.
2. Click **Direct Backup Engine**. The Direct Backup Engine pane appears.

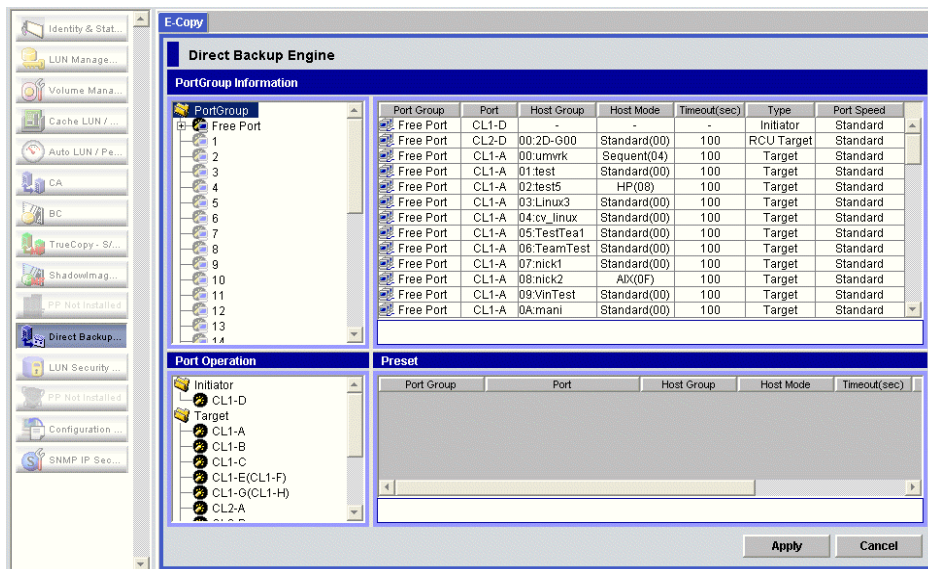

Figure 436 Direct Backup Engine pane

## Direct Backup Engine pane

This pane contains the following items.

### Port Group Information box

This box is in the upper part of the Direct Backup Engine pane. It contains the Port Group tree on the left and the Port Group table on the right.









### Port Group tree

This tree contains the following folders:

- **Free Port**: Lists all free ports that do not belong to any port group
- **Port Group** (1 - N [N = 32 for XP128/1024; N = 128 for XP12000]): Lists ports that belong to the selected group

The tree uses the following Fibre Channel port icons:

**Table 150** Fibre Channel port icons for Direct Backup Engine operations

Icon	Status
	A short-wave port in standard mode without LUN security.
	A short-wave port in standard mode with LUN security.
	A long-wave port in standard mode without LUN security.
	A long-wave port in standard mode with LUN security.
	A short-wave port in high-speed or high-speed (2 port) mode without LUN security.
	A short-wave port in high-speed or high-speed (2 port) mode with LUN security.
	A long-wave port in high-speed or high-speed (2 port) mode without LUN security.
	A long-wave port in high-speed or high-speed (2 port) mode with LUN security.



**NOTE:** High-speed (2 port) mode is available only if the XP disk array has firmware version 21.06.22 or later installed for an XP128/1024.

You can select only one port group at a time. To display information for all ports, select the Port Group folder at the top of the Port Group tree.

## Port Group Information table

This table displays ports belonging to the port group selected in the Port Group Information tree. You can select more than one port in the table. The table has the following columns and labels:

- **Port Group:** Port group name (Free Port or 1 - N [N = 32 for XP128/1024; N = 128 for XP12000]).
- **Port:** Name of the port (CL1-A, CL2-B, etc.) belonging to the selected port group.
- **Host Group:** Name of the host group used to classify host servers connected to the disk array.
- **Host Mode:** Host mode set by LUN Manager.
- **Timeout (sec):** Timeout period (35 - 290 seconds) set for the host group. The default is 100 seconds. For instructions on setting a timeout period, see "[Setting timeout periods](#)" on page 831.
- **Type:** Port type (Initiator, Target, or RCU Target).
- **Port Speed:** PCB mode (Standard or High Speed).

## Port Operation tree

This tree is in the left lower area of the Direct Backup Engine pane. It displays the folders (Initiator, Target, RCU Target, and External) that have free ports (ports that do not belong to any port group) in a tree. When a free port is set in a port group, that port is removed from the Port Operation tree at the same time. The tree contains the following folders:

- **Initiator:** Ports set as initiator ports. Initiator ports are dedicated fibre-channel interface ports on the disk array that are connected to the backup devices.
- **Target:** Ports set as ordinary target ports. Target ports are dedicated fibre-channel interface ports on the disk array that are connected to the host server(s).
- **RCU Target:** Ports set as RCU target ports. CA uses RCU target ports. To use an RCU target port for Direct Backup Engine, change it to an ordinary target port or initiator port. You cannot change a target port or initiator port to an RCU target port.
- **External:** Ports set as external ports. To use an external port for Direct Backup Engine, change it to an ordinary target port or initiator port. You cannot change a target port or initiator port to an external port.

## Preset table

This table is located in the right lower area of the Direct Backup Engine pane. It displays specified or changed settings (port information). Changed settings (port group and timeout period, or port type) are indicated by the before and after statuses separated by a bracket (>). For example, if the Port Group is **Free Port > 3**, the free port is assigned to port group 3.

The table does not display changes in blue. The table can hold multiple settings only if the settings are for the same operation (such as operations in the Port Group Information box or Port Operation tree). For example, when you set a port group or a timeout period, and the setting is displayed in the Preset table, you cannot change port types. To perform a different operation, apply the existing setting to the disk array by clicking **Apply**.

The Preset table contains the following columns and labels:

- **Port Group:** Port group name (Free Port or 1 - N [N = 32 for XP128/1024; N = 128 for XP12000])
- **Port:** Name of the port (CL1-A, CL2-B, etc.) belonging to the selected port group
- **Host Group:** Name of the host group set by LUN Manager
- **Host Mode:** Host mode set by LUN Manager
- **Timeout (sec):** Timeout period set for the host group
- **Type:** Port type (Initiator, Target, RCU Target, or External)
- **Error Code:** Error code if an error occurs when you click **Apply**
- **N Row(s) [Change Port] (Port Type Change):** Number of ports that you change the port type (N: the number of rows = the number of ports)
- Buttons
  - **Apply:** Applies settings to the disk array. Clicking **Apply** displays the I/O Check Confirmation pane, which verifies whether or not to perform an I/O check before changing the selected port(s). If all settings are applied successfully, the Preset table is cleared. Failed settings remain in the Preset table.
  - **Cancel:** Cancels all settings in the Preset table.

---

## Using Direct Backup Engine

You must register one or more port groups, and may have to change port types before you can use Direct Backup Engine.



Direct Backup Engine topics include the following:

- “Viewing detailed port information” on page 827
- “Adding ports to port groups” on page 828
- “Moving ports from port groups” on page 830
- “Setting timeout periods” on page 831
- “Changing target ports, RCU target ports, or external ports to initiator ports” on page 833
- “Changing initiator ports, RCU target ports, or external ports to target ports” on page 833

You must operate Command View in Modify mode to perform Direct Backup Engine operations. Users in View mode can only view Direct Backup Engine information.

## Viewing detailed port information

The **Detail** command displays detailed information about the selected port(s). If an error occurs, an error message is also displayed on the Detail pane.

1. In the Direct Backup Engine pane, select one or more ports from the Preset table, and right-click. A pop-up menu appears.

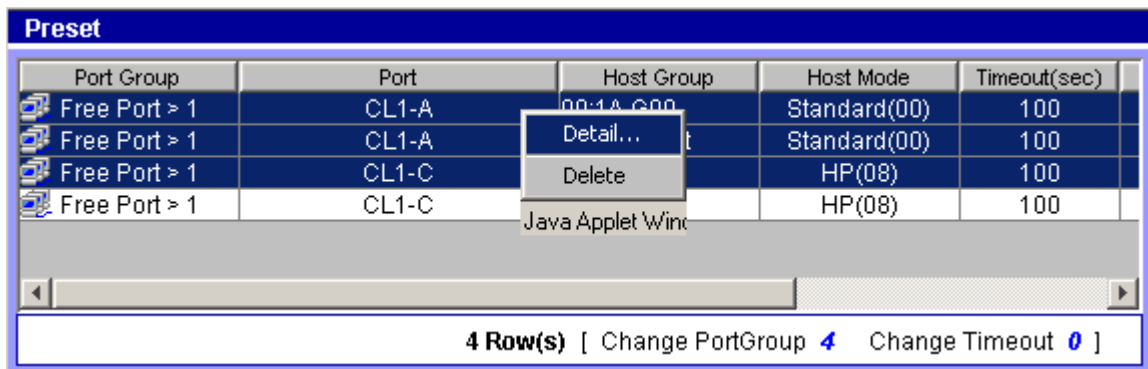

2. Click **Detail**. The Detail pane displays information about the port(s) selected.

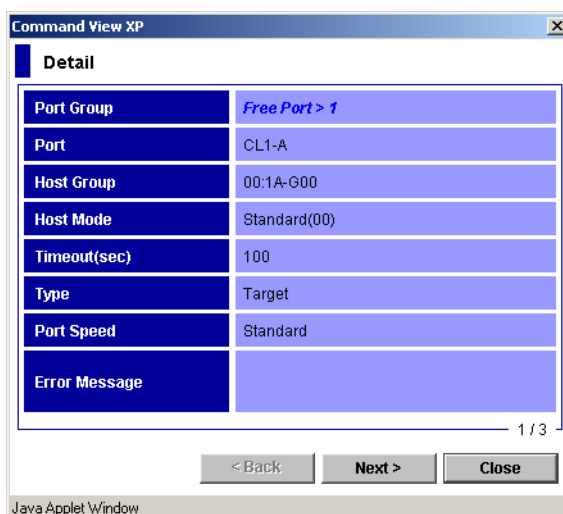

**Figure 437** Detail window

3. If two or more ports are selected, click **Next** to view the next port, or click **Previous** to view the previous port.
4. When you are done viewing port information, click **Close**.

The Detail pane contains the following information:

- **Port Group:** Port group name including *Free Port*. If you changed the port group, that change is displayed. For example, *Free Port > 3* means a free port is assigned to port group 3.
- **Port:** Port name (CL1-A, CL2-B, etc.).
- **Host Group:** Name of the host group set by LUN Management.
- **Host Mode:** Host mode set by LUN Management.
- **Timeout (sec):** Timeout period. If you changed the timeout period, that change is displayed. For example, *100 > 120* means the timeout period was changed from 100 to 120.
- **Type:** Port type (Initiator, Target, RCU Target, or External). If you changed the port type, that change is displayed. For example, *RCU Target > Initiator* means an RCU target port was changed to an initiator port.
- **Port Speed:** PCB mode (Standard or High Speed).
- **Error Message:** Error message displayed in red italic.

## Adding ports to port groups

Before adding ports, ensure that no Direct Backup Engine I/Os are being executed from the host server to the affected ports. If you continue adding ports that execute Direct Backup Engine commands without performing an I/O check, you cannot perform operations on those ports for about five minutes.

1. In the Direct Backup Engine pane, select a port group (1 - N [N = 32 for XP128/1024; N = 128 for XP12000]) from the Port Group tree, and right-click. A pop-up menu appears.

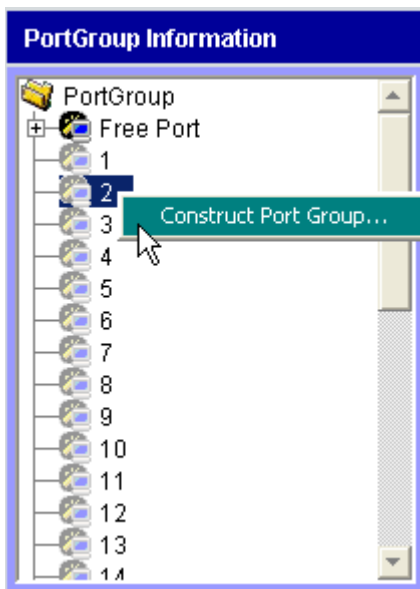

- Click **Construct Port Group**. The Construct Port Group pane appears.

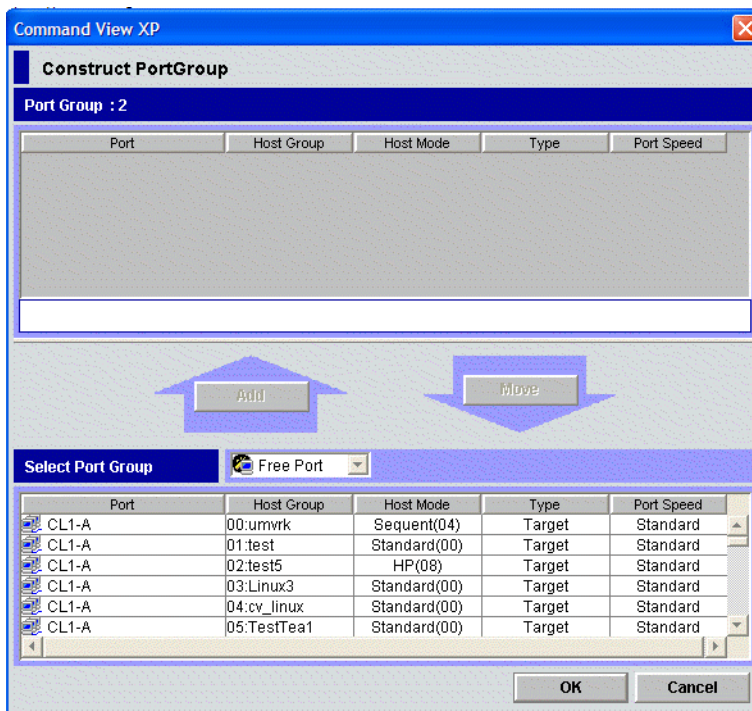

**Figure 438** Construct Port Group pane (adding ports)

The ports already assigned to the port group selected in [step 1](#) are displayed in the Port Group box in the Construct Port Group pane.

- In the **Select Port Group** list, click **Free Port** or a port group that has ports you want to add. You cannot click the same port group as the one selected in [step 1](#).
- In the Port table, click the target ports or RCU target ports and initiator ports. You can select more than one port. A port group must contain at least one initiator port and at least one target port (either an RCU target port or an ordinary target port).
- Click **Add**. The selected ports are added to the port group and displayed in the Port Group box.
- Click **OK**. The Construct Port Group pane closes, and the port information for the changed port group is displayed in the Preset table and Port Group Information table (in blue).

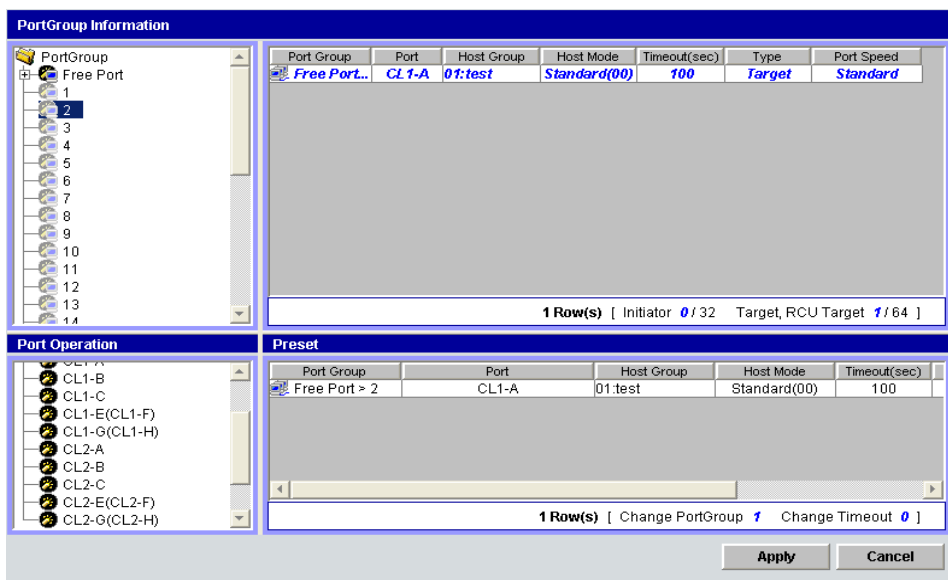

7. In the Direct Backup Engine pane, click **Apply**. The I/O Check dialog box appears.

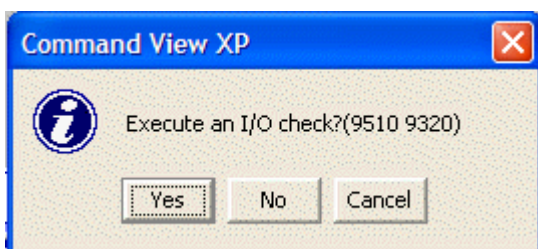

8. Click **Yes** to perform an I/O check before ports are added. Click **No** to forcibly add ports without first performing an I/O check. A confirmation dialog box appears.
9. Click **OK** to confirm. When the operation is completed, a confirmation dialog box appears.
10. Click **OK**. When the selected ports are added to the port group, the port information is cleared from the Preset table. Verify that the ports are added correctly and displayed in the Direct Backup Engine pane.

## Moving ports from port groups

Before moving ports, ensure that no Direct Backup Engine I/Os are being executed from the host server to the affected ports. If you continue adding ports that execute Direct Backup Engine commands without performing an I/O check, you cannot perform operations on those ports for about five minutes.

1. In the Direct Backup Engine pane, select Free Port or a port group (1 - N [N = 32 for XP128/1024; N = 128 for XP12000]) from the Port Group tree, and right-click. A pop-up menu appears.
2. Click **Construct Port Group**. The Construct Port Group pane appears.  
Available free ports or ports already assigned to the port group selected in [step 1](#) are displayed in the Port Group box in the Construct Port Group pane.
3. In the **Select Port Group** list, click **Free Port** or the port group to which you want to move the ports in the Port Group box. You cannot click the same port group as the one selected in [step 1](#).

4. In the Port Group box, click the ports you want to move to the port group in the Port table. You can select two or more ports.

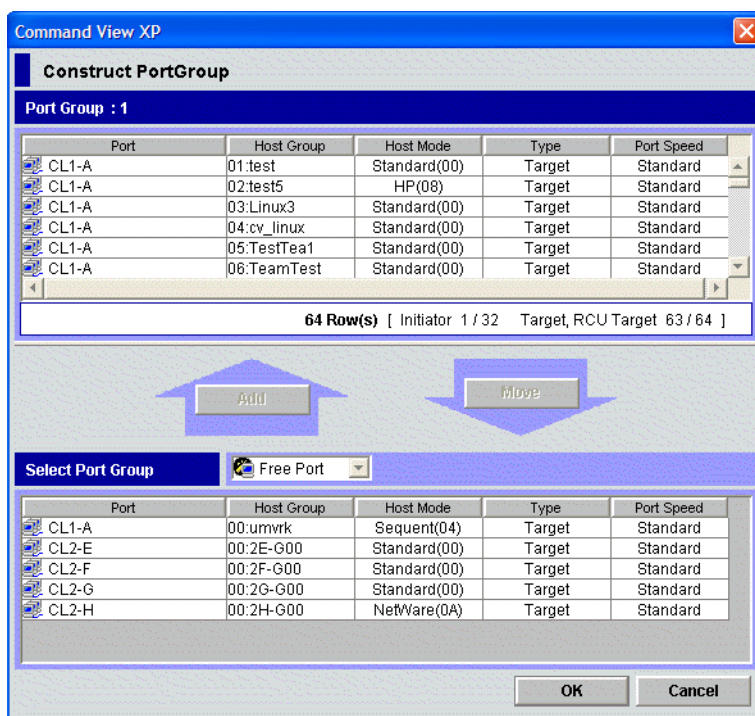

**Figure 439** Construct Port Group pane (moving ports)

5. Click **Move**. The selected ports move from the Port Group box to the Port table.
6. Click **OK**. The Construct Port Group pane closes, and the port information for the changed port group is displayed in the Preset table and Port Group Information table (in blue).
7. In the Direct Backup Engine pane, click **Apply**. The I/O Check dialog box appears.
8. Click **Yes** to perform an I/O check before ports are moved. Click **No** to forcibly move ports without first performing an I/O check. A confirmation dialog box appears.
9. Click **OK** to confirm. When the operation is completed, a confirmation dialog box appears.
10. Click **OK**. When the selected ports are moved, the port information is cleared from the Preset table. Verify that the ports are moved correctly and displayed in the Direct Backup Engine pane.

## Setting timeout periods

Before setting timeout periods, ensure that no Direct Backup Engine I/Os are being executed from the host server to the affected ports. If you continue adding ports that execute Direct Backup Engine commands without performing an I/O check, you cannot perform operations on those ports for about five minutes.

1. In the Direct Backup Engine pane, select a port group (1 - N [N = 32 for XP128/1024; N = 128 for XP12000]) from the Port Group tree. The port information for the selected port group is displayed in the Port Group table.
2. Select a port in the host group for which you want to set a timeout period, and right-click.

You can select multiple ports, but a timeout period is set by the host group. Therefore, if you select two ports that have different host groups, and set a timeout period, the same timeout period is set for both host groups. A pop-up menu appears.

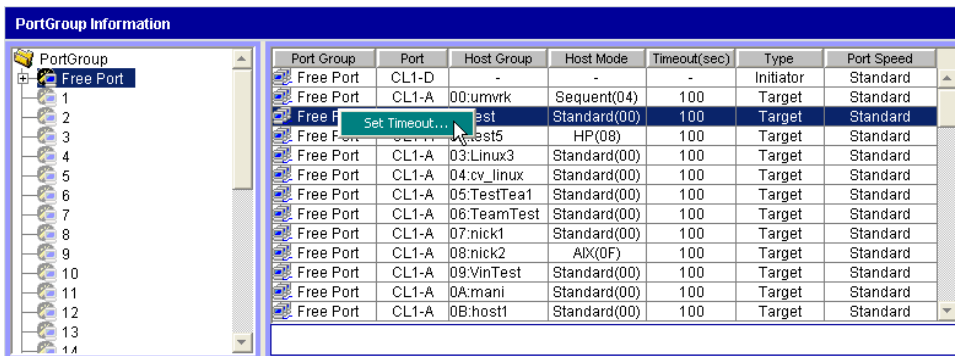

3. Click **Set Timeout**. The Set Timeout pane appears.

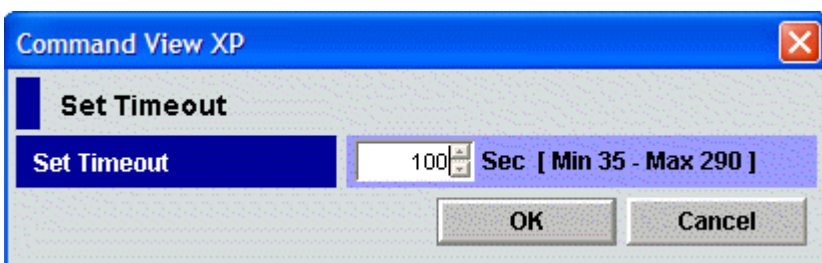
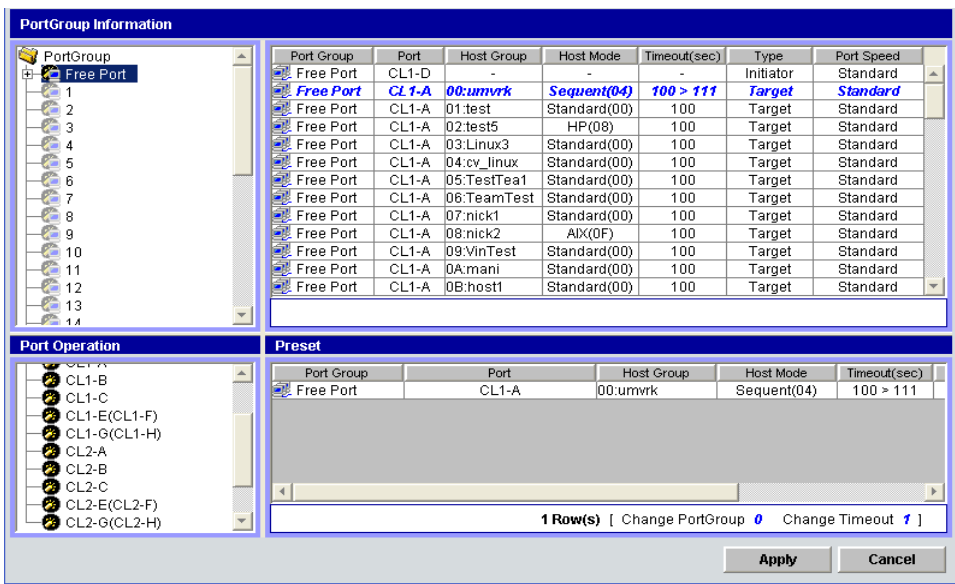

Figure 440 Set Timeout dialog box

4. In the **Set Timeout** box, enter a timeout period (35 to 290 sec). You can enter a value in the box or use the scroll bar to change the value. The default is 100 seconds.

5. Click **OK**. The Set Timeout dialog box closes, and the setting is displayed in the Preset table and Port Group Information table (in blue).



6. In the Direct Backup Engine pane, click **Apply**. The I/O Check dialog box appears.

7. Click **Yes** to perform an I/O check before the timeout period is set. Click **No** to forcibly set the timeout period without first performing an I/O check. A confirmation dialog box appears.

8. Click **OK** to confirm. When the operation is completed, a confirmation dialog box appears.

- Click **OK**. When the timeout period is set, the port information is cleared from the Preset table. Verify the timeout period is set correctly and displayed in the Direct Backup Engine pane.

## Changing target ports, RCU target ports, or external ports to initiator ports

Before changing a port to an initiator port, ensure that no Direct Backup Engine I/Os are being executed from the host server to the affected ports. You can change the port type of free ports only.

- In the Direct Backup Engine pane, select the Target, RCU Target, or External folder in the Port Operation tree to display free ports.
- Select the free port you want to change to an initiator port, and right-click. A pop-up menu appears.

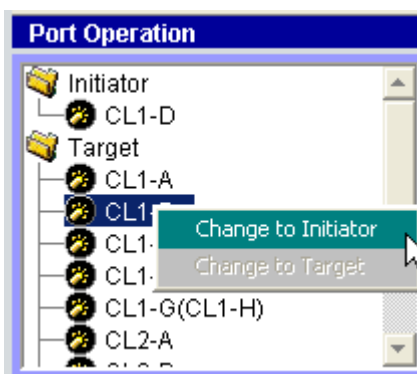

- Click **Change to Initiator**. The selected port moves from Target, RCU Target, or External to Initiator, and is shown in blue. The changed port is also displayed in the Preset table.

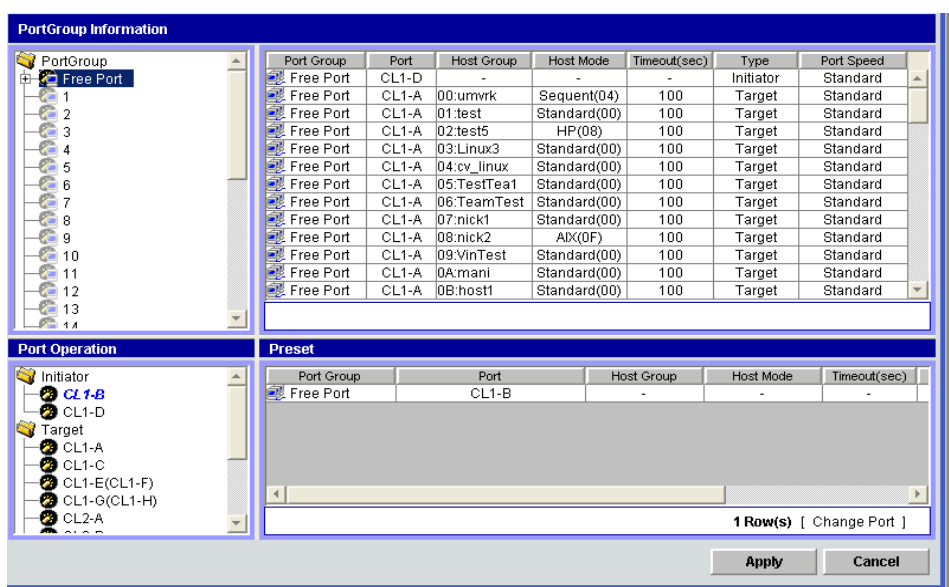

- In the Direct Backup Engine pane, click **Apply**. When the port type is changed successfully, it is cleared from the Preset table and displayed in the Port Operation tree.
- Verify that the changed port is correctly displayed in the Direct Backup Engine pane.

## Changing initiator ports, RCU target ports, or external ports to target ports

Before changing a port to a target port, ensure that no Direct Backup Engine I/Os are being executed from the host server to the affected ports. You can change the port type of free ports only.



1. In the Direct Backup Engine pane, select the Initiator, RCU Target, or External folder in the Port Operation tree to display free ports.
2. Select the free port (initiator or RCU target) you want to change to a target port, and right-click. A pop-up menu appears.

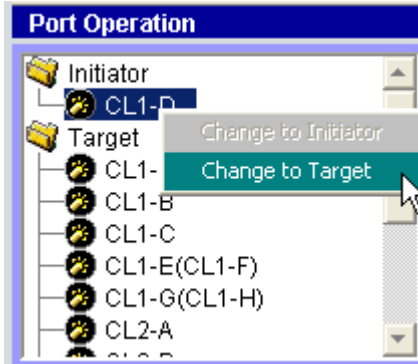

3. Click **Change to Target**. The selected port moves from Initiator, RCU Target, or External to Target, and is shown in blue. The changed port is also displayed in the Preset table.

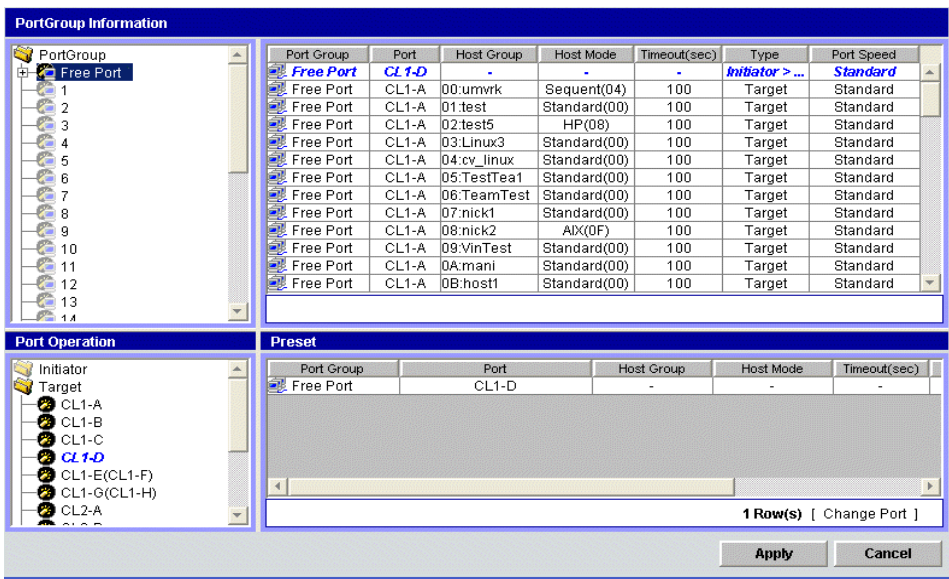

4. In the Direct Backup Engine pane, click **Apply**. When the port type is changed successfully, it is cleared from the Preset table and displayed in the Port Operation table.
5. Verify that the changed port is correctly displayed in the Direct Backup Engine pane.



# A Troubleshooting

This appendix contains Command View troubleshooting information for open systems. For TrueCopy, ShadowImage, and SANtinel on mainframe systems, see the *HP StorageWorks Command View XP for Main Frames User Guide*. For troubleshooting information on External Storage XP for the XP12000, see the External Storage chapter of this user guide.

This appendix provides recommended solutions for the following topics:

- [Browser displays “Data Retrieval in Progress” message for a long time \(XP48/XP512 only\)](#), page 835
- [Browser displays “The storage capacity of an audit log remains and is slight” message](#), page 835
- [Mozilla browser is incorrectly displaying some features on HP-UX](#), page 836
- [Device Health pane displays red or yellow disk array components](#), page 836
- [Session Administration pane reports the incorrect host address](#), page 837
- [The disk array license key installation fails](#), page 837
- [Identity and Status panes contain outdated information \(XP48/XP512 only\)](#), page 837
- [Problems occur when removing LUSE volumes from Volume Management](#), page 838
- [The refresh fails with an SNMP timeout error \(XP48/XP512 only\)](#), page 838
- [Command View reports “possible Auto LUN initialization problem”](#), page 838
- [Error occurs when entering the IP Address in the Device Administration pane](#), page 838
- [Configuration File Loader fails to start or the spreadsheet file cannot be uploaded](#), page 839
- [Business Copy fails or does not function properly](#), page 839
- [Continuous Access fails or does not function properly](#), page 840

For troubleshooting information about installing, configuring, and logging on to Command View, or for recommendations for solving host agent installation and configuration problems, refer to the *HP StorageWorks Command View XP Installation Guide*. For troubleshooting information specific to Path Connectivity, refer to the *HP StorageWorks Command View XP Path Connectivity User Guide*.

## Browser displays “Data Retrieval in Progress” message for a long time (XP48/XP512 only)

The SNMP service on the Command View server is most likely disabled, uninstalled, or stopped. For the Command View server to work properly, SNMP and SNMP trap services should be running. Verify that these services are running correctly on your server and try again.

## Browser displays “The storage capacity of an audit log remains and is slight” message

The audit log has reached capacity and needs to be downloaded. After logging in, click **Audit:Warning** to download the audit log.

## Mozilla browser is incorrectly displaying some features on HP-UX

If you are unable to view Device Administration or other features in the Command View management station in the Mozilla Browser on HP-UX, you will need to adjust your settings in the Mozilla on HP-UX. If you are working behind the proxy, follow these instructions to set up the correct proxy name, IP address, and port:

1. Open the browser.
2. Click **Edit -> Preferences**. The Preferences Window appears.
3. In the left pane of the Preferences window, click **Advanced -> Proxies**.
4. Select Manual proxy configuration.
5. Set the HTTP, SSL, FTP, etc... proxies and appropriate ports for the same.
6. Click **OK**.

**To remove all the cookies and select "Enable cookies for the originating Web site only" in Mozilla:**

1. Open the browser.
2. Click **Edit -> Preferences**. The Preferences Window appears.
3. In the left pane of the Preferences window, click **Privacy & Security -> Cookies**.
4. Select "Enable cookies for the originating web site only" and click **Manage Stored Cookies**. The Cookie Manager window will be displayed.
5. Select the Stored Cookies tab. If any cookies are displayed, click **Remove all cookies**.
6. Click **Close** in Cookie Manager.
7. Click **OK** in the Preferences Window.

**To clear history in Mozilla:**

1. Open the browser.
2. Click **Edit -> Preferences**. The Preferences Window appears.
3. In the left pane of the Preferences window, click **Navigator -> History**.
4. Click **Clear History** in the Preferences Window.
5. Click **OK**.

**To Clear Cache in Mozilla:**

1. Open the browser.
2. Click **Edit -> Preferences**. The Preferences window appears.
3. In the left pane of the Preferences window, click **Advanced -> Cache**.
4. Click **Clear Cache**.
5. Click **OK**.

## Device Health pane displays red or yellow disk array components

The disk array's physical status is reported according to groups or types of components. To locate the source of the problem (yellow or red state), do the following:

- Determine the potential problem area (disks, processors, environmental monitor, etc.). Examining the picture of the disk array from Command View XP should locate the problem. You can also read the list of status conditions provided to the left of the XP disk array image.

- Examine the list of trap information provided by clicking the **Array Event History** tab. The trap history may provide further information about physical failures in the XP disk array.
- Perform a physical/visual examination of XP disk array status lights to verify the problem indicated in the Command View XP application.
- If you continue to have problems, contact your HP account support representative to resolve the issue.

## Session Administration pane reports the incorrect host address

If the Session Administration pane shows the wrong host address, you most likely have a Web proxy server problem. To fix this, either disable the proxy server in your browser (Internet Explorer only) or add the Command View XP management station IP address to the list of excluded addresses that are **not** to be directed through a Web proxy service.

To disable the proxy service in Internet Explorer:

1. In Internet Explorer, click **Tools > Internet Options > Connections > LAN Settings**.
2. Clear the **Use a proxy server** check box.
3. Click **OK**. Click **OK** again to exit and save changes.

To add IP addresses in Internet Explorer:

1. In Internet Explorer, click **Tools > Internet Options > Connections > LAN Settings**.
2. Click **Advanced**.
3. Add the IP address of the disk array to the **Exceptions** box.
4. Click **OK**. Click **OK** again to exit and save changes.

To add IP addresses in Netscape:

1. In Netscape, click **Edit > Preferences > Advanced > Proxies**.
2. Click **Manual Proxy Configuration**.
3. Click **View**.
4. Enter the IP address of the disk array to the **Exceptions** list. Use commas to separate entries.
5. Click **OK**. Click **OK** again to exit and save changes.

## The disk array license key installation fails

Certain XP disk array license keys must be installed in a specific order:

- Install the Continuous Access XP key before the Continuous Access XP Extension key.
- Install the ShadowImage key before the FlashCopy Extension key.
- Install the TrueCopy key before the TrueCopy Asynchronous key.

If this installation order is not followed, the installation will fail with a generic message indicating that another key must be installed first.

## Identity and Status panes contain outdated information (XP48/XP512 only)

If you have applied changes in LUN Manager or Volume Management, you may notice the information on the Identity or Status pane is not consistent with these changes. To correct this, you must update the Identity and Status panes to reflect the latest changes. To do this, click **Update** on the Identity pane.

## Problems occur when removing LUSE volumes from Volume Management

Only LUSE volumes that have been allocated can be released. Additionally, when removing a LUSE Volume, verify that the CU folder is highlighted (under the LDEV Information tree), instead of an LDEV underneath the CU folder. After this you can proceed to remove the LUSE volume.

## The refresh fails with an SNMP timeout error (XP48/XP512 only)

If an SNMP timeout error occurs when attempting to refresh or if subsequent refresh attempts display the following message: “No such variable in MIB”, a refresh may have been in progress when the Service Processor (SVP) of an XP48/XP512 was rebooted.

To clear the error and begin a new refresh of XP disk array data, follow these steps:

1. Access Session Administration by clicking **Array Manager** in the left pane and then the **Session Administration** tab. The Session Management pane appears.
2. Click the disk array exhibiting the error from the **Disk Array** box.
3. Click **End Session**.
4. Click the **Main** tab.
5. Click the link to the disk array exhibiting the error and begin a new refresh.

## Command View reports “possible Auto LUN initialization problem”

Auto LUN configuration for the XP128/XP1024/XP12000: If the short-range monitor and long-range monitor are set to *off* on the Auto LUN pane, click the **Monitoring Options** tab. Specify the gathering interval and click **Apply**. Auto LUN will now collect its monitoring data.

For the XP128/XP1024/XP12000 Auto LUN functionality, there may be times when upon loading Auto LUN you will receive a “No Monitoring Data” message. This means that no input/output traffic has occurred on the disk array. Once I/O does begin, however, this message will no longer be displayed.

If you continue to experience problems, contact your HP account support representative for further assistance.

## Error occurs when entering the IP Address in the Device Administration pane

Several possible causes can create the following error message when you enter the IP address in the Device Administration pane: “Could not connect to Agent, or check the format of the IP Address. For more details, see the Help window. FAILURE.” Possible causes include the following:

- The connection to that IP address is down
- The format of the IP address is incorrect
- IP security could be enabled on the SVP (XP48/XP512)
- The SNMP agent is not configured on the SVP (XP48/XP512)
- Incompatible firmware (see the Command View `readme.txt` for additional information)

# Configuration File Loader fails to start or the spreadsheet file cannot be uploaded

If you cannot upload the spreadsheet file in Configuration File Loader, check the spreadsheet for possible errors. When the error information is displayed in the Error Information list, edit the spreadsheet according to the information listed. Possible errors include the following:

- First row of the spreadsheet (the declaration row) is not written correctly. For information on the declaration row, see "[Spreadsheet declaration](#)" on page 307.
- Spreadsheet file is not in the text file format (the file is a binary file).
- No function tag exists in the spreadsheet. For information on the function tag, see "[Function tag](#)" on page 307.
- File name is incorrect. For example, the extension is not *.spd* or the file name exceeds the maximum number of letters.
- Number of letters in a row exceeds 128.
- Number of rows in a spreadsheet exceeds 70,000.
- The program product that is stated in the declaration row is not installed. For information on the declaration row, see "[Spreadsheet declaration](#)" on page 307.

## Business Copy fails or does not function properly

If a problem occurs with the Command View management station when using BC, or if BC operations do not function properly, try the following:

- Make sure all BC requirements and restrictions are met. Verify that the PC's operating system and LAN hardware and software are properly configured.
- Make sure the disk array is powered on and fully functional (NVS, cache, DFW).
- Check all input values and parameters to make sure that you entered the correct information on the BC panes (such as P-VOL and S-VOL IDs).
- Exit the Web browser, close all other applications, and then restart the PC.
- If the volume pairs are not displaying correctly, make sure the correct CU image is selected.
- If a BC error message is displayed on the Command View management station, refer to "[BC error codes](#)" on page 478 for a description of the error code.
- If the BC pair status is incorrect or unexpected, the pair may have been suspended or deleted from the UNIX/PC server host using RAID Manager XP. If not, the disk array detected an error condition during BC operations. Check the Command View error log. If necessary, call your HP Account Support Representative for assistance.
- If a pinned track occurs on a BC P-VOL or S-VOL, the disk array will suspend the pair. Please contact your HP account support representative for assistance in recovering pinned tracks.
- If only the Exit and Refresh buttons are available when accessing the disk array from the Command View management station, the disk array might not be ready to perform some write processes from the other system. Wait for a while, and then click **Refresh**.
- If the problem persists, save the Java log file on the Command View management station and report to HP technical support. For Windows 2000, the Java log file (plugin.trace) location is  
C:\Documents and Settings\login user ID.

## Continuous Access fails or does not function properly

If a problem occurs with the Command View management station when using CA, or if CA operations do not function properly, try the following:

- Make sure that the problem is not being caused by the PC or Ethernet hardware or software, and then restart the PC. Restarting the Command View management station does not affect disk array operations.
- Make sure that all CA requirements and restrictions are met.
- Make sure that the MCU and RCU and remote copy connections are powered on and fully operational (NVS, cache).
- Check all input values and parameters to make sure that you entered the correct information in Command View (for example, RCU S/N and SSID, path parameters, P-VOL and S-VOL IDs).
- If an RCP or initiator channel-enable LED indicator (on the disk array's control window) is off or flashing, call HP technical support for assistance.
- If the volume pairs and/or RCUs are not displaying correctly, make sure that the correct CU image is selected.
- If the RCU path status is not normal, check the path status (RCU Status window), and refer to [Table 151](#) on page 840 for possible solutions.
- If the pair status is suspended, check the pair status (Pairdisplay window), and see [Table 152](#) on page 842 for possible solutions.
- If the paircreate or pairresync operation resulted in a timeout error, there could be two possible causes:
  - Hardware failure: If the timeout error was caused by a hardware failure, a SIM will be generated. If this occurs, call your HP Account Support Representative, and retry CA operations after the problem is fixed.
  - Heavy workload: If no SIM was generated, wait for 5 to 6 minutes, then check the pair status of the pair(s) being created or resumed. If the pair status changed correctly, the failed operation completed after the timeout message was issued. If the pair status did not change as expected, heavy workload might have prevented the CA operation from being completed. In this case, retry the CA operation again when the disk array has a lighter workload.
- If there is a pinned track on a CA volume, refer to [Table 153](#) on page 843 for possible solutions.

## Troubleshooting RCU path status problems

The following table provides troubleshooting instructions for RCU paths.

**Table 151** RCU path status troubleshooting

Path Status	Description	Corrective Action
Initialization Failed	The link initialization procedure to the RCU failed.	Make sure that you entered the correct RCU S/N and SSID and path parameters (port, link address, logical address).  For Fibre Channel, make sure that the correct MCU port is configured as an initiator port and the correct RCU port is configured as an RCU target port.  For serial, make sure the correct MCU port is configured as an RCP and the correct RCU port is configured as an LCP.

**Table 151** RCU path status troubleshooting (continued)

Path Status	Description	Corrective Action
Communication Time Out	Communication between the MCU and RCU timed out.	<p>Make sure that the RCU is powered on and fully functional (NVS and cache ON).</p> <p>Make sure that the remote copy connection hardware (cables, connectors, ESCDs) is properly configured and functional.</p> <p>Delete the failed path. You may need to change the minimum paths setting or delete the RCU in order to delete the path. Then register the path/RCU.</p>
Resource Shortage (MCU/RCU)	The MCU/RCU rejected the establish logical path link control function because all logical path resources in the MCU/RCU are being used for other connections.	<p>Delete the failed path, and also delete all paths and RCUs not currently in use. The MCU can be connected to up to four RCUs with up to eight paths to each RCU.</p> <p>Make sure that all MCU and RCU ports are properly configured:                      Fibre – ordinary target ports or RCU target ports for hosts, RCU target ports for MCUs, initiator ports for RCUs.                      Serial – LCPs for hosts and MCUs, RCPs for RCUs.</p> <p>If necessary, connect to the RCU to delete paths/RCUs and reconfigure ports, then reconnect to the MCU.</p> <p>Register the path/RCU again.</p>
Serial Number Mismatch	The RCU's S/N does not match the specified S/N.	<p>Make sure that you entered the correct RCU S/N and SSID and path parameters (port, link address, logical address).</p> <p>Delete the failed path. You may need to change the minimum paths setting or delete the RCU in order to delete the path. Then register the path/RCU.</p>
Invalid Port	The specified port is not configured as an RCP or initiator port, or this path already exists.	<p>For fibre, make sure that the correct MCU port is configured as an initiator ports. Make sure that the correct RCU port is configured as an RCU target port.</p> <p>For serial, make sure the correct MCU port is configured as an RCP and the correct RCU port is configured as an LCP.f</p> <p>Make sure that you entered the correct RCU S/N and SSID and path parameters (port, link address, logical address).</p> <p>Delete the failed path. You may need to change the minimum paths setting or delete the RCU in order to delete the path. Then register the path/RCU.</p>
RCU Port Number Mismatch	The specified port in the RCU is physically disconnected from the MCU, or the port is not configured as an RCU target port.	<p>Make sure that you entered the correct RCU port number. Correct the port number if necessary.</p> <p>Make sure that the port in the RCU is configured as an RCU target port. Configure the port as an RCU target port if necessary.</p> <p>Make sure that the MCU and RCU are physically connected.</p>
<blank>	This path was not established.	Delete the failed path. You may need to change the minimum paths setting or delete the RCU in order to delete the path. Then register the path/RCU.

## Troubleshooting suspended CA pairs

The following table provides troubleshooting instructions for suspended CA pairs (Synchronous and Asynchronous).

**Table 152** Suspended CA pairs troubleshooting

Suspend Type	Applies to	Description	Corrective Action
PSUE, by RCU	P-VOL	The MCU detected an error condition at the RCU that caused the MCU to suspend the volume pair. The S-VOL suspend type is <i>by MCU</i> .	Clear the error condition at the RCU or S-VOL. If you need to access the S-VOL, split the pair (pairsplit-r) from the MCU using the S-VOL write enable option.  Resume the pair (pairresync) from the MCU after the error condition is cleared.
PSUE, S-VOL Failure	P-VOL	The MCU detected an error during communication with the RCU or an I/O error during update copy. In this case, the suspend type for the S-VOL is usually <i>by MCU</i> .	Check the path status on the RCU Status window.  Clear any error conditions at the RCU or S-VOL. If you need to access the S-VOL, split the pair (pairsplit-r) from the MCU using the S-VOL write enable option.  Resume the pair (pairresync) from the MCU after the error condition is cleared.
PSUE, MCU IMPL	P-VOL, S-VOL	The MCU could not find valid control information in its nonvolatile memory during the IMPL procedure. This error occurs only if the MCU is without power for more than 48 hours (power failure and fully discharged batteries).	Resume the pair (pairresync) from the MCU. The MCU will perform an entire initial copy operation in response to the pairresync request.
PSUE, Initial Copy Failed	P-VOL, S-VOL	The MCU suspended this pair during the initial copy operation. The data on the S-VOL is not identical to the data on the P-VOL.	Delete the pair from the MCU. Clear all error conditions at the MCU, P-VOL, RCU, and S-VOL. Restart the initial copy operation using the Paircreate window.
PSUE, MCU P/S-OFF	S-VOL (Async)	The MCU suspended all CA Async pairs due to MCU power-off.	None. The MCU will automatically resume these CA Async pairs during power-on.
PSUS, Sidefile Overflow	P-VOL S-VOL	The amount of sidefile exceeds the specified current pending update data rate, and the RCU data is not transferred within the specified offloading timer.	Add cache memory, increase the number of paths between MCU and RCU, or decrease the number of Async pairs or host I/Os.

## Resolving CA Async suspension conditions

The following table provides troubleshooting instructions for the CA Async suspension conditions caused by the offloading timer async option, the group timeout options (copy pending and RCU ready), and



recordset errors. Hardware failures that affect the cache storage/shared memory of the MCU or RCU may also cause the CA Async volume pairs to be suspended.

**Table 153** CA Async Suspension Conditions

Classification	Causes of Suspension	SIM	Recovery procedure
MCU/RCU hardware	<p>Hardware redundancy has been lost due to some blockade condition. As a result, MCU-RCU communication, creating or receiving recordset, or the staging or de-staging process could not complete.</p> <p>The pending recordset cannot be retained because one side of cache storage or shared memory has been blocked due to hardware failure.</p> <p>MCU-Creating/sending recordset failed due to unrecoverable hardware failure.</p> <p>RCU-Reading/settling recordset failed due to unrecoverable hardware failure.</p> <p>The drive parity group was in correction-access status while the CA pair was in COPY state.</p>	DB0x DB1x DB2x	<p>According to SIM, remove the hardware blockade or failure.</p> <p>Re-establish failed volume pairs (pairresync).</p>
MCU-RCU communication	<p>During the power-on-reset sequence, the MCU could not communicate with the RCU within the specified RCU ready timeout.</p> <p>The RCU could not settle the pending recordset or could not communicate with the MCU before the copy pending timeout due to MCU not-ready or inoperative facilities on the remote copy connections.</p>	DB0x DB1x	<p>Remove the failed condition at the RCU/MCU or on the remote copy connection.</p> <p>Re-establish failed pairs (pairresync).</p>
RIO overload	<p>The unrecoverable RIO (remote I/O) timeout occurred due to overload of the RCU or the communication facilities on the remote copy connections.</p> <p>No recordset could be sent within the specified copy pending timeout.</p> <p>The RCU could not settle the pending recordset before the copy pending timeout due to overload of the RIO or the RCU itself.</p>	DB1x	<p>Delete failed pairs (pairsplit-S).</p> <p>Reconsider the performance resources necessary, and increase resources as needed (cache amount, number of MCU-RCU paths, etc.).</p> <p>Re-establish failed pairs (paircreate).</p>
RIO failure	<p>The RIO (remote I/O) could not complete due to the failure at the RCU.</p>	DB2x	<p>According to SIM generated at the RCU, remove the failure.</p> <p>Re-establish failed pairs (pairresync).</p>
MCU planned outage	<p>The CA Async pairs were temporarily suspended due to a planned outage of the MCU.</p>	DB8x	<p>No recovery procedure is required. The MCU will automatically remove the suspension condition during the next power-on-reset sequence.</p>



# Index

## Numerics

16-Port FC/CA CHIP 183  
2 port mode 190, 219

## A

access attributes 285, 287, 292  
access path usage statistics 346, 378  
ACP/Ldev Map pane 130  
ACU (Array Configuration Utility) 770  
ACU Selective Storage Presentation (SSP) 771  
Add CT Group pane 550  
Add LU 797  
Add LU window 792  
addresses  
  disk array 48, 49  
  Fibre Channel ports 167, 189, 219  
  iSCSI ports 192  
  troubleshooting IP 838  
administrators  
  adding users 63  
  default user names and passwords 43  
  passwords, changing 64  
  properties of 60  
  user groups 58  
  users, modifying 62  
AIX  
  host modes 165, 186  
  operating systems supported 39  
alerts. See event notifications  
AL-PA addresses 189  
alternate paths  
  defining 212, 758, 800  
  viewing 214  
Application Admin pane 69  
applications  
  adding 70  
  administration pane 69  
  deleting 71  
  editing 71  
  integrating with Command View 39  
arbitrated loop physical address (AL-PA) 189  
Array Configuration Utility 770  
Array Configuration Utility (ACU) 770  
Array Event History pane 81  
Array IP 48  
Array IP address 49  
Array Manager  
  Device Administration 48  
  Device Launcher 47  
  Session Administration 53

Array Membership pane 66  
ASCII codes 50  
Async Option 553  
Asynchronous Operation pane 525  
At-Time Split function 440  
Attribute tab 391  
audience, documentation 35  
Audit  
  Normal 98, 101  
  Warning 98, 101  
audit log file 101  
authorized resellers, HP 37  
Auto LUN  
  auto migration 349, 362, 388  
  BC, combining with 446  
  estimating usage rates 349  
  External Storage XP 762  
  features 345  
  fixing parity groups 393  
  graphs 366  
  History tab 395  
  LDEV tab 367, 369  
  manual migration 351, 362, 385  
  migration operations 348  
  migration plans 385  
  Monitoring Data 365  
  Monitoring Options 370  
  Monitoring Term 365  
  Performance Control 399  
  Physical tab 367, 369  
  Port-LUN tab 367, 368  
  powering off disk arrays 363  
  releasing parity groups 394  
  reserve volumes 348, 350  
  restrictions 360  
  starting 363  
  statistics 345, 372  
  Table selection 366  
  target volumes 393  
  tasks 347  
  troubleshooting 411, 838  
  user restrictions 44  
  WWN tab 367  
Auto LUN pane 365  
Auto Map Setting window 794

- auto migration
  - execution [362](#)
  - history [395](#)
  - parameters [349](#)
  - planning [362](#)
  - powering off disk arrays [363](#)
  - reserving target volumes [393](#)
  - settings [388](#)

## B

- backup utility, Command View [45](#)
- Base information, System pane [141](#)
- basic information [115](#)
- Basic Information icon, Identity pane [99](#)
- battery backup [325](#), [332](#)
- BC

- At-Time Split function [440](#)
- CA, combining with [513](#)
- cascade function [427](#), [436](#)
- cascade pairs [415](#)
- combining with other features [446](#)
- components [413](#)
- Copy Pace list [462](#), [467](#)
- creating and splitting pairs [469](#)
- Detail window [455](#)
- Display Filter window [456](#)
- Display pane [451](#)
- error codes [478](#)
- external LUs [763](#)
- features [413](#)
- Flex Copy operations [726](#)
- history [475](#)
- Host I/O Performance option [436](#)
- initial copy operation [425](#)
- main screen [451](#)
- normal pairresync operation [428](#)
- operations [413](#)
- options [477](#)
- pair status conditions [443](#)
- paircreate operation [425](#), [461](#)
- pairresync operation [428](#), [470](#)
- pairs, maximum number of [417](#), [420](#)
- pairsplit operation [427](#), [465](#)
- pairsplit-E (suspend) operation [434](#), [473](#)
- pairsplit-S (delete) operation [434](#), [474](#)
- power supply, switching off [444](#)
- preparing for operations [445](#)
- Preset Volume list [457](#)
- protecting logical volumes [294](#)
- quick pairresync operation [428](#)
- quick restore pairresync operation [429](#)
- quick split operation [427](#)
- requirements [416](#), [419](#)
- reset reserve attribute operation [425](#)
- Reset Reserve Attribute window [460](#)
- reverse pairresync operation [429](#)
- Select MU list [462](#), [467](#)
- Select S-VOL box [463](#), [467](#)
- set reserve attribute operation [424](#)

- Set Reserve Attribute window [459](#)
- shortcut commands [455](#)
- source volumes [360](#)
- starting operations [450](#)
- status [442](#), [475](#)
- status icons [451](#)
- steady split operation [427](#)
- S-Vol Path window [456](#)
- Swap&Freeze option [435](#), [478](#)
- system requirements [444](#)
- Tree View [451](#)
- troubleshooting [839](#)
- update copy operation [426](#)
- Volume list [453](#)
- volume pairs [414](#)
- bind mode for Cache LUN
  - XP128/XP1024/XP12000 [332](#)
  - XP48/XP512 [325](#)
- Blockade function [277](#)
- browsers, accessing Command View [42](#)
- Business Copy. See BC

## C

- CA
  - about [485](#)
  - BC, combining with [446](#), [513](#)
  - cache requirements [506](#)
  - Change Pair Option command [578](#)
  - combining with other operations [512](#)
  - Command View management station [490](#)
  - components [486](#)
  - configuration operations [531](#)
  - consistency groups [489](#), [505](#)
  - consistency of S-VOLs [586](#)
  - currency of S-VOLs [585](#)
  - disaster recovery [582](#)
  - discontinuing operations [560](#)
  - Display Filter pane [520](#)
  - error codes [588](#)
  - Fibre Channel remote copy connections [507](#)
  - functions [516](#)
  - History Operations pane [527](#)
  - host failover software [491](#)
  - host requirements [506](#)
  - initial copy operation [491](#)
  - initial copy options [568](#)
  - installing hardware [506](#)
  - LU parameters, modifying [562](#)
  - LU types supported [505](#)
  - LUs, deleting [563](#)
  - LUSE pairs [498](#)
  - LUSE support [505](#)
  - LUSE volumes [512](#)
  - main pane [515](#), [517](#)
  - MCUs [487](#), [488](#)
  - Number tree [523](#)
  - one-to-one volume pairs [505](#)
  - optimizing operations [558](#), [559](#)
  - Other Operations pane [529](#)

- pair operations, common procedures [561](#)
- pair status [497](#)
- Paircreate command [565](#)
- Pairdisplay command [563](#)
- Pairresync command [572](#)
- Pairsplit-r command [569](#)
- Pairsplit-S command [575](#)
- pinned tracks [589](#)
- Port tree and Port list [525](#)
- powering off components [580](#)
- preparing for pair operations [560](#), [561](#)
- primary site, transferring back to [587](#)
- Prioritized Port Control [513](#)
- protecting logical volumes [294](#)
- P-VOLs [488](#)
- RAID support [489](#)
- RCUs [487](#), [488](#)
- read and write I/O operations [492](#)
- remote copy connections [489](#)
- remote copy operations [491](#)
- remote sites, switching to [585](#)
- requirements and restrictions [504](#)
- serial remote copy connections [509](#)
- source volumes [360](#)
- split types [500](#)
- starting [515](#)
- status icons [519](#)
- subsystem settings [530](#)
- S-VOL write option [493](#), [506](#)
- S-VOLs [488](#)
- system requirements [504](#)
- troubleshooting [840](#), [842](#)
- TrueCopy Snapshot function [521](#)
- update copy operation [492](#)
- Usage Monitor [555](#)
- Usage Monitor pane [527](#)
- Volume list [518](#), [562](#)
- CA Asynchronous
  - about [485](#)
  - adding consistency groups [550](#)
  - Async Option pane [553](#)
  - consistency groups [489](#), [496](#)
  - consistency of S-VOLs [586](#)
  - consistency status [501](#)
  - deleting consistency groups [552](#), [555](#)
  - file recovery [584](#)
  - operation pane [525](#)
  - operations [517](#), [547](#)
  - options, consistency group [551](#)
  - pair status [498](#)
  - Pairresync options [573](#)
  - Pairsplit-r options [570](#)
  - Pairsplit-S options [576](#)
  - parameters [555](#), [569](#)
  - performance impact [558](#)
  - Point-in-Time copies [580](#)
  - recordset operations [493](#)
  - recordsets [503](#)
  - remote copy connections [489](#)
  - sidefile threshold values [496](#)
  - split types [500](#)
  - suspension conditions [503](#)
  - troubleshooting [842](#)
  - update copy operation [492](#)
  - write operations during [492](#)
- CA Synchronous
  - about [485](#)
  - data migration and duplication [579](#)
  - fence level [568](#)
  - performance impact [558](#)
  - P-VOL fence level [583](#)
  - remote copy connections [489](#)
  - split types [500](#)
  - update copy operation [492](#)
  - write operations during [492](#)
- cache
  - CA requirements [506](#)
  - inflow control [495](#)
  - size, CA operations [559](#)
- Cache LUN for XP128/XP1024/XP12000
  - bind mode [332](#)
  - LDEV table [334](#)
  - logical blocks [330](#)
  - mode, changing [339](#)
  - pane [333](#)
  - Partial Cache Residence (PCR) [339](#)
  - pie chart [334](#)
  - pre-staging [332](#)
  - priority mode [331](#)
  - releasing a cache extent [338](#)
  - restrictions [330](#)
  - setting a cache extent [335](#)
  - settings [334](#)
  - starting [332](#)
  - supported emulation types [330](#)
  - supported volumes [329](#)
  - tasks [329](#)
- Cache LUN for XP48/XP512
  - bind mode [325](#)
  - logical blocks [324](#)
  - modes, changing [328](#)
  - pane [326](#)
  - priority mode [325](#)
  - removing a cache extent [328](#)
  - restrictions [324](#)
  - setting a cache extent [326](#)
  - starting [326](#)
  - supported emulation types [323](#)
  - supported volumes [323](#)
  - tasks [323](#)
- Cache LUN pane [134](#)
- Cache LUN, combining with other applications
  - BC [446](#)
  - CA [512](#)
  - External Storage XP [768](#)
- Cache Mode [768](#)
- cascade function [427](#), [436](#)
- cascade pairs [415](#)

- cascaded volumes [361](#)
- CHA mode [313](#)
- Change Pair Option command [578](#)
- channel adapters (CHAs)
  - package status icons [217](#)
  - usage statistics [346](#), [375](#)
- channel processors (CHPs) usage statistics [346](#), [375](#)
- CHAP authentication [193](#), [222](#)
- characters
  - entering alphanumeric [50](#)
  - user names and passwords [61](#)
- CHAs (channel adapters)
  - package status icons [217](#)
  - usage statistics [346](#), [375](#)
- Check Paths & Restore Vol. command [775](#), [812](#)
- CHPs (channel processors) usage statistics [346](#), [375](#)
- CLI sessions [54](#)
- cluster status [142](#)
- command devices [188](#), [216](#)
- command line, using Backup Utility [46](#)
- Command View
  - application integration [39](#)
  - Array Manager [47](#)
  - backup utility [45](#)
  - BC software [415](#)
  - CA management station [490](#)
  - communicating with disk arrays [42](#)
  - default user names [43](#)
  - Device Launcher pane [47](#)
  - features [40](#)
  - host agents supported [39](#)
  - LU path settings [289](#), [295](#)
  - main window [45](#)
  - security system [57](#)
  - starting from a browser [42](#)
  - starting from Storage Area Manager [44](#)
  - troubleshooting [835](#)
- concatenated parity groups [212](#), [253](#)
- Configuration File Loader
  - CHA mode [313](#)
  - closing spreadsheets [303](#)
  - command device settings [316](#)
  - comments [309](#)
  - components [299](#)
  - configuration definition [308](#), [309](#)
  - declaration [307](#)
  - editing spreadsheets [318](#)
  - error checking [320](#)
  - exporting spreadsheets [317](#)
  - function tag [307](#)
  - host group settings [314](#)
  - importing spreadsheets [319](#)
  - LUN Manager spreadsheet [311](#)
  - LUN path settings [316](#)
  - opening spreadsheets [302](#)
  - overview [299](#)
  - pane [300](#)
  - port settings [312](#)
  - requirements [299](#)
  - rules [306](#)
  - sample spreadsheet [305](#)
  - screen [304](#)
  - security status [313](#)
  - software supported [302](#)
  - spreadsheet extensions [300](#)
  - spreadsheets supported [301](#)
  - starting [303](#), [317](#)
  - tasks [301](#)
  - troubleshooting [839](#)
  - WWN settings [315](#)
- Configuration File Loader pane [304](#)
- consistency groups
  - adding [550](#)
  - defined [489](#)
  - deleting [552](#), [555](#)
  - options [496](#), [551](#)
  - parameters, modifying [555](#)
  - requirements [505](#)
- consistency status, CA Async S-VOLs [501](#)
- Contact, disk array [48](#), [49](#)
- Continuous Access. See CA
- continuous expanded LUNs, creating [163](#)
- Control Panel [120](#)
- control units (CUs) [596](#)
- conventions, document [36](#)
- COPY [498](#), [519](#), [586](#), [587](#)
- COPY (PD) [455](#), [723](#)
- COPY (RS) [455](#), [723](#)
- COPY (RS-R) [455](#), [723](#)
- COPY (SP) [455](#), [723](#)
- Copy Pace list [462](#), [467](#)
- Copy Type Setting pane, Flex Copy [747](#)
- copying paths [212](#)
- CT Group Option pane [551](#)
- CU image [488](#)
- currency of S-VOLs [585](#)
- custom volumes
  - configuration information, viewing [259](#)
  - converting to normal [175](#)
  - converting volumes to space [172](#)
  - Customized Volume pane [257](#)
  - defined [169](#), [243](#)
  - deinstalling [175](#)
  - Install Custom Volume function [246](#)
  - Install CV function [261](#)
  - installing [173](#)
  - LDEV ID, setting [174](#)
  - limitations [170](#)
  - Make Volume function [248](#), [268](#)
  - restrictions [278](#)
  - samples [244](#)
  - specifications [170](#)
  - starting VSC operations [257](#)
  - starting VSC pane [172](#)
  - Volume Initialize function [248](#), [273](#)
  - Volume to Space function [245](#), [260](#)
- customer support [37](#)
- Customized Volume pane [257](#)

## D

Data Retrieval in Progress, troubleshooting [835](#)

Data Shredder  
about [278](#)  
canceling shredding [284](#)  
confirmation pane [281](#)  
deleting data [283](#)  
example [279](#)  
Param panel [280](#)  
preparing [282](#)  
settings [282](#)  
starting [280](#)  
systems supported [278](#)  
volume status [279](#)

data transfer speed, Fibre Channel ports [190](#), [219](#)

database recovery [584](#), [689](#)

declaration, spreadsheet [307](#)

default user names and passwords [43](#)

default users [58](#)

deinstalling  
custom volumes [175](#)  
External Storage XP [772](#)  
Flex Copy [739](#)  
license keys [79](#)

Delete CT Group command [552](#)

Delete LU command [813](#)

Delete Pair command, Flex Copy [752](#)

deleting  
applications [71](#)  
BC pairs (pairsplit-S) [474](#)  
CA pairs (pairsplit-S) [575](#)  
consistency groups [552](#), [555](#)  
data (shredding) [278](#), [283](#)  
disk arrays [51](#)  
HBAs from host groups [211](#)  
history events [93](#)  
host groups [209](#)  
LU paths [207](#)  
LUs [563](#)  
PFC groups [411](#)  
RCU paths [543](#)  
RCUs [541](#)  
SCSI/FC paths [158](#)  
SSIDs from RCUs [545](#)  
users [65](#)  
WWNs [211](#), [215](#), [237](#)

Deleting status [520](#)

development servers [352](#)

Device Administration pane [48](#)

Device Health pane [132](#), [836](#)

Device Launcher pane [47](#)

Device List, External Storage XP [779](#)

Device Name [47](#), [49](#)

device status [132](#)

Device Tree, External Storage XP [778](#)

Device Type [48](#)

Direct Backup Engine

about [823](#)

adding ports to groups [828](#)

commands [823](#)

Detail command, port information [827](#)

disk array requirements [824](#)

host server requirements [823](#)

initiator ports [833](#)

moving ports from groups [830](#)

panes [824](#)

Port Group Information table [825](#)

Port Group tree [824](#)

Port Operation tree [825](#)

Preset table [826](#)

starting [824](#)

supported backup devices [823](#)

target ports [833](#)

timeout, setting [831](#)

disaster recovery

consistency of S-VOLs [586](#)

currency of S-VOLs [585](#)

file and database recovery [584](#)

file/DB recovery [689](#)

host failover [584](#)

preparing for [582](#), [689](#)

primary site, transferring back to [587](#)

remote sites, switching to [585](#)

disaster recovery and regeneration processors (DRRs)

usage statistics [346](#), [349](#), [377](#)

Disconnect Subsystem command [774](#), [810](#)

Disconnect Volume command [810](#), [811](#)

disk adapters (DKAs) usage statistics [346](#), [376](#)

disk arrays

adding [50](#)

communication with [42](#)

deleting [51](#)

identity information [97](#)

locking [58](#)

parameters, changing [51](#)

powering off/on CA components [580](#)

viewing device history [51](#)

See also local disk arrays; external disk arrays

disk processors (DKPs) usage statistics [346](#), [349](#), [376](#)

disk usage, auto migration [350](#)

disk usage, maximum [394](#)

dispersed expanded LUNs, creating [164](#)

Display Filter pane, CA [520](#)

Display Filter window [456](#)

DKAs (disk adapters) usage statistics [346](#), [376](#)

DKC status [133](#), [140](#)

DKPs (disk processors) usage statistics [346](#), [349](#), [376](#)

DKU status [133](#), [140](#)

DKU types [49](#)

document conventions [36](#)

documentation, related [35](#)

DRRs usage statistics [346](#), [349](#), [377](#)

dummy data [279](#), [280](#)

DYNIX host modes [186](#)



## E

- Edit Applications pane [71](#)
- e-mail notifications [85](#), [89](#)
- emergency keys [75](#)
- emulation types supported [179](#)
- ending a session [55](#)
- environment parameters [121](#)
- erasing data (shredding) [278](#)
- error codes
  - BC [478](#)
  - CA [588](#)
  - Status pane [139](#), [140](#)
- ESCON connections
  - CA components [487](#)
  - configuring for CA [511](#)
  - distances supported [489](#)
  - requirements [509](#)
  - system requirements [504](#)
- estimating usage [349](#)
- event history pane [81](#)
- event notification
  - accessing [83](#)
  - deleting history events [93](#)
  - e-mail server, specifying [84](#)
  - e-mail, configuring [85](#)
  - history settings [84](#)
  - schedule, managing [89](#)
  - script [86](#)
  - SNMP, configuring [87](#)
  - testing [93](#)
  - viewing configured notifications [90](#)
  - viewing event history [91](#)
  - viewing notification history [92](#)
- Excel spreadsheets [302](#), [303](#)
- expanded LDEVs [252](#), [253](#)
- expanded LUNs
  - continuous, creating [163](#)
  - Detail pane [162](#)
  - dispersed, creating [164](#)
  - size limitations [160](#)
  - starting [161](#)
- Expiration Lock [286](#), [288](#), [290](#)
- expiration, license keys [75](#)
- Export Tool [44](#)
- exporting spreadsheets [317](#)
- external disk arrays
  - Add LU window [792](#)
  - backup operations example [735](#)
  - capacities [710](#), [755](#)
  - compatible storage devices [765](#)
  - configuring for External Storage XP [769](#)
  - configuring for Flex Copy [739](#)
  - defined [703](#)
  - Device List [780](#)
  - Flex Copy and External Storage XP feature
    - comparison [706](#)
    - information window [807](#)
    - IO Suppression mode [768](#)
    - mapping with External Storage XP [757](#), [773](#)
  - mapping with Flex Copy [704](#)
  - port settings [790](#)
  - powering off while using External Storage XP [774](#), [776](#)
- external LUs
  - Add LU [797](#)
  - alternate paths [800](#)
  - attributes [768](#)
  - BC operations [763](#)
  - capacities [755](#), [819](#)
  - Check Paths & Restore Vol. command [812](#)
  - copying data from local disk arrays [749](#)
  - copying data to local disk arrays [747](#)
  - defined [703](#)
  - Delete LU command [813](#)
  - Device List [780](#)
  - disconnecting [810](#)
  - External Storage XP settings [788](#)
  - Flex Copy and External Storage XP feature
    - comparison [706](#)
    - groups [773](#)
    - information window [807](#)
    - IO Suppression mode [768](#)
    - LU Operation pane [777](#)
    - mapping with External Storage XP [757](#), [773](#), [791](#)
    - mapping with Flex Copy [704](#)
    - restoring [808](#)
    - setting [740](#)
    - size limitations [767](#)
    - troubleshooting [814](#)
    - using data with External Storage XP [761](#)
    - Volume Detail window [809](#)
    - Volume Migration [762](#)
    - writing data using External Storage XP [760](#)
- external ports [826](#)
- External Storage XP
  - Add LU [797](#)
  - Add LU window [792](#)
  - alternate paths [758](#), [800](#)
  - applications, combining with [764](#)
  - attributes [768](#)
  - Auto LUN [762](#)
  - Auto Map Setting window [794](#)
  - BC operations [763](#)
  - Cache LUN [768](#)
  - capacity and emulation type [819](#)
  - Check Paths & Restore Vol. command [775](#), [812](#)
  - Configuration File Loader [769](#)
  - configuring external disk arrays [769](#)
  - Delete LU command [813](#)
  - Device List [779](#)
  - Device Tree [778](#)
  - Disconnect Subsystem command [774](#), [810](#)
  - Disconnect Volume command [810](#), [811](#)
  - external disk arrays, compatible [765](#)
  - external LU groups [773](#)
  - external LU settings [788](#)
  - features [757](#)
  - Fibre Channel switches supported [765](#)



- Filter button [781](#)
- Flex Copy, comparison with [706](#)
- Hitachi Parallel Access Volume (HPAV) [769](#)
- Hitachi SANtinel [769](#)
- installing [772](#)
- IO Suppression mode [768](#)
- LDEV Information window [807](#)
- limitations [766](#)
- LU Operation pane [777](#)
- LU size limitations [767](#)
- LU size, calculating [771](#)
- LUN management [769](#)
- LUN Security XP Extension [769](#)
- mapping [757](#), [773](#)
- mapping external LUs [791](#)
- Path Setting window [801](#)
- Port List [786](#)
- Port Operation pane [784](#)
- port settings [773](#), [790](#)
- Port Tree [785](#)
- powering off disk arrays [774](#), [776](#)
- Preset list [782](#), [787](#)
- restoring external LUs [808](#)
- Select LDEV window [796](#)
- Selective Storage Presentation (SSP) [771](#)
- settings [772](#)
- starting [776](#)
- system requirements [765](#)
- troubleshooting [814](#)
- uninstalling [772](#)
- using data in external LUs [761](#)
- Volume Detail window [809](#)
- volume status [806](#)
- writing data to external LUs [760](#)

## F

- fabric topology [188](#)
- failover, host [491](#), [584](#)
- FCAL settings [131](#)
- FC-AL topology [188](#)
- features, Command View [40](#)
- fence level [568](#), [583](#)
- Fibre Channel ports
  - addresses [167](#), [189](#), [219](#)
  - CA components [487](#)
  - configuring [167](#), [216](#), [511](#)
  - copying paths [212](#), [213](#), [214](#)
  - data transfer speed [190](#), [219](#)
  - Direct Backup Engine support [824](#)
  - direct connection [508](#)
  - distances supported [489](#), [507](#)
  - extender connection [508](#)
  - fabric settings [131](#)
  - host modes [165](#)
  - initiator [490](#)
  - LU paths [180](#), [202](#)
  - LUN Path tree [198](#)
  - Package tree [217](#)
  - RCU path parameters [541](#)

- status [198](#)
- status icons [825](#)
- switch connection [508](#)
- system requirements [504](#)
- topology [168](#), [188](#), [219](#)
- Fibre Channel switches supported by External Storage XP [765](#)
- fibre remote copy connections [507](#)
- file recovery [584](#), [689](#)
- firmware version [100](#)
- fixing parity groups [393](#)
- FlashCopy [713](#)
- Flex Copy
  - backup operations example [735](#)
  - canceling copy pairs [752](#)
  - capacities [708](#), [710](#), [755](#)
  - configuration examples [718](#)
  - copy operations using Command View [725](#)
  - copy operations using RAID Manager XP [725](#)
  - Copy Type Setting pane [747](#)
  - copying data from local disk arrays to external LUs [749](#)
  - copying from external LUs to local disk arrays [747](#)
  - Delete Pair command [752](#)
  - external disk arrays, configuring [739](#)
  - external LUs, setting [740](#)
  - External Storage XP, comparison with [706](#)
  - features [703](#)
  - history, viewing [750](#)
  - HP Stagerworks [703](#)
  - installing [739](#)
  - main pane [741](#)
  - mapping [704](#)
  - maximum number of copy pairs [711](#)
  - Pair list [742](#)
  - Pair Volume Setting pane [746](#)
  - pairs [704](#)
  - panes [740](#)
  - precautions for copy operations [716](#)
  - Preset list [744](#)
  - RAID Manager commands [733](#)
  - RAID Manager operations [730](#)
  - reference codes [751](#)
  - requirements for LUs used for copy pairs [709](#)
  - settings [739](#)
  - starting [718](#), [740](#)
  - status of copy pairs [722](#)
  - system requirements [707](#)
  - troubleshooting [753](#)
  - uninstalling [739](#)
- Flex Copy pane [741](#)
- formatting LDEVs [277](#)
- free LDEVs [252](#), [253](#)
- FTP, disabling [50](#)
- function tag, spreadsheet [307](#)

## G

- Groups tab [67](#)

- groups, user
  - modifying [67](#)
  - properties [59](#)
  - roles [59](#)
  - types of [58](#)
- GUI sessions [54](#)

## H

- hard disk drives (HDDs) [349](#)
  - Attribute tab [391](#)
  - disk usage, maximum [350](#), [394](#)
  - estimating usage [349](#)
  - optimizing performance [347](#)
  - reserved volumes [350](#)
- hardware installation for CA [506](#)
- HBAs
  - deleting from host groups [211](#)
  - grouping [408](#)
  - many-to-many port connections [355](#)
  - one-to-one port connections [353](#)
  - PFC names [407](#)
  - prioritizing PFC groups [409](#)
  - replacing [408](#)
  - traffic management [404](#)
  - traffic statistics [383](#), [405](#)
  - upper limit values [409](#)
- HDDs
  - Attribute tab [391](#)
  - auto migration [350](#)
  - disk usage, maximum [350](#), [394](#)
  - estimating usage [349](#)
  - optimizing performance [347](#)
  - reserved volumes [350](#)
- help
  - HP technical support [37](#)
  - Support pane [73](#)
- high-speed modes [190](#), [219](#)
- history
  - array event [81](#)
  - BC pair [475](#)
  - clearing log file [93](#)
  - deleting events [93](#)
  - device, viewing [51](#)
  - event notification [84](#), [91](#)
  - Flex Copy [750](#)
  - notification [92](#)
- History Operations pane, CA [527](#)
- History tab, migrations [395](#)
- Hitachi Parallel Access Volume (HPAV) [769](#)
- Hitachi SANTinel [769](#)
- Hitachi ShadowImage [713](#), [764](#)
- host agents [39](#)
- host bus adapters (HBAs)
  - deleting from host groups [211](#)
  - grouping [408](#)
  - many-to-many port connections [355](#)
  - one-to-one port connections [353](#)
  - PFC names [407](#)
  - prioritizing PFC groups [409](#)

- replacing [408](#)
- traffic management [404](#)
- traffic statistics [383](#), [405](#)
- upper limit values [409](#)

- host failover software [491](#), [584](#)
- host groups
  - associating to logical volumes [207](#)
  - creating [184](#), [203](#)
  - deleting [209](#)
  - deleting HBAs [211](#)
  - initializing group 0 [209](#)
  - mode, changing [208](#)
  - name, changing [208](#)
  - settings [314](#)
- Host I/O Performance option [436](#)
- hosts
  - authentication, enabling [224](#)
  - CA requirements [506](#)
  - incorrect address, troubleshooting [837](#)
  - iSCSI authentication [194](#)
  - modes [165](#), [186](#)
  - mutual authentication [227](#)
  - performance control [352](#)
  - registering in host groups [204](#)
  - registering user information [224](#)
  - storage domains [180](#)
  - user information, changing [226](#)
- HP
  - authorized resellers [37](#)
  - storage web site [37](#)
  - Subscriber's choice web site [37](#)
  - technical support [37](#)
- HPAV (Hitachi Parallel Access Volume) [769](#)
- HP-UX
  - FCAL settings [131](#)
  - host modes [165](#), [186](#)
  - operating systems supported [39](#)

## I

- I/O operations, performance control [352](#), [358](#)
- I/O rate [353](#)
- IBM AIX
  - host modes [165](#), [186](#)
  - operating systems supported [39](#)
- Identity pane
  - Control panel [120](#)
  - information in [97](#)
  - lock icon [100](#)
  - user privileges [97](#)
- importing spreadsheets [319](#)
- initial copy operation [425](#), [491](#), [568](#)
- initiator ports [490](#), [532](#), [826](#), [833](#)
- Install CV function [243](#), [246](#), [261](#)

- installing
  - CA hardware [506](#)
  - custom volumes [173](#)
  - External Storage XP [772](#)
  - Flex Copy [739](#)
  - license keys [77](#)
  - troubleshooting [835](#)
- integrating applications with Command View [39](#)
- internal LUs
  - Add LU [797](#)
  - alternate paths [800](#)
  - capacities [755](#), [819](#)
  - defined [703](#)
  - groups [773](#)
  - IO Suppression mode [768](#)
  - mapping with External Storage XP [757](#), [773](#)
  - mapping with Flex Copy [704](#)
  - size limitations [767](#)
- Internet access [39](#)
- Inv (Invisible mode) [290](#)
- IO Suppression mode [768](#)
- IO Trace host modes [165](#)
- IP addresses
  - disk array [48](#), [49](#)
  - iSCSI ports [192](#)
  - troubleshooting [838](#)
- iSCSI
  - configuring [216](#), [220](#)
  - copying paths [212](#), [213](#), [214](#)
  - disk arrays supported [363](#)
  - LU paths, defining [202](#)
  - mutual authentication [227](#)
  - Name table [201](#)
  - names [192](#), [209](#)
  - Package Tree [217](#)
  - port settings [191](#), [228](#)
  - registering user information on host [224](#)
  - status [199](#)
  - user authentication [193](#), [222](#)
  - user information, changing [226](#)

## J

- Java Runtime Environment (JRE) [122](#)

## K

- keys, license
  - accessing [76](#)
  - installing [77](#)
  - troubleshooting [837](#)
  - types of [75](#)
  - uninstalling [79](#)

## L

- LCPs (local control ports) [490](#)
- LDEV ID setting [174](#)
- LDEV Information window [807](#)
- LDEV tab, Auto LUN [367](#), [369](#)
- Ldev/Port Map pane [129](#)
- LDEVs
  - associating host groups to logical volumes [207](#)
  - Auto LUN [361](#)
  - BC pair maintenance [416](#), [420](#)
  - Cache LUN for XP128/XP1024/XP12000 [334](#)
  - cache LUN status [134](#)
  - capacity [100](#)
  - combining [241](#), [242](#)
  - command device settings [316](#)
  - command devices [188](#), [216](#)
  - custom volumes [169](#)
  - expanded [252](#), [253](#)
  - External Storage XP window [796](#)
  - Flex Copy and External Storage XP feature comparison [706](#)
  - Flex Copy capacities [708](#)
  - formatting [277](#)
  - free [252](#), [253](#)
  - Information table [250](#), [254](#)
  - Information tree [250](#)
  - Information window, External Storage XP [807](#)
  - LUN Path tree [200](#)
  - LUSE volume capacity, changing [256](#)
  - LUSE volumes, creating [253](#)
  - Pairdisplay command [563](#)
  - parity group tree [257](#)
  - port map pane [129](#)
  - releasing a LUSE volume [255](#)
  - resetting an unregistered volume [256](#)
  - SCSI/FC paths [158](#)
  - Status Overview pane [127](#), [128](#)
  - status table [201](#)
  - Volume to Space function [245](#)
- leaf volume [437](#)
- Left DKU Type [49](#)
- License Key Management pane [75](#)
- license keys
  - accessing [76](#)
  - installing [77](#)
  - troubleshooting [837](#)
  - types of [75](#)
  - uninstalling [79](#)
- Linux
  - host modes [186](#)
  - operating systems supported [39](#)
- local control ports (LCPs) [490](#)

- local disk arrays
  - backup operations example [735](#)
  - capacities [710](#), [755](#)
  - configuring for External Storage XP [769](#)
  - copying data from external LUs [747](#)
  - copying to external LUs [749](#)
  - defined [703](#)
  - Flex Copy and External Storage XP feature
    - comparison [706](#)
  - IO Suppression mode [768](#)
  - mapping with Flex Copy [704](#)
  - port settings [790](#)
  - powering off while using External Storage XP [774](#), [776](#)
- Location, disk array [48](#), [49](#)
- lock icon, Identity pane [99](#), [100](#)
- locking arrays [58](#), [122](#)
- log file, clearing [93](#)
- logging on to Command View
  - default user names and passwords [43](#)
  - from a browser [42](#)
  - restrictions [44](#)
- logical devices. See LDEVs
- logical volumes
  - access attributes [287](#), [289](#), [292](#)
  - associating host groups [207](#)
  - Auto LUN [360](#)
  - pairs [414](#)
  - read-only [285](#)
  - usage statistics [346](#), [347](#), [373](#)
- logs
  - migration [396](#)
- loop IDs [189](#)
- LU Operation pane [777](#)
- LU Path tree [198](#), [200](#), [216](#)
- LU paths
  - alternate, defining [212](#)
  - alternate, viewing [214](#)
  - associating host groups to logical volumes [207](#)
  - Command View, disabling [295](#)
  - defining [202](#)
  - deleting [207](#)
  - Fibre Channel environment [180](#)
  - limitations [179](#)
  - NAS environment [182](#)
  - settings [289](#)
  - traffic statistics [347](#), [379](#)
- LUN Management
  - emulation types supported [179](#)
  - External Storage XP [769](#)
  - host modes [165](#)
  - LU Path tree [200](#)
  - main pane [197](#)
  - operational restrictions [176](#)
  - restrictions [229](#)
  - SCSI/FC path information [157](#)
  - starting for XP128/XP1024/XP12000 [197](#)
  - starting for XP48/XP512 [157](#)
- LUN Manager spreadsheets [301](#), [311](#)
- LUN security
  - applying [215](#)
  - BC, combining with [446](#)
  - CA, combining with [512](#)
  - changing WWN access [234](#)
  - defining [233](#)
  - enabling and disabling [187](#), [232](#)
  - group nicknames, changing [235](#)
  - group parameters [234](#)
  - groups, creating [234](#)
  - pane, accessing [133](#)
  - port status icons [825](#)
  - removing [215](#)
  - starting [231](#)
  - WWN group members, changing [238](#)
  - WWN groups, creating [236](#)
  - WWN nicknames [237](#)
  - WWNs, adding [235](#)
  - WWNs, deleting [237](#)
- LUN Security Extension
  - about [285](#)
  - access attributes [287](#), [292](#)
  - applications, closing other [287](#)
  - Error Detail pane [292](#), [296](#)
  - icons [289](#)
  - LUSE volumes, viewing [295](#)
  - protecting against CA and BC operations [294](#)
  - retention term [290](#), [291](#), [293](#)
  - starting [288](#)
  - Term Setting dialog box [291](#)
  - troubleshooting [296](#)
  - Volume Detail dialog box [291](#), [296](#)
- LUN Security Extension pane [289](#)
- LUN Security XP Extension [769](#)
- LUNs
  - 16-Port FC/CA CHIP mapping [183](#)
  - expanded continuous, creating [163](#)
  - expanded dispersed, creating [164](#)
  - map pane [128](#)
  - path settings [316](#)
  - size expansion [161](#)
  - size limitations [160](#)
  - status [128](#)
- LUs
  - Add LU [797](#)
  - alternate paths [800](#)
  - attributes [768](#)
  - BC operations [763](#)
  - capacities [755](#), [819](#)
  - Check Paths & Restore Vol. command [812](#)
  - copying data from local disk arrays [749](#)
  - copying data to local disk arrays [747](#)
  - Delete LU command [813](#)
  - deleting [563](#)
  - Device List [780](#)
  - External Storage XP settings [788](#)
  - external, setting [740](#)
  - Flex Copy and External Storage XP feature
    - comparison [706](#)

- groups [773](#)
- information window [807](#)
- internal and external, defined [703](#)
- IO Suppression mode [768](#)
- mapping with External Storage XP [757](#), [773](#), [791](#)
- mapping with Flex Copy [704](#)
- Pairedisplay command [563](#)
- pairs, maximum number of [417](#), [424](#)
- parameters, modifying [562](#)
- restoring external [808](#)
- size limitations [767](#)
- size, calculating [771](#)
- troubleshooting External Storage XP [814](#)
- types supported [505](#)
- using data with External Storage XP [761](#)
- Volume Detail window [809](#)
- Volume Migration [762](#)
- writing data using External Storage XP [760](#)

#### LUSE operations

- BC, combining with [446](#)
- CA support [505](#)
- CA, combining with [512](#)
- capacities, changing [256](#)
- combining LDEVs [241](#)
- concatenated parity groups [253](#)
- creating a LUSE volume [253](#), [254](#)
- defined [160](#)
- Detail pane [162](#)
- pairs, maximum number of [417](#), [424](#)
- path-defined LDEVs [242](#)
- releasing a volume [255](#)
- resetting an unregistered volume [256](#)
- restrictions [278](#)
- rules [241](#)
- starting [249](#)
- troubleshooting [838](#)
- viewing configuration information [252](#)

LUSE source volumes [361](#)

## M

- mainframe volume [100](#)
- Make Volume function [243](#), [248](#), [268](#), [278](#)
- Manage Array check box [50](#)
- manual migration
  - about [351](#)
  - execution [362](#)
  - fixing parity groups [393](#)
  - history [395](#)
  - settings [385](#)
- mapping
  - Add LU [797](#)
  - alternate paths [800](#)
  - defined [704](#)
  - Delete LU command [813](#)
  - External Storage XP [757](#), [773](#), [791](#)
- MCUs
  - configuring [511](#)
  - consistency groups [489](#)
  - defined [487](#)

- disaster recovery [584](#)
- inflow control [495](#)
- initial copy operations [491](#)
- initiator ports [490](#)
- Number tree [523](#)
- operations [488](#), [532](#)
- pair split types [500](#)
- planned outages [581](#)
- ports [532](#)
- powering off/on [581](#)
- read and write operations [492](#)
- recordsets [493](#), [503](#)
- registering RCUs [536](#)
- remote control ports [490](#)
- remote copy connections [489](#)
- serial connections [509](#)
- subsystem settings [530](#)
- S-VOL write option [493](#)
- system requirements [504](#)
- update copy operations [492](#)
- Microsoft Excel [302](#), [303](#)
- migration
  - auto [349](#), [362](#), [388](#)
  - Auto LUN [762](#)
  - CA Synchronous [579](#)
  - estimating usage rates [349](#)
  - fixing parity groups [393](#)
  - history tab [395](#)
  - logs [396](#)
  - manual [351](#), [362](#), [385](#)
  - operations [348](#)
  - plans [385](#)
  - powering off disk arrays [363](#)
  - releasing parity groups [394](#)
  - target volumes [393](#)
- Mode-Switching icon, Identity pane [99](#)
- Modify link [47](#)
- Monitoring Options pane [370](#), [372](#)
- MSA 1000s, configuring for External Storage XP [769](#)
- MU numbers, selecting [462](#), [467](#)
- mutual authentication [227](#)

## N

- NAS ports
  - configuring LU paths [182](#)
  - copying paths [213](#), [214](#)
  - LUN Path tree [198](#)
  - status [198](#)
- NetBackup [823](#)
- NetWare host modes [165](#), [186](#)
- nicknames [235](#), [237](#)
- node volume [437](#)
- non-cascaded volumes [361](#)
- non-prioritized port [353](#), [356](#)
- nonvolatile storage requirements [506](#)
- normal pairresync operation [428](#)
- notifications. See event notifications
- Novell NetWare host modes [165](#), [186](#)
- NVS, CA requirements [506](#)

- - OPEN volumes
    - defined [100](#)
    - differential tables [713](#)
    - External Storage XP capacity [819](#), [820](#)
    - LUSE rules [241](#)
    - pairs, maximum number of [417](#), [421](#)
  - OPEN-V
    - differential tables [421](#), [714](#)
    - Install Custom Volume function [246](#)
    - IO Suppression mode [768](#)
    - Make Volume function [268](#)
    - Make Volume operation [248](#)
    - parity group configuration [244](#)
    - size limitations [767](#)
    - size, volume [243](#)
  - OpenVMS host modes [165](#), [186](#)
  - operating systems supported [39](#)
  - optimizing performance [347](#), [558](#)
  - Other Operations pane [529](#)
- P**
- Package tree [217](#)
  - PAIR
    - BC shortcuts [455](#)
    - CA pair status [498](#), [515](#), [519](#)
    - Hex Copy pair status [723](#)
    - S-VOL consistency [587](#)
    - S-VOL currency [586](#)
  - PAIR (NOCOPY) [723](#)
  - Pair list, Flex Copy [742](#)
  - Pair Operation pane [515](#), [517](#)
  - pair status
    - CA volumes [497](#)
    - COPY [498](#)
    - COPY(PD) [443](#)
    - COPY(RS) [443](#)
    - COPY(RS-R) [444](#)
    - COPY(SP) [443](#)
    - deleting [500](#)
    - Flex Copy [722](#)
    - PAIR [443](#), [498](#)
    - PDUB [499](#)
    - PSUE [444](#), [499](#)
    - PSUS [443](#), [499](#), [500](#)
    - PSUS(SP) [443](#)
    - shared CA/BC volumes [513](#)
    - shortcut commands [455](#)
    - SMPL [443](#), [498](#)
    - suspending [500](#)
    - viewing [452](#), [475](#)
  - Pair Volume Setting pane, Flex Copy [746](#)
  - Paircreate command, CA [565](#)
  - paircreate operation, BC [425](#), [461](#)
  - Pairdisplay command [563](#)
  - pairresync
    - split pair [433](#)
    - suspended pair [433](#)
  - Pairresync command, CA [572](#)
  - pairresync operation, BC [428](#), [470](#)
  - pairs
    - cascade [415](#)
    - maximum number of [417](#), [420](#)
    - requirements [416](#), [419](#)
    - status [442](#)
    - types of [414](#)
  - pairsplit operation, BC [427](#), [465](#)
  - pairsplit-E (suspend) operation, BC [434](#)
  - pairsplit-E operation (suspend) BC [473](#)
  - Pairsplit-r command [569](#)
  - pairsplit-S (delete) operation, BC [434](#), [474](#)
  - Pairsplit-S command, CA [575](#)
  - parameters, disk array [51](#)
  - Parity Group pane [136](#)
  - parity groups
    - Attribute tab [391](#)
    - auto migration [349](#)
    - bind mode, Cache LUN for XP 48/XP512 [325](#)
    - concatenated [212](#), [253](#)
    - configuration [244](#)
    - fixing [393](#)
    - LDEV tab, Auto LUN [369](#)
    - releasing [394](#)
    - statistics [346](#)
    - status icons [257](#)
    - usage rate [349](#)
    - usage statistics [373](#), [380](#)
  - Partial Cache Residence (PCR) [339](#)
  - passwords
    - changing [62](#), [64](#)
    - default [43](#)
    - rules [61](#)
  - Path Connectivity [39](#)
  - Path Setting window, External Storage XP [801](#)
  - PC Server host modes [165](#)
  - PCR (Partial Cache Residence) [339](#)
  - PCR pane [340](#)
  - PDEV maintenance [416](#), [420](#)
  - PDUB [498](#), [499](#), [505](#), [519](#)
  - Performance Control
    - I/O transfer rates [358](#)
    - optimizing performance [352](#)
    - restrictions [363](#)
    - starting [399](#)
    - troubleshooting [411](#)
  - permanent keys [75](#)
  - PFC groups
    - adding HBAs [408](#)
    - deleting [411](#)
    - prioritizing [409](#)
    - renaming [410](#)
    - upper limit values [409](#)
  - PFC names [407](#)
  - Physical tab, Auto LUN [367](#), [369](#)
  - pinned track [701](#)
  - pinned tracks [589](#)



- plans, migration
  - accessing [385](#)
  - auto [388](#)
  - manual [385](#)
- platforms supported [39](#)
- Point-in-Time (PiT) copies [417](#), [580](#)
- point-to-point topology [188](#)
- Port Group Information table [825](#)
- Port Group tree, Direct Backup Engine [824](#)
- Port List, External Storage XP [786](#)
- Port Operation pane [784](#)
- Port Operation tree [825](#)
- Port Status, System pane [141](#)
- Port tab [217](#)
- Port tab, Performance Control pane [400](#)
- Port Tree, External Storage XP [785](#)
- Port/LUN Map pane [128](#)
- Port-LUN tab [367](#), [368](#)
- ports
  - 16-Port FC/CA CHIP product [183](#)
  - adding to groups [828](#)
  - alternate paths, defining [212](#)
  - CA tree and list [525](#)
  - Detail command, viewing [827](#)
  - external disk array settings [790](#)
  - External Storage XP settings [773](#), [784](#)
  - host modes [165](#)
  - initiator [490](#), [532](#), [826](#), [833](#)
  - iSCSI Name table [201](#)
  - local (LCPs) [490](#)
  - LU paths [202](#)
  - LUN security [215](#)
  - many-to-many HBA connections [355](#)
  - moving from groups [830](#)
  - one-to-one HBA connections [353](#)
  - operation restrictions [230](#)
  - path information, viewing [158](#)
  - prioritized [513](#)
  - remote control (RCPs) [490](#)
  - security [187](#)
  - settings [312](#)
  - speed modes [190](#), [219](#)
  - status icons [825](#)
  - system requirements [504](#)
  - target [490](#), [532](#), [826](#), [833](#)
  - threshold control [407](#)
  - traffic management [404](#)
  - traffic statistics [347](#), [379](#), [382](#), [383](#), [405](#)
  - upper limit values [406](#)
  - WWN Name table [201](#)
  - See also Fibre Channel ports; iSCSI ports
- Ports pane [131](#)
- power off/on requirements [698](#)
- powering off
  - BC operations [444](#)
  - CA components [580](#)
  - disk arrays while using External Storage XP [774](#), [776](#)
- prerequisites [35](#)
- Preset list, External Storage XP [782](#), [787](#)
- Preset list, Flex Copy [744](#)
- Preset table, Direct Backup Engine [826](#)
- Preset Volume list [457](#)
- pre-staging, Cache LUN for XP128/XP1024/XP12000 [332](#), [333](#), [339](#)
- primary path [758](#)
- primary volumes. See P-VOLs
- prioritized port [353](#)
- Prioritized Port Control [513](#)
- prioritized WWN [356](#)
- priority mode for Cache LUN
  - XP128/XP1024/XP12000 [331](#)
  - XP48/XP512 [325](#)
- Product Type [49](#)
- production servers [352](#)
- Protect attribute [285](#)
- PSUE [519](#), [586](#), [723](#)
  - BC shortcuts [455](#)
  - CA pair status [498](#), [499](#)
  - CA suspend types [502](#)
- PSUEGroup [587](#)
- PSUE-LU [587](#)
- PSUS
  - CA pair status [498](#), [499](#), [515](#)
  - CA split types [500](#)
  - CA status [519](#)
  - CA suspend types [502](#)
  - Hex Copy pair status [723](#)
  - S-VOL currency [586](#)
- PSUS (SP) [455](#), [723](#), [725](#)
- PSUS/PSUE [586](#)
- P-VOLs
  - At-Time Split function [440](#)
  - CA pair status [498](#)
  - CA split types [500](#)
  - cascade function [436](#)
  - Change Pair Option command [578](#)
  - combining CA and BC operations [448](#)
  - copying using CA Asynchronous [580](#)
  - copying using CA Synchronous [579](#)
  - defined [413](#), [488](#), [704](#)
  - Delete Pair command, Flex Copy [752](#)
  - Detail window [455](#)
  - error codes [478](#)
  - fence level [568](#), [583](#)
  - Flex Copy and BC operations [726](#)
  - Flex Copy requirements [709](#), [710](#)
  - host requirements [506](#)
  - initial copy operation [425](#), [491](#)
  - MCUs [487](#), [488](#)
  - one-to-one pairs [505](#)
  - paircreate operation [425](#), [461](#)
  - Pairresync command [572](#)
  - pairresync operation [470](#)
  - pairresynch operation [428](#)
  - pairsplit operation [427](#)
  - pairsplit-E (suspend) operation [434](#), [473](#)
  - Pairsplit-r command [570](#)
  - pairsplit-S (delete) operation [434](#), [474](#)

- Pairsplit-S command [575](#)
- pinned track [589](#)
- pinned tracks [589](#)
- point-in-time backups [417](#)
- primary site, transferring back to [587](#)
- RAID groups [415](#)
- RAID Manager commands [733](#)
- read and write operations [492](#)
- recordsets [493](#)
- remote site, switching to [585](#)
- requirements [416](#), [419](#)
- shared with CA and BC [513](#)
- update copy operation [426](#), [492](#)
- Volume list [451](#), [453](#)
- volume pairs [414](#)

## Q

- quick pairresync operation [428](#)
- quick restore operation [435](#)
- quick restore pairresync operation [429](#)
- quick split operation [427](#), [467](#)

## R

- RAID groups [415](#), [416](#), [420](#)
- RAID Manager [188](#)
  - At-Time Split function [441](#)
  - CA support [489](#)
  - command devices, creating [216](#)
  - Flex Copy commands [733](#)
  - Flex Copy operations [725](#), [730](#)
  - Flex Copy pair status [722](#), [724](#)
  - LUN Security Extension [289](#), [290](#)
- RAID parity groups
  - bind mode [325](#), [332](#)
  - optimizing performance [347](#), [349](#)
  - status [257](#)
- RAID volumes
  - combining LDEVs [242](#)
  - status table [202](#)
- RCPs (remote control ports) [490](#)
- RCU Operation pane [522](#)
- RCU target ports [826](#)
- RCUs
  - configuring [511](#)
  - defined [487](#)
  - deleting [541](#)
  - disaster recovery [584](#)
  - inflow control [495](#)
  - initiator ports [490](#)
  - Number tree [523](#)
  - operation pane [522](#)
  - operations [488](#), [516](#), [533](#)
  - options [540](#)
  - pair split types [500](#)
  - path parameters [541](#)
  - path status [536](#)
  - paths, adding and deleting [543](#)
  - planned outages [581](#)
  - powering off [581](#)

- read and write operations [492](#)
- recordsets [493](#), [503](#)
- registering [536](#)
- remote control ports [490](#)
- remote copy connections [489](#)
- serial connections [509](#)
- SSIDs, adding and deleting [544](#)
- status, viewing [534](#)
- S-VOL write option [493](#), [506](#)
- system requirements [504](#)
- target ports [490](#), [532](#)
- timeout operations [497](#)
- troubleshooting path status [840](#)
- update copy operations [492](#)
- read and write I/O operations [492](#), [603](#)
- Read/Write attribute
  - retention term [290](#), [291](#), [293](#)
  - settings [285](#)
- read-only data
  - access attributes [285](#)
  - creating [285](#)
  - LUN Security Extension pane [289](#)
  - retention term [290](#), [291](#), [293](#)
- real-time data backup [485](#)
- recordset operations [493](#)
- recordsets [503](#)
- registering disk arrays [50](#)
- remote access [39](#)
- remote control ports (RCPs) [490](#)
- remote copy connections [489](#), [507](#), [509](#)
- Remote Method Invocation (RMI) [42](#)
- remote sites, switching to [585](#)
- reserve volumes [348](#), [350](#), [424](#), [459](#), [460](#)
- Reset button, Identity pane [99](#)
- reset reserve attribute operation [425](#)
- Reset Reserve Attribute window [460](#)
- restoring data with Backup Utility [46](#)
- restoring external LUs [808](#)
- restrictions, logon [44](#)
- resynchronizing pairs
  - BC (pairresync) [470](#)
  - CA [572](#)
- resynchronizing S-VOLs [428](#), [435](#)
- Retention Term [290](#), [293](#)
- reverse pairresync operation [429](#)
- Right DKU Type [49](#)
- RMI (Remote Method Invocation) [42](#)
- RMI Server Status button [50](#)
- RMI Server Version [141](#)
- RMI timeout period [122](#)
- root volume [437](#)

## S

- SANTinel [769](#)
- schedule, event notification [89](#)
- script notifications [86](#), [89](#)
- SCSI ports, host modes [165](#)



- SCSI/FC paths
  - deleting [158](#)
  - viewing [157](#)
- secondary volumes. See S-VOLs
- security
  - access attributes [285](#), [287](#)
  - accessing [57](#)
  - applying to ports [215](#)
  - default permissions [58](#)
  - default users [58](#)
  - defining LUN parameters [233](#)
  - Groups tab [67](#)
  - host authentication [224](#)
  - iSCSI user authentication [222](#)
  - LUN Management restrictions [229](#)
  - mutual authentication [227](#)
  - ports [187](#)
  - RAID manager [188](#)
  - read-only data, creating [285](#)
  - SNMP IP [52](#), [53](#)
  - status spreadsheet [313](#)
  - switch status [176](#)
  - user groups [58](#)
  - See also LUN security
- security system [58](#)
- Select LDEV window [796](#)
- Select MU list [462](#), [467](#)
- Select S-VOL box [463](#), [467](#)
- Selective Storage Presentation (SSP) [771](#)
- Sequent host modes [165](#), [186](#)
- serial (ESCON) connections
  - CA components [487](#)
  - configuring for CA [511](#)
  - distances supported [489](#)
  - local ports (LCPs) [490](#)
  - requirements [509](#)
  - system requirements [504](#)
- serial number, disk array [48](#), [49](#)
- servers, production and development [352](#)
- Service Information Messages (SIMs)
  - CA [588](#)
  - status details [140](#)
  - Status pane [139](#)
- Session Administration
  - accessing [54](#)
  - ending a session [55](#)
  - timeout value, setting [56](#)
  - user restrictions [53](#)
- Session Administration pane [837](#)
- Set Env tab [121](#)
- set reserve attribute operation [424](#)
- Set Reserve Attribute window [459](#)
- ShadowImage [713](#), [764](#)
- shared CA/BC volumes [513](#)
- shredding data
  - about [278](#)
  - canceling [284](#)
  - confirmation pane [281](#)
  - deleting data on volumes [283](#)
  - example [279](#)
  - Param panel [280](#)
  - preparing for [282](#)
  - settings [282](#)
  - starting [280](#)
  - systems supported [278](#)
  - volume status [279](#)
- sidefile threshold [496](#), [553](#)
- Simple Network Management Protocol (SNMP) [42](#)
- SIMs (Service Information Messages)
  - CA [588](#)
  - status details [140](#)
  - Status pane [139](#)
- SMPL
  - BC pair status conditions [443](#)
  - BC shortcuts [455](#)
  - CA pair status [498](#), [519](#)
  - Pairsplit-S command [575](#)
  - S-VOL consistency [587](#)
  - S-VOL currency [586](#)
- SMPL (PD) [723](#)
- SNMP
  - notifications [87](#), [89](#)
  - timeout errors [838](#)
  - trap [589](#)
- SNMP (Simple Network Management Protocol) [42](#)
- SNMP IP Security [52](#), [53](#)
- SNMP IP Security Manager check box [50](#)
- Solaris
  - host modes [165](#), [186](#)
  - operating systems supported [39](#)
- source volumes [360](#)
- speed
  - copying pairs [462](#)
  - data retrieval, troubleshooting [835](#)
  - Fibre Channel ports data transfer [190](#), [219](#)
- splitting
  - BC pairs (pairsplit) [465](#)
  - CA pairs (pairsplit-r) [569](#)
- spreadsheets
  - CHA mode [313](#)
  - closing [303](#)
  - command device settings [316](#)
  - comments [309](#)
  - configuration definition [308](#), [309](#)
  - declaration [307](#)
  - editing [318](#)
  - error checking [320](#)
  - exporting [317](#)
  - extensions [300](#)
  - function tag [307](#)
  - host group settings [314](#)
  - importing [319](#)
  - LUN Manager [311](#)
  - LUN path settings [316](#)
  - opening [302](#)
  - port settings [312](#)
  - rules [306](#)
  - sample [305](#)

- security status [313](#)
- starting Configuration File Loader [317](#)
- types supported [301](#)
- WWN settings [315](#)
- SSIDs, adding/deleting for RCUs [544](#)
- SSP (Selective Storage Presentation) [771](#)
- standard speed mode [190](#), [219](#)
- statistics
  - Auto LUN [345](#), [372](#)
  - CA Usage Monitor [555](#)
  - Monitoring Options pane [370](#)
- status
  - CA icons [519](#)
  - External Storage XP [806](#)
  - Flex Copy pairs [722](#)
  - pairs [442](#)
  - ports [825](#)
  - RCU [534](#)
  - security switch [176](#)
  - updates, troubleshooting [837](#)
- Status Lamp icon [99](#)
- Status Overview pane [127](#)
- Status pane [139](#)
- Status panes [127](#)
- status, device [132](#)
- steady split operation [427](#), [467](#)
- StorageAdmins
  - default user names and passwords [43](#)
  - properties of [61](#)
  - user groups [58](#)
- subnet mask, default [192](#)
- Subscriber's choice, HP [37](#)
- subsystem settings [530](#)
- Support pane [73](#)
- suspended CA pairs, troubleshooting [842](#)
- suspending BC pairs (pairsplit-E) [473](#)
- Suspending status [520](#)
- S-VOLs
  - At-Time Split function [440](#)
  - CA pair status [498](#)
  - CA split types [500](#)
  - cascade function [436](#)
  - Change Pair Option command [578](#)
  - combining CA and BC operations [448](#)
  - consistency status [501](#)
  - consistency, analyzing [586](#)
  - copying using CA Asynchronous [580](#)
  - copying using CA Synchronous [579](#)
  - currency of [585](#)
  - defined [413](#), [488](#), [704](#)
  - Detail window [455](#)
  - error codes [478](#)
  - fence level [568](#)
  - Flex Copy and BC operations [726](#)
  - Flex Copy requirements [709](#), [710](#)
  - host requirements [506](#)
  - initial copy operation [425](#), [491](#)
  - one-to-one pairs [505](#)
  - paircreate operation [461](#)
  - pairrecreate operation [425](#)
  - Pairresync command [572](#)
  - pairresync operation [428](#), [470](#)
  - pairsplit operation [427](#)
  - pairsplit-E (suspend) operation [434](#), [473](#)
  - Pairsplit-r command [570](#)
  - pairsplit-S (delete) operation [434](#), [474](#)
  - Pairsplit-S command [575](#)
  - Path window [456](#)
  - pinned track [589](#)
  - pinned tracks [589](#)
  - point-in-time backups [417](#)
  - primary site, transferring back to [587](#)
  - RAID groups [415](#)
  - RAID Manager commands [733](#)
  - RCUs [487](#), [488](#)
  - read and write operations [492](#)
  - Read/Write protection [294](#)
  - remote site, switching to [585](#)
  - requirements [416](#), [419](#)
  - reserving [459](#)
  - Select box [467](#)
  - Select list [463](#)
  - set reserve attribute operation [424](#)
  - shared with CA and BC [513](#)
  - UNIX/PC server host access [512](#)
  - update copy operation [426](#), [492](#)
  - Volume list [451](#), [453](#)
  - volume pairs [414](#)
  - write option [493](#), [506](#)
- Swap&Freeze option [435](#), [478](#)
- synchronizing volume pairs [414](#)
- System pane [141](#)

## T

- target ports [490](#), [532](#), [826](#), [833](#)
- target volumes [361](#), [393](#)
- technical support, HP [37](#)
- temporary keys [75](#)
- testing event notifications [93](#)
- Text Import Wizard [302](#)
- threshold control [352](#), [407](#)
- timeout
  - copy pending [550](#), [551](#)
  - Direct Backup Engine [831](#)
  - errors, troubleshooting [838](#)
  - RCU ready [497](#), [550](#), [551](#)
  - RMI [122](#)
  - session [56](#)
- traffic management [404](#)
- traffic statistics [347](#), [379](#), [405](#)
- transfer rate [353](#)
- Trap Distributor [81](#)
- troubleshooting
  - Auto LUN [411](#), [838](#)
  - BC [839](#)
  - BC error codes [478](#)
  - CA [840](#)
  - CA Async suspension conditions [842](#)

- CA error codes [588](#)
- Configuration File Loader [320](#), [839](#)
- Data Retrieval in Progress [835](#)
- Device Health pane [836](#)
- External Storage XP [814](#)
- Flex Copy [753](#)
- host address [837](#)
- host failover software [491](#)
- installation [835](#)
- IP addresses [838](#)
- license keys [837](#)
- LUN Security Extension [296](#)
- LUSE operations [838](#)
- Performance Control [411](#)
- RCU path status [840](#)
- status updates [837](#)
- suspended CA pairs [842](#)
- timeout errors [838](#)
- Tru64 host modes [165](#), [186](#)
- TrueCopy Snapshot function [521](#)

## U

- uninstalling
  - custom volumes [175](#)
  - External Storage XP [772](#)
  - Flex Copy [739](#)
  - license keys [79](#)
- unregistering disk arrays [51](#)
- update copy operation [426](#), [492](#)
- upper limit control [352](#)
- UR
  - components [595](#)
- Usage Monitor pane, CA [527](#)
- Usage Monitor, CA [555](#)
- User Authentication tab [222](#)
- User Entry tab [120](#)
- user groups
  - modifying [67](#)
  - properties [59](#)
  - roles [59](#)
  - types of [58](#)
- user names
  - default [43](#)
  - rules [61](#)
- users
  - adding [63](#)
  - authentication, iSCSI environments [222](#)
  - control panel settings [120](#)
  - default names and passwords [43](#)
  - deleting [65](#)
  - information of hosts, changing [226](#)
  - iSCSI environment authentication [193](#)
  - logon restrictions [44](#)
  - mutual authentication [227](#)
  - registering information on host [224](#)
  - Session Administration [53](#)
  - shredding data [278](#)

- Users pane [62](#)

## V

- VDEVs [257](#), [273](#)
- View link [48](#)
- volume count list [253](#)
- Volume Detail window, External Storage XP [809](#)
- Volume Initialize function [243](#), [248](#), [273](#), [278](#)
- Volume list
  - BC [453](#)
  - CA [518](#), [562](#)
- Volume Management [241](#)
- Volume Management pane [250](#)
- Volume to Space function [243](#), [245](#), [260](#), [278](#)
- volume, Identity pane [100](#)
- VSC operations
  - BC, combining with [446](#)
  - CA, combining with [512](#)
  - configuration information, viewing [259](#)
  - converting to normal [175](#)
  - converting volumes to space [172](#)
  - Customized Volume pane [257](#)
  - defined [169](#), [243](#)
  - deinstalling custom volumes [175](#)
  - Install Custom Volume function [246](#)
  - Install CV function [261](#)
  - installing custom volumes [173](#)
  - LDEV ID, setting [174](#)
  - limitations [170](#)
  - Make Volume function [248](#), [268](#)
  - restrictions [278](#)
  - samples [244](#)
  - specifications [170](#)
  - starting [172](#), [257](#)
  - Volume Initialize function [248](#), [273](#)
  - Volume to Space function [245](#), [260](#)
- VSC pane [135](#)

## W

- Web browsers, accessing Command View [42](#)
- web sites
  - HP documentation [36](#)
  - HP storage [37](#)
  - HP Subscriber's choice [37](#)
- Windows
  - host modes [186](#)
  - operating systems supported [39](#)
- write-pending data [346](#), [378](#)
- WWN tab, Auto LUN [367](#)
- WWN tab, Performance Control pane [401](#), [402](#)

## WWNs

- access settings [234](#)
- adding [235](#)
- deleting [211](#), [215](#), [237](#)
- groups, creating [236](#)
- Name table [201](#)
- names, changing [209](#)
- nicknames [237](#)
- settings [315](#)
- threshold control [407](#)
- upper limit values [406](#)

## Z

- Zer (Zero Red Cap mode) [290](#)
- Zer/Inv (Zero Read Cap Invisible mode) [290](#)