

user guide

# HP StorageWorks Command View XP

## for XP Disk Arrays

**Product Version:** 1.8A

First Edition (March 2004)

**Part Number:** B9357-96085

This guide provides information about Command View XP and its features, and describes procedures for using Command View XP to provide centralized, Web-based management for the HP StorageWorks Disk Array XP48, XP128, XP256, XP512, and XP1024.



© Copyright 1999-2004 Hewlett-Packard Development Company, L.P.

Hewlett-Packard Company makes no warranty of any kind with regard to this material, including, but not limited to, the implied warranties of merchantability and fitness for a particular purpose. Hewlett-Packard shall not be liable for errors contained herein or for incidental or consequential damages in connection with the furnishing, performance, or use of this material.

This document contains proprietary information, which is protected by copyright. No part of this document may be photocopied, reproduced, or translated into another language without the prior written consent of Hewlett-Packard. The information contained in this document is subject to change without notice.

Java™ is a U.S. trademark of Sun Microsystems, Inc.

Microsoft®, MS-DOS®, MS Windows®, Windows®, and Windows NT® are U.S. registered trademarks of Microsoft Corporation.

Oracle® is a registered U.S. trademark of Oracle Corporation, Redwood City, California.

UNIX® is a registered trademark of The Open Group.

Hewlett-Packard Company shall not be liable for technical or editorial errors or omissions contained herein. The information is provided "as is" without warranty of any kind and is subject to change without notice. The warranties for Hewlett-Packard Company products are set forth in the express limited warranty statements for such products. Nothing herein should be construed as constituting an additional warranty.

Printed in the U.S.A.

Command View XP for XP Disk Arrays User Guide  
First Edition (March 2004)  
Part Number: B9357-96085

<b>About this Guide</b> . . . . .	<b>37</b>
Overview . . . . .	38
Intended Audience . . . . .	38
Prerequisites . . . . .	38
Related Documentation . . . . .	38
Conventions . . . . .	39
Document Conventions . . . . .	39
Text Symbols . . . . .	39
Getting Help . . . . .	41
HP Technical Support . . . . .	41
HP Storage Website . . . . .	41
HP Authorized Reseller . . . . .	41
<b>1 Getting Started</b> . . . . .	<b>43</b>
Features . . . . .	45
Communicating with the Disk Arrays . . . . .	47
Starting Command View from a Browser . . . . .	48
Default User Names and Passwords . . . . .	49
Starting Command View from Storage Area Manager . . . . .	50
Main Tab and Overview/Launch Screen . . . . .	51
Using the Backup Utility . . . . .	53
<b>2 User Administration</b> . . . . .	<b>55</b>
Accessing User Administration . . . . .	56
Rules for User Names and Passwords . . . . .	57
Adding a New User . . . . .	58
Modifying a User's Password . . . . .	59
Deleting a User . . . . .	60
Setting User Attributes . . . . .	61
Automatic Downgrading of Permissions . . . . .	62

<b>3</b>	<b>Application Administration</b> .....	<b>63</b>
	Accessing Application Administration.....	64
	Adding Applications.....	66
	Deleting Applications.....	67
	Editing Application Information.....	68
<b>4</b>	<b>Support Screens</b> .....	<b>69</b>
	Accessing the Support Screen .....	70
	Download Page .....	70
	FAQs .....	71
	Reference Documents .....	72
	Integrating Command View with Other Products .....	73
	Other HP Products .....	74
<b>5</b>	<b>Device Administration</b> .....	<b>75</b>
	Accessing Device Administration .....	76
	Adding (Registering) a Disk Array.....	78
	Deleting (Unregistering) a Disk Array.....	79
	Changing Disk Array Parameters.....	80
	Viewing Device History.....	81
	Setting SNMP IP Security .....	82
	Accessing SNMP IP Security.....	82
	Adding SNMP IP Security.....	83
	Removing SNMP IP Security .....	84
	Managing License Keys.....	85
	Accessing License Key Management .....	85
	License Key Management Main Screen .....	86
	Installing a License Key.....	88
	Uninstalling a License Key .....	89
<b>6</b>	<b>Array Event History and Event Notification</b> .....	<b>91</b>
	Viewing Array Event History.....	92
	Accessing Event Notification.....	93
	Configuring Event History Settings.....	93
	Specifying the E-mail Server for E-mail Notifications .....	94
	Configuring E-mail Notifications .....	95
	Configuring Script Notifications .....	98
	Configuring SNMP Notifications .....	101
	Managing the Notification Schedule .....	104



---

Viewing a List of Configured Notifications . . . . .	106
Viewing Event History . . . . .	106
Viewing Notification History . . . . .	108
Deleting History Events . . . . .	109
Testing Event Notification . . . . .	110
<b>7 Session Administration . . . . .</b>	<b>113</b>
Accessing Session Administration . . . . .	114
Ending a Session . . . . .	115
Changing the Session Timeout Value . . . . .	116
<b>8 Identity Screen . . . . .</b>	<b>117</b>
Viewing Identity Information . . . . .	118
<b>9 Status Monitoring . . . . .</b>	<b>121</b>
Accessing the Status Overview Screen . . . . .	122
Port/LUN Map Screen . . . . .	124
Ldev/Port Map Screen . . . . .	126
ACP/Ldev Map Screen . . . . .	128
Ports Screen . . . . .	130
Device Health Screen . . . . .	132
LUN Security Screen . . . . .	134
Cache LUN Screen . . . . .	136
VSC Screen . . . . .	138
Parity Group Screen . . . . .	140
<b>10 LUN Management for the XP48/XP256/XP512 . . . . .</b>	<b>143</b>
Starting LUN Management . . . . .	144
View/Delete LUNs: Viewing SCSI/FC Path Information . . . . .	146
View/Delete LUNs: Deleting SCSI/FC Paths . . . . .	147
Add Path: Adding SCSI/FC Paths . . . . .	148
LUN Size Expansion (LUSE) . . . . .	152
Starting LUN Size Expansion . . . . .	153
Viewing Expanded LUN Information: Detail Screen . . . . .	154
Creating Expanded LUNs (Continuous) . . . . .	155
Creating Expanded LUNs (Dispersed) . . . . .	157
Host Modes . . . . .	160
Viewing the Host Mode Configuration . . . . .	161
Setting or Changing the Host Mode . . . . .	162

Configuring Fibre Channel Ports . . . . .	164
Viewing the Fibre Channel Port Configuration . . . . .	164
Setting or Changing Fibre Channel Port Addresses. . . . .	165
Setting or Changing Fibre Channel Port Topology . . . . .	166
Volume Size Configuration . . . . .	169
VSC Functions . . . . .	169
VSC Limitations. . . . .	170
VSC Specifications . . . . .	170
Starting VSC . . . . .	172
Converting a Normal Volume to VSC Space . . . . .	174
Installing Custom Volumes . . . . .	178
Setting the LDEV ID . . . . .	179
Specifying the Subsystem ID (XP256 Only). . . . .	180
Deinstalling Custom Volumes . . . . .	181
Converting a VSC Volume to a Normal Volume . . . . .	183
Operational Restrictions . . . . .	186
Restrictions on LUN Management Operations . . . . .	186
Restrictions on VSC and LUSE Operations. . . . .	187
Restrictions on Port Operations . . . . .	187
<b>11 LUN Management for the XP128/XP1024 . . . . .</b>	<b>189</b>
Supported Emulation Types. . . . .	189
LU Paths. . . . .	189
Configuring LU Paths in a NAS environment. . . . .	190
16-Port FC/CA CHIP Product . . . . .	192
Host Groups . . . . .	193
Host Modes . . . . .	194
LUN Security . . . . .	196
RAID Manager Command Devices. . . . .	198
Fibre Channel Ports Attributes. . . . .	198
LUN Management Operations . . . . .	203
Starting LUN Management Operations . . . . .	204
LUN Management Main Screen . . . . .	204
Defining LU Paths . . . . .	209
Changing or Viewing LU Path Settings. . . . .	215
Defining Alternate Paths . . . . .	225
Displaying Alternate Paths. . . . .	232
Deleting WWNs. . . . .	233
Applying and Removing LUN Security. . . . .	234

---

Creating RAID Manager Command Devices . . . . .	235
Port Operations . . . . .	238
Starting Port Operations . . . . .	238
Port Screen . . . . .	239
Setting the Fibre Channel Topology . . . . .	241
Setting Fibre Channel Port Addresses . . . . .	241
Setting the Data Transfer Speed . . . . .	241
Switching to Standard, High-Speed, or High-Speed (2 Port) Mode . . . . .	242
Partial Cache Residence (PCR) Operations . . . . .	243
Overview of the PCR Function . . . . .	243
Starting PCR Operations . . . . .	243
PCR Main Panel . . . . .	244
PCR Operations . . . . .	246
Operational Restrictions . . . . .	250
Restrictions on LUN Management Operations . . . . .	250
Restrictions on Port Operations . . . . .	252
<b>12 LUN Security for the XP48/XP256/XP512 . . . . .</b>	<b>253</b>
Starting LUN Security . . . . .	254
Enabling and Disabling LUN Security . . . . .	257
Defining LUN Security . . . . .	258
Changing LUN Security Parameters . . . . .	260
Changing WWN Access to a LUN . . . . .	260
Creating a LUN Group . . . . .	260
Changing LUN Group Information . . . . .	261
Creating or Changing a LUN Group Nickname . . . . .	262
Adding a New WWN . . . . .	263
Creating a WWN Group . . . . .	264
Deleting a WWN or WWN Group . . . . .	266
Updating WWNs and Nicknames . . . . .	266
Changing WWN Group Members . . . . .	267
<b>13 Volume Management for the XP128/XP1024 . . . . .</b>	<b>269</b>
Volume Management (LU Size Expansion) . . . . .	270
LUSE Rules . . . . .	271
LUSE Operations that Handle a Path-defined LDEV . . . . .	272
Volume Size Configuration (VSC) . . . . .	273
Parity Group Configuration . . . . .	275
Volume to Space Operation . . . . .	276

Install Custom Volume (CV) Operation . . . . .	277
Volume Initialize and Make Volume Operations . . . . .	279
LUSE Operations . . . . .	282
Starting LUSE Operations . . . . .	282
Volume Management Screen . . . . .	283
Viewing LUSE Configuration Information . . . . .	286
Viewing Concatenated Parity Groups . . . . .	287
Creating a LUSE Volume Using the Volume Count Drop-down List. . . . .	287
Creating a LUSE Volume Using the Select an LDEV Drop-down List . . . . .	288
Creating a LUSE Volume Using the LDEV Information Table . . . . .	289
Releasing a LUSE Volume . . . . .	291
Changing LUSE Capacities . . . . .	292
Resetting an Unregistered LUSE Volume . . . . .	292
VSC Operations . . . . .	294
Starting VSC Operations . . . . .	294
Customized Volume Screen. . . . .	295
Viewing VSC Configuration Information . . . . .	296
Viewing Concatenated Parity Groups . . . . .	297
Converting Volumes to Space (Volume to Space) . . . . .	297
Creating Custom Volumes (Install CV). . . . .	299
Deleting Custom Volumes (Volume to Space) . . . . .	309
Creating Initial Custom Volumes for OPEN-V (Make Volume). . . . .	309
Initializing Custom Volumes for Other than OPEN-V (Volume Initialize) . . . . .	317
Operational Restrictions . . . . .	322
Restrictions on VSC and LUSE Operations. . . . .	322
<b>14 LUN Security Extension for the XP128/XP1024 . . . . .</b>	<b>323</b>
Assigning Access Attributes to Logical Volumes . . . . .	323
Using LUN Security Extension with Other Products . . . . .	325
Starting LUN Security Extension . . . . .	327
LUN Security Extension Screen . . . . .	328
Volume Detail Window . . . . .	330
Error Detail Window . . . . .	331
Using LUN Security Extension . . . . .	332
Changing Access Attributes of Logical Volumes . . . . .	332
Protecting Logical Volumes Against CA and BC Operations. . . . .	333
Viewing a List of Logical Volumes Combined into a LUSE Volume . . . . .	335

---

<b>15 Configuration File Loader for the XP128/XP1024.</b> . . . . .	<b>337</b>
Configuration File Loader Components. . . . .	337
Configuration File Loader Tasks . . . . .	338
Spreadsheet Type and Available Function. . . . .	339
Requirements for Configuration File Loader . . . . .	341
Spreadsheet Software Requirements . . . . .	341
Starting Configuration File Loader. . . . .	344
Configuration File Loader Screen . . . . .	344
Spreadsheet Rules and Formats . . . . .	346
Spreadsheet File Rules. . . . .	346
Spreadsheet Components . . . . .	348
Writing the Configuration Definition. . . . .	352
LUN Manager Spreadsheet. . . . .	354
Port Settings . . . . .	355
CHA Mode Settings. . . . .	357
Host Group Settings. . . . .	357
WWN Settings . . . . .	358
Path Settings. . . . .	359
Command Device Settings. . . . .	360
Using Configuration File Loader . . . . .	361
Downloading a Spreadsheet File . . . . .	362
Editing a Spreadsheet File . . . . .	363
Uploading a Spreadsheet File. . . . .	365
Spreadsheet Error Checking . . . . .	367
First Check . . . . .	367
Second Check. . . . .	367
Third Check . . . . .	368
<b>16 Cache LUN for the XP48/XP256/XP512</b> . . . . .	<b>371</b>
Supported Emulation Types and Other Parameters . . . . .	373
Restrictions . . . . .	374
Cache LUN Modes . . . . .	375
Priority Mode . . . . .	375
Bind Mode . . . . .	375
Starting Cache LUN . . . . .	377
Cache LUN Screen. . . . .	377
Setting (Creating) a Cache Extent . . . . .	379
Releasing (Removing) a Cache Extent. . . . .	381
Changing an Extent's Mode . . . . .	382

<b>17 Cache LUN for the XP128/XP1024</b> .....	<b>383</b>
Supported Emulation Types and Other Parameters .....	385
Restrictions .....	386
Cache LUN Modes .....	387
Priority Mode .....	387
Bind Mode .....	388
Pre-staging .....	389
Starting Cache LUN .....	390
Cache LUN Screen .....	390
Setting (Creating) a Cache Extent .....	394
Releasing (Removing) a Cache Extent .....	398
Changing an Extent's Mode and Pre-staging .....	400
<b>18 Auto LUN for the XP48/XP512</b> .....	<b>401</b>
Starting Auto LUN .....	402
About Monitoring .....	403
About Manual Migration .....	405
Creating Migration Plans .....	405
Viewing Migration Progress Status .....	406
Canceling Manual Migration Plans .....	406
About Auto Migration .....	407
Migration Parameters .....	407
Migration Details .....	408
View Configuration .....	411
Disk Utilization/Manual Migration .....	413
LDEV Utilization Screen .....	414
Manual Migration Screen .....	415
View/Stop Migration Screen .....	417
Hardware Utilization .....	419
Auto Migration .....	421
Execution Parameter Settings Screen .....	422
Auto Migration Class Detail Screen .....	425
Fix Parity Group Attributes Screen .....	427
History Log .....	429
<b>19 Auto LUN for the XP128/XP1024</b> .....	<b>431</b>
Auto LUN Statistics .....	431
Auto LUN Uses .....	435
Reserve Volumes .....	435

---

Volume Migration . . . . .	436
Estimating Usage Rates . . . . .	436
Automatic Migration . . . . .	437
Manual Migration. . . . .	441
Requirements and Restrictions . . . . .	442
Starting Auto LUN . . . . .	446
Auto LUN Main Screen . . . . .	446
Port-LUN, LDEV, and Physical Tabs . . . . .	448
Auto LUN Monitoring Options Screen . . . . .	451
Usage Statistics. . . . .	453
Collecting Usage Statistics About Disk Array Resources . . . . .	453
Viewing Parity Group Usage Statistics . . . . .	453
Viewing Logical Volume Usage Statistics . . . . .	454
Viewing Channel Adapter (CHA) Usage Statistics . . . . .	456
Viewing Channel Processor (CHP) Usage Statistics . . . . .	457
Viewing Disk Adapter (DKA) Usage Statistics. . . . .	458
Viewing Disk Processor (DKP) Usage Statistics. . . . .	458
Viewing Disaster Recovery and Regeneration Processor (DRR) Usage Statistics . . . .	459
Viewing Write Pending Rates . . . . .	460
Viewing Access Path Usage Statistics. . . . .	461
Workload and Traffic Statistics . . . . .	463
Collecting Workload and Traffic Statistics About Disk Drives, Ports, and LU Paths. .	463
Viewing Disk Drive Workload Statistics. . . . .	463
Viewing Disk Array Port Traffic Statistics . . . . .	465
Creating and Executing Migration Plans . . . . .	468
Accessing the Plan Screens . . . . .	468
Manual Migration Screen. . . . .	468
Migrating Volumes Manually . . . . .	470
Deleting Manual Migration Plans . . . . .	472
Auto Migration Screen. . . . .	473
Setting Auto Migration Parameters . . . . .	475
Deleting Auto Migration Plans . . . . .	476
Remaking Auto Migration Plans . . . . .	476
Attribute Screen . . . . .	477
Reserving Target Volumes. . . . .	479
Setting (“Fixing”) a Parity Group . . . . .	480
Releasing (“Unfixing”) a Parity Group . . . . .	481
Changing the Maximum Disk Usage Rate for an HDD Class. . . . .	481

History Screen . . . . .	483
Viewing the Migration History Log . . . . .	484
<b>20 Business Copy (BC) for the XP128/XP1024 . . . . .</b>	<b>491</b>
Overview of BC Operations . . . . .	492
BC Components . . . . .	492
BC Requirements . . . . .	495
BC Operations . . . . .	499
BC Options . . . . .	509
Cascade Function . . . . .	510
At-Time Split Function . . . . .	515
Pair Status . . . . .	517
Cautions on Switching Off the Power Supply . . . . .	520
Preparing for BC Operations . . . . .	522
System Requirements . . . . .	522
Preparing for BC Operations . . . . .	522
Combining BC with Other Data Management Operations . . . . .	523
Starting BC . . . . .	527
BC Main Screen . . . . .	528
Performing BC Operations . . . . .	538
Setting the Reserve Attribute . . . . .	538
Resetting the Reserve Attribute . . . . .	539
Creating BC Pairs (Paircreate) . . . . .	540
Splitting BC Pairs (Pairsplit) . . . . .	545
Resynchronizing BC Pairs (Pairresync) . . . . .	549
Suspending BC Pairs (Pairsplit-E) . . . . .	552
Deleting BC Pairs (Pairsplit-S) . . . . .	554
Viewing BC Pair Status and History . . . . .	556
Setting BC Options . . . . .	558
BC Error Codes . . . . .	560
<b>21 Continuous Access (CA) for the XP128/XP1024 . . . . .</b>	<b>567</b>
Overview of CA Operations . . . . .	568
Components . . . . .	569
Remote Copy Operations . . . . .	577
CA Asynchronous Recordset Operations . . . . .	580
CA Asynchronous Consistency Group Operations . . . . .	585
CA Volume Pair Status . . . . .	587
Preparing for CA Operations . . . . .	598



---

System Requirements . . . . .	598
Requirements and Restrictions . . . . .	599
Installing the Hardware . . . . .	602
Configuring the MCUs and RCUs for CA Operations . . . . .	609
Combining CA with Other Data Management Operations . . . . .	612
Starting CA . . . . .	617
CA Screens . . . . .	617
CA Main Screen (Pair Operation Screen) . . . . .	619
RCU Operation Screen . . . . .	625
Asynchronous Operation Screen . . . . .	629
Usage Monitor Screen . . . . .	630
History Operations Screen . . . . .	631
Performing CA Configuration Operations . . . . .	635
MCU Operations . . . . .	636
RCU Operations . . . . .	638
CA Asynchronous Operations . . . . .	660
Usage Monitor Operations . . . . .	672
Optimizing CA Operations and Disk Array Performance . . . . .	677
Discontinuing CA Operations . . . . .	679
Performing CA Pair Operations . . . . .	680
Preparing for CA Volume Pair Operations . . . . .	680
Common Procedure for CA Pair Operation . . . . .	681
Viewing CA Pair Status for LUs and LDEVs (Pairdisplay) . . . . .	684
Creating CA Volume Pairs (Paircreate) . . . . .	686
Splitting CA Pairs (Pairsplit-r) . . . . .	693
Resuming CA Volume Pairs (Pairresync) . . . . .	697
Deleting CA Volume Pairs (Pairsplit-S) . . . . .	701
Changing the Pair Options (Change Pair Option) . . . . .	705
Using CA for Data Migration and Duplication . . . . .	707
Powering Off/On CA Components . . . . .	709
CA Disaster Recovery Operations . . . . .	712
Preparing for Disaster Recovery . . . . .	712
Switching Operations to the Remote Site . . . . .	716
Transferring Operations Back to the Primary Site . . . . .	719
Resuming Normal Operations at the Primary Site . . . . .	720
Error Codes and Messages . . . . .	722
CA Error Codes . . . . .	722
Service Information Messages (SIMs) . . . . .	722

Pinned Track Recovery for CA Volumes . . . . .	723
<b>22 TrueCopy for the XP128/XP1024 (Mainframe) . . . . .</b>	<b>725</b>
Other Data Duplication Features . . . . .	726
Overview of TrueCopy Operations . . . . .	729
Components . . . . .	730
Remote Copy Operations . . . . .	742
TrueCopy Asynchronous Recordset Operations . . . . .	747
TrueCopy Asynchronous Consistency Group Operations . . . . .	756
TrueCopy Volume Pair Status . . . . .	759
PPRC Support . . . . .	767
Preparing for TrueCopy Operations . . . . .	771
System Requirements . . . . .	771
Requirements and Restrictions . . . . .	773
Installing the TrueCopy Hardware . . . . .	777
Installing the TrueCopy Software . . . . .	784
Configuring the MCUs and RCUs for TrueCopy Operations . . . . .	785
Combining TrueCopy with Other Data Management Operations . . . . .	791
Starting TrueCopy . . . . .	797
Performing TrueCopy Configuration Operations . . . . .	798
TrueCopy Main Screen . . . . .	799
TrueCopy Main Screen (Pair Operations Screen) . . . . .	801
RCU Operations Screen . . . . .	808
Asynchronous Operations Screen . . . . .	813
Usage Monitor Screen . . . . .	814
Script Operations Screen . . . . .	816
History Screen . . . . .	819
Other Operations Screen . . . . .	821
RCU Operations . . . . .	822
Asynchronous Operations . . . . .	850
Usage Monitor Operations . . . . .	862
Script Operations . . . . .	867
History Operations . . . . .	867
Other Operations . . . . .	867
Optimizing TrueCopy Operations and Disk Array Performance . . . . .	868
Discontinuing TrueCopy Operations . . . . .	870
Performing TrueCopy Pair Operations . . . . .	872
Preparing for TrueCopy Volume Pair Operations . . . . .	872
Common Procedure for TrueCopy Pair Operation . . . . .	873

---

Viewing the Status of TrueCopy Volume Pairs (Pair Status) . . . . .	876
Creating TrueCopy Volume Pairs (Add Pair) . . . . .	880
Suspending TrueCopy Pairs (Suspend Pair) . . . . .	890
Resuming TrueCopy Volume Pairs (Resume Pair) . . . . .	894
Deleting TrueCopy Volume Pairs (Delete Pair) . . . . .	898
Changing the Pair Options (Change Pair Option) . . . . .	903
ICKDSF Considerations for TrueCopy Volumes . . . . .	905
Using TrueCopy for Data Migration and Duplication . . . . .	907
Powering Off/On TrueCopy Components . . . . .	910
TrueCopy Disaster Recovery Operations . . . . .	913
Preparing for Disaster Recovery . . . . .	913
Switching Operations to the Remote Site . . . . .	918
Transferring Operations Back to the Main Site . . . . .	921
Resuming Normal Operations at the Main Site . . . . .	923
Troubleshooting . . . . .	925
General TrueCopy Troubleshooting . . . . .	925
TrueCopy Software Error Codes . . . . .	932
Using PPRC Commands for TrueCopy . . . . .	933
Overview of PPRC Commands . . . . .	933
Using PPRC TSO Commands with TrueCopy Asynchronous . . . . .	938
CGROUP (FREEZE/RUN) Support . . . . .	950
IEA494I and IEA491E Console Messages . . . . .	959
XP128/XP1024 Response Characteristics to Failure Conditions . . . . .	961
Pinned Track Recovery for TrueCopy Volumes . . . . .	972
SIM Reporting . . . . .	973
TrueCopy Scripting . . . . .	979
Overview of Scripting . . . . .	979
Syntax for Scripting . . . . .	981
Operation Macro Commands . . . . .	984
Internal Macro Commands . . . . .	995
Work Variables . . . . .	999
Reserved Variables . . . . .	1000
Optional Script Parameters . . . . .	1003
Error Reporting . . . . .	1007
HXRC Device Blocking and Load Balancing . . . . .	1015
Device Blocking Function . . . . .	1015
Load Balancing Control . . . . .	1015

<b>23 ShadowImage for the XP128/XP1024 (Mainframe)</b> . . . . .	<b>1023</b>
ShadowImage Components . . . . .	1023
ShadowImage Requirements . . . . .	1026
ShadowImage Operations . . . . .	1029
ShadowImage Options . . . . .	1039
At-Time Split Function . . . . .	1041
ShadowImage Pair Status . . . . .	1043
Cautions on Switching Off the Power Supply . . . . .	1047
Preparing for ShadowImage Operations . . . . .	1049
System Requirements . . . . .	1049
Preparing for ShadowImage Operations . . . . .	1049
Combining ShadowImage with Other Data Management Operations . . . . .	1050
Starting ShadowImage . . . . .	1056
ShadowImage Main Screen . . . . .	1057
Performing ShadowImage Operations . . . . .	1066
Setting the Reserve Attribute . . . . .	1066
Resetting the Reserve Attribute . . . . .	1068
Adding ShadowImage Pairs . . . . .	1069
Splitting ShadowImage Pairs . . . . .	1073
Resynchronizing ShadowImage Pairs . . . . .	1078
Suspending ShadowImage Pairs . . . . .	1081
Deleting ShadowImage Pairs . . . . .	1083
Viewing ShadowImage Pair Status and History . . . . .	1085
Setting ShadowImage Options . . . . .	1087
CTG Screen . . . . .	1089
Using PPRC Commands for ShadowImage . . . . .	1094
PPRC Command Support . . . . .	1094
PSF and DEVSERV Commands . . . . .	1105
Adding Pairs: CESTPAIR and PPRCOPY ESTPAIR . . . . .	1106
Displaying Pair Status: CQUERY, PPRCOPY QUERY, DEVSERV . . . . .	1106
Splitting Pairs: CSUSPEND and PPRCOPY SUSPEND . . . . .	1110
Resynchronizing Pairs: MODE(RESYNC) Parameter . . . . .	1112
Deleting Pairs: CDELPAIR and PPRCOPY DELPAIR . . . . .	1113
Setting and Resetting the At-Time Split Time: ATSPLIT . . . . .	1113
Displaying the Status of the Consistency Group: ATQUERY . . . . .	1115
Using ShadowImage - FlashCopy . . . . .	1118
Overview of ShadowImage - FlashCopy . . . . .	1118
ShadowImage - FlashCopy Pair Status . . . . .	1119

Establishing ShadowImage - FlashCopy Pairs .....	1120
Combining ShadowImage - FlashCopy With Other Copy Solutions .....	1122
Using ShadowImage - FlashCopy Host Commands .....	1124
Cautions on Switching Off the Power Supply When Using ShadowImage - FlashCopy ..	1131
Troubleshooting .....	1132
General ShadowImage Troubleshooting .....	1132
ShadowImage Error Window .....	1133
<b>24 HPAV for the XP128/XP1024 (Mainframe) .....</b>	<b>1135</b>
Overview of HPAV Operations .....	1136
Components .....	1136
Static and Dynamic HPAV Operations .....	1138
Requirements and Restrictions .....	1141
Maximizing Your HPAV Results .....	1142
Preparing for HPAV Operations .....	1144
System Requirements .....	1144
Preparing the XP128/XP1024 for HPAV Operations .....	1145
Preparing the Host System for HPAV Operations .....	1146
Starting HPAV .....	1148
HPAV Screen .....	1148
Performing HPAV Operations .....	1151
Assigning and Canceling Aliases .....	1151
Considerations for Defining the XP128/XP1024 Devices to the Host System .....	1155
Monitoring HPAV Activities .....	1158
Additional MVS Commands .....	1158
GTF I/O Tracing .....	1158
Using HCD to Define and View XP128/XP1024 LCUs and HPAV Devices .....	1162
Using HCD to Define an XP1024 LCU and the Base and Alias Devices .....	1162
Displaying HPAV Device Parameters .....	1175
Checking the WLM PAV Settings .....	1180
<b>25 SANtinel - S/390 for the XP128/XP1024 (Mainframe) .....</b>	<b>1183</b>
Overview of SANtinel Operations .....	1184
System Requirements .....	1184
Protecting Logical Volumes from I/O Operations at Mainframe Hosts .....	1184
Protecting Logical Volumes from Erroneous Remote Copy Operations .....	1189
Restrictions and Cautions .....	1189
Starting SANtinel .....	1192

SANtinel Screen . . . . .	1192
Applying and Disabling Security . . . . .	1196
Enabling Only the Specified Hosts to Access Logical Volumes . . . . .	1196
Prohibiting All Hosts from Accessing Logical Volumes . . . . .	1206
Protecting Logical Volumes from Remote Copy Operations . . . . .	1208
Disabling Security . . . . .	1210
Editing Security Settings . . . . .	1212
Editing Security Groups . . . . .	1212
Editing Host Groups . . . . .	1214
Editing LDEV Groups . . . . .	1220
Viewing Security Settings . . . . .	1224
Finding Logical Volumes in a Specified Security Group . . . . .	1224
Finding Security Groups that Contains a Specified Host . . . . .	1225
Finding Ports Through which Hosts Can Access Logical Volumes . . . . .	1227
Finding Logical Volumes in the Security Group that Contains a Specified Host . . . . .	1228
Finding Security Groups that Contain a Specified Logical Volume . . . . .	1229
Finding Hosts in the Security Group that Contains a Specified Logical Volume . . . . .	1230
Finding Security Groups that Contain a Specified Host Group . . . . .	1231
Finding Security Groups that Contain a Specified LDEV Group . . . . .	1232
General SANtinel Troubleshooting . . . . .	1234
<b>26 LDEV Guard for the XP128/XP1024 (Mainframe) . . . . .</b>	<b>1237</b>
Assigning Access Attributes to Logical Volumes . . . . .	1237
Using Pattern Files . . . . .	1239
Using LDEV Guard with Other Products . . . . .	1240
Requirements for LDEV Guard . . . . .	1242
Starting LDEV Guard . . . . .	1243
LDEV Guard Screen . . . . .	1243
LDEV Guard Error Window . . . . .	1245
Using LDEV Guard . . . . .	1247
Changing Access Attributes of Logical Volumes . . . . .	1247
Creating a Pattern File . . . . .	1248
Editing a Pattern File . . . . .	1249
Applying a Pattern File to the Disk Array . . . . .	1249
Renaming a Pattern File . . . . .	1250
Deleting a Pattern File . . . . .	1250
Downloading a Pattern File . . . . .	1251
Uploading a Pattern File . . . . .	1252
Specifying the VTOC Size . . . . .	1253

<b>27 Direct Backup Engine (DBE) for the XP128/XP1024</b> .....	<b>1255</b>
Host Server Requirements .....	1256
Supported Backup Devices .....	1256
Disk Array Requirements .....	1256
Starting DBE .....	1257
DBE Screen .....	1257
Using DBE .....	1262
Viewing Detailed Port Information .....	1262
Adding Ports to Port Groups .....	1264
Moving Ports from Port Groups .....	1267
Setting a Timeout Period .....	1269
Changing Target Ports, RCU Target Ports, or External Ports to Initiator Ports .....	1271
Changing Initiator Ports, RCU Target Ports, or External Ports to Target Ports .....	1272
<b>A Troubleshooting</b> .....	<b>1275</b>
The Browser Displays “Data Retrieval in Progress” Message for a Long Time .....	1276
The Device Health Screen Displays Red or Yellow Disk Array Components .....	1276
The Session Administration Screen Reports the Incorrect Host Address .....	1276
The Disk Array License Key Installation Fails .....	1277
The Identity and Status Screens Contain Outdated Information .....	1278
Problems Occur When Removing LUSE Volumes from Volume Management .....	1278
The Refresh Fails with an SNMP Timeout Error .....	1278
Command View Reports “Possible Auto LUN initialization problem” .....	1279
An Error Occurs When Entering the IP Address in the Device Administration Screen .....	1279
Configuration File Loader Fails to Start or the Spreadsheet File Cannot be Uploaded .....	1280
Business Copy Fails or Does Not Function Properly .....	1280
Continuous Access Fails or Does Not Function Properly .....	1281
<b>Index</b> .....	<b>1289</b>

**Figures**

1 Command View integrated with other management platforms and application modules	44
2 Command View initial screen .....	48
3 Login dialog box .....	49
4 Overview/Launch screen .....	51
5 User Administration screen .....	56
6 Add a New User screen .....	58
7 Modify User Password screen .....	59
8 Delete a User screen .....	60

9	Set Attributes for a User screen . . . . .	61
10	Downgrading Permission message . . . . .	62
11	Application Administration screen . . . . .	64
12	Add New Applications screen . . . . .	66
13	Deleting applications (Application Administration screen). . . . .	67
14	Edit Applications screen . . . . .	68
15	Download page. . . . .	70
16	FAQ page . . . . .	71
17	Reference Documents page . . . . .	72
18	Integrating Command View with Other Platforms page . . . . .	73
19	HP Customer Care Web page . . . . .	74
20	Device Administration screen (XP128/XP1024). . . . .	76
21	Device History screen . . . . .	81
22	IP Security Manager screen . . . . .	83
23	Accessing License Key Management . . . . .	86
24	License Key Management main screen . . . . .	87
25	License Key Management (Install) screen. . . . .	88
26	License Key Management (Uninstall) screen . . . . .	89
27	Array Event History screen . . . . .	92
28	Notification screen. . . . .	93
29	History Log Configuration screen . . . . .	94
30	Email Server Configuration screen . . . . .	95
31	Email Notification screen. . . . .	96
32	Notification screen for e-mail notifications . . . . .	97
33	Script Notification screen. . . . .	99
34	Notification screen for script notifications. . . . .	100
35	SNMP Notification screen . . . . .	102
36	Notification screen for SNMP notifications. . . . .	103
37	Schedule screen for creating a new schedule. . . . .	104
38	Schedule screen for existing schedules . . . . .	105
39	Event History screen . . . . .	107
40	Notification History screen . . . . .	109
41	Clear History screen. . . . .	110
42	Array Test Event screen. . . . .	111
43	Path Connectivity Test Event screen . . . . .	112
44	Session Administration screen. . . . .	114
45	Identity screen (XP512). . . . .	118
46	Identity screen (XP1024). . . . .	119



---

47	Status Overview screen	122
48	Port/LUN Map screen	124
49	Ldev/Port Map screen	126
50	ACP/Ldev Map screen	128
51	Ports screen	130
52	Device Health screen	132
53	LUN Security screen	134
54	Cache LUN screen	136
55	VSC screen	138
56	Parity Group screen	140
57	LUN Management screen	144
58	Delete Path Confirmation screen (LUN Management screen)	147
59	Add Path screen	148
60	Add Path Confirmation screen	150
61	LUN Expansion Main screen	153
62	LUN Expansion Detail screen	155
63	LUN Expansion Continuous screen	156
64	LUN Expansion Disperse screen	158
65	View Host Mode Configuration screen	161
66	Host Mode Configuration screen	162
67	View Fibre Port Configuration screen	164
68	Setting a Fibre Channel port address (Set Fibre Port Configuration screen)	165
69	Setting a Fibre Channel topology (Set Fibre Port Configuration screen)	167
70	VSC functions	170
71	Volume Size Configuration (Main Screen) screen (XP256)	172
72	Volume Size Configuration (Main Screen) screen (XP48/XP512)	173
73	Volume Size Configuration (Normal To VSC) screen (XP256)	175
74	Volume Size Configuration (Volume To Space) screen (XP48/XP512)	176
75	Volume Size Configuration (Install CV) screen (XP48/XP512)	178
76	LDEV ID Configuration screen	180
77	Sub-System ID Configuration screen	181
78	Volume Size Configuration (Deinstall CV) screen	182
79	Deinstall CV Confirmation screen	183
80	Volume Size Configuration (VSC to Normal) screen (XP256)	184
81	LU paths configuration in a NAS environment	191
82	16-Port CHIP pair labeling	192
83	Host group example 1	193
84	Host group example 2	194

85	Host group example 3 (LUN security)	197
86	Differences between high-speed and high-speed (2 port) modes	202
87	LUN Management main screen	204
88	NAS folder in LU Path tree	206
89	Add New Host Group window	210
90	Add New WWN window	212
91	Change Host Group window	217
92	Change WWN & Nickname window	221
93	Alternate Paths window	233
94	Port screen (LUN Management screen)	239
95	PCR Cache Area (Cache Extent)	243
96	PCR Main Panel	244
97	LUN Security main screen	254
98	LUN Security main screen with WWN/WWN Group list box displayed	255
99	LUN/LUN Group Security screen	258
100	LUN Group screen	261
101	LUN Security main screen with Nickname field displayed	263
102	New WWN screen	264
103	WwnGroup screen	265
104	LUN Security main screen with Update WWN/WWN Group fields displayed	267
105	WwnGroup screen	268
106	LUSE configuration	270
107	VSC process (all supported emulation types except for OPEN-V)	274
108	VSC process (OPEN-V)	274
109	Parity group configuration for other than OPEN-V	275
110	Virtual VSC volume configuration for other than OPEN-V	276
111	Volume Management screen	283
112	Customized Volume screen (Volume Management screen)	295
113	Install CV window (1) for OPEN-V (when two or more free spaces are available)	300
114	Install CV window (1) for other than OPEN-V	301
115	Install CV window (1) for OPEN-V after clicking Set	302
116	Install CV window (1) for other than OPEN-V after clicking Set	304
117	Install CV window (2)	305
118	Setting the SSID	307
119	Install CV confirmation window	308
120	Make Volume window (1)	311
121	Make Volume window (1) after clicking Set	312
122	Make Volume window (2)	313

---

123 Make Volume confirmation window . . . . .	316
124 Volume Initialize window . . . . .	318
125 Volume Initialize confirmation window . . . . .	320
126 Example of access attributes . . . . .	324
127 LUN Security Extension screen. . . . .	327
128 Volume Detail window . . . . .	330
129 Error Detail window . . . . .	331
130 Volume Detail window . . . . .	336
131 Outline of the Configuration File Loader tasks . . . . .	339
132 Text Import Wizard - Step 1 of 3. . . . .	342
133 Text Import Wizard - Step 2 of 3. . . . .	342
134 Text Import Wizard - Step 3 of 3. . . . .	343
135 Configuration File Loader screen . . . . .	344
136 Example of Spreadsheet . . . . .	346
137 Format of configuration definition (settings) . . . . .	350
138 Index and parameter parts of a spreadsheet (example) . . . . .	353
139 Download window. . . . .	362
140 Specifying where to download the spreadsheet. . . . .	362
141 Upload window . . . . .	365
142 Specifying from where to upload the spreadsheet. . . . .	365
143 Cache LUN operations . . . . .	371
144 Cache LUN screen. . . . .	377
145 LUN/VOL Caching Define screen . . . . .	379
146 LUN/VOL Caching Define screen after clicking Set . . . . .	380
147 Cache LUN operations . . . . .	383
148 Cache LUN screen. . . . .	390
149 Auto LUN main screen . . . . .	402
150 Auto Migration function . . . . .	407
151 Migration of volumes based on the parity group class . . . . .	409
152 Moving volumes to another class based on utilization . . . . .	410
153 View Configuration screen . . . . .	411
154 Parity Group Utilization screen. . . . .	413
155 LDEV Utilization screen . . . . .	414
156 Manual Migration screen. . . . .	416
157 View/Stop Migration screen . . . . .	418
158 Hardware Utilization screen . . . . .	419
159 Auto Migration screen. . . . .	421
160 Execution Parameter Settings screen. . . . .	423

161 Auto Migration Class Detail screen.....	426
162 Fix Parity Group Attributes screen .....	427
163 Auto Migration History Display screen.....	429
164 Moving volumes to another class based on usage.....	439
165 Auto migration function example 1.....	440
166 Auto migration function example 2.....	440
167 Auto LUN main screen .....	446
168 Port-LUN, LDEV, and Physical tabs.....	448
169 Auto LUN Monitoring Options screen .....	451
170 Parity group usage statistics.....	454
171 Logical volume usage statistics .....	455
172 CHA usage statistics .....	456
173 CHP usage statistics.....	457
174 DKA usage statistics .....	458
175 DKP usage statistics .....	459
176 DRR usage statistics .....	460
177 Write pending rates .....	460
178 Usage statistics about paths between adapters and the cache switch .....	461
179 Usage statistics about paths between adapters and the shared memory .....	462
180 Usage statistics about paths between cache switches and the cache memory.....	462
181 Workload statistics for parity groups.....	464
182 Workload statistics for logical volumes in a parity group.....	464
183 Traffic statistics about ports in the disk array .....	466
184 Traffic statistics about host ports to which a disk array port is connected .....	466
185 Traffic statistics about host ports in a host group .....	466
186 Traffic statistics about LU paths .....	466
187 Manual Migration screen.....	468
188 Auto Migration screen.....	473
189 Attribute screen .....	477
190 Class table fields .....	478
191 Parity group table fields.....	479
192 Change Threshold window .....	482
193 History screen .....	483
194 BC overview .....	493
195 Adding a pair in BC.....	500
196 Update Copy operation .....	501
197 Normal and quick pairresync operations.....	503
198 Reverse and quick restore pair operations.....	504

---

199 Quick Restore operation with or without Swap&Freeze option . . . . .	510
200 Cascade pairs . . . . .	512
201 Overview of At-Time Split function . . . . .	516
202 BC pair status transitions . . . . .	518
203 BC and CA: shared P-VOL/P-VOL . . . . .	525
204 BC and CA: shared P-VOL/S-VOL . . . . .	525
205 BC and CA: shared P-VOL/P-VOL and P-VOL/S-VOL . . . . .	526
206 BC and CA: shared S-VOL/P-VOL . . . . .	526
207 BC main screen . . . . .	527
208 Volume List box . . . . .	530
209 Detail window . . . . .	533
210 S-Vol Path window . . . . .	534
211 Display Filter window . . . . .	535
212 Preset Volume List box . . . . .	536
213 Set Reserve Attribute window . . . . .	538
214 Reset Reserve Attribute window . . . . .	539
215 Paircreate window . . . . .	541
216 Pairsplit window . . . . .	545
217 Pairsync window . . . . .	550
218 Pairsplit-E window . . . . .	553
219 Pairsplit-S window . . . . .	555
220 History screen . . . . .	557
221 Option screen . . . . .	559
222 CA components for Fibre Channel connection . . . . .	570
223 CA components for Serial (ESCON) connection . . . . .	571
224 Remote copy operations . . . . .	577
225 Selecting and settling CA Async recordsets at the RCU . . . . .	583
226 Fibre Channel remote copy connections . . . . .	604
227 Direct connection . . . . .	605
228 Switch connection . . . . .	605
229 Extender connection . . . . .	606
230 Serial remote copy connections . . . . .	607
231 N pairs of remote copy connections . . . . .	607
232 N-to-1 and 1-to-n remote copy connections (n£4) . . . . .	608
233 Remote copy connections shared with channel-to-RCU connections . . . . .	609
234 Add RCU and RCU Option windows . . . . .	611
235 Async Option and Add CT Group windows . . . . .	612
236 Shared CA P-VOL and shared BC P-VOL . . . . .	615

---

237 Shared CA S-VOL and shared BC P-VOL . . . . .	615
238 Shared CA/BC P-VOL and shared CA S-VOL/BC P-VOL . . . . .	615
239 Shared BC S-VOL/CA P-VOL . . . . .	616
240 CA main screen . . . . .	617
241 CA main screen (Pair Operation screen) . . . . .	620
242 Volume list (partial view) . . . . .	621
243 Display Filter window . . . . .	624
244 RCU Operation screen. . . . .	625
245 RCU Operation screen with the MCU&RCU option button selected. . . . .	627
246 RCU Operation screen with the Port option button selected. . . . .	628
247 Asynchronous Operation screen . . . . .	629
248 Usage Monitor screen . . . . .	631
249 History Operations screen . . . . .	632
250 Configuring the MCU ports. . . . .	637
251 Displaying RCU status information. . . . .	640
252 RCU Status window . . . . .	641
253 Add RCU window . . . . .	643
254 RCU Option window . . . . .	644
255 Registering an RCU to the connected MCU . . . . .	646
256 RCU Settings Parameter list . . . . .	648
257 RCU Option window . . . . .	649
258 RCU Settings Parameter list (RCU Option) . . . . .	650
259 Fibre Channel interface connections going through switches . . . . .	652
260 Add RCU window used for configuration in <a href="#">Figure 259</a> . . . . .	652
261 Add Path window . . . . .	653
262 Adding a new logical path from the connected MCU to an existing RCU . . . . .	654
263 Add SSID window. . . . .	656
264 Adding/Deleting an SSID for an existing RCU. . . . .	657
265 Changing the port type. . . . .	658
266 Performing asynchronous operations . . . . .	661
267 CT Group Status window . . . . .	662
268 Add CT Group window . . . . .	663
269 CT Group Option window . . . . .	665
270 Consistency Group Settings Parameter list . . . . .	667
271 Async Option window . . . . .	669
272 Asynchronous Option Settings Parameter list . . . . .	671
273 Display Item window. . . . .	674
274 Performing the pair settings operation. . . . .	682

---

275 Pairdisplay window . . . . .	684
276 Paircreate window . . . . .	687
277 Pair Settings Parameter list (Paircreate) . . . . .	690
278 Pairsplit-r window . . . . .	694
279 Pair Settings Parameter list (Pairsplit-r) . . . . .	697
280 Pairresync window. . . . .	698
281 Pair Settings Parameter list (Pairresync) . . . . .	701
282 Pairsplit-S window. . . . .	702
283 Pair Settings Parameter list (Pairsplit-S) . . . . .	705
284 Change Pair Option window . . . . .	705
285 Pair Settings Parameter list (Pair Option) . . . . .	707
286 Relationship between log file and data file in PAIR status . . . . .	715
287 TrueCopy components for serial (ESCON) connection . . . . .	731
288 TrueCopy components for Fibre Channel connection. . . . .	732
289 TrueCopy remote copy operations. . . . .	743
290 Selecting and settling TrueCopy Async recordsets at the RCU . . . . .	751
291 Graduated delay process for sidefile management . . . . .	754
292 Dummy pair mode. . . . .	755
293 Fibre Channel remote copy connection configurations. . . . .	779
294 Fibre Channel interface direct connection (NL port) . . . . .	780
295 Fibre Channel interface switch connection (FL port or F port). . . . .	780
296 Fibre Channel interface extender connection . . . . .	781
297 Serial remote copy connection configurations . . . . .	782
298 N pairs of remote copy connections . . . . .	782
299 N-to-1 and 1-to-n remote copy connections (n£4) . . . . .	783
300 Remote copy connections shared with channel-to-RCU connections. . . . .	784
301 Setting the Async options . . . . .	786
302 Adding the consistency groups . . . . .	787
303 Add the RCUs (for Fibre) . . . . .	788
304 Configuring the RCU options . . . . .	789
305 Setting the Async options . . . . .	790
306 Adding the consistency groups . . . . .	791
307 TrueCopy and ShadowImage: shared M-VOL/S-VOL. . . . .	795
308 TrueCopy and ShadowImage: shared R-VOL/S-VOL . . . . .	795
309 TrueCopy and ShadowImage: shared M-VOL/S-VOL and R-VOL/S-VOL . . . . .	796
310 TrueCopy and ShadowImage: shared M-VOL/T-VOL. . . . .	796
311 TrueCopy main screen. . . . .	797
312 TrueCopy main screen (Pair Operations screen). . . . .	802

313 Volume list . . . . .	803
314 Display Filter window . . . . .	806
315 Example of snapshot file . . . . .	808
316 RCU Operations screen . . . . .	809
317 RCU Operations screen with the MCU&RCU option button selected . . . . .	810
318 RCU Operations screen with the Port option button selected . . . . .	811
319 Standard speed, two ports per row . . . . .	812
320 High-speed (2 port), two ports per row . . . . .	812
321 High-speed, four ports per row . . . . .	812
322 Asynchronous Operations screen . . . . .	813
323 Usage Monitor screen . . . . .	815
324 Script Operations screen . . . . .	817
325 Script Operations screen during execution of a script file . . . . .	819
326 History Operations screen . . . . .	820
327 Other Operations screen . . . . .	822
328 MCU/RCU list with the RCU Status command . . . . .	827
329 RCU Status window . . . . .	828
330 Add RCU windows (Fibre and Serial). . . . .	831
331 MCU/RCU list with the RCU Operation command . . . . .	833
332 Typical TC390 remote copy configuration with two paths . . . . .	835
333 Add RCU window – serial interface . . . . .	836
334 Fibre Channel interface connections going through switches . . . . .	837
335 Add RCU window – FC interface . . . . .	838
336 RCU Option window (Change RCU Option) . . . . .	839
337 Add Path window (for Fibre). . . . .	844
338 Opening the Add Path window . . . . .	845
339 Add SSID window . . . . .	847
340 Opening the Add SSID window . . . . .	848
341 Consistency Group list . . . . .	851
342 CT Group Status window . . . . .	852
343 Add CT Group window . . . . .	854
344 CT Group Option window . . . . .	857
345 Async Option window . . . . .	859
346 Display Item window . . . . .	864
347 TrueCopy main screen (Pair Operations screen) . . . . .	874
348 Pair Status window . . . . .	877
349 Add Pair (Synchronous) window . . . . .	881
350 Add Pair (Asynchronous) window . . . . .	882



---

351 Suspend Pair window (Asynchronous) . . . . .	890
352 Resume Pair window (Asynchronous) . . . . .	895
353 Delete Pair window (Asynchronous). . . . .	900
354 Change Pair Option window (Asynchronous). . . . .	904
355 Example of the TC390 error message . . . . .	932
356 Overview of GDPS operations . . . . .	956
357 Failure conditions (described in <a href="#">Table 116</a> ) . . . . .	962
358 Typical XP128/XP1024 SIM showing reference code and SIM type. . . . .	974
359 Result statement format. . . . .	1001
360 Scripting error code format . . . . .	1008
361 Current load balancing control . . . . .	1017
362 Combination 1: MODE 85,86 = ON,OFF; Threshold 1/2/3 = 30/40/50% . . . . .	1019
363 Combination 2 (Default): MODE 85,86 = OFF,OFF; Threshold 1/2/3 = 40/50/60%. . . . .	1020
364 Combination 3: MODE 85,86 = OFF,ON – Threshold 1/2/3 = 50/60/70% . . . . .	1021
365 Combination 4: MODE 85,86 = ON,ON – Threshold 1/2/3 = 60/70/80% . . . . .	1022
366 Typical SI390 configuration . . . . .	1024
367 Adding a pair . . . . .	1031
368 Update Copy operation . . . . .	1032
369 Normal and quick pair operations . . . . .	1034
370 Reverse and quick restore pair operations. . . . .	1035
371 Quick Restore operation with or without Swap&Freeze option . . . . .	1040
372 Outline of the At-Time Split function . . . . .	1042
373 ShadowImage pair status transitions . . . . .	1044
374 SI390 and TC390: shared S-VOL/M-VOL . . . . .	1053
375 SI390 and TC390: shared S-VOL/R-VOL . . . . .	1054
376 SI390 and TC390: shared S-VOL/M-VOL and S-VOL/R-VOL . . . . .	1054
377 SI390 and TC390: shared T-VOL/M-VOL . . . . .	1055
378 ShadowImage main screen . . . . .	1056
379 Volume List box . . . . .	1059
380 Detail window . . . . .	1062
381 Detail Filter window . . . . .	1063
382 Preset Volume List box displaying settings (operations) . . . . .	1064
383 Set Reserve Attribute window . . . . .	1066
384 Reset Reserve Attribute window (unreserve) . . . . .	1068
385 Add Pair Dialog window . . . . .	1070
386 Split Volume Pair window. . . . .	1074
387 Resynchronize Volume Pair window . . . . .	1079
388 Suspend Volume Pair window. . . . .	1082

389 Delete Volume Pair window . . . . .	1084
390 History screen . . . . .	1086
391 Options screen . . . . .	1088
392 CTG screen . . . . .	1089
393 CTG List Box . . . . .	1090
394 CT Group Status window . . . . .	1092
395 ShadowImage - FlashCopy pair status transition . . . . .	1119
396 Possible combination of ShadowImage - FlashCopy and SI390 pairs . . . . .	1121
397 ShadowImage - FlashCopy and TC390: shared T-VOL and M-VOL/R-VOL (not allowed) 1123	
398 Copying All Datasets Using DFSMSdss Command . . . . .	1125
399 Copying Specified Dataset Using TSO (FCESTABL) Command with EXTENTS Parameter . . . . .	1129
400 Static HPAV . . . . .	1140
401 Dynamic HPAV . . . . .	1141
402 HPAV screen . . . . .	1148
403 Assigning aliases . . . . .	1152
404 Confirming new aliases . . . . .	1153
405 Canceling aliases . . . . .	1154
406 Security example 1 . . . . .	1185
407 Security example 2 . . . . .	1187
408 Security example 3 . . . . .	1188
409 SANtinel screen . . . . .	1192
410 Add/Change Host Group window . . . . .	1197
411 Add/Change Host window . . . . .	1199
412 Select Port window . . . . .	1200
413 Add/Change LDEV Group window . . . . .	1202
414 Select LDEV window . . . . .	1203
415 Add/Change Security Group window . . . . .	1204
416 Specify Security Group window . . . . .	1205
417 Add/Change Security Group window . . . . .	1207
418 Specify Security Group window . . . . .	1208
419 Add/Change Security Group window . . . . .	1209
420 Add/Change Security Group window . . . . .	1211
421 Add/Change Security Group window . . . . .	1213
422 Add/Change Host window . . . . .	1215
423 Add/Change Host window . . . . .	1217
424 Select Port window . . . . .	1218

425 Add/Change Host Group window . . . . .	1219
426 Select LDEV window . . . . .	1221
427 Add/Change LDEV Group window . . . . .	1222
428 Security Group to LDEV window . . . . .	1225
429 Host to Security Group window . . . . .	1226
430 Host Group to Port window . . . . .	1227
431 Host to LDEV window . . . . .	1228
432 LDEV to Security Group window . . . . .	1230
433 LDEV to Host window . . . . .	1231
434 Host Group to Security Group window . . . . .	1232
435 LDEV Group to Security Group window . . . . .	1233
436 Error Detail window . . . . .	1234
437 Example of a pattern . . . . .	1238
438 Example of using pattern files . . . . .	1240
439 LDEV Guard screen . . . . .	1243
440 LDEV Guard Error window . . . . .	1245
441 Enter Pattern Name window . . . . .	1248
442 Download/Upload Pattern File window (Download tab) . . . . .	1251
443 Download/Upload Pattern File window (Upload tab) . . . . .	1252
444 VTOC Area window . . . . .	1254
445 DBE overview . . . . .	1255
446 DBE screen . . . . .	1257
447 Detail window . . . . .	1263
448 Construct Port Group window (adding ports) . . . . .	1265
449 Construct Port Group window (moving ports) . . . . .	1268
450 Set Timeout window . . . . .	1270

## Tables

1 Document Conventions . . . . .	39
2 Information for configuring SNMP notifications ( <i>NetCitizen2.mib</i> ) . . . . .	101
3 LUN size limitations for OPEN-3, OPEN-8, and OPEN-9 (XP48/XP256/XP512) . . . . .	152
4 LUN size limitations for OPEN-3 VSC, OPEN-8 VSC, and OPEN-9 VSC (XP48/XP256/XP512) . . . . .	152
5 Host modes (fast-wide and Fibre Channel support for the XP48/XP256/XP512) . . . . .	160
6 Host modes (ultra SCSI support for the XP256 only) . . . . .	160
7 VSC specifications (XP48/XP256/XP512) . . . . .	171
8 Volume types, logical blocks, and capacities (XP48/XP256/XP512) . . . . .	171
9 LUN Management operation restrictions (XP48/XP256/XP512) . . . . .	186

10	VSC and LUSE operation restrictions (XP48/XP256/XP512) . . . . .	187
11	Port operation restrictions (XP48/XP256/XP512) . . . . .	187
12	Host modes for host operating systems (XP128/XP1024) . . . . .	195
13	AL-PA and Loop IDs (XP128/XP1024) . . . . .	199
14	Fibre Channel port icons for LUN Management operations . . . . .	205
15	NAS port icons for LUN Management operations . . . . .	206
16	LUN icons for LUN Management operations . . . . .	207
17	LDEV icons for LUN Management operations . . . . .	208
18	Channel adapter package icons for Port operations . . . . .	240
19	LUN Management operation restrictions (XP128/XP1024) . . . . .	250
20	Port operation restrictions (XP128/XP1024) . . . . .	252
21	Creating VSC Volumes by Install CV (for OPEN-V) . . . . .	277
22	VSC supported emulations . . . . .	278
23	Install Custom Volume operation parameters for mainframe and open system volumes . . . . .	278
24	Capacities of open system custom volume sizes . . . . .	279
25	Settings for the Make Volume operation (OPEN-V only) . . . . .	280
26	LDEV status icons for LUSE operations . . . . .	284
27	LDEV status icons for VSC operations . . . . .	296
28	VSC and LUSE operation restrictions (XP128/XP1024) . . . . .	322
29	LUN Security Extension icons . . . . .	328
30	Requirements and rules for the spreadsheet file . . . . .	347
31	Components of the spreadsheet declaration line . . . . .	348
32	Format of LUN Manager spreadsheet . . . . .	354
33	Available values of configuration definitions for the [Port] tag . . . . .	355
34	Status of security switch and restriction on setting operation . . . . .	356
35	Available values of configuration definitions for the [Cha] tag . . . . .	357
36	Available values of configuration definitions for the [HostGroup] tag . . . . .	358
37	Available values of configuration definitions for the [WWN] tag . . . . .	359
38	Available values of configuration definitions for the [LUN] tag . . . . .	359
39	Available values of configuration definitions for the [LDEV] tag . . . . .	360
40	Cache LUN supported emulation types and parameters (XP48/XP256/XP512) . . . . .	373
41	Cache LUN icons (XP128/XP1024) . . . . .	391
42	Default migration parameters and values (XP48/XP512) . . . . .	424
43	Non-cascaded volumes that can be used as source volumes (XP128/XP1024) . . . . .	442
44	Cascaded volumes that can be used as source volumes (XP128/XP1024) . . . . .	443
45	Auto LUN - Port-LUN tab icons (XP128/XP1024) . . . . .	449
46	Auto LUN - Physical tab icons (XP128/XP1024) . . . . .	450

---

47	Migration log messages (XP128/XP1024) . . . . .	488
48	BC operational requirements . . . . .	495
49	Number of Pairs That Can Be Created With Volumes of Each Emulation Type and Capacity . . . . .	498
50	BC pairresync parameter requirements . . . . .	506
51	BC options types and requirements . . . . .	509
52	Relationship between L1 pair status and L2 pair operations . . . . .	513
53	Relationship between L2 pair status and L1 pair operations . . . . .	514
54	Read/write operation (host to the node volume) and L1/L2 pair status . . . . .	514
55	Read/write operation (host to the leaf volume) and L2 pair status . . . . .	515
56	BC pair status conditions . . . . .	519
57	Identifying the volumes for BC operations . . . . .	523
58	Status icons for BC . . . . .	528
59	BC operations pop-up menu commands . . . . .	532
60	BC pair activity codes, messages, and descriptions . . . . .	557
61	BC error codes . . . . .	560
62	CA supported RAID level configurations . . . . .	573
63	Sidefile threshold values for CA Asynchronous operations and write pending operations. 585	
64	CA Asynchronous pair status descriptions . . . . .	589
65	CA split types (PSUS) . . . . .	592
66	Consistency status descriptions for split/suspended CA Async S-VOLs . . . . .	593
67	CA suspend types . . . . .	595
68	CA Asynchronous suspension conditions . . . . .	596
69	Host pair status reporting for CA, BC, and CA/BC shared volumes . . . . .	614
70	Data Currency of a shared CA/BC volume . . . . .	614
71	CA functions . . . . .	618
72	Volume icons for CA operations . . . . .	622
73	Status icons for CA operations . . . . .	622
74	Logical path status . . . . .	642
75	Remote copy I/O statistics . . . . .	675
76	Disk array performance conditions and recommendations . . . . .	678
77	Fence level settings on a CA Sync P-VOL . . . . .	713
78	Determining CA Synchronous S-VOL currency based on its pair status and P-VOL fence level setting . . . . .	718
79	Determining CA Async S-VOL consistency based on its pair status and consistency status 719	
80	HXRC path configuration with FICON . . . . .	728

---

81	XP128/XP1024 modes for TrueCopy (and HXRC).....	733
82	TC390 configuration with FICON.....	739
83	Operation of the unit of data stored in bitmap.....	747
84	Maximum number of pairs possible for the basic LU type.....	747
85	Sidefile thresholds.....	752
86	Differences between TC390A dummy pair mode and HPAV.....	755
87	TrueCopy volume pair status.....	761
88	Suspend types.....	764
89	Consistency status for suspended TrueCopy Async R-VOLs.....	765
90	TrueCopy Asynchronous suspension conditions.....	766
91	Requirements and restrictions for combining TrueCopy and HXRC.....	793
92	Host pair status reporting for TrueCopy/ShadowImage shared volumes.....	794
93	Data currency of a shared TrueCopy/ShadowImage volume.....	794
94	TC390 functions.....	799
95	Logical path status.....	830
96	I/O statistics.....	865
97	Optimizing TrueCopy operations and XP128/XP1024 performance.....	869
98	Fence level setting on a TrueCopy M-VOL.....	914
99	Analyzing the currency of TrueCopy Synchronous R-VOLs.....	919
100	Analyzing the consistency of TrueCopy Asynchronous R-VOLs.....	921
101	Selecting the correct timer type for TrueCopy Async disaster recovery.....	923
102	General TrueCopy troubleshooting.....	925
103	Troubleshooting RCU path status problems.....	926
104	Troubleshooting suspended TrueCopy pairs.....	929
105	Resolving TrueCopy Asynchronous suspension conditions.....	931
106	TrueCopy operations versus PPRC TSO and ICKDSF commands.....	935
107	Typographic conventions for PPRC TSO commands.....	938
108	CESTPATH LINK parameter for serial and Fibre Channel.....	940
109	SAID values for the CESTPATH LINK parameter.....	941
110	Using CESTPAIR to establish and resume TrueCopy Async pairs.....	942
111	Using CSUSPEND to suspend TrueCopy Async pairs.....	944
112	Using CDELPAIR to delete TrueCopy Async pairs/groups at the MCU.....	945
113	Using CRECOVER to delete TrueCopy Async pairs/groups at the RCU.....	947
114	CQUERY output for serial and Fibre Channel.....	950
115	TrueCopy pair status during CGROUP (FREEZE/RUN) operations.....	955
116	XP128/XP1024 response characteristics to failure conditions.....	963
117	GDPS-TC390-HXRC matrix.....	967
118	TrueCopy control unit SIMs.....	974

---

119 TrueCopy device SIMs	975
120 Functional macro commands for TrueCopy scripting	980
121 Internal macro commands for TrueCopy scripting	981
122 Syntax description	982
123 Script components	982
124 Script file requirements	983
125 Script symbols	983
126 Example of CreateHrcPair parameters	986
127 Select device parameters	994
128 Internal macro commands	995
129 ASCII character codes	997
130 If/EndIf comparison symbols	997
131 MakeString expression definitions	998
132 Work variables	1000
133 Reserved result variables	1001
134 Reserved status variables	1002
135 Syntax requirements for optional parameters	1004
136 Error messages	1008
137 TrueCopy scripting error codes	1009
138 ShadowImage requirements	1026
139 Number of Pairs That Can Be Created With Volumes of Each Emulation Type and Capacity	1028
140 Reverse and quick restore Pairresync requirements	1036
141 Types of ShadowImage options	1039
142 Pair status versus allowable operations	1045
143 ShadowImage pair status	1045
144 Sample table for ShadowImage configuration information	1050
145 Host pair status reporting for SI390/TC390 shared volumes	1052
146 Currency of a shared SI390 and TC390 volume	1053
147 Displayed information in progress	1060
148 List of ShadowImage pop-up menu commands	1061
149 ShadowImage status and history reference codes and messages	1086
150 List of pop-up menu commands for CTG operation	1091
151 PPRC commands	1094
152 TSO command parameters	1095
153 ICKDSF command parameters	1100
154 Restrictions for PPRC commands	1103
155 Accepting PPRC commands	1104

156 PSF command operability for ShadowImage volumes . . . . .	1105
157 PSF and DEVSERV results for ShadowImage volumes . . . . .	1105
158 Pair status reported by the host for volumes in multiple pairs . . . . .	1109
159 Path status displayed by the CQUERY TSO and PPRCOPY QUERY DSF commands . . . . .	1110
160 QUIESCE parameter requirements for ShadowImage . . . . .	1111
161 Parameters of ATSPLIT command . . . . .	1114
162 Description of the ATQUERY command examples . . . . .	1116
163 Requirements for ShadowImage - FlashCopy . . . . .	1118
164 ShadowImage - FlashCopy pair status condition . . . . .	1120
165 Pair Status versus allowable operations. . . . .	1120
166 Relationship between L1 pair status and L2 pair operations. . . . .	1122
167 Relationship between L2 pair status and L1 pair operations. . . . .	1122
168 ShadowImage - FlashCopy and TC390 shared volume . . . . .	1123
169 ShadowImage - FlashCopy and XRC shared volume . . . . .	1124
170 PPRC TSO commands. . . . .	1127
171 PPRC TSO command parameters . . . . .	1128
172 Status displayed by FCQUERY command . . . . .	1130
173 General ShadowImage troubleshooting . . . . .	1132
174 HCD settings for static and dynamic HPAV . . . . .	1139
175 Requirements and restrictions for HPAV . . . . .	1141
176 Ratio of base devices to alias devices . . . . .	1143
177 Security group icons for SANTinel operations. . . . .	1193
178 Add/Change Host window icons . . . . .	1198
179 Supported volume emulation types . . . . .	1237
180 LDEV Guard icons . . . . .	1244
181 Fibre Channel port icons for DBE operations . . . . .	1258
182 RCU path status troubleshooting. . . . .	1283
183 Suspended CA pairs troubleshooting. . . . .	1285
184 CA Async Suspension Conditions. . . . .	1287





## about this guide

This user guide provides information to help you:

- Use the administration features to manage:
  - User profiles and disks array sessions.
  - Applications installed on the Command View management station.
  - Disk arrays added to Command View.
- View recent disk array events and error conditions.
- Display identity and status information about a disk array.
- Access additional help and support information.
- Manage the HP StorageWorks XP Disk Array XP48, XP128, XP256, XP512, and XP1024.

“About this Guide” topics include:

- [Overview](#), page 38
- [Conventions](#), page 39
- [Getting Help](#), page 41

## Overview

This section covers the following topics:

- [Intended Audience](#)
- [Prerequisites](#)
- [Related Documentation](#)

## Intended Audience

This book is intended for use by customers and HP authorized service providers who are experienced with the following:

- Disk array hardware and software
- Storage systems

## Prerequisites

Before you use Command View, make sure you consider the items below.

- Install or upgrade to the most recent version of Command View XP.
- Set up the HP StorageWorks XP disk arrays.
- Install Path Connectivity.
- Refer to the *readme.txt* file on the CD for any last minute announcements.

## Related Documentation

In addition to this guide, HP provides corresponding information:

- *HP StorageWorks Command View XP Installation Guide*
- *HP StorageWorks Command View XP Path Connectivity User Guide*
- *HP StorageWorks Command View XP Path Connectivity Command Line Interface (CLI) Reference Guide*
- *HP StorageWorks Command View XP Command Line Interface (CLI) Reference Guide*
- Command View XP and Path Connectivity online help

## Conventions

Conventions consist of the following:

- [Document Conventions](#)
- [Text Symbols](#)

## Document Conventions

The document conventions included in [Table 1](#) apply in most cases.

**Table 1: Document Conventions**

Element	Convention
Cross-reference links	Blue text: <a href="#">Figure 1</a>
Key and field names, menu items, buttons, and dialog box titles	<b>Bold</b>
File names, application names, and text emphasis	<i>Italics</i>
User input, command and directory names, and system responses (output and messages)	Monospace font COMMAND NAMES are uppercase monospace font unless they are case sensitive
Variables	<monospace, italic font>
Website addresses	Blue, underlined sans serif font text: <a href="http://www.hp.com">http://www.hp.com</a>

## Text Symbols

The following symbols may be found in the text of this guide. They have the following meanings.



**WARNING:** Text set off in this manner indicates that failure to follow directions in the warning could result in bodily harm or death.



**Caution:** Text set off in this manner indicates that failure to follow directions could result in damage to equipment or data.

---

**Note:** Text set off in this manner presents commentary, sidelights, or interesting points of information.

---

## Getting Help

If you still have a question after reading this guide, contact an HP authorized service provider or access our website: <http://www.hp.com>.

## HP Technical Support

Telephone numbers for worldwide technical support are listed on the following HP website: <http://www.hp.com/support/>. From this website, select the country of origin.

---

**Note:** For continuous quality improvement, calls may be recorded or monitored.

---

Be sure to have the following information available before calling:

- Technical support registration number (if applicable)
- Product serial numbers
- Product model names and numbers
- Applicable error messages
- Operating system type and revision level
- Detailed, specific questions

## HP Storage Website

The HP website has the latest information on this product, as well as the latest drivers. Access storage at: <http://www.hp.com/country/us/eng/prodserv/storage.html>. From this website, select the appropriate product or solution.

## HP Authorized Reseller

For the name of your nearest HP authorized reseller:

- In the United States, call 1-800-345-1518
- In Canada, call 1-800-263-5868
- Elsewhere, see the HP website for locations and telephone numbers: <http://www.hp.com>.



# Getting Started

## 1

HP StorageWorks Command View XP is a Web-based storage management platform that monitors and configures the HP StorageWorks Disk Array XP family of products. HP StorageWorks Path Connectivity XP is a component included with Command View. You can access Command View from remote locations using the Internet and a Web browser.

Command View is part of a total Storage Area Network (SAN) solution and runs on a Windows-based workstation, which is referred to as the Command View management station. Disk array control from the management station is accomplished over the corporate LAN.

As stated, Command View is a Web-based application, so you can use a Web browser to manage the disk arrays from any location worldwide.

## Host Agents

If you are using Path Connectivity, you have the option to install small portions of the Command View software on host systems in the SAN that consume disk storage space. The distributed software components are called host agents.

Command View host agents use the network to send statistics about disk array consumption to the Command View management station. Because of this, Command View can provide reports that describe disk consumption per host system. You can access this information through Command View's **Path Connectivity** tab.

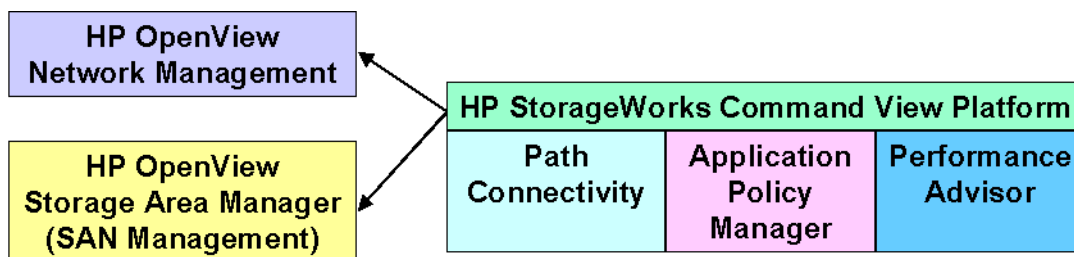
Command View host agents run on the following host operating systems:

- Windows Server 2003 (32-bit)
- Windows 2000 (Service Pack 4)
- Windows NT 4.0 (Service Pack 6a)
- HP-UX 11.00, 11.11, and 11.23 (32 and 64-bit)
- Solaris 8 or 9
- Red Hat Linux 7.1, kernel 2.4.2 (32-bit)

- Red Hat Linux AS 2.1, kernel 2.4.9 (32-bit)
- UnitedLinux 1.0, kernel 2.4.19 (32-bit)
- SuSE Linux Enterprise Server 8 (SLES8), kernel 2.4.19 (32-bit)
- IBM AIX 4.3.3 or 5.1

## Integration with Other Applications

Command View can be integrated with any management platform that supports Web applications. For example, Command View integrates with the HP OpenView Network Management platform and the HP OpenView Storage Area Manager platform.



**Figure 1: Command View integrated with other management platforms and application modules**

You can also integrate optional “snap-in” application modules. As shown in the previous figure, HP StorageWorks Application Policy Manager and HP StorageWorks Performance Advisor XP are integrated with Command View. HP StorageWorks Path Connectivity XP is a component included with Command View.



## Features

- **User, device, and session administration:** Controls access to the Command View management station and the disk arrays.
- **Event management and history:** Archives and distributes traps to configured storage area network (SAN) management stations. Trap messages are converted into readable error messages and are stored in log files for viewing.
- **Disk array status monitoring:** Monitors every aspect of disk array operation.
- **Path Connectivity:** Monitors and reports the connection paths between the disk array and hosts consuming disk space. Diagnoses the “health” of connections. Path Connectivity is included with the Command View application.
- **LUN configuration:** Provides LUN configuration and management. Requires the purchase and installation of HP StorageWorks LUN Configuration Manager XP (XP48/XP256/XP512) or HP StorageWorks LUN Configuration and Security Manager XP - LUN Manager (XP128/XP1024).
- **Disk array security at the disk array controller and LUN level:** Used to manage disk array security at the disk array controller level and the port/LUN level. Requires the purchase and installation of HP StorageWorks Secure Manager XP (XP48/XP256/XP512) or HP StorageWorks LUN Configuration and Security Manager XP - Volume Manager (XP128/XP1024).
- **Advanced LUN management (XP128/XP1024 only):** Protects data in your disk arrays from I/O operations performed on open system hosts. Requires the purchase and installation of HP StorageWorks LUN Security XP Extension.
- **Configuration File Loader (XP128/XP1024 only):** Sets the disk arrays to have the same configuration by applying a configuration definition file that can be edited. Is available preloaded from the factory, and requires the purchase and installation of HP StorageWorks LUN Configuration and Security Manager XP to manage LUN configuration files.
- **Cache LUN configuration:** Manages the placing of data from LUNs into cache memory to improve data access speeds. Requires the purchase and installation of HP StorageWorks Cache LUN XP.
- **Auto LUN configuration:** Manages and optimizes the disk array’s storage by performing manual and automatic migration operations. Requires the purchase and installation of HP StorageWorks Auto LUN XP.

- **Business Copy (XP128/XP1024 only):** Maintains internal copies of user data on the disk array for purposes such as data backup or duplication. Business Copy is used for open system data. Requires the purchase and installation of HP StorageWorks Business Copy XP.
- **ShadowImage and ShadowImage - FlashCopy (XP128/XP1024 and mainframe systems only):** ShadowImage is comparable to Business Copy, but is used for mainframe data. Requires the purchase and installation of HP StorageWorks ShadowImage XP. ShadowImage - FlashCopy requires the purchase and installation of both ShadowImage XP and FlashCopy Extension.
- **Continuous Access and Continuous Access Extension (XP128/XP1024 only):** Creates and maintains duplicate copies of user data from a local disk array on a remote disk array. These copies are useful for data duplication, backup, and disaster recovery. Continuous Access is used for open system data. Requires the purchase and installation of HP StorageWorks Continuous Access XP and XP Extension.
- **TrueCopy and TrueCopy Asynchronous (XP128/XP1024 and mainframe systems only):** TrueCopy is comparable to Continuous Access, but is used for mainframe data. Requires the purchase and installation of HP StorageWorks TrueCopy XP and True Copy XP Asynchronous.
- **HPAV (XP128/XP1024 and mainframe systems only):** Allows a mainframe host system to issue multiple I/O requests in parallel to logical devices on the disk array. When HPAV is used, the mainframe host has substantially faster access to the data stored in the disk array. Requires the purchase and installation of HP StorageWorks HPAV XP.
- **LDEV Guard (XP128/XP1024 and mainframe systems only):** Protects data in your disk arrays from I/O operations performed on mainframe hosts. Requires the purchase and installation of HP StorageWorks LDEV Guard XP.
- **SANtinel and SANtinel Port Security Option (XP128/XP1024 and mainframe systems only):** Used to apply security to logical volumes to prevent specified mainframe hosts from reading and writing to the specified logical volumes. The Port Security Option provides port-level security. Requires the purchase and installation of HP StorageWorks SANtinel. SANtinel Port Security Option requires the purchase and installation of both SANtinel and SANtinel Port Security Option.
- **Direct Backup Engine (XP128/XP1024 only):** Combined with a backup application installed on a host server, provides server-free backup between the disk array and the backup devices connected to the host server. Requires the purchase and installation of HP StorageWorks Direct Backup Engine XP.

## Communicating with the Disk Arrays

The Command View platform uses the RMI and SNMP protocols to communicate with the disk arrays and host agents.

SNMP operation varies slightly when working with different members of the XP disk array family.

### **XP128/XP1024**

Communication with the disk array is through the RMI interface. The RMI server resides on the disk array's Service Processor (SVP).

### **XP48/XP512**

Communication with the disk array is through FTP/SNMP. The SNMP agent resides on the disk array. The disk array sends SNMP traps to the Command View management station. The license key for the SNMP agent must be installed on the disk array.

### **XP256**

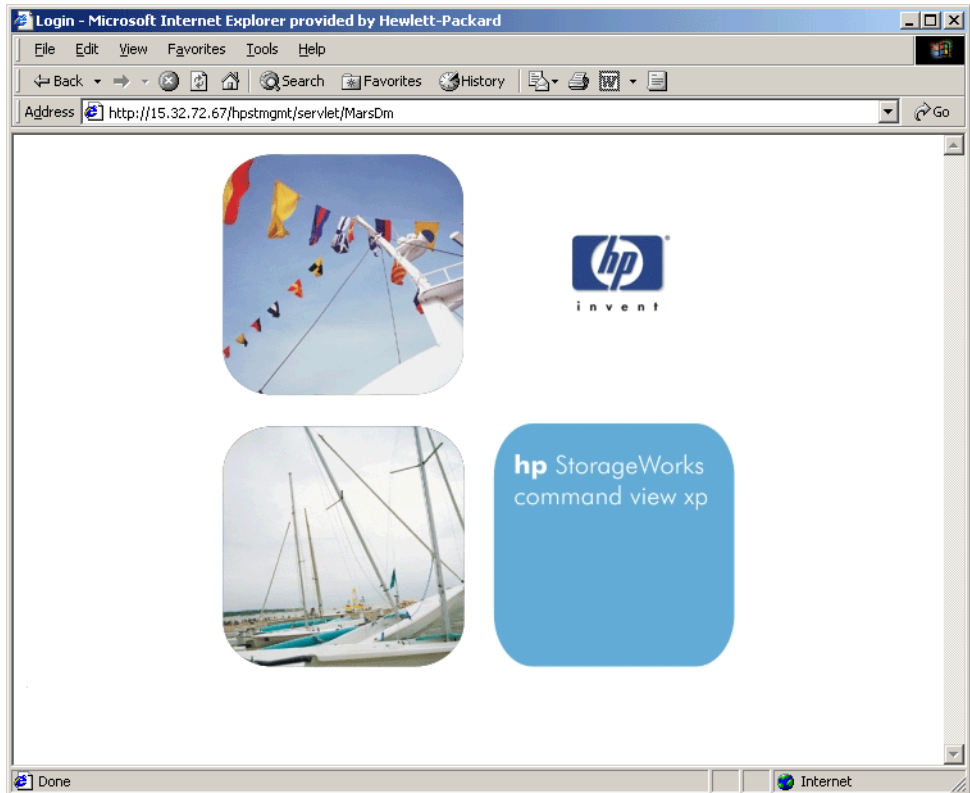
Communication with the disk array is through SNMP. The SNMP agent for the XP256 resides on the remote console PC running the Remote Control XP software. Command View communicates with the SNMP agent.

The XP256 sends Remote Service Information Messages (R-SIMs) to the remote console PC. If the Trap Distributor utility is installed on the remote console PC, R-SIM notifications are converted into SNMP traps and sent to the Command View management station.

## Starting Command View from a Browser

### To start and log in to Command View:

1. Start the browser and enter the Command View management station's host name or IP address as the URL. The Command View initial screen is displayed.



**Figure 2: Command View initial screen**

The initial screen is immediately overlaid by the Login dialog box.



**Figure 3: Login dialog box**

2. Enter the user name and password, and then click **OK**.
3. After the user name and password have been verified, the Overview (or Launch) screen is displayed (see [Figure 4](#)).

## Default User Names and Passwords

When you start Command View for the first time, log in using one of the default user names (“user” or “administrator”). Use the User Administration functions to add new users and set their access privileges. After setting up the users, you may want to change the passwords for the default user names.

### Default Administrator

User name: administrator

Password: administrator

This login provides both modify and view-only access.

### Default User

User name: user

Password: user

This login provides view-only access. A user with view-only access cannot make configuration changes.

## Starting Command View from Storage Area Manager

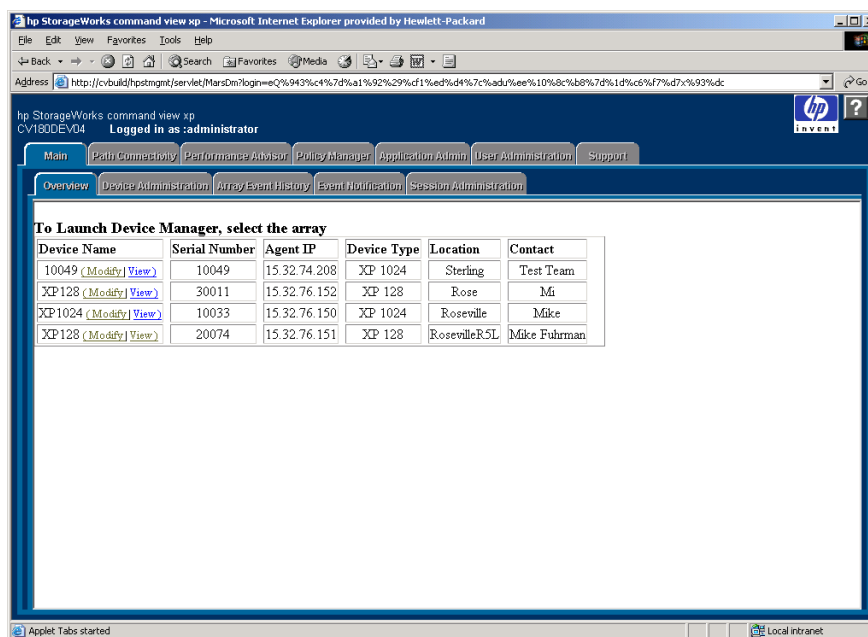
HP OpenView Storage Area Manager discovers Command View and formulates the required disk array management URL for each disk array managed by Command View. Refer to the HP OpenView Storage Area Manager documentation for information about Storage Area Manager operations.

## Main Tab and Overview/Launch Screen

The Overview screen is the first screen that is displayed after logging in. Clicking the Command View tabs and buttons provides access to the Command View functions. The Command View Main and Overview tabs are highlighted when you log in to Command View.

The top-level Command View tabs are for “snap-in” modules and other functions *independent of any one disk array*.

When you click the **Main** tab, the screen displays the **Overview** tab and additional tabs. These functions are *independent of any one disk array*.



**Figure 4: Overview/Launch screen**

The Overview screen is often referred to as the Launch screen. This screen displays a list of disk arrays that Command View is set up to manage (disk arrays that were added using the Device Administration Add Array function).

Clicking the **Modify** or **View** links for a disk array displays that disk array's Identity screen. In addition, the tabs are replaced by new tabs for *array-dependent management functions*. For example, tabs for LUN Management, Auto LUN, Cache LUN, and so forth are displayed. The array-dependent tabs manage the selected disk array only.

## Display

The Overview/Launch screen consists of the following items:

- **Device Name:** The device name is a nickname that identifies a disk array. You can create or change this name using the Device Administration functions.
- **Modify link:** Use Modify mode to make changes to a disk array's configuration. For example, when you are in Modify mode, you can delete a LUN from the disk array.
- **View link:** Use View-only mode to access the disk array without modification permissions. While in View-only mode, you cannot make changes to the disk array.
- **Serial Number:** The serial number of the disk array. It is filled in automatically when you enter the IP address of the disk array in the Add Array operation under Device Administration. For the XP256, this field shows the list of disk arrays that are managed by the remote console.
- **Agent IP:** The disk array's IP address. For the XP256, this is the IP address of the remote console.
- **Device Type:** The disk array's HP product name, such as the XP1024.
- **Location:** This field describe the location of the disk array. You can change this value at any time using the Device Administration screen.
- **Contact:** This field shows the person to be contacted about issues with the disk array. You can change this value at any time using the Device Administration screen.



## Using the Backup Utility

If you want to back up Command View data, settings, and preferences, use the Backup Utility. You can also use this tool to migrate data from an existing management station to a new management station. This tool preserves your data and configuration preferences by saving your existing settings. If needed, you can then restore the backup on an existing management station or on a new management station.

To use the Backup Utility, both management stations must have Command View 1.8 or later installed. This tool is not compatible with older versions of Command View. In addition, the Backup Utility does not save the Windows registry.

### To save or restore your data using the Backup Utility:

1. Click **Start > Programs > HP StorageWorks Command View XP > Backup Utility**. The Backup Utility window is displayed.
2. To save your files:
  - a. Click **Backup**. The Open File dialog box is displayed.
  - b. Choose a location, such as a network drive or shared file system, to save the backup file and click **Open**. A confirmation dialog box is displayed.
  - c. Click **Yes** to proceed. The Backup Progress status window is displayed.
  - d. When the backup process is completed, the **Finished** button becomes available. Click **Finished**. A confirmation message is displayed.
  - e. Click **OK**.
3. To restore your files:
  - a. Click **Restore**. The Open File dialog box is displayed.
  - b. Navigate to where the backup file is located and click **Open**. A confirmation dialog box is displayed.
  - c. Click **Yes** to proceed. The Restore Progress status window is displayed.
  - d. When the restore process is completed, the **Finished** button becomes available. Click **Finished**. A confirmation message is displayed.
  - e. Click **OK**.

**To save or restore your data from the Windows command line:**

- To save your files, enter %HPSS\_HOME%\bin\backup <*target-path*>. The *target-path* is the location, such as a network drive or shared file system, to where you want to save the backup file.
- To restore your files, enter %HPSS\_HOME%\bin\restore <*target-path*>. The *target-path* is the location of the backup file.

# User Administration

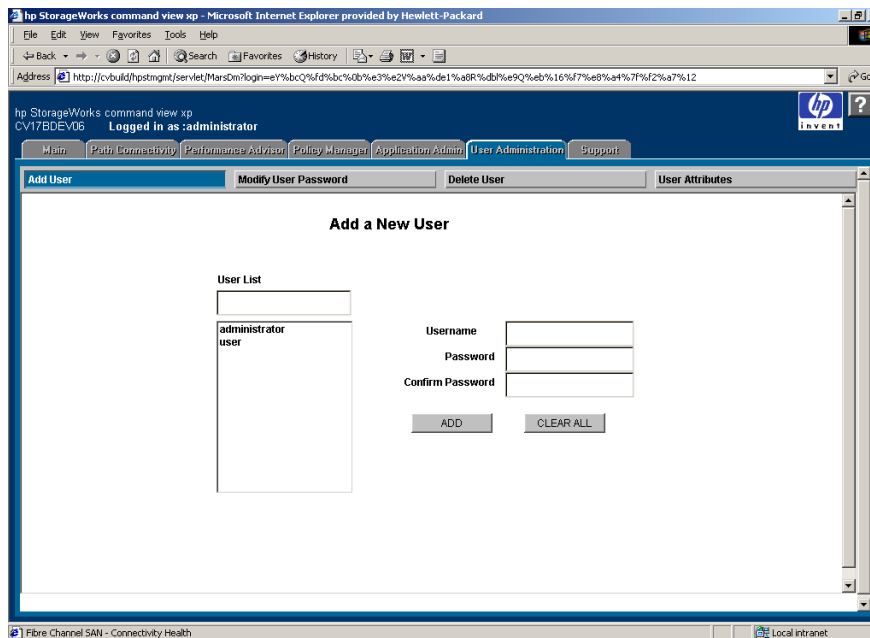
## 2

Use the User Administration functions to:

- View users and their profiles (page 56)
- Add a new user (page 58)
- Modify a user's profile (page 59)
- Change a user's permissions to modify or view-only (page 59)
- Delete a user (page 60)

## Accessing User Administration

To access the User Administration functions, click the **User Administration** tab from the Main screen. The User Administration screen is displayed.



**Figure 5: User Administration screen**

### Display

The User Administration screen has buttons for the following operations:

- **Add User:** Displays the Add a New User screen. This screen is displayed when you first click the **User Administration** tab.
- **Modify User Password:** Displays the Modify User Password screen.
- **Delete User:** Displays the Delete User screen.
- **User Attributes:** Displays the Set User Attributes screen.

## Rules for User Names and Passwords

When you create user accounts and passwords, use the following rules:

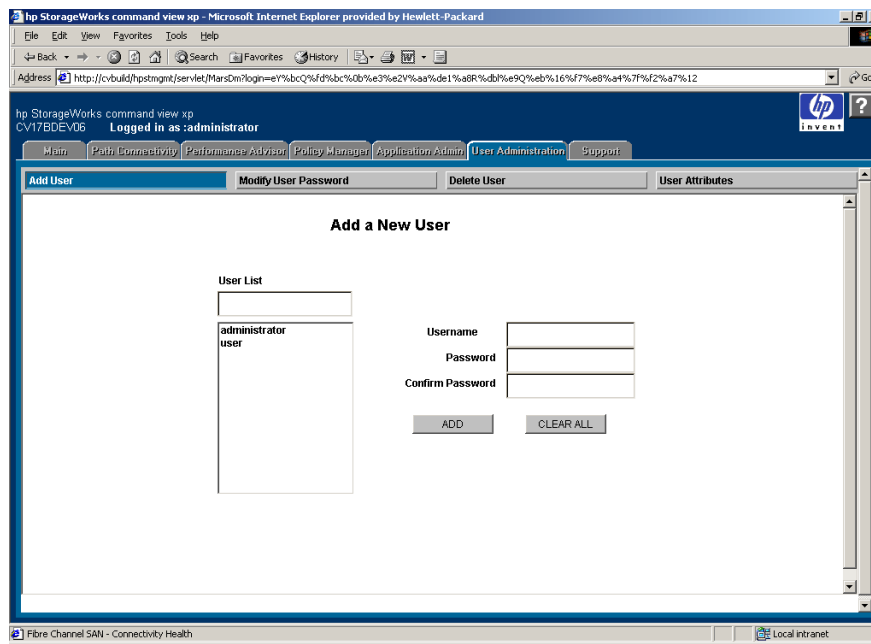
- The user name and password cannot be null (empty).
- The user name must have at least six characters, and cannot have more than 16 characters.
- The password must have at least six characters, and cannot have more than ten characters.
- The user name and password cannot contain any special characters, colons, semicolons, or spaces.
- The new password cannot be the same as the old password.

## Adding a New User

Only the administrator can add users. Other users can only view this screen.

**To add a new user:**

1. From the User Administration page, click **Add User**. The Add User screen is displayed.



**Figure 6: Add a New User screen**

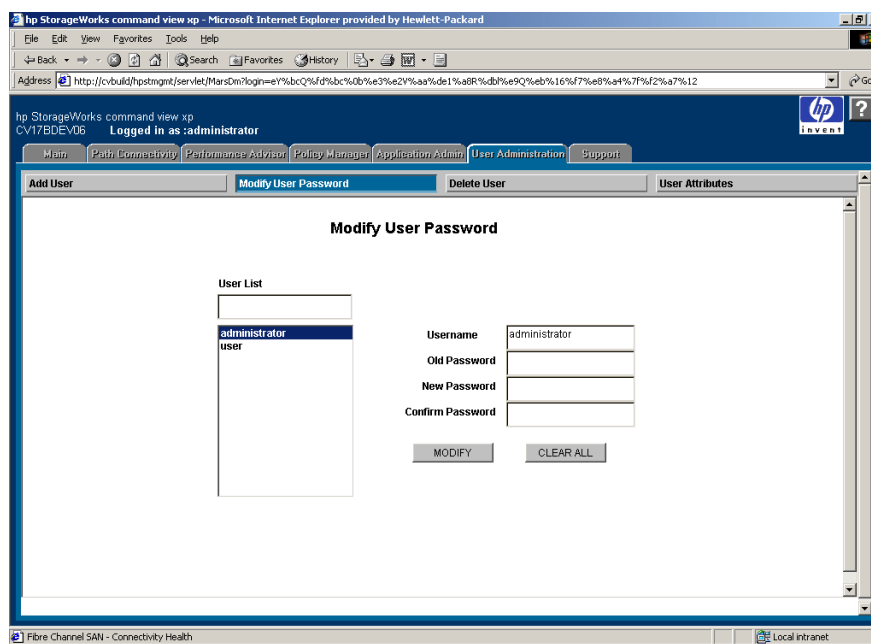
2. In the **Username** field, enter a name.
3. In the **Password** field, enter a password.
4. In the **Confirm Password** field, enter the password again.
5. Click **ADD**. The system creates a new user and immediately displays the user's name in the User List. To clear the text fields, click **CLEAR ALL**.

## Modifying a User's Password

Users can change their own passwords. Only the administrator can modify other users' passwords.

### To modify a user's password:

1. From the User Administration page, click **Modify User Password**. The Modify User Password screen is displayed.



**Figure 7: Modify User Password screen**

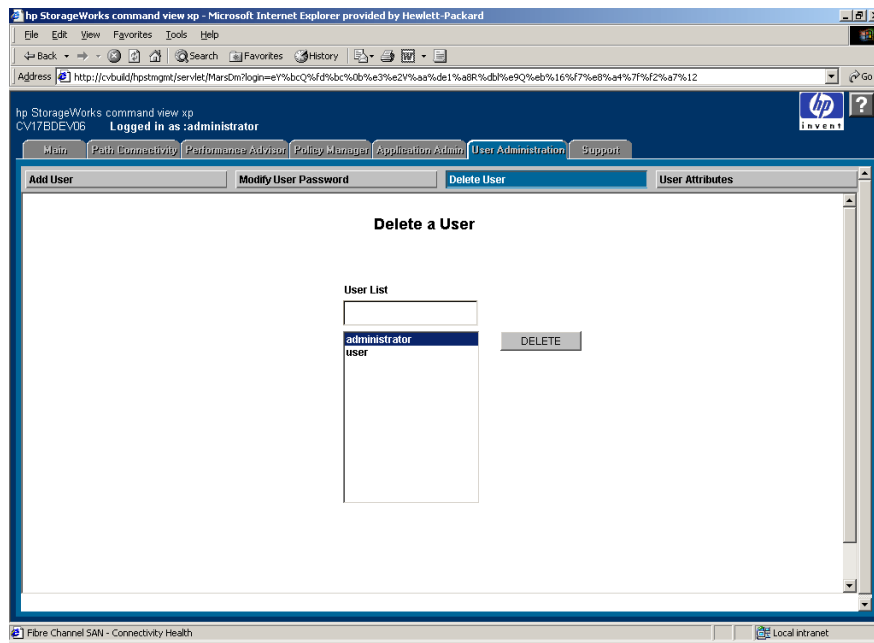
2. In the **User List** text box, click the name of the user whose password you want to change.
3. In the **Old Password** field, enter the old password.
4. In the **New Password** field, enter a new password.
5. In the **Confirm Password** field, enter the new password again.
6. Click **MODIFY**. A confirmation dialog box is displayed.
7. Click **OK**. The system saves the new password. To cancel the process of modifying a user's password and clear all the fields, click **CLEAR ALL**.

## Deleting a User

Only the administrator can delete users. Other users can only view this screen.

### To delete a user:

1. From the User Administration page, click **Delete User**. The Delete a User screen is displayed.



**Figure 8: Delete a User screen**

2. In the **User List** text box, click the name of the user whose account you want to delete.
3. Click **DELETE**. A confirmation dialog box is displayed.
4. Click **OK** to confirm the deletion.

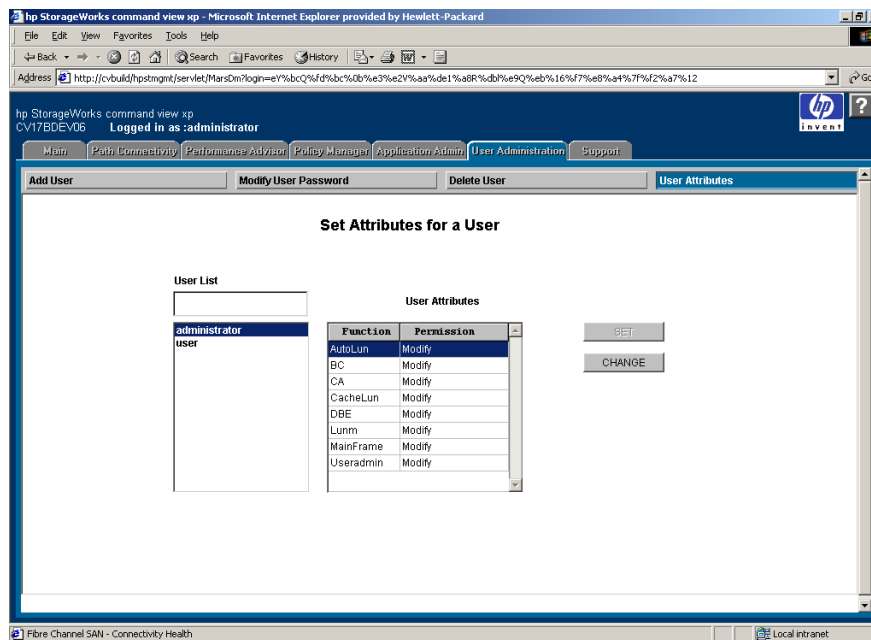


## Setting User Attributes

Only the administrator can set user attributes. Other users can view this screen, but cannot make changes. In addition, the administrator cannot give other users administrative “modify” privileges.

### To set a user’s attributes:

1. From the User Administration page, click **User Attributes**. The Set Attributes for a User screen is displayed.

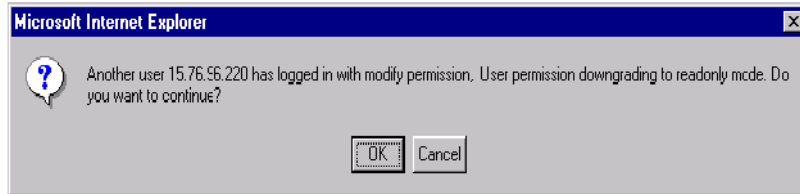


**Figure 9: Set Attributes for a User screen**

2. In the **User List** text box, click the name of the user whose attributes you want to change. The permissions for that user will be displayed.
3. To change a permission, click the function you want to change.
4. Click **CHANGE** to toggle the permission between View and Modify.
5. When you have finished assigning permissions, click **SET**. A confirmation dialog box is displayed.
6. Click **OK**. Command View saves the new attributes for the user.

## Automatic Downgrading of Permissions

If you have modify permission and try to open a session when there is another user accessing the disk array in Modify mode, the following message will be displayed.



**Figure 10: Downgrading Permission message**

More than one simultaneous modify session is not possible Your modify permission will be temporarily downgraded to view-only permission. Click **OK** to continue or **Cancel** to cancel.

# Application Administration



## 3

The Application Administration screen shows you what applications are installed on the Command View management station. You can also use this screen to add related non-Command View applications such as tape.

## Accessing Application Administration

To access Application Administration, click the **Application Admin** tab from the Main screen. The Application Administration screen is displayed.

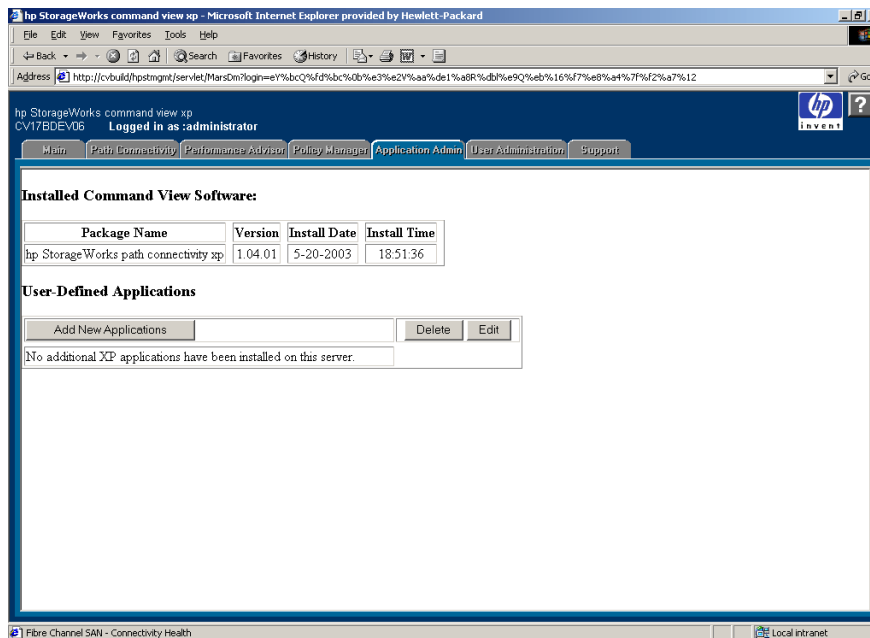


Figure 11: Application Administration screen

## Display

### Installed Command View Software section

This section contains a table with the following columns:

- **Package Name:** Names of applications that are already installed on the Command View management station.
- **Version:** Version number of the installed software package.
- **Install Date:** Date the software package was installed.
- **Install Time:** Time the software package was installed.

**User-Defined Applications section**

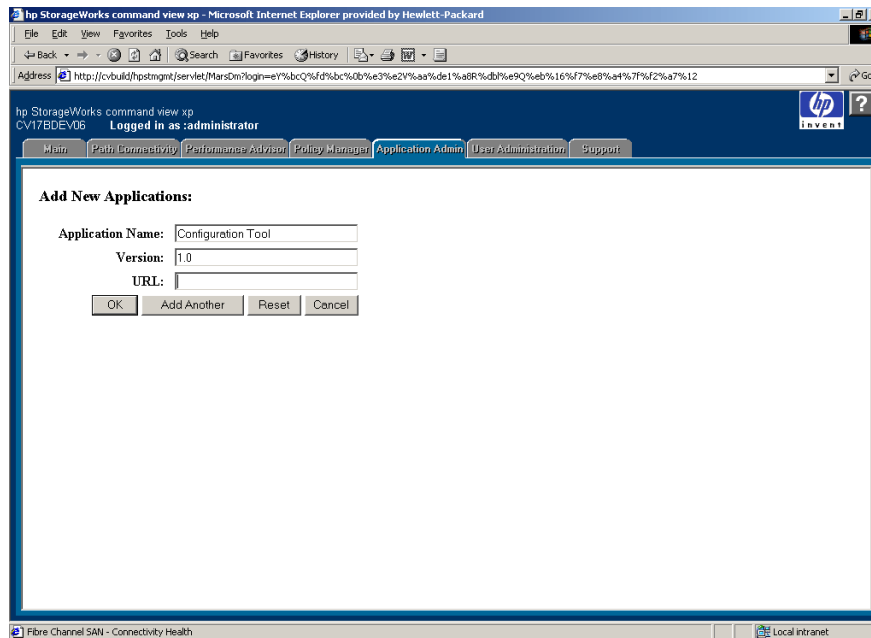
The section lists user-added applications that are installed on the Command View management station. This section contains the following buttons:

- **Add New Applications:** Click **Add New Applications** to add one or more applications.
- **Delete:** Click **Delete** to delete a user-added application.
- **Edit:** Click **Edit** to modify a user-added application.

## Adding Applications

To add a new application:

1. Click **Add New Applications** on the Application Administration screen. The Add New Application screen is displayed.



**Figure 12: Add New Applications screen**

2. Enter the name of the application you want to access.
3. Enter the version number of the application.
4. Enter the URL where the application is located.
5. To add the application and return to the main Application Administration screen, click **OK**. To add another application click **Add Another**.

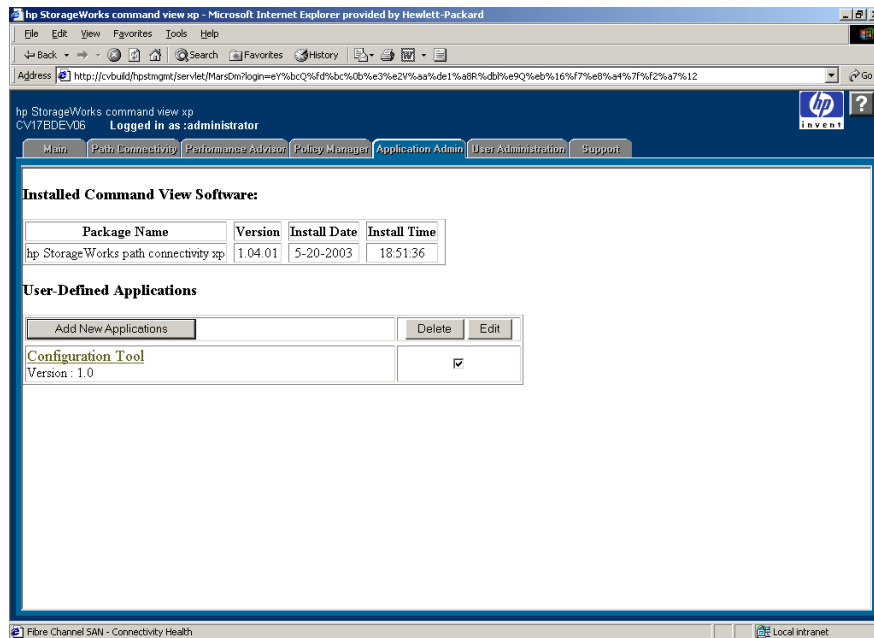
Clicking **Reset** will reset the fields to blanks. Clicking **Cancel** will return you to the main Application Administration screen.

When you return to the main Application Administration screen, the display will confirm that the application has been added.

## Deleting Applications

To delete an application:

1. From the Application Administration screen, select the check box beside the application you want to delete.



**Figure 13: Deleting applications (Application Administration screen)**

2. Click **Delete**. A confirmation dialog box is displayed.
3. Click **OK** to confirm the deletion or click **Cancel** to cancel the operation.

When you return to the main Application Administration screen, the display will confirm that the application has been deleted.

## Editing Application Information

To edit information about an application:

1. Select the check box beside the application you want to edit.
2. Click **Edit**. The Edit Applications screen is displayed.

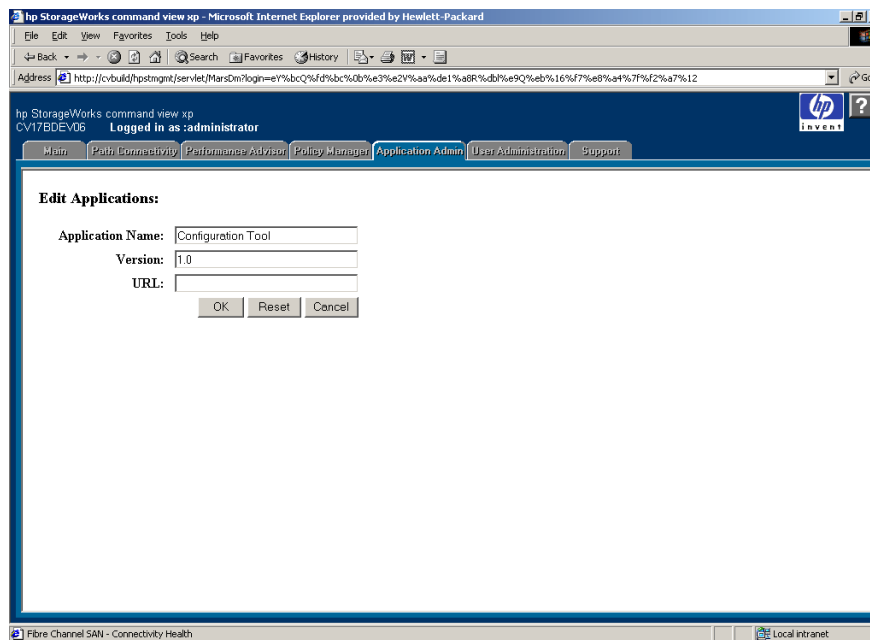


Figure 14: Edit Applications screen

3. Make any changes you want to the application's name or version.
4. Click **OK** to confirm the changes or click **Cancel** to cancel the operation. Clicking **Reset** will remove your changes without canceling the operation.

When you return to the main Application Administration screen, the display will confirm that the application information has been changed.



# Support Screens

## 4

The Support screens provide you with access to help information. You can click the links in the Contents area of the screen to learn more about the following topics:

- Download page for platforms and host agents (see page 70)
- Frequently asked questions (see page 71)
- Reference documents (see page 72)
- Integrating Command View with other products (see page 73)
- Other HP products (see page 74)

## Accessing the Support Screen

When you log on to Command View, the Main screen opens by default. To go to the Support screen, click the **Support** tab from the Main screen.

## Download Page

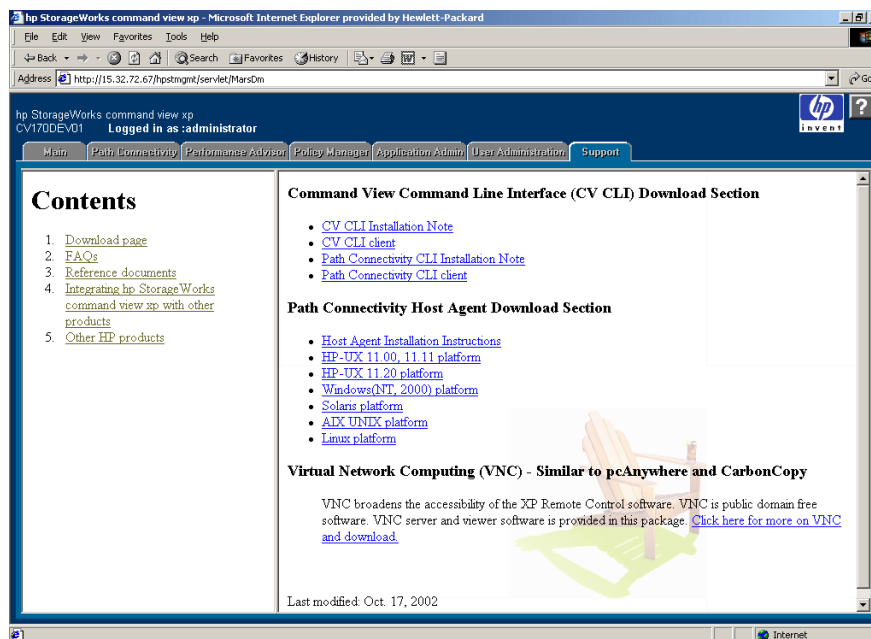
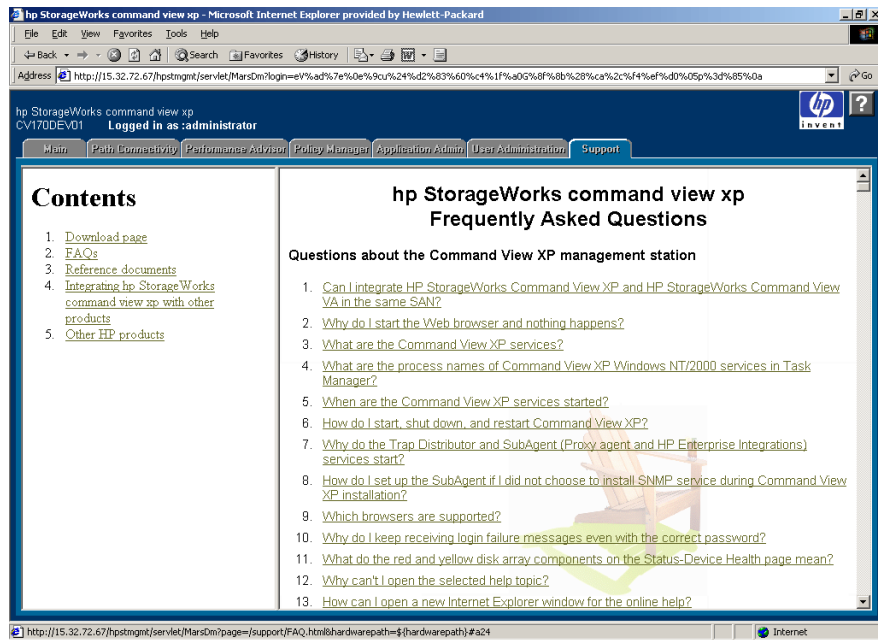


Figure 15: Download page

Clicking the **Support** tab displays the Download page by default. It contains several sections, with links to:

- Command View CLI information and downloads
- Path Connectivity CLI information and downloads
- Path Connectivity Host Agent downloads

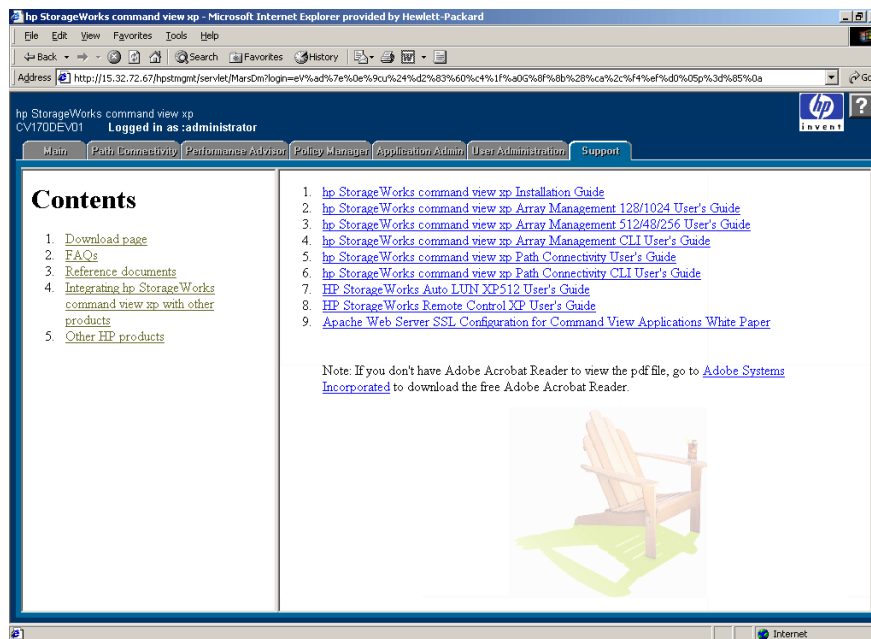
## FAQs



**Figure 16: FAQ page**

The FAQs link displays frequently asked questions and answers. You can refer to the FAQs for additional information about Command View operations.

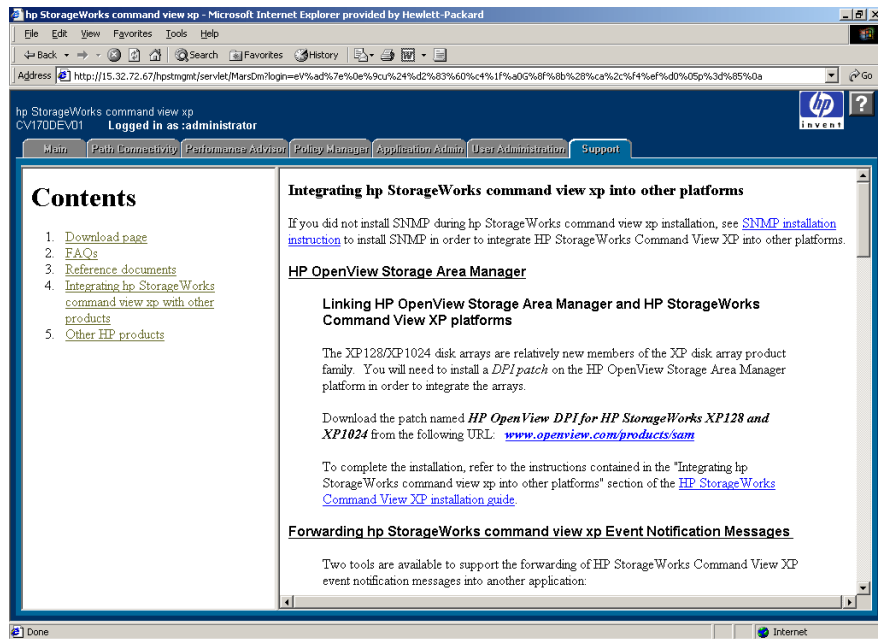
## Reference Documents



**Figure 17: Reference Documents page**

The Reference Documents link provides access to other documents. You can refer to these documents to get background information and to learn more about this product and how best to use it.

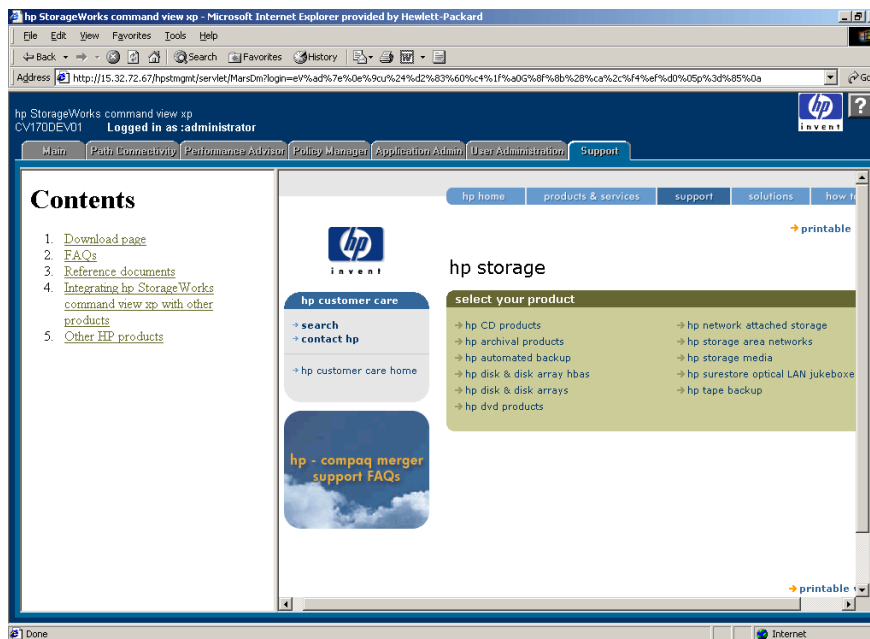
## Integrating Command View with Other Products



**Figure 18: Integrating Command View with Other Platforms page**

Use the integration page to learn about integrating Command View with HP OpenView Storage Area Manager and other products.

## Other HP Products



**Figure 19: HP Customer Care Web page**

Use the Other HP Products link to access the HP Customer Care Web pages. Customer Care provides you with links to information about HP products and services.

# Device Administration

## 5

Use the Device Administration functions to:

- Add a disk array (page 78)
- Delete a disk array (page 79)
- Modify disk array parameters (page 80)
- Set SNMP IP security (page 82)
- Manage license keys (page 85)

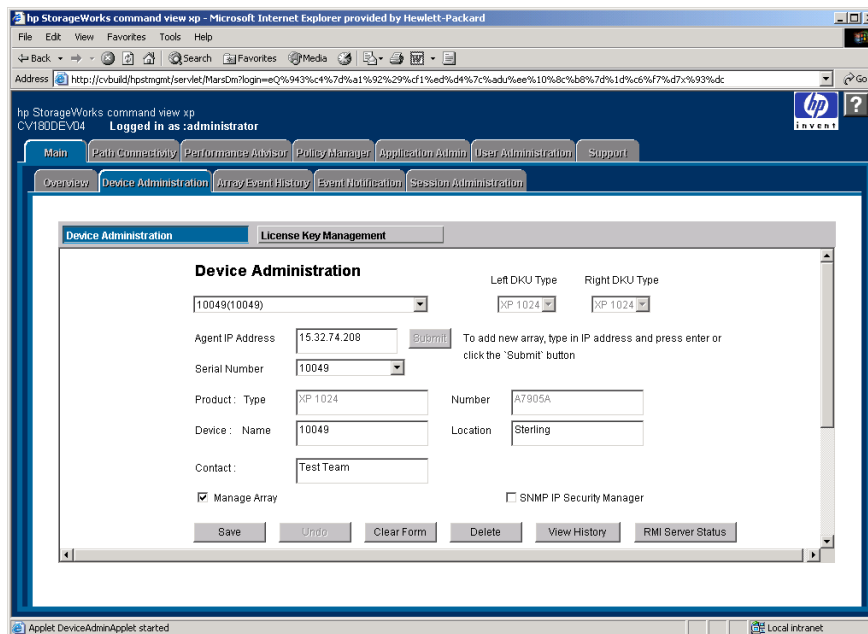
---

**Note:** Unless otherwise stated, the figures in this chapter reflect the screens of an XP128 or XP1024. There are slight differences in the screens for an XP48, XP256, or XP512, but all differences have been noted in the text.

---

## Accessing Device Administration

To access Device Administration, click the **Main** tab and then the **Device Administration** tab. The Device Administration screen is displayed.



**Figure 20: Device Administration screen (XP128/XP1024)**

## Display

The Device Administration screen consists of the following items:

- **Device drop-down list:** A list of disk arrays known to Command View. The disk array information is a combination of the serial number and user-assigned name. If you're adding a new disk array, ignore this field. It will display the new disk array after you enter its IP address and name. This is described in [Adding \(Registering\) a Disk Array](#) on page 78.
- **Left DKU Type (XP128/XP1024 only):** The type of DKUs to the left of the disk controller unit (DKC). An XP1024 may have an XP512 DKU installed in this position.
- **Right DKU Type (XP128/XP1024 only):** The type of DKUs to the right of the disk controller unit (DKC). An XP1024 may have an XP512 DKU installed in this position.



- **Agent IP Address:** The disk array's IP address.
- **Serial Number:** The serial number of the disk array. When you're adding a new disk array, it is automatically updated when you type the IP of address of the disk array.
- **Product Type and Number:** The product type will be XP48, XP128, XP256, XP512, or XP1024. The product number is the HP product designation. When you're adding a new disk array, these fields are automatically updated when you type the IP address.
- **Device Name:** A user-defined nickname that identifies a disk array.
- **Location:** The location of the disk array.
- **Contact:** The person to be contacted regarding issues with the disk array.
- **Enable FTP check box (XP48/XP512 only):** The check box is selected by default. Clear this check box to disable the FTP option. By default, FTP will be used for data retrieval.
- **Manage Array check box:** The check box is selected by default. Select this check box to indicate whether or not the disk array will be managed by Command View. If it isn't selected, the device will be added to a Command View list of disk arrays, but it will not be managed by Command View. No configuration data will be retrieved. Information about managed disk arrays can be used by other storage management platforms such as SAN Manager DM.
- **SNMP IP Security Manager check box:** When selected, displays the IP Security Manager screen.
- **Save button:** Saves disk array information.
- **Undo button:** Removes any changes made to the device information displayed, but only those made before you click **Save**.
- **Clear Form button:** Clears all the fields on the screen.
- **Delete button:** Deletes the disk array from the list of devices.
- **View History button:** Displays the Device History screen, which lists recent device administration events.
- **RMI Server Status button (XP128/XP1024 only):** Displays a message indicating whether the RMI server is up or down.

## Adding (Registering) a Disk Array

Adding an XP disk array from the Device Administration screen is not supported if you are using Mozilla 1.2.1.01 on HP-UX 11.23. Instead, add an XP disk array by using any of the other supported operating systems and browsers, or by using the "create device" CLI command. For more information, refer to the Known Issues section of the *Command View XP ReadMe*.

### To add or register a disk array:

1. From the Device Administration screen, enter the disk array's IP address in the **Agent IP Address** field.  
For the XP256, enter the IP address of the computer running the Remote Control software. Each XP256 has a dedicated computer.
2. Press **Enter** or click **Submit**.  
The **Serial Number**, **Product Type**, and **Product Number** fields are filled in automatically.
3. If the **Device Name** field is blank, enter a name for the disk array.
4. For the XP1024, select the left DKU type and right DKU type from the drop-down lists.
5. If the **Contact** and **Location** fields are blank, enter a contact name and a location.
6. Select the **Manage Array** check box. This check box is selected by default. If it is not selected, the disk array is added to Command View's list, but it will not be managed by Command View. No configuration data will be retrieved.
7. Click **Save** and then click **OK** to confirm.

## Deleting (Unregistering) a Disk Array

You cannot unregister a device that is in use. If the device is in use, go to the Session Administration screen, select the disk array, and click **End Session**. When the device is no longer in use, return to the Device Administration screen.

### To delete or unregister a disk array:

1. From the Device Administration screen, select the disk array you want to delete from the **Device** drop-down list.
2. Clear the **Manage Array** check box. A managed disk array cannot be deleted.
3. Click **Save**.
4. Select the disk array again.
5. Click **Delete**.

## Changing Disk Array Parameters

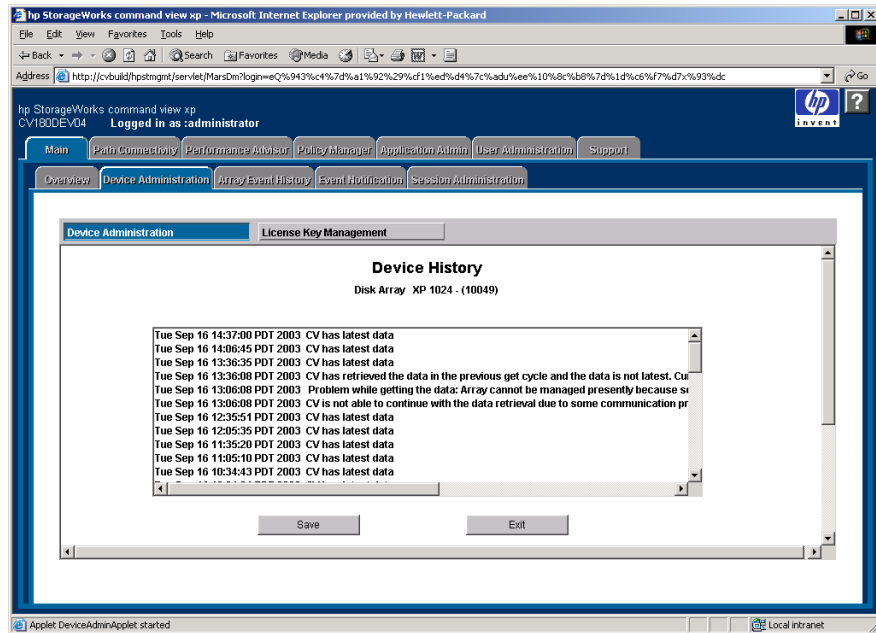
**To change the a disk array's parameters:**

1. From the Device Administration screen, select the disk array whose information you want to modify from the **Device** drop-down list.
2. Modify the parameters (name, location, contact name, etc.). To clear all the fields on the screen, click **Clear Form**. To cancel all your changes, click **Undo**.
3. To save all changes, click **Save**. You must click **Save** to save all changes or all of your changes will be canceled.

## Viewing Device History

To view recent device administration events:

1. From the Device Administration screen, select the disk array whose history you want to view from the **Device** drop-down list.
2. Click **View History**. The Device History screen is displayed.



**Figure 21: Device History screen**

3. To save the device history to a text file, click **Save** and complete the required steps to save the file to your computer.
4. When you are done viewing the events, return to Device Administration screen by clicking **Exit**.

## Setting SNMP IP Security

SNMP IP Security is a facility for managing SNMP IP security from Command View. It is a tool for controlling which SNMP managers can access a disk array.

Limiting disk array access to specified SNMP managers reduces the possibility that unauthorized persons can access the disk arrays. It makes SNMP communication safer over the network.

Using SNMP IP Security, only registered IP addresses can access the disk array via SNMP. Otherwise (the default condition), the SNMP interface is open to all management stations that “speak” SNMP. The registered IP addresses are stored on the disk array. The disk array keeps a list of up to 32 IP addresses to which it can send SNMP messages.

Note that using SNMP IP Security is optional and is not supported for the XP256.

Use SNMP IP Security to:

- Display a list of SNMP manager IP addresses registered in the disk array (page 82)
- Add SNMP managers to the disk array’s list (page 83)
- Delete SNMP managers from the disk array’s list (page 84)

### Disabling SNMP IP Security

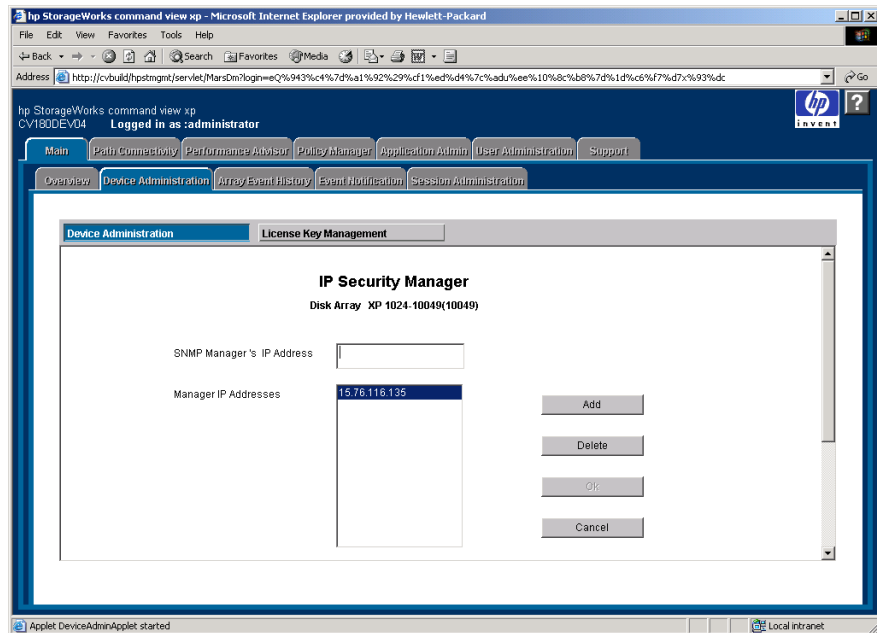
Disabling SNMP IP Security gives all SNMP Managers access to the MIB database on the disk array. To do this, first delete all the other SNMP Managers. Then, delete the Command View SNMP Manager’s IP address.

Note that if at least one SNMP manager is registered, then the IP Security function is ON and does not allow any other SNMP manager to access the MIB.

## Accessing SNMP IP Security

### To access SNMP IP security:

1. From the Device Administration screen, click an existing disk array or add a new disk array.
2. Select the **SNMP IP Security Manager** check box. The IP Security Manager screen is displayed.



**Figure 22: IP Security Manager screen**

The list box on this screen displays all IP addresses registered in the disk array. Note that IP security applies only to the disk array selected. You should perform this operation for each disk array requiring IP security.

## Adding SNMP IP Security

### To add SNMP IP security:

1. From the IP Security Manager screen, enter the IP Address in the **SNMP Manager's IP Address** field.
2. Click **Add**. The IP address is added to the list in the list box.
3. Click **OK** to add the address to the list. A confirmation dialog box is displayed.
4. Click **OK** to confirm and return to the Device Administration screen.
5. After the operation has been completed, a confirmation dialog box is displayed.

6. Click **OK** to continue.

## Removing SNMP IP Security

### To remove SNMP IP security:

1. From the IP Security Manager screen, click an address in the list box.
2. Click **Delete**. A confirmation dialog box is displayed.
3. Click **OK**.
4. To return to the Device Administration screen, click **OK**. A confirmation dialog box is displayed.
5. Click **OK** to confirm and return to the Device Administration screen.
6. After the operation has been completed, a confirmation dialog box is displayed.
7. Click **OK** to continue.



## Managing License Keys

If you need to install any license keys that enable disk array product features such as Business Copy or Continuous Access, use the License Key Management (Install) screen. The license key is provided by the HP license server. The 20-digit key is e-mailed to you. You can then install the license key in Command View, using License Key Management.

The main functions of License Key Management are:

- Displays a list of software, showing which options do or do not have license keys installed (page 86)
- Installs licenses (page 88)
- Uninstalls licenses (page 89)

The feature is supported for the XP48, XP128, XP512, and XP1024.

There are three types of license:

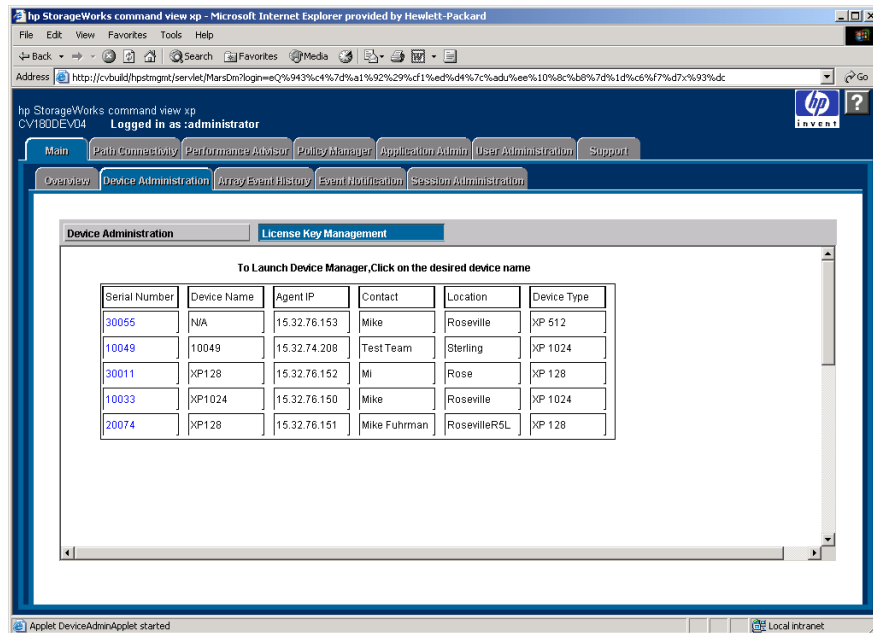
- **Temporary key.** A temporary key is a 120-day trial key. When this key expires, it cannot be re-installed for 180 days.
- **Emergency key.** An emergency key is a 10-day key, used to continue operating a function until you obtain a permanent key, or to release a changed configuration after a temporary key expires. This key can be re-installed.
- **Permanent key.** A permanent key does not expire. Permanent keys are purchased based on the amount of your disk array's capacity.

Your HP representative can help determine which keys you need to purchase, based on the options you want to run and the capacity of your disk array.

## Accessing License Key Management

**To access the License Key Management main screen:**

1. From the Device Administration screen, click **License Key Management**.

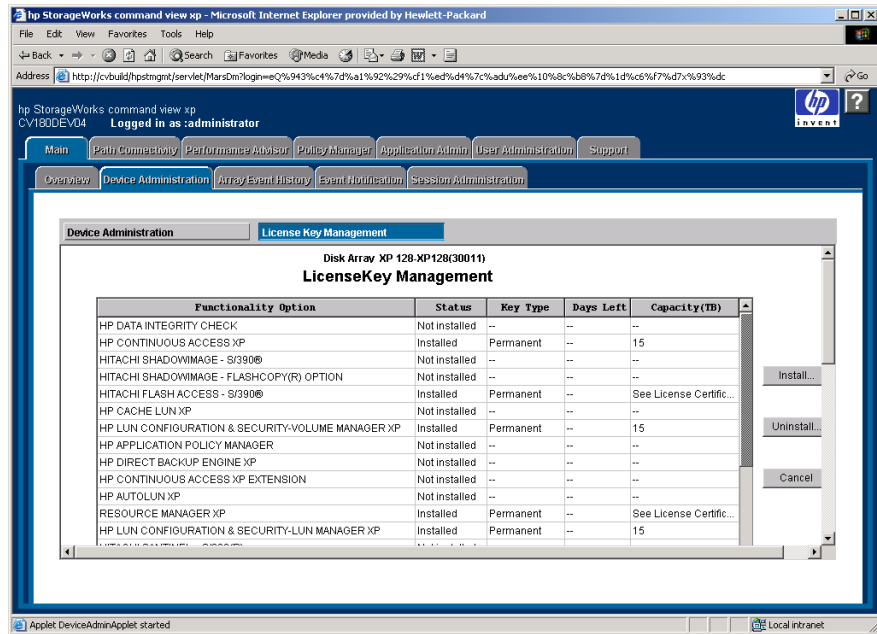


**Figure 23: Accessing License Key Management**

2. In the Serial Number column, click the disk array you want to access. The License Key Management main screen is displayed.

## License Key Management Main Screen

The License Key Management main screen displays when the refresh completes and current License Key information is received from the disk array.



**Figure 24: License Key Management main screen**

The License Key Management main screen consists of the following items:

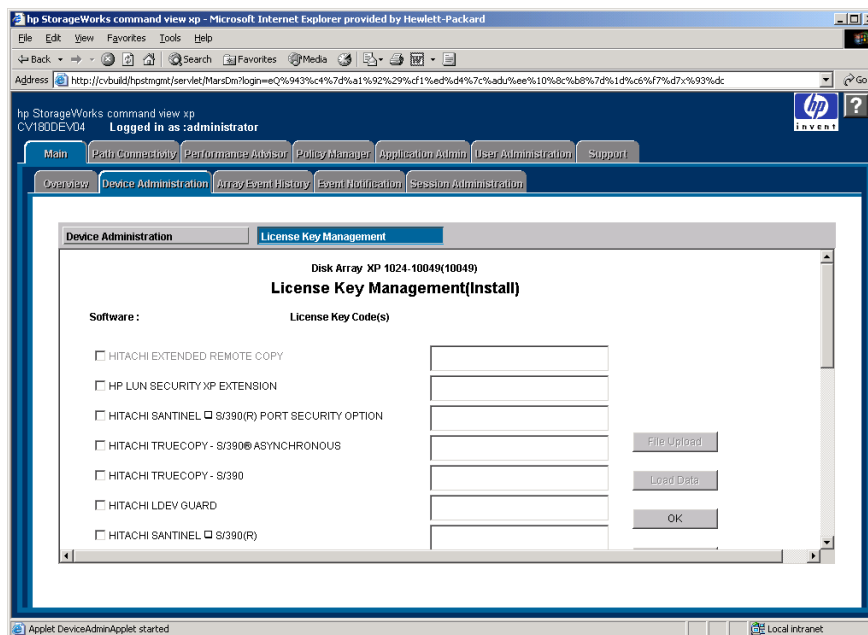
- **Functionality Option:** List of software options. Note that not all options are supported.
- **Status:** Installation status of the option (“Installed” or “Not Installed”).
- **Kind of Key:** Type of key installed (Temporary, Emergency or Permanent). If no key is installed, the column displays “--”.
- **Days Left:** Number of days left before expiration of the key. This is displayed only for Temporary and Emergency keys.
- **Capacity:** Capacity of the license (for Permanent keys) in megabytes.
- **Install button:** Displays the License Key Management (Install) screen
- **Uninstall button:** Displays the License Key Management (Uninstall) screen.
- **Cancel button:** Returns you to the previous screen.

## Installing a License Key

Use the License Key Management (Install) screen to install additional license keys. Some of the check boxes may be disabled. This means that licenses for those applications have been installed with full capacity and no more install operations need to be performed for them.

### To install a license key:

1. From the License Key Management main screen, click **Install**. The License Key Management (Install) screen is displayed.



**Figure 25: License Key Management (Install) screen**

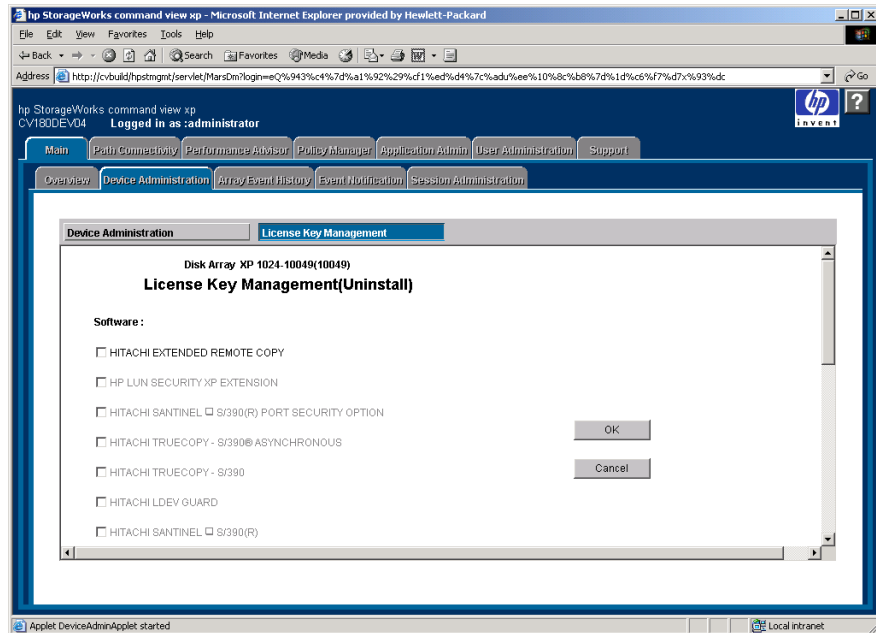
2. Select the check box for each license key you want to install.
3. Enter the license key code(s).
4. Click **OK** to add the license key and return to the License Key Management main screen. Clicking **Cancel** returns you to the License Key Management main screen without installing the license.

You can perform multiple license installs in the same operation. The **File Upload** and **Load Data** buttons are not used at this time.

## Uninstalling a License Key

To uninstall a license key:

1. From the License Key Management main screen, click **Uninstall**. The License Key Management (Uninstall) screen is displayed.



**Figure 26: License Key Management (Uninstall) screen**

2. Select a check box for each license you want to uninstall. Some check boxes will be disabled because licenses for these options have not been installed.
3. Click **OK**. Clicking **Cancel** returns you to the License Key Management main screen without uninstalling the license.



# Array Event History and Event Notification



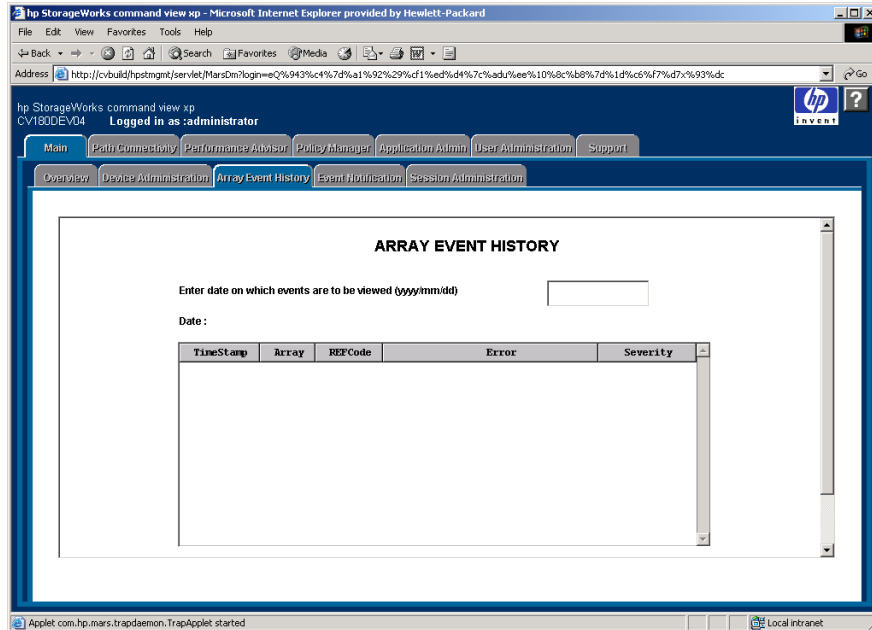
Use the Array Event History screen to view recent disk array events and error conditions. To use Array Event History, you must configure one or more XP disk arrays to forward traps to Command View's Trap Distributor and then you can choose to set up Trap Distributor to forward SNMP traps. Only SNMP traps received by Trap Distributor are recorded in the Array Event History screen. To configure an XP disk array to forward traps to Trap Distributor, refer to the Trap Distributor section of the Integrating Command View with Other Platforms page under the **Support** tab in Command View.

Use the Event Notification screens to configure and dispatch notifications, configure the history log file, view events and notification history, and test notification dispatching. Event Notification also includes a history log of disk array events. The primary difference between the Array Event History and Event Notification Event History screens is that Event Notification will automatically record events and generate notifications for any managed disk array and Path Connectivity without requiring additional configuration. Trap Distributor can be used to record events from unmanaged disk arrays as well as managed disk arrays.

For information about integrating with other software products, refer to the integration page by clicking the **Support** tab in Command View.

## Viewing Array Event History

To access Array Event History, click the **Main** tab and then the **Array Event History** tab. The Array Event History screen is displayed.



**Figure 27: Array Event History screen**

### Display

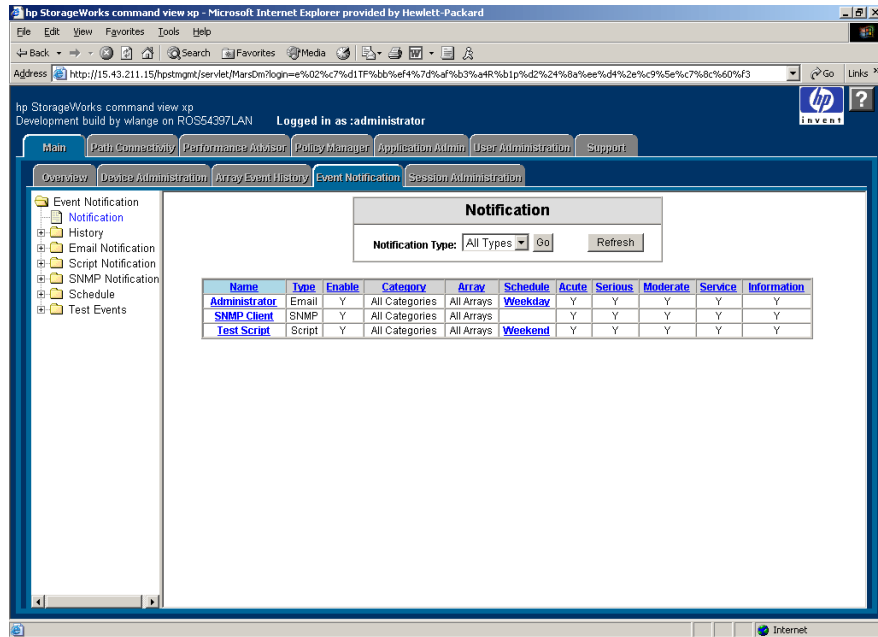
The Array Event History screen consists of the following items:

- **Date field:** Enter the date whose events you want to view and click **Refresh**. Use the yyyy/mm/dd format.
- **Array Event History table:** Contains the date and time the event occurred, the serial number of the disk array that generated the error, the reference code for a Remote Service Information Message (R-SIM) to identify the error, an explanation of the error, and the error’s severity level.
- **Refresh button:** Refreshes the display. Click this button to receive updated information for the date selected or to refresh the display after entering a new date.



## Accessing Event Notification

To access Event Notification, click the **Main** tab and then the **Event Notification** tab. The Notification screen is displayed.



**Figure 28: Notification screen**

To display the other Event Notification screens, use the navigation tree on the left. To display the most current event notification data on the screen, click **Refresh**.

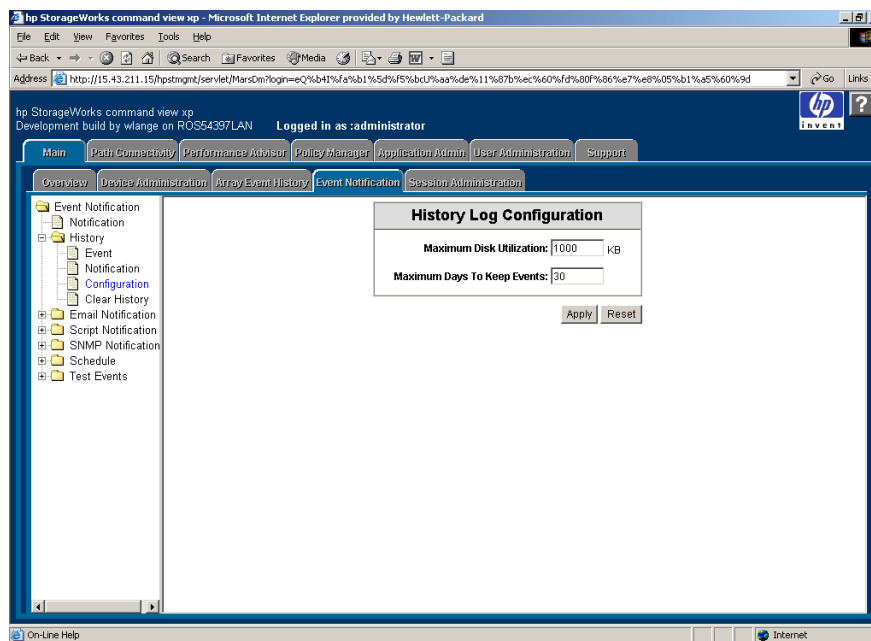
## Configuring Event History Settings

The event history data is saved in the history log file. Use the History Log Configuration screen to make changes to the event history settings.

You can use this screen to set the file size and number of days to save the events. Because the file size takes priority over the number of days, the history log file will never exceed the maximum file size regardless of the number of days you set.

### To configure event history settings:

1. In the Event Notification navigation tree, click **History** and then **Configuration**. The History Log Configuration screen is displayed.



**Figure 29: History Log Configuration screen**

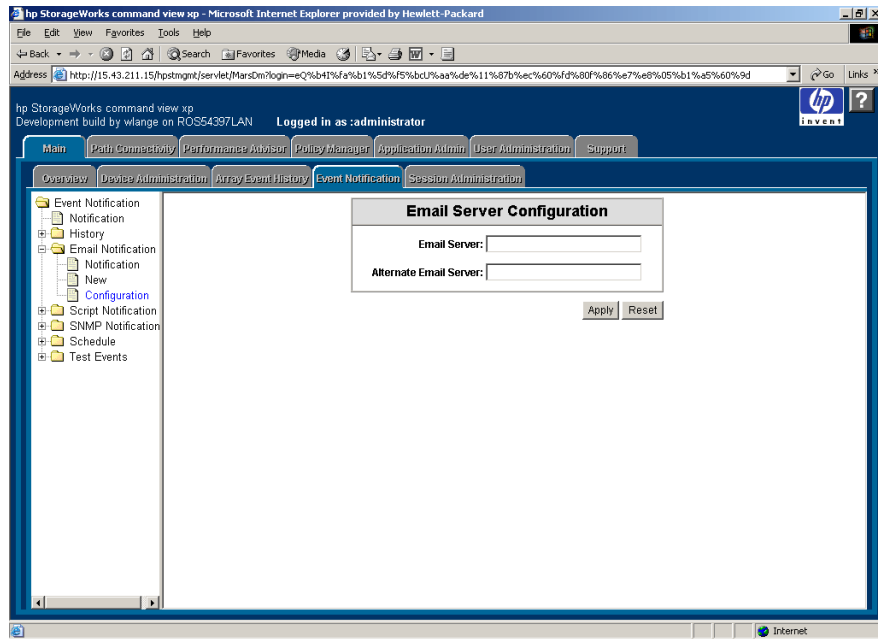
2. To set the maximum file size for the history log file, enter the file size in KB in the **Maximum Disk Utilization** field.
3. To set the maximum number of days to save events in the history log file, enter the number of days in the **Maximum Days To Keep Events** field.
4. Click **Apply**. To cancel your changes, click **Reset**.

## Specifying the E-mail Server for E-mail Notifications

Before sending any e-mail notifications, you must specify the e-mail SMTP server that is used to send an e-mail notification.

### To specify the e-mail server:

1. In the Event Notification navigation tree, click **Email Notification** and then **Configuration**. The Email Server Configuration screen is displayed.



**Figure 30: Email Server Configuration screen**

2. In the **Email Server** field, enter the server name or address.
3. To specify a alternate server if the first one is not available, enter the server name or address in the **Alternate Email Server** field.
4. Click **Apply**. To cancel your changes, click **Reset**.

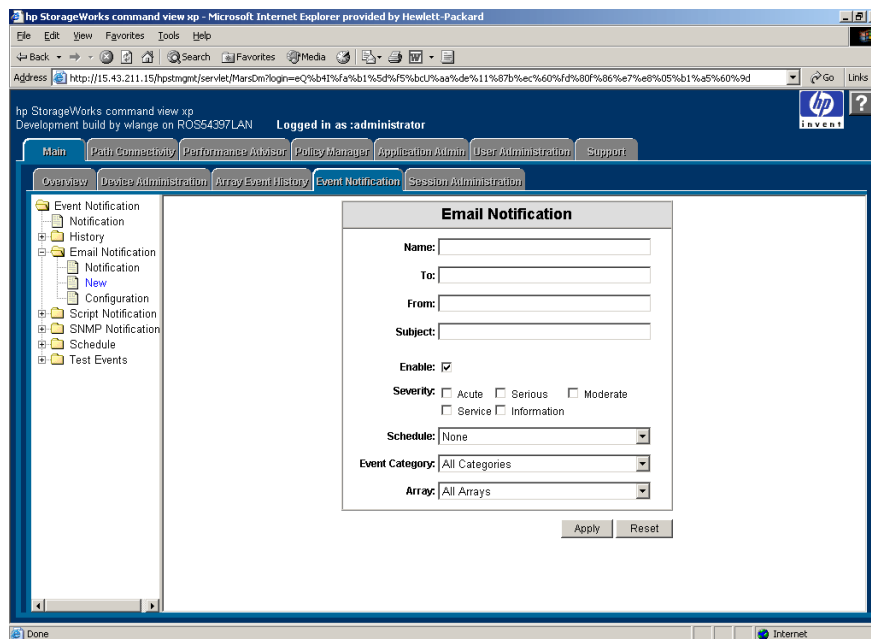
## Configuring E-mail Notifications

Use the Email Notification screen to add, edit, or delete existing e-mail notifications. Event information is provided in the e-mail message body. The following is an example of an e-mail notification message:

```
Notification_Dispatch_Notice: Notification dispatch.
Notification_Name: My Email
Category: Array
Severity: Serious
Timestamp: 2003-10-21T10:00:56
Array_Serial_Number: 10033
Reference_Code: 54321
Message: Test Message
```

**To add a new e-mail notification:**

1. In the Event Notification navigation tree, click **Email Notification** and then **New**. The Email Notification screen is displayed.



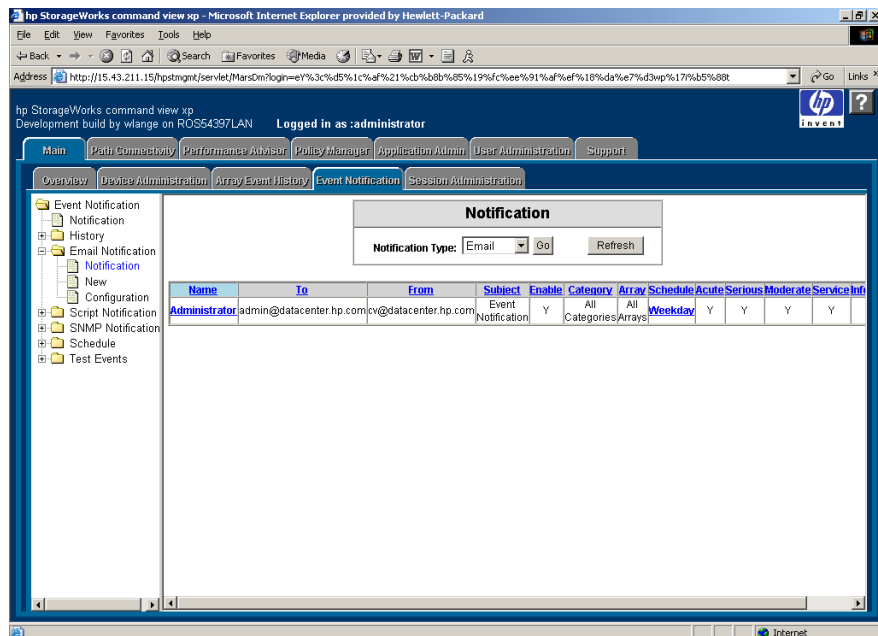
**Figure 31: Email Notification screen**

2. In the **Name** field, enter the name of the notification for identification purposes.
3. In the **To** and **From** fields, enter the notification recipient's e-mail address and the sender's e-mail address, respectively.
4. In the **Subject** field, enter the subject of the e-mail notification.
5. By default, the **Enable** check box is selected. If you want to create an inactive notification, clear the check box. Notifications will not be sent until this check box is selected.
6. Choose one or more severity levels by selecting the appropriate **Severity** check box(es). A notification will be sent only when it meets the severity level criteria.

7. In the **Schedule** drop-down list, click a previously created schedule or **None**, which means there should be no schedule restrictions. If you select a schedule, a notification will be sent only for events that occurred during the set schedule. For more information about creating schedules, see [Managing the Notification Schedule](#) on page 104.
8. In the **Event Category** drop-down list, click **All Categories**, **Array**, or **Path Connectivity**. The default is **All Categories**. Only events that fall into the specified category will trigger a notification.
9. In the **Array** drop-down list, click a disk array or **All Arrays**. The default is **All Arrays**. Only events that occurred on the specified disk array will trigger a notification.
10. Click **Apply**. To cancel your changes, click **Reset**.

**To edit or delete an existing e-mail notification:**

1. In the Event Notification navigation tree, click **Email Notification** and then **Notification**. The Notification screen is displayed.



**Figure 32: Notification screen for e-mail notifications**

2. Click the name of the notification you want to edit or delete. The Email Notification screen is displayed.
3. Edit the notification and click **Apply**. To cancel your changes, click **Reset**. To delete the notification, click **Delete**.

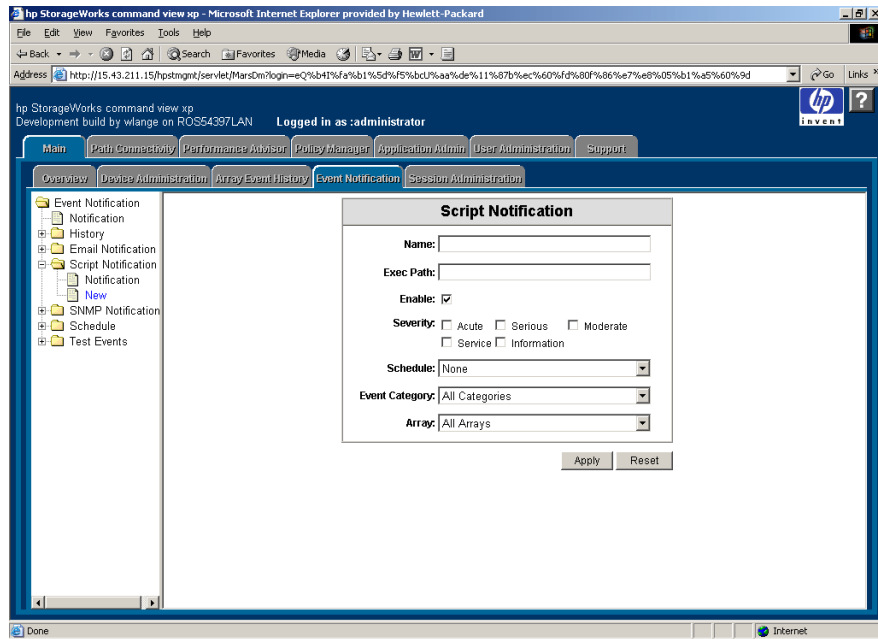
## Configuring Script Notifications

Use the Script Notification screen to add, edit, or delete script notifications. Event information to the script is provided by the standard input stream. The following is an example of a script notification:

```
Notification_Dispatch_Notice: Notification dispatch.  
Notification_Name: My Script  
Category: Array  
Severity: Serious  
Timestamp: 2003-10-21T10:00:56  
Array_Serial_Number: 10033  
Reference_Code: 54321  
Message: Test Message
```

### To add a new script notification:

1. In the Event Notification navigation tree, click **Script Notification** and then **New**. The Script Notification screen is displayed.



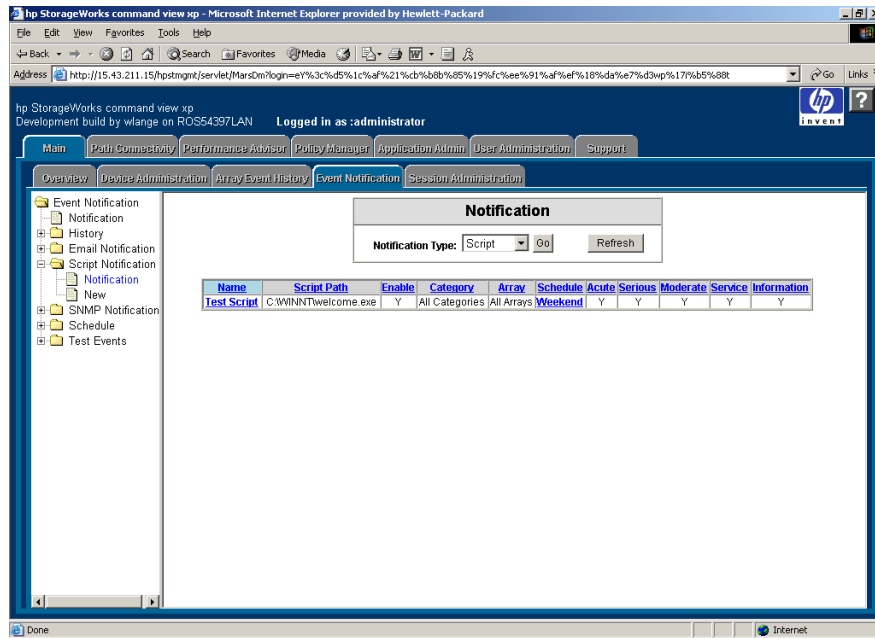
**Figure 33: Script Notification screen**

2. In the **Name** field, enter the name of the notification for identification purposes.
3. In the **Exec Path** field, enter the absolute path of the script you want to execute.
4. By default, the **Enable** check box is selected. If you want to create an inactive notification, clear the check box. Notifications will not be executed until this check box is selected.
5. Choose one or more severity levels by selecting the appropriate **Severity** check box(es). A notification will be executed only when it meets the severity level criteria.
6. In the **Schedule** drop-down list, click a previously created schedule or **None**, which means there should be no schedule restrictions. If you select a schedule, a notification will be executed for events that occurred during the set schedule. For more information about creating schedules, see [Managing the Notification Schedule](#) on page 104.

7. In the **Event Category** drop-down list, click **All Categories**, **Array**, or **Path Connectivity**. The default is **All Categories**. Only events that fall into the specified category will trigger a notification.
8. In the **Array** drop-down list, click a disk array or **All Arrays**. The default is **All Arrays**. Only events that occurred on the specified disk array will trigger a notification.
9. Click **Apply**. To cancel your changes, click **Reset**.

**To edit or delete an existing script notification:**

1. In the Event Notification navigation tree, click **Script Notification** and then **Notification**. The Notification screen is displayed.



**Figure 34: Notification screen for script notifications**

2. Click the name of the notification you want to edit or delete. The Script Notification screen is displayed.
3. Edit the notification and click **Apply**. To cancel your changes, click **Reset**. To delete the notification, click **Delete**.



## Configuring SNMP Notifications

Use the SNMP Notification screen to add, edit, or delete SNMP notifications. A SNMP notification sends SNMP traps to other applications. The trap format is based on the NetCitizen MIB. The *NetCitizen2.mib* file is located in the `\hpss\subagent` directory.

The trap's description contains the following information:

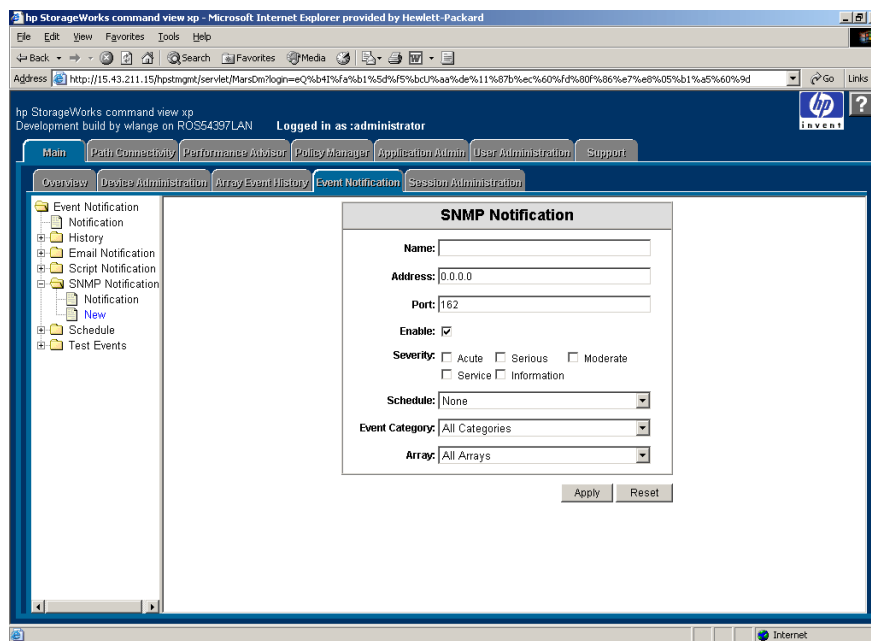
**Table 2: Information for configuring SNMP notifications (*NetCitizen2.mib*)**

Event Severity	Trap Type
Acute	hpHttpMgNonRecoverableHealthTrap
Serious	hpHttpMgCriticalHealthTrap
Moderate or Service	hpHttpMgWarningHealthTrap
Information	hpHttpMgOKHealthHealthTrap

	Information Included in the Description
Trap Info:	community: public enterpriseOid: .1.3.6.1.4.1.11.2.36.1 trapType: 6 specificTrapType: hpHttpMgNonRecoverableHealthTrap (7), hpHttpMgCriticalHealthTrap (6), hpHttpMgWarningHealthTrap(5), or hpHttpMgOKHealthTrap (4) upTime: event time
Trap Variables:	hpHttpMgDeviceIndex: Always 0 (zero) hpHttpMgDeviceSysObjID: 1.3.6.1.4.1.11.10.2.1.14 hpHttpMgDeviceGlobalUniqueID: hostIpAddress_arraySn or hostIpAddress_PCApplication hpHttpMgDeviceManagementURL: http://hostIpAddress/hpstmgmt/servlet/MarsDm hpHttpMgDeviceManagementURLLabel: ArrayMgmt or PC hpHttpMgDeviceSpecificEventCode: Event Message hpHttpMgDeviceSpecificFRU: RefCode or FRU

### To add a new SNMP notification:

1. In the Event Notification navigation tree, click **SNMP Notification** and then **New**. The SNMP Notification screen is displayed.



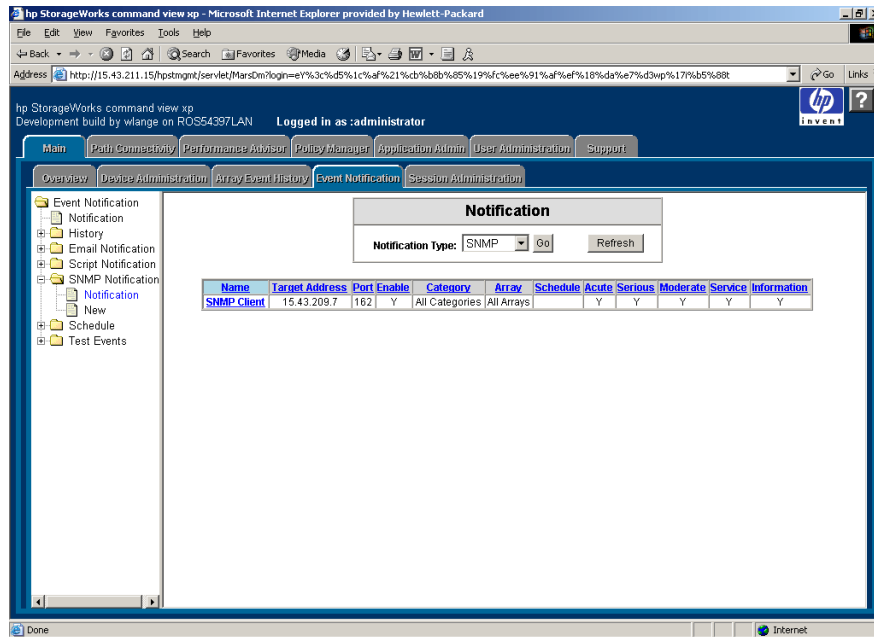
**Figure 35: SNMP Notification screen**

2. In the **Name** field, enter the name of the notification for identification purposes.
3. In the **Address** field, enter the target IP address for the SNMP trap.
4. In the **Port** field, enter the IP port number for SNMP. The recommended port number is 162.
5. By default, the **Enable** check box is selected. If you want to create an inactive notification, clear the check box. Notifications will not be sent until this check box is selected.
6. Choose one or more severity levels by selecting the appropriate **Severity** check box(es). A notification will be sent only when it meets the severity level criteria.
7. In the **Schedule** drop-down list, click a previously created schedule or **None**, which means there should be no schedule restrictions. If you select a schedule, a notification will be sent for events that occurred during the set schedule. For more information about creating schedules, see [Managing the Notification Schedule](#) on page 104.

8. In the **Event Category** drop-down list, click **All Categories**, **Array**, or **Path Connectivity**. The default is **All Categories**. Only events that fall into the specified category will trigger a notification.
9. In the **Array** drop-down list, click a disk array or **All Arrays**. The default is **All Arrays**. Only events that occurred on the specified disk array will trigger a notification.
10. Click **Apply**. To cancel your changes, click **Reset**.

**To edit or delete an existing SNMP notification:**

1. In the Event Notification navigation tree, click **SNMP Notification** and then **Notification**. The Notification screen is displayed.



**Figure 36: Notification screen for SNMP notifications**

2. Click the name of the notification you want to edit or delete. The SNMP Notification screen is displayed.
3. Edit the notification and click **Apply**. To cancel your changes, click **Reset**. To delete the notification, click **Delete**.

## Managing the Notification Schedule

If needed, you can create one or more schedules to restrict event notification to a specific day and time on a weekly basis. After creating a schedule, you can then apply the schedule when creating or editing e-mail, script, or SNMP notifications.

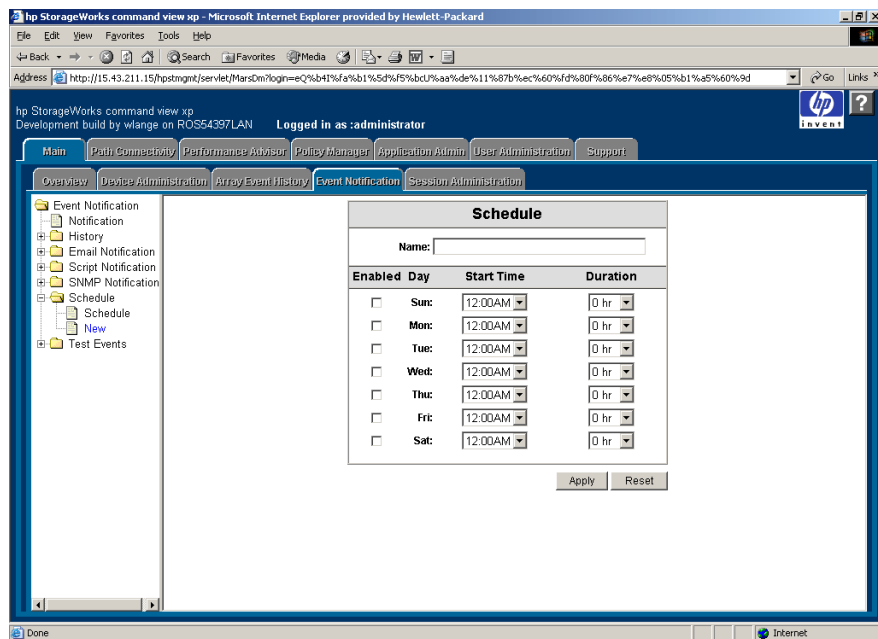
You can also create schedules that span over two days. For instance, if you set the start time to 10:00 p.m. and set the duration to 5 hours, notification monitoring will end at 3 a.m. the following day.

You can also edit or delete schedules. If you rename or delete a schedule currently in use, go to the notification and reselect the schedule or chose a new schedule, or the notification will not follow a schedule.

To update the Schedule screen, click **Refresh**.

### To create a new notification schedule:

1. In the Event Notification navigation tree, click **Schedule** and then **New**. The Schedule screen displays a form.

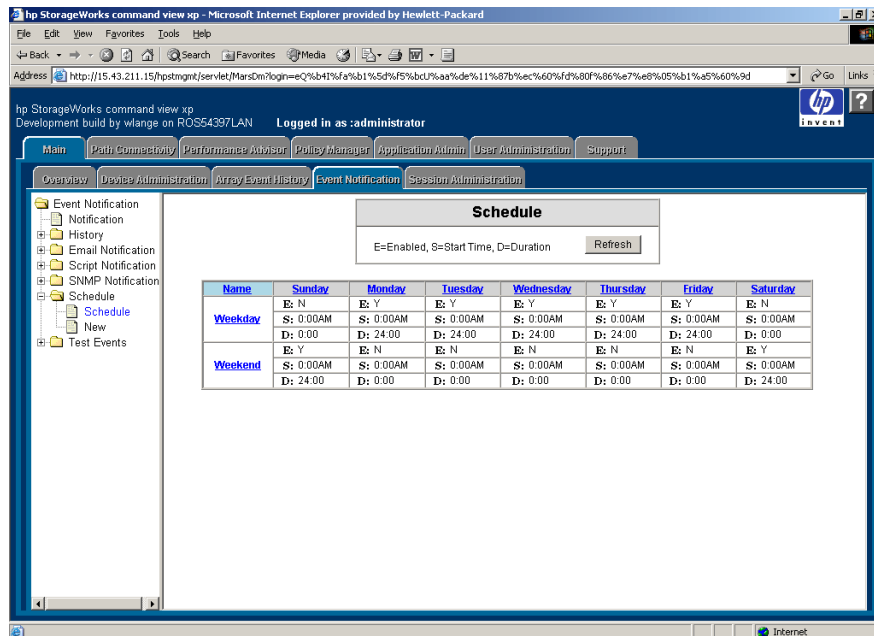


**Figure 37: Schedule screen for creating a new schedule**

2. Set the schedule by selecting the **Enable** check box next to the day you want, clicking a start time in the **Start Time** drop-down list, and clicking the number of hours in the **Duration** drop-down list.
3. Click **Apply**. To cancel your changes, click **Reset**.

**To edit or delete an existing notification schedule:**

1. In the Event Notification navigation tree, click **Schedule** and then **Schedule**. The Schedule screen displays a list of existing schedules.



**Figure 38: Schedule screen for existing schedules**

2. Click the name of the schedule you want to edit or delete. The Schedule screen displays a form of the existing schedule.
3. Edit the schedule and click **Apply**. To cancel your changes, click **Reset**. To delete the schedule, click **Delete**.

## Viewing a List of Configured Notifications

Use the Notification screen to display the e-mail, script, and SNMP notifications that have been set. There are several methods of viewing configured notifications. The following procedures explain the various ways. From the Notification screen, you can then sort the list or access additional screens to edit or delete a notification.

### To manage configured notifications:

1. To display a list of configured notifications, complete one of the following steps:
  - Click the **Event Notification** tab display the default screen, which is the Notification screen. The default screen displays all notifications.
  - From any other Event Notification screen, click **Notification** in the navigation tree to display the default screen.
  - To view a specific type of notification from the default screen, click the **Notification Type** drop-down list, click **Email**, **Script**, or **SNMP**, and then click **Go**.
  - To view a specific type of notification from any other Event Notification screen, click **Email Notification**, **Script Notification**, or **SNMP Notification** in the navigation tree, and then click **Notification** to display that type of notification.
2. To sort by column, click the column heading link.
3. To edit a notification, click the name of the notification.
4. To delete a notification, click the name of the notification and then click **Delete**.
5. To edit the schedule of a notification, click the name of the schedule.
6. To update the Notification screen, click **Refresh**.

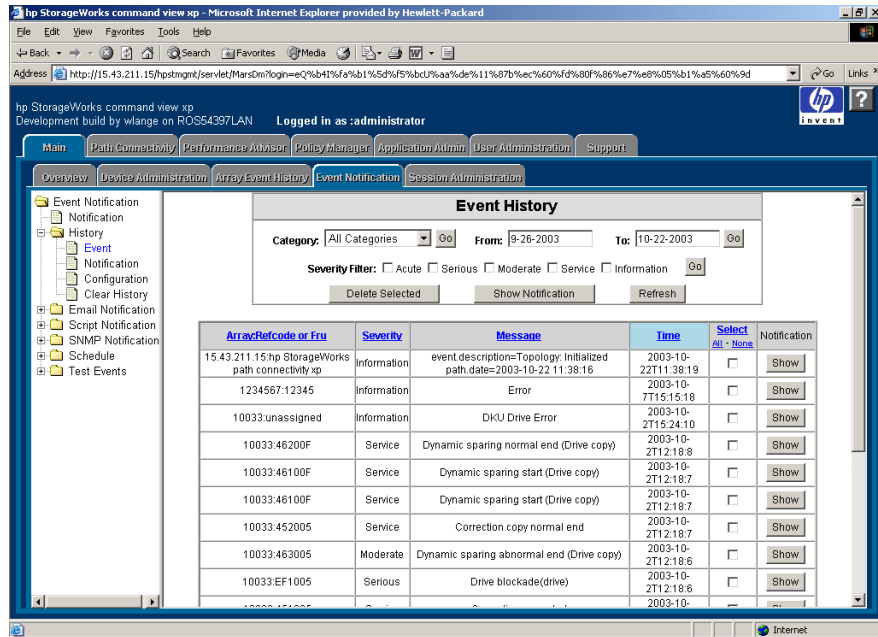
## Viewing Event History

Use the Event History screen to display event messages along with information about its severity, when the event occurred, and whether a notification was sent. In addition, you can filter events by category and date, and sort by column.

You can also display the event notification history from the Notification History screen (see [Viewing Notification History](#) on page 108).

**To view the event history:**

1. In the Event Notification navigation tree, click **History** and then **Event**. The Event History screen displays all the events that have occurred according to the settings specified on the History Log Configuration screen (see [Configuring Event History Settings](#) on page 93).

**Figure 39: Event History screen**

2. To create a more selective listing, apply any of the following filters:
  - To display disk array events only, click **Array** in the **Category** drop-down list and click **Go**. To narrow the list to a specific disk array, click the disk array in the **Array** drop-down list.
  - To display Path Connectivity events only, click **Array** in the **Category** drop-down list and click **Go**. To narrow the list to a specific disk array, click the disk array in the **Array** drop-down list.
  - To display events during a specific date range, enter the dates in the **From** and **To** fields and click **Go**. Use the mm-dd-yyyy format.
  - To display events of a specific severity level, select one or more of the **Severity Filter** check box(es) and click **Go**.

3. To sort by column, click the column heading link.
4. To display or hide any notifications associated with an event:
  - To display notifications for a specific event, click **Show** next to the event you want to view.
  - To display notifications for all events, go the Notification History screen by clicking **History** and then **Notification** in the Event Notification navigation tree (see [Viewing Notification History](#) on page 108).
  - Click **Hide Notification** when you are done viewing the event notifications.
5. To update the Event History screen, click **Refresh**.

## Viewing Notification History

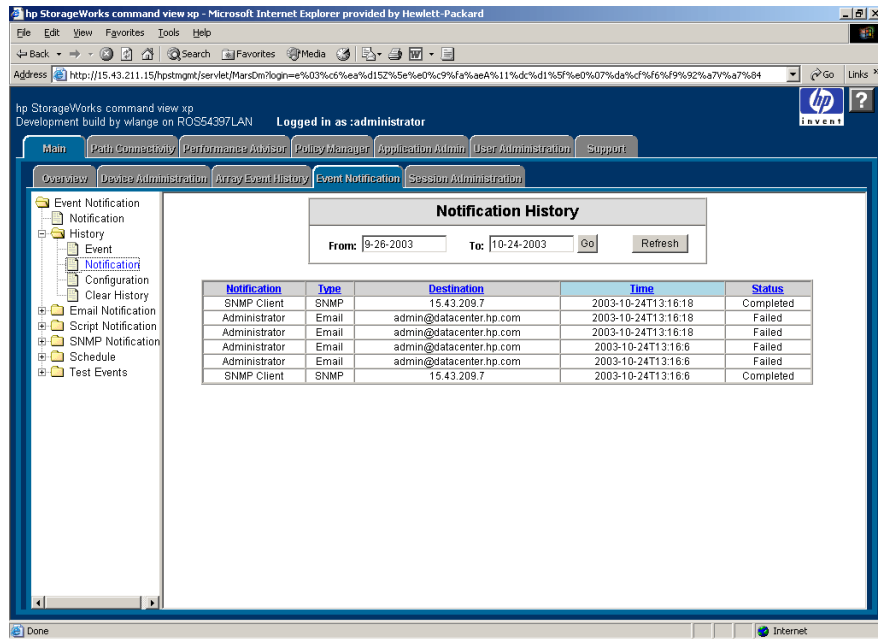
Use the Notification History screen to display a history of event notifications. The list shows who was notified, the type of notification, where and when the notification was sent, and the status. In addition, you can filter notifications by date and sort by column.

You can also display the event notification history for a specific event from the Event History screen (see [Viewing Event History](#) on page 106).

### To view the notification history:

1. In the Event Notification navigation tree, click **History** and then **Notification**. The Notification History screen displays all the notifications that have occurred.





**Figure 40: Notification History screen**

2. To display notifications during a specific date range, enter the dates in the **From** and **To** fields and click **Go**. Use the mm-dd-yyyy format.
3. To sort by column, click the column heading link.
4. To update the Notification History screen, click **Refresh**.

## Deleting History Events

In addition to deleting individual event entries, you can also delete all events by clearing event history log file. Deleting events also deletes the notification history associated with those events.

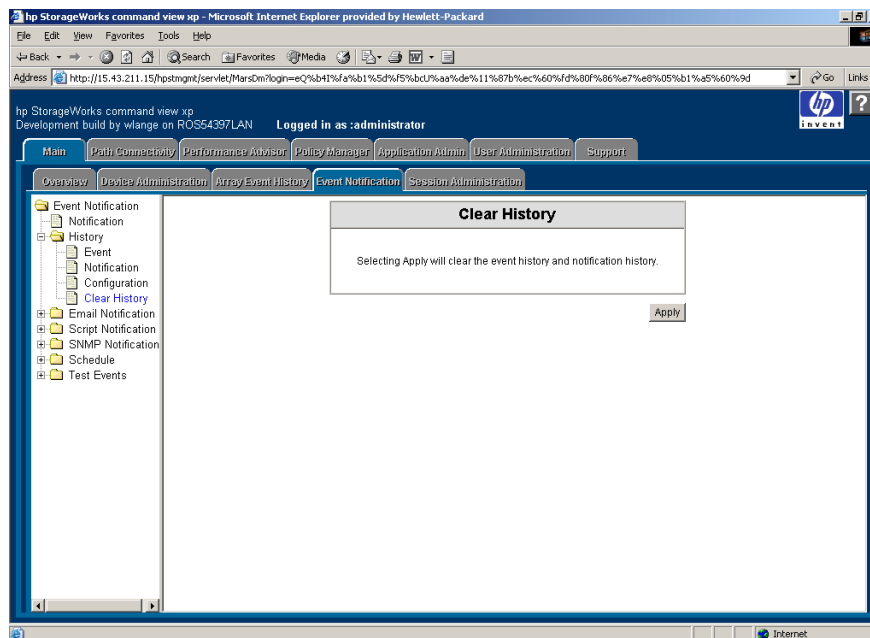
### To delete individual events:

1. In the Event Notification navigation tree, click **History** and then **Event**. The Event History screen displays all the notifications that have occurred.
2. In the Select column, select the check box(es) next to the events you want to delete. To select all the check boxes, click the **All** link in the Select column heading. Clicking the **None** link clears all the check boxes.

3. Click **Delete Selected**. The Event History screen is updated and no longer shows the events you selected to delete.

**To clear the history log file:**

1. In the Event Notification navigation tree, click **History** and then **Clear History**. The Clear History screen is displayed.



**Figure 41: Clear History screen**

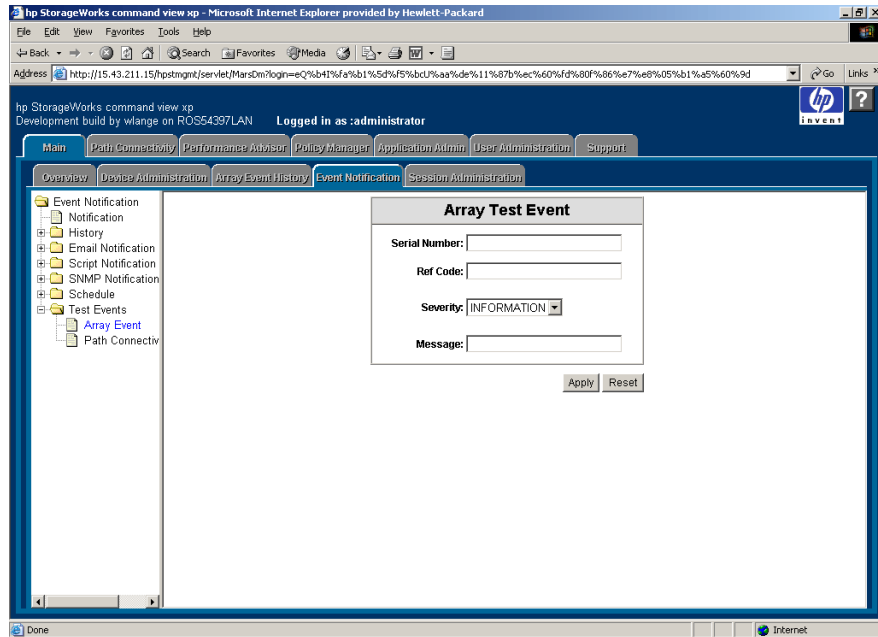
2. Click **Apply** to clear the history log file. A confirmation dialog box is displayed.
3. Click **OK** to confirm.

## Testing Event Notification

The Array Test Event and Path Connectivity Test Event screens provide a diagnostic tool that administrators can use to test event notifications. To use the tool, create a test event to then trigger a notification that is displayed on the Event History screen.

**To test array event notification:**

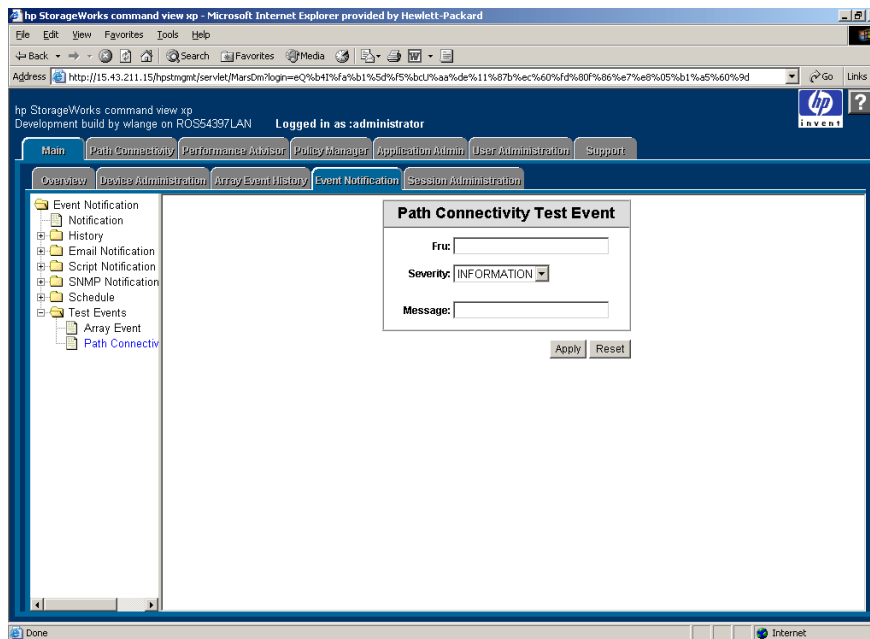
1. In the Event Notification navigation tree, click **Test Events** and then **Array Event**. The Array Test Event screen displays a form.

**Figure 42: Array Test Event screen**

2. Complete the form that triggers an event notification.
3. Click **Apply**. To cancel your changes, click **Reset**.
4. Go to the Event History screen by clicking **History** and then **Event**.
5. Locate the event that you created, and verify that a notification occurred by clicking **Show** next to the event.

**To test Path Connectivity event notification:**

1. In the Event Notification navigation tree, click **Test Events** and then **Path Connectivity Event**. The Path Connectivity Test Event screen displays a form.



**Figure 43: Path Connectivity Test Event screen**

2. Complete the form that triggers an event notification.
3. Click **Apply**. To cancel your changes, click **Reset**.
4. Go to the Event History screen by clicking **History** and then **Event**.
5. Locate the event that you created, and verify that a notification occurred by clicking **Show** next to the event.

# Session Administration



Use Session Administration to view information about disk array sessions and to end sessions.

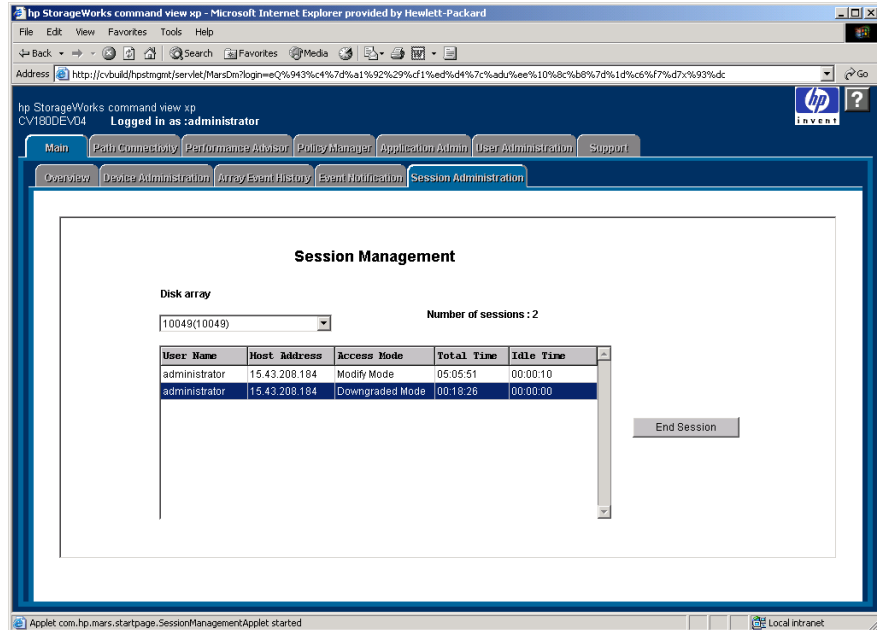
Multiple users can access a disk array simultaneously. Only one user is allowed to be in Modify mode, but there can be many view-only users.

View-only or modify status is determined by user permissions (set using the User Administration functions) and by whether another “modify” user is already managing a disk array. In that case, the second user’s permissions are downgraded to view-only.

If a session is inactive after a certain period of time because a user has not used the system, Command View automatically terminates the session. The default is 60 minutes, which can be changed. To change the value, edit the `SESSION_TIMEOUT_PLAN` value in the *CommandView.properties* file (see [Changing the Session Timeout Value](#) on page 116 for more information).

## Accessing Session Administration

To access Session Administration, click the **Main** tab and then the **Session Administration** tab. The Session Administration screen is displayed.



**Figure 44: Session Administration screen**

### Display

The Session Administration screen consists of the following items:

- **Disk Array:** A drop-down list containing disk array names.
- **Number of Sessions:** The number of GUI or CLI sessions in progress for the selected disk array.
- **User Name:** Names of users who are in session with the disk array.
- **Host Address:** The IP address of the user's workstation.
- **Access Mode:** "Modify Mode" or "View-only Mode."
- **Total Time:** Total time the user has been in session with the disk array.
- **Idle Time:** The elapsed time since the user has executed a command.
- **End Session button:** Ends the session for a selected user.

## Ending a Session

### To end a user's session:

1. From the Session Administration screen, click a disk array from the drop-down list. All sessions for that disk array are displayed.
2. Click the session you want to end.
3. Click **End Session**.



4. Click **OK**.

When you end a user's session, the user must log in again to access Command View.

## Changing the Session Timeout Value

The session timeout value determines how long a session lasts after a user in Modify mode has not used the browser. The default is set to 60 minutes. You cannot change the session timeout value using the Session Administration screen, but you can change the value by editing a configuration file. To change the value, edit the `SESSION_TIMEOUT_PLAN` value in the *CommandView.properties* file.

### To change the session timeout value:

1. Locate the *CommandView.properties* file in the `C:\hpss\dm\tomcat\webapps\hpstmgmt\webroot\Stormgmt` directory.
2. Use a word processor or text editor to open the file. Look for the `SESSION_TIMEOUT_PLAN` setting by locating the following line:

```
SESSION_TIMEOUT_PLAN=ONCE:60
```

3. Replace `60` with the number of minutes you want a session to last before it times out due to inactivity. This setting is applicable to all XP disk arrays.
4. If you are managing an XP128/XP1024, also consider changing `ONCE` to `ALWAYS`. The default is `ONCE:60`.

Most users will want to choose the `ONCE` setting. Using this setting means that Command View checks the *CommandView.properties* file only once, when someone adds a device or restarts the server, and then sets the session timeout value at that time.

Certain users may find they need the flexibility of the `ALWAYS` setting, which ensures that Command View always determines the timeout value. Using this setting means that Command View checks the *CommandView.properties* file every time a user in Modify mode clicks a tab to manage an XP128/XP1024 (Identity and Status tabs excluded). You may want to consider using this setting if you or someone else needs to change the timeout value on the SVP, but you want to override that when using Command View. Note that this setting adds an additional delay of approximately 45 seconds when loading a new screen.

If you are managing an XP48/XP256/XP512, Command View ignores the `ONCE` or `ALWAYS` setting because the `ALWAYS` setting is not available.

5. Save and close the file.
6. Restart Command View XP Services by clicking **Start > Programs > HP StorageWorks Command View XP > Restart Services**.



# Identity Screen



The Identity screen is an array-dependent screen and is the default screen when a disk array is selected.

---

**Note:** Unless otherwise stated, the figures in this chapter reflect the screens of an XP128 or XP1024. There are slight differences in the screens for an XP48, XP256, or XP512, but all differences have been noted in the text.

---

## Viewing Identity Information

To access this screen and other disk array management functions, click a disk array from the Launch screen or from one of the array-dependent screens, and then click the **Identity** tab. The Identity screen is displayed.

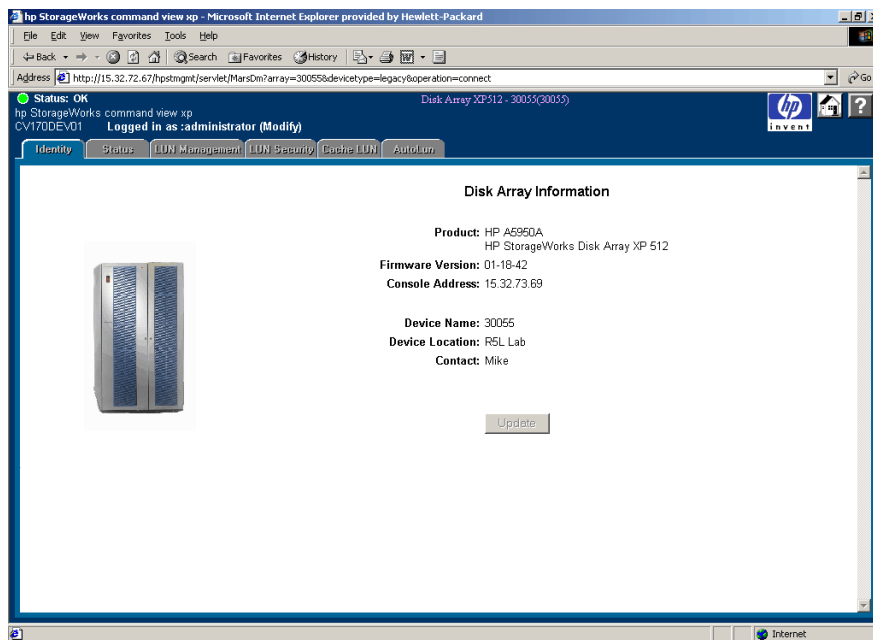
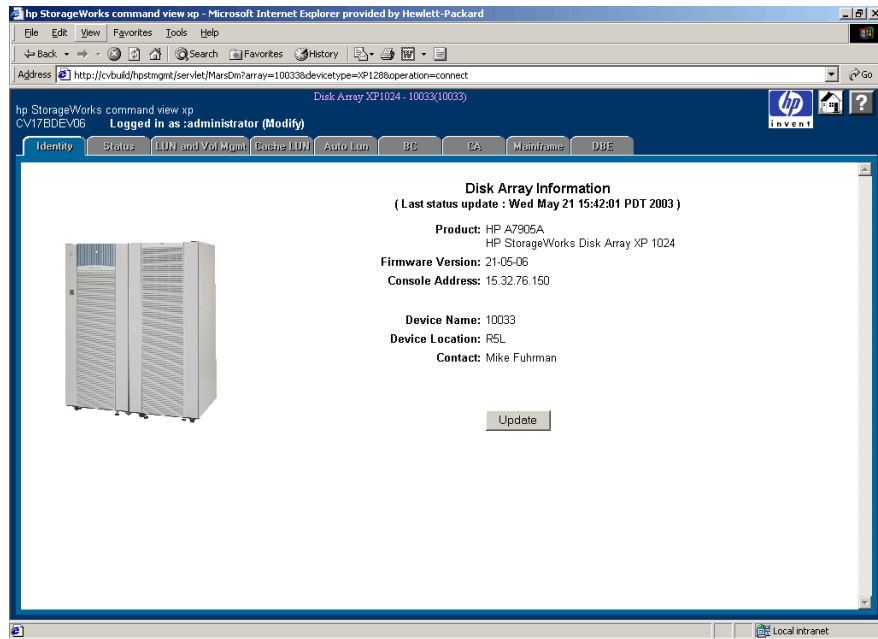


Figure 45: Identity screen (XP512)



**Figure 46: Identity screen (XP1024)**

## Display

The Identity screen consists of the following items:

- **Last status update** (XP128/XP1024 only): The most recent date and time that the information on the Identity screen was updated.
- **Product**: The HP product number for the disk array.
- **Firmware Version**: The version number of the firmware currently loaded on the disk array.
- **Console Address**: The IP address of the disk array.
- **Device Name**: A name for the disk array. You can add or change this using the Device Administration function.
- **Device Location**: The location of the disk array. You can add or change this using the Device Administration function.
- **Contact**: The name of the person to contact with issues regarding the disk array. You can add or change this using the Device Administration function.

- **Update button:** For the XP48/XP256/XP512, this button is available in view mode only. Click this button to display the latest data from the disk array.  
For the XP128/XP1024, clicking this button refreshes the system by copying information from the disk array to a database on the Command View management station.

# Status Monitoring



The Status screens display a comprehensive overview of a selected disk array's configuration and condition. There are ten buttons you use to display ten different status screens.

---

**Note:** Unless otherwise stated, the figures in this chapter reflect the screens of an XP128 or XP1024. There are slight differences in the screens for an XP48, XP256, or XP512, but all differences have been noted in the text.

---

## Accessing the Status Overview Screen

The Status Overview screen summarizes the hardware and storage configuration status for the selected disk array.

To access the status screens, click a disk array listed on the Launch screen, and then click the **Status** tab. The Status Overview screen is displayed.

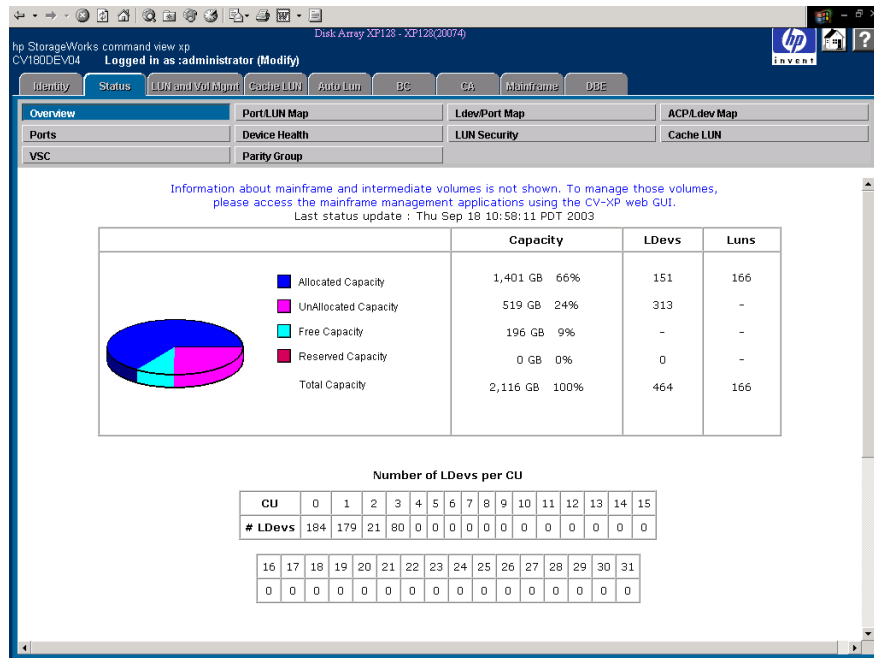


Figure 47: Status Overview screen

To access this screen from one of the other Status screens, click **Overview**.

## Display

### Capacity Table

This table contains a pie chart illustrating the current storage allocation: the allocated, unallocated, free, and reserved capacities. This table also contains columns indicating the capacity in GB and percentage, the number of LDEVs and LUNs, and the amount of cache memory installed by Cache LUN.

The following explains how each type of capacity is determined:

- **Allocated Capacity:** The sum of the capacities of all allocated LDEVs. An LDEV is considered allocated when at least one LUN path is associated with it. If two LUN paths point to the same LDEV, the space on that LDEV is only tallied once.
- **Unallocated Capacity:** The sum of the capacities of all of unallocated LDEVs.
- **Free Capacity:** The sum of all free space in the disk array. This field is not supported for the XP256.
- **Reserved Capacity:** The sum of the capacities of all of reserved LDEVs.
- **Total Capacity:** The sum of the storage capacity of all LDEVs on the system.

#### *LDevs column*

- **Allocated LDEVs:** The number of LDEVs that are associated with LUNs.
- **Unallocated LDEVs:** The number of LDEVs that do not have LUN paths assigned to them.
- **Reserved LDEVs:** The number of LDEVs reserved as Auto LUN reserved volumes for use in LUN migration. This item is displayed only if HP StorageWorks Auto LUN XP is installed.
- **Total LDEVs:** The total number of LDEVs on the disk array.

#### *Luns column*

- **Total LUNs:** The number of LUN paths that have been created.

#### **LDev/CU Table**

The table displays the number of LDEVs associated with each CU.

#### **LDev/ACP Table**

The table displays the number of LDEVs associated with each ACP pair.

#### **Hardware Configuration Table**

The table displays the hardware configuration. The quantity and names for the following hardware elements are displayed.

- Channel Host Interface Processor (CHIP)
- Channel Processor (CHP)
- Array Control Processor (ACP)
- Disaster Recovery and Regeneration Processor (DRR)

## Port/LUN Map Screen

The Port/LUN Map screen displays a map of LUNs configured on each physical disk array port. A LUN may be thought of as a path to a logical device (LDEV).

To access this screen, click the **Status** tab and then click **Port/LUN Map**.

hp StorageWorks command view xp  
CV17BDEV06 Logged in as administrator (Modify)

Overview Port/LUN Map Ldev/Port Map ACP/Ldev Map  
Ports Device Health LUN Security Cache LUN  
VSC Parity Group

Port	Host group	LUN	CU:Ldev
CL1-A	1A-S00	0	0:00
CL1-A	1A-S00	1	0:11
CL1-A	1A-S00	2	0:12
CL1-A	1A-S00	3	0:13
CL1-A	1A-S00	4	0:14
CL1-A	1A-S00	5	0:15
CL1-A	1A-S00	6	0:16
CL1-A	1A-S00	7	0:17
CL1-A	1A-S00	8	0:18
CL1-A	1A-S00	9	0:19
CL1-A	1A-S00	a	0:1a
CL1-A	1A-S00	b	0:0f
CL1-A	1A-S00	c	0:1d
CL1-A	1A-S00	d	0:3d
CL1-A	1A-S00	e	0:1f
CL1-A	1A-S00	f	0:3e
CL1-A	1A-S00	10	0:3f
CL1-A	1A-S00	11	0:23
CL1-A	1A-S00	12	3:40

Last status update : Wed May 21 15:42:01 PDT 2003

Information about mainframe and intermediate volumes is not shown. To manage those volumes, please access the mainframe management applications using the CV-XP web GUI.

Figure 48: Port/LUN Map screen

## Display

The Port/LUN Map screen consists of the following items:

- **Port:** The physical disk array port associated with this LUN.
- **Host Group** (XP128/XP1024 only): The host group, defined using LUN Management, associated with a LUN and LDEV.
- **Scsi ID** (XP48/XP256/XP512 only): The SCSI ID, defined using LUN Management, associated with a LUN and LDEV.
- **LUN:** The LUN ID for the LUN.
- **CU:LDev:** The first logical device associated with the LUN.



- **Save button:** Downloads the information from this screen to a text file.

## Ldev/Port Map Screen

The Ldev/Port Map screen displays a map of LDEVs configured on each physical array port. LDEV configuration details are displayed.

It is possible to configure multiple physical disk array ports to access a single LDEV (by means of a LUN). Depending upon your disk array configuration, the LDev/Port Map display may reference redundant physical ports associated with a single LDEV and LUN.

To access this screen, click the **Status** tab and then click **Ldev/Port Map**.

CU:Ldev	ACP Pair	Parity Group	Vdev	Port	Attribute	Status	Emulation	Size (MB)
0:4b	1	1-6	1	N/A	NOT_EXPANDED	Free	OPEN-9	7042.50
0:4c	1	1-6	1	N/A	NOT_EXPANDED	Free	OPEN-9	7042.50
0:4d	1	1-6	1	N/A	NOT_EXPANDED	Free	OPEN-9	7042.50
0:4e	1	1-6	1	N/A	NOT_EXPANDED	Free	OPEN-9	7042.50
0:4f	1	1-6	1	N/A	NOT_EXPANDED	Free	OPEN-9	7042.50
0:50	1	1-6	1	N/A	NOT_EXPANDED	Free	OPEN-9	7042.50
0:51	1	1-6	1	CL1-E	NOT_EXPANDED	Allocated	OPEN-9	7042.50
0:52	1	1-6	1	CL1-E	NOT_EXPANDED	Allocated	OPEN-9	7042.50
0:60	1,2	1-2	1	CL1-E	NOT_EXPANDED	Allocated	OPEN-E	13893.05
0:61	1,2	1-2	1	CL1-E	NOT_EXPANDED	Allocated	OPEN-E	13893.05
0:62	1,2	1-2	1	CL1-E	NOT_EXPANDED	Allocated	OPEN-E	13893.05
0:63	1,2	1-2	1	CL1-G	NOT_EXPANDED	Allocated	OPEN-E	13893.05
0:64	1,2	1-2	1	CL1-B	NOT_EXPANDED	Allocated	OPEN-E	13893.05
0:65	1,2	1-2	1	CL1-B	NOT_EXPANDED	Allocated	OPEN-E	13893.05
0:66	1,2	1-2	1	CL1-G	NOT_EXPANDED	Allocated	OPEN-E	13893.05
0:67	1,2	1-2	1	CL1-C	NOT_EXPANDED	Allocated	OPEN-E	13893.05
0:68	1,2	1-2	1	CL1-C	NOT_EXPANDED	Allocated	OPEN-E	13893.05
0:69	1,2	1-2	1	CL1-C	NOT_EXPANDED	Allocated	OPEN-E	13893.05
0:6a	1,2	1-2	1	CL1-C	NOT_EXPANDED	Allocated	OPEN-E	13893.05
0:6b	1,2	1-2	1	CL1-E	NOT_EXPANDED	Allocated	OPEN-E	13893.05
0:6c	1,2	1-2	1	CL1-E	NOT_EXPANDED	Allocated	OPEN-E	13893.05

Figure 49: Ldev/Port Map screen

## Display

The Ldev/Port Map screen consists of the following items:

- **CU:Ldev:** The name of the logical device (LDEV). The CU:LDEV name is a combination of control unit (CU) and LDEV.
- **ACP Pair:** The ACP pair associated with this LDEV. If the parity group spans across two ACP pairs, the table displays both pairs. For example: 1,2.

- **Parity Group:** The parity group associated with this LDEV.
- **Vdev:** If applicable, the VDEV associated with this LDEV.
- **Port:** The physical disk array port associated with this LDEV.
- **Attribute:** Indicates whether the LDEV is part of an expanded (LUSE) volume. LUSE functionality is available when the optional Volume Management software is installed. **Normal** indicates that the LDEV is not part of an expanded volume. **Expanded First** indicates that the LDEV is the top element in an expanded volume. **Expanded Element** indicates that the LDEV is part of an expanded volume and is not the first element of the expansion.
- **Status:** **Free** indicates that the LDEV is not allocated. **Allocated** indicates that a LUN has been assigned to the LDEV. **Reserved** indicates that a LUN has not been assigned. The LDEV is reserved for use by the Auto LUN migration function. This condition can occur only when HP StorageWorks Auto LUN XP is installed.
- **Emulation:** The open system emulation mode. This determines the size of the logical device.
- **LdevSize (MB):** The size of the LDEV in megabytes.
- **Save button:** Downloads the information from this screen to a text file.

## ACP/Ldev Map Screen

The ACP/Ldev Map screen displays a list of ACP pairs and their associated LDEVs.

To access this screen, click the **Status** tab and then click **ACP/Ldev Map**.

ACP Pair	CU:LDEV	Parity Group	VDev	Disk Group	Disk Type	Port
1	0:4f	1-6	1	HDU-005 HDU-105 HDU-205 HDU-305	DKS2B-K036FC	N/A
1	0:50	1-6	1	HDU-005 HDU-105 HDU-205 HDU-305	DKS2B-K036FC	N/A
1	0:51	1-6	1	HDU-005 HDU-105 HDU-205 HDU-305	DKS2B-K036FC	CL1-E
1	0:52	1-6	1	HDU-005 HDU-105 HDU-205 HDU-305	DKS2B-K036FC	CL1-E
1,2	0:60	1-2	1	HDU-001 HDU-101 HDU-201 HDU-301 HDU-011 HDU-111 HDU-211 HDU-311	DKS2B-K036FC	CL1-E
1,2	0:61	1-2	1	HDU-001 HDU-101 HDU-201 HDU-301 HDU-011 HDU-111 HDU-211 HDU-311	DKS2B-K036FC	CL1-E
1,2	0:62	1-2	1	HDU-001 HDU-101 HDU-201 HDU-301 HDU-011 HDU-111 HDU-211 HDU-311	DKS2B-K036FC	CL1-E
1,2	0:63	1-2	1	HDU-001 HDU-101 HDU-201 HDU-301 HDU-011 HDU-111 HDU-211 HDU-311	DKS2B-K036FC	CL1-G
1,2	0:64	1-2	1	HDU-001 HDU-101 HDU-201 HDU-301	DKS2B-K036FC	CL1-B

**Figure 50: ACP/Ldev Map screen**

### Display

The ACP/Ldev Map screen consists of the following items:

- **ACP Pair:** The ACP pair number. If the parity group spans across two ACP pairs, the table displays both pairs. For example: 1,2.
- **CU:Ldev:** The LDEV number.
- **Parity Group:** The parity group to which the LDEV belongs.
- **Vdev:** If applicable, the VDEV to which the LDEV belongs.
- **Disk Group:** The physical locations within the disk array that the RAID group occupies.

- **Disk Type:** The physical disk type.
- **Port:** The port associated with the LDEV.
- **Save button:** Downloads the information from this screen to a text file.

## Ports Screen

The Ports screen shows the details of the port configuration. The number of configured ports depends upon the number of I/O boards installed. The ports are displayed in two separate tables. The first table lists all the “CL1” ports and the second table lists all the “CL2” ports. Ports that are not configured are displayed with empty data fields. Also, port speeds are not shown on this screen.

To access this screen, click the **Status** tab and then click **Ports**.

Port CL1	Type	Topology	Loop ID (AL-PA)
A	Fibre	Point-to-Point with Fabric ON	124 (02)
	Host Group		HostMode
	1A-S00	0C	
	narendra	00	
	test2	08	
	cvunix1	00	
	cvunix2	00	
	cvunix3	00	
	cvunix4	00	
	cvunix5	00	
	test	08	
	UCHG0	00	
	naren	00	
B	Fibre	FCAL with Fabric OFF	1 (E8)
	Host Group		HostMode
	1B-G00	00	
	1	00	
	2	00	
	3	00	

**Figure 51: Ports screen**

## Display

The Ports screen consists of the following items:

- **Port:** Port name.
- **Type:** The type of the port is determined by the I/O card associated with the port. Possible values are:
  - **Fibre:** Fibre Channel port
  - **SCSI:** Direct connected or bridge-connected SCSI port

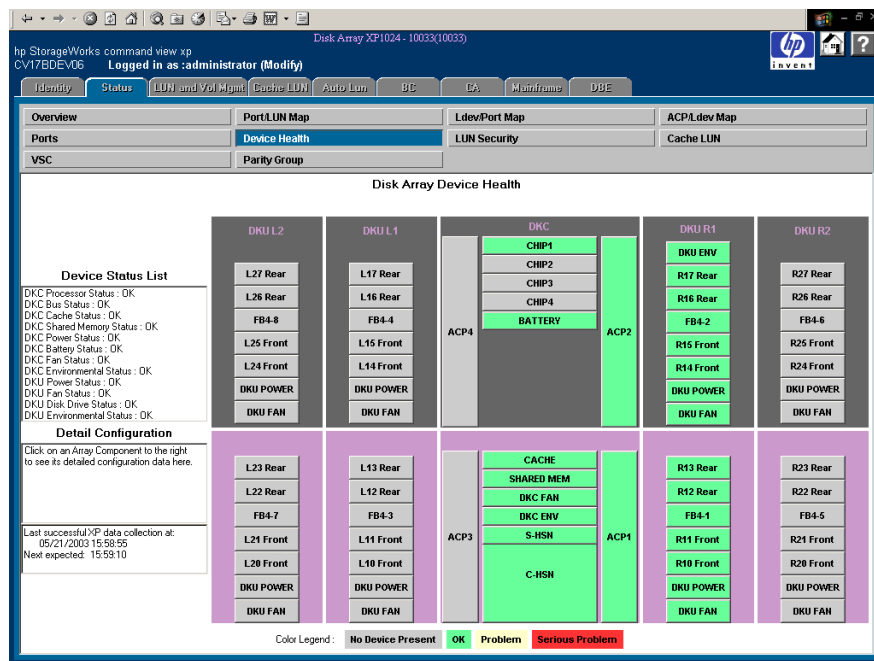
- **Topology:** This field is applicable only to Fibre Channel ports and will be blank for other port types. For HP-UX systems only, the “FCAL with Fabric Off” configuration is supported. Possible values are:
  - **FCAL with Fabric ON:** Fibre Channel Arbitrated Loop with Fabric on
  - **FCAL with Fabric OFF:** Fibre Channel Arbitrated Loop with Fabric off
  - **Point-to-Point with Fabric ON:** Fibre Channel Point-to-Point with Fabric on
  - **Point-to-Point with Fabric OFF:** Fibre Channel Point-to-Point with Fabric off
- **Host Group/Host Mode:** A list of host groups set up for a port, with the corresponding host mode.
- **Loop ID (AL-PA):** The FC-AL loop number and the loop physical address. Loop ID is a value from 0-125 corresponding to the last 8 bits of the node ID for the port. This value is applicable only to Fibre Channel ports.
- **Save button:** Downloads the information from this screen to a text file.

## Device Health Screen

The Device Health screen shows the state of major components in a selected disk array. There is a graphic representation of the disk array hardware and a list of health status conditions. You can quickly monitor the overall status of the disk array, with red or yellow indicating problems and green indicating normal operation.

Both configuration and health information are dynamically and continually updated as long as the Device Health screen remains active in the Command View session.

To access this screen, click the **Status** tab and then click **Device Health**.



**Figure 52: Device Health screen**

Clicking on a component in the picture displays detailed information for the selected component in the **Detail Configuration** text box in the lower-left side of the screen.



## Display

### Legend of status conditions

- **Gray.** No device present. Component is not present or active on this disk array. A maximum configuration would contain this component.
- **Green.** OK. Normal operation status.
- **Yellow.** Problem. A warning or minor problem condition detected.
- **Red.** Serious problem. Serious problem detected.

### Status areas

The major components for which status health is detected and reported in this screen are:

- **DKC Processor Status:** The DKC processors include both the ACP Processor pairs and Channel Host Interface Processor (CHIP)
- **DKC Bus Status:** The bus components are either the set of FBUS-Low, FBUS-High, MBUS-Low, and MBUS-High; or the set of C-HSN and S-HSN
- **DKC Cache Status:** Cache memory
- **DKC Shared Memory Status:** Shared memory
- **DKC Power Status:** AC power
- **DKC Battery Status:** DC backup battery power
- **DKC Fan Status:** Fans in the controller cabinet
- **DKC Environmental Status:** The Environmental Monitor component in the controller cabinet
- **DKU Power Status:** AC power in one or more of the disk cabinets
- **DKU Fan Status:** Fans in one or more of the disk cabinets
- **DKU Disk Drive Status:** One or more disk drives in one or more hard disk unit (HDU) groups in one or more of the disk Unit cabinets
- **DKU Environmental Status:** The Environmental Monitor component in the R1 disk cabinet (to the right of the DKC)

## LUN Security Screen

The LUN Security screen displays the security status of the Fibre Channel ports, and shows associated host groups and host WWNs.

To access this screen, click the **Status** tab and then click **LUN Security**.

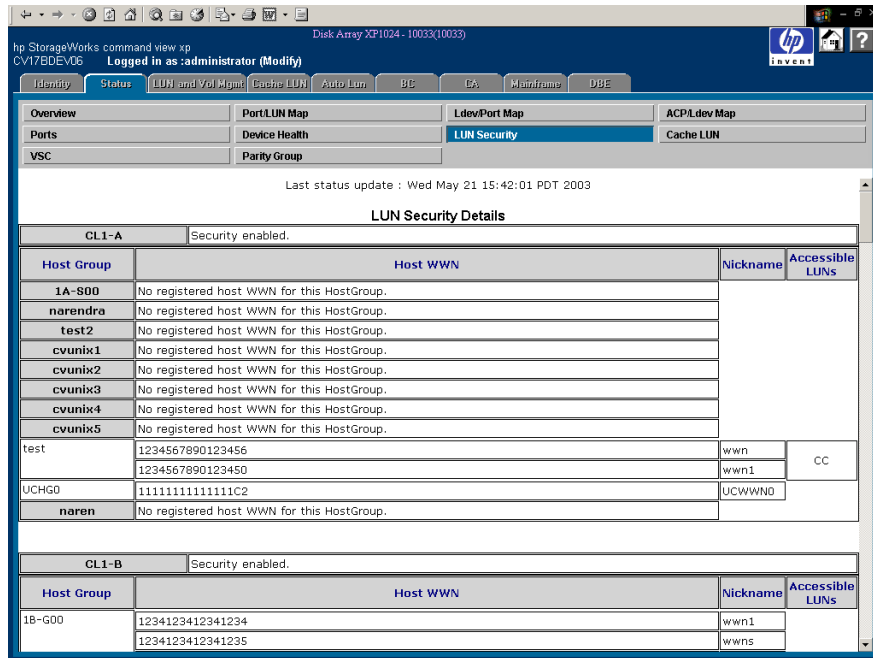


Figure 53: LUN Security screen

### Display

The LUN Security screen consists of the following items:

- **Port Name:** Port name.
- **Security Status:** Port security status can be either “enabled” or “disabled.”
- **Host Group:** If applicable, the host group associated with the port.
- **Host WWN:** The registered host Worldwide Names (WWNs) in the host group.
- **Nickname:** A nickname assigned to the host WWN. If the registered host WWN does not have a nickname, this field is empty.

- **Accessible LUNs:** The LUN IDs for LUNs to which the host group has access.
- **Save button:** Downloads the information from this screen to a text file.

## Cache LUN Screen

The Cache LUN screen displays the LDEVs that have been set up in cache memory as cache LUNs. This screen is not supported for the XP256.

To access this screen, click the **Status** tab and then click **Cache LUN**.

hp StorageWorks command view xp  
CV180DEV04 Logged in as administrator (Modify)

Overview Port LUN Map Ldev/Port Map ACP Ldev Map  
Ports Device Health LUN Security Cache LUN  
VSC Parity Group

Last status update : Thu Sep 18 10:58:11 PDT 2003

Information about mainframe and intermediate volumes is not shown. To manage those volumes, please access the mainframe management applications using the CV-XP web GUI.

<b>Total Cache</b>	2097152 KB
<b>Allocated Cache</b>	104148 KB
<b>Unallocated Cache</b>	1993004 KB

Mode	Start LBA	End LBA	LBA Size	Pre_Staging
BIND	0	255	396	Enabled

Mode	Start LBA	End LBA	LBA Size	Pre_Staging
PRIO	798816	1000031	103752	Enabled

Save

**Figure 54: Cache LUN screen**

## Display

The Cache LUN screen consists of the following items:

- **Total Cache:** The total amount of system cache that has been allocated for use by Cache LUN that may or may not be fully consumed by cache extents.
- **Allocated Cache:** The amount of Cache LUN cache currently allocated to hold any cache extents.
- **Unallocated Cache:** The amount of Cache LUN cache not currently allocated to any cache extents.
- **CU:Ldev:** The LDEV for which cache LUN extents have been set up.
- **Mode:** The modes are Bind mode or Priority mode.

- **Start LBA:** The start logical block address (LBA) for the cache extent.
- **End LBA:** The end LBA for the cache extent.
- **LBA Size:** The size in LBAs of the cache extent. An LBA is 48 KB.
- **Pre-Staging** (XP128/XP1024 only): Indicates whether the extents have been pre-staged.
- **Save button:** Downloads the information from this screen to a text file.

## VSC Screen

The VSC screen displays VSC information for each parity group. This screen is not supported for the XP256.

To access this screen, click the **Status** tab and then click **VSC**.

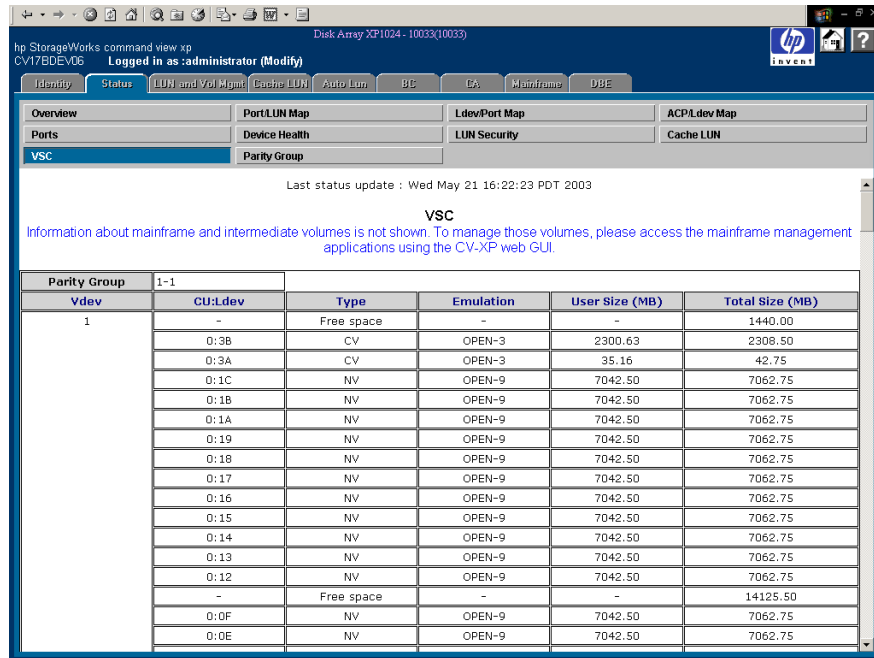


Figure 55: VSC screen

## Display

The VSC screen consists of the following items:

- **VDEV:** If applicable, the VDEV to which the parity group belongs.
- **Parity Group:** The parity group for which the parity group configuration is displayed.
- **CU:Ldev:** The control unit (CU) and logical device (LDEV) associated with the parity group.
- **Type:** If an attribute value is a plus sign (+), the LDEV is part of a path or LU expansion. If the attribute value is “CV,” it is a custom volume. Other possible values include NV (normal volume) and free space.

- **Emulation:** The emulation type of the parity group.
- **User Size:** The space on the LDEV available for storing user data.
- **Total Size:** The total space on the LDEV.
- **Save button:** Downloads the information from this screen to a text file.

## Parity Group Screen

The Parity Group screen displays details about disk array parity groups. This screen is not supported for the XP256.

To access this screen, click the **Status** tab and then click **Parity Group**.

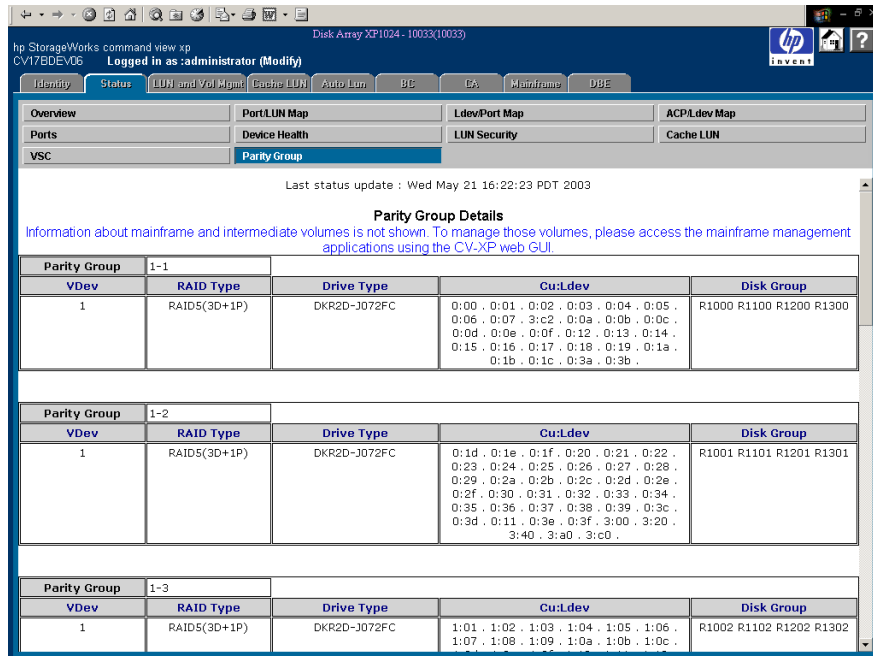


Figure 56: Parity Group screen

## Display

The Parity Group screen consists of the following items:

- **Parity Group:** The parity group for which the parity group configuration is displayed.
- **VDEV:** If applicable, the VDEV to which the parity group belongs.
- **RAID Type:** The parity group’s RAID configuration (2D+2D, 3D+1P, 4D+4D, 7D+1P).
- **Drive Type:** The type of physical drives making up the parity group.
- **Cu:Ldev:** The control unit (CU) and logical devices (LDEVs) associated with the parity group.



- **Disk Group:** The physical locations within the disk array that the parity group occupies.
- **Save button:** Downloads the information from this screen to a text file.



# LUN Management for the XP48/XP256/XP512

## 10

You can use the LUN Management screens to add and delete SCSI or Fibre Channel LUN paths for the disk array. Each LUN can be mapped for access from multiple ports and multiple target IDs to provide alternate paths to promote continuous data availability.

Use LUN Management to reconfigure the SCSI or Fibre Channel paths to accommodate system configuration changes (for example, adding a host) and optimize disk array performance.

Logical unit size expansion (LUSE) creates virtual logical units that are larger than standard LUNs. Volume Size Customization (VSC) creates virtual logical units that are smaller than standard LUNs.

In summary, LUN Management provides the functionality for:

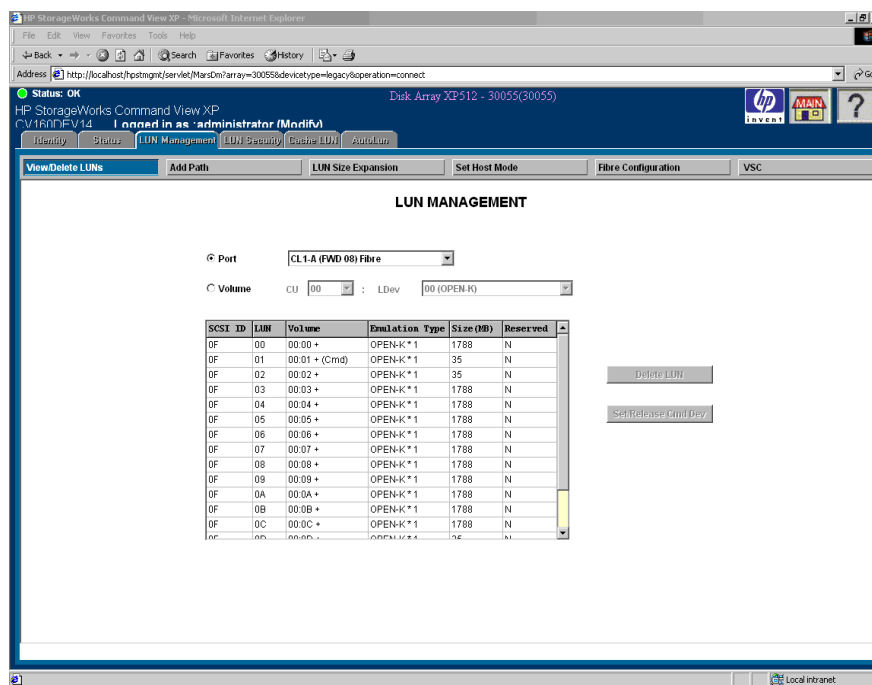
- Viewing SCSI paths (page 146)
- Deleting SCSI paths (page 147)
- Adding SCSI paths (page 148)
- LUN expansion (LUSE) (page 152)
- Setting host modes (page 160)
- Viewing Fibre Channel port configurations (page 164)
- Setting Fibre Channel addresses (page 165)
- Setting a Fibre Channel topology (page 166)
- Configure custom volumes (page 169)

## Starting LUN Management

The LUN Management features are available after accessing a disk array from the main screen.

### To start LUN Management:

1. From the Launch screen, click an XP48, XP256, or XP512.
2. Click the **LUN Management** tab. The LUN Management screen is displayed.



**Figure 57: LUN Management screen**

Click the buttons located below the **LUN Management** tab to perform the following tasks:

- View SCSI and Fibre Channel port paths (see page 146)
- Delete SCSI and Fibre Channel port paths (see page 147)
- Add SCSI and Fibre port paths (see page 148)
- Create virtual LDEVs that are larger than standard OPEN-3/8/9 LDEVs (see page 152)

- Set the host mode (see page 160)
- Configure Fibre ports (see page 164)
- Create virtual LDEVs that are smaller than standard OPEN-3/8/9 LDEVs (see page 169)

## View/Delete LUNs: Viewing SCSI/FC Path Information

The SCSI/FC path configuration for a selected port or volume is displayed in the LUN Management screen. The display shows the SCSI/FC target ID, LUN number, volume (LDEV ID), emulation type, size, and an indication of whether the path is reserved.

### To access SCSI/FC path information:

- After selecting a disk array, click the **LUN Management** tab. The LUN Management screen is displayed. By default, the View/Delete LUNs screen is displayed.

### To view path information for a port:

1. From the LUN Management screen, click **Port**. The **Port** drop-down list is activated.
2. In the **Port** drop-down list, click a port. The list box displays the path information for the selected port.

### To view path information for a volume:

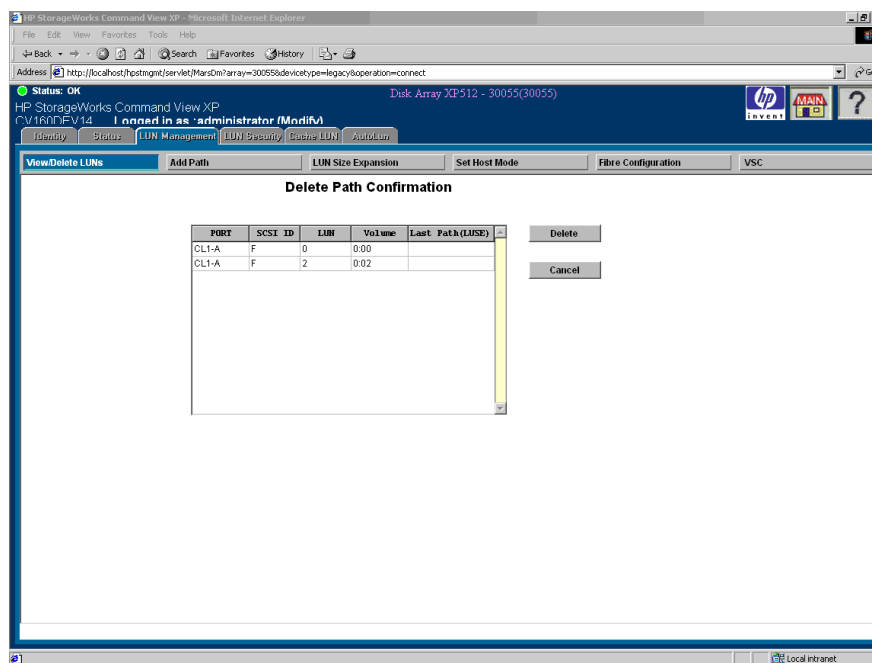
1. From the LUN Management screen, click **Volume**. The **CU** and **LDEV** drop-down lists are activated.
2. In the **CU** drop-down list, click a CU.
3. In the **Ldev** drop-down list, click an LDEV. The list box displays the path information for the selected volume.

## View/Delete LUNs: Deleting SCSI/FC Paths

Use LUN Management to delete SCSI/FC paths to LDEVs in the disk array. Each LDEV can have multiple paths to support high availability.

### To delete SCSI/FC paths:

1. From the LUN Management screen, click the LDEVs whose SCSI/FC paths you want to delete. To make multiple selections, press Ctrl or Shift while clicking.
2. Click **Delete LUN**. The Delete Path Confirmation screen displays the path(s) you selected to delete.



**Figure 58: Delete Path Confirmation screen (LUN Management screen)**

3. Click **Delete**. A confirmation dialog box is displayed. If the information is not correct, click **Cancel** to return to the LUN Management screen.
4. Click **OK** to confirm. The selected paths are deleted.

## Add Path: Adding SCSI/FC Paths

The Add Path LUN Management function adds SCSI/FC paths to LDEVs in the disk array. Each LDEV can be mapped from multiple SCSI ports to provide alternate path high availability.

Before assigning a SCSI path to an LDEV, make sure that the LDEV is not an Auto LUN reserved device. The Add Path screen does not display reserved volumes. You must use Auto LUN to verify the reserve status of the LDEVs. If the volume has been reserved, it is write-protected and any writes to that volume will fail.

### To add SCSI/FC paths:

1. From the LUN Management screen, click **Add Path**. The Add Path screen displays the SCSI/FC paths that have already been assigned.

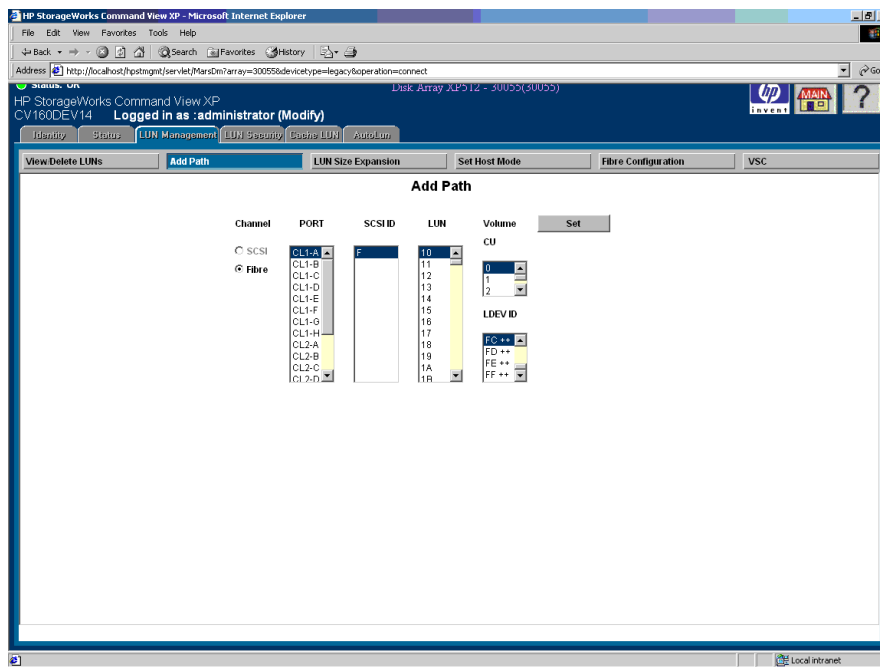


Figure 59: Add Path screen

2. Click either **SCSI** or **Fibre** under Channel in the Add Path screen.



3. Click the ports, target SCSI IDs, LUN IDs you want to assign, and then click the corresponding CU and LDEV IDs.

To calculate the number of LUNs to select, multiply the number of selected SCSI IDs by the number of selected LUN IDs. For example, if you select four SCSI IDs and two LUN IDs, you must select eight LUNs ( $4 \times 2 = 8$ ).

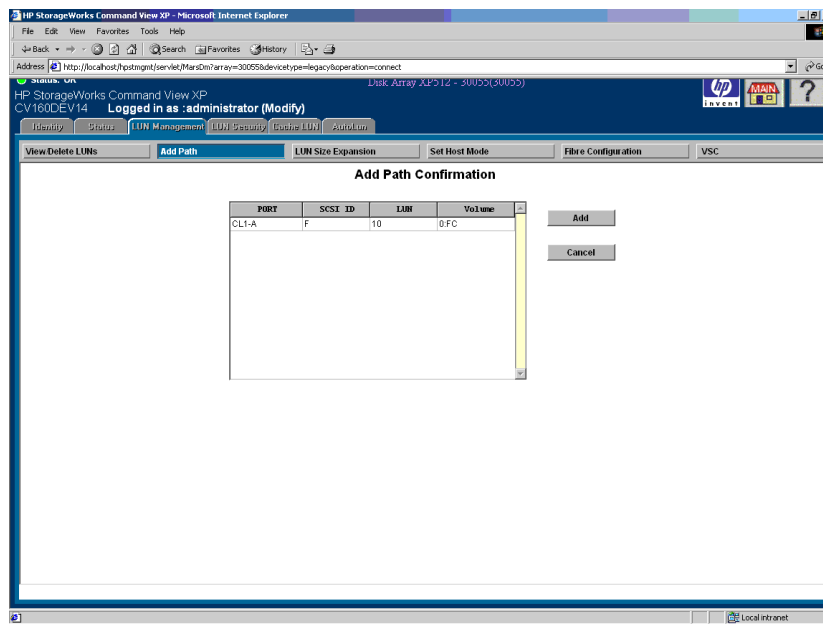
You can define paths individually (individual mode), in a group (bulk mode), or randomly (random mode).

**Individual Mode:** Click PORT, SCSI ID, and LUN one by one for each LDEV ID.

**Bulk Mode:** Click the first LDEV ID. LUN Manager assigns the remaining paths sequentially. You can also click the number of LDEV IDs you want to assign. A bulk mode operation fails if the number of LUNs defined exceeds the number of LDEVs available.

**Random Mode:** Click the LDEV IDs randomly and the items will be assigned in numerical order. For example, if you click LDEV IDs 07, 00, 0F, 01, and 0A, the LDEVs are assigned in the following order: 00, 01, 07, 0A, and 0F.

4. Click **Set**. The Add Path Confirmation screen displays all of the paths you are adding.



**Figure 60: Add Path Confirmation screen**

5. Click **Add**. A confirmation dialog box is displayed.  
If the information is not correct, click **Cancel** to return to the Add Path screen.
6. Click **OK** to confirm. The selected paths are added.

## Display

The Add Path screen consists of the following items:

- **Channel:** Option buttons for selecting the type of path you are adding, SCSI or Fibre Channel.
- **PORT:** Displays the assigned SCSI or Fibre Channel ports.
- **SCSI ID:** Clicking **SCSI** displays all of the allowed values for SCSI IDs. Clicking **Fibre** displays only one SCSI ID (F).
- **LUN:** Clicking **SCSI** displays all of the allowed values for LUN number. Clicking **Fibre** displays LUN values from 0 through 119 (0 to 77 in hexadecimal).
- **CU:** Displays all of the CU numbers available in the disk array. The first CU number is selected by default.

- **LDEV ID:** Displays all of the LDEVs for the selected CU. A single plus sign (+) indicates that one path is defined for that LDEV. Two plus signs (++) indicate that multiple paths are defined for that LDEV.
- **Set button:** Confirms and saves the selected path.

## LUN Size Expansion (LUSE)

The LUN Size Expansion process creates virtual LDEVs that are larger than standard OPEN-3/8/9 LDEVs. This capability enables hosts to access the data on the disk array using fewer logical units.

You can perform these LUN expansion functions:

- View expanded LUN information (page 154)
- Create expanded LUNs (continuous mode) (page 155)
- Create expanded LUNs (disperse mode) (page 157)

The following tables list LUN size limitations.

**Table 3: LUN size limitations for OPEN-3, OPEN-8, and OPEN-9 (XP48/XP256/XP512)**

Parameter	OPEN-3	OPEN-8	OPEN-9
Size of LUNs	2.4 GB	7.3 GB	7.3 GB
Possible number of LDEVs in expanded volume	2 to 36 LDEVs	2 to 36 LDEVs	2 to 36 LDEVs
Volume of expanded LUNs	4.8 GB to 86.4 GB	14.6 GB to 262.8 GB	14.6 GB to 262.8 GB
Display designation ( $n$ = number of LUs in the expanded LUN)	OPEN-3* $n$	OPEN-8* $n$	OPEN-9* $n$

**Table 4: LUN size limitations for OPEN-3 VSC, OPEN-8 VSC, and OPEN-9 VSC (XP48/XP256/XP512)**

Parameter	OPEN-3 VSC	OPEN-8 VSC	OPEN-9 VSC
Size of LUNs	35 MB to 2.3 GB	35 MB to 6.9 GB	35 MB to 7.0 GB
Possible number of LDEVs in expanded volume	2 to 36 LDEVs	2 to 36 LDEVs	2 to 36 LDEVs
Volume of expanded LUNs	70 MB to 84.2 GB	70 MB to 250.2 GB	70 MB to 252.6 GB
Display designation ( $n$ = number of LUs in the expanded LUN)	OPEN-3* $n$ VSC	OPEN-8* $n$ VSC	OPEN-9* $n$ VSC

Note the following limitations:

- You cannot join LDEVs on different control units into an expanded LUN.
- The LDEVs you join must be in sequential order.

- Windows NT cannot use more than 32 logical units.
- Some operating systems may experience slow disk access times with large logical units.

## Starting LUN Size Expansion

To start LUN size expansion:

- From the LUN Management screen, click **LU Size Expansion**. The LUN Expansion Main screen displays the LUNs defined in the disk array.

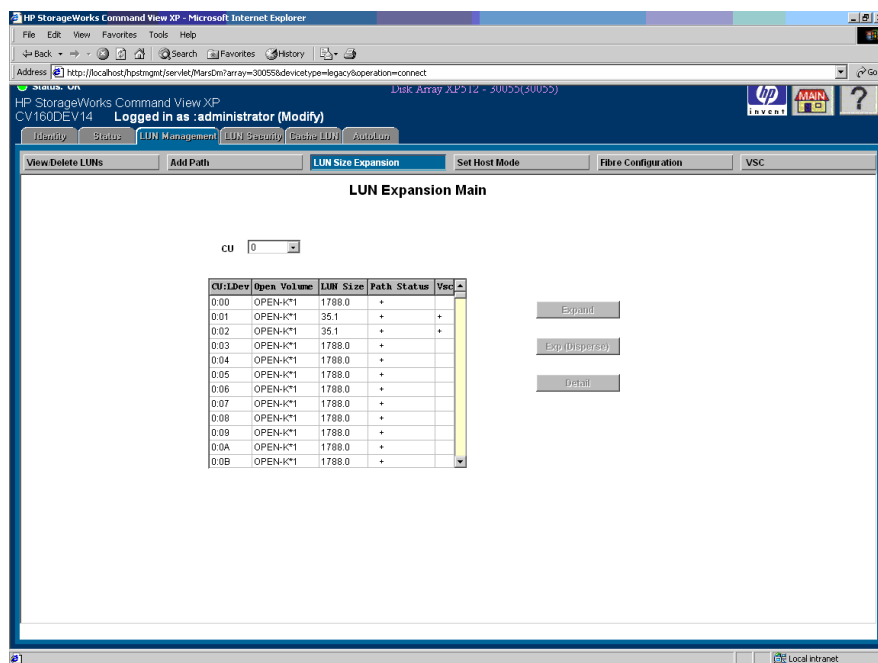


Figure 61: LUN Expansion Main screen

## Display

The LUN Expansion Main screen consists of the following items:

- **CU:** Used to select a CU. The list box displays the volumes corresponding to the selected CU.
- **CU:LDEV:** CU:LDEV displays the LUNs in the CU selected in the CU list.

- **Open Volume:** Open Volume displays the emulation type of the LUN followed by the number of LDEVs that are part of any expanded LUN. If the LUN is not expanded, the number of LDEVs displayed is 1.
- **LUN Size:** Size displays the size of the LUN.
- **Path Status:** A “+” will be displayed if there is at least one path to the LUN defined.
- **VSC:** VSC displays a “+” if this LUN is a custom volume.
- **Expand button:** Click **Expand** to display the LUN Expansion Continuous screen. This button is enabled only when a LUN is selected for expansion. The selected LUN should have continuous LDEVs available for expansion and there should be no path defined for the LUN.
- **Expand (Disperse) button:** Click **Expand (Disperse)** to display the LUN Expansion Disperse screen. This button is enabled only when a LUN is selected for expansion. The selected LUN should not have continuous LDEVs available for expansion and there should be no path defined for the LUN.
- **Detail button:** Click **Detail** to display the LUN Expansion Detail screen, which displays the LDEVs that are part of the expanded LUN. This button is enabled when a LUN is selected.

## Viewing Expanded LUN Information: Detail Screen

### To display LUN expansion detail information:

1. From the LUN Management screen, click **LUN Size Expansion**. The LUN Expansion Main screen is displayed.
2. In the **CU** drop-down list, click the CU you want to view.
3. In the list box, click the LUN you want to view.
4. Click **Detail**. The LU Expansion Detail screen is displayed.

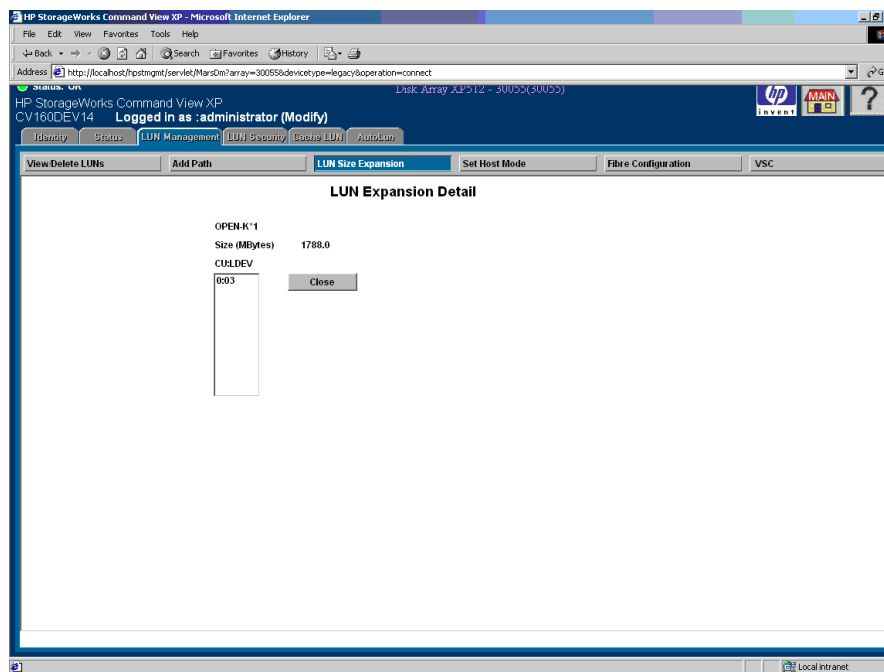


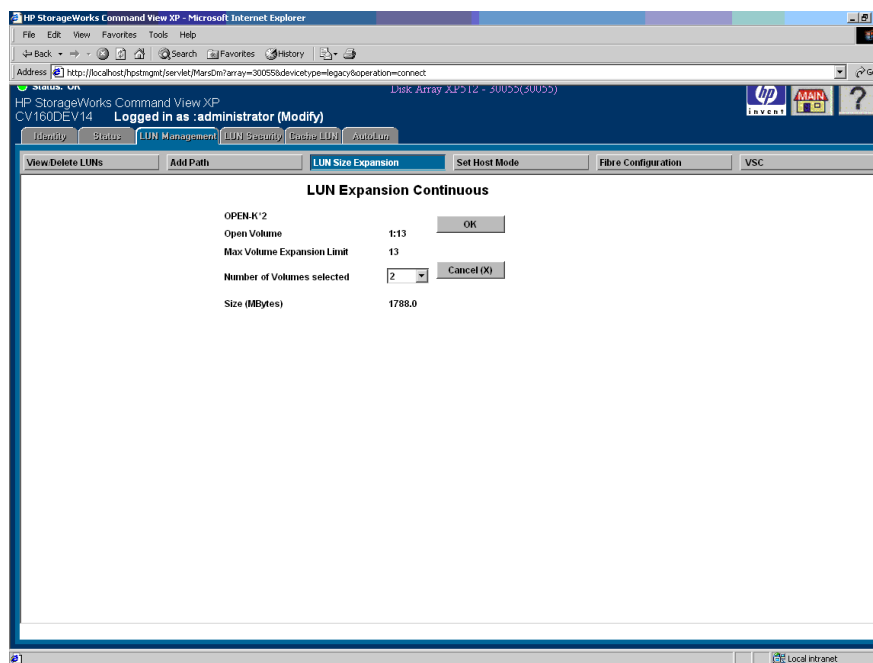
Figure 62: LUN Expansion Detail screen

5. Click **Close** to return to the LUN Expansion Main screen.

## Creating Expanded LUNs (Continuous)

### To create expanded LUNs (continuous mode):

1. From the LUN Management screen, click **LUN Size Expansion**. The LUN Expansion Main screen is displayed.
2. In the **CU** drop-down list, click the CU for the LDEVs you want to expand.  
The list box displays the LDEVs for the selected CU. If a “+” is displayed under the path listing, this indicates that the path has already been set. If a LUN has a path assigned, it cannot be expanded. Delete paths before expanding.
3. In the list box, click the LDEVs you want to expand.
4. Click **Expand**. The LUN Expansion Continuous screen is displayed.



**Figure 63: LUN Expansion Continuous screen**

5. In the **Number of Volumes Selected** drop-down list, click the size of the expanded LUN.
6. Click **OK** to expand the LUN. The LUN Expansion Confirmation screen is displayed. Click **Cancel (X)** to return to the LUN Expansion Main screen.
7. Click **Confirm**. The Add Path screen is displayed.

In the Add Path screen, you can associate a path with the expanded LUN. If you do not add a path for the expanded LUN, the expansion does not occur. Click **Cancel (X)** to return to the LUN Expansion Confirmation screen.

## Display

The LUN Expansion Continuous screen consists of the following items:

- **OPEN-X\*n**: Displays the emulation type. Available LUNs are displayed as OPEN-X\*1, indicating that only one LUN is present. Volumes that have already been expanded are displayed as OPEN-X\*n, where *n* is the number of LUNs present.

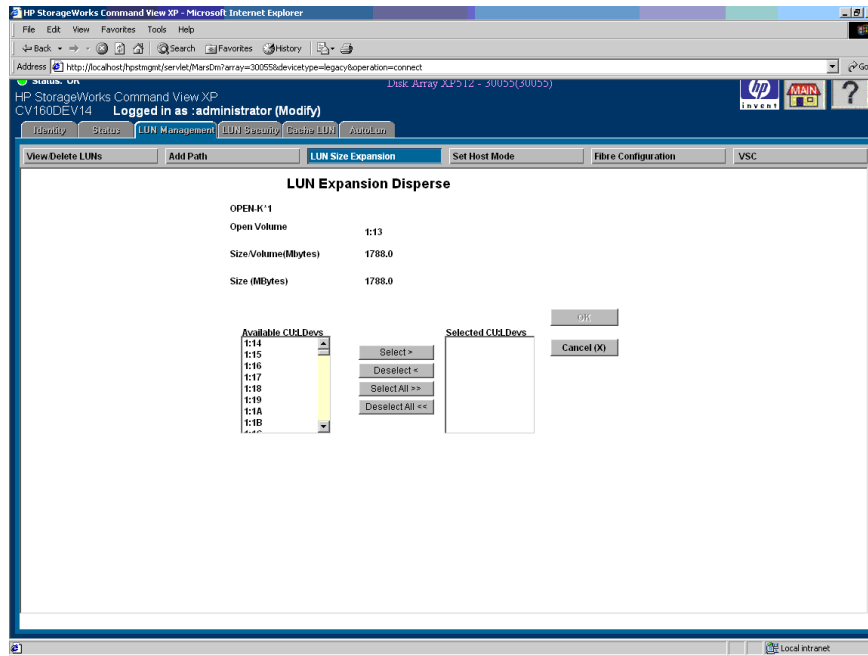


- **Open Volume:** The CU/LDEV that will be the first or (“top”) LUN after expansion.
- **Max Volume Expansion Limit:** The number of available LUNs to combine.
- **Number of Volumes selected:** The number of volumes to combine.
- **Size (MBytes):** The capacity of the expanded volume to be created.

## Creating Expanded LUNs (Dispersed)

### To create expanded LUNs (disperse mode):

1. From the LUN Management screen, click **LUN Size Expansion**. The LUN Expansion Main screen is displayed.
2. In the **CU** drop-down list, click the CU for the LDEVs you want to expand. The list box displays the LDEVs for the selected CU. If a “+” is displayed under the path listing, this indicates that the path has already been set. If a LUN has a path assigned, it cannot be expanded. Delete paths before expanding.
3. In the list box, click the first LDEV in the series of LUNs you want to expand.
4. Click **Exp(Disperse)**. The LUN Expansion Disperse screen is displayed.



**Figure 64: LUN Expansion Disperse screen**

5. In the **Available CU:LDEV** list box, click a volume and then click **Select**. To select all of the volumes, click **Select All**. The **Selected CU:LDEV** list box displays the selected volumes.
6. Click **OK** to expand the LUN. The LUN Expansion Confirmation screen is displayed. Click **Cancel (X)** to return to the LUN Expansion Main screen.
7. Click **Confirm**. The Add Path screen is displayed.

In the Add Path screen, you can associate a path with the expanded LUN. If you do not add a path for the expanded LUN, the expansion does not occur. Click **Cancel(X)** to return to the LUN Expansion Confirmation screen.

## Display

The LUN Expansion Disperse screen consists of the following items:

- **OPEN-X\*n**: The emulation type. All available LUNs are displayed as OPEN-X\*1, indicating that only one LUN is present. Volumes that have already been expanded are displayed as OPEN-X\*n, where *n* is the number of LUNs present.

- **Open Volume:** The selected volume.
- **Size/Volume (Mbytes):** The size per volume of the emulation type.
- **Size (MBytes):** The size of the expanded LUN.
- **Available CU:LDEV:** List of available volumes.
- **Selected CU:LDEV:** List of the selected volumes.

## Host Modes

Use LUN Management to manage the host modes for SCSI and Fibre Channel ports on the disk array. This feature can display and set the host mode. Host modes are specified by number.

**Table 5: Host modes (fast-wide and Fibre Channel support for the XP48/XP256/XP512)**

Host Mode	Fast-Wide Differential Support (XP256 only) Fibre Channel Support
00	Standard
03	Reserved
04	Sequent
05 - 07	Reserved
08	HP-UX
09	VxVM-DMP
0A	NetWare
0C	MS Cluster Server
0D - 0F	Reserved

**Table 6: Host modes (ultra SCSI support for the XP256 only)**

Host Mode	Ultra SCSI Support (XP256 only)
10	Standard
11	IBM-7135
12	NCR
13	Reserved
14, 15	Sequent
16, 17	Reserved
18	HP-UX
19	VxVM-DMP
1A	NetWare

**Table 6: Host modes (ultra SCSI support for the XP256 only) (Continued)**

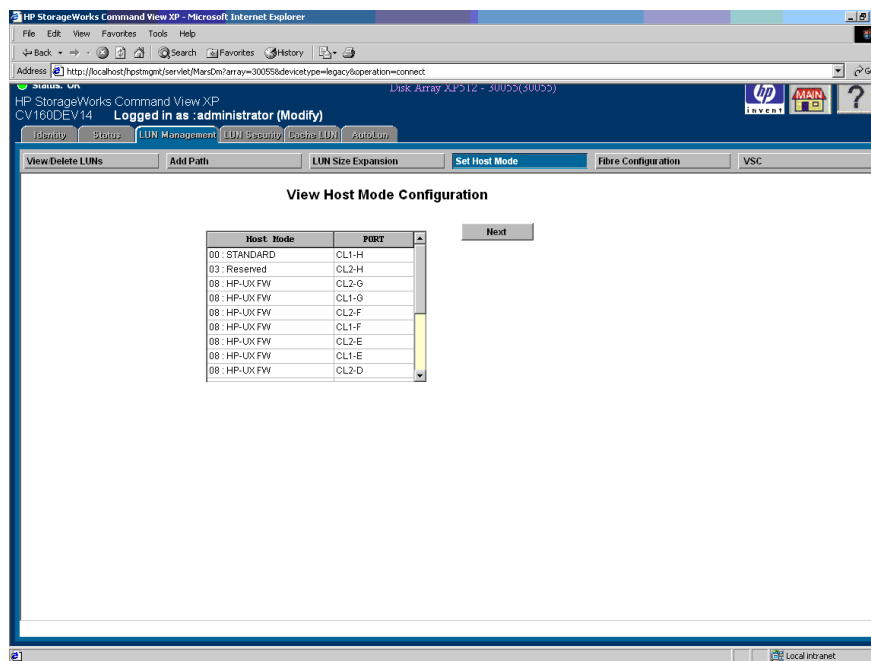
Host Mode	Ultra SCSI Support (XP256 only)
1B	MPE/iX
1C	MS Cluster Server
1D, 0E, 0F	Reserved

## Viewing the Host Mode Configuration

The View Host Mode Configuration screen displays the ports and their host modes in a scrollable box, sorted by host mode.

**To view host mode configurations:**

- From the LUN Management screen, click **Set Host Mode**. The View Host Mode Configuration screen is displayed.

**Figure 65: View Host Mode Configuration screen**

## Display

In addition to Host Mode and PORT columns, the View Host Mode Configuration screen also has of the following item:

- **Next button:** Displays a screen where you can set host modes.

## Setting or Changing the Host Mode

The Host Mode Configuration screen is used to set or change host mode and port configurations.

**To set or change host mode configurations:**

1. From the LUN Management screen, click **Set Host Mode**. The View Host Mode Configuration screen is displayed.
2. Click **Next** on the View Host Mode Configuration screen. The Host Mode Configuration screen is displayed.

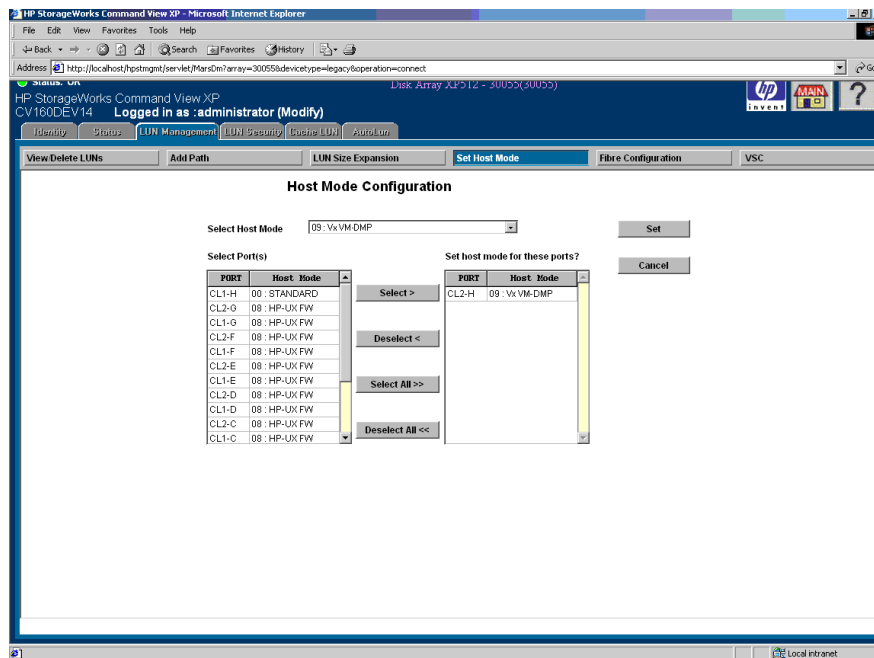


Figure 66: Host Mode Configuration screen

3. In the **Select Host Mode** drop-down list, click the host mode. Each host mode is represented by its host mode number and a descriptive name.
4. In the **Select Port(s)** box, click the ports and then click **Select**. To select all the ports, click **Select All**.

The available ports that are listed are all the available ports in the disk array and the current host mode setting.

The **Set host mode for these ports?** box on the right side of the screen displays the selected ports for the selected host mode.

*(Optional)* If you want to reverse a selected host mode and port combination, click the combination in the **Set host mode for these ports?** box and then click **Deselect**. To reverse all of the selected host mode and port combinations, click **Deselect All**. The deselected port names are moved from the **Set host mode for these ports?** box to the **Select Port(s)** box.

5. Click **Set**. A confirmation dialog box is displayed. To cancel any changes and return to the View Host Mode Configuration screen, click **Cancel**.
6. Click **OK** to confirm. The selected values are set and the data on the screen is updated.

## Configuring Fibre Channel Ports

Fibre Channel configuration includes viewing and setting the port address and topology for Fibre Channel ports.

### Viewing the Fibre Channel Port Configuration

To view the Fibre Channel port configuration:

1. From the LUN Management screen, click **Fibre Configuration**. The View Fibre Port Configuration screen displays the port address or topology for Fibre Channel ports.

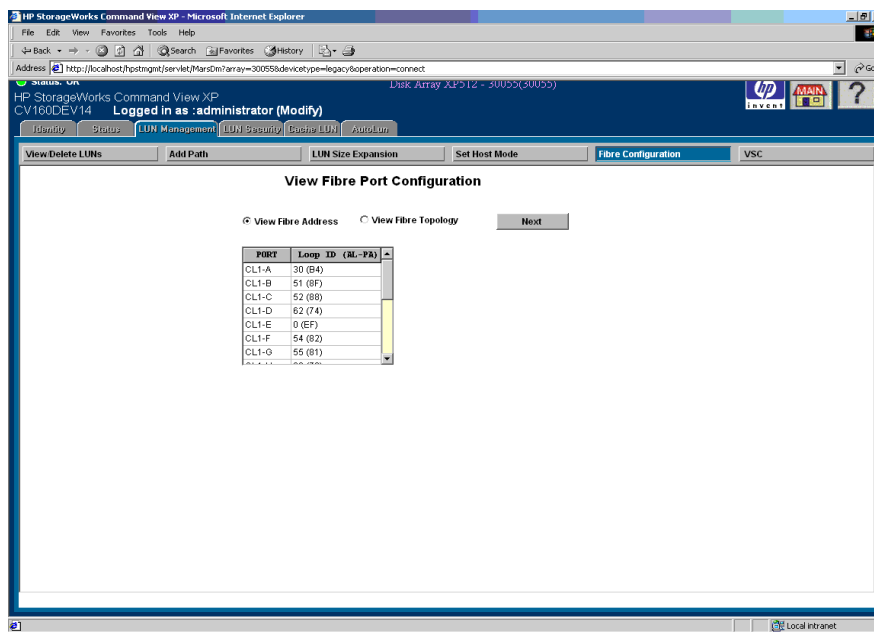


Figure 67: View Fibre Port Configuration screen

2. To display the port names (PORT) and their addresses (Loop ID (AL-PA)) in the list box, click **View Fibre Address**.

To display the port names (PORT) and their topology (Fabric and Connection) information, click **View Fibre Topology**. The possible values for Fabric and Connection are ON/OFF and FC-AL/Point-to-Point respectively.

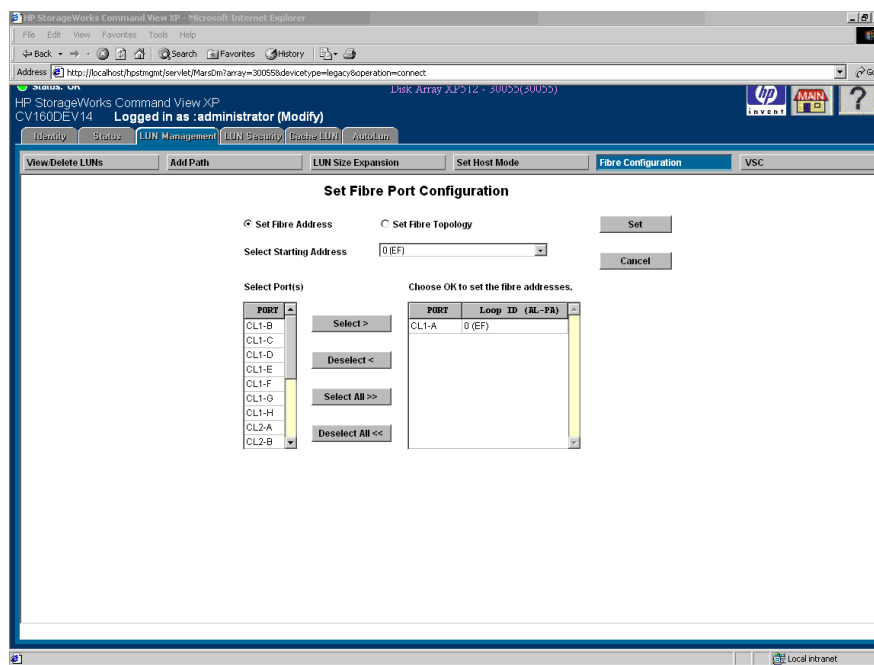


3. Click **Next** to set or modify the address and topology information for a Fibre Channel port.

## Setting or Changing Fibre Channel Port Addresses

To set or change a Fibre Channel port address:

1. From the LUN Management screen, click **Fibre Configuration** on the LUN Management screen. The View Fibre Port Configuration screen is displayed.
2. Click **Next** on the View Fibre Port Configuration screen. The Set Fibre Port Configuration screen is displayed.



**Figure 68: Setting a Fibre Channel port address (Set Fibre Port Configuration screen)**

3. Click **Set Fibre Address**, if not already selected by default.
4. In the **Select Starting Address** drop-down list, click the starting address. This has a range from 0 to 125.
5. In the **Select Port(s)** box, click the port. You can select multiple ports.
6. Click **Select**. To select all of the available ports, click **Select All**.

The **Choose OK to set the fibre addresses** box displays the selected ports. The selected ports will have addresses assigned starting with the address selected in the **Select Starting Address** drop-down list.

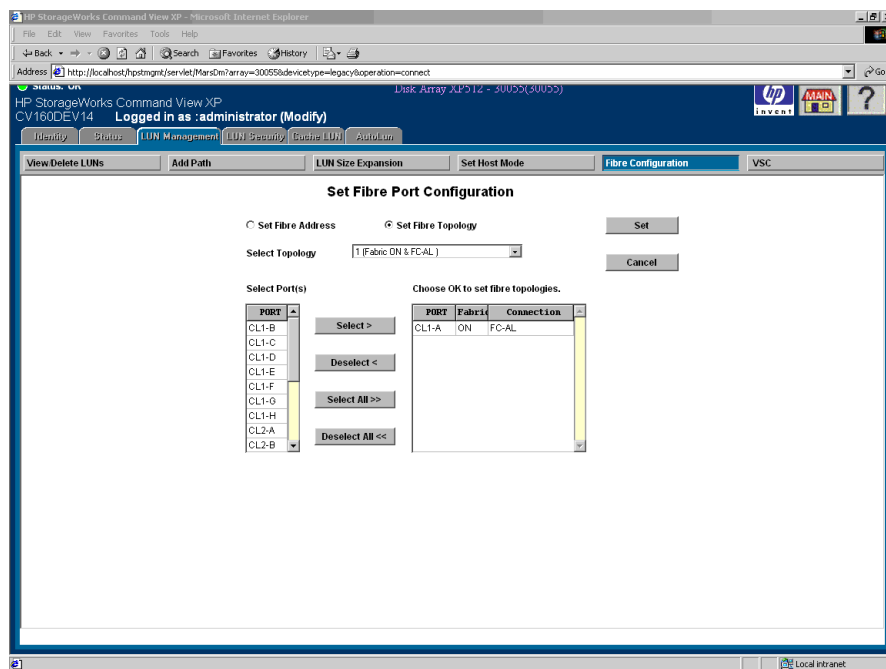
*(Optional)* If you want to reverse the selection of Fibre Channel port addresses, click the ports in the **Set the following fibre addresses?** list box and then click **Deselect**. To reverse the selection of all of the selected Fibre Channel port addresses, click **Deselect All**. The deselected port addresses are moved from the **Set the following fibre addresses?** list box to the **Select Port(s)** box.

7. Click **Set**. A confirmation dialog box is displayed. Click **Cancel** to cancel your selections and return to the View Fibre Port Configuration screen.
8. Click **OK** to confirm. The new addresses are set and the data on the screen is updated.

## Setting or Changing Fibre Channel Port Topology

**To set or change a Fibre Channel port topology:**

1. From the LUN Management screen, click **Fibre Configuration**. The View Fibre Port Configuration screen is displayed.
2. Click **Next** on the View Fibre Port Configuration screen. The Set Fibre Port Configuration screen is displayed.
3. Click **Set Fibre Topology**.



**Figure 69: Setting a Fibre Channel topology (Set Fibre Port Configuration screen)**

4. In the **Select Topology** drop-down list, click the topology. You can select only one topology at a time.
5. In the **Select Port(s)** box, click the port. You can select multiple ports.
6. Click **Select**. To select all the available ports, click **Select All**.

The **Choose OK to set fibre topologies** list box displays the selected ports. The topology selected in the **Select Topology** drop-down list is assigned to each of the selected ports.

(Optional) If you want to reverse the selected Fibre Channel port topologies, click the ports in the **Choose OK to set fibre topologies** list box and then click **Deselect**. To reverse all of the selected Fibre Channel port topologies, click **Deselect All**. The deselected port topologies are moved from the **Set the following fibre topologies?** list box to the **Select Port(s)** box.

7. Click **Set**. A confirmation dialog box is displayed. Click **Cancel** to cancel your selections and return to the View Fiber Port Configuration screen.

8. Click **OK** to confirm. The new addresses are set and the data on the screen is updated.

## Volume Size Configuration

The Volume Size Configuration (VSC) process configures custom volumes (CVs) that are smaller than normal volumes. Custom volumes improve data access performance by reducing logical device contention as well as host I/O queue times, which can occur when several frequently accessed files are located on the same volume.

If you have several frequently-accessed files on the same LDEV, you can use VSC to set up smaller “separate” custom volumes for them. This should reduce conflicts and improve performance.

A small custom volume can also be useful for a command device. This leaves the rest of the LDEV free for other uses.

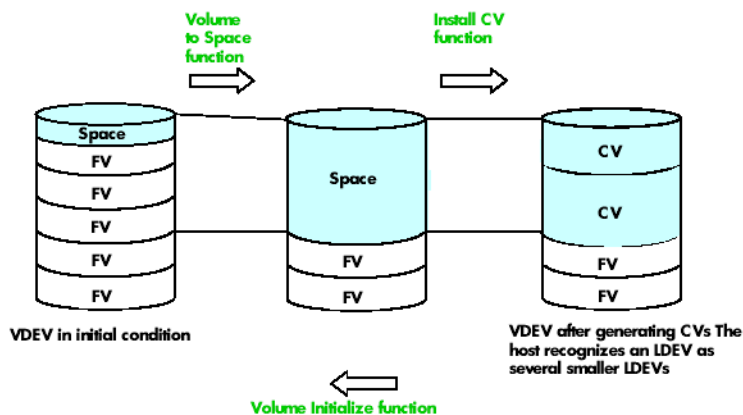
## VSC Functions

VSC functions include:

- Converting a normal volume to VSC space (page 174)
- Installing a CV (page 178)
- Deinstalling a CV (page 181)
- Converting a custom volume to a normal (or “fixed”) volume (page 183)

The first step in creating custom volumes is to define a custom volume using the Normal-to-VSC conversion process. When you convert a normal volume to a VSC volume, all of the logical blocks in the volume are reformatted for use in custom volumes. You can then extend the VSC volume using the install custom volumes process.

When you no longer require a VSC volume, use the Volume to Space process to convert it to a normal volume.



**Figure 70: VSC functions**

Note that a fixed volume (FV) is the same as LDEV.

## VSC Limitations

- On an XP256, if you format a parity group into an fixed volume, the extra space remaining after you format the disk is lost. When you convert to a custom volume, the usable space does not include that extra space.
- LUSE, LUN Security, and LDEV Security volumes are not available for VSC operations.
- When space is converted to a custom volume, an LDEV address is assigned to that custom volume automatically. For mainframes, each custom volume will also have its own assigned unit control block (UCB). The UCB can be assigned either automatically or manually, at the user's option.
- The VSC function is destructive. Be sure to back up your data before performing VSC operations.

## VSC Specifications

The following table lists the custom volume specifications. Each custom volume has its own assigned unit control block (UCB), and multiple custom volume types can be configured within each parity group. Add and delete custom volumes at any time. The administrator may control the emulation type associate with each custom volume.

**Table 7: VSC specifications (XP48/XP256/XP512)**

Parameter	Specification
Emulation type	OPEN-3/8/9/E/K
Minimum size of a custom volume	35 MB
Maximum size of a custom volume	OPEN-3: 2.4 GB OPEN-8: 7.3 GB OPEN-9: 7.3 GB OPEN-E: 13.5 GB OPEN-K: 1.75 GB
Size increment	1 MB
Maximum number of volumes (custom and normal) per parity group	124
Maximum number of volumes (custom and normal) per disk array	4096
Control (overhead) capacity required per custom volume	OPEN-3: 5.6 MB OPEN-8: 19 MB OPEN-9: 19 MB OPEN-E: 13.3 MB OPEN-K: 6.4 MB

Volumes are composed of 512-byte pieces called logical blocks. Logical block addresses (LBAs) are used for referring to locations within volumes. Use the following table when you configure custom volumes.

**Table 8: Volume types, logical blocks, and capacities (XP48/XP256/XP512)**

Volume Type	Logical Blocks	Capacity (GB)	Capacity (GB)
OPEN-3	4,806,720	2.461 GB	2.292 GB
OPEN-8	14,423,040	7.384 GB	6.877 GB
OPEN-9	14,423,040	7.384 GB	6.877 GB
OPEN-E	28,452,960	14.226 GB	13.567 GB
OPEN-K	3,661,920	1.83096 GB	1.746 GB

## Starting VSC

### To start VSC:

- From the LUN Management screen, click **VSC**. The Volume Size Configuration (Main Screen) screen is displayed.

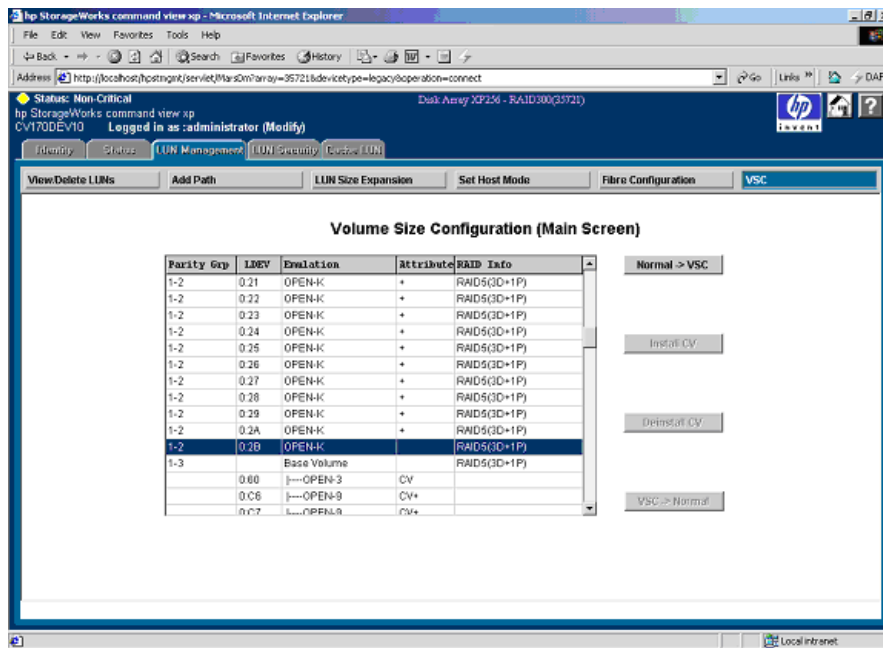


Figure 71: Volume Size Configuration (Main Screen) screen (XP256)



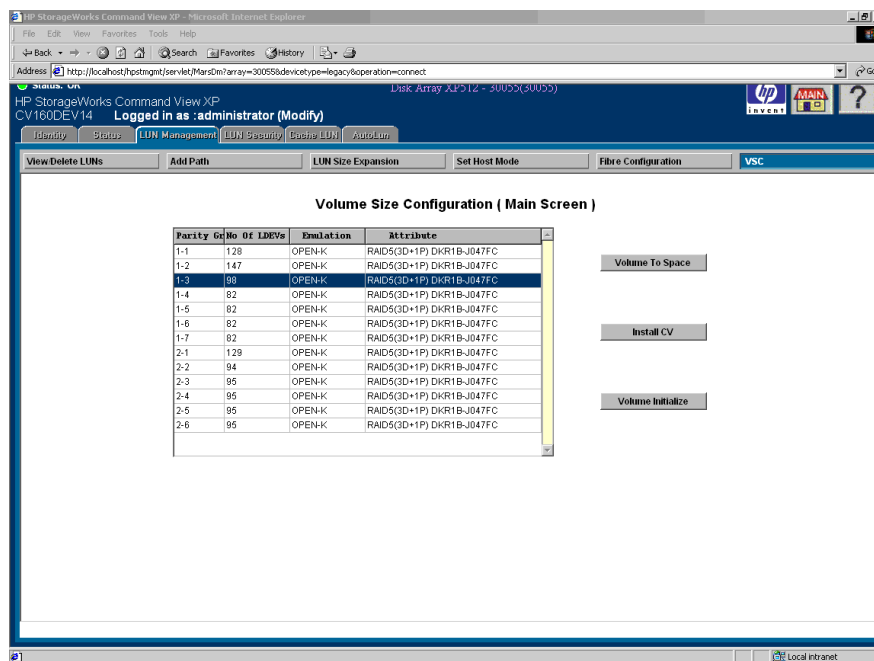


Figure 72: Volume Size Configuration (Main Screen) screen (XP48/XP512)

## Display

The Volume Size Configuration (Main Screen) screen consists of the following items:

- **List box:** Displays the parity group configuration of each CU, including the number of LDEVs, emulation type, RAID level, and HDD designation of each parity group.

If an attribute value is a plus sign (+), the LDEV is part of a SCSI path or LUSE expanded volume. If the attribute value is CV, then it is a custom volume.

- **Normal -> VSC button (XP256) or Volume To Space button (XP48/XP512):** Converts a normal volume to a VSC volume.
- **Install CV button:** Adds a new custom volume.
- **Deinstall CV button (XP256 only):** Uninstalls one or more custom volumes.
- **VSC -> Normal button (XP256) or Volume Initialize button (XP48/XP512):** Converts a VSC volume back to a normal volume.

## Converting a Normal Volume to VSC Space

Before you can configure custom volumes, you must use the Volume to Space process to convert a normal volume to a VSC volume.

The Volume to Space process is destructive. The data on the volume will be lost when the operation is complete. Back up your data before performing this operation.

You can create only one custom volume for each base volume. You cannot convert any volume that is part of a SCSI path or LUN expansion into a VSC volume.

### To convert a normal volume to a VSC volume:

1. From the LUN Management screen, click **VSC**. The Volume Size Configuration (Main Screen) screen is displayed.
2. In the list box, click a normal volume on the Volume Size Configuration screen.
3. Click **Normal -> VSC (XP256)** or **Volume To Space (XP48/XP512)**. A confirmation dialog box is displayed.
4. Click **OK** to continue. The Volume Size Configuration (Normal To VSC)/ (Volume To Space) screen is displayed. Click **Cancel** to cancel the operation.

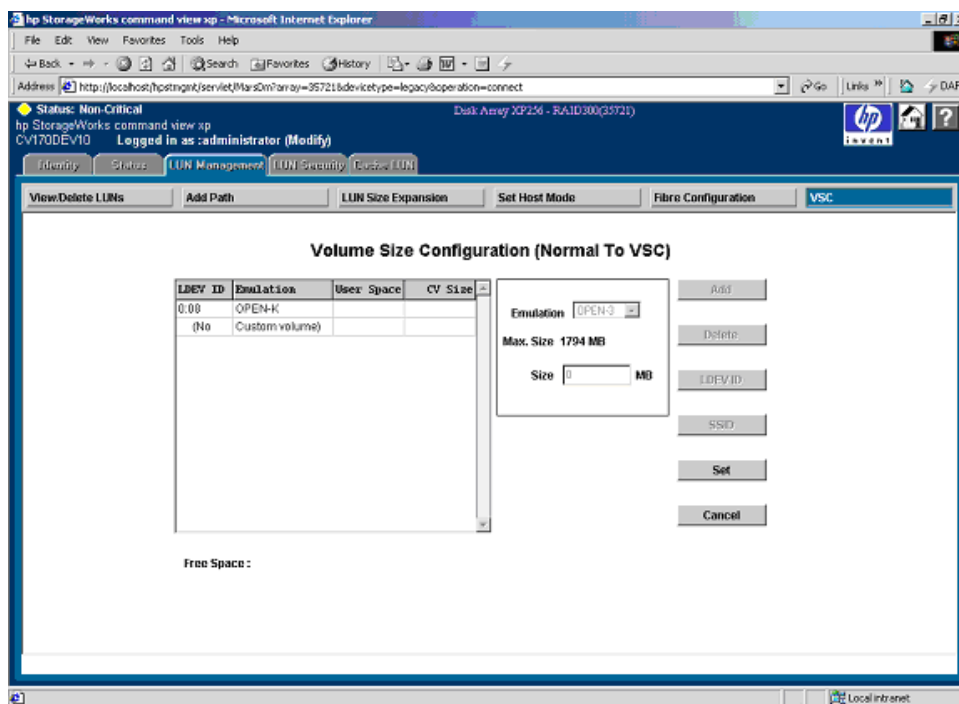
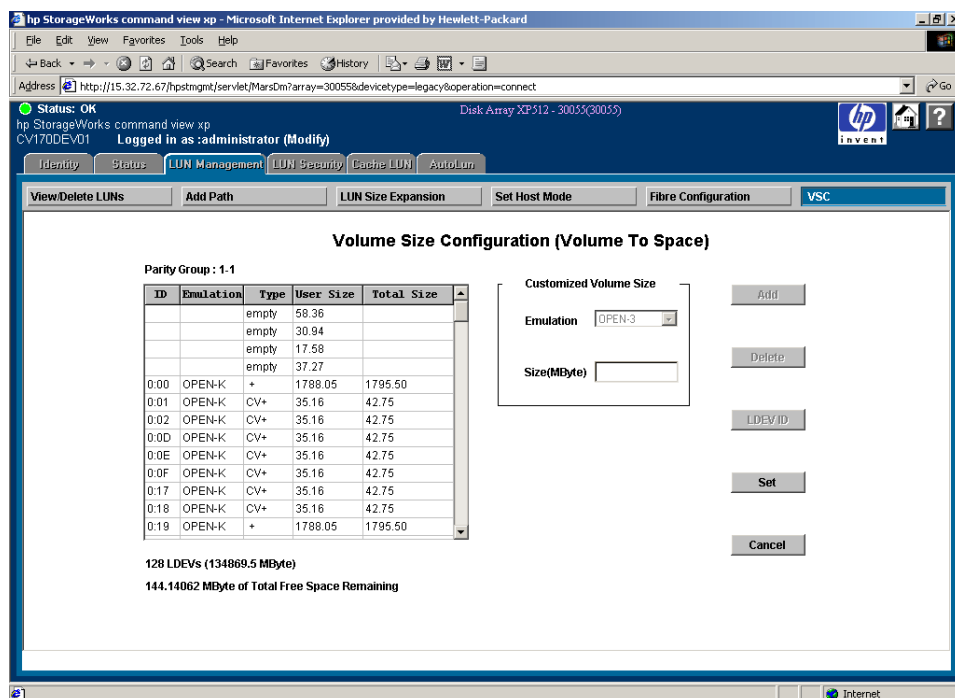


Figure 73: Volume Size Configuration (Normal To VSC) screen (XP256)



**Figure 74: Volume Size Configuration (Volume To Space) screen (XP48/XP512)**

5. In the list box, click an LDEV.
6. In the **Emulation** drop-down list, click an emulation type. The maximum size possible for free space for the selected emulation type is displayed below the drop-down list.
7. In the **Size** box, enter the size and click **Add**. The custom volume is displayed in the list box. At the bottom of the screen, the free space on the volume is updated.

If you make a mistake, select the volume, click **Delete**, and re-enter the correct information.

The **Add** button is disabled to prevent you from adding any additional custom volumes to the current base volume.

8. By default, the LDEV ID of a normal volume being converted is assigned to the newly created custom volume. You can change it if required.

*(Optional, XP256 only)* If the **SSID** button is enabled, you can set the Subsystem ID. Setting the Subsystem ID is optional.

9. Before clicking **Set**, repeat [step 5](#) - [step 8](#) for each selected volume.
10. After you assign the LDEV ID and Subsystem ID (if required), click **Set** to commit the new CV. A confirmation dialog box is displayed.
11. Click **OK** to confirm.

Converting a normal volume to VSC free space can take several minutes because the disk array must format the volume. You can convert multiple normal volumes in a single operation.

## Display

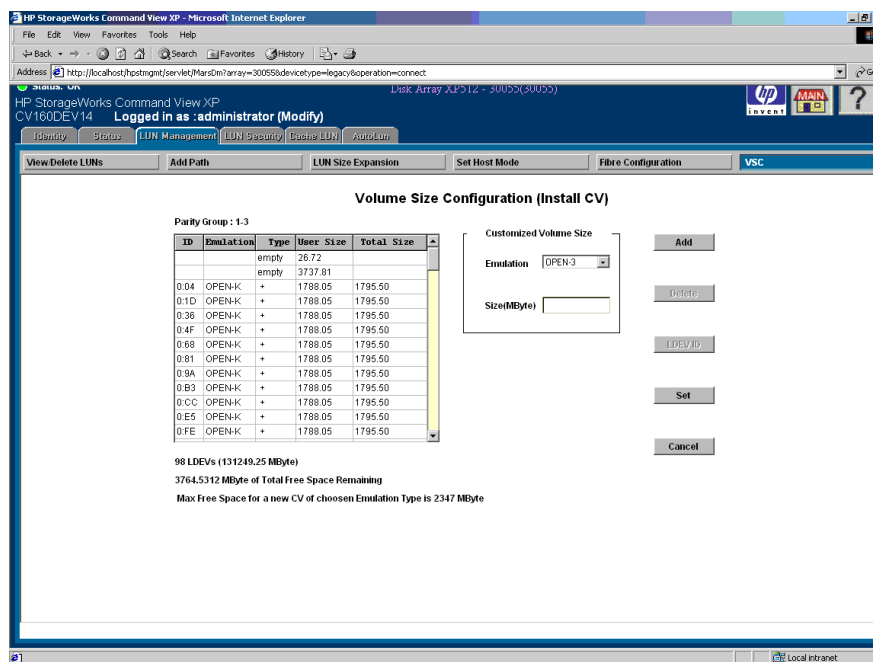
The Volume Size Configuration (Normal To VSC) and (Volume To Space) screens consist of the following items:

- **List box:** Displays an entry for each LDEV selected on the Volume Size Configuration (Main Screen) screen. For each LDEV, the LDEV ID, emulation, type, user size, and total size (the sum of user space and the control overhead) are displayed.
- **Customized Volume Size box:** Contains fields where you select an emulation type and set a volume size during add operations.
- **Add button:** Adds a new volume configuration to the list box. The **Add** button is enabled when a base volume is selected.
- **Delete button:** Deletes a selected custom volume.
- **LDEV ID button:** Displays a screen for assigning the LDEV ID to newly created custom volumes.
- **SSID button** (XP256 only): Displays a screen for assigning the SSID.
- **Set button:** Commits the new volume configuration. The **Set** button and **Cancel** buttons are the only buttons enabled when the screen is displayed.
- **Cancel button:** Returns to the VSC main screen without making changes.
- **Free Space:** Displayed at the bottom of the screen is the space available on the selected base volume.

## Installing Custom Volumes

### To install custom volumes:

1. From the LUN Management screen, click **VSC**. The Volume Size Configuration (Main Screen) screen is displayed.
2. In the list box, click a base volume on the Volume Size Configuration screen.
3. Click **Install CV**. The Volume Size Configuration (Install CV) screen is displayed.



**Figure 75: Volume Size Configuration (Install CV) screen (XP48/XP512)**

4. In the list box, click the VSC volume to configure.
5. In the **Emulation** drop-down list, click the emulation type. The maximum size possible for a custom volume for the selected emulation type displays below the drop-down list.
6. In the **Size** box, enter the custom volume size and click **Add**.

If the free space is zero (0), the **Add** button is disabled. If the size is valid, the custom volume defined is displayed in the list box. The free space on the volume is updated at the bottom of the screen.

If you make a mistake, select the custom volume, click **Delete**, and re-enter the correct information. You cannot delete a custom volume that was not created in the current session.

The **LDEV ID** button is enabled if the base volume containing the new custom volume is highlighted in the list box. You cannot complete the install until an LDEV ID is assigned to all new custom volumes.

*(Optional, XP256 only)* The **SSID** button is enabled so that you can set the Subsystem ID. Setting the Subsystem ID is optional.

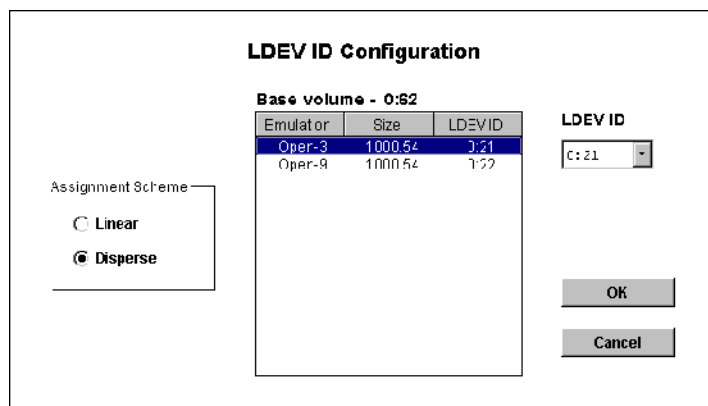
7. Repeat [step 4](#) - [step 6](#) for each volume selected in the VSC main screen.
8. After you assign the LDEV ID and Subsystem ID (if required), click **Set** to commit the new VSC. A confirmation dialog box is displayed.
9. Click **OK** to the configuration or click **Cancel** to cancel the new configuration.

## Setting the LDEV ID

You must assign an LDEV ID to newly created custom volumes, installed custom volumes, or any normal volume that has been converted from a VSC volume.

### To assign LDEV IDs:

1. Verify that the correct custom volume is highlighted.
2. Click **LDEV ID**. The LDEV ID Configuration screen is displayed.



**Figure 76: LDEV ID Configuration screen**

The list box displays the new custom volumes or reconverted normal volumes. The **LDEV ID** drop-down list displays the LDEV IDs you can assign to the custom volumes or normal volumes.

- In the list box, click the custom volume.
- In the **Assignment Scheme** box, click one of the following:
 

**Linear.** Assigns the LDEV IDs in sequential order for all unassigned logical addresses within the parity group. The Linear option is appropriate for users who actively balance their disk array workloads.

**Disperse.** Randomly rotates the LDEV IDs among multiple groups across the disk array, eliminating hot spots and improving data access. The Disperse option is appropriate for users who do not actively balance their disk array workloads.
- Click **OK** to confirm your selections and return to the updated Volume Size Configuration screen. Click **Cancel** to cancel your selections and return to the Volume Size Configuration screen without making any updates.

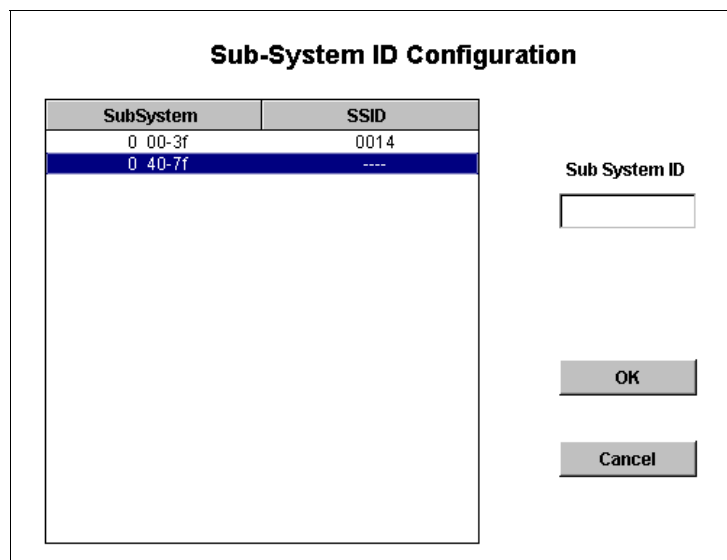
## Specifying the Subsystem ID (XP256 Only)

Each CU contains four logical subsystems, each of which contain 64 logical devices. It may be necessary to specify an SSID when creating custom volumes. Any value can be used for the SSID of OPEN-3/8/9/E/K devices. The lowest SSID number used must be evenly divisible by four. The SSID is a hexadecimal number.



**To specify the Subsystem ID:**

1. Click **SSID**. The Sub-System ID Configuration screen is displayed.



**Figure 77: Sub-System ID Configuration screen**

2. In the list box, select the LDEV range for the SSID not defined.
3. In the **Sub System ID** box, enter the SSID. The SSID must be unique.
4. Click **OK** to assign the specified SSID and return to the Volume Size Configuration screen. Click **Cancel** to cancel the specified SSID and return to the Volume Size Configuration screen without assigning the SSID.
5. On the Volume Size Configuration screen, click **Set**.

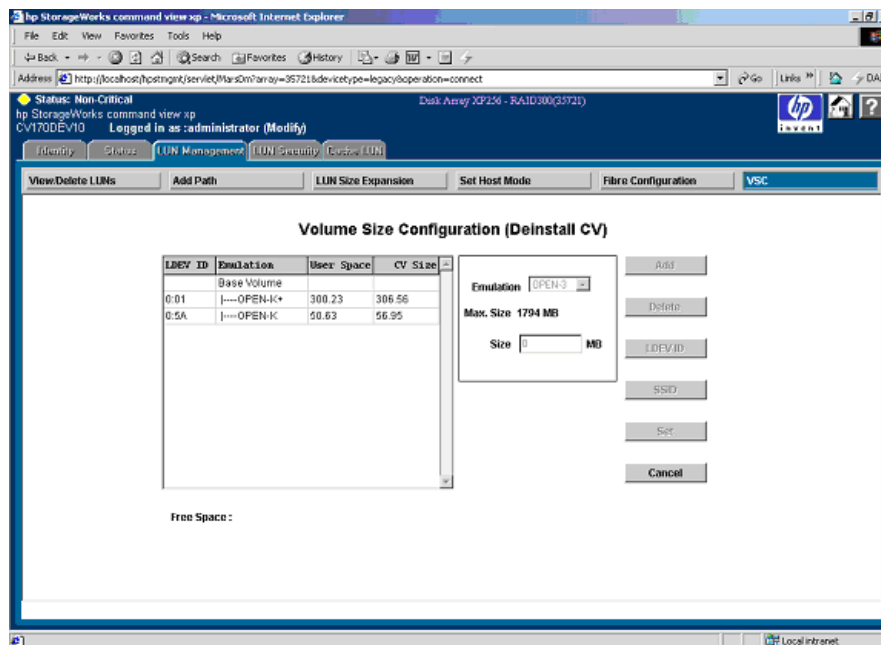
## Deinstalling Custom Volumes

The Deinstall CV process uninstalls one or more custom volumes. The process deletes selected custom volumes on a VSC volume.

The Deinstall CV process is destructive. The data on the custom volumes being uninstalled will be lost when the operation is complete.

**To deinstall custom volumes on an XP256:**

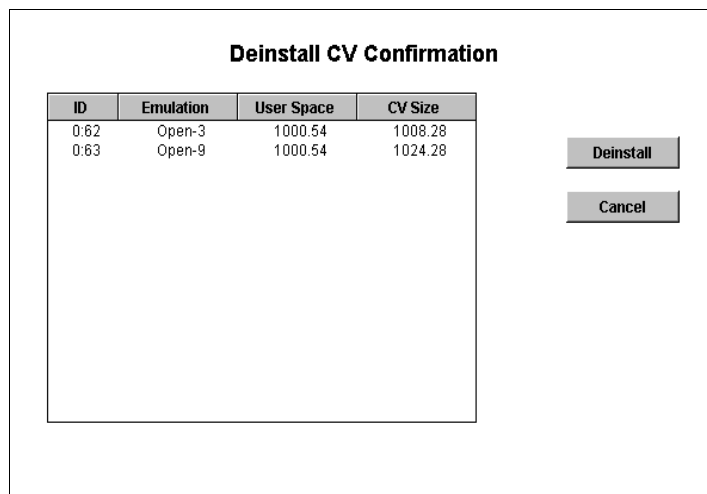
1. From the LUN Management screen, click **VSC**. The Volume Size Configuration (Main Screen) screen is displayed.
2. Click one or more base volumes (CVs).
3. Click **Deinstall CV**. The Volume Size Configuration (Deinstall CV) screen is displayed.

**Figure 78: Volume Size Configuration (Deinstall CV) screen**

You cannot delete all the custom volumes. There should be at least one custom volume for any base volume. The **Delete** button is disabled if there is only one custom volume in a selected LDEV.

If you want to delete the last custom volume, use the **VSC -> Normal** button in the Volume Size Configuration (Main Screen) screen.

4. In the list box, click one or more custom volumes and then click **Delete**. The Deinstall CV Confirmation screen is displayed.



**Figure 79: Deinstall CV Confirmation screen**

5. Click **Deinstall**. The changes are saved. Click **Cancel** to cancel your changes.

#### **To deinstall custom volumes on an XP48/XP512:**

1. From the LUN Management screen, click **VSC**. The Volume Size Configuration (Main Screen) screen is displayed.
2. Click one or more base volumes (CVs).
3. Click **Volume To Space**. A confirmation dialog box is displayed.
4. Click **OK** to continue. The Volume Size Configuration (Volume To Space) screen is displayed. Click **Cancel** to cancel the operation.
5. In the list box, click one or more custom volumes that does not contain a “+” in the Type column and then click **Delete**.
6. Click **Set** to apply the changes. A confirmation dialog box is displayed.
7. Click **OK** to confirm and return to the Volume Size Configuration (Main Screen) screen.

## **Converting a VSC Volume to a Normal Volume**

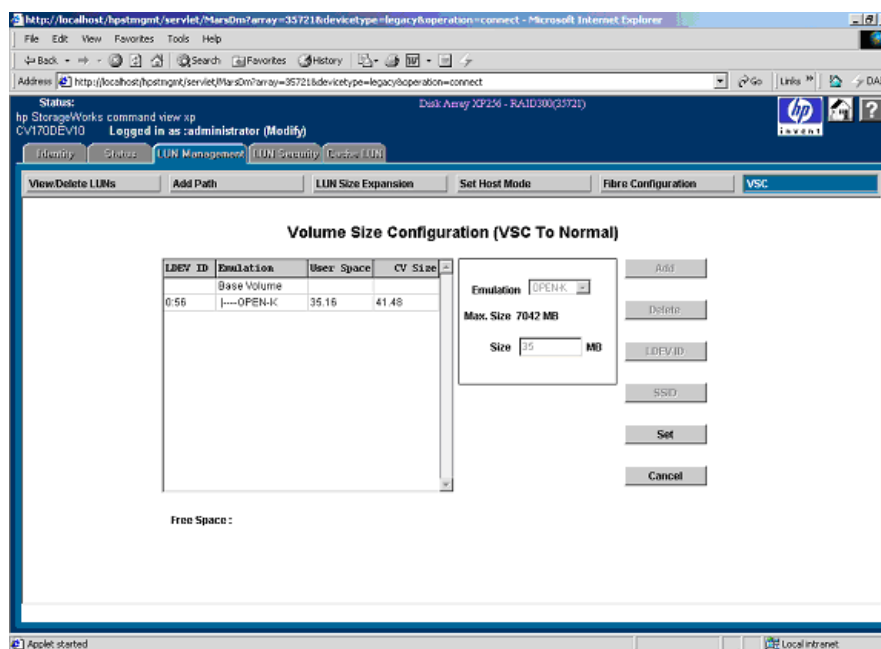
The VSC to Normal process converts a VSC volume back to a normal volume. This operation uninstalls all custom volumes under a VSC volume and then reformats the VSC volume as a normal volume.

If the VSC volume was originally formatted as a VSC volume by the HP representative (using the SVP), you cannot convert it back to normal using Command View. If the volume was converted to a VSC volume using Command View, you can convert it back to normal using the remote console.

Converting a VSC volume to a Normal volume is a destructive operation. The data on the custom volume being converted will be lost when the operation is complete.

#### To convert a VSC volume to a normal volume:

1. From the LUN Management screen, click **VSC**. The Volume Size Configuration (Main Screen) screen is displayed.
2. In the list box, click one or more base volumes that only have one custom volume.
3. Click **VSC -> Normal** (XP256) or **Volume Initialize** (XP48/XP512). The Volume Size Configuration (VSC to Normal)/(Volume Initialize) screen is displayed.



**Figure 80: Volume Size Configuration (VSC to Normal) screen (XP256)**

4. In the list box, click a custom volume and then click **Delete**.

When you click and delete the last custom volume, the **Delete** button is disabled.

By default the LDEV ID of a custom volume being converted is assigned to the normal volume. You can change it if required. Click **LDEV ID** to assign an LDEV ID for the normal volume

*(Optional, XP256 only)* The **SSID** button is enabled so that you can set the Subsystem ID. Setting the Subsystem ID is optional.

5. Click **Set** to convert the VSC volume to a normal volume.

## Operational Restrictions

The success of some LUN Management activities depends on the status of the security switch and whether I/O is active or inactive to the port or LUN. The following tables describe those restrictions.

### Restrictions on LUN Management Operations

**Table 9: LUN Management operation restrictions (XP48/XP256/XP512)**

Activity		Security Switch OFF	Security Switch ON
Security SW OFF=>ON	With active I/O on port	Permitted	Invalid operation
	With no active I/O on port		
Security SW ON=>OFF	With active I/O on port	Invalid operation	Permitted
	With no active I/O on port		
Adding WWN Group	With active I/O on port	Invalid operation	Permitted
	With no active I/O on port		
Adding LUN Groups	With active I/O on port	Invalid operation	Permitted
	With no active I/O on port		
Adding WWN	With active I/O on port	Invalid operation	Permitted
	With no active I/O on port		
Adding LUN	With active I/O on port	Permitted (XP48/XP512) Invalid operation (XP256)	Permitted
	With no active I/O on port	Permitted	
Deleting WWN Groups	With active I/O on port	Invalid operation	Permitted
	With no active I/O on port		
Deleting LUN Groups	With active I/O on port	Invalid operation	Permitted
	With no active I/O on port		
Deleting WWNs	With active I/O on port	Invalid operation	Permitted
	With no active I/O on port		
Deleting LUN, including VSC, LUSE, and command devices	With active I/O on LUN	Not permitted	
	With no active I/O on LUN	Permitted	

## Restrictions on VSC and LUSE Operations

**Table 10: VSC and LUSE operation restrictions (XP48/XP256/XP512)**

Activity		
VSC Volume to Space	With active I/O on LUN	Not permitted
	With no active I/O on LUN	Permitted
VSC Volume Initialize	With active I/O on LUN	Not permitted
	With no active I/O on LUN	Permitted
Deleting a LUSE volume	With active I/O on	Not permitted
	With no active I/O on	Permitted

## Restrictions on Port Operations

**Table 11: Port operation restrictions (XP48/XP256/XP512)**

Activity	
Changing Topology	Operation is possible when I/O is not existing on the port. When I/O is existing on the port, SNMP agent returns an error code.
Changing Fibre Address	
Changing PCB mode	The XP48/XP512 checks the I/O of all LUNs under the port and the XP256 check the I/O of the port.
Changing Host mode	





# LUN Management for the XP128/XP1024



You can connect an XP128/XP1024 to different open system and mainframe hosts using Fibre Channel or Network Attached Storage (NAS), and use LUN Management to configure host groups, logical units, and Fibre Channel and NAS ports. You can also configure NAS cache settings.

One of the important tasks in logical unit configuration is to define I/O paths from hosts to logical units. After the paths are defined, the hosts can send commands and data to the logical units and can receive data from them.

LUN Management can also configure security policies to protect logical units from unauthorized access.

In a Fibre Channel environment, you will also need to configure the Fibre Channel ports on the disk array. With LUN Management, you can set addresses, set speed, and specify topology for Fibre Channel ports.

There are two types of Logical Units (LUs) in a NAS environment: system LUs and user LUs. When configuring a NAS system, you need to define paths between hosts and user LUs. You cannot define paths to system LUs.

## Supported Emulation Types

LUN Management supports the following device emulation types:

- OPEN-3, OPEN-9, OPEN-K, OPEN-8, OPEN-E, OPEN-L, OPEN-M, and OPEN-V for open systems
- 3390-3A/B/C and 3380-KA/B/C for mainframe systems

## LU Paths

After hosts and the disk array are physically connected by cables, switches, etc., use LUN Management to establish paths between the hosts and the logical units. This determines which host can access which logical unit (LU). The paths between hosts and LUs are called LU paths.

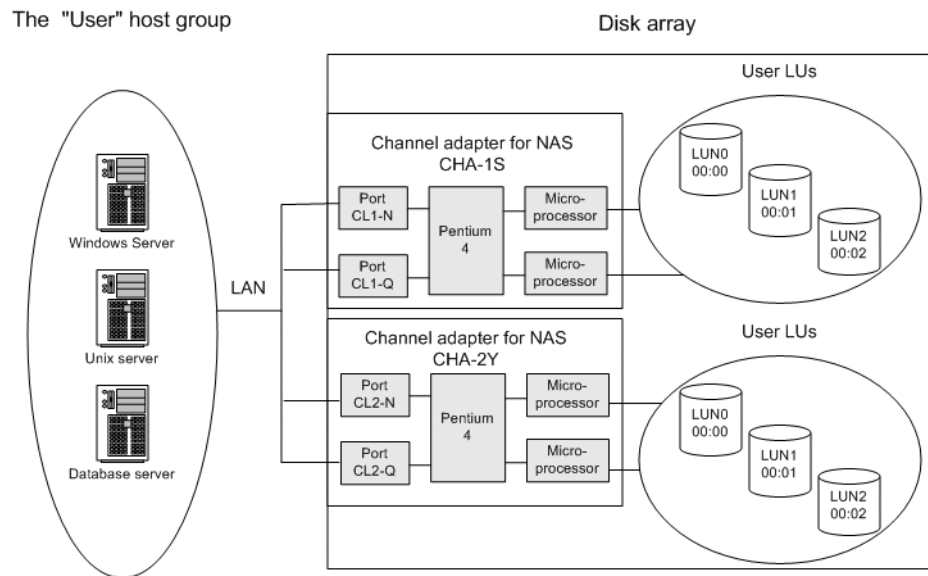
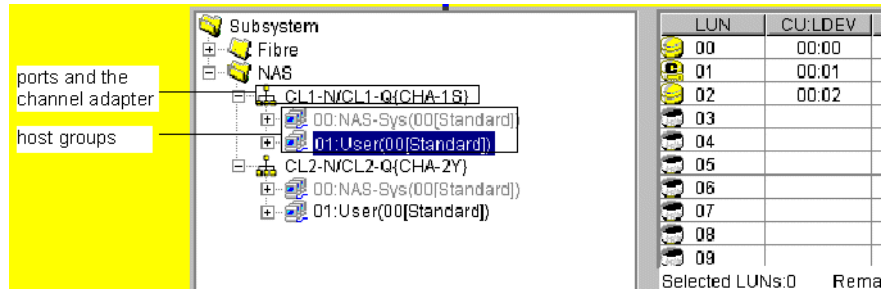
- In a Fibre Channel environment, up to 256 LU paths can be defined for a host group.
- Up to 512 LU paths can be defined for a Fibre Channel port.
- Up to 256 LU paths can be define for a NAS port.
- Up to 128 host groups can be created for a Fibre Channel port.
- Up to 8,192 host groups can be created a one disk array.

## Configuring LU Paths in a NAS environment

In a Fibre Channel environment, you need to classify hosts into host groups (host storage domains) based on platforms. In a NAS environment, however, you do not need to classify hosts: those attached to a NAS port are registered automatically in a host group (a host storage domain) called **User**.

In a NAS environment, LUs are classified into system LUs and user LUs. System LUs contain system information necessary for managing the NAS environment and can only be manipulated by Hewlett-Packard service representatives. User LUs contain data that can be accessed by ordinary network users. When configuring a NAS system, you need to define paths between hosts and user LUs.

The figure below gives an example of defining paths between hosts and user LUs. In a NAS environment, paths are always defined between a user LU and a group of two ports. In the figure below, for example, two paths are defined to the user LU 00:00 (LUN 00). One path comes from the CL1-N port and the other path comes from the CL1-Q port. Thanks to this two path configuration, hosts can access the user LU even if one of the paths fails.



**Figure 81: LU paths configuration in a NAS environment**

**Notes:**

- In a NAS environment, up to 256 LU paths can be defined for one NAS port.
- In a NAS environment, you cannot define LU paths to logical volumes unless they have the Read/Write access attribute.
- The LUN Management panel displays two host groups (**User** and **NAS-Sys**) below each NAS port. When you define LU paths, you can use the **User** host group only; you cannot use the **NAS-Sys** host group.

## 16-Port FC/CA CHIP Product

Although there is not a significant performance gain compared to the 8-port FC/CA CHIP product, the primary advantage of the 16-port FC/CA CHIP product is the increased FC connectivity, or port count, it offers.

High-speed mode is not currently available on the 16-port FC/CA CHIP product.

Odd/even LUN data path handling through the processor does not exist on the XP128/XP1024. There is no odd/even LUN mapping issues associated with this product. Each processor of the 16-port CHIP product handles the data flow of two ports (eight total processors for 16 total ports = two ports per a processor).

For load balancing, the two ports serviced by a processor should be considered as one port. Although volumes can be mapped to the two ports handled by one processor, the I/O will still go through the one processor. For redundancy and performance reasons, consider distributing the load across multiple CHIPS.

When deciding whether to map volumes to ports (LUN mapping) for host connectivity, after considering load balancing across processors, there is no reason to not use all 16 ports immediately. After considering load balancing among processors, there is no reason not to use both ports in the I/O path of one processor or to use both ports in the I/O path of a processor.

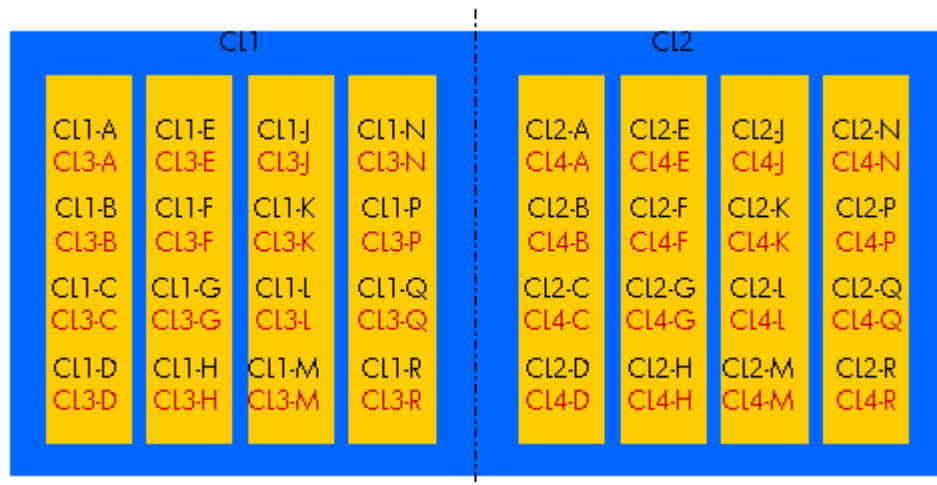


Figure 82: 16-Port CHIP pair labeling

Port numbering is as such: Cluster 1 uses CL1-\* and CL3-\*, while Cluster 2 uses CL2-\* and CL4-\*, where \* is an alphabetical character designation of the port such as A, B, C, and so on. Ports A use the same processor, such as ports CL1-A and CL3-A, ports CL2-E and CL4-E. In other words, port CL1-A and CL3-A share the same processor for I/O purposes.

## Host Groups

Begin by grouping server hosts into host groups. For example, if HP-UX and Windows hosts are connected to the disk array, you must create one host group for the HP-UX hosts and another host group for the Windows hosts. Then, you register HP-UX and Windows hosts separately in their corresponding host group. After hosts are classified into host groups, you then associate host groups with logical units.

In the following figure, the host group *hpux01* is associated with six logical units. LU paths are defined between the three hosts in the *hpux01* group (*WWN\_1*, *WWN\_2*, *WWN\_3*) and the six logical units LUN00-LUN05.

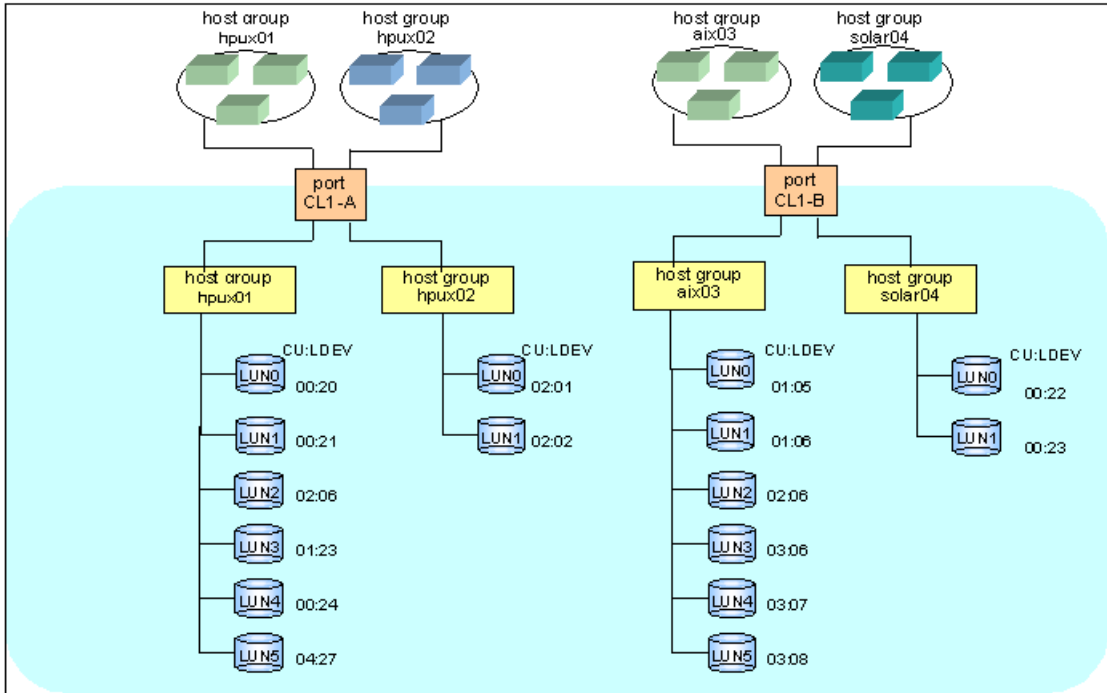
The screenshot shows the LUN Manager interface with the 'Port' tab selected. The left pane displays a tree view of the storage configuration. A 'Port' folder is expanded to show 'CL1-A(5C)'. Under this port, a host group '00 hpux01(HP)' is selected. This group contains three hosts: 'WWN\_1(0123456789ABCDEF)', 'WWN\_2(123456789ABCDEF1)', and 'WWN\_3(123456789ABCDEF2)'. Other ports and host groups are also visible in the tree.

The right pane shows a table of Logical Units (LUNs) associated with the selected host group. The table has columns for LUN, CU:LDEV, Emulation, Capacity, RAID, and Paths. Six LUNs (00-05) are listed, each with a capacity of 2.29GB and RAID 5(3D+1P). A 'Command device' label points to the 'CU:LDEV' column.

LUN	CU:LDEV	Emulation	Capacity	RAID	Paths
00	00:20	OPEN-3 * 1	2.29GB	5(3D+1P)	1
01	00:21	OPEN-3 * 1	2.29GB	5(3D+1P)	1
02	02:06	OPEN-3 * 1	2.29GB	5(3D+1P)	1
03	01:23	OPEN-3 * 1	2.29GB	5(3D+1P)	1
04	00:24	OPEN-3 * 1	2.29GB	5(3D+1P)	1
05	02:27	OPEN-3 * 1	2.29GB	5(3D+1P)	1
06					
07					
08					
09					

Selected LUNs:0    Remained LUNs(Port):506    Remained LUNs(GRP):250

Figure 83: Host group example 1



**Figure 84: Host group example 2**

LUN Management can define paths between a single host and multiple LUs. In the previous figure, each of the three hosts in the host group *hpux01* is able to access the six LUs. LUN Management can also define paths between multiple hosts and a single LU.

Hosts can be members of only one host group for a given port. Host group definitions and members apply only to the port that they are defined for.

## Host Modes

As part of registering hosts in host groups, you'll be asked for the host mode. Use the following table to determine the host modes for the hosts you are installing.

**Table 12: Host modes for host operating systems (XP128/XP1024)**

Host modes	Host operating system
00	Red Hat Linux, IRIX, or Windows <sup>1</sup> (Standard)
01 - 03	Reserve
04	DYNIX/ptx (Sequent)
05	OpenVMS
06	Reserve
07	Tru64
08	HP-UX or Windows <sup>2</sup>
09	Solaris
0A	NetWare
0B	Reserve
0C	Windows <sup>3, 4</sup>
0D, 0E	Reserve
0F	AIX
10 - 19	Reserve
1A - 1F	Reserve
20 - 29	Reserve
2A, 2B	Reserve
2C	Windows Extension <sup>3, 4</sup>
2D - 2F	Reserve

1. For Windows with any FC HBAs when MSCS is not needed.
2. For Windows with D8602 FC HBAs with or without MSCS.
3. For Windows with Emulex or QLogic FC HBAs with or without MSCS.
4. If you register Windows server hosts in a host group, verify that the host mode of the host group is **0C: Windows** or **2C: Windows Extension**. If you are thinking about creating LUSE volumes, such as expanded LUs, consider setting the host mode **2C: Windows Extension** to the host group. If the host mode is **0C: Windows** and an LU path is defined for a volume, you cannot execute LUSE operations on the volume without unmapping the volume first.

## LUN Security

To protect data in your disk array from unauthorized access, you should apply security policies to LUNs. LUN Management can apply LUN security to ports to safeguard LUs. If a port has the External attribute, you cannot apply LUN security to the port.

---

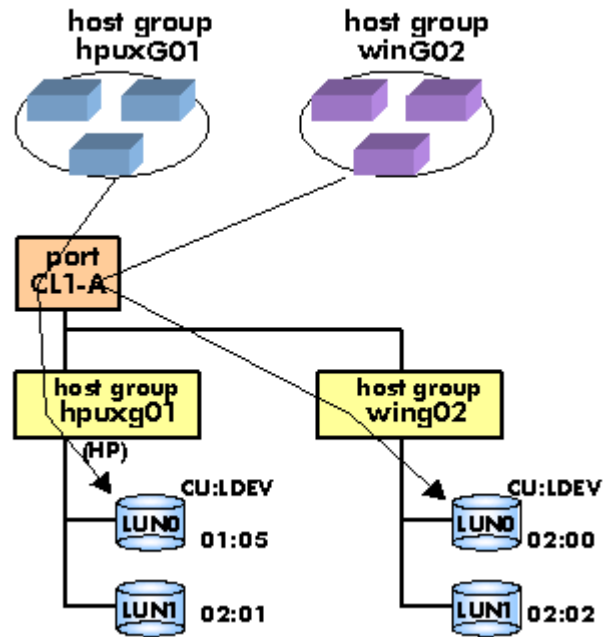
**Note:** You cannot apply LUN security to NAS ports.

---

If LUN security is applied, it limits which host can access which LUs. Hosts can only access LUs associated with the host group that the hosts belong to. The hosts cannot access to LUs associated with the other host groups.

In the following figure, the three hosts in the hpux-G01 group can reference LUN0 and LUN1 associated with the same host group, but cannot reference LUN0 and LUN1 in the winG02 host group. Therefore, the hosts in hpuxG01 can only access the two LUs, identified by 01:05 and 02:01; the hosts cannot access the LUs 02:00 and 02:02. On the other hand, the three hosts in the winG02 group cannot reference LUN0 and LUN1 in hpuxG01 and therefore cannot access the LUs 01:05 and 02:01.





**Figure 85: Host group example 3 (LUN security)**

If LUN security is disabled, the hosts will not be able to access most of the LUs. Hosts will have access to only those LUs defined in host group 0.

By default, LUN security is disabled on a port, so host group 0 is the only accessible host group reserved for the port. Initially it contains no LUs or WWNs.

When security is disabled, only LUs defined in host group 0 are accessible to hosts connected to the port, regardless of any WWNs that may be defined for a host group. After security is enabled, WWNs are used, permitting or restricting access based on WWN.

If you have more than one host group defined on a port, you can locate host group 0 by disabling LUN security from the port. When done, the tree display will “gray” out all host groups except host group 0.

## RAID Manager Command Devices

To use RAID Manager commands for Business Copy and Continuous Access operations, you must designate at least one LDEV on the disk array as a command device. A command device receives RAID Manager commands entered from hosts. When you enter a RAID Manager command from a host, the command is transferred to the target device via the command device.

If you want to restrict access to LUs and by RAID Manager, you can apply command device security in LUN Manager.

You cannot use the following LDEVs as command devices:

- Volumes that do not have read/write access
- Volumes reserved by Auto LUN
- CA volumes
- BC volumes
- External LUs

If you want to use a LUSE volume as a command device, you must specify only the first LU as the command device.

## Fibre Channel Ports Attributes

As part of configuring a disk array, you must configure the Fibre Channel topology and set addresses for the Fibre Channel ports. You can enhance system performance by adjusting the data transfer speed at the Fibre Channel ports and changing the channel adapter mode.

## Fibre Channel Topologies

Fibre Channel provides the following topologies:

- **Fabric:** Uses a fabric switch to connect a large number of devices. Each device will have the full bandwidth of 100 MB/sec.
- **FC-AL (Fibre Channel-Arbitrated Loop):** A shared-bandwidth topology that can connect up to 126 devices (AL ports) together.
- **Point-to-point:** A simple Fibre Channel topology in which two devices are connected directly together.

When you configure the disk array, use LUN Management to specify whether the hosts and the disk array are connected by a fabric switch. Also, you must specify FC-AL or point-to-point in the LUN Management screen. The default is FC-AL.

If you are using a fabric switch, consult the switch's documentation to learn whether FC-AL or Point-to-point should be used. Some fabric switches require you to specify Point-to-point to get the system running.

## Arbitrated Loop Physical Addresses

You will need to set addresses for Fibre Channel ports. When addressing Fibre Channel ports, you can use AL-PA (arbitrated loop physical address) or loop IDs as the addresses (see the following table).

**Table 13: AL-PA and Loop IDs (XP128/XP1024)**

AL-PA	Loop ID	AL-PA	Loop ID	AL-PA	Loop ID	AL-PA	Loop ID
EF	0	B2	32	72	64	3A	96
E8	1	B1	33	71	65	39	97
E4	2	AE	34	6E	66	36	98
E2	3	AD	35	6D	67	35	99
E1	4	AC	36	6C	68	34	100
E0	5	AB	37	6B	69	33	101
DC	6	AA	38	6A	70	32	102
DA	7	A9	39	69	71	31	103
D9	8	A7	40	67	72	2E	104
D6	9	A6	41	66	73	2D	105
D5	10	A5	42	65	74	2C	106
D4	11	A3	43	63	75	2B	107
D3	12	9F	44	5C	76	2A	108
D2	13	9E	45	5A	77	29	109
D1	14	9D	46	59	78	27	110
CE	15	9B	47	56	79	26	111
CD	16	98	48	55	80	25	112
CC	17	97	49	54	81	23	113
CB	18	90	50	53	82	1F	114
CA	19	8F	51	52	83	1E	115
C9	20	88	52	51	84	1D	116
C7	21	84	53	4E	85	1B	117

**Table 13: AL-PA and Loop IDs (XP128/XP1024) (Continued)**

AL-PA	Loop ID	AL-PA	Loop ID	AL-PA	Loop ID	AL-PA	Loop ID
C6	22	82	54	4D	86	18	118
C5	23	81	55	4C	87	17	119
C3	24	80	56	4B	88	10	120
BC	25	7C	57	4A	89	0F	121
BA	26	7A	58	49	90	08	122
B9	27	79	59	47	91	04	123
B6	28	76	60	46	92	02	124
B5	29	75	61	45	93	01	125
B4	30	74	62	43	94		
B3	31	73	63	3C	95		

## Data Transfer Speed for Fibre Channel Ports

As disk array operation continues, you may notice that a larger amount of data is transferred at some ports but a smaller amount of data is transferred at some other ports. If you set a faster data transfer speed for ports where a larger amount of data is transferred, system performance should improve. If you set a slower data transfer speed for ports where a smaller amount of data is transferred, you should also see improved system performance.

## Standard, High-Speed, and High-Speed (2 Port) Modes

The channel adapter boards can operate in standard, high-speed, or high-speed (2 port) mode. By default, they run in standard mode. However, if a channel adapter board satisfies certain conditions, you can set it to high-speed or high-speed (2 port) mode to improve port performance.

---

**Note:** High-speed (2 port) mode is available only if the XP disk array has firmware version 21.06.22 or later installed.

---

High-speed mode can be applied to channel adapter boards that satisfy the following conditions:

- Only one port is planned for use.
- All ports take the same Fibre topology option (on or off).

- All ports take FC-AL as the Connection option.
- All ports use different port addresses and no matching addresses.
- All ports take the same port type (Initiator, RCU target, or Target).

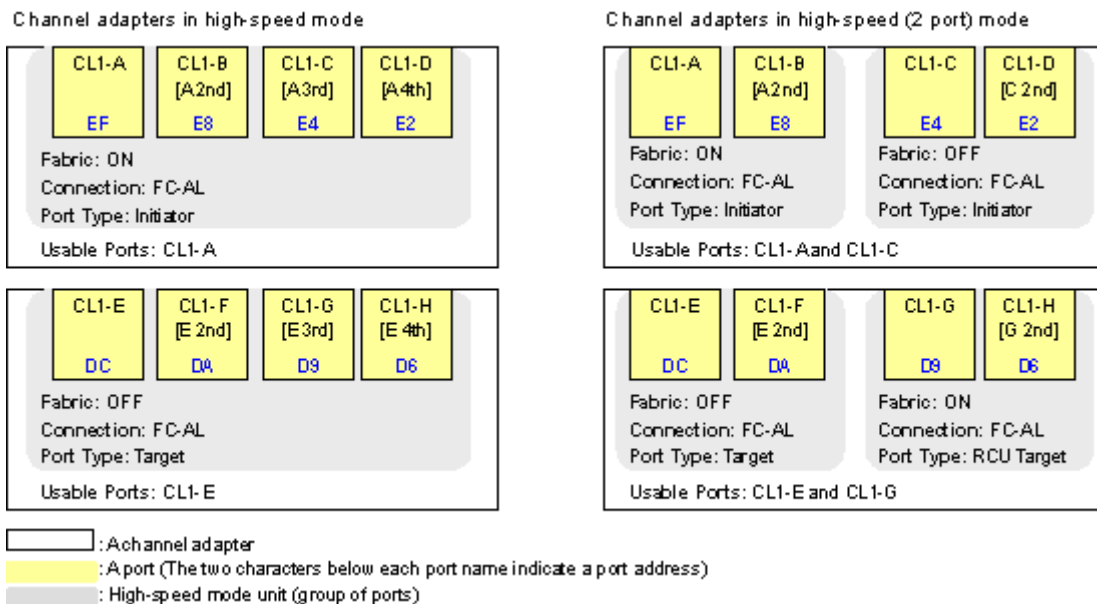
High-speed (2 port) mode can be applied only to four-port channel adapter boards. When you apply high-speed (2 port) mode, two of the four ports must satisfy the following conditions. Also, the other two ports must satisfy the following conditions:

- Of the two ports, only one port is planned for use.
- The two ports take the same Fibre topology option (on or off).
- The two ports take FC-AL as the Connection option.
- The two ports use different port addresses and no matching addresses.
- The two ports take the same port type (Initiator, RCU target, or Target).

If high-speed mode is applied to a channel adapter board, only one of the ports on the channel adapter board can be used. This port can exclusively use channel processors and fibre optic processors (FOPs) that would otherwise be reserved for the other ports.

If high-speed (2 port) mode is applied to a four-port channel adapter board, two ports out of the four ports cannot be used. The remaining two ports can exclusively use channel processors and fibre optic processors (FOPs) that would otherwise be reserved for the other two ports.

In both cases, the system performance will be improved. By balancing the workloads on the processors, a greater improvement can be expected with the system performance.



**Figure 86: Differences between high-speed and high-speed (2 port) modes**

Before changing the configuration of a port that is being used, perform a backup operation. You cannot change standard mode to high-speed mode or vice versa while you are online to the hosts.


## LUN Management Operations

LUN Management operation topics include the following:

- Starting LUN Management operations (see page 204)
- LUN Management screen (see page 204)
- Defining LU paths (see page 209)
  - Creating host groups (see page 209)
  - Registering hosts in host groups (see page 211)
  - Associating host groups to logical volumes (see page 213)
- Changing or viewing LU path settings (see page 215)
  - Deleting LU paths (see page 215)
  - Changing the name and host mode of a host group (see page 216)
  - Deleting host groups (see page 218)
  - Initializing the host group 0 (zero) (see page 219)
  - Changing WWNs and nicknames (see page 220)
  - Deleting host bus adapters from host groups (see page 222)
  - Deleting unneeded WWNs from the WWN table (see page 223)
  - Viewing a list of concatenated parity groups (see page 224)
- Defining alternate paths (see page 225)
  - Copying paths from one Fibre Channel port to another (see page 225)
  - Copying paths from one NAS port to another (see page 227)
  - Copying paths from a Fibre Channel port to a NAS port (see page 229)
  - Copying paths from a NAS port to a Fibre Channel port (see page 230)
- Displaying alternate paths (see page 232)
- Deleting WWNs (see page 233)
- Applying and removing LUN security (see page 234)
- Creating RAID Manager command devices (see page 235)

## Starting LUN Management Operations

To start LUN Management operations:

1. From the Launch screen, click an XP128 or XP1024.
2. Click the **LUN and Volume Mgmt** tab, and then click the **LUN Management** button (  ). The LUN Management main screen is displayed.

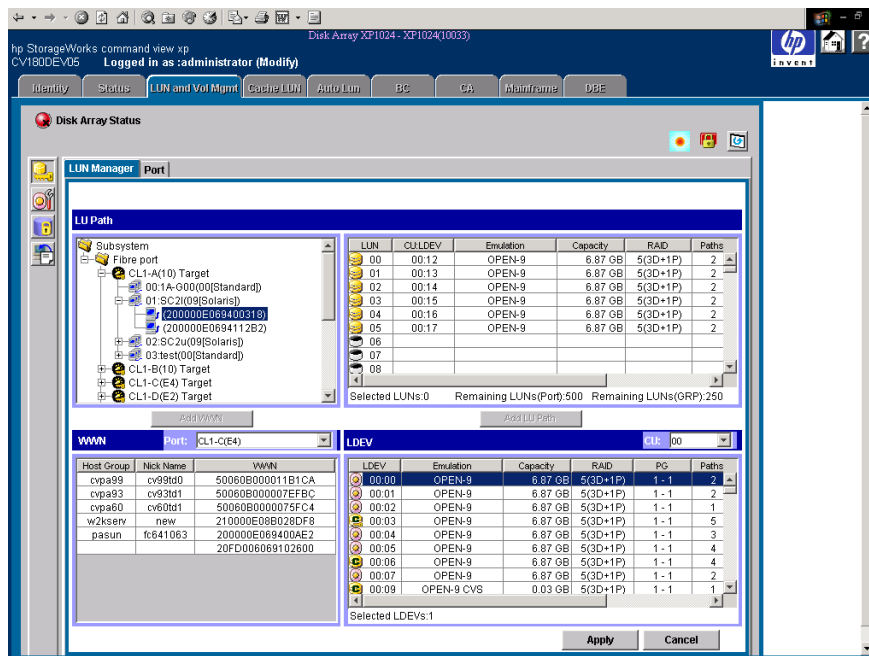


Figure 87: LUN Management main screen

## LUN Management Main Screen

### LU Path tree

On the left side is a tree that lists the Fibre Channel and NAS ports in the disk array and hosts connected to them. Hosts are identified by nicknames and WWNs and are classified by host groups.









The LU Path tree may contain different folders: Fibre Channel, NAS, etc.



## Fibre Channel Folder

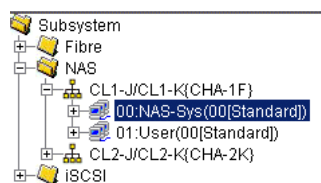
The following are the Fibre Channel port icons used in the LU Path tree:

**Table 14: Fibre Channel port icons for LUN Management operations**

Icon	Status
	A short-wave port in standard mode without LUN security.
	A short-wave port in standard mode with LUN security.
	A long-wave port in standard mode without LUN security.
	A long-wave port in standard mode with LUN security.
	A short-wave port in high-speed or high-speed (2 port) mode without LUN security.
	A short-wave port in high-speed or high-speed (2 port) mode with LUN security.
	A long-wave port in high-speed or high-speed (2 port) mode without LUN security.
	A long-wave port in high-speed or high-speed (2 port) mode with LUN security.

**Note:** High-speed (2 port) mode is available only if the XP disk array has firmware version 21.06.22 or later installed.

## The NAS folder



**Figure 88: NAS folder in LU Path tree**

In a NAS environment, if you double-click the NAS folder, NAS ports in the disk array appear as icons. Two port names appear to the right of each icon, followed by the name of the channel adapter in parentheses.

**Note:** The NAS folder appears only if the disk array contains one or more NAS channel adapters.

The following are the NAS port icons used in the LU Path tree:

**Table 15: NAS port icons for LUN Management operations**

Icon	Status
	Indicates that you can assign paths from this NAS port to logical volumes.
	Represents a short-wave port in standard mode with LUN security.

When you double-click a NAS port, the following host groups appear:

- NAS-Sys
  - If you select this host group, the table on the right displays information about paths to system LUs. The table contents are grayed out and cannot be changed.
  - This host group number is 00.
- User
  - If you select this host group, the table on the right displays information about paths to user LUs.
  - This host group number is 01.






### LU Path table

On the right side is a table that displays LU Path information about the hosts in the tree. The table contains the following information:

- **LUN:** LUNs (address numbers) assigned to logical units (LUs), which are LDEVs that can be accessed by hosts. If no paths are defined, the other columns on the right are blank.

The following icons are used to indicate the status:

**Table 16: LUN icons for LUN Management operations**

Icon	Status
	A logical volume to which an LU path is defined.
	An expanded LU
	A command device.
	A command device with security enabled.
	A LUN to which no LU path is defined.

- **CU:LDEV:** The CU image number is to the left of the colon. The LDEV number is to the right of the colon. If an LDEV number ends with the sharp symbol (#), the logical volume is an external LU.
- **Emulation:** Emulation type for each LDEV.
- **Capacity:** Size of each LDEV.
- **RAID:** RAID level for each LDEV. If the logical volume is an external LU, the RAID column does not display the RAID level, but displays a hyphen (-) instead.
- **Paths:** Number of alternate paths, if any.
- **Access Attribute:** The access attribute of each logical volume.

### WWN table

The WWN table in the lower-left corner lists hosts that are connected to Fibre Channel ports of the disk array. The table contains the following information:

- **Port drop-down list:** Displays the list of ports.

- **Host Group:** Host groups are used to classify servers (hosts) connected to the disk array. You need to create host groups in the LUN Management screen.
- **Nickname:** Indicates nicknames for hosts. Nicknames can be specified in the LUN Management screen.
- **WWN:** Worldwide names. Each worldwide name represents one host.






### LDEV table

The LDEV table lists LDEVs in the disk array. The LDEV table does not contain Auto LUN-reserved LDEVs. The table contains the following information:

- **CU drop-down list:** Displays the list of CU images.
- **LDEV:** The combination of CU image number and LDEV number to identifies an LDEV. If an LDEV number ends with the sharp symbol (#), the logical volume is an external LU.

The following icons are used to indicate the status:

**Table 17: LDEV icons for LUN Management operations**

Icon	Status
	A normal logical volume.
	An expanded LU.
	A volume to which the VSC feature is applied.
	A command device.
	A command device with security enabled.

- **Emulation:** The emulation type for each LDEV.
- **Capacity:** The size of each LDEV.
- **RAID:** The RAID level for each LDEV. If the logical volume is an external LU, the RAID column does not display the RAID level, but displays a hyphen (-) instead.
- **PG:** Displays names of parity groups. If a parity group name begins with the letter E, the parity group consists of one or more external LUs.
- **Paths:** Displays the number of alternate paths, if any.
- **Access Attribute:** Displays the access attribute of each logical volume.

**Buttons**

- **Apply button:** Applies settings in the screen to the disk array.
- **Cancel button:** Cancels settings in the screen.
- **Add LU Path button:** Adds logical units to LU Path table.
- **Add WWN button:** Registers host bus adapters in a host group. Applicable to Fibre Channel ports only.

## Defining LU Paths

If you are configuring a Fibre Channel environment, complete the following four major steps:

1. Finding WWNs of host bus adapters connected to the Fibre Channel ports
2. Creating host groups (see page 209)
3. Registering hosts in host groups (see page 211)
4. Associating host groups to logical volumes (see page 213)

If you are configuring a NAS environment, follow the procedure described in [Associating Host Groups to Logical Volumes](#) (page 213)

## Creating Host Groups


---


**Note:** If you are configuring a NAS environment, you do not need to follow the procedure described in this section. For instructions on how to define LU paths in a NAS environment, see [Associating Host Groups to Logical Volumes](#) (page 213).

---

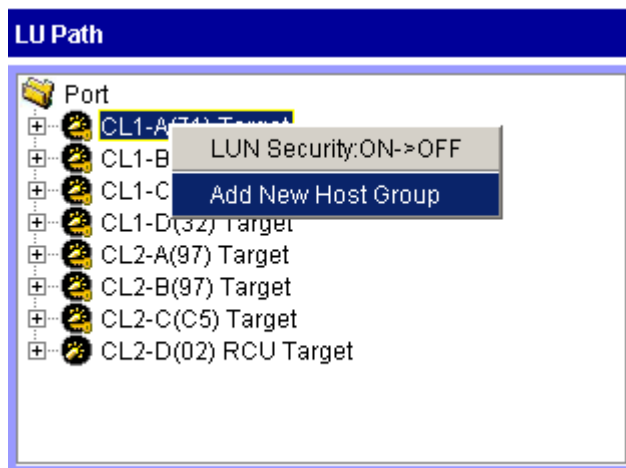
You can connect multiple server hosts of different platforms to one port of your XP disk array. When configuring your system, you must group server hosts connected to the disk array by host groups. For example, if HP-UX and Windows hosts are connected to a port, create one host group for HP-UX hosts and also create another host group for Windows hosts. Next, register the HP-UX hosts to the corresponding host group and also register the Windows hosts to the other host group.

**To create a host group:**

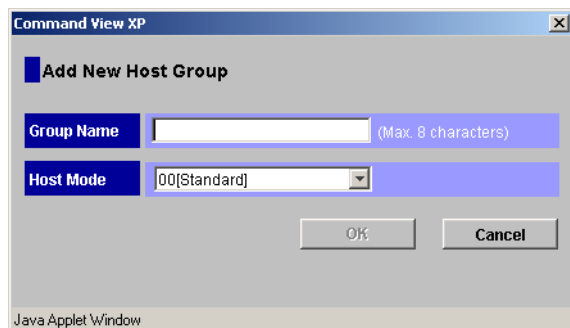
1. In the LU Path tree on the LUN Management main screen, locate the port and verify that LUN security has been applied to the port. If the port icon contains a key (such as ) , then LUN security has been enabled.

If the port icon does not contain a key (such as ) , select and right-click the port, and from the pop-up menu, click **LUN Security: OFF->ON** to enable LUN security.

2. After LUN security is enabled, select and right-click the port in the LU Path tree. A pop-up menu is displayed.



3. Click **Add New Host Group** from the pop-up menu. The Add New Host Group window is displayed.



**Figure 89: Add New Host Group window**

4. In the **Group Name** field, enter the host group name.

It is convenient if you name each host group after the host platform. For example, if you are creating a host group to register Windows NT hosts in, the host group name could be WNT or WinNT.

Host group names can be up to eight characters long and are case-sensitive.

5. In the **Host Mode** drop-down list, click a host mode. Host groups on the same port can have different host modes.
6. Click **OK**. The host group name and the host mode are shown in blue in the LU Path tree.
7. Click **Apply** in the LUN Management main screen. A confirmation dialog box is displayed.
8. Click **OK**. The settings are applied to the disk array.

## Registering Hosts in Host Groups

---



**Note:** If you are configuring a NAS environment, you do not need to follow the procedure described in this section. For instructions on how to define LU paths in a NAS environment, see [Associating Host Groups to Logical Volumes](#) (page 213).

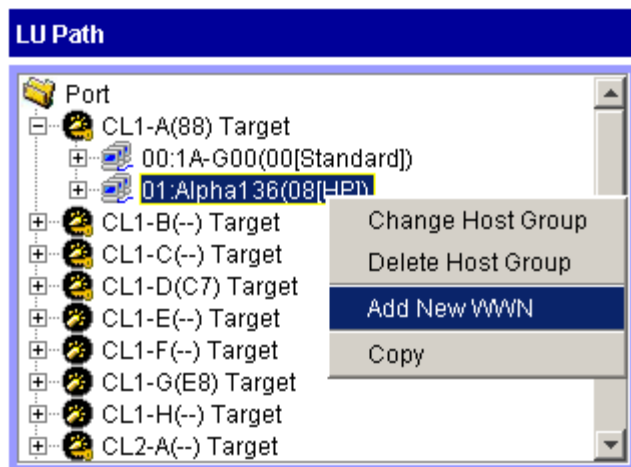
---

To be able to set LU paths, you must register hosts in host groups. For example, if HP-UX and Windows hosts are connected to a port, you must register HP-UX and Windows hosts separately in two different host groups.

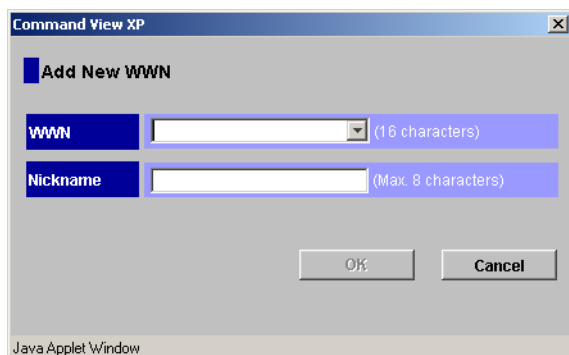
When registering a host, you can assign a nickname of the host bus adapter. If you assign a nickname, you will be able to easily identify each host bus adapter on the screen. Although WWNs are also used to identify each host bus adapter, the nickname that you assign will be more helpful because you can name host bus adapters after the host installation site or the host owners.

### To register hosts in a host group:

1. In the LU Path tree on the LUN Management main screen, locate the port that the host group belongs to and verify that LUN security has been applied to the port. If the port icon contains a key (such as ) , then LUN security has been enabled.  
  
If the port icon does not contain a key (such as ) , select and right-click the port, and from the pop-up menu, click **LUN Security: OFF->ON** to enable LUN security.
2. After LUN security is enabled, select and right-click the host group in the LU Path tree. A pop-up menu is displayed.



3. Click **Add New WWN** from the pop-up menu. The Add New WWN window is displayed.



**Figure 90: Add New WWN window**

4. In the **WWN** field, enter the WWN for the host, or in the **WWN** drop-down list, click a WWN.
5. In the **Nickname** field, enter the nickname for the host.

Nicknames are used to easily identify each host in the LUN Management screen. Although WWNs are also used to identify each host, nicknames are more helpful because you can name hosts after the host installation site or the host owners. Nicknames can be up to eight characters long and are case-sensitive.



6. Click **OK**. The new WWN and nickname are shown in blue below the selected host group in the LU Path tree.
7. Click **Apply** in the LUN Management main screen. A confirmation dialog box is displayed.
8. Click **OK**. The settings are applied to the disk array.

If the WWN table (located in the lower-left corner of the screen) includes a host that you want to register, you can register the host by first selecting the host group in the LU Path tree, selecting the host from the WWN table, and then clicking **Add WWN**.

## Associating Host Groups to Logical Volumes

You can use LUN Management to define LU paths by associating host groups to logical volumes. For example, if you associate a group of three hosts with logical volumes, LU paths are defined between the three hosts and the logical volumes.

### To define LU paths:

1. In the LU Path tree on the LUN Management main screen, click a host group.

---

**Note:** If you are configuring a NAS environment, you must select the User host group.

---

2. In the **CU** drop-down list above the LDEV table, click a CU number. The LDEV table shows LDEVs in the CU.
3. In the LDEV table, click one or more LDEVs. Press the Ctrl key while clicking to select more than one LDEV.
4. In the LU Path table, click the logical units.

The screenshot shows the LUN Management interface. The top section is titled "LU Path" and contains a tree view on the left and a table on the right. The tree view shows a hierarchy of ports and targets, with "01:Alpha136(08)(HP)" selected. The table lists LUNs with columns for LUN, CU:LDEV, Emulation, Capacity, RAID, and Paths. The bottom section is titled "WWW" and "LDEV" and contains a table of LDEVs with columns for LDEV, Emulation, Capacity, RAID, PG, and Paths. The "Add LU Path" button is highlighted.

LUN	CU:LDEV	Emulation	Capacity	RAID	Paths
00	00:00	OPEN-9	6.87 GB	5(3D+1P)	1
01	00:01	OPEN-9	6.87 GB	5(3D+1P)	1
02	00:02	OPEN-9	6.87 GB	5(3D+1P)	1
03	00:03	OPEN-9	6.87 GB	5(3D+1P)	1
04	00:04	OPEN-9	6.87 GB	5(3D+1P)	1
05	00:05	OPEN-9	6.87 GB	5(3D+1P)	1
06	00:06	OPEN-9	6.87 GB	5(3D+1P)	2
07	00:07	OPEN-9	6.87 GB	5(3D+1P)	1
08	00:08	OPEN-9	6.87 GB	5(3D+1P)	1
09	00:09	OPEN-9	6.87 GB	5(3D+1P)	1

LDEV	Emulation	Capacity	RAID	PG	Paths
00:1A	OPEN-9	6.87 GB	5(3D+1P)	1 - 2	1
00:1B	OPEN-9	6.87 GB	5(3D+1P)	1 - 2	1
00:1C	OPEN-9	6.87 GB	5(3D+1P)	1 - 3	1
00:1D	OPEN-9	6.87 GB	5(3D+1P)	1 - 3	1
00:1E	OPEN-9	6.87 GB	5(3D+1P)	1 - 3	1
00:1F	OPEN-9	6.87 GB	5(3D+1P)	1 - 3	1
00:20	OPEN-9	6.87 GB	5(3D+1P)	1 - 3	1
00:21	OPEN-9	6.87 GB	5(3D+1P)	1 - 3	1
00:22	OPEN-9	6.87 GB	5(3D+1P)	1 - 3	1
00:23	OPEN-9	6.87 GB	5(3D+1P)	1 - 3	1

- Click **Add LU Path**. A message displays information about LU Paths to be defined.

The screenshot shows a dialog box titled "Command View XP" with the subtitle "Check paths". The text inside says "The paths will be defined. Do you want to continue?". Below the text is a table with columns for Port, Host Group, LUN, and CU:LDEV. The table contains one row with the values: CL1-A(71), alpha136, 05, and 00:01. At the bottom of the dialog are "OK" and "Cancel" buttons.

Port	Host Group	LUN	CU:LDEV
CL1-A(71)	alpha136	05	00:01

- Click **OK**. The settings are shown in blue in the LU Path table.
- Click **Apply** in the LUN Management main screen. A confirmation dialog box is displayed.
- Click **OK**. The settings are applied to the disk array.

## Changing or Viewing LU Path Settings

Topics for changing or viewing LU path settings include the following:

- Deleting LU paths (see page 215)
- Changing the name and host mode of a host group (see page 216)
- Deleting host groups (see page 218)
- Initializing the host group 0 (zero) (see page 219)
- Changing WWNs and nicknames (see page 220)
- Deleting host bus adapters from host groups (see page 222)
- Deleting unneeded WWNs from the WWN table (see page 223)
- Viewing a list of concatenated parity groups (see page 224)

## Deleting LU Paths

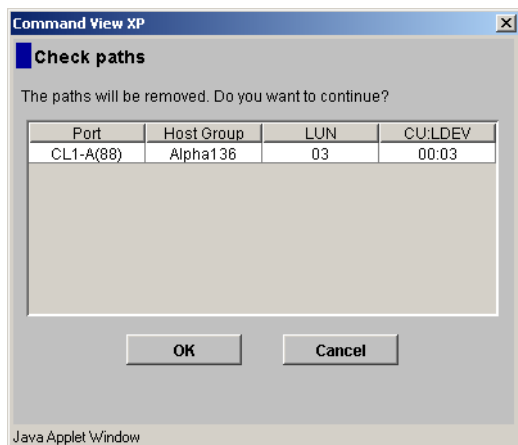
**To delete one or more LU paths:**

1. In the LU Path tree on the LUN Management main screen, click a port.
2. In the LU Path table, click one or more LUNs to which LDEVs are assigned (If an LDEV is assigned to a LUN, the columns on the right of the LUN column are not empty).
3. Right-click the selection. A pop-up menu is displayed.

LUN	CU:LDEV	Emulation	Capacity	RAID	Paths
00	00:00	OPEN-9	6.87 GB	5(3D+1P)	1
01	00:01	OPEN-9	6.87 GB	5(3D+1P)	1
02	00:02	OPEN-9	6.87 GB	5(3D+1P)	1
03			6.87 GB	5(3D+1P)	1
04			6.87 GB	5(3D+1P)	1
05			6.87 GB	5(3D+1P)	1
06			6.87 GB	5(3D+1P)	2
07	00:07	OPEN-9	6.87 GB	5(3D+1P)	1
08	00:08	OPEN-9	6.87 GB	5(3D+1P)	1
09	00:09	OPEN-9	6.87 GB	5(3D+1P)	1

Selected LUNs:1 Remaining LUNs(Port):490 Remaining LUNs(GRP):234

4. Click **Release LU Path** from the pop-up menu. A message displays information about LU Paths to be deleted.



5. Click **OK**. The settings are shown in blue in the LU Path table.
6. Click **Apply** in the LUN Management main screen. A confirmation dialog box is displayed.
7. Click **OK**. The settings are applied to the disk array.

## Changing the Name and Host Mode of a Host Group

Before changing the host mode of a host group, first back up the data on the port that the host group belongs to. The operation for changing host mode should not be destructive, but data integrity cannot be guaranteed without a backup.

To change the host mode for host group 0, port security can be either enabled or disabled. For all other host groups, you must enable port security first before changing the host mode.

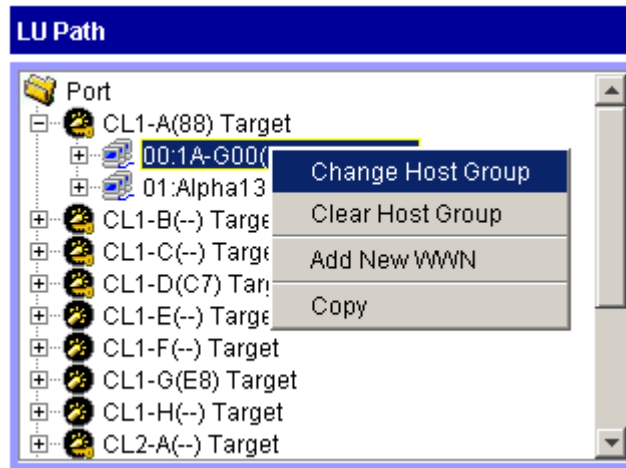
---

**Note:** You cannot perform this operation on host groups for NAS ports.

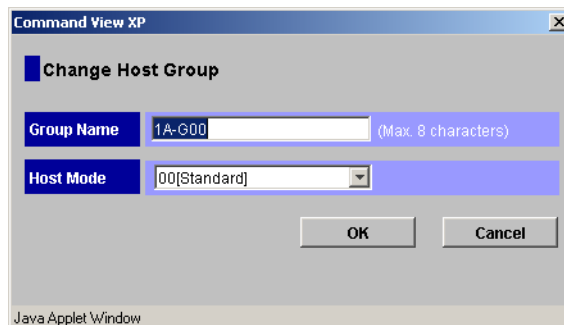
---

### To change the host group information:

1. In the LU Path tree on the LUN Management main screen, select and right-click the host group. A pop-up menu is displayed.



2. Click **Change Host Group** from the pop-up menu. The Change Host Group window is displayed.



**Figure 91: Change Host Group window**

3. To change the name of the host group, enter a new name in the **Group Name** field.
4. To change the host mode, select the new host mode from the **Host Mode** drop-down list.
5. Click **OK**. The settings are shown in blue in the LU Path table.
6. Click **Apply** in the LUN Management main screen. A confirmation dialog box is displayed.
7. Click **OK**. The settings are applied to the disk array.

## Deleting Host Groups

You cannot delete the host group 0 (zero). If you want to remove all the WWNs and LU paths from the host group 0, you must initialize the host group 0 (see [Initializing the Host Group 0 \(Zero\)](#) on page 219).

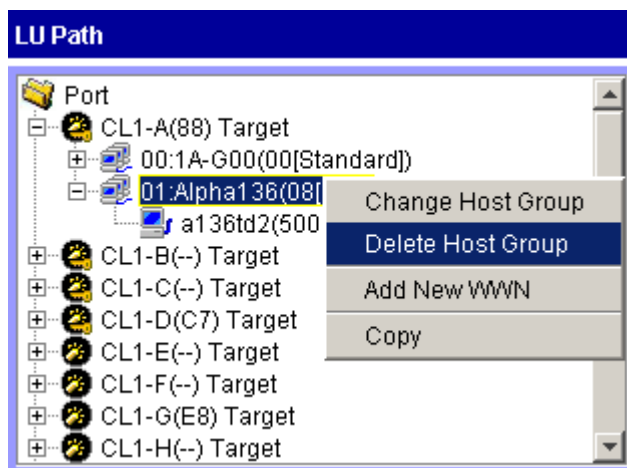
---

**Note:** You cannot perform this operation on host groups for NAS ports.

---

### To delete a host group:

1. In the LU Path tree on the LUN Management main screen, select and right-click the host group. A pop-up menu is displayed.



2. Click **Delete Host Group** from the pop-up menu. A confirmation dialog box is displayed.
3. Click **Yes** to delete the host group. The host group you specified no longer is displayed in the LU Path tree.
4. Click **Apply** in the LUN Management main screen. A confirmation dialog box is displayed.
5. Click **OK**. The settings are applied to the disk array.

## Initializing the Host Group 0 (Zero)

The following procedure explains how to set the host group 0 (zero) to its initial state. This removes all the WWNs from the host group 0 and all the LU paths related to the host group 0. This procedure also changes the host mode of the host group 0 to Standard and initializes the host group name. For example, if you initialize the host group 0 for the port CL1-A, the name of the host group 0 will change to 1A-G00.

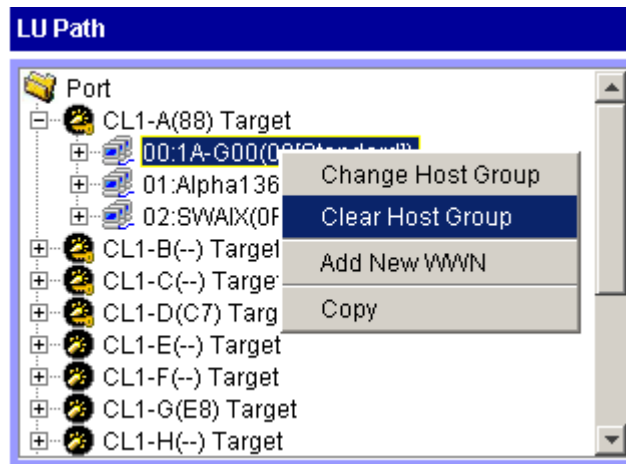
---

**Note:** You cannot perform this operation on host groups for NAS ports.

---

### To initialize the host group 0:


1. In the LU Path tree on the LUN Management main screen, select and right-click the host group 0. A pop-up menu is displayed.




2. Click **Clear Host Group** from the pop-up menu. A confirmation dialog box is displayed.
3. Click **Yes**. The host mode and the host group name of the host group 0 are changed in the LU Path tree. WWNs are also removed from the host group 0. LU paths are removed from the LU Path table on the right of the LU Path tree. The LUNs corresponding to the removed LU paths are shown in blue.
4. Click **Apply** in the LUN Management main screen. A confirmation dialog box is displayed.
5. Click **OK**. The settings are applied to the disk array.

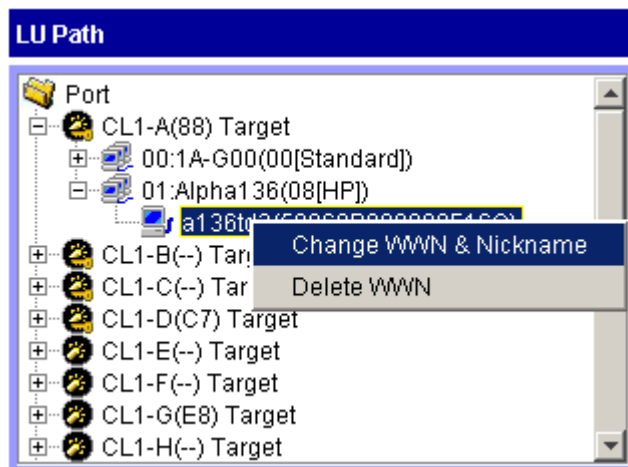
## Changing WWNs and Nicknames

### To change WWN and nickname information:

1. In the LU Path tree on the LUN Management main screen, locate the port that the HBA is connected to and verify that LUN security has been applied to the port. If the port icon contains a key (such as ) , then LUN security has been enabled.

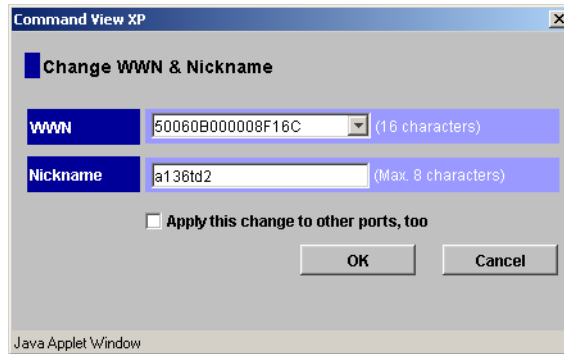
If the port icon does not contain a key (such as ) , select and right-click the port, and from the pop-up menu, click **LUN Security: OFF->ON** to enable LUN security.

2. In the LU Path tree, select and right-click the WWN. A pop-up menu is displayed.



3. Click **Change WWN & Nickname** from the pop-up menu. The Change WWN & Nickname window is displayed.





**Figure 92: Change WWN & Nickname window**

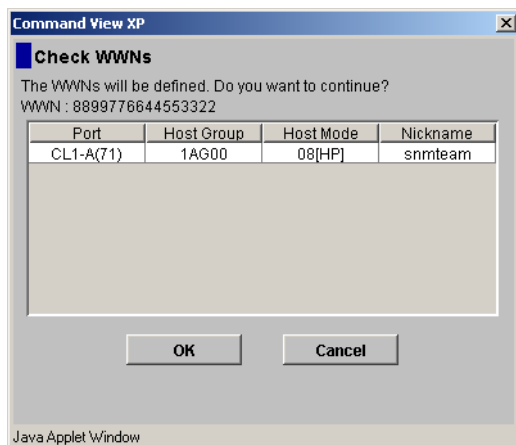
If the selected WWN is not registered in any host group, the Change WWN & Nickname window is not displayed.

4. In the **WWN** field, enter the WWN, or in the **WWN** drop-down list, click a WWN.
5. In the **Nickname** field, enter the new nickname.
6. If necessary, select the **Apply this change to other ports, too** check box.

If this check box is selected, the change in the panel will also affect other ports. For example, if the same host bus adapter (or the same WWN) is located below the ports CL1-A and CL2-A in the tree and if you select the host bus adapter (or the WWN) from below one of the ports and change the name to *hba1*, then the host bus adapter below the other port will also be renamed *hba1*.

7. Click **OK**.

If you selected the **Apply this change to other ports, too** check box, the Check WWNs window is displayed. To accept the changes to the other ports, click **OK**. If not, click **Cancel**. The changes are shown in blue.



8. Click **Apply** in the LUN Management main screen. A confirmation dialog box is displayed.
9. Click **OK**. The settings are applied to the disk array.

## Deleting Host Bus Adapters from Host Groups

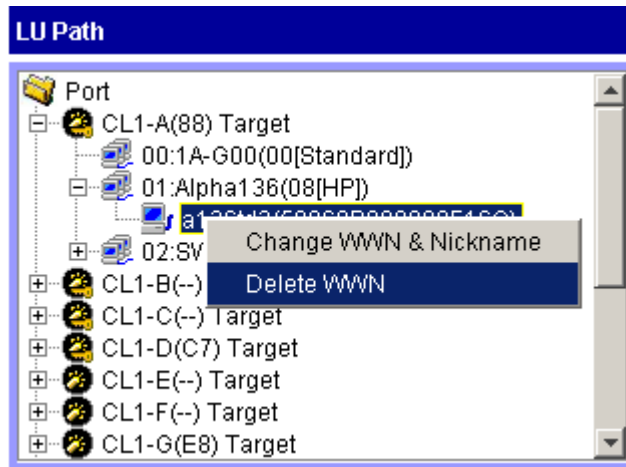
---

**Note:** You cannot perform this operation on host groups for NAS ports.

---

### To delete an HBA from a host group:

1. In the LU Path tree on the LUN Management main screen, select and right-click the HBA. A pop-up menu is displayed.



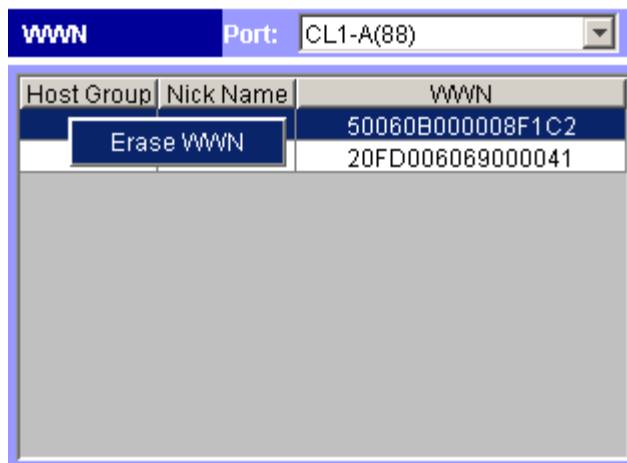
2. Click **Delete WWN** from the pop-up menu. A confirmation dialog box is displayed.
3. Click **Yes**. The WWN you specified no longer is displayed in the LU Path tree.
4. Click **Apply** in the LUN Management main screen. A confirmation dialog box is displayed.
5. Click **OK**. The settings are applied to the disk array.

## Deleting Unneeded WWNs from the WWN Table

If you disconnect a host that has been connected through a cable to your disk array, the WWN for the host will remain in the WWN table of the LUN Management main screen. Complete the procedure in this section to remove the WWN from the WWN table.

**To delete the WWN from the WWN table for a host no longer connected to a disk array:**

1. In the WWN table on the LUN Management main screen, locate the WWN that is not registered in any host group. If the Host Group column is blank, the WWN is not registered in any host group.
2. Select and right-click the WWN you want to delete. A pop-up menu is displayed.



3. Click **Erase WWN** from the pop-up menu.
4. Click **Apply** in the LUN Management main screen. A confirmation dialog box is displayed.
5. Click **OK**. The settings are applied to the disk array.

## Viewing a List of Concatenated Parity Groups

The XP128/XP1024 supports concatenation of parity groups. If parity groups are concatenated, a logical volume can be dispersed across the concatenated parity groups. Dispersal of logical volumes can provide faster access to data (particularly, faster sequential access to data).

### To view a list of concatenated parity groups:

1. In the LDEV table on the LUN Management main screen, select and right-click a logical volume (an LDEV). A pop-up menu is displayed. If the parity groups are concatenated, the **Concatenation List** command is displayed in pop-up menu.
2. Click **Concatenation List** from the pop-up menu. The Concatenation List window is displayed.
3. When you are finished viewing the information, click **OK** to return to the LUN Management main screen.

## Defining Alternate Paths

LUN Management can define alternate paths. If one LU path fails, you can switch to its alternate path.

To create an alternate path, copy the original path from one port to another. For example, to define an alternative for the LU path from the CL1-A port to the logical volume 00:01, copy the LU path from the CL1-A port to another port.

If you want to define alternate paths when LUN security is removed, you must redefine the LU path.

In order to use alternate paths, you must copy LU paths from one port to another. The procedure to follow depends on the type of port:

- To copy paths from one Fibre Channel port to another, see page 225
- To copy paths from one NAS port to another, see page 227
- To copy paths from a Fibre Channel port to a NAS Port, see page 229
- To copy paths from a NAS Port to a Fibre Channel Port, see page 230


## Copying Paths from One Fibre Channel Port to Another


---

**Caution:** Before taking the following steps, see [Restrictions on Port Operations](#) page 252 for important information.

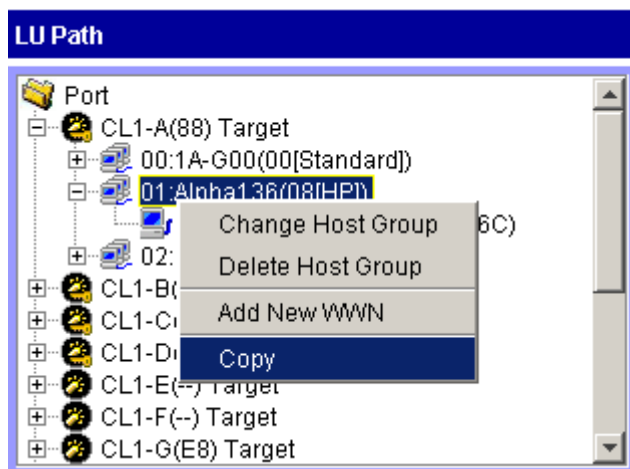
---

To define alternate paths:

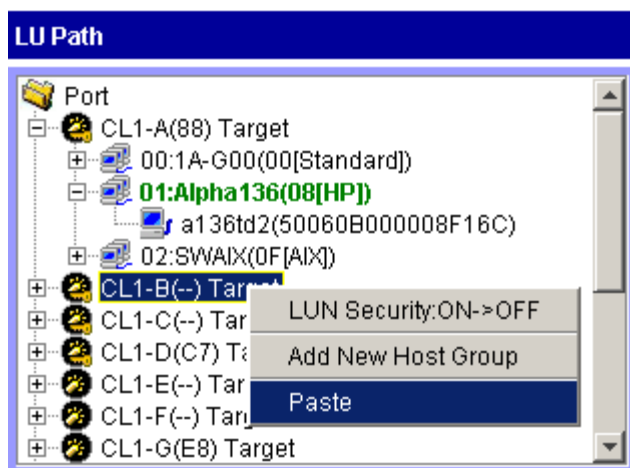
1. In the LU Path tree on the LUN Management main screen, locate the port that you want to use as the copy destination and verify that LUN security has been applied to the port. If the port icon contains a key (such as ) , then LUN security has been enabled.

If the port icon does not contain a key (such as ) , select and right-click the port, and from the pop-up menu, click **LUN Security: OFF->ON** to enable LUN security.

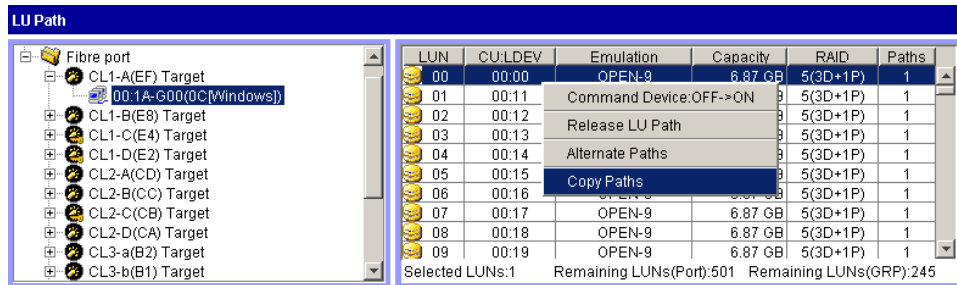
2. If you want to copy all the LU paths defined to a host group, complete the following steps:
  - a. Select and right-click a host group in the tree view and then click **Copy** from the pop-up menu. The selected host group turns green.



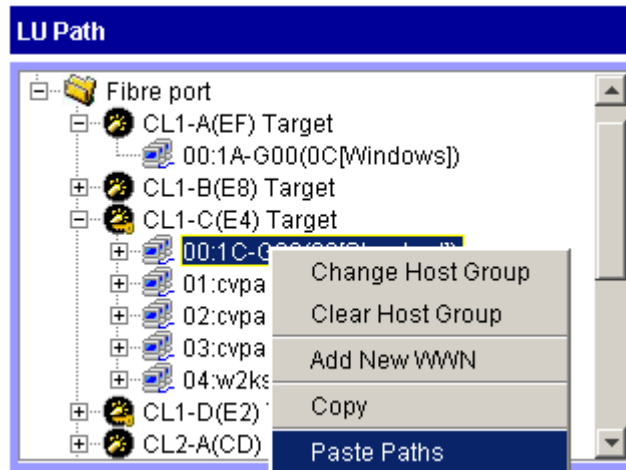
- b. Right-click the copy destination port and then click **Paste** from the pop-up menu.



3. If you want to copy some, but not all the LU paths defined to a host group, complete the following steps:
  - a. In the LU Path tree, click a host group. In the LU Path table on the right, click one or more LUNs to which volumes are assigned.
  - b. Right-click the selection and then click **Copy Paths** from the pop-up menu. The selected LUNs turn green.



- c. Double-click the copy destination port.
- d. Select and right-click the copy destination host group, and then click **Paste Paths** from the pop-up menu.



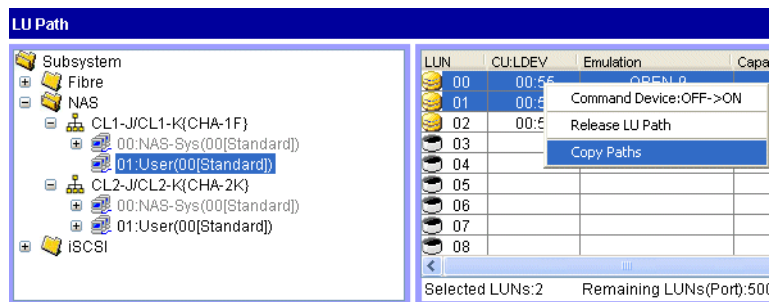
4. Click **Apply** in the LUN Management main screen. A confirmation dialog box is displayed.
5. Click **OK**. The settings are applied to the disk array.

## Copying Paths from One NAS Port to Another

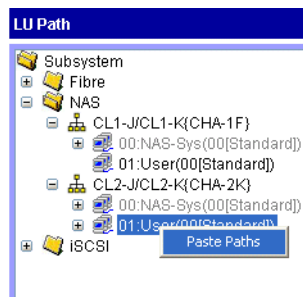
**Caution:** Before taking the following steps, see [Restrictions on Port Operations](#) page 252 for important information.

To define alternate paths:

1. Take the following steps to specify the LU paths that you want to copy:
  - a. In the LU Path tree on the LUN Management main screen, double click a **NAS** port (the copy source port) and then select the **User** host group.
  - b. From the **LU Path** table on the right, select one or more LUNs to which volumes are assigned. (If a volume is assigned to an LUN, the columns on the right of the **LUN** column are not empty.)
  - c. Right-click the selection and then select **Copy Paths** from the pop-up menu. The selected LUNs turn green.



2. Take the following steps to paste the LU paths:
  - a. In the LU Path tree, double-click the copy destination port (a NAS port) to display the **User** host group below the port.
  - b. Right-click the **User** host group and then select **Paste Paths** from the pop-up menu.



3. Click **Apply** in the LUN Manager tab. A confirmation dialog box is displayed.
4. Click **OK**. The settings are applied to the disk array.

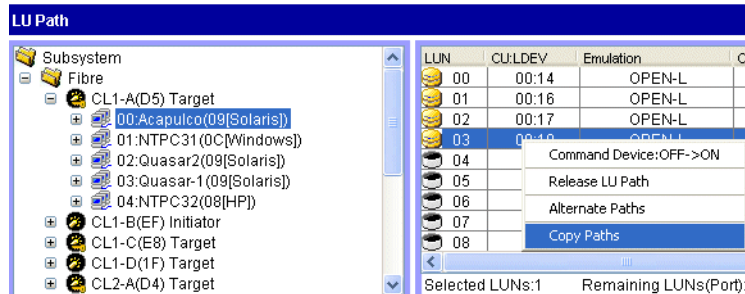


## Copying Paths from a Fibre Channel Port to a NAS Port

**Caution:** Before taking the following steps, see [Restrictions on Port Operations](#) page 252 for important information.

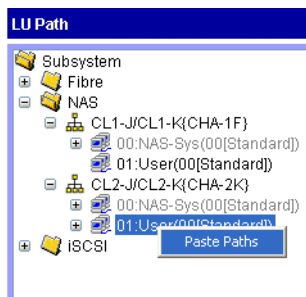
To define alternate paths:

1. Take the following steps to specify the LU paths that you want to copy:
  - a. In the LU Path tree on the LUN Management main screen, double click a Fibre Channel port (the copy source port) and then select a host group. The **LU Path** table on the right displays information about LU paths.
  - b. In the table, select one or more LUNs to which volumes are assigned. (If a volume is assigned to an LUN, the columns on the right of the LUN column are not empty.)
  - c. Right-click the selection and then select **Copy Paths** from the pop-up menu. The selected LUNs turn green.



2. Take the following steps to paste the LU paths:
  - a. In the tree view, double-click a NAS port (the copy destination port) to display the **User** host group below the port.

- b. Right-click the **User** host group and then select **Paste Paths** from the pop-up menu.



3. Click **Apply** in the LUN Manager tab. A confirmation dialog box is displayed.
4. Click **OK**. The settings are applied to the disk array.

## Copying Paths from a NAS Port to a Fibre Channel Port

---

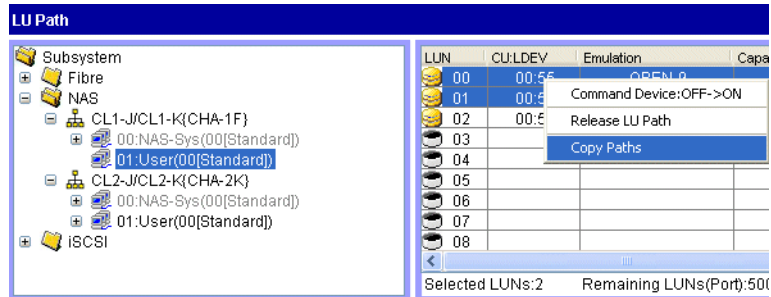
**Caution:** Before taking the following steps, see [Restrictions on Port Operations](#) page 252 for important information.


---


To define alternate paths:

1. Take the following steps to specify the LU paths that you want to copy:
  - a. In the LU Path tree on the LUN Management main screen, double click a NAS port (the copy source port) and then select the **User** host group.
  - b. From the **LU Path** table on the right, select one or more LUNs to which volumes are assigned. (If a volume is assigned to an LUN, the columns on the right of the LUN column are not empty.)

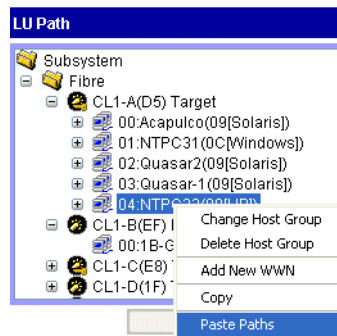
- c. Right-click the selection and then select **Copy Paths** from the pop-up menu. The selected LUNs turn green.



2. In the LU Path tree on the LUN Management main screen, locate the Fibre Channel port that you want to use as the copy destination and verify that LUN security has been applied to the port. If the port icon contains a key (such as ) , then LUN security has been enabled.

If the port icon does not contain a key (such as ) , select and right-click the port, and from the pop-up menu, click **LUN Security: OFF->ON** to enable LUN security.

3. Take the following steps to paste the LU paths:
- Double-click the Fibre Channel port (the copy destination port) to display host groups below the port.
  - Right-click the host group to which you want to paste paths and select **Paste Paths** from the pop-up menu.



- Click **Apply** in the LUN Manager tab. A confirmation dialog box is displayed.
- Click **OK**. The settings are applied to the disk array.

## Displaying Alternate Paths

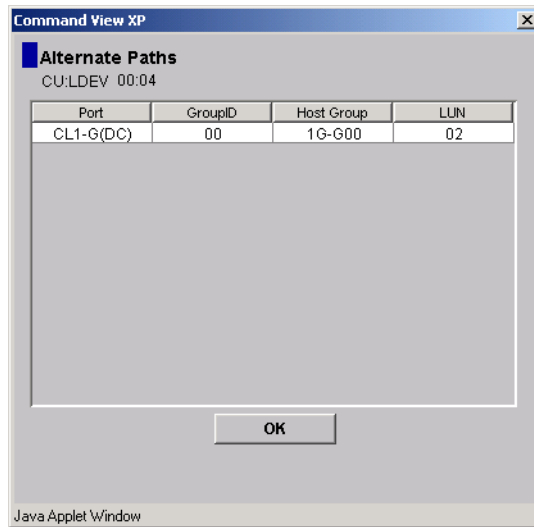
### To display a list of alternate paths:

1. From the LUN Management main screen, do one of the following:
  - In the LU Path table, click a LUN containing one or more paths.
  - In the LDEV table, click an LDEV containing one or more paths.
2. Right-click the selection. A pop-up menu is displayed.

LDEV	Emulation	Capacity	RAID	PG	Paths
00:1A	OPEN		5(3D+1P)	1 - 2	1
00:1B	OPEN		5(3D+1P)	1 - 2	1
00:1C	OPEN-9	6.87 GB	5(3D+1P)	1 - 3	1
00:1D	OPEN-9	6.87 GB	5(3D+1P)	1 - 3	1
00:1E	OPEN-9	6.87 GB	5(3D+1P)	1 - 3	1
00:1F	OPEN-9	6.87 GB	5(3D+1P)	1 - 3	1
00:20	OPEN-9	6.87 GB	5(3D+1P)	1 - 3	1
00:21	OPEN-9	6.87 GB	5(3D+1P)	1 - 3	1
00:22	OPEN-9	6.87 GB	5(3D+1P)	1 - 3	
00:23	OPEN-9	6.87 GB	5(3D+1P)	1 - 3	

Selected LDEVs:1

3. Click **Alternate Paths** from the pop-up menu. The Alternate Paths window is displayed.



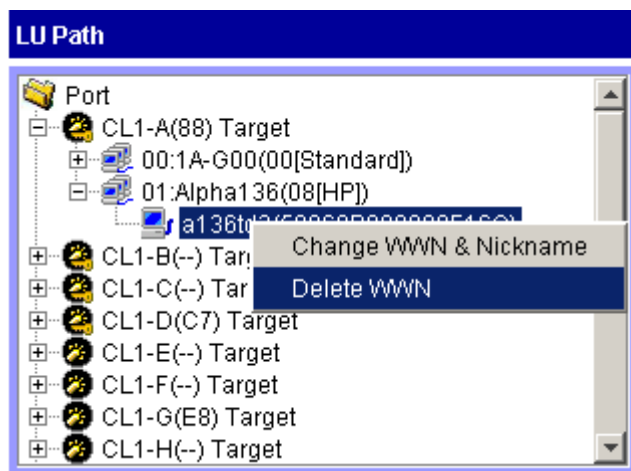
**Figure 93: Alternate Paths window**

4. Click **OK**.

## Deleting WWNs

### To delete a WWN:

1. In the LU Path tree on the LUN Management main screen, select and right-click a WWN. A pop-up menu is displayed.




---

**Note:** If the selected WWN is not registered in any host group, the **Delete WWN** command is not displayed.

---

2. Click **Delete WWN** from the pop-up menu. A confirmation dialog box is displayed.
3. Click **Yes** to confirm the deletion. The WWN you specified no longer is displayed in the LU Path tree.
4. Click **Apply** in the LUN Management main screen. A confirmation dialog box is displayed.
5. Click **OK**. The settings are applied to the disk array.

## Applying and Removing LUN Security

By default, LUN security is not applied to any of the ports. When configuring your system, you must apply LUN security to the ports. If a port has the External attribute, you cannot apply LUN security to the port. The 🌟 icon indicates a port without LUN security and changes to a 🌟 icon when LUN security is applied.

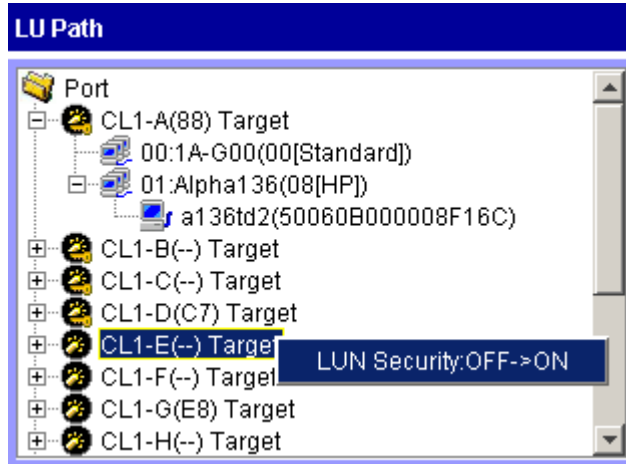
---

**Note:** You cannot apply LUN security to NAS ports.

---

**To apply or remove LUN security to or from a port:**

1. In the LU Path tree on the LUN Management main screen, select and right-click a port. A pop-up menu is displayed.






2. To apply LUN security, click **LUN Security: OFF->ON** from the pop-up menu. A confirmation dialog box is displayed.

To remove LUN security, click **LUN Security: ON->OFF** from the pop-up menu. A confirmation dialog box is displayed.

3. Click **Yes** to confirm. The changes are shown in blue.
4. Click **Apply** in the LUN Management main screen. A confirmation dialog box is displayed.
5. Click **OK**. The settings are applied to the disk array.

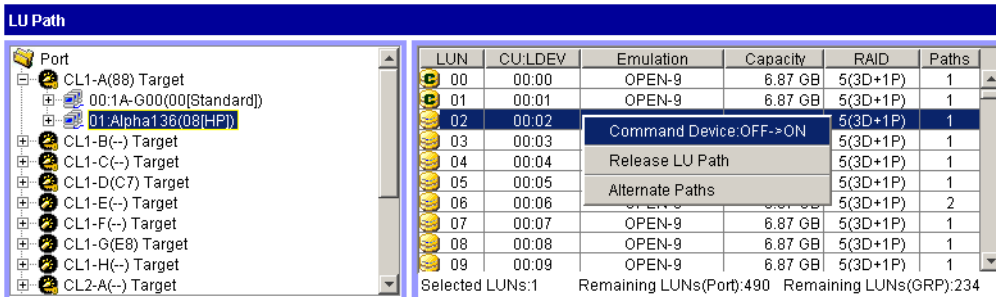
## Creating RAID Manager Command Devices

To enter RAID Manager commands, set up at least one logical unit as a command device. In addition to explaining how to set an LU as a command device, this section also discusses how to apply command device security and how to no longer use an LU as a command device.

The  icon indicates an LDEV that is not a command device and changes to a  icon when set to a command device. When security is enabled, the icon changes to .

**To set an LU as a command device:**

1. In the LU Path tree on the LUN Management main screen, double-click a port and then click a host group.
2. In the LU Path or LDEV table, select and right-click the LUN. A pop-up menu is displayed.



3. Click **Command Device: OFF->ON** from the pop-up menu. A confirmation dialog box is displayed.

If the pop-up menu displays **Command Device: ON->OFF**, the logical device is already specified as a command device and therefore you do not need to go through the remaining steps in this procedure.

4. Click **Yes** to confirm. The changes are shown in blue.
5. Click **Apply** in the LUN Management main screen. A confirmation dialog box is displayed.
6. Click **OK**. The settings are applied to the disk array.

**To no longer use an LU as a command device:**

- Select and right-click the command device. Click **Command Device: ON->OFF** from the pop-up menu.

**To apply command device security:**

- Select and right-click the command device. Click **Cmd. Dev. Security: OFF->ON** from the pop-up menu.



The screenshot shows the 'LU Path' management window. On the left, a tree view shows a 'Port' containing several 'CL1-A(88) Target' sub-items, with '01:Alpha136(08[HP])' selected. On the right, a table lists LUNs with columns for LUN, CU:LDEV, Emulation, Capacity, RAID, and Paths. LUN 02 is selected, and a context menu is open over it, showing options: 'Command Device:ON->OFF', 'Cmd Dev. Security:OFF->ON', 'Release LU Path', and 'Alternate Paths'. At the bottom, status information reads: 'Selected LUNs:1 Remaining LUNs(Port):481 Remaining LUNs(GRP):233'.

LUN	CU:LDEV	Emulation	Capacity	RAID	Paths
00	00:00	OPEN-9	6.87 GB	5(3D+1P)	1
01	00:01	OPEN-9	6.87 GB	5(3D+1P)	1
02	00:02	OPEN-9	6.87 GB	5(3D+1P)	1
03	00:03	OPEN-9	6.87 GB	5(3D+1P)	1
04	00:04	OPEN-9	6.87 GB	5(3D+1P)	1
05	00:05	OPEN-9	6.87 GB	5(3D+1P)	1
06	00:06	OPEN-9	6.87 GB	5(3D+1P)	1
07	00:07	OPEN-9	6.87 GB	5(3D+1P)	1
08	00:08	OPEN-9	6.87 GB	5(3D+1P)	1
09	00:09	OPEN-9	6.87 GB	5(3D+1P)	1

### To remove command device security:

- Select and right-click the command device. Click **Cmd. Dev. Security: ON->OFF** from the pop-up menu.

## Port Operations

Port operation topics include the following:

- Starting Port operations (see page 238)
- Port screen (see page 239)
- Setting the fibre channel topology (see page 241)
- Setting the fibre channel port addresses (see page 241)
- Setting the data transfer speed (see page 241)
- Switching to standard, high-speed, or high-speed (2 port) mode (see page 242)

### Starting Port Operations


Click the **Port** tab of the LUN Management screen to configure ports in your disk array. You can also use this screen to modify the port configuration when the disk array is operating.

---

**Note:** You cannot use the **Port** tab to make settings on NAS ports.

---

#### To start Port operations:

1. From the Launch screen, click an XP128 or XP1024.
2. Click the **LUN and Volume Mgmt** tab, and then click the **LUN Management** button (). The LUN Management main screen is displayed.
3. Click the **Port** tab. The Port screen is displayed.

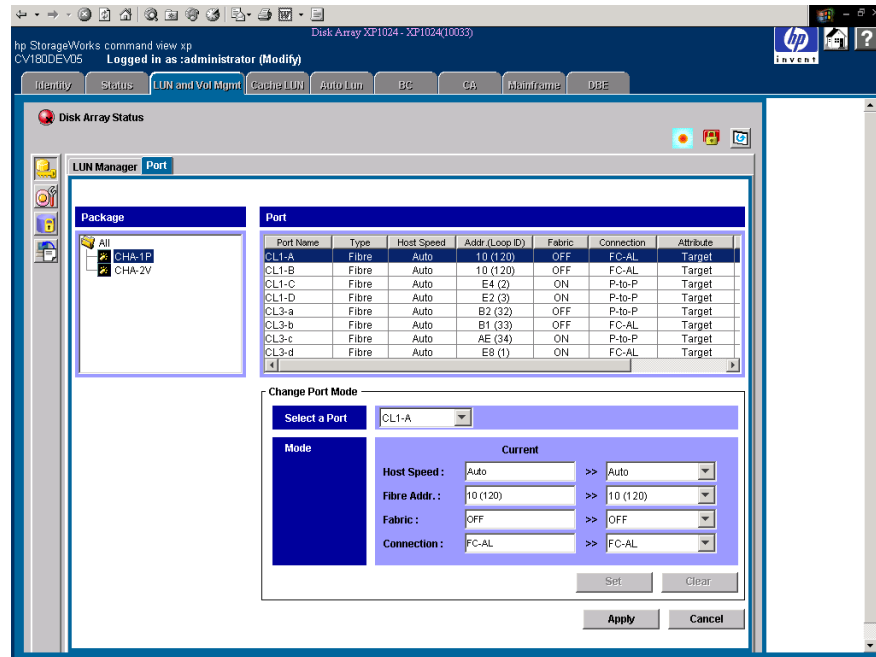


Figure 94: Port screen (LUN Management screen)

## Port Screen





### Package tree

The Package tree displays all the Fibre Channel channel adapter (CHA) packages. When you select and right-click a CHA package, you can choose standard mode, high-speed mode, or high-speed (2 port) mode.

**Note:** High-speed (2 port) mode is available only if the XP disk array has firmware version 21.06.22 or later installed.

The following icons are used to indicate the status:

**Table 18: Channel adapter package icons for Port operations**

Icon	Status
	A short-wave CHA package in standard mode.
	A long-wave CHA package in standard mode.
	A short-wave CHA package in high-speed or high-speed (2 port) mode.
	A long-wave CHA package in high-speed or high-speed (2 port) mode.

### Port table

The table displays information about the ports in the CHA packages selected in the Package tree.

The table contains the following columns:

- **Port Name:** Displays port names.
- **Type:** “Fibre” indicates a Fibre Channel port, used for connecting open system hosts. “MF-Serial” indicates an ESCON port, used for connecting mainframe hosts.
- **Host Speed:** Used to specify the data transfer speed for Fibre Channel ports. If Auto is selected, the disk array automatically sets the data transfer speed to 1GB/sec or 2GB/sec.
- **Addr (Loop ID):** Displays addresses of ports. You can change port addresses.
- **Fabric:** Specify ON if a fabric switch is used, or OFF if no Fabric switch is used.
- **Connection:** Used to specify the topology. The default is FC-AL. However, some fabric switches require you to specify point-to-point topology. Check the switch’s documentation.
- **Attribute:** Indicates whether the port is an initiator port, a target port, an RCU target port, or an external port.
- **WWN:** Displays WWNs of ports.

### Change Port Mode box

Use the fields in this box to change information in the Port table.

## Setting the Fibre Channel Topology

### To set the Fibre Channel topology:

1. In the Port table or the **Select a Port** drop-down list on the Port screen, click a Fibre Channel port.
2. If a fabric switch is used, click **ON** in the **Fabric** drop-down list in the Mode area. If a fabric switch is not used, click **OFF** in the **Fabric** drop-down list in the Mode area.
3. In the **Connection** drop-down list, click **FC-AL** or **P-to-P**.  
If a fabric switch is used, consult the switch's documentation to check if it requires point-to-point topology.
4. Click **Set**. A confirmation dialog box is displayed.
5. Click **OK**. The settings are applied to the Port table (shown in blue), but not to the disk array.
6. Click **Apply**. A confirmation dialog box is displayed.
7. Click **OK**. The settings are applied to the disk array.

## Setting Fibre Channel Port Addresses

### To set the Fibre Channel address:

1. In the Port table or the **Select a Port** drop-down list on the Port screen, click a Fibre Channel port.
2. In the **Fibre Address** drop-down list in the Mode area, click an address.
3. Click **Set**. A confirmation dialog box is displayed.
4. Click **OK**. The settings are applied to the Port table (shown in blue), but not to the disk array.
5. Click **Apply**. A confirmation dialog box is displayed.
6. Click **OK**. The settings are applied to the disk array.

## Setting the Data Transfer Speed

### To set the data transfer speed:

1. In the Port table or the **Select a Port** drop-down list on the Port screen, click a Fibre Channel port.

2. In the **Host Speed** drop-down list in the Mode area, click a data transfer speed.
3. Click **Set**. A confirmation dialog box is displayed.
4. Click **OK**. The settings are applied to the Port table (shown in blue), but not to the disk array.
5. Click **Apply**. A confirmation dialog box is displayed.
6. Click **OK**. The settings are applied to the disk array.

## Switching to Standard, High-Speed, or High-Speed (2 Port) Mode

Channel adapter boards can be set for standard mode, high-speed, or high-speed (2 port) mode. If possible, apply high-speed mode to channel adapters to improve the system performance. Be aware that you can only apply high-speed or high-speed (2 port) mode to channel adapters that satisfy certain requirements.

---

**Note:** High-speed (2 port) mode is available only if the XP disk array has firmware version 21.06.22 or later installed.

---

### To switch to a different the mode:

1. In the Package tree on the Port screen, select and right-click a channel adapter (CHA) package. A pop-up menu is displayed. The current mode is preceded by a bullet.
2. Click the mode that you want. A confirmation dialog box is displayed.
3. Click **OK** to confirm the change.
4. Click **Apply**. A confirmation dialog box is displayed.
5. Click **OK**. The settings are applied to the disk array.

## Partial Cache Residence (PCR) Operations

### Overview of the PCR Function

The XP1028/XP1024 disk array has a special network board that enables the array to be connected directly to a LAN. This network connection interface is called Network Attached Storage (NAS).

The NAS disk array uses a cache to store two types of data:

- management information (called *i-node*), including information on managing file system directories and file pointers
- log information, used by the NAS channel file system to improve performance of data throughput in the LAN via the NAS channel

This cache function is called *Partial Cache Residence (PCR)*. A PCR cache is assigned to each channel, and the PCR cache is shared and used by all files that are accessed via NAS channels. User data transferred via a NAS channel uses the ordinary cache area. The figure below shows the PCR cache area (cache extent).

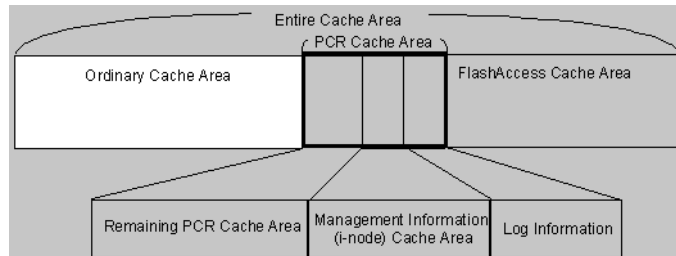


Figure 95: PCR Cache Area (Cache Extent)

### Starting PCR Operations

**To start PCR operations:**

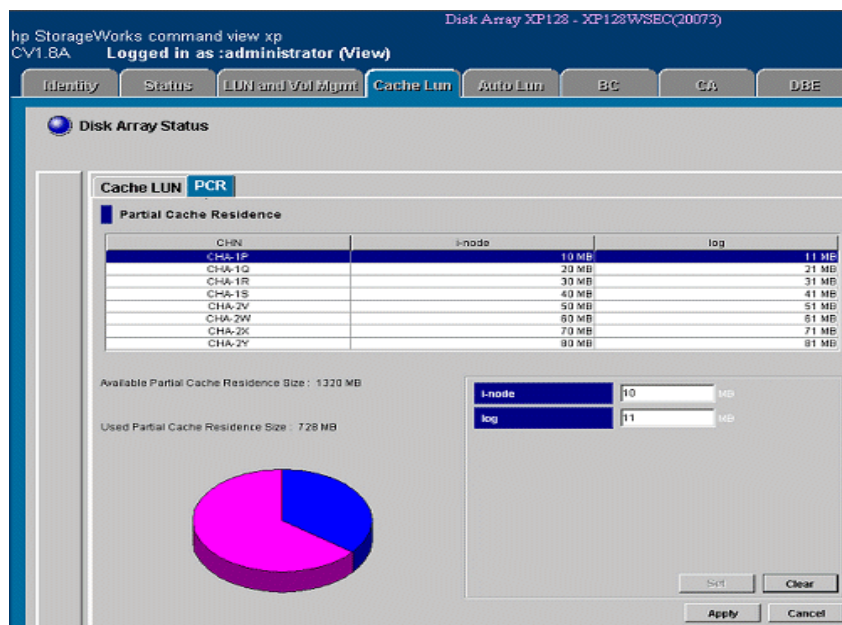
1. In the Launch screen, select modify mode in order to perform PCR operations.

---

**Note:** You must select modify mode to perform PCR operations. If you are in view mode you can only view PCR information.

---

2. From the Launch screen, click an XP128 or XP1024.
3. Click the **Cache LUN** tab, and then click the **PCR** tab. The PCR main panel is displayed.



**Figure 96: PCR Main Panel**

You can perform PCR operations from the PCR main panel.

## PCR Main Panel

The PCR main panel displays the table of NAS channels available for PCR operations, as well as a pie chart showing PCR cache usage. You can set the PCR cache size for management information (i-node) and log information used by the NAS channel file system.

---

**Note:** You must select modify mode to perform PCR operations. If you select view mode you can only view PCR information.

---

The PCR main panel has the following features:



- The PCR information table, located in the upper part of the PCR main panel, displays the PCR cache size for both management information (i-node) and for log information files used to manage data on NAS channels.
  - The **CHN** column displays the name of the NAS channel.
  - The **i-node** column displays the cache size assigned to the area used by the NAS channel file system for two types of management: *current status management* (i-node) and *directory management*.
  - The **log** column displays the cache size assigned to the area used for obtaining log information on NAS channels.
- The PCR information area, located above the pie chart, displays two fields with PCR cache usage information:
  - **Available Partial Cache Residence Size:** the amount of the PCR cache available for use (pink area in the pie chart).
  - **Used Partial Cache Residence Size:** the amount of PCR cache currently in use (blue and/or yellow areas in the pie chart).
- Pie chart. The pie chart uses the following colors:
  - **Blue:** PCR cache usage
  - **Yellow:** the increase in the specified size of the PCR cache
  - **Pink:** the remaining amount of available PCR cache
- The PCR operations box, located on the lower right corner of the PCR main panel, allows you to set the PCR cache size for both management information (i-node) and log information used by the NAS channel selected in the PCR information table. You can select several NAS channels at once.
  - The **i-node** field allows you to enter the amount of cache assigned to the area used by the NAS channel file system for current status management (i-node) and directory management.
  - The **log** field allows you to enter the amount of cache assigned to the area used for obtaining log information on NAS channels.
- The **Set** button adds the requested PCR operation (set PCR cache) to the PCR information table.
- The **Clear** button enters 0 (zero) into both the **i-node** and **log** fields.
- The **Apply** button starts the requested operation(s) listed in the PCR information table.
- The **Cancel** button cancels the requested operation(s) and resets the PCR information table.

## PCR Operations

PCR operations topics include the following:

- Viewing the current PCR settings
- Setting the PCR cache

### Viewing the current PCR settings

You can view the current PCR settings in the PCR main panel.

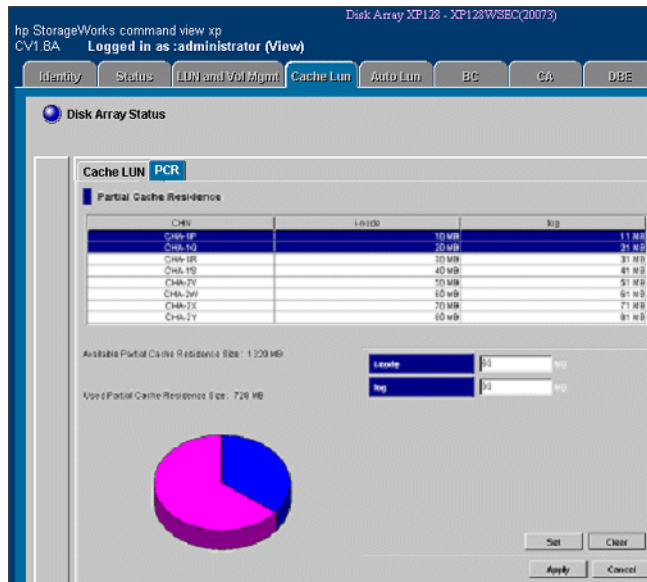
- The PCR information table shows the current PCR cache size for management information (i-node) and for log information files that are used to manage data on NAS channels.
- The 3D pie chart shows current cache usage.

### Setting the PCR cache

**To set PCR cache for management information (i-node) and log information:**

1. Connect to the desired disk array and log on with Administrator or PCR write access.
2. Open the PCR main panel. Make sure that you are in modify mode.

- Click the desired NAS channel in the PCR information table. You can select more than one channel at a time.



- Enter desired values (the capacities of PCR cache) in the **i-node** and **log** fields.

---

**Note:** If you want to enter 0 (zero) in both boxes, click the **Clear** button.

---

- Click **Set**.  
A confirmation message is displayed.
- Click **OK** to continue your operations.

The requested PCR operation is displayed in blue bold italics in the PCR information table.

hp StorageWorks command view xp  
CV1.8A Logged in as :administrator (View)  
Disk Array XP128 - XP128W5BC(20073)

Identity Status LUN and VOl Mgmt **Cache LUN** Auto LUN BC CA DBE

● Disk Array Status

Cache LUN PCR

FlashAccess: PCR

Partial Cache Residence

Cache LUN	hide	top
CLUN 01	<b><i>50 MB</i></b>	20 MB
CLUN 02	50 MB	50 MB
CLUN 03	10 MB	31 MB
CLUN 04	49 MB	41 MB
CLUN 05	70 MB	51 MB
CLUN 06	60 MB	61 MB
CLUN 07	60 MB	61 MB

Available Partial Cache Residence Size: 1222 MB

Used Partial Cache Residence Size: 826 MB

Apply Cancel

7. Repeat steps (3)-(6) until all desired operations are listed.
8. Review the requested operation(s) in the PCR main panel.
  - To start the operation(s), click **Apply** in the PCR main panel. The Apply confirmation message appears.
  - Click **OK**. The Complete confirmation message appears.
  - To cancel the operation(s), click **Cancel** in the PCR main panel, and then click **OK** in the Cancel confirmation message.
9. To confirm the operations, click **OK** in the Complete confirmation message.

The PCR main panel is displayed.

hp StorageWorks command view xp  
CV1.8A Logged in as administrator (View)  
Disk Array XP128 - XP128W5BC(20073)

Identity Status LUN and VOl Mgmt Cache LUN Auto LUN BC CA DBE

Disk Array Status

Cache LUN PCR

FlashAccess: PCR

Partial Cache Residence

Cache LUN	Cache Size	Cache Type	Cache State
Cache_1P	50 MB	Partial	Ready
Cache_1Q	50 MB	Partial	Ready
Cache_1R	50 MB	Partial	Ready
Cache_1S	40 MB	Partial	Ready
Cache_1T	50 MB	Partial	Ready
Cache_2W	50 MB	Partial	Ready
Cache_2X	50 MB	Partial	Ready
Cache_2Y	50 MB	Partial	Ready

Available Partial Cache Residence Size: 1222 MB

Used Partial Cache Residence Size: 820 MB

3D pie chart showing the distribution of cache residence sizes.

OK Cancel Apply Cancel

10. Monitor the PCR main panel to make sure that the operation(s) complete successfully.

## Operational Restrictions

The success of some LUN Management activities depends on the status of the security switch and whether I/O is active or inactive to the port or LUN. The following tables describe those restrictions.

Notes:

- If you attempt to apply a large number of the settings in the LUN Management panels in a single session, the XP128/XP 1064 might be unable to continue processing. It is recommended that you apply no more than 1,000 settings per session. Note that a large number of settings are likely to be applied when you define alternate paths (see [Defining Alternate Paths](#) page 225), even though only two commands are required to define alternate paths.
- Do not remove LU paths (see [Deleting LU Paths](#) page 215) when the hosts are performing I/O processing.
- Do not remove LUN security (see [Applying and Removing LUN Security](#) page 234) when the hosts are performing I/O processing.

## Restrictions on LUN Management Operations

**Table 19: LUN Management operation restrictions (XP128/XP1024)**

Activity		Security Switch OFF		Security Switch ON	
		Host Group 0	Host Group 01-7F	Host Group 0	Host Group 01-7F
Setting the LUN Security Switch ON	With active I/O on port	Permitted with confirmation message	Invalid operation	Invalid operation	
	With no active I/O on port				
Setting the LUN Security Switch OFF	With active I/O on port	Invalid operation		Permitted with confirmation message	
	With no active I/O on port				

**Table 19: LUN Management operation restrictions (XP128/XP1024) (Continued)**

Activity		Security Switch OFF		Security Switch ON	
		Host Group 0	Host Group 01-7F	Host Group 0	Host Group 01-7F
Adding a host group	With active I/O on port	Default host group	Not permitted	Default host group	Permitted
	With no active I/O on port				
Adding a WWN	With active I/O on port	Invalid operation		Permitted	
	With no active I/O on port				
Adding a LUN	With active I/O on port	Permitted	Invalid operation	Permitted	
	With no active I/O on port				
Deleting a WWN	With active I/O on port	Invalid operation		Permitted with confirmation message	
	With no active I/O on port				
Deleting a LUN	With active I/O to deleted LUN	Not permitted	Invalid operation	Not permitted	
	With no active I/O on LUN	Permitted		Permitted	
Deleting a command device	With active I/O on LUN	Not permitted	Invalid operation	Not permitted	
	With no active I/O on LUN	Permitted		Permitted	
Deleting a host group	With active I/O on LUN	Not permitted	Invalid operation	Not permitted	
	With no active I/O on LUN			Not permitted	Permitted

## Restrictions on Port Operations

**Table 20: Port operation restrictions (XP128/XP1024)**

Activity		
Changing Topology	With active I/O on LUN	Not permitted
	With no active I/O on LUN	Permitted
Changing Fibre Address	With active I/O on LUN	Not permitted
	With no active I/O on LUN	Permitted
Changing Host Speed	With active I/O on LUN	Not permitted
	With no active I/O on LUN	Permitted
Changing PCB Mode	With active I/O on LUN	Not permitted
	With no active I/O on LUN	Permitted
Changing Host Mode	With active I/O on LUN	Not permitted
	With no active I/O on LUN	Permitted



# LUN Security for the XP48/XP256/XP512

## 12

Use LUN Security to restrict LUN availability to specified hosts, using the hosts' worldwide names (WWNs). Unauthorized hosts cannot access a secured LUN and its data.

You can secure some or all of the LUNs on a port. You can consolidate LUNs into LUN groups to help simplify this task. Use a LUN group to assign a group of LUNs to a host under a single LUN group name.

You can also combine host WWNs into WWN groups. For the XP256, you can assign up to 32 WWNs to a single group; for the XP48/XP512, you can assign up to 256 WWNs to a single group.

By giving a WWN group access to a specified LUN or group of LUNs, you give every host in the WWN group access to the LUN or LUN group.

You can assign more than one WWN to one port and one WWN to several ports.

Use LUN Security for the following functions:

- Enabling and disabling the security for Fibre Channel ports (page 257)
- Setting permission to access LUNs and LUN groups (page 260)
- Creating LUN groups (page 260)
- Modifying and deleting LUN groups (page 261)
- Changing LUN group nicknames (page 262)
- Defining WWNs (page 263)
- Creating WWN groups (page 264)
- Deleting a WWN or WWN groups (page 266)
- Changing WWN nicknames (page 266)
- Changing WWNs (page 267)
- Modifying WWN groups (page 267)

## Starting LUN Security

To start LUN security:

1. From the Launch screen, click an XP48, XP256, or XP512.
2. Click the **LUN Security** tab. The LUN Security main screen is displayed.

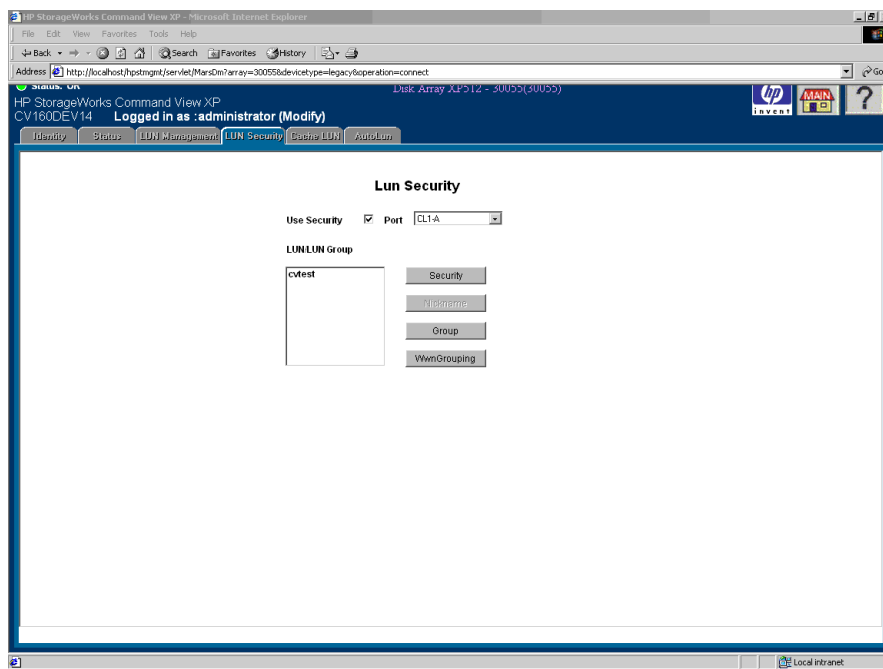


Figure 97: LUN Security main screen

### Display

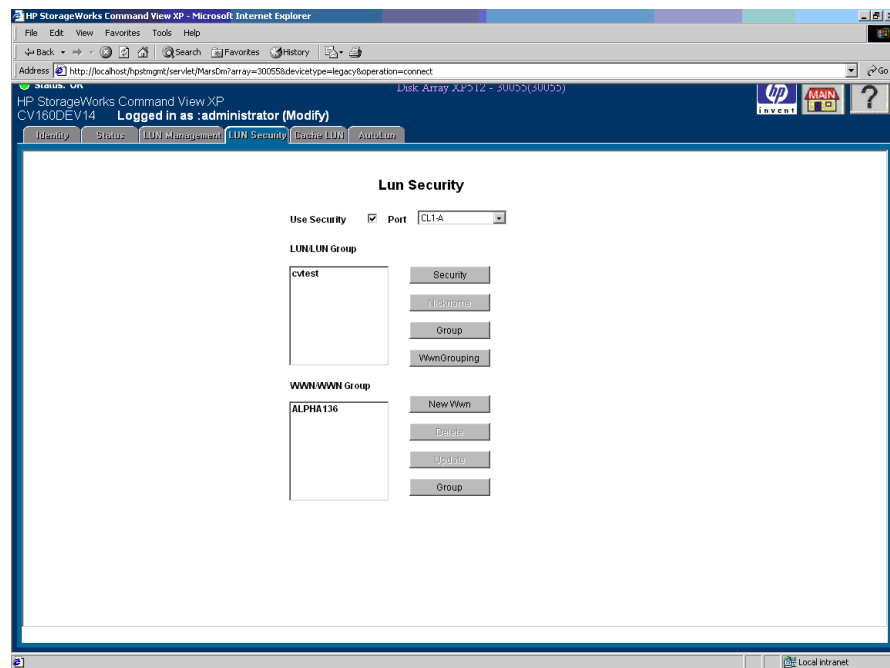
The LUN Security main screen consists of the following items:

- **Use Security:** A check box used to enable or disable LUN Security for the selected port displayed in the **Port** drop-down list.
- **Port:** A drop-down list containing the Fibre Channel ports.
- **LUN/LUN Group:** Displays the LUNs and LUN groups defined for the selected port.
- **Security button:** Sets the security options for the selected LUNs or LUN groups listed in the **LUN/LUN Group** list box.

The top section of the screen changes when you click **Security**. The top section is used to group LUNs, change LUN group nicknames, and set the security for LUNs and LUN groups defined for the selected port.

- **Nickname button:** Changes the nickname of the selected LUN group.
- **Group button:** Creates, modifies, or deletes the selected LUN group.
- **WwnGrouping button:** Used to define WWNs, create and modify WWN groups, delete WWNs and WWN groups, and change WWN, WWN nickname, and WWN group nicknames.

The bottom section is displayed when you click **WwnGrouping**.



**Figure 98: LUN Security main screen with WWN/WWN Group list box displayed**

- **WWN/WWN Group:** The list box displays WWNs and WWN groups for the selected port.
- **New Wwn button:** Used to define WWNs and WWN nicknames.
- **Delete button:** Deletes WWNs and WWN groups.

- **Update button:** Changes the WWN, WWN nickname, and WWN group nickname.
- **Group button:** Creates, modifies, and deletes WWN groups.

## Enabling and Disabling LUN Security

If there are no paths defined for a selected port, you cannot perform LUN Security operations for that port. Exit LUN Security, establish paths, and then return to LUN Security.

### To enable or disable LUN security:

1. From the LUN Security main screen, click a port in the **Port** drop-down list.
2. To enable LUN security for the selected port, select the **Use Security** check box. If no WWN is defined for the selected port, the **New Wwn** button will be enabled in the bottom section of the screen. To add new WWNs, see [Adding a New WWN](#) on page 263.

To disable LUN security for the selected port, clear the **Use Security** check box. All security permissions for the port will be disabled and any host can access the port. Disabling LUN Security for a port does not erase the LUN security setting for a LUN. The assigned setting for the LUN is held until that LUN or its port is uninstalled or until the settings are manually erased.

## Defining LUN Security

You can allow access to a single LUN or allow access to a group of LUNs. To do this, you must first create a LUN group.

You can make access to a LUN or a LUN group available to a single host WWN, or you can group WWNs in a WWN group as a simple way to allow access by multiple hosts to a LUN or LUN group.

### To define LUN security:

1. From the LUN Security main screen, click a port in the **Port** drop-down list. The **LUN/LUN Group** list box displays the LUNs for the specified port.

If no LUNs are displayed, a LUN must be defined. To define LUNs, see [LUN Management for the XP48/XP256/XP512](#) on page 143.

2. Select the **Use Security** check box.
3. Click a LUN or LUN Group.
4. Click **Security**. The LUN/LUN Group Security screen is displayed.

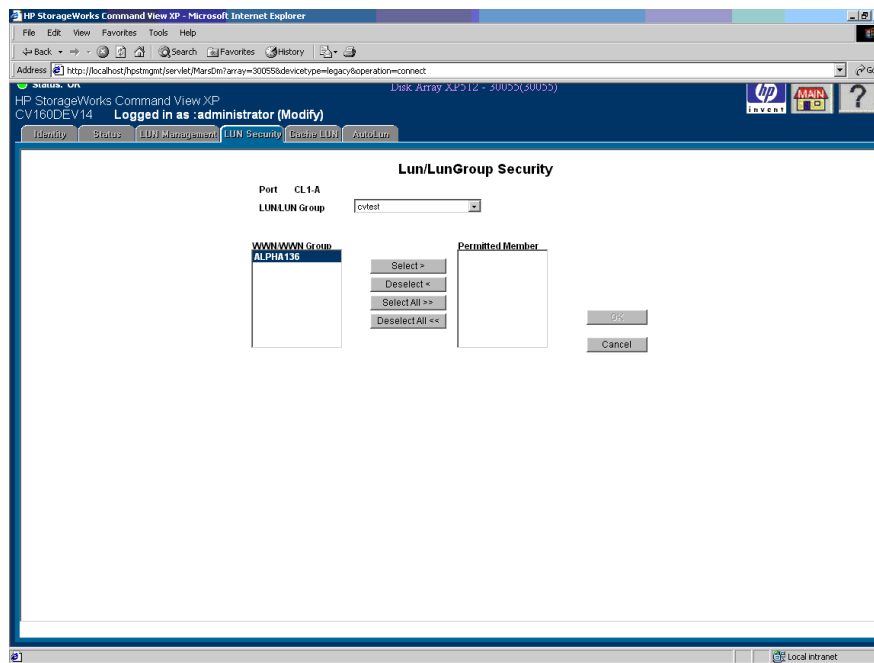


Figure 99: LUN/LUN Group Security screen

5. Click the WWN or WWN group that is to be granted access to the selected LUN or LUN group.
6. Click **Select**. To select all of the WWNs in the list box, click **Select All**. The **Permitted Member** list box displays the selected WWNs.  
If you do not want to grant access for a selected WWN, click the unwanted WWN in the **Permitted Member** list box and then click **Deselect**. To move all of the selected WWNs out of the Permitted Member list, click **Deselect All**.
7. Click **OK** to confirm your entries or click **Cancel** to cancel your selections. The LUN Security screen is displayed.

Repeat these steps for each port and LUN or port and LUN group combination you want secure.

## Changing LUN Security Parameters

### Changing WWN Access to a LUN

You can change WWNs or a WWN group permission to communicate with a selected LUN.

**To change WWN access to a LUN:**

1. From the LUN Security main screen, click a port in the **Port** drop-down list.
2. In the **LUN/LUN Group** list box, click a LUN or LUN group.
3. Click **Security**. The LUN/LUN Group Security screen is displayed.
4. To grant access to the LUN or LUN group, select a WWN or WWN group and click **Select**. To select all of the WWNs or WWN groups listed, click **Select All**. The selected WWNs or WWN groups are moved into the **Permitted Member** list box.

To remove access, click the WWNs or WWN groups in the Permitted Member list and then click **Deselect**. To remove permissions for all of the WWNs or WWN groups, click **Deselect All**.

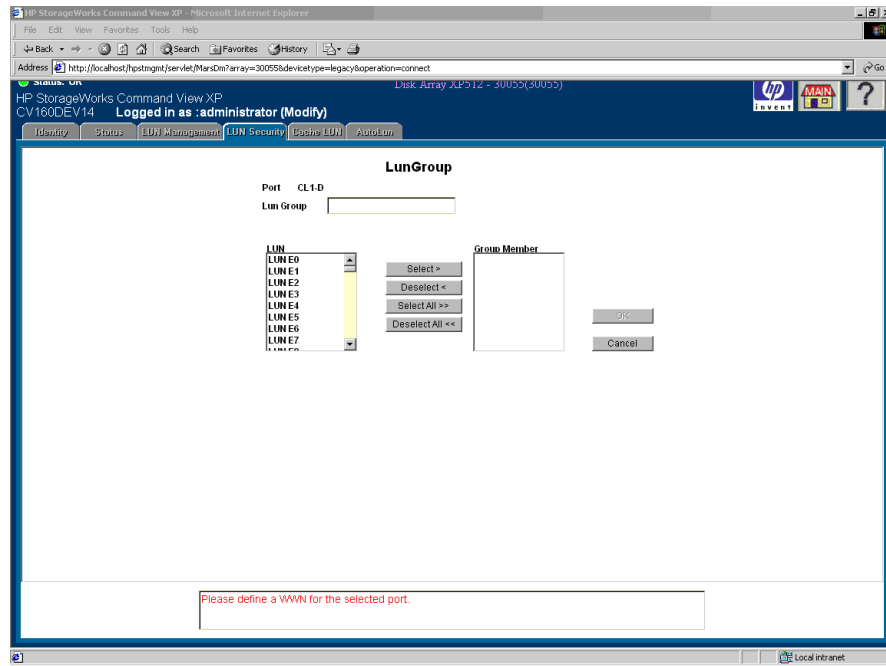
5. Click **OK**, or click **Cancel** to cancel your selections. You are returned to the LUN Security main screen.

### Creating a LUN Group

**To create a LUN group:**

1. From the LUN Security main screen, click a port in the **Port** drop-down list.
2. Click **Group**. The LUN Group screen is displayed.





**Figure 100: LUN Group screen**

The **LUN Group** list box displays the available LUNs for the port.

3. In the **LUN Group** text box, enter the name for the LUN Group.
4. Add one or more LUNs to the group by clicking each LUN you want to assign and then clicking **Select**. To select all the displayed LUNs, click **Select All**. The **Group Member** list box displays the newly-assigned LUNs.

To remove a LUN from the **Group Member** list box, click the LUN you want to remove and then click **Deselect**. To remove all the displayed LUNs, click **Deselect All**.

5. Click **OK** to confirm your selection, or click **Cancel** to cancel.

## Changing LUN Group Information

**To change LUN group information:**

1. From the LUN Security main screen, click a port in the **Port** drop-down list.

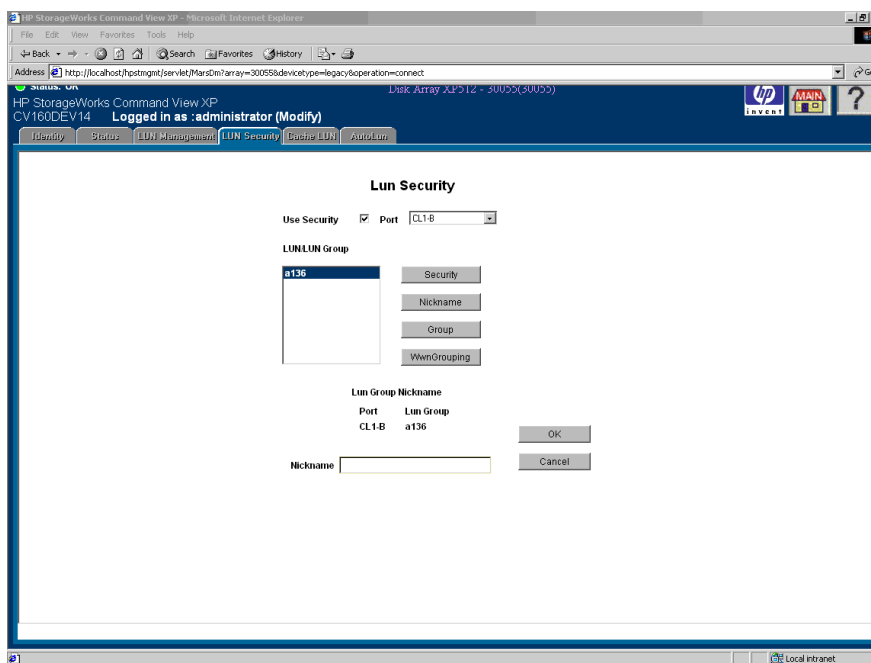
2. In the **LUN/LUN group** list box on the LUN Security main screen, click a LUN group.
3. Click **Group**. The LUN Group screen is displayed.
4. Add LUNs to or remove LUNs from the group:
  - To add a LUN to the LUN group, click the LUN and then click **Select**. To select all the displayed LUNs, click **Select All**. The **Group Member** list box displays the newly-assigned LUNs.
  - To remove a LUN from the group, click the LUN you want to remove in the **Group Member** list box and then click **Deselect**. To remove all the LUNs in the **Group Member** list box, click **Deselect All**.
5. Click **OK** to confirm your changes, or click **Cancel** to cancel your changes.

## Creating or Changing a LUN Group Nickname

You can assign a nickname to a LUN group. Note that you cannot assign a nickname to an individual LUN.

### To create or change a LUN group nickname:

1. From the LUN Security main screen, click a port in the **Port** drop-down list.
2. Click the LUN group for which the nickname is to be created or changed.
3. Click **Nickname**. The screen expands to display a **Nickname** field.



**Figure 101: LUN Security main screen with Nickname field displayed**

4. To add a nickname, enter the nickname for the LUN group. To change a nickname, enter a new nickname for the group.
5. Click **OK**.

## Adding a New WWN

### To add a new WWN:

1. From the LUN Security main screen, click a port in the **Port** drop-down list.
2. Click **WwnGrouping**. The screen expands to display WWN information.
3. Click **New Wwn**. The New WWN screen is displayed.

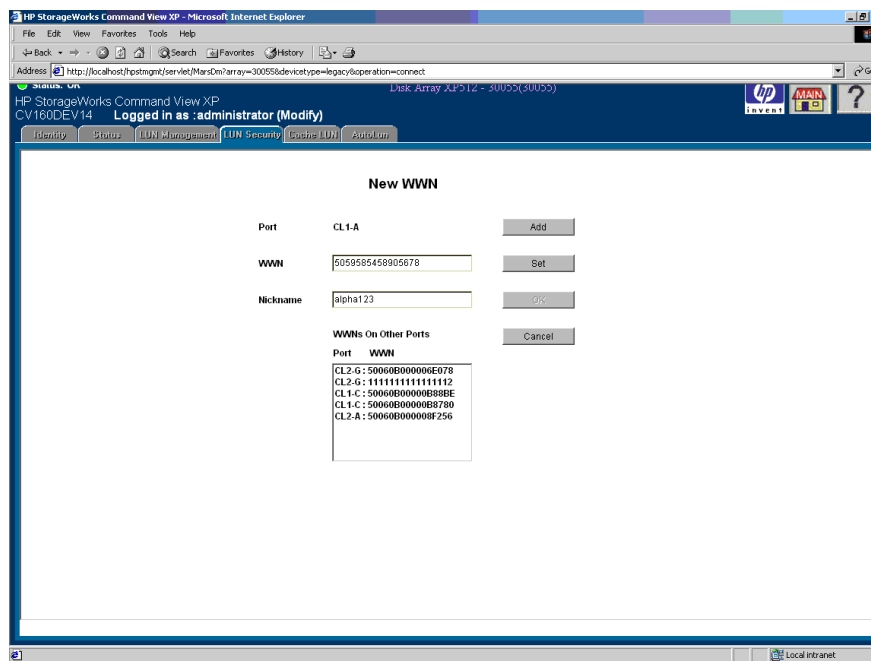


Figure 102: New WWN screen

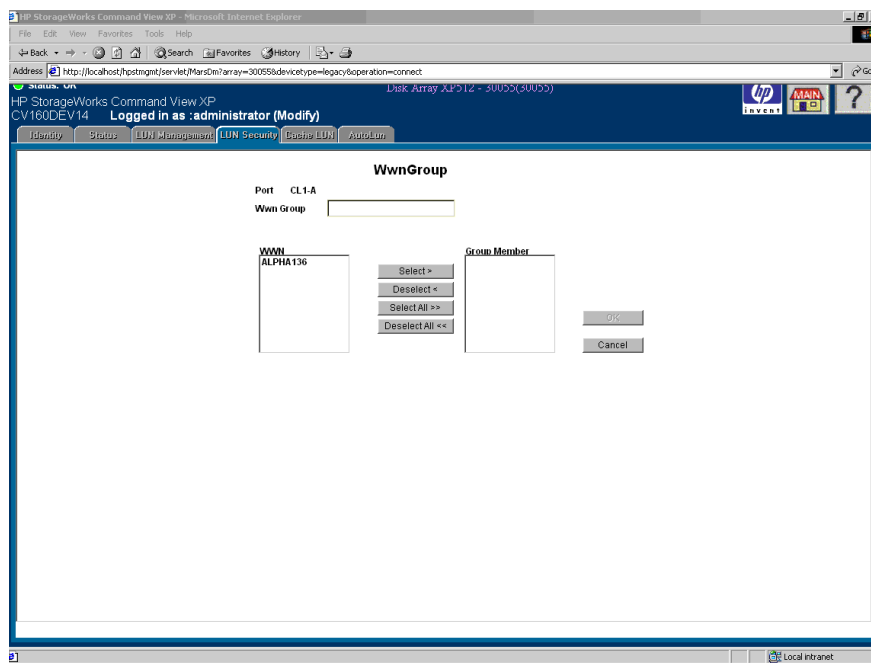
4. In the **WWN** text box, enter the new WWN. The WWN is a hexadecimal string containing 16 characters.
5. In the **Nickname** text box, enter the nickname. The nickname is mandatory for all WWNs. Maximum length is 8 characters.
6. Click **Add** to add the WWN to the WWN list. The WWN displays in the list box.
7. Click **Set** or **OK** to register the WWN, or click **Cancel** to cancel your entries.  
If you click **Set**, the display remains in the same screen after registering the WWN for the selected port. If you click **OK**, the display returns the LUN Security main screen after adding the WWN.

## Creating a WWN Group

WWNs can be combined into groups.

**To create a WWN Group:**

1. From the LUN Security main screen, click a port in the **Port** drop-down list.
2. Click **WwnGrouping**. The screen expands to display WWN information.
3. In the WWN/WWN Group area, click **Group**. The WwnGroup screen is displayed.

**Figure 103: WwnGroup screen**

4. In the **WwnGroup** text box, enter the name for the WWN Group.  
To add a WWN to the new WWN group, click the WWN in the **WWN** list box and then click **Select**. To select all the WWNs in the list box, click **Select All**.  
The selected WWN will display in the **Group Member** list box.  
To remove a WWN from the group, click **Deselect**. To remove all the WWNs, click **Deselect All**.
5. Click **OK**.

## Deleting a WWN or WWN Group

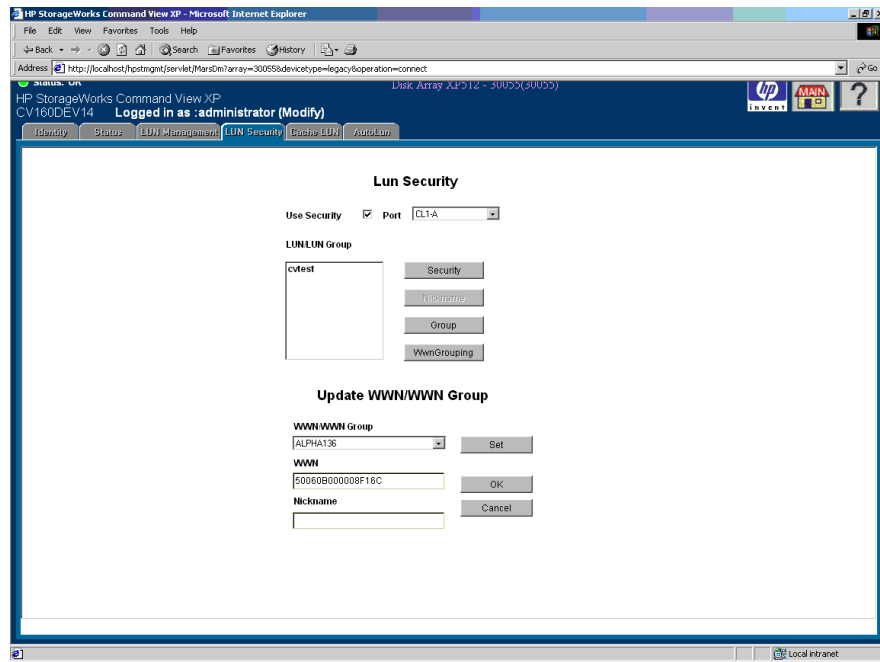
### To delete a WWN or WWN group:

1. From the LUN Security main screen, click a port in the **Port** drop-down list.
2. Click **WwnGrouping**. The screen expands to display WWN information.
3. Click the WWN or WWN group you want to delete.
4. Click **Delete**. A confirmation dialog box is displayed.
5. Click **OK** to confirm or click **Cancel** to exit without deleting the name.

## Updating WWNs and Nicknames

### To update a WWN or nickname:

1. From the LUN Security main screen, click a port in the **Port** drop-down list.
2. Click **WwnGrouping**. The screen expands to display WWN information.
3. Click **Update**. The screen displays the **Update WWN/WWN Group** fields.



**Figure 104: LUN Security main screen with Update WWN/WWN Group fields displayed**

4. In the **WWN/WWN Group** drop-down list, click the WWN or WWN group you want to modify.
5. Enter a WWN name and WWN's nickname.
6. Click **Set** or **OK** to register the change, or click **Cancel** to cancel your entries.

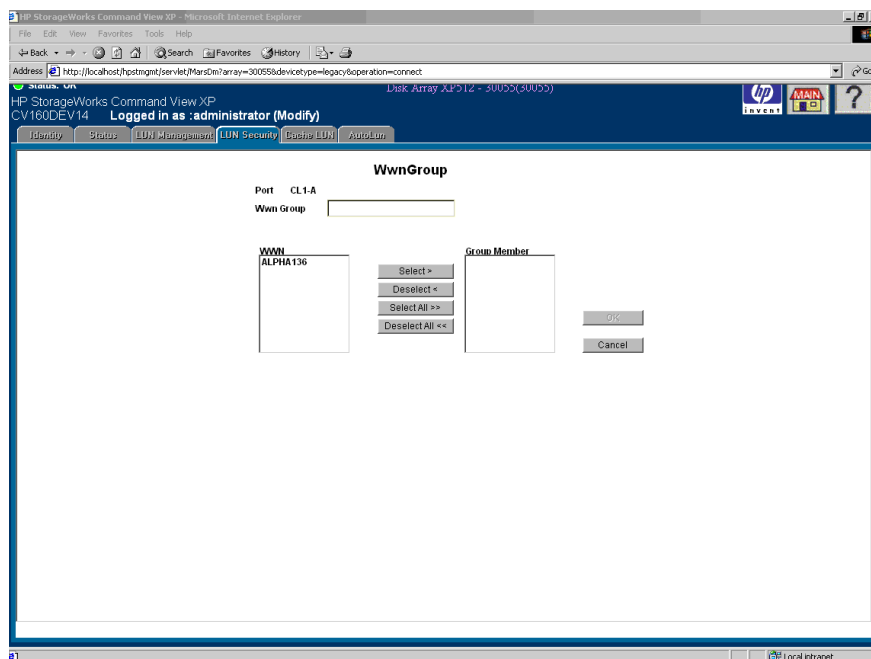
If you click **Set**, the display remains in the same screen after registering the change. If you click **OK**, the display returns the LUN Security main screen after changing the WWN.

## Changing WWN Group Members

### To change WWN group members:

1. From the LUN Security main screen, click a port in the **Port** drop-down list.
2. Click **WwnGrouping**. The screen expands to display WWN information.

- Click the WWN group you want to modify and then click **Group** in the WWN/WWN Group area. The WwnGroup screen is displayed.



**Figure 105: WwnGroup screen**

- To add a WWN to the new WWN group, click the WWN in the **WWN** list box and then click **Select**. To select all the WWNs in the list box, click **Select All**. The **Group Member** list box displays the selected WWN.

To remove a WWN from the group, click **Deselect**. To remove all the WWNs, click **Deselect All**.

- Click **OK**.



# Volume Management for the XP128/XP1024

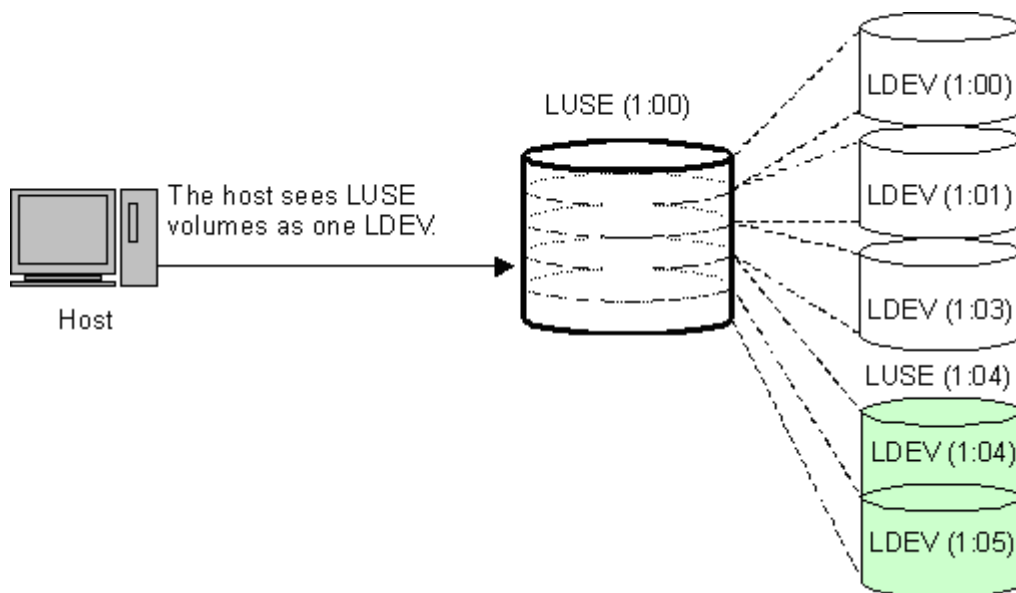
13

Use Volume Management to perform the following tasks:

- LU Size Expansion (LUSE): Combine multiple LDEVs into a single larger LDEV (see page 270)
- Volume Size Configuration (VSC): Divide an LDEV into smaller addressable pieces (see page 273)

## Volume Management (LU Size Expansion)

Volume Management (LU Size Expansion or LUSE) combines two or more LDEVs to function into a larger LDEV. As a result, a host can access a greater amount of storage with a smaller number of LDEVs. The following figure shows the function effect of a LUSE configuration.



**Figure 106: LUSE configuration**

LUSE can combine up to 36 LDEVs into a LUSE volume. The LDEV number of the LUSE volume is the “first” or “lowest” number of the LDEVs making up the LUSE volume. This is the “top” LDEV, and is the number the host will recognize.

### Drawbacks

Some operating systems may experience slow disk access times with large logical units, if they contain a large number of high-use files.

The size of a LUSE volume can increase the amount of time required to perform backups.

## LUSE Rules

The following is a list of guidelines for LUSE volumes:

- Open volume emulation types OPEN-3, OPEN-8, OPEN-9, OPEN-E, OPEN-K, OPEN-L, OPEN-M, or OPEN-V are supported.
- LDEVs that are to be combined into LUSE volumes should be on the same CU.
- Maximum number of LDEVs that can be used to create a LUSE is 36.
- LDEVs must be of the same emulation type.
- LDEVs must be at the same RAID level. Combining RAID 1 and RAID 5 volumes into the same LUSE is supported, but not recommended.
- LDEVs must have the same capacity. If the LUSE volume contains another LUSE volume, all LDEVs should have the same capacity.
- LDEVs that will become members of the LUSE volume must not have paths assigned. These are known as free (or available) LDEVs.
- LDEVs must not be Business Copy, Continuous Access, TrueCopy (TC390), or ShadowImage (SI390) volumes.
- LDEVs cannot be reserved for Auto LUN.
- LDEVs to be combined can be normal volumes or custom (VSC) volumes, but you cannot combine these types together in the same LUSE volume.
- When you combine a LUSE volume with another LUSE volume, the range of LDEVs should not be overlapped.  
  
For example, if you combine LDEV00, LDEV03 and LDEV05 in to LUSE 1, LDEV02 and LDEV04 into LUSE 2, and LDEV06 and LDEV07 into LUSE3, you can also combine LUSE 1 and LUSE 3. However, you cannot combine LUSE 1 and LUSE 2, because the LDEV range in LUSE 1 and LUSE 2 is overlapped.
- A maximum of 256 expanded logical units (LUs) can be configured on the same port.
- The maximum capacity of a LUSE volume is up to 2 TB.
- The access attribute should be set to read/write when creating or releasing a LUSE volume.
- When releasing a LUSE volume, the volume cannot have a path definition.

## LUSE Operations that Handle a Path-defined LDEV

You can use an LDEV (or another LUSE volume) that has path definitions as the top LDEV of the resulting LUSE volume, and can combine the top LDEV with other LDEVs or LUSES that have no path definitions. Creating a LUSE volume in this manner is referred to as “a LUSE operation that handles a path-defined LDEV.”

When creating a LUSE volume in this manner, the following rules apply:

- You can combine an LDEV or LUSE volume having no path definitions with another LDEV or LUSE volume having no path definitions.
- You can perform a LUSE operation that handles a path-defined LDEV regardless of how many paths are defined to the LDEV.
- You cannot combine an LDEV (or a LUSE volume) that has path definitions with another LDEV or LUSE volume that also has path definitions.
- If you want to use an LDEV (or a LUSE volume) having no path definitions as the top LDEV of the resulting LUSE volume, you cannot combine this LDEV (or LUSE volume) with other LDEVs or LUSE volumes having path definitions.

Note the following points when performing a LUSE operation that handles a path-defined LDEV:

- If a path is defined from a Windows 2000 host (the host mode is 2C) or from an AIX 5.2 host to an LDEV, the LDEV can be used for LUSE operations that handle a path-defined LDEV. However, if a path is defined from a host running another operating system to an LDEV, the LDEV cannot be used for LUSE operations that handle a path-defined LDEV.
- If a path is defined from a Windows 2000 host to an LDEV and you want to perform a LUSE operation that handles this path-defined LDEV, verify that the host mode of the Windows 2000 host is 2C (Windows Extension). If the host mode is not 2C, change the host mode to 2C before performing the LUSE operation.

## Volume Size Configuration (VSC)

The Volume Size Configuration (VSC) process configures custom volumes (CVs) that are smaller than normal volumes. Custom volumes improve data access performance by reducing logical device contention as well as host I/O queue times, which can occur when several frequently-accessed files are located on the same volume.

If you have several frequently-accessed files on the same LDEV, you can use VSC to set up smaller, “separate” custom volumes for them. This should reduce conflicts and improve performance.

A small custom volume can also be useful as a command device. This leaves the rest of the LDEV free for other uses.

VSC operations include:

1. **Volume to Space:** Formats one or more of the LDEVs on a selected VDEV into free space, which can be used to install one or more custom volumes using the Install CV function, or left as free space for future use.
2. **Install CV:** Creates custom volumes from free space.
3. **Make Volume** (OPEN-V only) or **Volume Initialize** (all supported emulation types except for OPEN-V): Converts a custom volume back to a normal volume (VDEV).

The **Make Volume** function clears all custom volumes under a VSC volume and creates an initial volume (VDEV) that consists of new user-defined custom volumes.

The **Volume Initialize** function uninstalls all custom volumes under a VSC volume, and reformats the VSC volume as a normal volume (VDEV).

Compared to other emulation types, use OPEN-V to easily create volumes of any size. OPEN-V volumes always consist of custom volumes, instead of fixed-size volumes.



**Caution:** VSC operations are destructive. Be sure to back up your data before performing VSC operations.

---

The following figure shows a sample VDEV (whose components are LDEVs) in its initial condition and the VDEV after custom volumes are created.

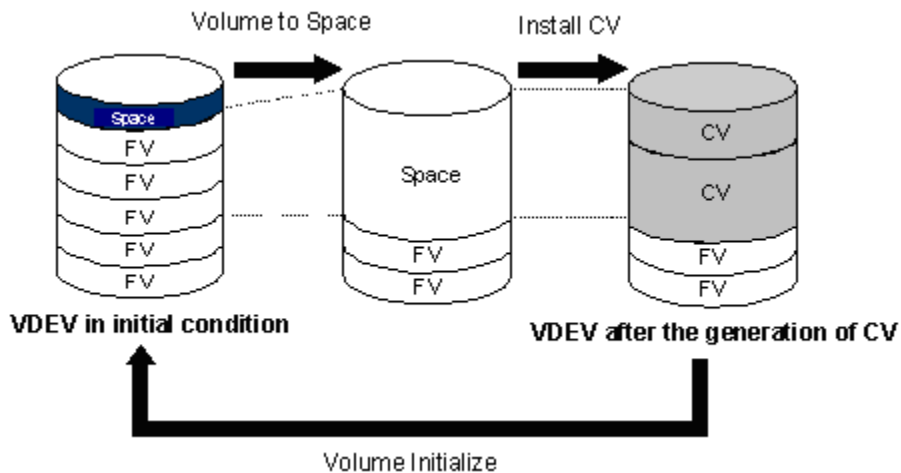


Figure 107: VSC process (all supported emulation types except for OPEN-V)

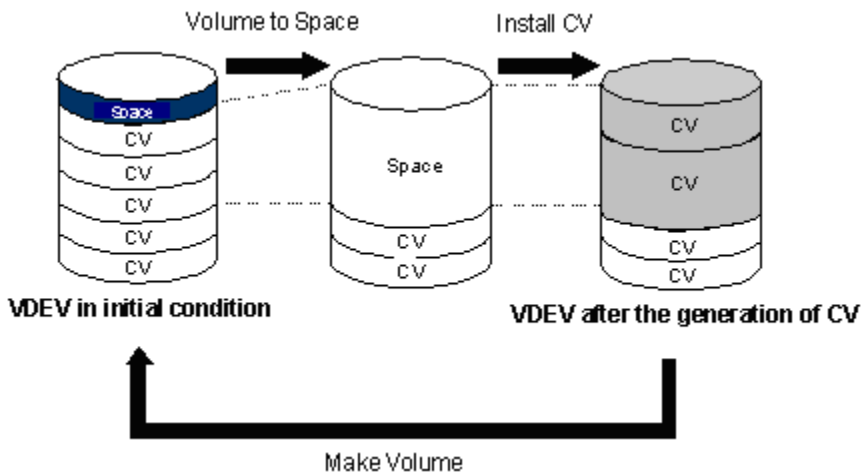


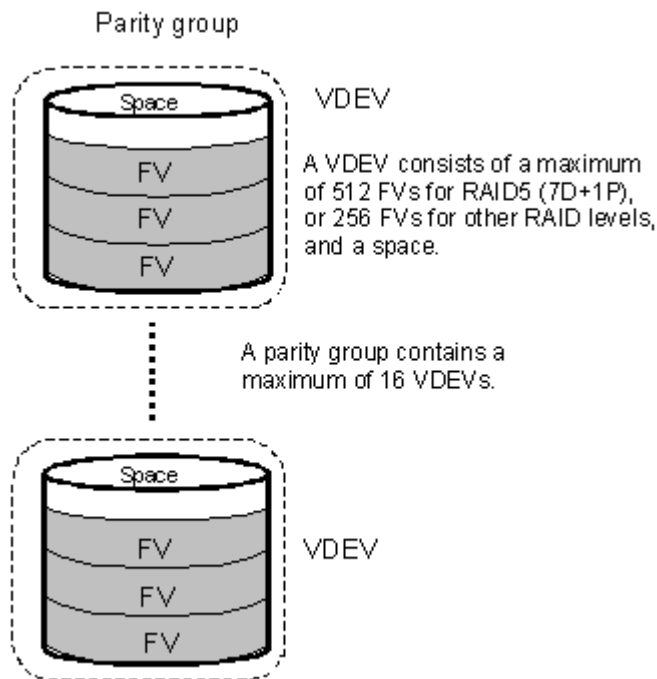
Figure 108: VSC process (OPEN-V)

## Parity Group Configuration

This section explains the parity group configuration of emulation types other than OPEN-V. OPEN-V volumes always consist of variable sized volumes instead of fixed-size volumes (FVs). To use OPEN-V, parity groups must be enabled to support the OPEN-V emulation type. To enable OPEN-V, contact your HP technical support representative.

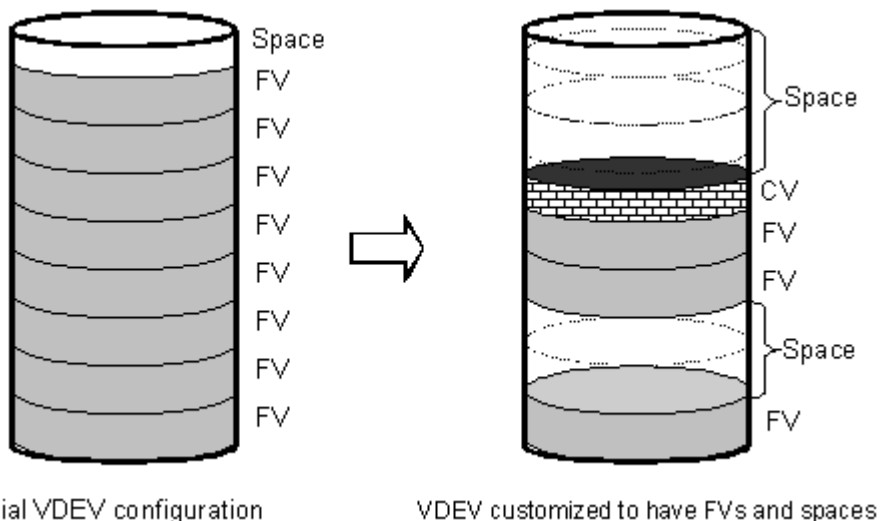
For emulation types other than OPEN-V, a parity group consists of a maximum of 16 VDEVs. A maximum of 512 fixed-size volumes for RAID5 (7D+1P) levels, or 256 fixed-size volumes for other RAID levels, and a certain amount of free space are available in one VDEV. Each VDEV in a parity group has the same configuration, and is assigned the same fixed-size volumes of the same size and RAID level.

The three functions of VSC (Volume to Space, Install CV, and Volume Initialize) are performed on each VDEV. VDEVs are also separated from each other by the boundary limitation. Therefore, you cannot define a volume across two or more VDEVs beyond the boundaries.



**Figure 109: Parity group configuration for other than OPEN-V**

As the result of VSC operations, a VDEV contains fixed volumes, custom volumes, and free spaces that are delimited in logical cylinders. Sequential free spaces are combined into a single free space.



**Figure 110: Virtual VSC volume configuration for other than OPEN-V**

Before changing ordinary target ports or RCU target ports to initiator ports, make sure that no I/Os (such as Extended Copy commands) are being executed from the host server to the affected port(s). You can change the port type of free ports only.

## Volume to Space Operation

The Volume to Space function converts LDEVs (fixed or custom volumes) on a VDEV into free space. However, the VDEV must contain at least one LDEV. Two or more consecutive free space areas are combined into a single free space. The Volume to Space function can convert n-1 LDEVs only. The last volume cannot be converted. OPEN-V LUSE volumes that have sequential LDEVs can be also converted into free space.

### Restrictions

- The LDEV should not have a path definition, including TrueCopy (TC390), Continuous Access (CA), ShadowImage (SI390), and Business Copy (BC) pair volumes.



- The LDEV should not be a component of a LUSE volume. This applies to the all supported emulation types except for OPEN-V.
- The LDEV should not be reserved for Auto LUN.
- The access attribute should be set to Read/Write.

## Install Custom Volume (CV) Operation

The Install CV function defines and installs one or more VSC volumes under an existing volume (free space in a VDEV). You can assign a specific number of physical cylinders (for mainframe systems) or MB (for open systems) to each VSC volume for maximum control over the volume size.

When you specify the capacity and the emulation type other than OPEN-V for a VSC volume to be created, the Install CV function automatically creates and formats the VSC volume in sufficient free space. You must specify a new CU number and LDEV number for the created VSC volume. The created VSC volume contains the user-specified number of user cylinders and a predetermined number of control cylinders by the emulation type.

For OPEN-V volumes, there are four ways to create VSC volumes. You can specify from 46 MB (50 cylinders) up to the maximum capacity of VDEV for the capacity of a volume. If the specified capacity exceeds 60 gigabytes (65,535 cylinders), the Install CV function creates the volume in LUSE configuration automatically.

When there is only one free space in the LDEV, you can use any method to create VSC volumes. When there are two or more free spaces, you can use the first method only. The other methods are not available.

**Table 21: Creating VSC Volumes by Install CV (for OPEN-V)**

No.	Install CV Method	Description
1	Specify size and number	Used to specify the capacity and the number of custom volumes in the VSC volume that you want to create.
2	Divide free space by number	Used to create VSC volumes by specifying the number of custom volumes in the VSC volume to be created.
3	Divide free space by size	Used to create VSC volumes by specifying the capacity of custom volumes in the VSC volume to be created.
4	Set remaining space as volume	Used to create a VSC volume using the remaining space on the VDEV.

**Note:** Allocating custom volumes in descending order of capacity optimizes custom volume allocation during the Install CV process.

As defined in the following table, VSC does not work with OPEN-L and OPEN-M emulation types. VSC supports OPEN-3, OPEN-8, OPEN-9, OPEN-E, OPEN-K, and OPEN-V emulations. OPEN-K VDEVs can be used only to create OPEN-K custom volumes.

**Table 22: VSC supported emulations**

Emulation	Can create these Volume Size Configurations
OPEN-3	3, 8, 9, E
OPEN-8	3, 8, 9, E
OPEN-9	3, 8, 9, E
OPEN-E	3, 8, 9, E
OPEN-K	K
OPEN-V	V

The following table lists specifications and the minimum and maximum volume capacities for mainframe and open systems.

**Table 23: Install Custom Volume operation parameters for mainframe and open system volumes**

Item	Mainframe system volumes	Open system volumes	
Track format	3380 or 3390	OPEN-3, OPEN-8, OPEN-9, OPEN-E, OPEN-K	OPEN-V
Emulation type	3380-E, -F, -J, -K, -KA/KB/KC; 3390-1,-2,-3,-3R, -3A/3B/3C, -9	OPEN-3, OPEN-8, OPEN-9, OPEN-E, OPEN-K	OPEN-V
Maximum number of LDEVs (fixed and custom volumes) per VDEV	512 for RAID5 (7D+1P) 256 for other RAID levels	512 for RAID5 (7D+1P) 256 for other RAID levels	512 for RAID5 (7D+1P) 256 for other RAID levels
Maximum number of LDEVs (fixed and custom volumes) per disk array	8,192	8,192	8,192

**Table 23: Install Custom Volume operation parameters for mainframe and open system volumes**

Item	Mainframe system volumes	Open system volumes	
	Minimum custom volume capacity	1 cylinder (+ control cylinders)	36 MB (+ control cylinders)
Maximum custom volume capacity	Emulation volume size	Emulation volume size	Emulation volume size
Increment of custom volume capacity	1 cylinder	1 MB	1 MB (1 cylinder)
Custom volume disk location	Anywhere	Anywhere	Anywhere

The following table shows specified and actual capacities of various open system custom volume sizes.

**Table 24: Capacities of open system custom volume sizes**

Setting size (MB)	User Size <sup>1</sup> (MB)	Notes
36	36.15625	Minimum custom volume size (other than OPEN-V)
46	48.875	Minimum custom volume size (OPEN-V)
500	500.625	
1000	1000.546875	
1788	1788.046875	Maximum OPEN-K volume size
2000	2000.390625	
2347	2347.03125	Maximum OPEN-3 volume size
7007	7007.34375	Maximum OPEN-8 volume size
7042	7042.5	Maximum OPEN-9 volume size
13893	13893.04688	Maximum OPEN-E volume size
737256	737256.09375	Maximum OPEN-V volume size (Maximum VDEV volume size)

1. The term "user size" refers to capacity available to users. User size does not include the number of control cylinders and the number of cylinders for volume boundary control.

## Volume Initialize and Make Volume Operations

The Volume Initialize and the Make Volume functions reset a VDEV to its original configuration.

If you not using OPEN-V, use the Volume Initialize function. The Volume Initialize function removes all custom volume areas and free spaces on the VDEV and regenerates initial fixed volumes. It formats the new fixed volumes. The newly-formatted fixed volumes must be assigned CU and LDEV numbers. Existing fixed volumes on the VDEV are not re-formatted.

If you are using OPEN-V, use the Make Volume function. The Make Volume function deletes all variable sized volumes in a VDEV, and creates new custom volume areas according to the specified settings. [Table 25](#) shows the settings that you can specify.

**Table 25: Settings for the Make Volume operation (OPEN-V only)**

No.	Specifying	VSC volumes to be created
1	Specify the capacity and the number of custom volumes under a VSC volume.	A VSC volume that has the specified number of custom volumes of the specified capacity is created. This is the same as the Install CV operation.
2	Specify the number of custom volumes.	A VSC volume that has the specified number of custom volumes is created. The VDEV is divided by the specified number.
3	Specify the capacity of a custom volumes.	A VSC volume that has custom volumes of the specified capacity is created. The VDEV is divided by the specified capacity.
4	Specify the remaining capacity for a VSC volume.	If some space remains in the VDEV after VSC volumes are created by the settings 1 - 3, the remaining space can also be converted into a VSC volume.

If the specified capacity exceeds 60 gigabytes (65,535 cylinders), the Make Volume function automatically creates the VSC volume in LUSE configuration.

### Restrictions

If the VDEV contains a custom volume that violates any of the restrictions, the Volume Initialize and Make Volume functions are disabled. You must eliminate invalid custom volumes before executing the Volume Initialize and Make Volume functions.

- The LDEV should not have a path definition, including TrueCopy (TC390), Continuous Access (CA), ShadowImage (SI390), and Business Copy (BC) pair volumes.
- The LDEV should not be a component of LUSE. This applies to the Volume Initialize function only.

- The LDEV should not be reserved for Auto LUN.
- The access attribute should be set to Read/Write. This applies to the Volume Initialize function only.

## LUSE Operations


Only users with administrator privileges in Modify mode can perform LUSE setting or releasing operations. Other users can browse LUSE configuration information but cannot change it.

LUSE operation topics include the following:

- Starting LUSE operations (see page 282)
- Volume Management screen (see page 283)
- Viewing LUSE configuration information (see page 286)
- Viewing concatenated parity groups (see page 287)
- Creating LUSE volumes by using:
  - Volume Count drop-down list (see page 287)
  - Select an LDEV drop-down list (see page 288)
  - LDEV Information table (see page 289)
- Releasing LUSE volumes (see page 291)
- Changing LUSE capacities (see page 292)
- Resetting unregistered LUSE volumes (see page 292)

## Starting LUSE Operations

**To start LUSE operations:**

1. From the Launch screen, click an XP128 or XP1024.
2. Click the **LUN and Volume Mgmt** tab, and then click the **Volume Management** button (). The Volume Management screen is displayed.

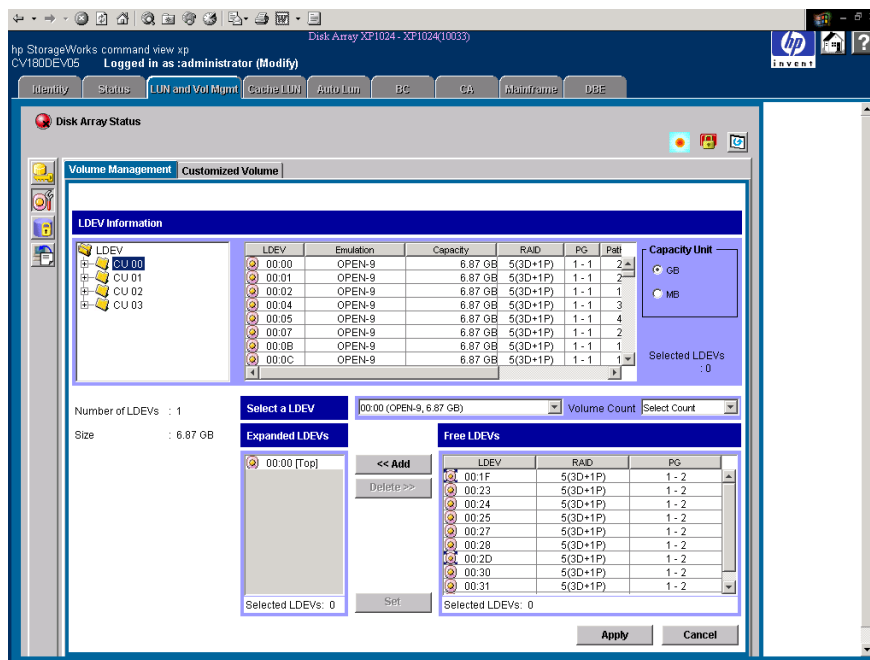


Figure 111: Volume Management screen

## Volume Management Screen




### LDEV Information tree

The top of the screen shows a tree and list of CU numbers (CU<sub>xx</sub>) and LDEV numbers (xx:xx). When an LDEV is made up of LUSE volumes, the top LUSE number is displayed, with the number of members preceded by an asterisk (\*n). The number is the number of LDEVs that the LUSE volume contains, such as 00:02\*2.

### LDEV Information table

The status of each LDEV is indicated by one of the following icons:

**Table 26: LDEV status icons for LUSE operations**

Icon	LDEV status
	Normal LDEV
	Custom volume
	LUSE volume

When you click a CU in the LDEV Information tree, this table shows information about all LDEVs in the CU. When you click an LDEV, the table shows detailed information about the LDEV. When you click a LUSE volume, the table shows detailed information about all LDEVs in the LUSE volume.

The table contains the following information:

- **LDEV:** Displays an LDEV status icon (same as that displayed in the LDEV information tree), a CU number and an LDEV number. When the selected LDEV is a LUSE volume, the LDEV number of the top LDEV in the LUSE volume is displayed. An LDEV number that ends with a “#” indicates that the LDEV is an external LU (for example, 00:01#).
- **Emulation:** The emulation type of the LDEV. If the selected LDEV is a VSC volume, the emulation type is displayed together with CVS (for example, OPEN-3 CVS). If the LDEVs that comprise a LUSE volume extend over two or more VDEVs, the emulation type is not displayed with an asterisk and the number of volumes (\*n), and each LDEV in the LUSE volume is displayed.
- **Capacity:** The capacity of the LDEV represented in units (GB or MB), based on the capacity you indicate with the **Capacity Unit** option button. If the selected LDEV is a LUSE volume, the capacity of a single LDEV is also displayed in brackets (for example, 6.87 (2.29) GB).
- **RAID:** The RAID level of the LDEV. The RAID level is left unspecified with a hyphen (-) when the LDEV is an external LU.
- **PG:** A combination of a disk group, a parity group, and a VDEV number. A parity group number that starts with a letter E indicates that the parity group consists of one or more external LUs (for example, E1-1).
- **Paths:** The number of paths that is set for the LDEV. If this column displays the number of paths for an LDEV, you can use the LDEV as the top LDEV of a LUSE volume. For more information, see [LUSE Operations that Handle a Path-defined LDEV](#) on page 272.
- **Access Attribute:** The access attribute that is set for the LDEV.



- **Selected LDEVs:** The number of LDEVs selected in the LDEV Information table is displayed.

### Capacity Unit option button

Click a capacity unit (**GB** or **MB**) to describe LDEVs.

### Select an LDEV drop-down list

Displays the LDEVs, VSC volumes, and LUSE volumes of the selected CU that are eligible to become part of a LUSE volume. The selected LDEV number becomes the top LDEV number of a LUSE volume.

### Volume Count drop-down list

Used to specify the number of LDEVs that should form a LUSE volume. For example, if you click **3** in the **Volume Count** drop-down list, three LDEVs are expected to form a LUSE volume and then three LDEVs are added to the Expanded LDEVs list. You can select an LDEV only from the **Volume Count** drop-down list. You cannot select a LUSE volume.

### Free LDEVs table

Lists the LDEVs, VSC volumes, and LUSE volumes that can constitute a LUSE volume in combination with the LDEV selected as a top LDEV in the **Select an LDEV** drop-down list. The table contains the following information:

- **LDEV:** An LDEV status icon, a CU number, and an LDEV number. If the selected LDEV is a LUSE volume, the LDEV number of the top LDEV in the LUSE volume is displayed. An LDEV number that ends with a “#” indicates that the LDEV is an external LU (for example, 00:01#).
- **RAID:** The RAID level of the LDEV. The RAID level is left unspecified with a hyphen (-) when the LDEV is an external LU.
- **PG:** A combination of a disk group, a parity group. If the LDEV extends over two or more parity groups, the PG column displays the smaller parity group number. A parity group number that starts with a letter E indicates that the parity group consists of one or more external LUs (for example, E1-1).
- **Selected LDEVs:** The number of LDEVs selected in the Free LDEVs table.

### Expanded LDEVs list

Lists the LDEVs that are selected as LUSE volume components. An LDEV from the Free LDEVs table is added to this list by clicking **Add**. The Expanded LDEVs list contains the following information:

- **Selected LDEVs:** The number of LDEVs selected in the Expanded LDEVs list.
- **Number of LDEVs:** The number of LDEVs contained in a LUSE volume.
- **Size:** The capacity of a LUSE volume. The number is displayed in GB or MB depending on the capacity unit selected.

#### **Buttons**

- **Add button:** Adds the selected LDEV(s) from the Free LDEVs table to the Expanded LDEVs list.
- **Delete button:** Removes the selected LDEV(s) from the Expanded LDEVs list and moves it back to the Free LDEVs table.
- **Set button:** Creates a LUSE volume consisting of the volumes currently in the Expanded LDEVs list. The LDEVs that are set as LUSE volume components are shown in blue in the LDEV Information table and the free LDEVs are deleted from the table.
- **Apply button:** Registers the LUSE settings with the disk array.
- **Cancel button:** Cancels the LUSE settings.

## **Viewing LUSE Configuration Information**

Use the Volume Management screen to view the current LUSE configuration:

- The LDEV Information tree displays an outline view of the CU and LDEV numbers installed on the disk array in a hierarchical structure.
- The LDEV Information table displays detailed information for all open system LDEVs in the selected CU. If you have selected a normal LDEV, the information in this section is for the top LDEV. If you have selected a LUSE volume, the information in this table is for all of the LDEVs in the LUSE volume.

An LDEV number that ends with a “#” indicates that the LDEV is an external LU (for example, 00:01#).

## Viewing Concatenated Parity Groups

### To view a concatenated parity group:

1. From the Volume Management screen, click a CU number in the LDEV Information tree. The LDEV Information table displays all the LDEVs in the selected CU.
2. In the LDEV Information table, select the free LDEVs for the LUSE volume and right-click. A pop-up menu is displayed. If the parity groups are concatenated, the **Concatenation List** command is displayed in pop-up menu.
3. Click **Concatenation List** from the pop-up menu. The Concatenation List window is displayed.
4. When you are finished viewing the information, click **OK** to return to the Volume Management screen.

## Creating a LUSE Volume Using the Volume Count Drop-down List



**Caution:** Creating a LUSE volume destroys existing data. To protect your data, make a backup copy of the existing data before starting the LUSE creation operation.

### To create a LUSE volume (Volume Count drop-down list method):

1. From the Volume Management screen, click a CU number in the LDEV Information tree.
2. In the **Select an LDEV** drop-down list, click a top LDEV of the LUSE volume. The Expanded LDEVs list displays the selected top volume. The Free LDEVs table displays normal LDEVs, VSC volumes, and LUSE volumes that can be used for a LUSE volume.  
  
If you select a LUSE volume as the top LDEV, the **Volume Count** drop-down list is grayed out, and [step 3](#) cannot be performed. In this case, click the LDEVs in the Free LDEVs table and then click **Add**. To delete LDEVs, click the LDEVs in the Expanded LDEVs list and then click **Delete**.
3. In the **Volume Count** drop-down list, click the number of LDEVs that should form a LUSE volume.

The Expanded LDEVs list displays as many LDEVs as specified in the **Volume Count** drop-down list. For example, if **3** is specified in the Volume Count, the Expanded LDEVs list displays three LDEVs.

---

**Note:** You cannot click the LUSE volumes in the **Volume Count** drop-down list. To select LUSE volumes, click the LDEVs in the Free LDEVs table and then click **Add**.

---

- To add more LDEVs to the Expanded LDEVs list, click one or more LDEVs in the Free LDEVs table and then click **Add**.
  - To delete LDEVs from the Expanded LDEVs list, click one or more LDEVs in the Expanded LDEVs list and then click **Delete**.
4. Click **Set**. A confirmation dialog box is displayed.
    - If you are performing a LUSE operation on a volume that has a path definition, a confirmation dialog box is displayed. Click **OK** to confirm. Another confirmation dialog box is displayed. Go to [step 5](#).
    - If you are performing a LUSE operation on a volume that does not have a path definition, a confirmation dialog box is displayed.
  5. To create a LUSE, click **OK**. The changes are shown in blue in the LDEV Information table.
  6. Click **Apply**. A confirmation dialog box is displayed.
  7. Click **OK**. The LUSE settings are registered with the disk array.

## Creating a LUSE Volume Using the Select an LDEV Drop-down List



**Caution:** Creating a LUSE volume destroys existing data. To protect your data, make a backup copy of the existing data before starting the LUSE creation operation.

---

### To create a LUSE volume (Select an LDEV drop-down list method):

1. From the Volume Management screen, click a CU number in the LDEV Information tree.

2. In the **Select an LDEV** drop-down list, click a top LDEV of the LUSE volume. The Expanded LDEVs list displays the selected top volume. The Free LDEVs table displays normal LDEVs, VSC volumes, and LUSE volumes that can be used for a LUSE volume.
  - To add LDEVs to the Expanded LDEVs list, click one or more LDEVs in the Free LDEVs table and then click **Add**. The selected LDEV(s) are added to the Expanded LDEVs list and deleted from the Free LDEVs table.
  - To delete LDEVs from the Expanded LDEVs list, click one or more LDEVs in the Expanded LDEVs list and then click **Delete**. The selected LDEV(s) are deleted from the Expanded LDEVs list and displayed in the Free LDEVs table.
3. Click **Set**. A confirmation dialog box is displayed.
  - If you are performing a LUSE operation on a volume that has a path definition, a confirmation dialog box is displayed. Click **OK** to confirm. Another confirmation dialog box is displayed. Go to [step 4](#).
  - If you are performing a LUSE operation on a volume that does not have a path definition, a confirmation dialog box is displayed.
4. To create a LUSE, click **OK**. The changes are shown in blue in the LDEV Information table.
5. Click **Apply**. A confirmation dialog box is displayed.
6. Click **OK** to confirm. The LUSE settings are registered with the disk array.

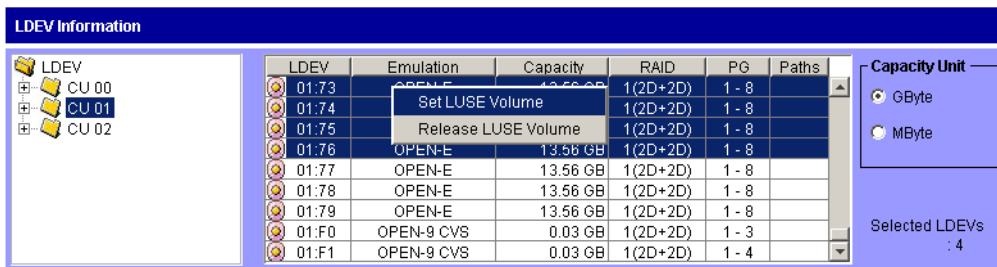
## Creating a LUSE Volume Using the LDEV Information Table



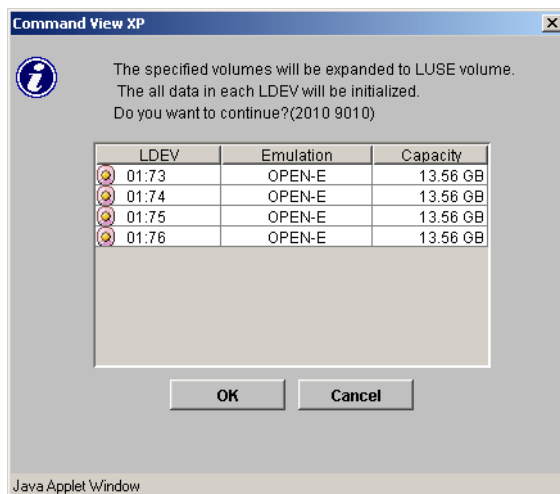
**Caution:** Creating a LUSE volume destroys existing data. To protect your data, make a backup copy of the existing data before starting the LUSE creation operation.

### To create a LUSE volume (LDEV Information table method):

1. From the Volume Management screen, click a CU number in the LDEV Information tree.
2. In the LDEV Information table, select the normal LDEVs, VSC volumes, or LUSE volumes and right-click. A pop-up menu is displayed.



3. Click **Set LUSE Volume** from the pop-up menu.
  - If you are performing a LUSE operation on a volume that has a path definition, a confirmation dialog box is displayed. Click **OK** to confirm. A LUSE creation confirmation window is displayed. Go to [step 4](#).
  - If you are performing a LUSE operation on a volume that does not have a path definition, a LUSE creation confirmation window is displayed.



4. Verify the information in the window and click **OK**. The LUSE creation starts. The changes are shown in blue in the LDEV Information table.
5. Click **Apply**. A confirmation dialog box is displayed.
6. Click **OK** to confirm. The LUSE setting is registered.

## Releasing a LUSE Volume



**Caution:** This operation destroys data. To protect data, be sure to make a backup copy before starting the LUSE releasing operation.

### To release a LUSE volume:

1. From the Volume Management screen, click the CU number from which you want to release a LUSE volume. The LDEV Information table shows all LDEVs that the selected CU contains.
2. In the LDEV Information table, select a LUSE volume and right-click. A pop-up menu is displayed.

LDEV	Emulation	Capacity	RAID	PG	Paths
01:73	OPEN-E	13.56 GB	1(2D+2D)	1-8	
01:74	OPEN-E	13.56 GB	1(2D+2D)	1-8	
01:75	OPEN-E	13.56 GB	1(2D+2D)	1-8	
01:76	OPEN-E	13.56 GB	1(2D+2D)	1-8	
01:77	OPEN-E	13.56 GB	1(2D+2D)	1-8	
01:78	OPEN-E	13.56 GB	1(2D+2D)	1-8	
01:79	OPEN-E	13.56 GB	1(2D+2D)	1-8	
01:F0	OPEN-9 CVS	0.03 GB	1(2D+2D)	1-3	
01:F1	OPEN-9 CVS	0.03 GB	1(2D+2D)	1-4	

3. Click **Release LUSE Volume** from the pop-up menu. A LUSE release confirmation window is displayed.

The specified LUSE volume will be released.  
The all data in the volume will be initialized.  
Do you want to continue?(2010 9060)

LDEV	Emulation	Capacity
01:73	OPEN-E *4	54.26 GB

OK Cancel

Java Applet Window

4. Verify that the information is correct, and then click **OK**. The LUSE release starts. The changes are shown in blue in the LDEV Information table.
5. Click **Apply**. A confirmation dialog box is displayed.
6. Click **OK** to confirm. The LUSE volume is released.

## Changing LUSE Capacities

There are two ways to change the capacity of a LUSE volume:

- Expanding LUSE capacities

To expand the capacity of a LUSE volume, select the LUSE volume you want to expand, and then add LDEVs or LUSE volume(s), or first select the LDEVs or LUSE volume(s) you want to add, and then select a LUSE volume to be expanded.

Each LDEV or LUSE volume that you want to add must have the same capacity as each LDEV in a LUSE volume to be expanded.

- Reducing LUSE capacities

You may not reduce the capacity of an existing LUSE volume. If you want a LUSE volume to have a smaller capacity, you must first release the LUSE volume and then redefine the LUSE volume.

## Resetting an Unregistered LUSE Volume

When you create a LUSE volume, the screen shows the changes in blue bold italics until you register the volume into the disk array by clicking **Apply**. The LUSE volume in blue bold italics indicates that you can reset this LUSE volume to the state before it was created.

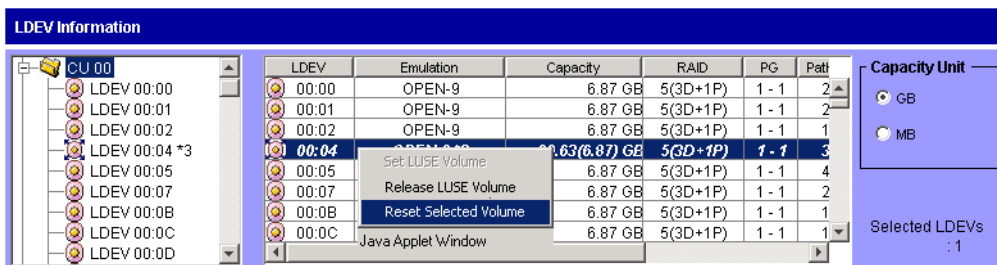
If the XP disk array has firmware version 21.06.22 or later installed, you can reset an unregistered LUSE volume to the state before it was created. However, you cannot recover any LUSE volumes that have been released already to the state when they were created. Therefore, if the LUSE volume that you have created consists of any LDEVs (those in blue bold italics) that have once been released from a different LUSE volume, you can only reset your LUSE volume to the state when the constituting LDEV(s) was released from that different LUSE volume.

**To reset an unregistered LUSE volume:**

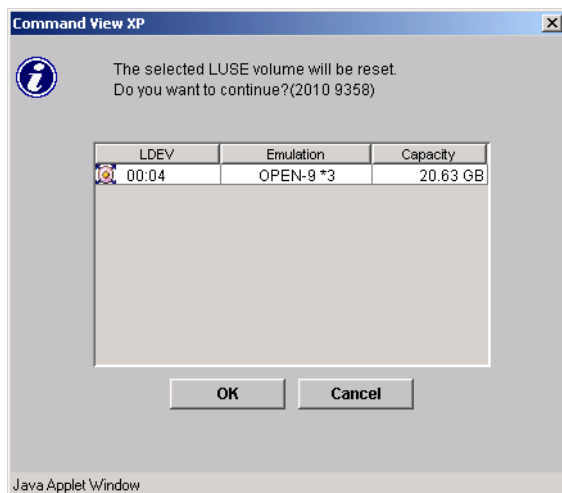
1. From the Volume Management screen, click the CU number from which you want to reset an unregistered LUSE volume. The LDEV Information table shows all LDEVs that the selected CU contains.



- In the LDEV Information table, select an unregistered LUSE volume (in blue bold italics) and right-click. A pop-up menu is displayed.



- Click **Reset Selected Volume** from the pop-up menu. A confirmation window is displayed.



- Verify the information in the window, and then click **OK**. The unregistered LUSE volume will be reset to the state before this LUSE volume was created. The LDEV Information table displays the LUSE volumes or the LDEVs constituting the selected LUSE volume that has just been reset.

## VSC Operations

Before beginning VSC operations, put the volumes in an offline state or unmount them (deallocate LUN paths).


Only users with administrator privileges can perform VSC operations. Non-administrative users can browse VSC information but cannot change it.

VSC operation topics include the following:

- Starting VSC operations (see page 294)
- Customized Volume screen (see page 295)
- Viewing VSC configuration information (see page 296)
- Viewing concatenated parity groups (see page 297)
- Converting volumes to space (see page 297)
- Creating custom volumes (see page 299)
- Deleting custom volumes (see page 309)
- Creating initial custom volumes for OPEN-V (see page 309)
- Initializing custom volumes for other than OPEN-V (see page 317)

## Starting VSC Operations

**To start VSC operations:**

1. From the Launch screen, click an XP128 or XP1024.
2. Click the **LUN and Volume Mgmt** tab, and then click the **Volume Management** button (). The Volume Management screen is displayed.
3. Click the **Customized Volume** tab. The Customized Volume screen is displayed.

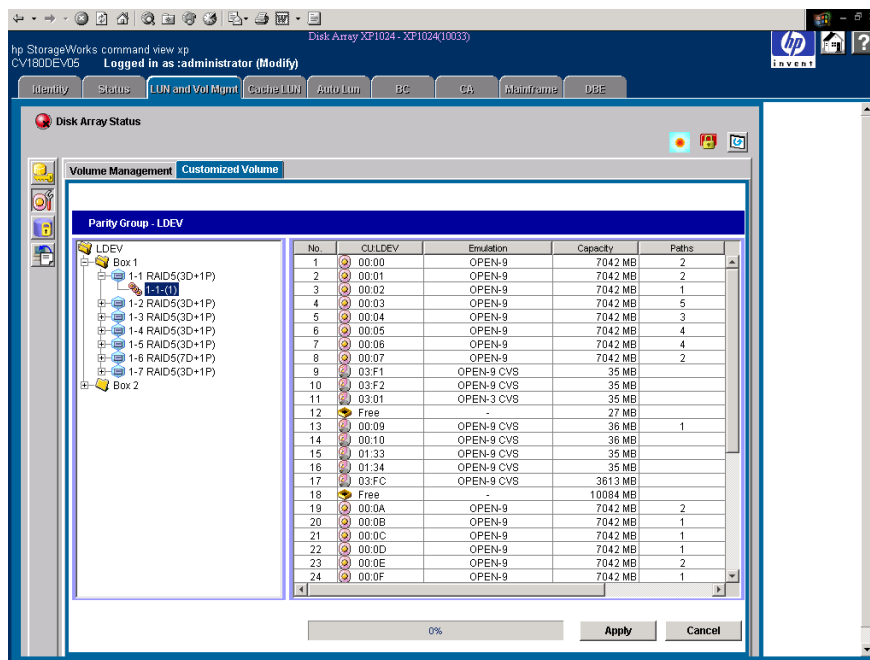


Figure 112: Customized Volume screen (Volume Management screen)

## Customized Volume Screen

### Parity Group - LDEV tree

This tree shows a hierarchical structure of a disk group number (Box 1), parity group numbers (for example, 1-1), RAID levels (for example, 3D+1P), and VDEV numbers (for example, 1-1-1).

An LDEV number that ends with a “#” indicates that the LDEV is an external LU (for example, 00:01#).







The RAID level is left unspecified with a hyphen (-) when the LDEV is an external LU.

### Parity Group - LDEV table

This table shows information about volumes in a VDEV selected in the Parity Group - LDEV tree.

The status of each LDEV is indicated by one of the following icons:

**Table 27: LDEV status icons for VSC operations**

Icon	LDEV status
	Normal LDEV
	LUSE volume
	LDEV reserved for Auto LUN
	VSC volume
	VSC volume reserved for Auto LUN
	Free space

The table contains the following information:

- **No.:** The number of a volume in the VDEV.
- **CU:LDEV:** A CU number/LDEV number combination. “Free” indicates a free space. An LDEV number that ends with a “#” indicates that the LDEV is an external LU (for example, 00:01#).
- **Emulation:** The emulation type of the volume.
- **Capacity:** The capacity of the volume represented in megabytes (MB).
- **Paths:** The number of LU paths that the volume has. This field is blank when the volume has no path.

#### Buttons

- **Apply button:** Registers the VSC settings.
- **Cancel button:** Cancels the VSC settings.

## Viewing VSC Configuration Information

Use the Customized Volume screen and its associated windows to view the current VSC configuration information:

- View the VDEV and LDEV configuration information on the Customized Volume screen. This screen shows an outline of group numbers, parity group numbers, RAID levels, and VDEV numbers and a table of CU:LDEV numbers, emulation types, LDEV capacities, and path settings of VDEVS selected in the outline.

- View the LDEV number setting information from the Install CV, Make Volume, and Volume Initialize windows. In the table, gray indicates LDEV numbers that are already in use, white indicates unused LDEV numbers, and blue indicates available LDEV numbers.

## Viewing Concatenated Parity Groups

### To view a concatenated parity group:

1. From the Customized Volume screen, select a set of parity groups from the Parity Group - LDEV tree and right-click. A pop-up menu is displayed. If the parity groups are concatenated, the **Concatenation List** command is displayed in pop-up menu.
2. Click **Concatenation List** from the pop-up menu. The Concatenation List window is displayed.
3. When you are finished viewing the window, click **OK** to return to the Customized Volume screen.

## Converting Volumes to Space (Volume to Space)

Use the Volume to Space function to convert logical volumes to space (free areas).



**Caution:** The Volume to Space operation destroys data on the logical volumes that are converted.

### To convert volumes to free space:

1. From the Customized Volume screen, click a disk group, a parity group, and a VDEV in the Parity Group - LDEV tree. The Parity Group - LDEV table displays information about LDEVs in the selected VDEV.
2. Click one or more LDEVs (normal or custom volumes) you want to convert to space.

For the OPEN-V emulation type, LUSE volumes can be also converted into free space. If the available LDEV is a LUSE volume, the emulation type is displayed together with an asterisk and the number of volumes in the LUSE volume (for example, OPEN-V\*3) in the Emulation column of the table.

To select two or more consecutive LDEVs, click the LDEVs while pressing the Shift key. To select two or more non-consecutive LDEVs, click the LDEVs while pressing the Ctrl key.

**Note:** You cannot change all LDEVs in the selected VDEV into spaces. You cannot select the last normal or custom volume.

3. Right-click the LDEV selected from the Parity Group - LDEV table. A pop-up menu is displayed.

No.	CU:LDEV	Emulation	Capacity	Paths
1	00:0E	OPEN-9	7042 MB	1
2	00:0F	OPEN-9	7042 MB	1
3	00:10	OPEN-9	7042 MB	1
4	00:11	OPEN-9	7042 MB	1
5	00:12	OPEN-9	7042 MB	1
6	00:13	OPEN-9	7042 MB	1
7	00:14	OPEN-9	7042 MB	1
8	00:F0	OPEN-3	97 MB	
9		OPEN-3	97 MB	
10	00:F2	OPEN-3	97 MB	
11	Free	-	35003 MB	
12	00:1A	OPEN-9	7042 MB	1
13	00:1B	OPEN-9	7042 MB	1
14	Free	-	3395 MB	

4. Click **Volume to Space** from the pop-up menu. A volume confirmation window is displayed.

The following volume will be initialized.  
The stored data in the volume will be removed at the time.  
Do you want to continue?(3010 9011)

VDEV	CU:LDEV	Emulation	Capacity
1-2-(1)	00:F0	OPEN-3	97 MB

OK Cancel

Java Applet Window

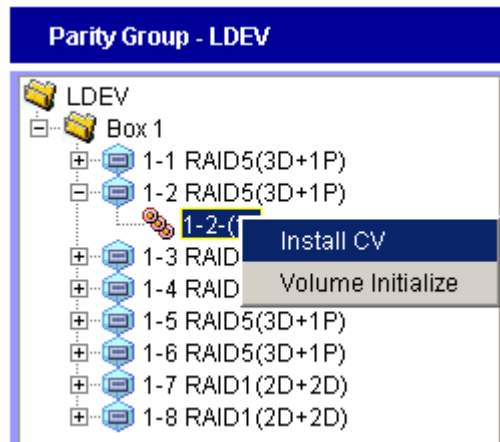
5. Click **OK**. The Parity Group - LDEV table is displayed and the selected LDEVs are marked **Free**.
6. Click **Apply**. A confirmation dialog box is displayed.
7. Click **OK** to confirm. The LDEVs are converted to space.

## Creating Custom Volumes (Install CV)

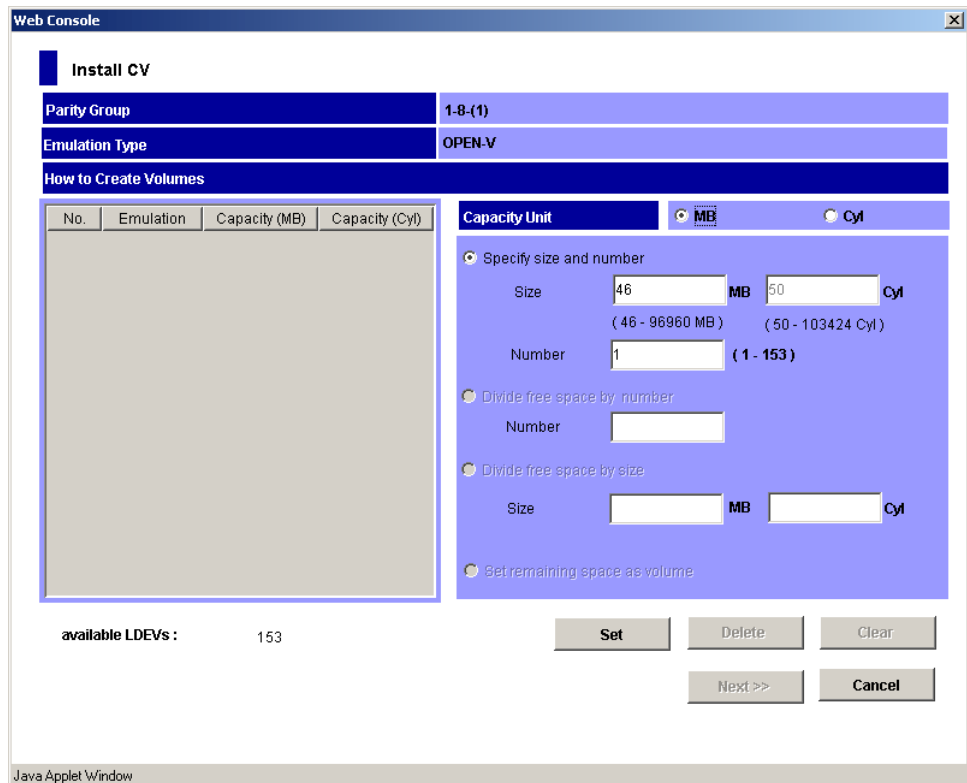
Use the Install CV function to create custom volumes in the free space that is prepared by the Volume to Space function. The Install CV function can define (install) one or more new custom volumes in the available space.

### To create custom volumes:

1. From the Customized Volume screen, click the LDEV folder in the Parity Group - LDEV tree to open a list of CUs, and then click a VDEV. The Parity Group - LDEV table displays information about LDEVs in the selected VDEV.
2. Right-click any part of the Parity Group - LDEV tree. A pop-up menu is displayed.



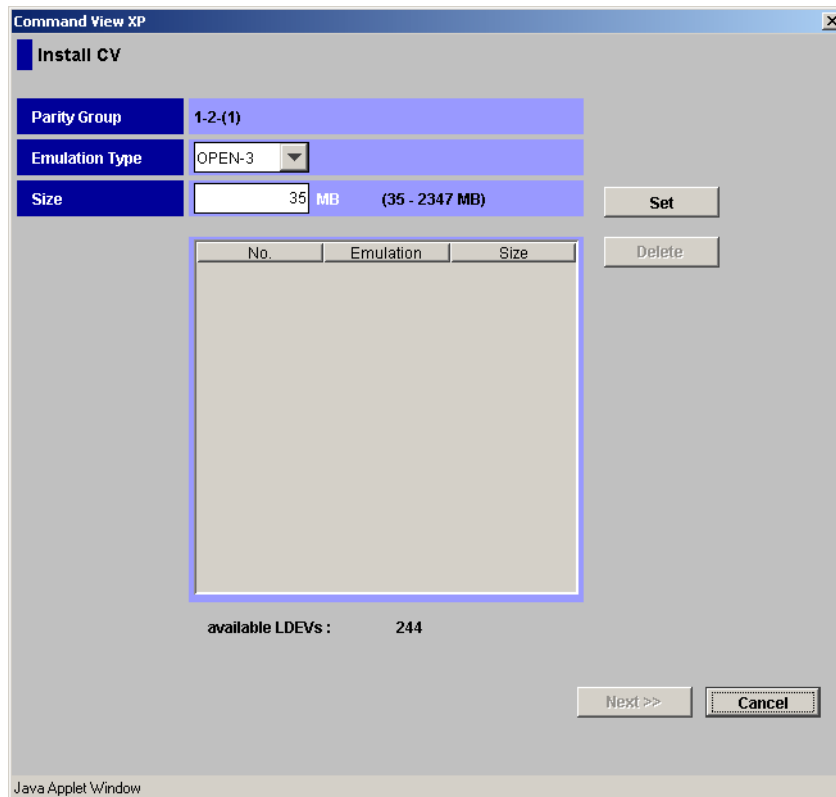
3. Click **Install CV** from the pop-up menu.  
If the VDEV you selected is an OPEN-V volume, the Install CV window (1) for OPEN-V is displayed. Go to [step 4](#).



**Figure 113: Install CV window (1) for OPEN-V (when two or more free spaces are available)**

If the VDEV you selected is not an OPEN-V volume, the Install CV window (1) for other than OPEN-V is displayed. Go to [step 5](#).





**Figure 114: Install CV window (1) for other than OPEN-V**

4. From the Install CV window (1) for OPEN-V, do the following:
  - a. In the Capacity Unit area, click either **MB** or **Cyl** for the capacity unit.
  - b. Select one of methods by clicking **Specify size and number**, **Divide free space by number**, **Divide free space by size**, or **Set remaining space as volume**.

---

**Note:** If there are two or more free spaces in the VDEV, only the **Specify size and number** option is available.

---

- c. Specify the capacity of the volume and/or the number of volumes according to the selected method. For example:

- If you clicked **Specify size and number**, enter the capacity, either in MB or Cyl, in the **Size** field and the number of custom volumes in the **Number** field.
- If you clicked **Divide free space by number**, enter the number of custom volumes in the **Number** field.
- If you clicked **Divide free space by size**, enter the capacity in the **Size** field.
- If you clicked **Set remaining space as volume**, go to the next step.

The Install CV Volume function allocates custom volumes in the order in which the function finds sufficient free space for the custom volumes, so for optimum space allocation you should allocate custom volumes in descending order of capacity.

- d. Click **Set**. The window now displays the selected custom volumes.

**Web Console**

**Install CV**

Parity Group: 1-8-(1)

Emulation Type: OPEN-V

How to Create Volumes

No.	Emulation	Capacity (MB)	Capacity (Cyl)
1	OPEN-V	46 MB	50 Cyl

Capacity Unit:  MB  Cyl

Specify size and number

Size: 46 MB 50 Cyl  
( 46 - 96960 MB ) ( 50 - 103424 Cyl )

Number: 1 ( 1 - 152 )

Divide free space by number

Number:

Divide free space by size

Size:  MB  Cyl

Set remaining space as volume

available LDEVs : 152

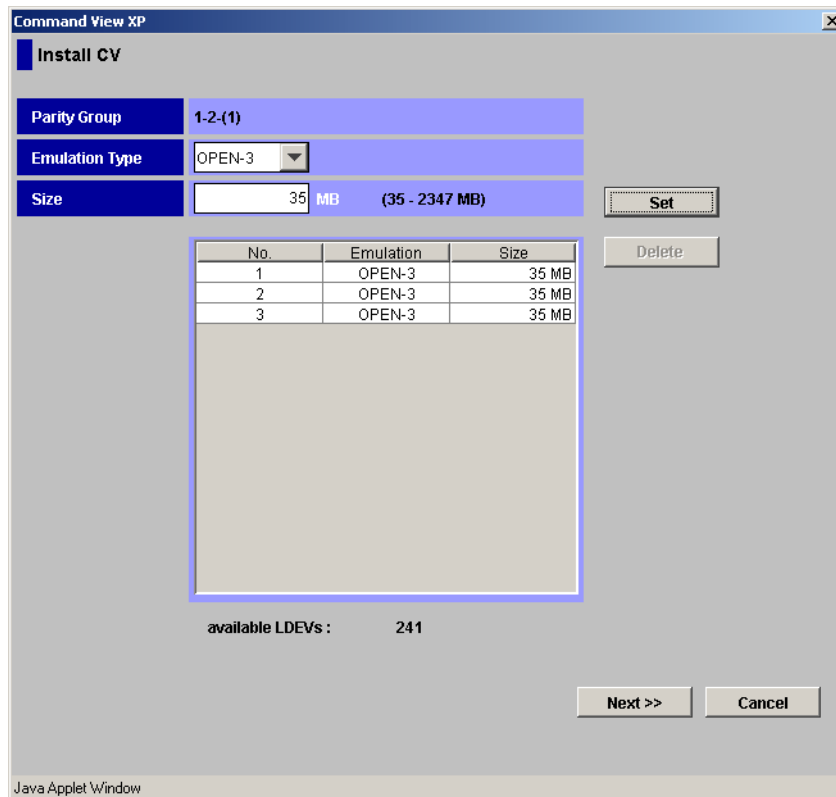
**Set** **Delete** **Clear**

**Next >>** **Cancel**

Java Applet Window

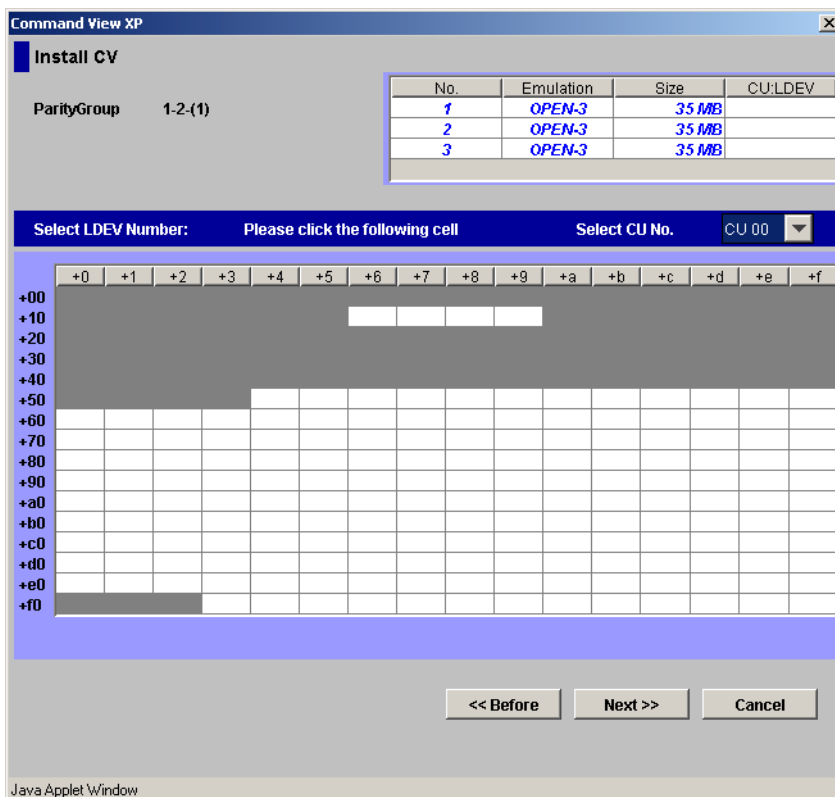
**Figure 115: Install CV window (1) for OPEN-V after clicking Set**

- e. To create other custom volumes, repeat the previous steps.
  - f. To delete a custom volume, click the custom volume, click **Delete**, and then click **OK** to the confirmation message. To delete all custom volumes, click **Clear**, and then click **OK** to the confirmation message. Go to [step 6](#).
5. From the Install CV window (1) for other than OPEN-V, do the following:
- a. In the **Emulation Type** drop-down list, click the emulation type.
  - b. In the **Size** field, enter the capacity of the custom volume you want to create, either in MB for open systems or in cylinders (Cyl) for mainframe volumes. The available capacity range (minimum - maximum) is shown to the right of the **Size** field. The value can be increased incrementally by one MB (open systems) or by one Cylinder (mainframe systems).  
  
The Install CV function allocates custom volumes in the order in which the function finds free space sufficient enough to hold them. Allocate custom volumes in descending order of capacity for optimum space allocation.
  - c. Click **Set**. The window now displays the selected custom volumes.



**Figure 116: Install CV window (1) for other than OPEN-V after clicking Set**

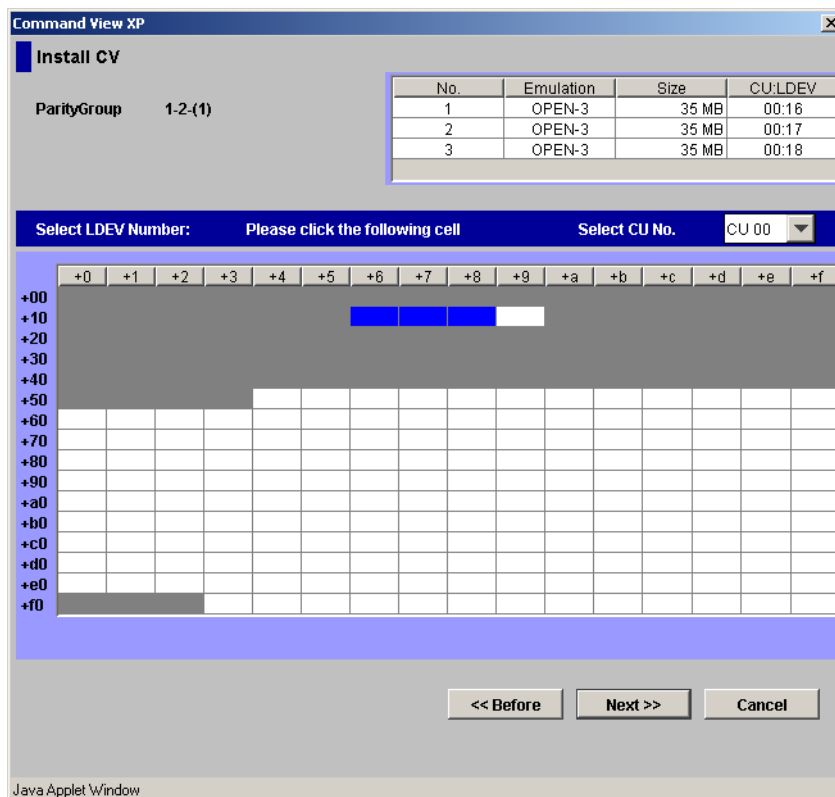
- d. Repeat the previous steps to create additional custom volumes.
- e. To delete a custom volume, click the custom volume, click **Delete**, and then click **OK** to the confirmation message.
6. After completing the custom volume configuration, click **Next**. The Install CV window (2) is displayed.



**Figure 117: Install CV window (2)**

Use this window to specify the CU and LDEV numbers of a custom volume to be created. The window is comprised of two areas. The top area is the *CV setting information area* and shows detailed information about the custom volumes to be created. The bottom area is the *LDEV number setting area* and is used to set the CU and LDEV numbers for the custom volume to be created.

7. In the CV setting information area at the top of the window, click a custom volume number for which you want to set a new CU number and LDEV number.
8. In the **Select CU No.** drop-down list, click a CU number. LDEV number setting area is updated to reflect the selected CU number.
9. In the LDEV number setting area, select an LDEV number by clicking the appropriate white box. For example, to select an LDEV number of 16, click the +10/+6 box as shown in the following figure.



The CU:LDEV number in the CV setting information area is updated.

**Note:** If you specify an LDEV number in the selected CU, free sequential LDEV numbers in LUSE configuration are automatically assigned. You cannot specify an LDEV number, if free LDEV numbers in LUSE configuration are not available in either of the following CUs:

- The CU displayed in the **Select CU No.** drop-down list.
- A CU whose CU number is larger than the CU number displayed in the **Select CU No.** drop-down list.

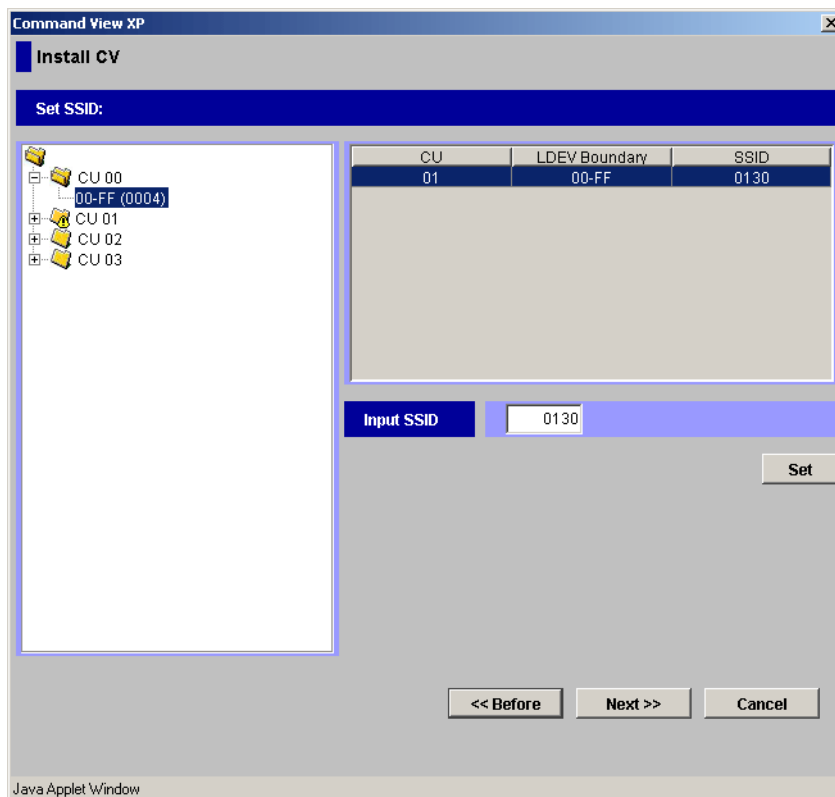
10. To set two or more custom volumes, repeat [step 7](#) - [step 9](#).

11. To change any set volumes, select and right-click the volume in the CV setting information area, and then click **Clear** from the pop-up menu.

No.	Emulation	Size	CU:LDEV
1	OPEN-3	35 MB	01:75
2	OPEN-3	35 MB	
3	OPEN-3	35 MB	

12. After setting all CU numbers and LDEV numbers, click **Next**.

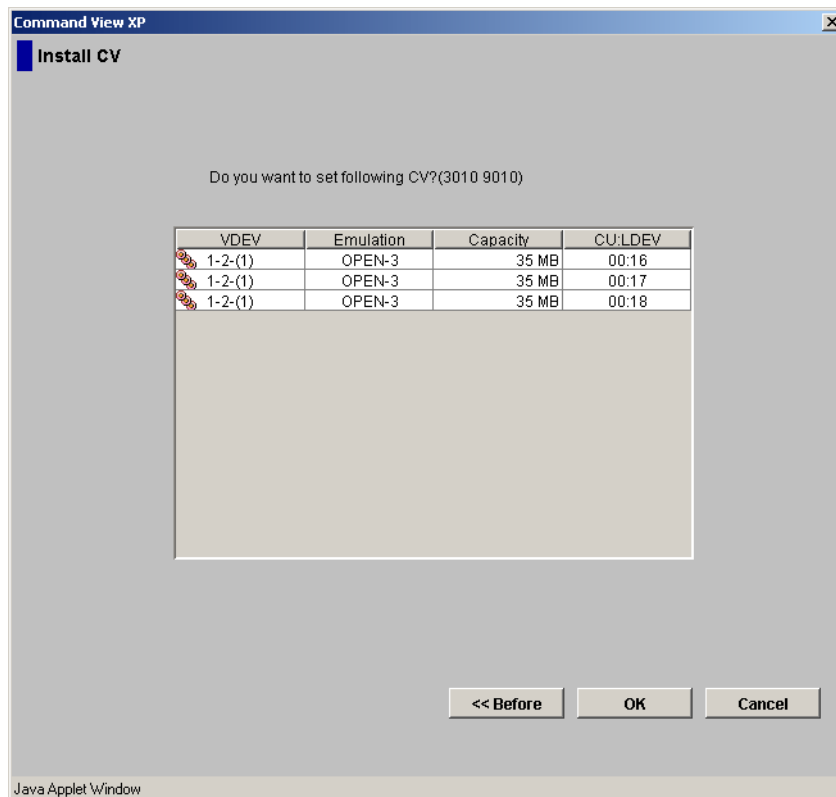
If the boundary area of the selected LDEV number does not have an SSID, a window is displayed for setting the SSID. Go to [step 13](#).



**Figure 118: Setting the SSID**

If the boundary area of the selected LDEV number has an SSID, the Install CV confirmation window is displayed. Go to [step 15](#).

13. In the SSID setting area, click a CU number to assign an SSID to it, enter a new SSID in the **Input SSID** field, and click **Set**. The SSID is displayed in the SSID field of the SSID setting area. Repeat this step until all the SSIDs are set.
14. After setting all the SSIDs, click **Next**. The Install CV confirmation window is displayed.



**Figure 119: Install CV confirmation window**

15. Verify that the information is correct, and then click **OK**. The Customized Volume screen is displayed. The new settings are shown in blue.



Parity Group - LDEV					
No.	CU:LDEV	Emulation	Capacity	Paths	
1	00:0E	OPEN-9	7042 MB	1	
2	00:0F	OPEN-9	7042 MB	1	
3	00:10	OPEN-9	7042 MB	1	
4	00:11	OPEN-9	7042 MB	1	
5	00:12	OPEN-9	7042 MB	1	
6	00:13	OPEN-9	7042 MB	1	
7	00:14	OPEN-9	7042 MB	1	
8	00:F0	OPEN-3	97 MB		
9	00:F1	OPEN-3	97 MB		
10	00:F2	OPEN-3	97 MB		
11	00:16	OPEN-3	35 MB		
12	00:17	OPEN-3	35 MB		
13	00:18	OPEN-3	35 MB		
14	Free	-	34875 MB		
15	00:1A	OPEN-9	7042 MB	1	
16	00:1B	OPEN-9	7042 MB	1	
17	Free	-	3395 MB		

16. Click **Apply**. A confirmation dialog box is displayed.

17. Click **OK**. The custom volume is created.

## Deleting Custom Volumes (Volume to Space)

To deleting a custom volume from a VDEV, convert the custom volume into free space by using the Volume to Space function (see [Converting Volumes to Space \(Volume to Space\)](#) on page 297).

## Creating Initial Custom Volumes for OPEN-V (Make Volume)

Use the Make Volume function to clear all custom volumes under a VSC volume and create an initial volume (VDEV) that consists of new user-defined custom volumes.



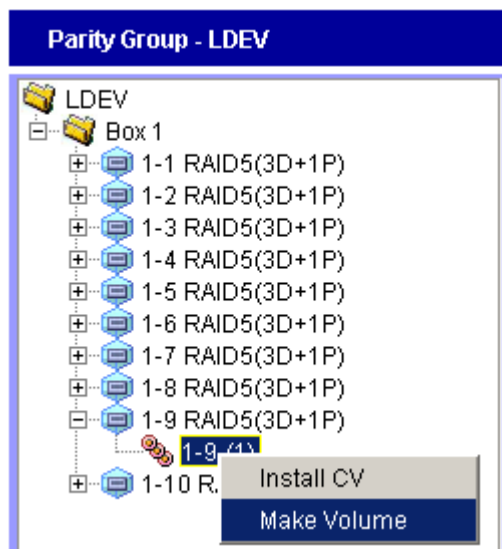
**Caution:** The Make Volume function is a destructive operation and destroys the data on selected custom volumes. Back up the data as needed before performing this operation.

### To create an initial custom volume for OPEN-V:

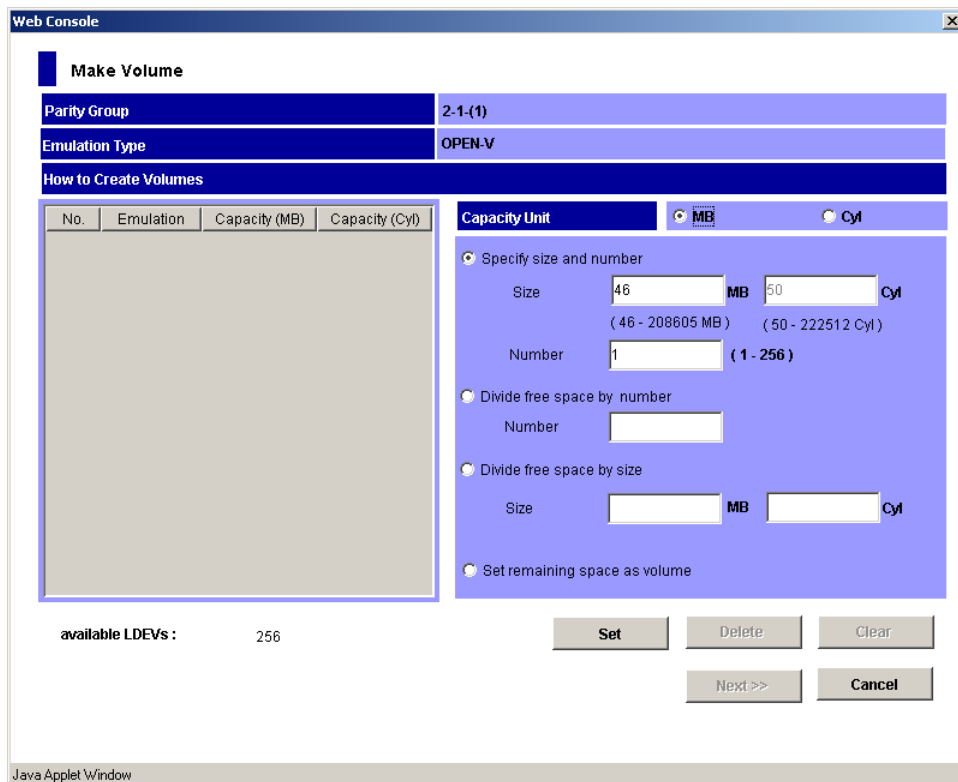
1. From the Customized Volume screen, click the LDEV folder in the Parity Group - LDEV tree to open a list of CUs, and then click a VDEV. The Parity Group - LDEV table displays information of LDEVs in the selected VDEV.

**Note:** If the selected VDEV contains one or more custom volumes that violates any restriction for the Make Volume function (see [Volume to Space Operation](#) on page 276), you cannot perform the Make Volume function. Be sure to remove all invalid custom volumes before performing the Make Volume function.

2. Right-click any part of the Parity Group - LDEV tree. A pop-up menu is displayed.



3. Click **Make Volume** from the pop-up menu. The Make Volume window (1) is displayed.



**Figure 120: Make Volume window (1)**

4. From the Make Volume window (1), do the following:
  - a. In the Capacity Unit area, click either **MB** or **Cyl** for the capacity unit.
  - b. Select one of methods by clicking **Specify size and number**, **Divide free space by number**, **Divide free space by size**, or **Set remaining space as volume**.
  - c. Specify the capacity of the custom volume and/or the number of custom volumes according to the selected method. For example:
    - If you clicked **Specify size and number**, enter the capacity, either in MB or Cyl, in the **Size** field and the number of custom volumes in the **Number** field.
    - If you clicked **Divide free space by number**, enter the number of custom volumes in the **Number** field.

- If you clicked **Divide free space by size**, enter the capacity in the **Size** field.
  - If you clicked **Set remaining space as volume**, go to the next step.
- d. Click **Set**. The window now displays the setting in the table.

**Make Volume**

Parity Group: 2-1-(1)

Emulation Type: OPEN-V

How to Create Volumes

No.	Emulation	Capacity (MB)	Capacity (Cyl)
1	OPEN-V	46 MB	50 Cyl
2	OPEN-V	46 MB	50 Cyl
3	OPEN-V	46 MB	50 Cyl

Capacity Unit:  MB  Cyl

Specify size and number

Size:  MB  Cyl  
( 46 - 208462 MB ) ( 50 - 222360 Cyl )

Number:  ( 1 - 253 )

Divide free space by number

Number:

Divide free space by size

Size:  MB  Cyl

Set remaining space as volume

available LDEVs : 253

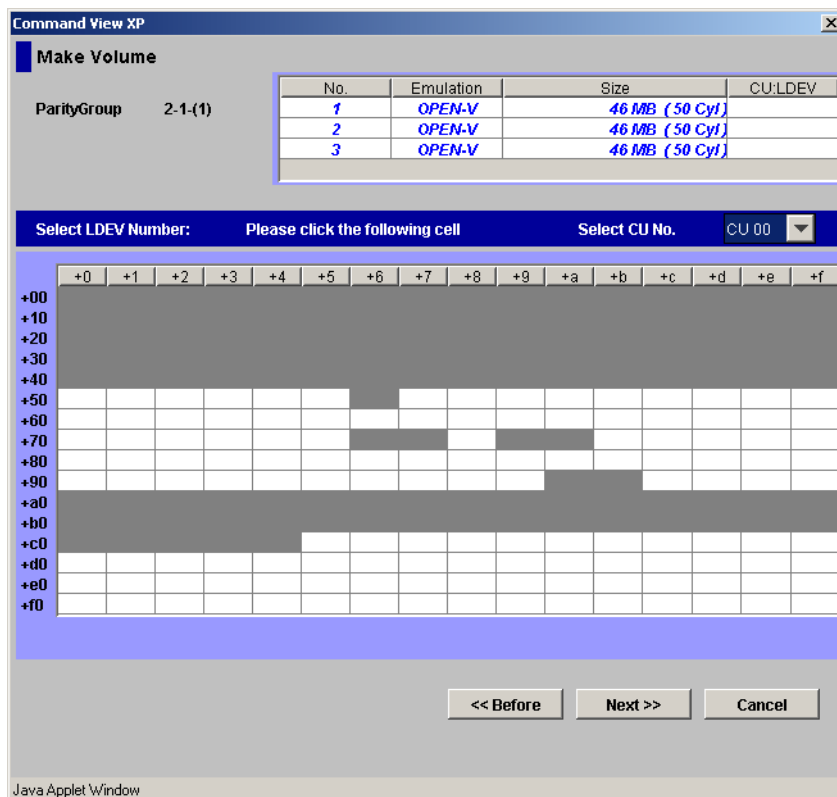
**Set** **Delete** **Clear**

**Next >>** **Cancel**

Java Applet Window

**Figure 121: Make Volume window (1) after clicking Set**

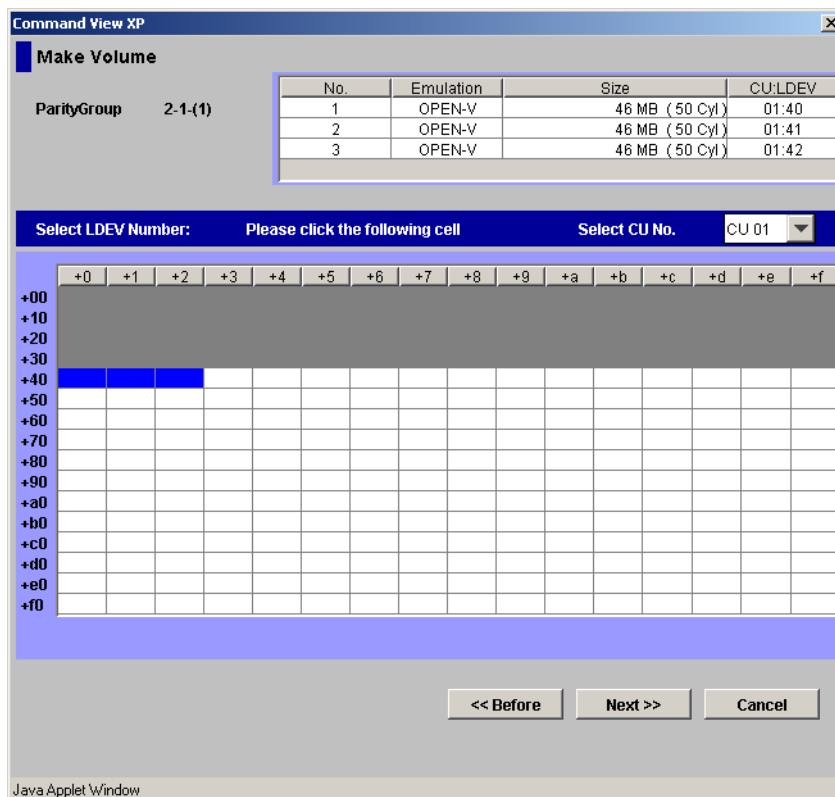
- e. To set other custom volumes, repeat the previous steps.
  - f. To remove a setting, click the custom volume, click **Delete**, and then click **OK** to the confirmation message. To remove all settings, click **Clear**, and then click **OK** to the confirmation message.
5. After setting all custom volumes, click **Next**. The Make Volume window (2) is displayed.



**Figure 122: Make Volume window (2)**

Use this window to assign CU and LDEV numbers to the custom volumes to be created. The window is comprised of two areas. The top area is the *CV setting information area* and shows detailed information about the custom volumes to be initialized. The bottom area is the *LDEV number setting area* and is used to set the CU and LDEV numbers for the custom volume to be initialized.

6. In the CV setting information area at the top of the window, click one or more custom volume numbers.
7. In the **Select CU No.** drop-down list, click a CU number.
8. In the LDEV number setting area, select an LDEV number by clicking the appropriate white box. For example, to select an LDEV number of 16, click the +10/+6 box as shown in the following figure.



The CU:LDEV number in the CV setting information area is updated.

**Note:** If you specify an LDEV number in the selected CU, free sequential LDEV numbers in LUSE configuration are automatically assigned. You cannot specify an LDEV number if free LDEV numbers in LUSE configuration are not available in either of the following CUs:

- The CU displayed in the **Select CU No.** drop-down list.
- A CU whose CU number is larger than the CU number displayed in the **Select CU No.** drop-down list.

9. To set additional volumes, repeat [step 6](#) - [step 8](#).
10. To change any set volumes, select and right-click the volume, and then click **Clear** from the pop-up menu.

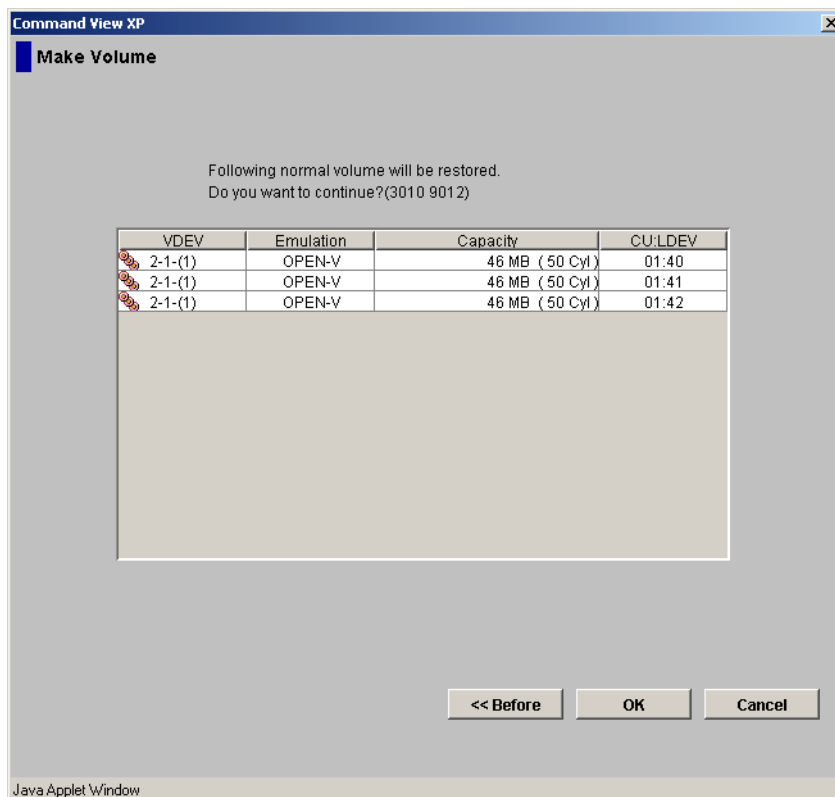
No.	Emulation	Size	CU:LDEV
1	OPEN-V	46 MB ( 50 Cyl )	01:40
2	Clear	46 MB ( 50 Cyl )	01:41
3	OPEN-V	46 MB ( 50 Cyl )	01:42

11. After setting all CU numbers and LDEV numbers, click **Next**.

If the boundary area of the selected LDEV number does not have an SSID, a window is displayed for setting the SSID. Go to [step 12](#).

If the boundary area of the selected LDEV number has an SSID, the Make Volume confirmation window is displayed. Go to [step 14](#).

12. In the SSID setting area, click a CU number to assign an SSID to it, enter a new SSID in the **Input SSID** field, and click **Set**. The SSID is displayed in the SSID field of the SSID setting area. Repeat this step until all the SSIDs are set.
13. After setting all the SSIDs, click **Next**. The Make Volume confirmation window is displayed.



**Figure 123: Make Volume confirmation window**

14. Verify that the information is correct, and then click **OK**. The Customized Volume screen is displayed. The created custom volumes are shown in blue.

---

**Note:** You cannot manipulate the VDEVs denoted by blue icons until you either apply the changes to the disk array or cancel them, but you can initialize additional custom volumes in VDEVs denoted by red icons.

---

15. Click **Apply**. A confirmation dialog box is displayed.
16. Click **OK**. The Make Volume operation begins. When LDEV formatting is in progress and at completion, a notation is displayed across the bottom of the screen to indicate the progress.



## Initializing Custom Volumes for Other than OPEN-V (Volume Initialize)

Use the Volume Initialize function to uninstall all custom volumes under a VSC volume, and reformat the VSC volume as a normal volume (VDEV).



**Caution:** The Volume Initialize function is a destructive operation and destroys the data on selected custom volumes. Back up the data as needed before performing this operation.

### To initialize custom volumes for other than OPEN-V:

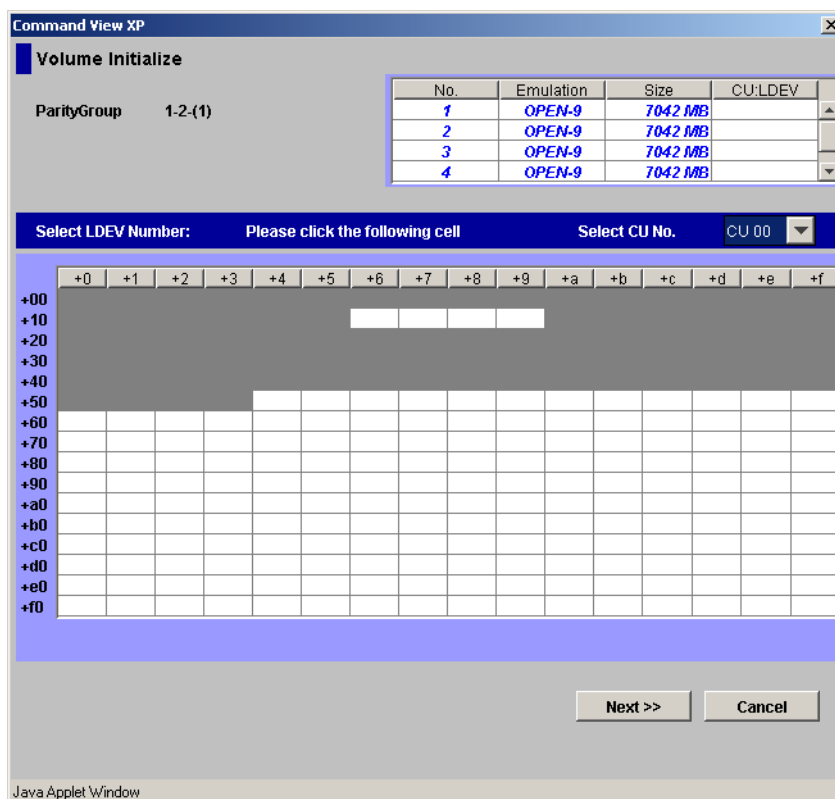
1. From the Customized Volume screen, click the LDEV folder in the Parity Group - LDEV tree to open a list of CUs, and then click a VDEV. The Parity Group - LDEV table displays information of LDEVs in the selected VDEV.

**Note:** If the selected VDEV contains one or more custom volumes that violates any restriction for the Volume Initialize function (see [Volume to Space Operation](#) on page 276), you cannot perform the Volume Initialize function. Be sure to remove all invalid custom volumes before performing the Volume Initialize function.

2. Right-click any part of the Parity Group - LDEV tree. A pop-up menu is displayed.



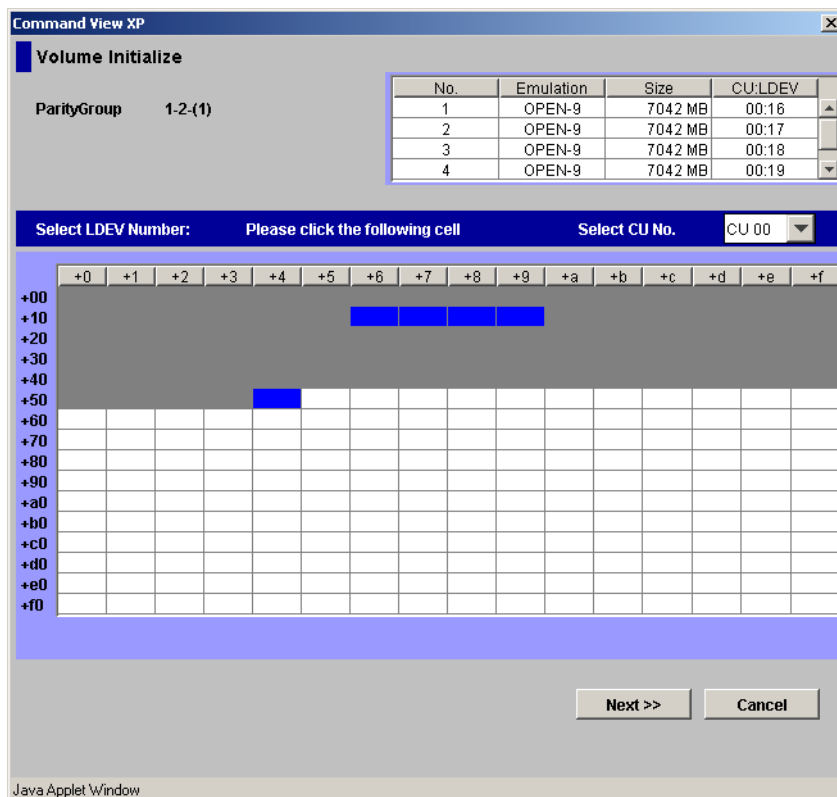
3. Click **Volume Initialize** from the pop-up menu. The Volume Initialize window is displayed.



**Figure 124: Volume Initialize window**

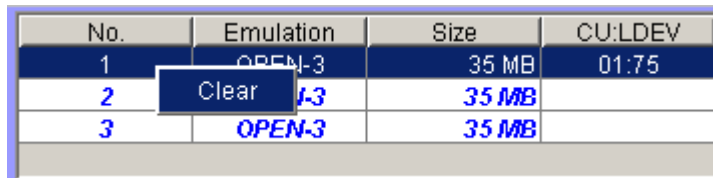
Use this window to initialize custom volumes other than OPEN-V. The window is comprised of two areas. The top area is the *CV setting information area* and shows detailed information about the custom volumes to be initialized. The bottom area is the *LDEV number setting area* and is used to set the CU and LDEV numbers for the custom volume to be initialized.

4. In the CV setting information area at the top of the window, click one or more custom volume numbers.
5. In the **Select CU No.** drop-down list, click a CU number. The LDEV number setting area is updated to reflect the selected CU number.
6. In the LDEV number setting area, select an LDEV number by clicking the appropriate white box. For example, to select an LDEV number of 16, click the +10/+6 box as shown in the following figure.



The CU:LDEV number in the CV setting information area is updated.

7. To set additional volumes, repeat [step 4](#) - [step 6](#).
8. To change any set volumes, select and right-click the volume, and then click **Clear** from the pop-up menu.

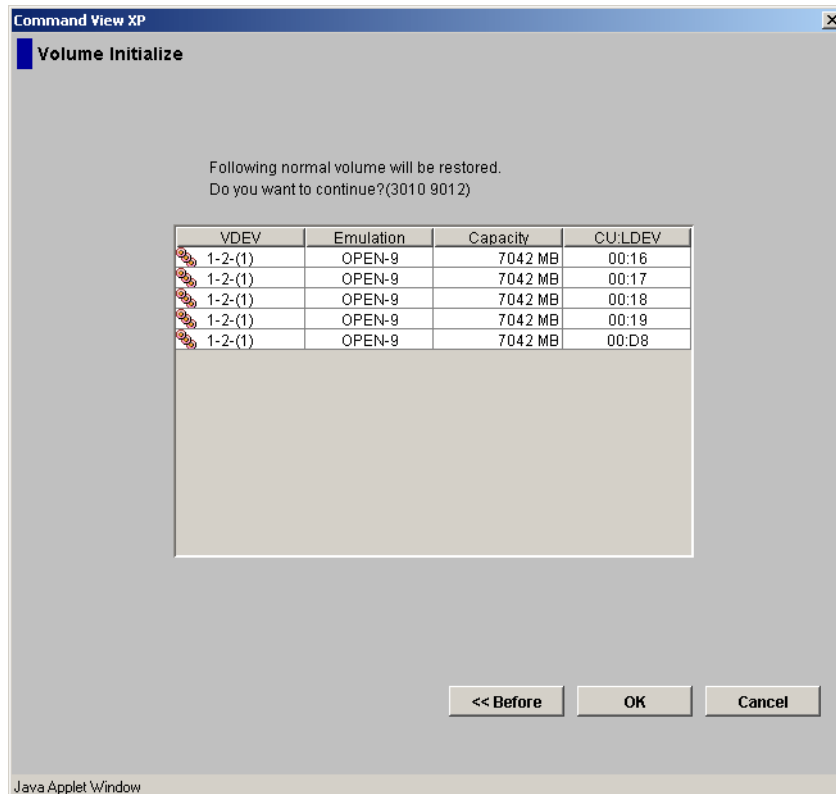


9. After setting all CU numbers and LDEV numbers, click **Next**.

If the boundary area of the selected LDEV number does not have an SSID, a window is displayed for setting the SSID. Go to [step 10](#).

If the boundary area of the selected LDEV number has an SSID, the Volume Initialize confirmation window is displayed. Go to [step 12](#).

10. In the SSID setting area, click a CU number to assign an SSID to it, enter a new SSID in the **Input SSID** field, and click **Set**. The SSID is displayed in the SSID field of the SSID setting area. Repeat this step until all the SSIDs are set.
11. After setting all the SSIDs, click **Next**. The Volume Initialize confirmation window is displayed.



**Figure 125: Volume Initialize confirmation window**

12. Verify that the information is correct, and then click **OK**. The Customized Volume screen is displayed.

A notation is displayed across the top of the screen to indicate that the volume has been initialized, and the color of the VDEV icon that you manipulated in the Parity Group - LDEV outline view changes from red to blue.

---

**Note:** You cannot manipulate VDEVs denoted by blue icons until you either apply the changes to the subsystem or cancel them, but you can initialize additional custom volumes in VDEVs denoted by red icons.

---

13. Click **Apply**. A confirmation dialog box is displayed.
14. Click **OK**. The Volume Initialize operation begins. When LDEV formatting is in progress and at completion, a notation is displayed across the bottom of the screen to indicate the progress.

## Operational Restrictions

The success of some volume management activities depend on the status of the security switch and whether I/O is active or inactive to the port or LUN. The following tables describe those restrictions.

### Restrictions on VSC and LUSE Operations

**Table 28: VSC and LUSE operation restrictions (XP128/XP1024)**

Activity		Security Switch OFF		Security Switch ON	
		Host Group 0	Host Group 01-7F	Host Group 0	Host Group 01-7F
Volume to Space (VSC operation)	With active I/O on LUN	Not permitted	Invalid operation	Not permitted	
	With no active I/O on LUN	Permitted		Permitted	
Make Volume/ Volume Initialize (VSC operation)	With active I/O on LUN	Not permitted	Invalid operation	Not permitted	
	With no active I/O on LUN	Permitted		Permitted	
Deleting a LUSE volume	With active I/O on	Not permitted	Invalid operation	Not permitted	
	With no active I/O on	Permitted		Permitted	

# LUN Security Extension for the XP128/XP1024

## 14

LUN Security Extension provides data protection to an XP disk array from I/O operations performed on open systems hosts. You can use LUN Security Extension to assign an access attribute to each logical volume. If you use LUN Security Extension, you will be able to use a logical volume as a read-only volume as well as protect a logical volume against both read and write operations.

You cannot use LUN Security Extension to change the access attribute of logical volumes that meet certain conditions. For detailed information, see [Using LUN Security Extension with Other Products](#) on page 325.

## Assigning Access Attributes to Logical Volumes

By default, all the open systems volumes are subject to read and write operations by open systems hosts. For this reason, data on open systems volumes might be damaged or lost if an open systems host performs erroneous write operations. Also, confidential data on open systems volumes might be stolen if a malicious operator performs read operations on open systems hosts.

However, if you use LUN Security Extension, you can use logical volumes as read-only volumes to protect the volumes against write operations. You can also protect logical volumes against both read and write operations. LUN Security Extension can restrict read operations and write operations on logical volumes, and prevent data from being damaged, lost, and stolen.

To restrict read and write operations, you must assign an access attribute to each logical volume. Use LUN Security Extension to assign one of the following access attributes to each logical volume:

- **Read/Write:** If a logical volume has the Read/Write attribute, open systems hosts can perform both read and write operations on the logical volume.

Continuous Access (CA) and Business Copy (BC) can copy data to logical volumes that have Read/Write attribute. However, if necessary, you can prevent copying data to logical volumes that have Read/Write attribute.

All open systems volumes have the Read/Write attribute by default.

- **Read Only:** If a logical volume has the Read Only attribute, open systems hosts can perform read operations, but cannot perform write operations on the logical volume.

CA and BC cannot copy data to logical volumes that have Read Only attribute.

- **Protect:** If a logical volume has the Protect attribute, open systems hosts cannot access the logical volume. Open systems hosts cannot perform either read nor write operations on the logical volume.

CA and BC cannot copy data to and from logical volumes that have Protect attribute.

To assign an access attribute to a logical volume, start LUN Security Extension and then apply an access attribute in the LUN Security Extension screen.

The following figure shows the access attributes of the logical volumes 00, 01, and 02. The access attribute of the logical volume 03 is displayed as *Can't Guard*, which indicates that you cannot assign any access attribute to the logical volume. LUN Security Extension does not allow you to assign any access attribute to:

- Mainframe volumes
- Logical volumes (logical devices) that are not mapped to physical devices

LDEV #	Attribute	Type	Capacity	S-Vol	Paths	Mode
00	Read/Write	OPEN-V	58.59 GB	Enable	0	-
01	Read Only	OPEN-V	58.59 GB	Disable	0	-
02	Protect	OPEN-V	58.59 GB	Disable	0	Inv
03	Can't Guard	-	-	-	-	-

**Figure 126: Example of access attributes**

Also note the following:

- You cannot use Command View to change the access attribute from Read Only to Read/Write, or from Protect to Read/Write. If you need to change the access attribute in this way, please contact your HP support team representative for more information.
- If a host computer attempts to write data to a read-only logical volume, the write operation fails and then the write failure is reported to the host.
- If a host computer attempts to read data from or write data to a logical volume that has the Protect attribute, the attempted access fails and then the access failure is reported to the host.



## Using LUN Security Extension with Other Products

### Protecting Logical Volumes Against CA and BC

When Continuous Access (CA) and Business Copy (BC) copies data, the data on the copy destination volume (also known as secondary volume) will be overwritten. If a volume containing important data is specified as a secondary volume by mistake, CA or BC can overwrite important data on the volume and you could suffer loss of important data. LUN Security Extension enables you to avoid such loss of data.


If you assign Read Only attribute or Protect attribute to a logical volume, CA and BC will be unable to copy data to that logical volume. Also, any other write operations will be prohibited on that logical volume. For example, business application software will be unable to write data to such a logical volume.

If you want to prohibit CA and BC from copying data to a logical volume, but do not want to prohibit other write operations to the same logical volume, you must ensure that the logical volume has Read/Write attribute. Also, you must make a setting on that logical volume to prevent CA and BC from copying data to that volume. For detailed information about how to do this, see [Protecting Logical Volumes Against CA and BC Operations](#) on page 333.

### Using LUN Security Extension with Other Products

Do not assign an access attribute to a logical volume if any job is manipulating data on the logical volume. If you assign an access attribute to such a logical volume, the job will possibly end abnormally.

- **Logical volumes:** You cannot use LUN Security Extension to change the access attribute of the following logical volumes:
  - Logical volumes that do not have any of the following emulation types OPEN-3, OPEN-8, OPEN-9, OPEN-E, OPEN-K, OPEN-L, OPEN-M, and OPEN-V.
  - Logical volumes that do not exist.
  - Logical volumes that are configured as command devices.
  - NAS system volumes, which are also known as system LUs.
  - NAS user volumes, which are also known as user LUs.
  - External LUs.

- **LUN Management:** You cannot combine logical volumes that do not have Read/Write attribute when you create a LUSE volume. However, you can assign an access attribute other than Read/Write to the resulting LUSE volume.  
You cannot release a LUSE volume that does not have Read/Write attribute.
- **Volume Management:** You cannot convert volumes that do not have Read/Write attribute into spaces. You cannot initialize customized volumes that do not have Read/Write attribute.
- **RAID Manager:** If someone uses RAID Manager to change the access attribute of a volume when you are using LUN Security Extension, you will be unable to change the access attribute of the volume with LUN Security Extension. If you attempt to change the access attribute of the volume with LUN Security Extension, an error occurs. If the error occurs, click the **Refresh** button () and then retry changing the access attribute of the volume.
- **Other products that can automatically start at a specified time:** Certain products, such as Auto LUN monitoring, start automatically at specified times. If a product that can start automatically is enabled, you must either perform LUN Security Extension operations when the program is not running or cancel the start time setting of the program.


## Starting LUN Security Extension

To use LUN Security Extension, you need to install the following:

- LUN Security Extension license key
- Firmware version 21.07.04 or later

To assign an access attribute, you must use a user account that has the write permission, such the Administrator account, and you must be in Modify mode. If you use a user account that does not have the write permission or you are in View mode, you will be able to view the access attribute of a volume, but you will be unable to assign an access attribute.

### To start LUN Security Extension:

1. From the Launch screen, click an XP128 or XP1024.
2. Click the **LUN and Volume Mgmt** tab, and then click the **LUN Security Extension** button (  ). The LUN Security Extension screen is displayed.

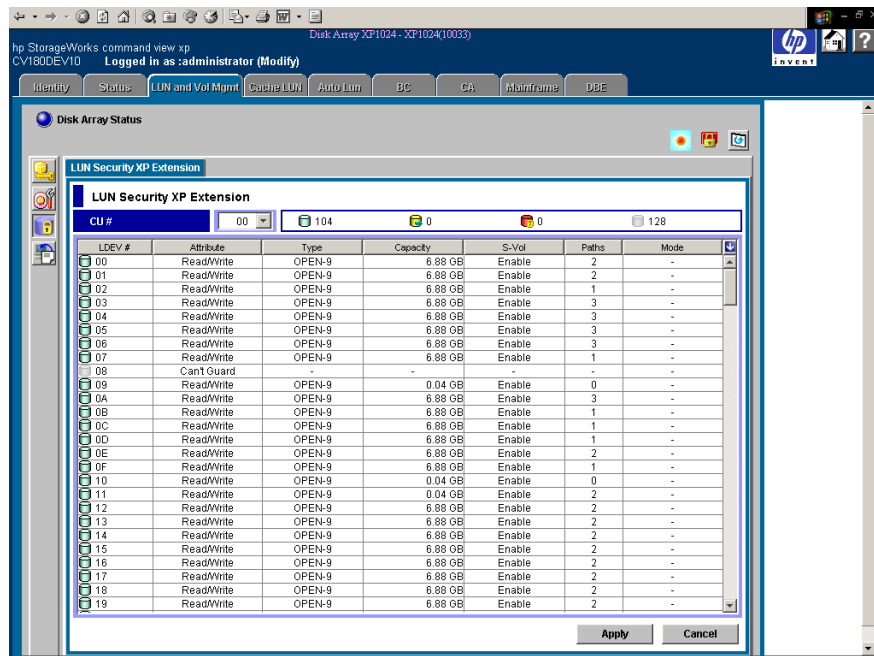






Figure 127: LUN Security Extension screen

## LUN Security Extension Screen

The LUN Security Extension screen is displayed when you start LUN Security Extension and is the starting point for all the LUN Security Extension operations. The LUN Security Extension screen displays the following items:

- **CU# drop-down list:** Used to specify a CU image. If you specify a CU image, the table displays logical volumes in the CU image. To the right of this drop-down list are four icons:

**Table 29: LUN Security Extension icons**

Icon	Status
	Logical volumes that have the Read/Write attribute.
	Logical volumes that have the Read Only attribute.
	Logical volumes that have the Protect attribute.
	Mainframe volumes and logical volumes (logical devices) that are not mapped to any physical storage devices. You cannot assign an access attribute to these volumes.

**Note:** If two or more volumes are combined into a LUSE volume, LUN Security Extension counts the number of the combined volumes as one. For example, if you combine five logical volumes into one LUSE volume, the number of volumes is one, not five.


The LUN Security Extension table lists logical volumes and the access attribute of each logical volume. The table contains the following columns:

- **LDEV#:** Displays logical volume numbers. The LUN Security Extension icons shown in [Table 29](#) displays additional information about each volume. If the symbol # is displayed to the right of a logical volume number, the logical volume is an external LU. You cannot assign an access attribute to external LUs.
- **Attribute:** Indicates the access attribute of each logical volume. If this column displays **Can't Guard**, you cannot assign an access attribute to the logical volume.
- **Type:** Displays volume emulation types.

If an asterisk and a number appear to the right of an emulation type, the logical volume is a LUSE volume. For example, OPEN-3\*36 indicates a LUSE volume into which 36 logical volumes are combined. For detailed information about LUSE volumes, refer to the LUN Management chapter of this user guide.

- **Capacity:** Displays the capacity of each logical volume. The unit is gigabytes (GB).
- **S-Vol:** Indicates whether each logical volume can be specified as a copy destination for Continuous Access (CA) and Business Copy (BC) operations. The CA and BC chapters in this user guide sometimes use the term S-VOL or secondary volume to refer to a logical volume used as a copy destination.
- **Paths:** Displays the number of LU paths to each logical volume.
- **Mode:** Displays the mode that the RAID Manager user assigns to the logical volume:
  - **Zer:** Indicates that Zero Read Cap mode is assigned to the logical volume. If the Read Capacity command (a SCSI command) is issued to a logical volume in Zero Read Cap mode, it will be reported that the capacity of the logical volume is zero.
  - **Inv:** Indicates that Invisible mode is assigned to the logical volume. If the Inquiry command (a SCSI command) is issued to a logical volume in Invisible mode, it will be reported that the logical volume does not exist. Therefore, the hosts will be unable to recognize the logical volume.
  - **Zer/Inv:** Indicates that both Zero Read Cap mode and Invisible mode are assigned to the logical volume.
  - **-(a hyphen):** Indicates that no mode is assigned by RAID Manager to the logical volume.

You cannot use LUN Security Extension change modes. Use RAID Manager to change modes.

-  **button:** Located in the upper-right corner of the table and selects all the logical volumes in the table.

If two or more volumes are combined into a LUSE volume, LUN Security Extension displays only the top LDEV but does not display other LDEVs (other volumes) that are combined into the LUSE volume. For example, if three volumes **03**, **04**, and **05** in the CU image **01** are combined into a LUSE volume, the table in the LUN Security Extension screen displays the volume number **03**, but does not

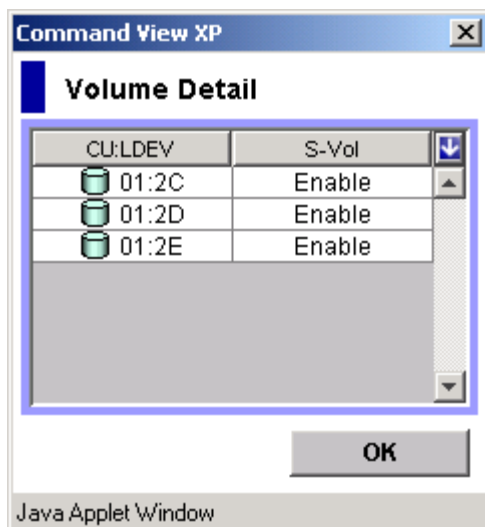
display **04** and **05**. If you want to view all logical volumes that form a LUSE volume, see [Viewing a List of Logical Volumes Combined into a LUSE Volume](#) on page 335.

### Buttons

- **Apply:** Applies settings in the LUN Security Extension screen to the disk array.
- **Cancel:** Discards settings in the LUN Security Extension screen.

## Volume Detail Window

The Volume Detail window displays a list of logical volumes combined into an LUSE volume (see page 335). For detailed information about LUSE volumes, refer to the LUN Management chapter of this user guide.



**Figure 128: Volume Detail window**

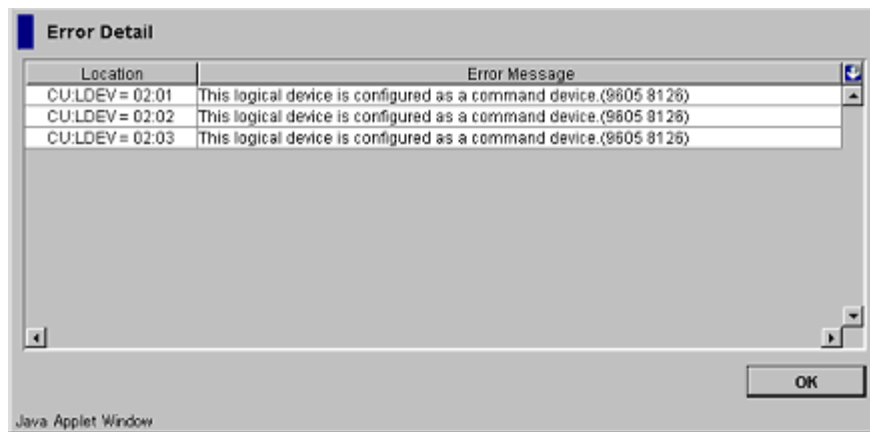
The Volume Detail window displays the following items:

- **CU:LDEV:** Lists logical volumes combined into an LUSE volume. To the left of the colon (:) appears the CU image number to which the logical volume belong. To the right of the colon appears the logical volume number.

- **S-Vol:** Indicates whether each logical volume can be specified as a copy destination volume (a secondary volume) for Continuous Access (CA) and Business Copy (BC) operations. **Enable** is shown if the logical volume can be specified as a copy destination volume. **Disable** is shown if the logical volume cannot be specified as a copy destination volume.
- **OK button:** Closes the Volume Detail window.

## Error Detail Window

The Error Detail window displays error locations and error messages when a LUN Security Extension operations error.



**Figure 129: Error Detail window**

The Error Detail window displays the following items:

- **Location:** Indicates where errors occur. If an error occurs with a logical volume, this column displays the CU number and the LDEV number (logical volume number).
- **Error Message:** Displays error messages.
- **OK button:** Closes the Error Detail window.

## Using LUN Security Extension

LUN Security Extension topics include the following:

- Changing the access attribute of a logical volume (see page 332)
- Protecting logical volumes from Continuous Access (CA) and Business Copy (BC) operations (see page 333)
- Viewing a list of logical volumes combined into a LUSE volume (see page 335)


You must operate Command View in Modify mode to perform LUN Security Extension operations. Users in view mode can only view LUN Security Extension information.

## Changing Access Attributes of Logical Volumes

To change the access attribute of a logical volume and apply the changes to the disk array, note the following:

- You cannot use Command View to change the access attribute from Read Only to Read/Write, or from Protect to Read/Write. If you need to change the access attribute in this way, please contact your HP support team representative for more information.
- If you change the access attribute of a volume from Read/Write to Read Only or Protect, Continuous Access (CA) and Business Copy (BC) will be unable to copy data to the volume.

### To change the access attribute of a logical volume:

1. From the LUN Security Extension screen, click a CU image in the **CU#** drop-down list. The table displays a list of logical volumes in the specified CU image. The access attributes are displayed on the right of logical volume names.
2. Select and right-click the logical volume whose access attribute you want to change. If you want to assign the same access attribute to all the logical volumes in the table, click the  button in the upper-right corner of the table and then right-click. A pop-up menu is displayed.



LDEV #	Attribute	Type	Capacity	S-Vol	Paths	Mode
00	Can't Guard	-	-	-	-	-
01	Read/Write	OPEN-9	6.88 GB	Enable	2	-
02	Read/Write	OPEN-9	6.88 GB	Enable	2	-
03	Read/Write	OPEN-9	6.88 GB	Enable	2	-
04	Read/Write	OPEN-9	6.88 GB	Enable	3	-
05	Read/Write	OPEN-9	6.88 GB	Enable	1	-
06	Read/Write	OPEN-9	6.88 GB	Enable	0	-
07	Read/Write	OPEN-9	6.88 GB	Enable	0	-
08	Read/Write	OPEN-9	6.88 GB	Enable	0	-
09	Read/Write	OPEN-9	6.88 GB	Enable	0	-
0A	Read/Write	OPEN-9	6.88 GB	Enable	0	-
0B	Read/Write	OPEN-9	6.88 GB	Enable	4	-

- From the pop-up menu, click **Attribute** and then click the access attribute you want to assign. The logical volume is displayed in blue and italics when the access attribute changes. The volume icon also changes when the access attribute changes. If you want to change access attribute of other logical volumes, repeat this step.

LDEV #	Attribute	Type	Capacity	S-Vol	Paths	Mode
00	Can't Guard	-	-	-	-	-
01	Read/Write	OPEN-9	6.88 GB	Enable	2	-
02	Read/Write	OPEN-9	6.88 GB	Enable	2	-
03	Read/Write	OPEN-9	6.88 GB	Enable	2	-
04	Read/Write	OPEN-9	6.88 GB	Enable	3	-
05	<i>R/W -&gt; R/O</i>	<i>OPEN-9</i>	<i>6.88 GB</i>	<i>Ena -&gt; Dis</i>	<i>1</i>	<i>-</i>
06	Read/Write	OPEN-9	6.88 GB	Enable	0	-

- If you want to change access attributes of logical volumes in other CU images, repeat [step 1](#) - [step 3](#).
- Click **Apply**. A confirmation dialog box is displayed.
- Click **OK**. The settings are applied to the disk array.

## Protecting Logical Volumes Against CA and BC Operations

Assigning the Read Only or Protect attribute is one way to prevent data in a volume from being overwritten by Continuous Access (CA) and Business Copy (BC) copy operations. Volumes with the Read Only or Protect attribute are protected against these copy operations, but are also protected against any other form of write operations.

If you want to protect a logical volume only against CA or BC copy operations, you must ensure that the logical volume has Read/Write attribute. Then, complete the following the procedure to prohibit a logical volume from being specified as a secondary volume (a copy destination volume) for CA or BC operations. The following procedure does not work if a logical volume is already used as a secondary volume (S-VOL) for CA or BC.

**To prevent a Read/Write volume from being specified as a secondary volume:**

1. From the LUN Security Extension screen, click a CU image in the **CU#** drop-down list. The table displays a list of logical volumes in the specified CU image.
2. Look at the S-Vol column of the table to find which volumes can be specified as secondary volumes. The column displays **Enable** if the logical volume can be specified as a secondary volume, or **Disable** if the logical volume cannot be specified as a secondary volume.
3. Select and right-click the logical volume. A pop-up menu is displayed.

LDEV #	Attribute	Type	Capacity	S-Vol	Paths	Mode
00	Can't Guard	-	-	-	-	-
01	Read/Write	OPEN-9	6.88 GB	Enable	2	-
02	Read/Write	OPEN-9	6.88 GB	Enable	2	-
03	Read/Write	OPEN-9	6.88 GB	Enable	2	-
04	Read/Write	OPEN-9	6.88 GB	Enable	3	-
05	Read/Write	OPEN-9	6.88 GB	Enable	1	-
06	Read/Write	OPEN-9	6.88 GB	Enable	0	-
07	Read/Write	OPEN-9	6.88 GB	Enable	1	-
08	Read/Write	OPEN-9	6.88 GB	Enable	1	-
09	Read/Write	OPEN-9	6.88 GB	Enable	2	-
0A	Read/Write	OPEN-9	6.88 GB	Enable	0	-
0B	Read/Write	OPEN-9	6.88 GB	Enable	1	-

4. From the pop-up menu, click **S-Vol** and then **Disable**. The logical volume is displayed in blue and italics.

LDEV #	Attribute	Type	Capacity	S-Vol	Paths	Mode
00	Can't Guard	-	-	-	-	-
01	Read/Write	OPEN-9	6.88 GB	Enable	2	-
02	Read/Write	OPEN-9	6.88 GB	Enable	2	-
03	Read/Write	OPEN-9	6.88 GB	Enable	2	-
04	Read/Write	OPEN-9	6.88 GB	Enable	3	-
05	<i>Read/Write</i>	<i>OPEN-9</i>	<i>6.88 GB</i>	<i>Ena -&gt; Dis</i>	<i>1</i>	-
06	Read/Write	OPEN-9	6.88 GB	Enable	0	-
07	Read/Write	OPEN-9	6.88 GB	Enable	1	-

5. If you want to prevent other logical volumes from being specified as a secondary volume, repeat the previous steps.
6. Click **Apply**. A confirmation dialog box is displayed.
7. Click **OK**. The settings are applied to the disk array.

**Note:** To allow the logical volume to be specified as a secondary volume (a copy destination volume), select and right-click the logical volume, and then click **S-Vol** and **Enable** from the pop-up menu. Finally, confirm that the logical volume turns blue and italics, and then click **Apply**.

## Viewing a List of Logical Volumes Combined into a LUSE Volume

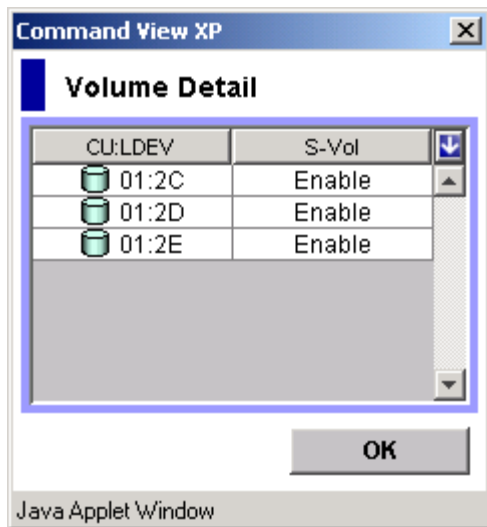
LUN Expansion (LUSE) combines two or more logical volumes to form a LUSE volume. If logical volumes are combined into a LUSE volume in your disk array, the LUN Security Extension screen does not display all the combined volumes, but displays only the top LDEV. The top LDEV is a logical volume whose LDEV number is the smallest of all the logical volumes combined into a LUSE volume. For detailed information about LUSE volumes, refer to the LUN Management chapter of this user guide. If you want to display all the volumes combined into a LUSE volume, complete the following instructions.

### To view a list of logical volumes combined into a LUSE volume:

1. From the LUN Security Extension screen, locate a LUSE volume by looking at the Type column of the table. If an asterisk (\*) and a number appear to the right of the emulation type, the volume is a LUSE volume. For example, *OPEN-V\*3* indicates a LUSE volume consisting of three OPEN-V volumes.
2. Select and right-click the LUSE volume. A pop-up menu is displayed.

LDEV #	Attribute	Type	Capacity	S-Vol	Paths	Mode
23	Read/Write	OPEN-E	13.57 GB	Enable	1	-
26	Read/Write	OPEN-E	13.57 GB	Enable	1	-
27	Read/Write	OPEN-E	13.57 GB	Enable	0	-
28	Read/Write	OPEN-E	13.57 GB	Enable	0	-
29	Read/Write	OPEN-E	13.57 GB	Enable	0	-
2A	Read/Write	OPEN-E	13.57 GB	Enable	1	-
2B	Read/Write	OPEN-E	13.57 GB	Enable	1	-
2C	Read/Write	OPEN-E*3	10.70 GB	Enable	0	-
2F	Read/Write	OPEN-E	3.57 GB	Enable	2	-
30	Read/Write	OPEN-E	3.57 GB	Enable	2	-
31	Read/Write	OPEN-E	3.57 GB	Enable	2	-
32	Read/Write	OPEN-E	3.57 GB	Enable	2	-

3. From the pop-up menu, click **Volume Detail**. The Volume Detail window displays all the logical volumes combined into the same LUSE volume.



**Figure 130: Volume Detail window**

4. Click **OK** to close the window.

# Configuration File Loader for the XP128/XP1024

15

You can use Command View to define the configuration of the disk array. Using the Command View GUI is appropriate for a small-scale changes, but can be too time consuming for a large-scale changes or for new settings. In addition, setting up large-scale changes with the GUI may produce errors. Configuration File Loader solves this problem by writing the parameters in a file and apply the settings quickly.

Any text editor or spreadsheet software can be used to edit the configuration definition files. The files should be edited according to the specific formats and rules described in this chapter.

With Configuration File Loader, you can set the disk arrays to have the same configuration by applying the same configuration definition file. You can also define the configuration offline.

In this chapter, the following information about Configuration File Loader is explained:

- Configuration File Loader components (see page 337)
- Outline of the Configuration File Loader operation (see page 338)
- Type of spreadsheet and available function (see page 339)

## Configuration File Loader Components

Configuration File Loader is comprised of two main components, the Configuration File Loader screen and the spreadsheet file.

Use the Configuration File Loader screen to download a spreadsheet file that includes the current configuration information, and to upload a file with the new configuration that you have defined. The Configuration File Loader screen shows the status and the error information of the uploaded file. From this screen, you can check the error information on the uploaded file and when there is no error in the file, you can apply the new configuration in the file by clicking the **Apply** button.

For detailed information on the components and the operations of the Configuration File Loader screen, see [Configuration File Loader Screen](#) on page 344.

The spreadsheet file, which contains information that defines the configuration settings, is a text file in the CSV (Comma Separated Value) format and must use the *.spd* file extension

At the beginning of the Configuration File Loader operation, the spreadsheet file needs to be downloaded from the disk array. You can then edit the downloaded spreadsheet file and upload the file.

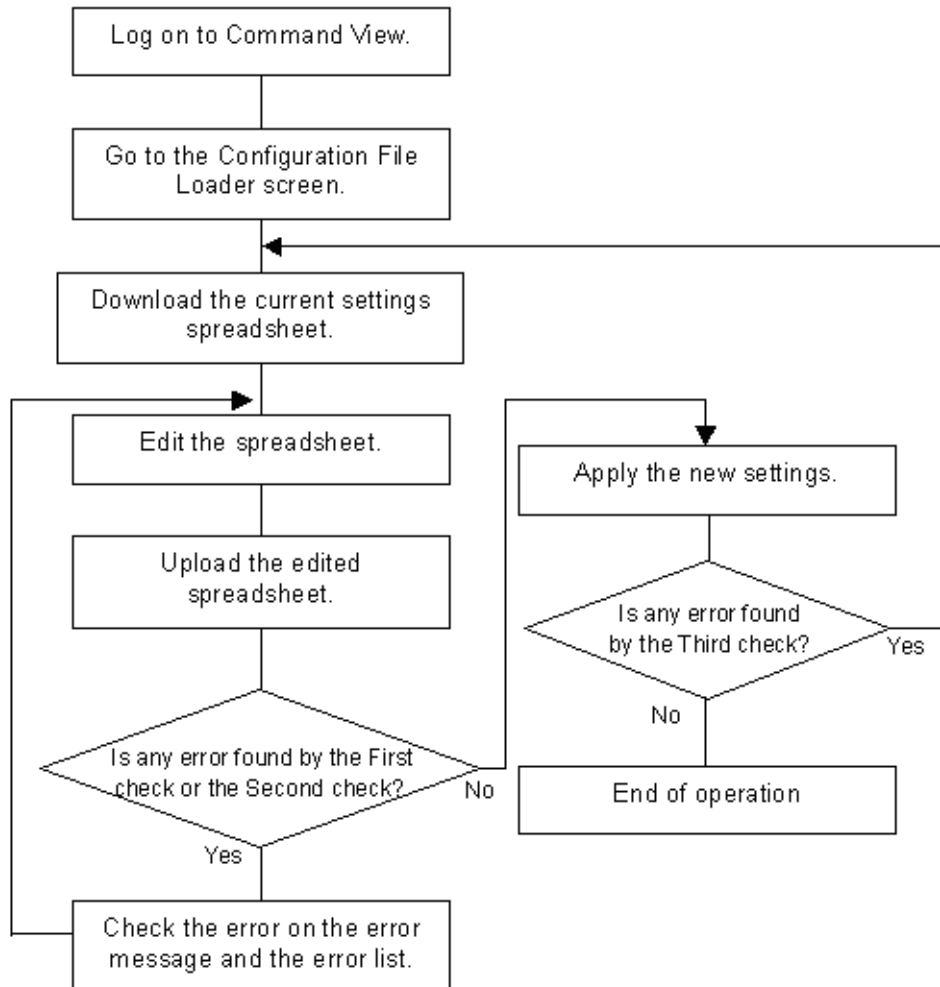
Use spreadsheet software or a text editor to edit the spreadsheet file. For information on using spreadsheet software to edit the spreadsheet, see [Spreadsheet Software Requirements](#) on page 341. Also, the spreadsheet must be written in a specific format and follow certain rules. See [Spreadsheet Rules and Formats](#) on page 346 for an explanation.

## Configuration File Loader Tasks

The main tasks of Configuration File Loader include:

- Accessing Configuration File Loader (see page 361)
- Downloading the current settings spreadsheet (see page 362)
- Editing the spreadsheet (see page 363)
- Uploading the edited spreadsheet (see page 365)
- Checking for errors (see page 367)

[Figure 131](#) shows an outline of the Configuration File Loader tasks.



**Figure 131: Outline of the Configuration File Loader tasks**

## Spreadsheet Type and Available Function

At this time, the LUN Manager spreadsheet is the only available spreadsheet. The spreadsheet for the features is not yet available, which means that Configuration File Loader can be used to set the LUN Manager settings (such as adding host group or path settings), but not for the other features such as Cache LUN or Volume Management.

For further information on the LUN Manager functions and settings, please refer to [LUN Management for the XP128/XP1024](#) on page 189. The available formats and the parameters of LUN Manager spreadsheet are described in [LUN Manager Spreadsheet](#) on page 354.

The spreadsheet can define the following LUN Manager settings.

- LUN path settings:
  - Add, delete, or change LU paths.
  - Set or release the command device and command device security.
- LUN security settings:
  - Create, delete, or change the host group (host storage domain).
  - Add or delete WWNs.
  - Apply or remove LUN security (security switch).
- Port settings:
  - Change the settings for AL-PA, data transfer speed (host speed) and topology.
- CHA settings:
  - Change the PCB mode (high-speed, high-speed (2 port), or standard).

---

**Note:** High-speed (2 port) mode is available only if the XP disk array has firmware version 21.06.22 or later installed.

---



## Requirements for Configuration File Loader

Configuration File Loader comes preloaded from the factory. In addition to meeting the minimum Command View installation requirements and installing Command View, you also need to install the following before using Configuration File Loader:

- Spreadsheet software or text editor
- HP StorageWorks LUN Configuration and Security Manager XP (to manage LUN configuration files)
- Java Web Start 1.2

### Java Web Start

Configuration File Loader uses Java Web Start 1.2 to transfer (upload and download) a spreadsheet file to the disk array. Java Web Start is a utility that allows Command View XP to execute a program locally from your browser to upload and download configuration files directly to and from the disk array.

If you are using Windows, Java Web Start is automatically installed when you installed JRE 1.4.2. You should not need to install Java Web Start separately.

If you are using HP-UX, Java Web Start is **not** installed when you installed JRE/RTE 1.4.1.03 and must be installed separately. The Java Web Start file is located in the `jre` directory. To install Java Web Start 1.2, refer to the instructions in the release notes or go to [http://www.hp.com/products1/unix/java/java2/webstart/infolib/notes\\_webstart\\_1-2.html](http://www.hp.com/products1/unix/java/java2/webstart/infolib/notes_webstart_1-2.html).

## Spreadsheet Software Requirements

To edit a downloaded spreadsheet, you can use spreadsheet software or a text editor. If you use spreadsheet software, Microsoft Excel is recommended. When you open the spreadsheet file on spreadsheet software, it is important that all of the settings are displayed in the text format. You also need to be careful when you save the spreadsheet after you have edited it with spreadsheet software.

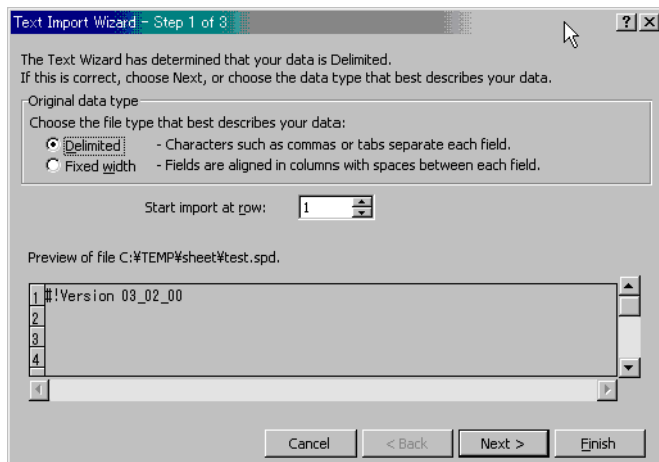
This section explains how to open a spreadsheet and save the edited spreadsheet file on the spreadsheet software using Microsoft Excel 2000.

### Opening the Spreadsheet File

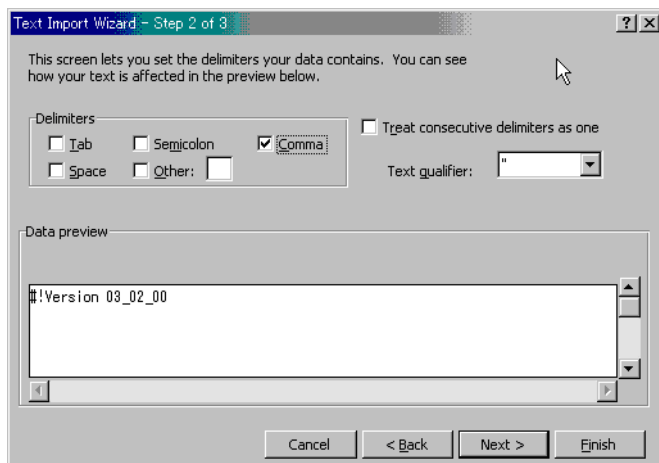
The following instructions describe how to use Microsoft Excel to open the spreadsheet file. If you use a different spreadsheet application, be sure to open the spreadsheet file and display the values in text format.

**To open the spreadsheet file on Microsoft Excel 2000:**

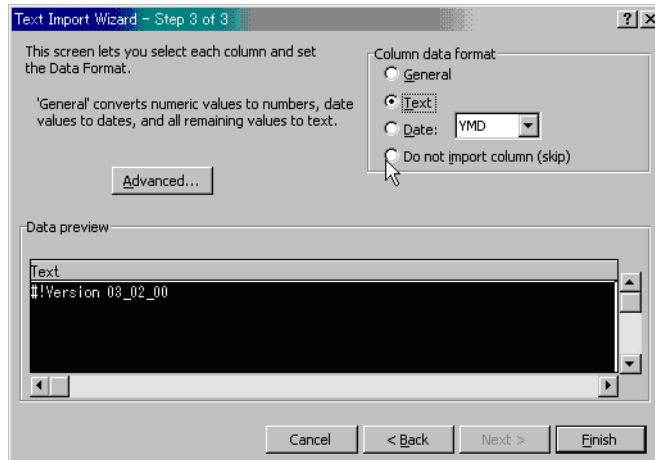
1. Start Microsoft Excel 2000.
2. From the **File** menu, click **Open**.
3. Select the spreadsheet file that you want to open and click **Open**.
4. Set the Text Import Wizard options as shown in the following figures.



**Figure 132: Text Import Wizard - Step 1 of 3**



**Figure 133: Text Import Wizard - Step 2 of 3**



**Figure 134: Text Import Wizard - Step 3 of 3**

5. Click **Finish** when you are done. The spreadsheet is opened

## Closing the Spreadsheet File


After you have edited the spreadsheet with Microsoft Excel 2000, save and close the file.

Save the spreadsheet file in the CSV (Comma Separated Value) format. If you save the spreadsheet file in Microsoft Excel format or text format, a format error occurs. Also, save the spreadsheet file using the *.spd* file extension.

To save the file in the CSV format with the *.spd* file extension, click **CSV** in the **Save as type** drop-down list of the Save As dialog box and enter the file name in the quotation marks in the **File name** field.

## Starting Configuration File Loader

To access Configuration File Loader:

1. From the Launch screen, click an XP128 or XP1024.
2. Click the **LUN and Volume Mgmt** tab, and then click the **Configuration File Loader** button (  ). The Configuration File Loader screen is displayed.

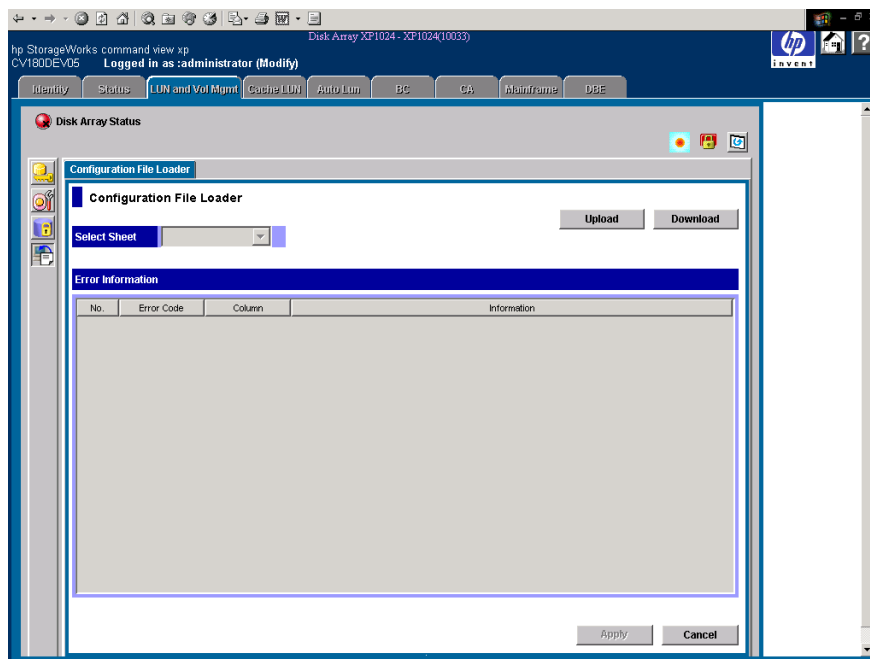


Figure 135: Configuration File Loader screen

## Configuration File Loader Screen

The components of the Configuration File Loader screen are as follows:

- **Select Sheet:** Used to select the function item to display error information in the Error Information list. An asterisk (\*) is displayed beside the function item that has the error. After you have uploaded the spreadsheet, the drop-down list becomes available. The function items are as follows:
  - Port
  - Cha

- HostGroup
- WWN
- LUN
- LDEV
- **Status:** Displays the status of uploaded spreadsheet after uploading the spreadsheet. When the spreadsheet includes some errors, **Error** is displayed. When there is no error in the spreadsheet, **Ready** is displayed. When **Ready** is displayed, the settings in the list can be applied to the disk array and therefore the **Apply** button becomes available.
- **Error Information:** Displays error information if the uploaded spreadsheet contains errors. Select the function item from the **Select Sheet** drop-down list to display the error information a particular function. The information that is displayed includes:
  - **No.:** The row number that includes the error.
  - **Error Code:** The error code.
  - **Column:** The column number that includes the error. When the error column cannot be specified, “-” is displayed.
  - **Information:** The error message.
- **Install Java Web Start button:** Displays information about the Java Web Start Download Site (for Mozilla users only).
- **Upload button:** Uploads the edited spreadsheet file. For detailed information on the procedure to upload the spreadsheet file, see [Uploading a Spreadsheet File](#) on page 365.
- **Download button:** Downloads the current spreadsheet file. For detailed information on the procedure to download the spreadsheet file, see [Downloading a Spreadsheet File](#) on page 362.
- **Apply button:** Applies the settings in the uploaded spreadsheet to the disk array. The **Apply** button becomes available only when a spreadsheet without errors is uploaded.
- **Cancel button:** Cancels the uploaded spreadsheet file and returns the Configuration File Loader screen back to the original status.

## Spreadsheet Rules and Formats

To set the configuration specified in the spreadsheet file, edit the spreadsheet according to the rules and formats indicated in this section. Following these rules and formats will prevent errors. The following figure shows an example of a spreadsheet.

Declaration											
#IVersion 03_00_01,LUN,Change											
[Port]											
#Port	Switch	AL-PA	Fabric	Connection	Speed						
1A	OFF	EF	OFF	FC-AL	Auto	1A	ON	EF	OFF	FC-AL	Auto
[CHA]											
#CHA	PCB	Mode				#CHA	PCB	Mode			
CHA-1P	HighSpeed					CHA-1P	Standard				
[HostGroup]											
#Port	Grp ID	Name	Host	Mode		#Port	Grp ID	Name	Host	Mode	
1A	00	Grp00	01			1A	00	Grp00	00		
1A	01	Grp01	00			1A	01	Grp01	01		
1A	02	Grp02	00								
[WWN]											
#Port	Grp ID	WWN	Name			#Port	Grp ID	WWN	Name		
1A	00	000000000000 0001	AA_2								
[LUN]											
#Port	Grp ID	LUN#	CU#	LDEV#		#Port	Grp ID	LUN#	CU#	LDEV#	

Current Configuration Definition (including a blank column)      New Configuration Definition (user settings)

Figure 136: Example of Spreadsheet

## Spreadsheet File Rules

The requirements and the rules for writing spreadsheet are shown in the following table. To produce a the spreadsheet file without any errors, all of the requirements must be satisfied.

**Table 30: Requirements and rules for the spreadsheet file**

Item	Requirements and Rules
File type	Text file
File name	Extension must be <i>.spd</i> . Maximum number of letters for the file name is 32 including four letters of extension. Do not use spaces in the file name. The following symbols cannot be used for the file name: \ / : , ; * ? " < >   space File path must be under 255 letters.
Maximum number of rows in a spreadsheet	70,000 rows
End-of-line character	Linefeed code must be in the end of each row.
Maximum number of letters in a row	Maximum number of letters in a row is 128 bytes including the linefeed code at the end.
Case-sensitivity	Settings are not case-sensitive. However, the exceptions are the names of WWN and host group (host storage domain). The names of WWN and host group (host storage domain) are case-sensitive.
Writing rules	Following parameters should be written in hexadecimal numbers in two digits (in one digit is also acceptable): Host group ID, host mode, LUN, CU, LDEV Tab codes and a series of spaces before or after comma are ignored.

If the error occurs with the spreadsheet file uploading operation, the following factors could be causing the problem. Review the following factors, check and revise the spreadsheet, and then try the operation again.

- The first row of the spreadsheet (the declaration row) is not correctly written. For information on the declaration row, see [Spreadsheet Declaration](#) on page 348.
- The spreadsheet file is not in the text file format (the file is a binary file).
- There is no function tag in the spreadsheet. For information on the function tag, see [Function Tag](#) on page 349.
- The file name is incorrect. For example, the extension is not *.spd* or the file name exceeds the maximum number of letters.
- The number of letters in a row exceeds 128.

- The number of rows in the spreadsheet exceeds 70,000.
- The program product that is stated in the declaration row is not installed. For information on the declaration row, see [Spreadsheet Declaration](#) on page 348.

## Spreadsheet Components

The spreadsheet consists of the following components:

- Spreadsheet Declaration (see page 348)
- Function tags (see page 349)
- Configuration Definition (Settings) (see page 350)
- Comments (see page 351)

## Spreadsheet Declaration

At the beginning of the spreadsheet, the spreadsheet declaration must be written. Some parts of the declaration have already been written in the downloaded current spreadsheet. The declaration cannot be omitted. If the declaration line is incorrect, the error occurs during the spreadsheet file uploading operation and the spreadsheet file is rejected.

The spreadsheet declaration line is not case-sensitive.

- Format (*Italics* are the variables):  
`#!Version Version number,Program Product,Process mode`
- Example:  
`#!Version 03_02_00,LUN,Change`

The components of the spreadsheet declaration are described in the following table.

**Table 31: Components of the spreadsheet declaration line**

Component	Description
#!	The symbols indicate the declaration line. They cannot be changed.
Version	The word indicates that the RMI version number follows. It cannot be changed.
(1 byte space)	One byte space is required between <i>Version</i> and the version number.
Version number	RMI version number.



**Table 31: Components of the spreadsheet declaration line**

Component	Description
, (comma)	-
Program Product	The term that indicates the program product is required. For this version of the spreadsheet, LUN, which indicates LUN Manager, should be written.
, (comma)	-
Process mode	The term that indicates the process mode is required. For this version of the spreadsheet, Change, which indicates the changing process, is only available. When the downloaded spreadsheet file is opened, the process mode is not stated yet.

## Function Tag

Each group of settings are identified by a function tag. The function tag is a string contained in brackets ( [ ] ). The types of the function tags depend on the program product (for example, the LUN Manager spreadsheet). Also, the order the function tag is displayed in a spreadsheet is set by the program product.

The following rules apply to function tags:

- A function tag must be written from the very beginning of the row. Do not add a space or some other letters before a function tag.
- If you are not changing any of the settings for a function tag, delete the function tag and all its setting from the spreadsheet. In this situation, the function tag and settings should be in the spreadsheet.
- At least one function tag is required in a spreadsheet.
- Any other comments and settings written in the same row with the function tag are ignored.

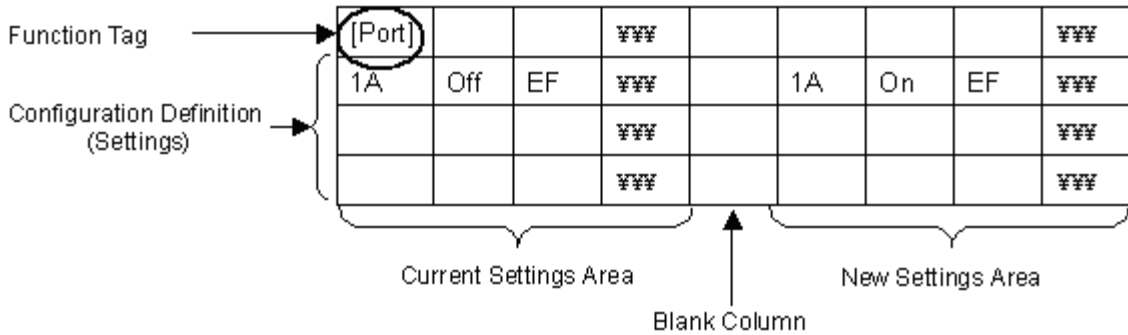
An example of the declaration and the function tag is as follows:

```
#!Version 03_00_02,LUN,Change
[Port]
[Cha]
[HostGroup]
[WWN]
[LUN]
[LDEV]
```

## Configuration Definition (Settings)

After each function tag, write the configuration definition (settings). The configuration definition sets the parameters (adding, deleting, or changing) for the disk array. A row of configuration definition can be divided into three different parts: the current settings area, a blank column, and the new settings area.

The following figure shows an example of the format of the configuration definition rows.



**Figure 137: Format of configuration definition (settings)**

When you first download the spreadsheet, the current settings area contains setting information, but the new settings area does not. The new settings area is blank, but will eventually contain information that you add.

The following rules apply:

- The current settings area and the new settings area must be the same format. The easiest way of doing this is to copy the current settings columns, paste the columns in the new settings area, and then make the changes to the settings.
- Between the current settings area and the new settings area, add a blank column.
- You must begin the new settings area in the 8th column or an error will occur when the spreadsheet is uploaded.
- The number of the available columns for each function tag depends on the number of parameters that can be set for each function. However, it also depends on the version of the spreadsheet.
- All the columns should be separated by comma.

For more information on adding, deleting, or changing settings, see [Writing the Configuration Definition](#) on page 352.

## Comments

In the spreadsheet, you can also add comment rows other than the configuration definition rows. To set a row as a comment row, write “#” at the very beginning of the row. If a space or other letters are inserted before “#”, the row is not recognized as a comment row and an error occurs. Because the comment row does not affect the settings of the spreadsheet, the comment row can consist of any character in any language. The row that includes only a linefeed code is also recognized as a comment row.

- Example:

```
#  
#Change CHA settings.  
[Cha]  
#Cha, PcbMode  
#  
#  
CHA-1P, Standard  
CHA-1Q, Standard
```

In the downloaded spreadsheet, which includes the current configuration definition, some comment rows have already been inserted. The existing comment rows are as follows:

- The next row of the function tag indicates the required setting items (Cha and PcbMode in the example) for the function. The setting items are written separately by commas.

- Example:

```
[Cha]  
#Cha, PcbMode
```

- The existing settings for the function are written. The existing settings row, which starts with “#\$”, is recognized as a comment row.

---

**Note:** The settings in the rows that start with “#\$” cannot be changed.

---

— Example:

```
[LUN]
#Port , HostGroup , LUN , CU , LDEV
#$1C , 0 , 1 , 1 , 1
```

## Writing the Configuration Definition

Use the spreadsheet to set the configuration definition. Setting the configuration definition means to add new settings, delete current settings, and change current settings. The configuration definition must be written in a specific format. The types (add, delete, change) of configuration definition and the notes on writing configuration definition are described in the following sections.

### Configuration Definition Types

The three types of configuration definition are available: adding new settings, deleting current settings and changing current settings.

- Adding new settings: To add a new setting, the current settings area of the spreadsheet should be blank. Write the new settings in the new settings area. You can add host group (host storage domain), WWN, LUN, and so on.
- Deleting current settings: To delete current settings, the new settings area should be blank. You can delete the settings for the host group, WWN, LUN, and so on.
- Changing current settings: To change existing settings, do not edit the current settings area and write the new settings in the new settings area. The format of the existing settings and the new settings must be the same.

### Configuration Definition Format

The configuration definition consists of the index and parameter parts. The index part is fixed for each function tag. Therefore, the index part must remain the same for the current settings and new settings. To modifying the settings, you can add, delete, or change the settings in the parameter parts.

[CHA]						
# CHA	PCB Mode			CHA	PCB Mode	
CHA-1P	HighSpeed			CHA-1P	Standard	
CHA-1Q	Standard			CHA-1Q	HighSpeed	

↑
↑
↑
↑

Index Part (unalterable)
Parameter Part (alterable)

**Figure 138: Index and parameter parts of a spreadsheet (example)**

When you write the configuration definition, note the following:

- The index parts are important for the settings and cannot be changed.
- In one function tag, do not write the identical index more than once.
- If there are both settings that you want to change and you do not want to change in one function tag, you need to copy and paste the current settings to the new settings area for the settings you do not want to change.

## Influences of New Settings on Other Settings

When you set the new settings in a function tag, the new settings may affect the settings of the other function tags.

For example, if you delete a host group (host storage domain) in the [HostGroup] tag, the path settings related to the deleted host group are also deleted automatically. In this case, if you write the new settings for the automatically deleted path in the [LUN] tag, an error occurs. The error occurs if you write the new settings in the [WWN] tag too.

As a general rule, the settings are applied to the disk array in the order of the settings are written in the spreadsheet, step by step, from the beginning of the sheet to the end. Therefore, the settings of the prior function tags affect the other function tags that follow.

## LUN Manager Spreadsheet

Use the LUN Manager spreadsheet to write the settings of port, CHA mode, host group (host storage domain), WWN, path definition, and command device. The format of the LUN Manager spreadsheet is as follows:

- **1st column to 6th column:** Current settings area
- **7th column:** Blank column
- **8th column to 13th column:** New settings area

The number of columns used depends on the function tag. Some function tag only requires less than six columns. In this case, the columns that are not used remain blank. The following table shows the format of the LUN Manager spreadsheet.

**Table 32: Format of LUN Manager spreadsheet**

Columns							
Function Tag	1st, 8th	2nd, 9th	3rd, 10th	4th, 11th	5th, 12th	6th, 13th	7th
[Port]	Port	Security Switch	AL-PA	Fabric	Connection	ChannelSpeed	Blank <sup>1</sup>
[Cha]	Cha	PcbMode	Blank	Blank	Blank	Blank	
[HostGroup]	Port	GroupId	GroupName	HostMode	Blank	Blank	
[WWN]	Port	GroupId	WWN	Nickname	Blank	Blank	
[LUN]	Port	GroupId	LunId	Cu	Ldev	Blank	
[LDEV]	Cu	Ldev	Cmd.Dev	Cmd.Sec	Blank	Blank	

1. When the LUN Manager spreadsheet is downloaded, the settings are written up to 7th column (blank column).

The available values of the function tags for LUN Manager spreadsheet are explained in the following sections. For detailed information on the function, the available values for LUN Manager, and the relationship between each function, please refer to [LUN Management for the XP128/XP1024](#) on page 189.

When you change the settings, you need to edit the spreadsheet according to the rules of LUN Manager settings.

## Port Settings

The [Port] tag sets the port information and the security switch (LUN security), and is available only for the changing operation. You cannot add or delete the settings with the [Port] tag definitions.

The following table shows the items and values available for the [Port] tag.

**Table 33: Available values of configuration definitions for the [Port] tag**

Column	Item	Available Value
1st, 8th (Index)	Port	One of the following can be set: 1A, 1B, 1C, 1D, 1E, 1F, 1G, 1H, 1I, 1J, 1K, 1L, 1M, 1N, 1O, 1P, 1Q, 1R, 2A, 2B, 2C, 2D, 2E, 2F, 2G, 2H, 2I, 2J, 2K, 2L, 2M, 2N, 2O, 2P, 2Q, 2R, 3A, 3B, 3C, 3D, 3E, 3F, 3G, 3H, 3I, 3J, 3K, 3L, 3M, 3N, 3O, 3P, 3Q, 3R, 4A, 4B, 4C, 4D, 4E, 4F, 4G, 4H, 4I, 4J, 4K, 4L, 4M, 4N, 4O, 4P, 4Q, 4R
2nd, 9th	Security Switch	ON or OFF
3rd, 10th	AL-PA	Set with hexadecimal numbers in two digits.
4th, 11th	Fabric	ON or OFF
5th, 12th	Connection	FCAL or PtoP
6th, 13th	ChannelSpeed	One of the following can be set: 1, 2, or Auto

When you change the settings on the port, note the following restrictions:

- **CHA PCB mode:** If the PCB mode is set to high-speed or high-speed (2 port) mode, changing the port settings is restricted. In this case, if there are settings with the [Cha] tag in the same spreadsheet, an error occurs, and the error information is displayed in the Error Information list when the spreadsheet is uploaded. If there is not a setting with the [Cha] tag in the same spreadsheet, the error occurs when the spreadsheet is uploaded and **Apply** is clicked.

---

**Note:** High-speed (2 port) mode is available only if the XP disk array has firmware version 21.06.22 or later installed.

---

- The OFF setting of the security switch (LUN security): When the security switch is OFF, changing the security settings in other function tags is restricted. However, if you change the setting of the security switch from ON to OFF, the operation is not restricted. Table 34 shows the relationship between the status of the security switch and availability of the changing operation of the settings of each function tag. If you write the settings for the unavailable item, the error occurs and the error information is displayed in the Error Information list.

**Table 34: Status of security switch and restriction on setting operation**

	Operation	Status of Security Switch			
		ON → OFF	ON → ON	OFF → ON	OFF → OFF
Host group	Adding	Yes <sup>1</sup>	Yes	Yes	No
	Changing the name	Yes	Yes	Yes	No
	Changing the host mode	Yes	Yes	Yes	No
	Changing the host mode for Group 00	Yes	Yes	Yes	Yes
	Deleting	Yes	Yes	Yes	Yes
	Deleting (settings for Group00) <sup>2</sup>	Yes	Yes	Yes	Yes
WWN	Adding	Yes	Yes	Yes	No
	Changing	Yes	Yes	Yes	No
	Deleting	Yes	Yes	Yes	Yes
LUN	Adding	Yes	Yes	Yes	No
	Changing	Yes	Yes	Yes	No
	Deleting	Yes	Yes	Yes	Yes

1. Yes: Available, No: Unavailable
2. WWN and LUN path definition under the Group 00 are deleted, host mode becomes 00, and the group name is changed to default.



## CHA Mode Settings

The [Cha] tag sets the CHA mode and is available only for the changing operation. You cannot add or delete the settings with the [Cha] tag definitions. The settings for the mainframe system are not written on the downloaded spreadsheet. The following table shows the items and values available for the [Cha] tag.

**Table 35: Available values of configuration definitions for the [Cha] tag**

Column	Item	Available Value
1st, 8th (Index)	Cha	The available values are different between the MC array and the SC array. One of the following can be set: For MC array: CHA-1P, CHA-1Q, CHA-1R, CHA-1S, CHA-2V, CHA-2W, CHA-2X, CHA-2Y For SC array: CHA-1D, CHA-1E, CHA-1G, CHA-2H, CHA-2K, CHA-2L
2nd, 9th	PcbMode	One of the following can be set: For standard mode: Standard For high-speed mode: HighSpeed For high-speed (2 port) mode: HighSpeed2
3rd - 6th, 10th - 13th	Blank	

**Note:** High-speed (2 port) mode is available only if the XP disk array has firmware version 21.06.22 or later installed.

## Host Group Settings

The [HostGroup] tag sets the host group (host storage domain) information and is available for the adding, deleting and changing operation.

When you change the settings of the host group, note the following:

- You can delete the settings for the host group 0 (zero), but the host group 0 itself cannot be deleted. If you delete all the settings for the host group 0, the settings for the host group 0 become default.
- If you delete a host group, the WWN and path definition of the deleted host group are automatically deleted. Therefore, if you write the settings for the host group that is deleted in the [LUN] tag or [WWN] tag, the error occurs.

- When you want to add or change the host group, the security switch of the related port must be ON. If the security switch is OFF, you need to set the security switch ON in the [Port] tag. However, you can change the host mode of the host group 0, even if the security switch of the port is OFF.

The following table shows the items and values available for the [HostGroup] tag.

**Table 36: Available values of configuration definitions for the [HostGroup] tag**

Column	Item	Available Value
1st, 8th (Index)	Port	One of the following can be set: 1A, 1B, 1C, 1D, 1E, 1F, 1G, 1H, 1I, 1J, 1K, 1L, 1M, 1N, 1O, 1P, 1Q, 1R, 2A, 2B, 2C, 2D, 2E, 2F, 2G, 2H, 2I, 2J, 2K, 2L, 2M, 2N, 2O, 2P, 2Q, 2R, 3A, 3B, 3C, 3D, 3E, 3F, 3G, 3H, 3I, 3J, 3K, 3L, 3M, 3N, 3O, 3P, 3Q, 3R, 4A, 4B, 4C, 4D, 4E, 4F, 4G, 4H, 4I, 4J, 4K, 4L, 4M, 4N, 4O, 4P, 4Q, 4R
2nd, 9th (Index)	GroupId	00—7F. Set with hexadecimal numbers in two digits.
3rd, 10th	GroupName	Up to eight ASCII characters (letters, numerals, and symbols). The setting is case-sensitive.
4th, 11th	HostMode	00—1F
5th, 6th, 12th, 13th	Blank	

## WWN Settings

The [WWN] tag sets the WWN information and is available for the adding, deleting and changing operation. The following table shows the items and values available for the [WWN] tag.

**Table 37: Available values of configuration definitions for the [WWN] tag**

Column	Item	Available Value
1st, 8th (Index)	Port	One of the following can be set: 1A, 1B, 1C, 1D, 1E, 1F, 1G, 1H, 1I, 1J, 1K, 1L, 1M, 1N, 1O, 1P, 1Q, 1R, 2A, 2B, 2C, 2D, 2E, 2F, 2G, 2H, 2I, 2J, 2K, 2L, 2M, 2N, 2O, 2P, 2Q, 2R, 3A, 3B, 3C, 3D, 3E, 3F, 3G, 3H, 3I, 3J, 3K, 3L, 3M, 3N, 3O, 3P, 3Q, 3R, 4A, 4B, 4C, 4D, 4E, 4F, 4G, 4H, 4I, 4J, 4K, 4L, 4M, 4N, 4O, 4P, 4Q, 4R
2nd, 9th (Index)	GroupId	00—7F. Set with hexadecimal numbers in two digits.
3rd, 10th	WWN	Set with hexadecimal numbers in 16 digits.
4th, 11th	Nickname	Up to eight ASCII characters (letters, numerals, and symbols). The setting is case-sensitive.
5th, 6th, 12th, 13th	Blank	

## Path Settings

Use the [LUN] tag to set the path definition and is available for the adding, deleting and changing operation. The following table shows the items and values available for the [LUN] tag.

**Table 38: Available values of configuration definitions for the [LUN] tag**

Column	Item	Available Value
1st, 8th (Index)	Port	One of the following can be set: 1A, 1B, 1C, 1D, 1E, 1F, 1G, 1H, 1I, 1J, 1K, 1L, 1M, 1N, 1O, 1P, 1Q, 1R, 2A, 2B, 2C, 2D, 2E, 2F, 2G, 2H, 2I, 2J, 2K, 2L, 2M, 2N, 2O, 2P, 2Q, 2R, 3A, 3B, 3C, 3D, 3E, 3F, 3G, 3H, 3I, 3J, 3K, 3L, 3M, 3N, 3O, 3P, 3Q, 3R, 4A, 4B, 4C, 4D, 4E, 4F, 4G, 4H, 4I, 4J, 4K, 4L, 4M, 4N, 4O, 4P, 4Q, 4R
2nd, 9th (Index)	GroupId	00—7F. Set with hexadecimal numbers in two digits.
3rd, 10th (Index)	LunId	00—FF. Set with hexadecimal numbers in two digits.
4th, 11th	Cu	00—1F. Set with hexadecimal numbers in two digits.
5th, 12th	Ldev	00—FF. Set with hexadecimal numbers in two digits.
6th, 13th	Blank	

## Command Device Settings

The [LDEV] tag changes the command device settings and is available only for the changing operation. You cannot add or delete the settings with the [LDEV] tag definitions. When the command device (Cmd. Dev) is OFF, and the command device security (Cmd. Sec) is ON, an error occurs. You can set the command device OFF, regardless of the existence of the LU path.

The following table shows the items and values available for the [LDEV] tag.

**Table 39: Available values of configuration definitions for the [LDEV] tag**

Column	Item	Available Value
1st, 8th (Index)	Cu	00—1F. Set with hexadecimal numbers in two digits.
2nd, 9th (Index)	ldev	00—FF. Set with hexadecimal numbers in two digits.
3rd, 10th	Cmd.Dev (Command Device)	ON or OFF
4th, 11th	Cmd.Sec (Command Device Security)	ON or OFF
5th, 6th, 12th, 13th	Blank	


## Using Configuration File Loader

Using Configuration File Loader topics also include the following:

- Downloading a spreadsheet file (see page 362)
- Editing a spreadsheet file (see page 363)
- Uploading a spreadsheet file (see page 365)

The following procedure explains the basic process for using Configuration File Loader.

### To use Configuration File Loader:

1. From the Launch screen, click an XP128 or XP1024.
2. Click the **LUN and Volume Mgmt** tab. Then click the **Configuration File Loader** button (). The Configuration File Loader screen is displayed.
3. Click **Download** to download the current spreadsheet. For downloading instructions, see [Downloading a Spreadsheet File](#) on page 362.
4. Edit the downloaded spreadsheet. For an explanation of the rules and format to follow when editing the spreadsheet, see [Spreadsheet Rules and Formats](#) on page 346. For instructions on using spreadsheet software, see [Spreadsheet Software Requirements](#) on page 341. For instructions making changes to the spreadsheet file, see [Editing a Spreadsheet File](#) on page 363.
5. Click **Upload** to upload the edited spreadsheet file. For uploading instructions, see [Uploading a Spreadsheet File](#) on page 365.
  - If the spreadsheet includes the errors, the error message is displayed or error information is listed in the Error Information list. Go to [step 6](#).
  - If the spreadsheet does not include any error, the **Apply** button becomes available. Go to [step 7](#).
6. Edit the spreadsheet to correct the errors, and then upload the corrected spreadsheet file.

If the spreadsheet still contains errors, the error message or error information is displayed again. Repeat this step to correct and upload the spreadsheet file until all the errors have been corrected. When the spreadsheet file without error is uploaded, the **Apply** button becomes available.
7. Click **Apply** to apply the settings in the spreadsheet to the disk array.

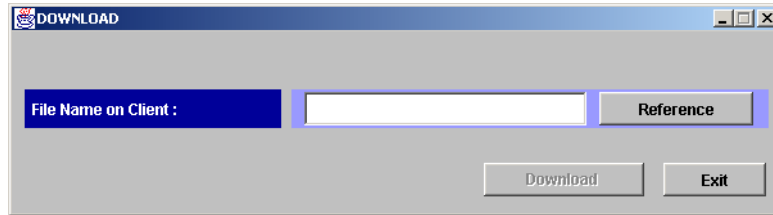
If an error occurs, the error message is displayed. Correct the spreadsheet according to the error message, upload the corrected spreadsheet, and click **Apply**. The **Apply** button will not be available until the spreadsheet without error is uploaded. If no errors are displayed, the operation is completed.

## Downloading a Spreadsheet File

As the first step of editing the spreadsheet, download the current spreadsheet file from the disk array by clicking **Download**.

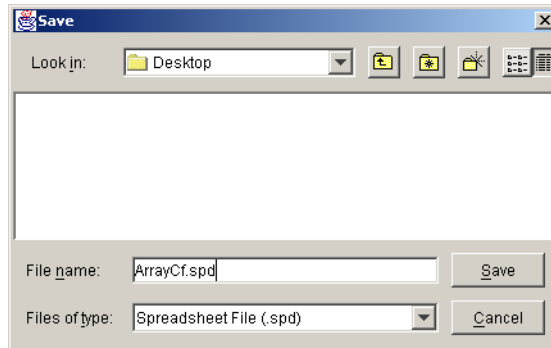
**To download the spreadsheet file:**

1. From the Configuration File Loader screen, click **Download**. The Download window is displayed.



**Figure 139: Download window**

2. From the Download window, indicate where to download the spreadsheet file by clicking **Reference** to open the Save dialog box.



**Figure 140: Specifying where to download the spreadsheet**

3. Navigate to the directory in which to save the file, and then enter the file name in the **File name** field. Be sure to use the *.spd* file extension when naming the file. For additional information on file naming rules, see [Spreadsheet File Rules](#) on page 346.
4. Click **Save**. The specified directory is displayed in the **File Name on Client** field and the **Download** button becomes available.



5. Click **Download** to download the spreadsheet file. To cancel the downloading operation, click **Exit**.

## Editing a Spreadsheet File

This section explains how to add, delete, and change settings in a downloaded spreadsheet file. These instructions assume you are using a spreadsheet application such as Microsoft Excel. When editing a spreadsheet file in a text editor, the same rules apply. The main difference is that a spreadsheet application uses the concept of columns, and in a text editor, each column is separated by a comma.

### To edit the spreadsheet file:

1. Download the spreadsheet and open the file in a spreadsheet application or text editor.
2. Edit the declaration, which is the first line, by adding the word **Change** in the third column.
3. Copy and paste columns 1 through 6 into columns 8 through 13. Be sure to leave column 7 blank.
4. Identify the settings you want to change by locating its function tags.
5. To add a new setting, insert a new row below the function tag and column heading, and add the changes to the new settings area.

#/Version		Lun		Change											
03_02_00															
[HostGroup]								[HostGroup]							
#Port	GroupId	Group Name	Host Mode					#Port	GroupId	Group Name	Host Mode				
1A	00	1A-G00	00					1A	00	1A-G00	00				
1B	00	1B-G00	00					1A	01	1A-G01	00				
								1B	00	1B-G00	00				
[WWN]								[WWN]							
#Port	GroupId	WWN	Nickname					#Port	GroupId	WWN	Nickname				
1A	00	200301300000001	WN01					1A	00	200301300000001	WN01				
1B	00	200211130000001	WN02					1B	00	200211130000001	WN02				

- To delete an existing setting, delete the settings in the new settings area. Leaving the new settings area blank resets the settings.

#/Version		Lun		Change											
03_02_00															
[HostGroup]								[HostGroup]							
#Port	GroupId	Group Name	Host Mode					#Port	GroupId	Group Name	Host Mode				
1A	00	1A-G00	00					1A	00	1A-G00	00				
1A	01	1A-G01	00					1B	00	1B-G00	00				
1B	00	1B-G00	00												
[WWN]								[WWN]							
#Port	GroupId	WWN	Nickname					#Port	GroupId	WWN	Nickname				
1A	00	200301300000001	WN01					1A	00	200301300000001	WN01				
1B	00	200211130000001	WN02					1B	00	200211130000001	WN02				

- To change a current setting, edit the setting in the new settings area. Note that certain settings cannot be changed. For example, you cannot change the ports in the [Port] tag.

#/Version		Lun		Change											
03_02_00															
[Port]								[Port]							
#Port	Security Switch	AL-PA	Fabric	Connection	ChamelSpeed			#Port	Security Switch	AL-PA	Fabric	Connection	ChamelSpeed		
1A	Off	E2	On	FCAL	2			1A	On	E2	On	FCAL	2		
1B	Off	D6	Off	PtoP	1			1B	Off	D6	Off	PtoP	1		
1C	Off	DC	On	FCAL	Auto			1C	Off	DC	On	FCAL	Auto		
1D	Off	E2	On	FCAL	Auto			1D	Off	E2	On	FCAL	Auto		
[Cha]								[Cha]							
#Cha	PcbMode							#Cha	PcbMode						
CHA-1C	Standard							CHA-1C	Standard						



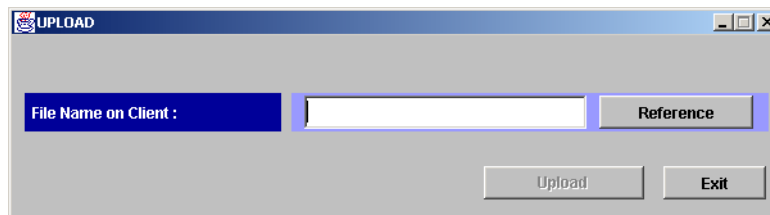
8. If you are not changing a setting, delete the entire row. If you are not changing any of the settings for an entire function tag, delete the function tag and all its settings.
9. Save the spreadsheet file when you are done making changes and upload the file using Configuration File Loader.

## Uploading a Spreadsheet File

After editing the spreadsheet, complete the following instructions to upload the spreadsheet file.

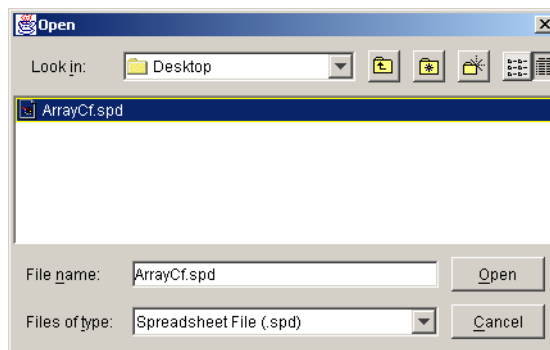
### To upload the spreadsheet file:

1. From the Configuration File Loader screen, click **Upload**. The Upload window is displayed.



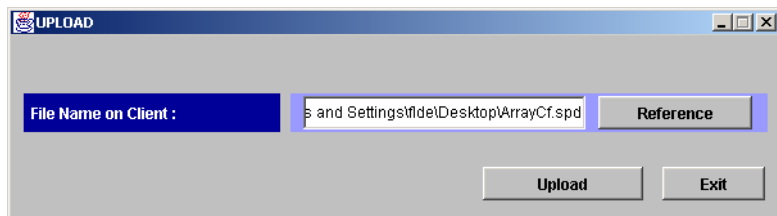
**Figure 141: Upload window**

2. From the Upload window, indicate from where to upload the spreadsheet file by clicking **Reference** to open the Open dialog box.



**Figure 142: Specifying from where to upload the spreadsheet**

3. Navigate to the directory containing the spreadsheet, and then select the file. Be sure the file uses the *.spd* file extension. For additional information on file naming rules, see [Spreadsheet File Rules](#) on page 346.
4. Click **Open**. The specified directory is displayed in the **File Name on Client** field and the **Upload** button becomes available.



5. Click **Open** to upload the spreadsheet file. To cancel the uploading operation, click **Exit**.

## Spreadsheet Error Checking

Before the configuration definition on the spreadsheet is applied to the disk array, Configuration File Loader checks the spreadsheet in three steps on the different criteria. The three different criteria are explained in the following sections.

### First Check

The first check is performed when the spreadsheet file is uploaded. Configuration File Loader mainly checks the format of the spreadsheet to verify it is formed and written in the specified way. If there is an error, the spreadsheet is rejected and the error message is displayed.

The spreadsheet is checked according to the following criteria for the first check:

- The first row of the spreadsheet (the declaration row) is not correctly written. For information on the declaration row, see [Spreadsheet Declaration](#) on page 348.
- The spreadsheet file is not in the text file format (the file is a binary file).
- There is no function tag in the spreadsheet. For information on the function tag, see [Function Tag](#) on page 349.
- The file name is incorrect. For example, the extension is not *.spd* or the file name exceeds the maximum number of letters.
- The number of letters in a row exceeds 128.
- The number of rows in the spreadsheet exceeds 70,000.
- The program product that is stated in the declaration row is not installed. For information on the declaration row, see [Spreadsheet Declaration](#) on page 348.

### Second Check

Configuration File Loader then checks the settings (configuration definitions) in the spreadsheet. The second check is performed before the **Apply** button becomes available. The information on the errors found by the second check is listed in the Error Information list. The second check consists of two kinds of the checks.

The first step is the check on the written format and the parameters. The second step is the logical check of the settings. When no error is found by the first step of the check, the check of the second step is performed. The criteria of each step is as follows:

- Check on the written format and the parameters:

If the uploaded spreadsheet corresponds with the following criteria, the error information is displayed in the Error Information list.

- An unsupported function tag is written.
- An unsuitable setting value is written or not written at all.
- The range of the setting is not correct. The correct range of the settings are as follows:

CU: 00—1F

LDEV: 00—FF

LUN: 00—FF

Group ID: 00—7F

Host Mode: 00—1F

- Logical check on the settings:

Configuration File Loader compares the current settings and the settings in the uploaded spreadsheet file, and checks the settings logically. However, the errors, which can only be found by the third check, cannot be detected.

## Third Check

The third check is performed after clicking **Apply**. The errors that cannot be detected by the first and the second check are finally detected by the third check. If the error is detected, the error message is displayed.

The spreadsheet is checked according to the following criteria for the third check:

- There is no difference between the current configuration definition and the configuration definition on the uploaded spreadsheet.

The spreadsheet is accepted anyway, but no operation is performed.

- The [Port] tag is on the spreadsheet, but the [Cha] tag is not, and the new port settings and the current PCB mode settings of the [Cha] tag do not match.

First, the port settings are processed and then the CHA settings are processed. Therefore, when the CHA settings are not stated on the spreadsheet, the error cannot be detected at the second check.

On the other hand, when the PCB mode settings of the [Cha] tag are on the spreadsheet, and the port settings are not, the PCB mode is checked with the current settings of the port. Therefore, the error is detected by the second check.

- The setting to delete LUN is defined for the port to which the I/Os are demanded.

The errors caused by other factors are detected by the second check as the logical errors of the settings. However, there could be a case that the current settings are changed even though you are on the Modify mode. In this case, the error occurs at the third check.



# Cache LUN for the XP48/XP256/XP512

## 16

HP StorageWorks Cache LUN XP is a product option that runs under HP StorageWorks Command View XP.

You can use Cache LUN to reserve areas of cache memory on the disk array for storing high-use data from the LDEVs. This capability improves data access speed because the cache-resident data is available to the hosts at much faster transfer speeds. This can be applied to both read and write I/O operations.

Cache LUN works with normal volumes, LUSE volumes, and customized (VSC) volumes.

When you use VSC volumes and Cache LUN together, you can achieve higher data access performance than when these features are used separately.

Cache LUN can perform the following tasks:

- Setting (creating) data areas (called cache extents) in cache memory (see page 379)
- Releasing (removing) data areas from cache memory (see page 381)
- Changing an extent's mode (see page 382)

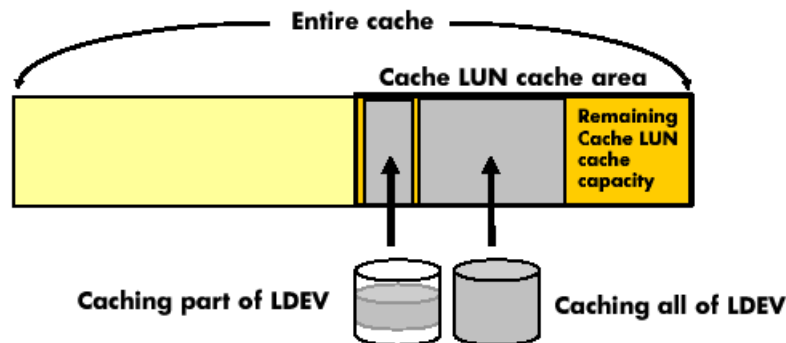


Figure 143: Cache LUN operations

Cache LUN requires a portion of cache memory, called the “Cache LUN cache area.” You can change the capacity of the Cache LUN cache area when installing or removing cache memory.

Typically, data assigned to Cache LUN becomes resident (“staged”) in cache after it is first accessed by the host. Then, the host finds the data in cache for the second and subsequent accesses.

Cache areas (also called cache extents) can be added or removed at any time. Each cache extent is defined as a range of logical blocks within an LDEV or as an entire LDEV. Logical blocks are defined by starting and ending Logical Block Addresses (LBAs).



## Supported Emulation Types and Other Parameters

### Supported emulation types

Supported emulation types are OPEN-3, OPEN-8, and OPEN-9.

### Modified volume types

LUSE (LU Size Expansion) and VSC volumes can be placed in the Cache LUN cache area.

If you want to apply Cache LUN to a LUSE volume, you must apply Cache LUN to all the LDEVs that form the LUSE volume.

### Unit of cache area allocation

A Cache LUN extent is a range of logical blocks within an LDEV. A logical block is 512 bytes.

**Table 40: Cache LUN supported emulation types and parameters (XP48/XP256/XP512)**

Parameter	OPEN-3	OPEN-8	OPEN-9
Minimum size for a Cache LUN extent	512 bytes (1 logical block)	512 bytes (1 logical block)	512 bytes (1 logical block)
Maximum size for a Cache LUN extent	2.4 GB	7.3 GB	7.3 GB
Cache LUN size increment	512 bytes (1 logical block)	512 bytes (1 logical block)	512 bytes (1 logical block)
Maximum number of Cache LUN extents	1024	1024	1024
Maximum number of Cache extents per LDEV (XP256)	16	16	16
Maximum number of Cache extents per LDEV (XP48/XP512)	1024	1024	1024

## Restrictions

### Configuration restrictions

- Do not exceed the capacity of the Cache LUN cache.
- Do not configure an Auto LUN reserved volume for Cache LUN.
- Do not place an LDEV in cache twice.
- You cannot allocate Cache LUN cache space for an on-demand LDEV.
- To apply Cache LUN to a LUSE volume, you must apply it to all the LDEVs that form the LUSE volume.

### Usage restrictions

If an LDEV is placed in cache, you must not use it for BC/CA quick restore operations or Auto LUN migration. These operations may swap the internal locations of the primary and secondary volumes and cause a loss of data integrity.

You cannot change a Cache LUN extent after it is configured. To change the specification, you must reset (“release”) the Cache LUN extent, and then re-allocate (“set”) the Cache LUN extent.

### VSC automatic resets

In the following cases, a Cache LUN cache extent is deleted (“reset” or “released”) automatically:

- If a fixed volume, part or all of which is assigned to Cache LUN, is converted into free space by the VSC Volume to Space function.
- If a custom volume, part or all of which is assigned to Cache LUN, is converted into free space using the VSC Volume to Space function.
- If an LDEV (or VDEV) containing fixed and custom volumes assigned to Cache LUN is initialized by the VSC Volume Initialize function.

## Cache LUN Modes

Cache LUN has two modes, priority mode and bind mode.

### Priority Mode

Priority mode requires fewer cache resources but has performance limitations over bind mode. Priority mode keeps all read data in cache (until you delete the extent) but all writes are destaged to disk normally (using the same algorithms as for regular, non-Cache LUN data).

- All reads following the initial read to a block will result in cache hits (100% cache read hits).
- After destaging of the write block to disk, the duplicated write areas in general cache become free.
- While destaging to disk, read requests to the same block are delayed until the disk operation is completed.
- Priority mode generates write traffic to disk, whereas bind mode does not.

In addition to the Cache LUN cache, you should set the general cache capacity according to the number of areas set in priority mode. This prevents a reduction in general cache performance.

If the general cache is overloaded (having very little cache space), it will be exhausted, often resulting in a wait for free cache space. This may degrade access to the general cache.

- If you set up to 512 areas in Cache LUN, set 512 MB x 2 (1024 MB) of standard cache.
- If you set 513-1024 areas in Cache LUN, set 1024 MB x 2 (2048 MB) of standard cache.

### Bind Mode

Bind mode keeps both read and write data in cache, eliminating disk traffic (100% read/write hits). All data stays in cache until the extent is removed. The data stored in the Cache LUN cache is duplexed for data protection, and this requires additional Cache LUN cache capacity. If there is a loss of AC power, data is maintained in cache for up to 48 hours, using battery power.

- All reads following the initial read to a block will result in cache hits.
- Duplicated write blocks are stored in cache and are never “evicted.”

- All read or write blocks stay resident in cache until the extent is deleted.
- Bind mode requires more cache because duplicated write blocks are not destaged to disk.

For RAID-5 parity groups, a Cache LUN extent in bind mode requires a cache capacity three times larger than the user data.

For RAID-1 parity groups, a Cache LUN extent in bind mode requires a cache capacity twice as large as user data.

If you want to change a RAID-1 or RAID-5 parity group's mode from priority mode to bind mode, reset and re-allocate the affected Cache LUN extent. When you re-allocate, specify the greater capacity needed for bind mode.

## Starting Cache LUN

### To start Cache LUN:

1. From the Launch screen, click an XP48, XP256, or XP512.
2. Click the **Cache LUN** tab. The Cache LUN screen is displayed.

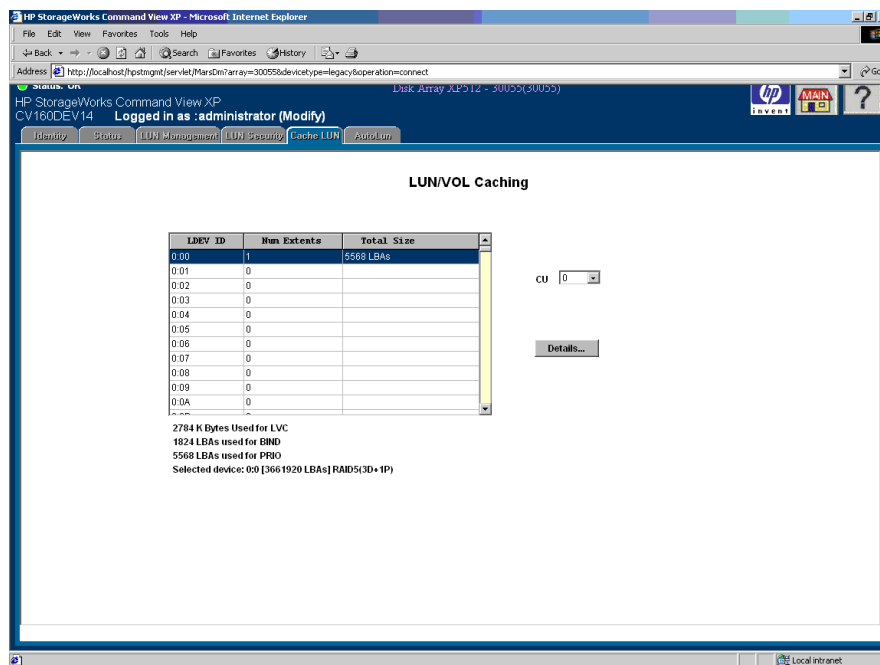


Figure 144: Cache LUN screen

## Cache LUN Screen

The Cache LUN screen consists of the following items:

- **CU:** A drop-down list where you can select the CU containing the LDEVs you want to work with.
- **List box:** The list box displays the current caching configurations of the LDEVs in the selected disk array CU. The list box displays LDEV ID, number of extents used, and the total size of cache extents.

Displayed below the list box are the bytes used for LVC, the number of LBAs used for Bind mode, the number of LBAs used Prio mode, and the selected device (CU:LDEV number, number of LBAs on the device, and RAID type of the device).

- **Details button:** Enabled when you select an LDEV from the list box. Disabled when no LDEV is selected. Clicking the button displays additional buttons on the screen. Use these buttons add and delete cache extents.

## Setting (Creating) a Cache Extent

To place data in cache:

1. From the LUN/VOL Caching screen, click a CU in the **CU** drop-down list.
2. In the list box, click an LDEV.
3. Click **Details**. The LUN/VOL Caching Define screen is displayed.

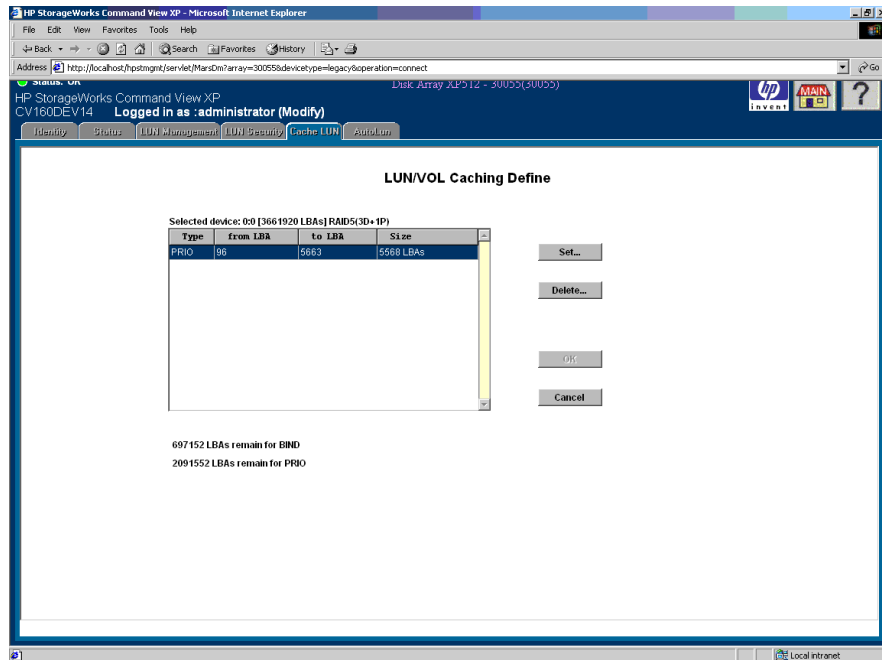


Figure 145: LUN/VOL Caching Define screen

4. Click **Set**. The buttons are replaced with a new screen containing different buttons and text fields.

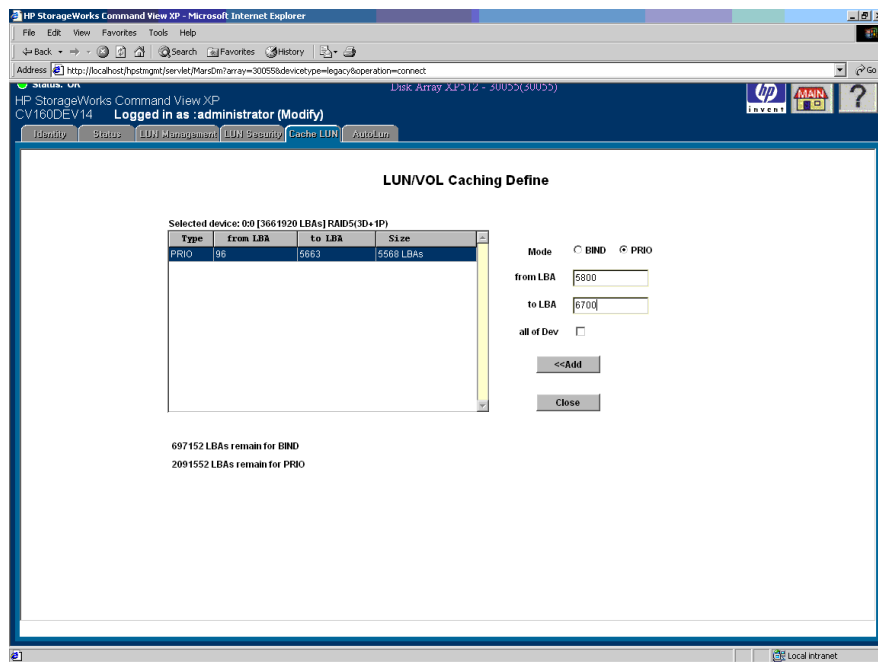


Figure 146: LUN/VOL Caching Define screen after clicking Set

5. Click a mode (**Bind** or **Prio**).
6. Enter the starting and ending LBAs. Alternately, you can select the **all of Dev** check box.
7. Click **Add**. To add more cache extents, repeat [step 5](#) - [step 7](#).
8. Click **Close**. This screen is replaced on with the original set of four buttons.
9. Click **OK**.



## Releasing (Removing) a Cache Extent

### To remove data from cache:

1. From the LUN/VOL Caching screen, click a CU in the **CU** drop-down list.
2. In the list box, click an LDEV.
3. Click **Details**. The LUN/VOL Caching Define screen is displayed.
4. Click the cache extent you want to remove.
5. Click **Delete**. The cache extent is removed from the list box. To delete more cache extents, repeat [step 4](#) - [step 5](#).
6. Click **OK**.

## Changing an Extent's Mode

You cannot directly change a cache extent's mode. You must delete the extent and reconfigure it with a new mode setting.

1. Select and release (remove) the extent in the Cache LUN cache.
2. Remake the extent with the new mode.

# Cache LUN for the XP128/XP1024



HP StorageWorks Cache LUN XP is a product option that runs under HP StorageWorks Command View XP.

You can use Cache LUN to reserve areas of cache memory on the disk array for storing high-use data from the LDEVs. This capability improves data access speed because the cache-resident data is available to the hosts at much faster transfer speeds. This can be applied to both read and write I/O operations.

Cache LUN works with normal volumes, LUSE volumes, and custom volumes (configured via VSC).

When you use custom volumes and Cache LUN together, you can achieve higher data access performance than when these features are used separately.

Cache LUN can perform the following tasks:

- Setting (creating) data areas (called cache extents) in cache memory (see page 394)
- Releasing (removing) data areas from cache memory (see page 398)
- Changing an extent's mode and pre-staging (see page 400)

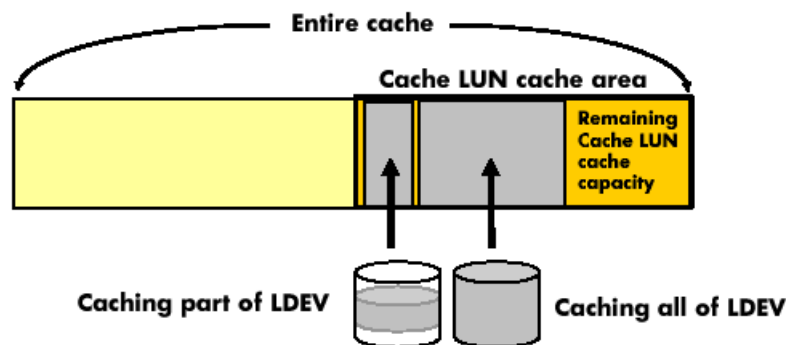


Figure 147: Cache LUN operations

Cache LUN requires a portion of cache memory, called the “Cache LUN cache area.” You can change the capacity of the Cache LUN cache area when installing or removing cache memory.

Typically, data assigned to Cache LUN becomes resident (“staged”) in cache after it is first accessed by the host. Then, the host finds the data in cache for the second and subsequent accesses.

There is also a pre-staging function. This puts data in the Cache LUN cache area when the data is first set up for caching. Pre-staging allows the host to find data in the cache at the first access.

Cache areas (also called cache extents) can be added or removed at any time. Each cache extent is defined as a range of logical blocks within an LDEV or as an entire LDEV. Logical blocks are defined by starting and ending Logical Block Addresses (LBAs).

## Supported Emulation Types and Other Parameters

### Supported emulation types

Supported open system emulation types are OPEN-3, OPEN-8, OPEN-9, OPEN-E, OPEN-K, OPEN-L, OPEN-M, and OPEN-V.

Supported mainframe emulation types are 3380-E, 3380-F, 3380-J, 3380-K, 3380-KA, 3380-KB, 3380-KC, 3390-1, 3390-2, 3390-3, 3390-3A, 3390-3B, 3390-3C, 3390-3R, 3390-6, 3390-9.

### Modified volume types

LUSE (LU Size Expansion) and VSC (Volume Size Configuration) volumes can be placed in the Cache LUN cache area.

If you want to apply Cache LUN to a LUSE volume, you must apply Cache LUN to all the LDEVs that form the LUSE volume.

### Unit of cache area allocation

A Cache LUN extent is a range of logical blocks within an LDEV. A logical block is 512 bytes.

For OPEN-V, a cache extent must have at least 128 Logical Block Addresses (LBAs), or 66 kB. For all other supported open system emulation types, a cache extent must have at least 96 Logical Block Addresses (LBAs), or 49.5 kB. This is known as a cache slot. A cache extent can have a maximum size of an entire LDEV, up to the limits of Cache LUN cache memory. Allocate data to Cache LUN with a minimum size of 128 LBAs for OPEN-V and 96 LBAs for other than OPEN-V.

For mainframe systems, a cache extent must be at least one cache slot or track (48 KB or 64 KB). Its maximum size may be an entire LDEV, up to the limits of Cache LUN cache memory. Allocate data to Cache LUN in unites of cylinders and tracks.

### Number of cache areas allowed

- In DKC: 1,024
- In LDEV: 1,024

## Restrictions

### Configuration restrictions

- Do not exceed the capacity of the Cache LUN cache.
- Do not configure an Auto LUN reserved volume for Cache LUN.
- Do not place an LDEV in cache twice.
- You cannot allocate Cache LUN cache space for an on-demand LDEV.
- To apply Cache LUN to a LUSE volume, you must apply it to all the LDEVs that form the LUSE volume.

### Usage restrictions

If an LDEV is placed in cache, you must not use it for BC/CA quick restore operations or Auto LUN migration. These operations may swap the internal locations of the primary and secondary volumes and cause a loss of data integrity.

You cannot change a Cache LUN extent after it is configured. To change the specification, you must reset (“release”) the Cache LUN extent, and then re-allocate (“set”) the Cache LUN extent.

### VSC automatic resets

In the following cases, a Cache LUN cache extent is deleted (“reset” or “released”) automatically:

- If a fixed volume, part or all of which is assigned to Cache LUN, is converted into free space by the VSC Volume to Space function.
- If a custom volume assigned to Cache LUN is converted into free space using the VSC Volume to Space function.
- If an LDEV (or VDEV) containing fixed volumes and custom volumes assigned to Cache LUN is initialized by the VSC Volume Initialize function.

## Cache LUN Modes

Cache LUN has two modes, priority mode and bind mode.

### Priority Mode

Priority mode requires fewer cache resources but has performance limitations over bind mode. Priority mode keeps all read data in cache (until you delete the extent) but all writes are destaged to disk normally (using the same algorithms as for regular, non-Cache LUN data).

- All reads following the initial read to a block will result in cache hits (100% cache read hits).
- After destaging of the write block to disk, the duplicated write areas in general cache become free.
- While destaging to disk, read requests to the same block are delayed until the disk operation is completed.
- Priority mode generates write traffic to disk, whereas bind mode does not.

In addition to the Cache LUN cache, you should set the general cache capacity according to the number of areas set in priority mode. This prevents a reduction in general cache performance.

If the general cache is overloaded (having very little cache space), it will be exhausted, often resulting in a wait for free cache space. This may degrade access to the general cache.

If you set up to 512 areas in Cache LUN, set 512 MB x 2 (1024 MB) of standard cache.

If you set 513-1024 areas in Cache LUN, set 1024 MB x 2 (2048 MB) of standard cache.

- For OPEN-V, one slot is 66 kB, which requires 4 cache segments (16.5 kB/segment). For example, 16 slots require 1,056 kB of reserved cache.
- For other than OPEN-V, one slot is 49.5 kB, which requires 3 cache segments. For example, 16 slots require 792 kB of reserved cache.

## Bind Mode

Bind mode keeps both read and write data in cache, eliminating disk traffic (100% read/write hits). All data stays in cache until the extent is removed. The data stored in the Cache LUN cache is duplexed for data protection, and this requires additional Cache LUN cache capacity. If there is a loss of AC power, data is maintained in cache for up to 48 hours, using battery power.

- All reads following the initial read to a block will result in cache hits.
- Duplicated write blocks are stored in cache and are never “evicted.”
- All read or write blocks stay resident in cache until the extent is deleted.
- Bind mode requires more cache because duplicated write blocks are not destaged to disk.

For RAID-5 parity groups, a Cache LUN extent in bind mode requires a cache capacity three times larger than the user data.

- For OPEN-V, one slot is 66 kB, which requires 12 cache segments (16.5 kB/segment). For example, 16 slots require 3,168 kB of reserved cache.
- For other than OPEN-V, one slot is 49.5 kB, which requires 9 cache segments. For example, 16 slots require 2,376 kB of reserved cache.

For RAID-1 parity groups, a Cache LUN extent in bind mode requires a cache capacity twice as large as user data.

- For OPEN-V, one slot is 66 kB, which requires 8 cache segments (16.5 kB/segment). For example, 16 slots require 2,112 kB of reserved cache.
- For other than OPEN-V, one slot is 49.5 kB, which requires 6 cache segments. For example, 16 slots require 1,584 kB of reserved cache.

If you want to change a RAID-1 or RAID-5 parity group’s mode from priority mode to bind mode, reset and re-allocate the affected Cache LUN extent. When you re-allocate, specify the greater capacity needed for bind mode.



## Pre-staging

As mentioned before, data assigned to a Cache LUN cache extent becomes resident (“staged”) in cache after it is first accessed by the host. Then, the host finds the data in cache for the second and subsequent accesses. The pre-staging function puts data in cache before the first read. Therefore, pre-staging allows the host to find data in cache on the first access.

You can specify pre-staging when you set up the cache extent. You can use this function with either priority or bind mode.

You cannot change a Cache LUN extent after it is configured. To change the specification, you must reset (“release”) the Cache LUN extent, and then re-allocate (“set”) the Cache LUN extent.

## Starting Cache LUN

The Cache LUN screen provides LDEV information, Cache LUN cache settings and Cache LUN cache information charts. In it, you can configure the Cache LUN cache.

### To start Cache LUN:

1. From the Launch screen, click an XP128 or XP1024.
2. Click the **Cache LUN** tab. The Cache LUN screen is displayed.

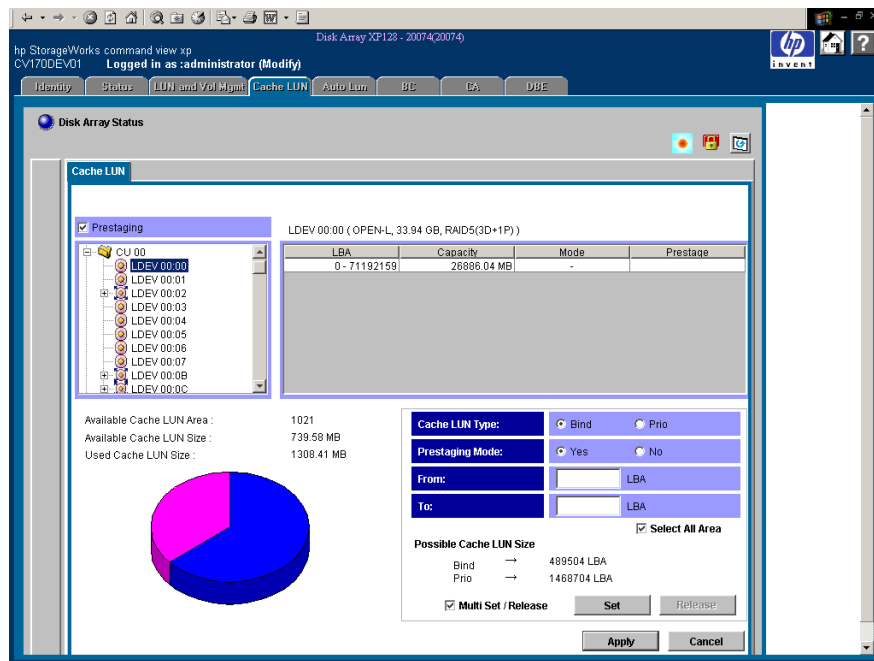


Figure 148: Cache LUN screen

## Cache LUN Screen

### Prestaging check box

Select or clear this check box to enable or disable the pre-staging function.

If you select this check box, set the Prestaging Mode to **Yes** and click **Apply**. A non-pre-staging operation will be performed and then a pre-staging operation will be performed.

If you clear this check box and then click **Apply**, a non-pre-staging operation will be performed, but a pre-staging operation will not be performed. If you select this check box later and then click **Apply**, only a pre-staging operation will be performed.

When a pre-staging operation is in progress, the text **Prestaging operation in progress** is displayed at the bottom of the Cache LUN screen. The progress is displayed in percentage.



The **Prestaging** check box is enabled in Modify mode and is selected by default. However, the **Prestaging** check box is disabled in either of the following conditions:

- There is no cache.
- The Prestaging Mode is set to **No** for each cache.

### LDEV tree

Displays the CU number (for example, CU 00) and LDEV number (for example LDEV 00) available for Cache LUN operations in a tree. The tree uses the following icons to show the settings:

**Table 41: Cache LUN icons (XP128/XP1024)**

Icon	Description
	Indicates an LDEV for which Cache LUN is not set.
	Indicates an LDEV for which Cache LUN is set.

The LDEV tree does not show Auto LUN-reserved volumes because they cannot be used in Cache LUN operations.

### LDEV table

Information about the LDEV selected in the tree is displayed on a single line in the upper-right portion of the screen. It includes LDEV number, emulation type, capacity, and RAID level.

The LDEV's capacity is displayed in MB for open systems, or cylinders and tracks for mainframe systems. The table shows the cache settings for the LDEV selected in the tree and contains the following columns:

- **LBA** (open systems only): The logical block starting and ending addresses.
- **CC HH** (mainframe systems only): The cylinder and head starting and ending addresses.

- **Capacity:** For open systems, the capacity of the cache extent in megabytes. For mainframe systems, the capacity of the cache extent in cylinders and tracks.
- **Mode:** The mode of the cache extent. “PRIO” indicates priority mode, “BIND” indicates bind mode, and “-” indicates that the LDEV is not assigned to the cache.
- **Prestage:** If this is blank, then pre-staging is not set. “ON” indicates that pre-staging is set.

### Cache LUN pie chart

The text above the pie chart lists the used cache and the amount of free space left in cache.

In the pie chart, pink indicates the amount of cache available, blue shows cache use, and yellow shows the size of the specified cache extent.

### Cache Settings area

Sets the mode and area for data that will reside in the Cache LUN cache. Also displays the settings for an existing cache extent. This area contains the following:

- **Cache LUN Type:** Select the Cache LUN mode by clicking either **Bind** or **Prio**.
- **Prestaging Mode:** The pre-staging operation will be performed if you select the **Prestaging** check box (located above the LDEV tree) and then click **Apply**. Click **Yes** if pre-staging is enabled. Click **No** if pre-staging is disabled.
- **From:** The starting address for data that will reside in the cache. This is expressed as a logical block address for open systems and as a cylinder and head address for mainframe systems.
- **To:** The ending address for data that will reside in the cache. This is expressed as a logical block address for open systems and as a cylinder and head address for mainframe systems.
- **Select All Area check box:** If you select this check box, all data areas in the selected LDEV will be set to Cache LUN cache.

This check box can be selected if no data areas in the selected LDEV are set to Cache LUN cache. This check box cannot be selected and is grayed out if some data areas in the selected LDEV are set to Cache LUN cache. If you select the **Select All Area** check box, nothing will be set to the starting address and the ending address, and the **From** and **To** fields remain empty.

- **Possible Cache LUN Size:** Displays the size you can set. “Bind” displays the size you should set for bind mode and “Prio” displays the size you should set for priority mode.
- **Multi Set / Release check box:** Selecting this check box and then clicking **Set** displays the Multi Set window, which you can use to make Cache LUN settings on more than one LDEV. Selecting this check box and then clicking **Release** displays the Multi Release window, which you can use to cancel Cache LUN settings on more than one LDEV.

Data that will reside in the Cache LUN cache is specified by the starting address in the **From** field and the ending address in the **To** field. When the **Select All Area** check box is selected, all data areas of the selected LDEVs will be set for the Cache LUN.

If you cancel the settings, all the settings specified for the LDEV will be canceled.

The **Multi Set / Release** check box does not select and cancel an individual Cache LUN data area specified for the LDEV. You must use the **Release** button to cancel an individual Cache LUN data area.

#### **Buttons**

- **Set button:** Creates a cache extent.
- **Release button:** Deletes a cache extent.
- **Apply button:** Applies the parameters to the disk array. You can then set or release other cache extents.
- **Cancel button:** Cancels the operation.

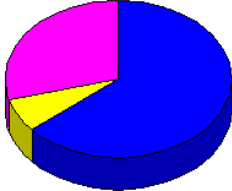
## Setting (Creating) a Cache Extent

### To place data in cache:

1. In the LDEV tree of the Cache LUN screen, click the CU:LDEV number of the LDEV you want to put in cache. The LDEV table displays Cache LUN information about the LDEV you selected.
2. Select an area to be made resident in the Cache LUN cache from one of those marked “-” in the Mode column. The **Set** button is enabled. The **From** and **To** input boxes display the selected area’s values.
3. Click **Bind** or **Prio** to indicate the mode.
4. Click **Yes** or **No** to indicate whether to set pre-staging.
5. Complete one of the following steps:
  - To place all data on an LDEV into cache, go to [step 6](#).
  - To place specific data from an LDEV into cache, go to [step 7](#).
  - To place all data on multiple LDEVs into cache, go to [step 8](#).
  - To place specific data from multiple LDEVs into cache, go to [step 9](#).
6. To place all data on an LDEV into cache:
  - a. Select the **Select All Area** check box.
  - b. Clear the **Multi Set / Release** check box.
  - c. Click **Set**. A confirmation dialog box is displayed.
  - d. Click **OK** to continue. The new settings are shown in blue on the Cache LUN main screen. To cancel operations, click **Cancel**. Go to [step 10](#).

Cache LUN configuration interface showing the Prestaging screen for LDEV 01:49 (OPEN-V, 0.04 GB, RAID5(3D+1P)).

**Available Cache LUN Area :** 1021  
**Available Cache LUN Size :** 594.95 MB  
**Used Cache LUN Size :** 1453.04 MB



LBA	Capacity	Mode	Prestage
0 - 95999	48.27 MB	BIND	ON

**Cache LUN Type:**  Bind  Prio

**Prestaging Mode:**  Yes  No

**From:**  LBA

**To:**  LBA

Select All Area

**Possible Cache LUN Size**

Bind → 393728 LBA  
Prio → 1181440 LBA

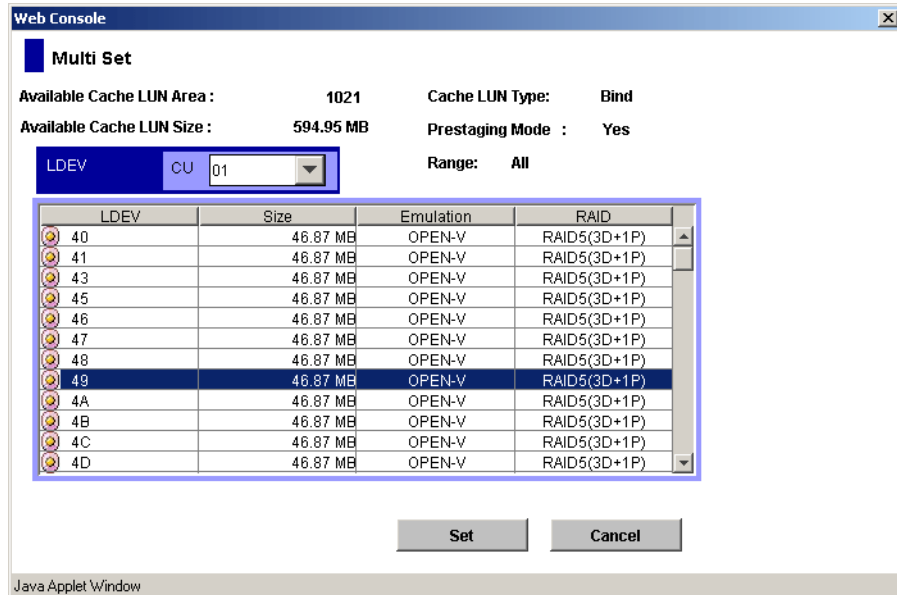
Multi Set / Release

7. To place specific data from an LDEV into cache:
  - a. If the **Select All Area** check box is grayed out, go to the next step. If the **Select All Area** check box is activated, clear the **Select All Area** check box.
  - b. Enter the starting and ending addresses (LBAs or CC HHs) of the area to be made resident in the cache.

For open systems, Cache LUN identifies a logical area in units of 128 blocks for OPEN-V, and 96 blocks for other than OPEN-V. For OPEN-V, if you have entered 1 as the starting logical block address and a value less than 128 as the ending logical block address, Cache LUN automatically changes the ending block address to 128. For other than OPEN-V, if you have entered 1 as the starting logical block address and a value less than 96 as the ending logical block address, Cache LUN automatically changes the ending block address to 96.

- c. Clear the **Multi Set / Release** check box.
- d. Click **Set**. A confirmation dialog box is displayed.
- e. Click **OK** to continue. The new settings are shown in blue on the Cache LUN main screen. To cancel operations, click **Cancel**. Go to [step 10](#).

8. To place all data on multiple LDEVs into cache:
  - a. Select the **Select All Area** check box.
  - b. Select the **Multi Set / Release** check box.
  - c. Click **Set**. A confirmation dialog box is displayed.
  - d. Click **OK** to continue. The Multi Set window is displayed.



- e. In the **CU** drop-down list, click the **CU**.
  - f. In the table, click more than one LDEV and then click **Set**. The Multi Set window closes and the new settings are shown in blue on the Cache LUN main screen. To cancel operations, click **Cancel**. Go to [step 10](#).
9. To place specific data from multiple LDEVs into cache:
    - a. If the **Select All Area** check box is grayed out, go to the next step. If the **Select All Area** check box is activated, clear the **Select All Area** check box.
    - b. Enter the starting and ending addresses (LBAs or CC HHs) of the area to be made resident in the cache.

For open systems, Cache LUN identifies a logical area in units of 128 blocks for OPEN-V, and 96 blocks for other than OPEN-V. For OPEN-V, if you have entered 1 as the starting logical block address and a value less



than 128 as the ending logical block address, Cache LUN automatically changes the ending block address to 128. For other than OPEN-V, if you have entered 1 as the starting logical block address and a value less than 96 as the ending logical block address, Cache LUN automatically changes the ending block address to 96.

- c. Select the **Multi Set / Release** check box.
  - d. Click **Set**. A confirmation dialog box is displayed.
  - e. Click **OK** to continue. The Multi Set window is displayed.
  - f. In the **CU** drop-down list, click the CU.
  - g. In the table, click more than one LDEV and then click **Set**. The Multi Set window closes and the new settings are shown in blue on the Cache LUN main screen. To cancel operations, click **Cancel**. Go to [step 10](#).
10. To make data in other volumes reside in the Cache LUN cache, repeat the previous steps.

---

**Note:** You cannot use the **Release** button to delete the set data until you click **Apply** or **Cancel**.

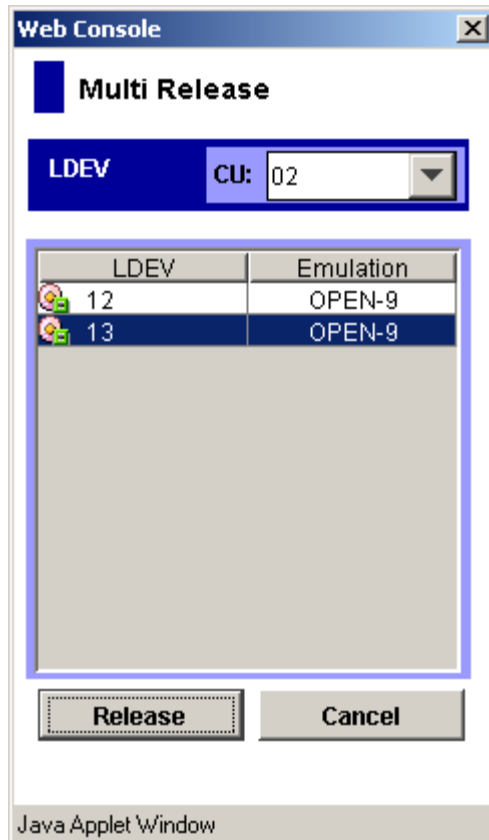
---

11. To enable the pre-staging function, select the **Prestaging** check box. To disable the pre-staging function, clear the **Prestaging** check box.
12. If the settings are correct, click **Apply**. A confirmation dialog box is displayed.
13. Click **OK** to confirm. The Cache LUN operation begins. If prestaging was selected, the prestaging operation will occur next. When the operation has been completed, a confirmation dialog box is displayed.
14. Click **OK**.

## Releasing (Removing) a Cache Extent

### To remove data from cache:

1. In the LDEV tree of the Cache LUN screen, click the CU:LDEV number of the LDEV you want to remove from cache. The LDEV table displays Cache LUN information about the LDEV you selected.
2. Select an extent to be removed from the Cache LUN cache. The **Release** button is enabled.
3. Complete one of the following steps:
  - To remove specific data from cache, go to [step 4](#).
  - To remove all data from cache, go to [step 5](#).
4. To remove specific data from cache:
  - a. Click **Release**. A confirmation dialog box is displayed.
  - b. Click **OK** to continue. The new settings are shown in blue on the Cache LUN main screen. To cancel operations, click **Cancel**. Go to [step 6](#).
5. To remove all data from cache
  - a. Select the **Multi Set / Release** check box.
  - b. Click **Release**. A confirmation dialog box is displayed.
  - c. Click **OK** to continue. The Multi Release window is displayed.



- d. In the **CU** drop-down list, click the CU.
- e. In the table, click more than one LDEV and then click **Release**. The Multi Release window closes and the new settings are shown in blue on the Cache LUN main screen. To cancel operations, click **Cancel**. Go to [step 6](#).
6. To remove cache data for another CU:LDEV, repeat the previous steps.
7. If the deletions are correct, click **Apply**. A confirmation dialog box is displayed.
8. Click **OK** to confirm. The Cache LUN operation begins. If prestaging was selected, the prestaging operation will occur next. When the operation has been completed, a confirmation dialog box is displayed.
9. Click **OK**.

## Changing an Extent's Mode and Pre-staging

You cannot directly change a cache extent's mode or pre-staging settings. You must delete the extent and reconfigure it with new settings.

1. Select and release (remove) the extent in the Cache LUN cache.
2. Remake the extent with the new mode and pre-staging settings.

# Auto LUN for the XP48/XP512

18

Use Auto LUN to optimize data storage and retrieval on the disk array. Auto LUN monitors resources in the disk array and also monitors hosts connected to the disk array. You can analyze information provided by Auto LUN to optimize the performance of your system.

You can use Auto LUN tuning operations to resolve bottlenecks of activity and optimize volume allocation.

Auto LUN enhances disk utilization and load balancing of disk arrays. Auto LUN monitors utilization of system resources, including hard disk utilization. Based on disk utilization, you can set Auto LUN to automatically migrate logical volumes from one group to another. This change is transparent to hosts.

---

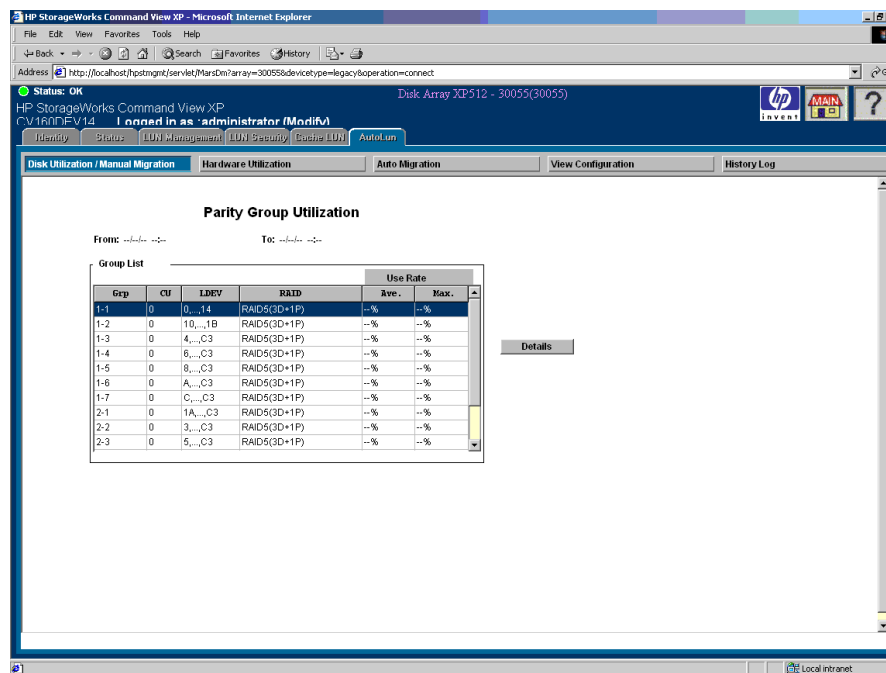
**Note:** Auto LUN is not available or supported for the XP256.

---

## Starting Auto LUN

### To start Auto LUN:

1. From the Launch screen, click an XP48 or XP512.
2. Click the **Auto LUN** tab. The Auto LUN main screen is displayed.



**Figure 149: Auto LUN main screen**

The Auto LUN main screen provides various operations to perform:

- **Monitoring:** Auto LUN monitors and shows utilization of system resources. See page 403 for more information.
- **Manual migration:** You can take full control of the Auto LUN's tuning operations with the manual migration option. See page 405 for more information.
- **Auto migration:** You can create a migration plan and define utilization values for different types of disks. Then, based on this plan, Auto LUN will move the data on logical volumes automatically whenever a particular type of disk utilization crosses its threshold limit. See page 407 for more information.

## About Monitoring

The Disk Controller (DKC) of the disk array performs the monitoring function. The monitoring function is disabled by default and should be enabled to let DKC start collecting monitoring information. The monitoring continues until it is explicitly disabled.

The monitoring information is collected from the DKC and stored on the hard disk of the SVP. When information has been stored for three months, the oldest information is overwritten by new information.

Utilization values represent the percentage of time for which the resource is active (non-idle) during the monitoring term (period). Usage is monitored and recorded in 15 minutes intervals. Each recorded value represents a data point in the monitoring term. The “Average Utilization” value is the average across all data points for the specified monitoring term. The “Maximum Utilization” value is the highest usage percentage across all data points for the specified monitoring term.

Monitor function monitors utilization of following system resources:

- Channel Processor (CHP) and Disk Processor (DKP) utilization.
- Disaster Recovery and Regeneration Processor (DRR) utilization.
- CSW-Adapter, CSW-Cache, ASM-Adaptor, and Write Pending utilization.
- Parity group utilization, Disk utilization of parity groups, and the used time of physical drives in a parity groups.
- Parity group utilization of each logical volume. The parity group utilization of each logical volume is the used time of physical drives of synchronous and asynchronous access on each logical volume, averaged by the number of physical drives in the parity group. Parity group utilization is the mean sum of utilization of each logical volume in the parity group.

The Monitoring data is shown in percentages (%). In case no monitoring data is available, “--%” will be shown for monitoring data to represent null data. The term for displaying the monitoring data will also show “--” in place of date, day etc. Other information, such as. Parity Group Id, will be shown as it is as it does not need the monitoring data to be available.

- The value “0%” is different from “--%”. 0% denotes the utilization is 0 percent while --% signifies that the information is not available.

The monitoring information is presented in the following headings throughout the Web interface:

- Disk Utilization/Manual Migration displays parity groups and logical volume utilization and performs manual migration operations.

- Hardware Utilization displays CHP, DKP, and DRR utilization; and CSW, ASM, and Write Pending utilization.
- View Configuration starts/stops monitoring and sets the time period for viewing the information.
- History Log displays the auto migration log. You can also clear the log details, when required.



## About Manual Migration

You can use the Auto LUN Manual Migration function take full control of Auto LUN tuning operations. Before performing manual migration operations, you must first collect and analyze the monitored data. After collecting the data, you must decide on the source and target volumes (that is, make migration plans). After performing manual migration operations, collect more monitor data to verify the improvements in performance. Through manual migration operations, you can fine-tune the disk array to optimize parity group, volume, and back-end processor usage (DKPs, DRRs) for your operational environment.

While auto migration operations are based only on disk usage and the hierarchy of parity groups, manual migration operations can be based on back-end processor usage (DKPs and DRRs) as well as volume and parity group usage. If Auto LUN monitoring shows high or unbalanced processor usage, you can use manual migration operations to tune the processor performance of the disk array.

The manual migration feature:

- Creates migration plans (page 405)
- Displays the migration progress status (page 406)
- Cancels manual migration plans (page 406)

## Creating Migration Plans

**To create a migration plan:**

- Analyze the Auto LUN monitoring data and select the source LDEV.
  - Analyze the DKP, DRR, and DKA information to select a DKA pair. The DKA pair is chosen if the DKA pair utilization is much higher than other DKA pairs or if the DRR/DKP average utilization is over 60%.
  - Select the parity group that has the highest utilization under the selected DKA pair.
  - Select the LDEV with the highest utilization within the selected parity group.

The Auto LUN monitoring data is displayed in the Disk Utilization and Hardware Utilization screens.

- Determine the target parity groups. The target parity groups should satisfy the following conditions:
  - The PG should not be the same PG that contains the source LDEV.

- The PG should have reserved volumes.
- The reserved volume should have the same emulation type and size as the source LDEV.
- Determine the prediction utilization data for the selected target parity groups.  
The source LDEV can be moved to any of the selected parity groups. The utilization of the each of the parity groups in the event of the source LDEV being moved to that parity group is determined. The parity group that has the lowest prediction utilization is then selected.
- Select a target LDEV.  
A reserved volume within the selected target parity group is selected.

## Viewing Migration Progress Status

You can use manual migration to create up to 36 migration plans. Only one plan can be executed at any time. The manual migration feature displays the current migration plans and the progress status of the plan currently under execution.

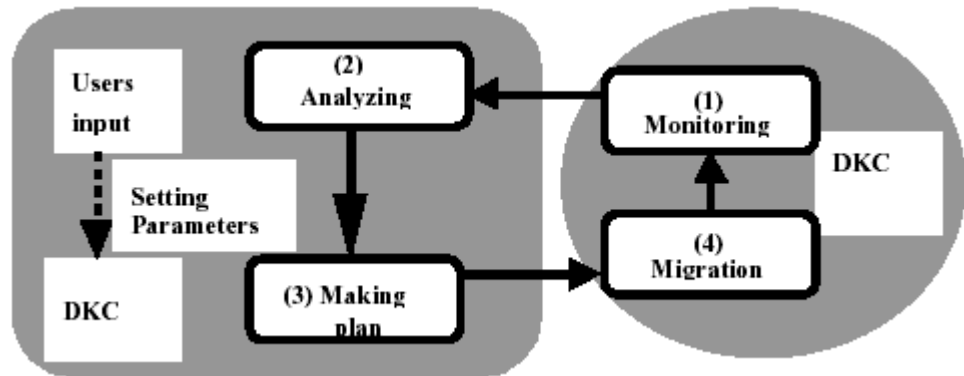
## Canceling Manual Migration Plans

You can use the manual migration feature to cancel a migration plan when the plan is in progress. A plan can be canceled any time before the completion of the migration.

Manual migration should not be done when automatic migration is enabled.

## About Auto Migration

Auto Migration function provides tuning method for the disk array based on parameters given by the users. The need for automatic migration occurs to load balance the disk array; currently this load balancing is done on the basis of “Disk Utilization.”



**Figure 150: Auto Migration function**

The complete cycle of Auto Migration function can be explained as:

1. **Monitoring** - DKC collects the utilization information about various components of the disk array. This information is displayed to the user.
2. **Analyzing** - This activity is performed by the users. They need to input the various migration parameters; these parameters are used by DKC to create the migration plan.
3. **Making Plan** - This activity is performed by DKC. Based on the monitored data and migration parameter setting, the plan is created.
4. **Migration** - The migration is performed by the DKC upon the time set by the user.

## Migration Parameters

When you create a migration plan, consider the following:

- **Maximum threshold utilization:** The disk array divides all of its volumes in logical grouping of Parity Groups. Each parity group can have only one type of disk drive. Disk drives can be classified based on their performance speed (low, medium or high). These classifications are called Classes. Class A

represents the highest performing disk drive, Class B lesser performing than Class A and so on. You can set the maximum threshold utilization for each type of class used in that particular disk array. If the monitored utilization for a volume of particular class crosses its threshold, it becomes eligible for the migration.

- **Reserved Volume:** Some of the volumes in the disk array need to be reserved as destination for the migrating volumes. A reserved volume does not have any path assigned to it. If a volume is marked for migration based on its utilization, the disk array checks for reserved volumes that should be similar to the volume whose data will be migrated. The following is needed for migration to reserved volume from source volume:
  - Both of the volumes have same emulation type.
  - Both of the volumes have same size.
  - Both of the volumes are not blockade.
  - Both of the volumes in same DKC.
- **Parity Group Attribute:** Auto migration checks LDEV utilization for all the parity groups before making the migration plan. If a parity group is set as fixed, the migration plan is made without considering LDEV utilization of fixed parity group.
- **Monitoring time:** You can specify the time frame for monitoring the utilization of volumes. This can vary from ½ hr. to 24 hrs. at any time in a particular day.
- **Migration time:** You can specify, what should be the time for migration of volumes.
- **Day selection:** You can specify to create migration plan on specific days in a month, week or daily.

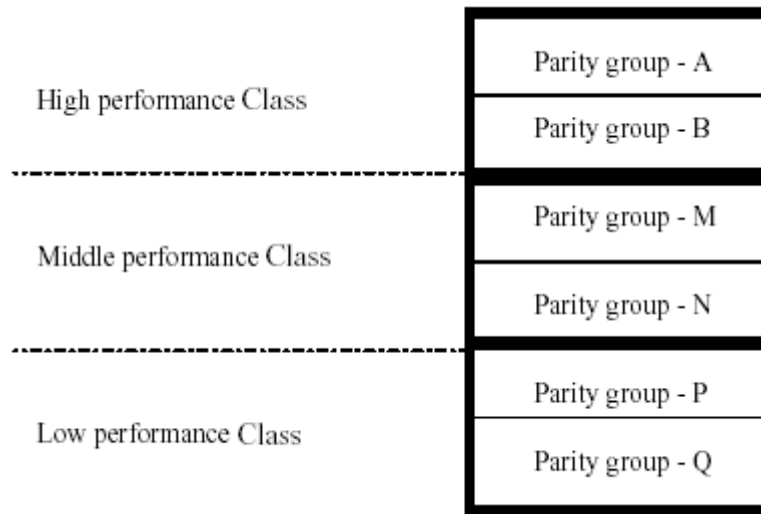
## Migration Details

An overutilized volume can be migrated if it satisfies following conditions:

- There is no PIN data in the source volume.
- The source and destination volumes have the same size.
- The volume is not blockade.
- The volume is not in the pair of volumes of HRC/HODM/HORC/HMRFC/HOMRCF.
- The volume is not Command Device.

- The volume does not have Cache LUN data stored in cache.

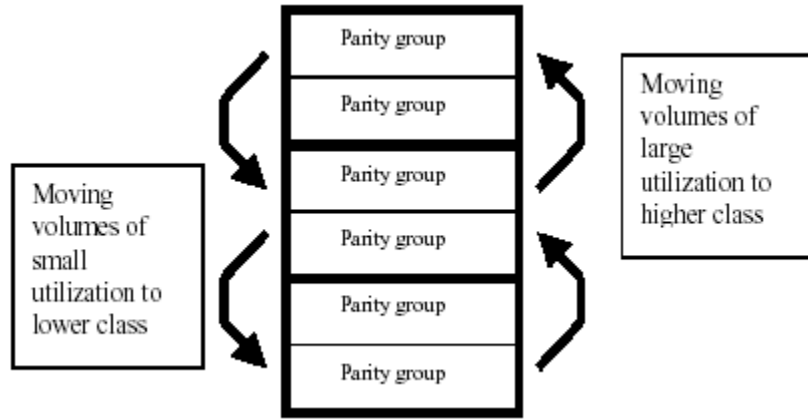
The migration of volumes takes place from one type of parity group to another based on the class to which that parity group belongs. The following is an example where six parity groups are shown, two each belonging to a particular type of class.



**Figure 151: Migration of volumes based on the parity group class**

If volumes from parity group 'P/Q' crosses the maximum threshold utilization set by the user, they will be moved to reserve volumes of parity group 'M/N' and similarly volumes from parity group 'M/N' will get moved to reserve volumes of 'A/B' parity groups. These migrations create reserve volumes back in the parity group but with better performance.

Your reserve volumes may get exhausted in the high performance class, and the need may arise to migrate volumes from the lower performance class to higher ones. The disk array automatically migrates under utilized volumes from higher performance class to lower performance class creating reserve volumes in the high performance class. If volumes of high performance class exceed their marked threshold, they will get migrated into some under utilized parity group (in same class only).



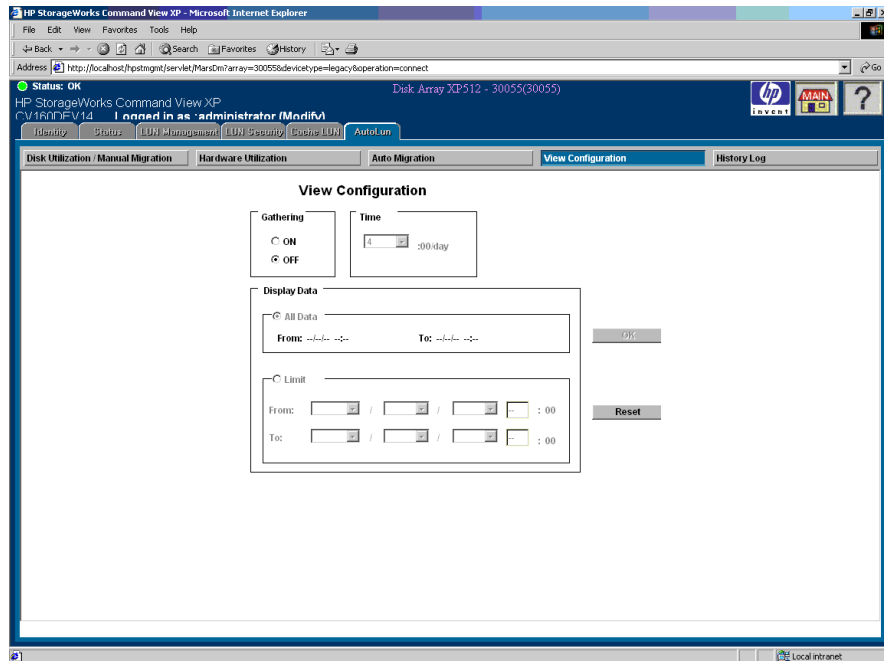
**Figure 152: Moving volumes to another class based on utilization**

## View Configuration

Use the View Configuration screen to configure the view parameters.

**To enable monitoring and configure view parameters:**

1. Click the **Auto LUN** tab.
2. Click **View Configuration**. The View Configuration screen is displayed.



**Figure 153: View Configuration screen**

3. In the Gathering area, click **ON**.
4. Click any of the choices you have in the Time and Display Data areas, and then click **OK**.

The system saves your settings, and the system begins monitoring the system resources.

## Display

The View Configuration screen consists of the following items:

- **Gathering:** Click **ON** or **OFF** to enable or disable monitoring.
- **Time:** Choose a time for the monitoring to start.
- **Display Data:** Choose whether to display all of the data available (93 days) or to define a term for displaying data.
- **Limit:** Displays a minimum From date as the date from which monitoring information is available. Similarly, the To date has the maximum date set until monitoring information is available. This prevents you from choosing dates beyond the limits.
- **OK button:** Accepts and saves the view configuration values. This button is enabled only in the following cases:
  - For modify users, if there is any change in the Gathering and/or Display data.
  - For view users, if there is any change in the Display data.
- **Reset button:** Reverts the screen back to the initial values that were present prior to making changes. The **Reset** button function is similar to Undo All.

Initially, the monitoring (gathering) is set to OFF. Before the monitoring function starts for the first time and when no monitoring information is available, the Display Data and Time components are displayed. The Display Data component shows NULL values. The Time component shows a default value.

When monitoring is turned ON for the first time, only the **Time** field becomes enabled. Simultaneously, the Display Data component becomes disabled because no monitoring information is available. Display Data becomes enabled only when monitoring information is available.



## Disk Utilization/Manual Migration

From any of the Auto LUN screens, click **Disk Utilization/Manual Migration** to display the Parity Group Utilization screen.

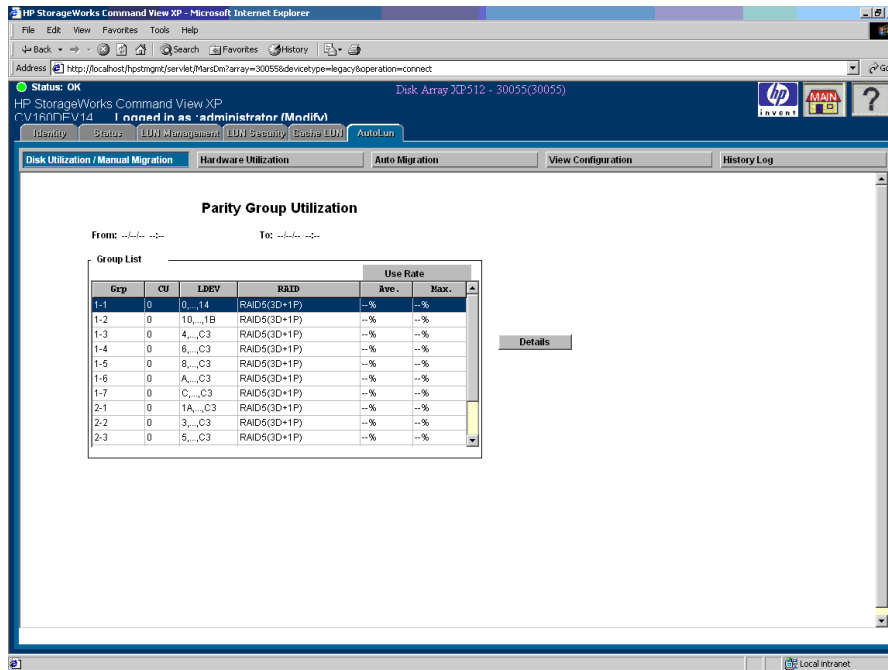


Figure 154: Parity Group Utilization screen

### Display

The Parity Group Utilization screen consists of the following items:

- **Grp**: Parity Group ID.
- **CU**: Control unit the parity group belongs to.
- **LDEV**: Logical devices the parity group contains.
- **RAID**: RAID level for the LDEV.
- **Ave**: Average utilization (%) of the parity group.
- **Max**: Maximum utilization (%) of the parity group.

- **Details button:** Enabled when a parity group is selected from the Group List area. Click this button to view detailed monitoring information about the LDEVs in the parity group.

## LDEV Utilization Screen

The LDEV Utilization screen shows utilization information about LDEVs for a particular parity group ID. This screen can also be used to start/view/stop manual migration operations.

Clicking **Details** on the Parity Group Utilization screen displays the LDEV Utilization screen.

The screenshot shows the HP StorageWorks Command View XP interface. The main window is titled "LDEV Utilization" and displays a table of LDEV utilization data for a specific parity group (1-1). The table has the following columns: CU#, Vol#, Emulation, LDEV Use (Ave., Max.), Read Rate (Rad., Seq.), Write Rate (Rad., Seq.), Group Use (Ave., Max.), and Attribute. The data shows utilization for various control units (0-19) and volumes (0, 1, 2, D, E, F, 17, 18, 19). To the right of the table are buttons for "Reserve" (Normal->Reserved, Reserved->Normal) and "Manual Migration" (Move, View/Cancel).

CU#	Vol#	Emulation	LDEV Use		Read Rate		Write Rate		Group Use(Exp.)		Attribute
			Ave.	Max.	Rad.	Seq.	Rad.	Seq.	Ave.	Max.	
0	0	OPEN-K	--%	--%	--%	--%	--%	--%	--%	--%	Normal
0	1	OPEN-K	--%	--%	--%	--%	--%	--%	--%	--%	Normal
0	2	OPEN-K	--%	--%	--%	--%	--%	--%	--%	--%	Normal
0	D	OPEN-K	--%	--%	--%	--%	--%	--%	--%	--%	Normal
0	E	OPEN-K	--%	--%	--%	--%	--%	--%	--%	--%	Normal
0	F	OPEN-K	--%	--%	--%	--%	--%	--%	--%	--%	Normal
0	17	OPEN-K	--%	--%	--%	--%	--%	--%	--%	--%	Normal
0	18	OPEN-K	--%	--%	--%	--%	--%	--%	--%	--%	Normal
0	19	OPEN-K	--%	--%	--%	--%	--%	--%	--%	--%	Normal

Figure 155: LDEV Utilization screen

## Display

The LDEV Utilization screen consists of the following items:

- **CU#:** Control unit.
- **Vol#:** Logical device.

- **Emulation:** Emulation type.
- **LDEV Use:** LDEV utilization, Average (%) and Maximum (%).
- **Read Rate:** LDEV read rate utilization, random and sequential.
- **Write Rate:** LDEV write rate utilization, random and sequential.
- **Group Use (Exp):** Expected average and maximum utilization of parity group, after the selected LDEV moves out of this parity group.
- **Attribute:** LDEV attribute, normal or reserved for auto migration.
- **Normal -> Reserved button:** Select an LDEV and click this button to convert the attribute from Normal to Reserve.
- **Reserved -> Normal button:** Select a reserved LDEV and click this button to set the attribute from Reserve to Normal.
- **Manual Migration Move button:** Displays the Manual Migration screen, used to create a migration plan for the volume selected from the Volume List area.
- **View/Cancel Migration button:** Displays the View/Stop Migration screen to view the status of the migration plans and to stop the migration, if needed.

## Manual Migration Screen

The Manual Migration screen displays utilization information for creating migration plans.

Clicking **Manual Migration Move** on the LDEV Utilization screen displays the Manual Migration screen.

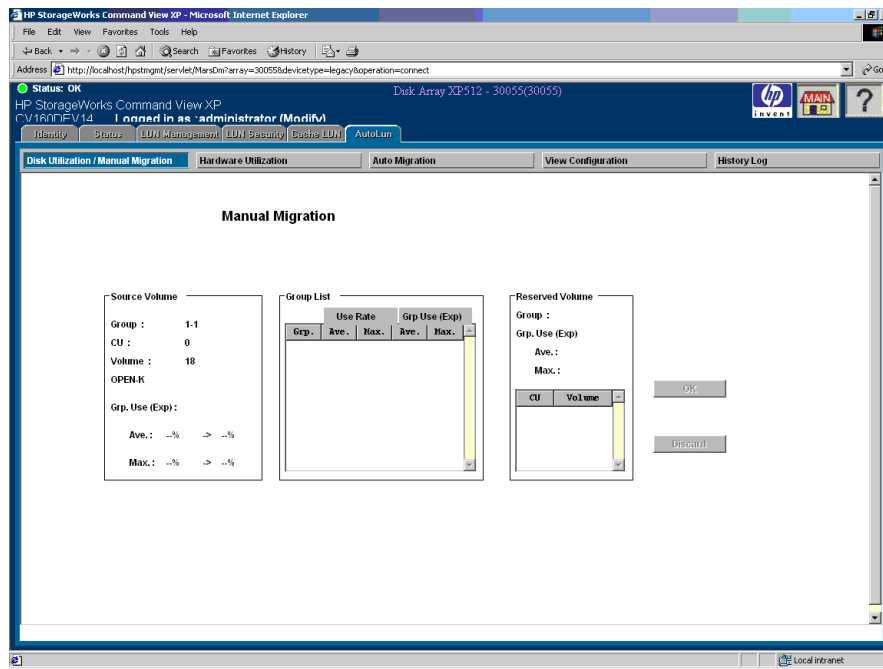


Figure 156: Manual Migration screen

## Display

The Manual Migration screen consists of the following items:

### Source Volume area

- **Group:** The parity group to which the source volume belongs.
- **CU:** The CU number of the source volume to be migrated.
- **Volume:** The LDEV of the source volume to be migrated.
- **Emulation:** The emulation type of the source parity group.
- **Grp Use (Exp.):** Average and maximum utilization of the parity group before and after the migration of the volume from this parity group.

### Group List area

Displays all the parity groups that are of the same emulation type as the source parity group.

- **Group#:** Possible target parity group.

- **Use Rate:** The current average and maximum utilization of this group.
- **Grp Use (Exp.):** The average and maximum utilization of this group if the source volume is moved to this group.

#### **Reserved Volume area**

- **Group#:** Displays the parity group selected in Group List area.
- **Grp Use (Exp.):** The average and maximum utilization of this group if the source volume is moved to this group.
- **CU#:** The CU# of the reserved volume in this parity group.
- **Volume#:** The LDEV# of the reserved volume in this parity group.

#### **Buttons**

- **OK button:** Creates the migration plan for the source volume and target volume selected. This button is enabled only for modify users.
- **Discard button:** Discards all prediction utilization values and returns the control to the Ldev Utilization screen. A different LDEV can now be selected for migration. This button is enabled only for modify users.

## **View/Stop Migration Screen**

The View/Stop Migration screen used for viewing the:

- Migration plans
- Progress status of the volume under migration

This screen is also used for stopping the migration in progress.

Clicking **View/Cancel Migration** on the LDEV Utilization screen displays the View/Stop Migration screen.

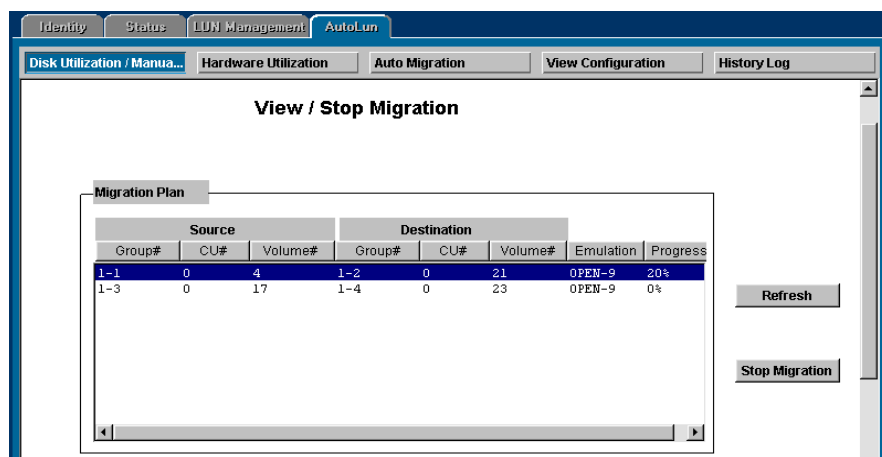


Figure 157: View/Stop Migration screen

## Display

The View/Stop Migration screen consists of the following items:

- **Migration Plan:** Displays the migration plan details.
- **Source:** The source volume to be migrated. This displays the parity group#, CU# and LDEV# of the source volume. An asterisk (“\*”) next to the Volume# specifies the volume currently under migration.
- **Destination:** The target volume to which the source volume will be migrated. This displays the parity group#, CU# and LDEV# of the target volume.
- **Emulation:** The emulation type of the parity groups.
- **Progress:** Displays the percentage of source volume migrated to the target volume for the volume currently under migration. All other plans will indicate 0%.
- **Refresh button:** Refreshes the migration progress for the volume under migration.
- **Stop Migration button:** Stops/Cancel the migration plan.

## Hardware Utilization

The Hardware Utilization screen shows CHP, DKP, DRR, and BUS monitoring information for the selected disk array.

Clicking the **Auto LUN** tab and then **Hardware Utilization** displays the Hardware Utilization screen.

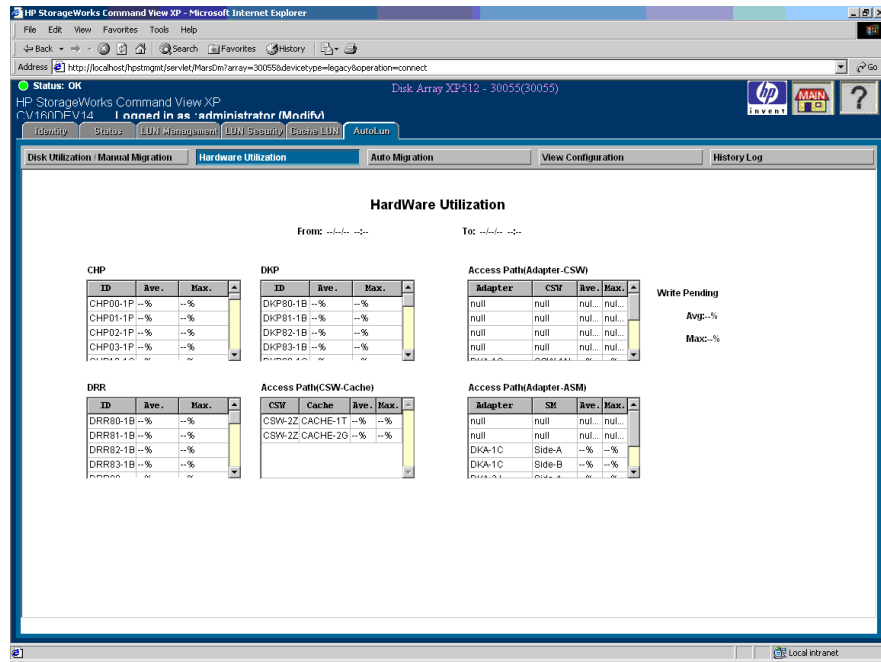


Figure 158: Hardware Utilization screen

## Display

The Hardware Utilization screen consists of the following items:

- **CHP:** CHP ID, average utilization, and maximum utilization.
- **DKP:** DKP ID, average utilization, and maximum utilization.
- **DRR:** DRR ID, average utilization, and maximum utilization.
- **Access Path CSW-Cache:** Average and maximum utilization of the path CSW-Cache.

- **Access Path Adapter-CSW:** Average and maximum utilization of the path Adapter-CSW.
- **Access Path Adapter-ASM:** Average and maximum utilization of the path Adapter-ASM.
- **Write Pending:** Average and maximum write pending rate.



## Auto Migration

Auto migration is the primary tuning method for the disk array.

Auto migration analyzes data and executes migration plans automatically, based on user-specified parameters. Use this feature to schedule the auto migration operations, select the data to be analyzed, and specify the maximum time and maximum performance impact of the auto migration operations. Auto LUN displays a detailed log of auto migration activities.

For auto migration to take place, both the **Gathering** box and the **Auto Migration Function** must be set to On.

Clicking the **Auto LUN** tab and then **Auto Migration** displays the Auto Migration screen.

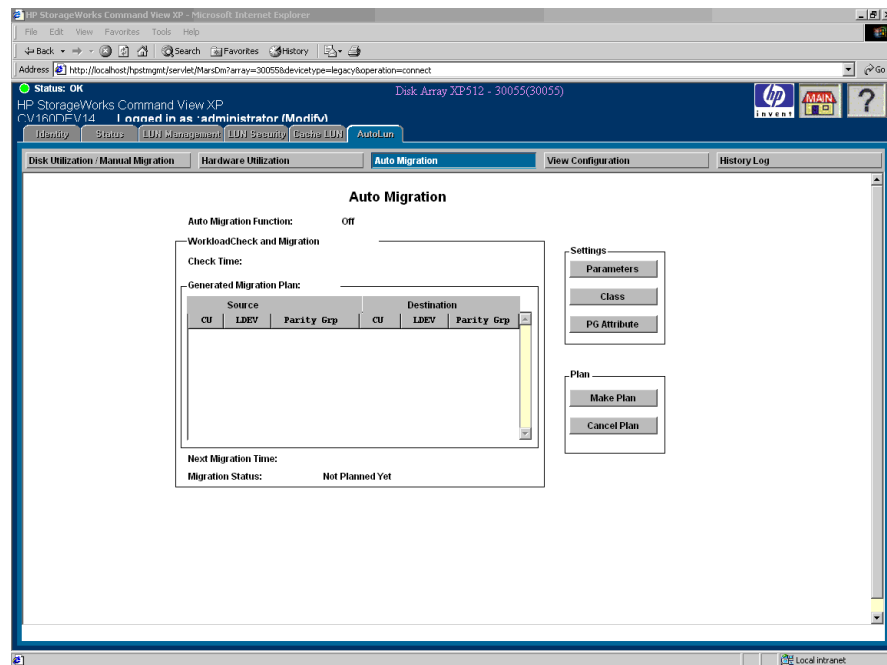


Figure 159: Auto Migration screen

## Display

The Auto Migration screen consists of the following items:

- **Auto Migration Function:** Displays whether this functionality is set to On or Off.

### Workload Check and Migration

- **Check Time:** Displays the time at which the migration plan was created.
- **Generated Migration Plan:** Details of generated migration plan, if any. It shows the source and destination volume information.
- **Next Migration Time:** Time for next migration to start.
- **Migration Status:** Status of migration plan.

### Settings buttons

- **Parameters button:** Displays the migration parameter screen. The parameters used to prepare a migration plan are entered through this screen.
- **Class button:** Displays the class details screen. The class threshold utilization is set through this screen.
- **PG Attribute button:** Displays the Parity Group attributes screen. Parity group can be set as fixed or nonfixed through this screen.

### Plan buttons

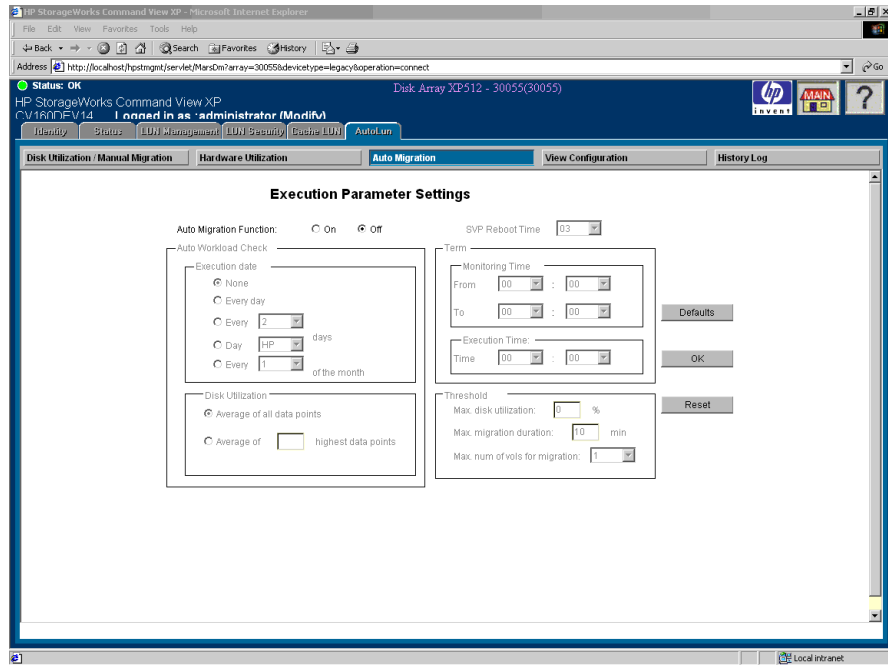
- **Make Plan button:** Performs the same action that the automatic migration function does when it attempts to make a plan.
- **Cancel Plan button:** Cancels the migration plan made on last “check time.” Canceling a plan does not mean stopping the creation of plan, to stop creation of plans auto migration status should be set to Off. After the next monitoring phase, the DKC will create the new plan, taking into account the current migration parameters. This button is enabled only for modify users.

## Execution Parameter Settings Screen

An automatic migration is attempted every day at the specified execution time regardless of whether a new migration plan exists. When a plan is made each week and the plan has more migrations than can be achieved in the maximum migration duration, any unfinished migrations will be attempted the next day at the execution time.

The Execution Parameter Settings screen displays parameters that need to be set for generating customized migration plans.

Clicking **Parameters** on the Auto Migration screen displays the Execution Parameter Settings screen.



**Figure 160: Execution Parameter Settings screen**

## Display

The Execution Parameter Settings screen consists of the following items:

- **Auto Migration Function:** Displays whether auto migration is set to ON or OFF.

### Auto Workload Check

- **Execution Date:** The date an Auto Migration plan begins. You can set this date to none, daily, every X days, on a particular day of the week or for every X day in a month. The limit values for every X day is 2 to 31 days.

- **Disk Utilization:** This parameter is used to determine the average of collected utilization information. You can derive either the average of all collected data, or the average of X highest points in collected data.

#### Term

- **Monitoring Time:** This is the time when monitoring information about LDEV and parity groups is collected. Based on the utilization information collected in this period, the migration plan is made by DKC.
- **Execution Time:** Displays the time that the migration plan was executed.

#### Threshold

- **Maximum Disk Utilization:** If the destination LDEV during migration crosses this utilization threshold, migration will terminate.
- **Maximum Migration Duration:** The Migration plan should not require more than this time. If it does, the migration stops and is attempted again at the next execution time.
- **Maximum Number of Volumes for Migration:** This is the maximum number of volumes (1 to 40) that can be migrated at one execution time.

#### Buttons

- **Defaults button:** Sets the migration parameters as default values.
- **OK button:** Sets the changed migration parameter values.
- **Reset button:** Restores the migration parameter values if changed before setting with OK.

The following table describes the default parameters and values that are set when you click **Defaults**.

**Table 42: Default migration parameters and values (XP48/XP512)**

Migration Parameter	Default Value	Meaning
Auto Migration Status	0	Auto Migration Function switch is off.
Auto Migration Planning Day	1	Every day
Auto Migration Interval Day	0	Every day
Auto Migration Day of Week	NULL	Every day
Auto Migration Monitoring From Time	05:00	Monitoring data for 5:00 a.m. to 2:00 a.m.

**Table 42: Default migration parameters and values (XP48/XP512) (Continued)**

Migration Parameter	Default Value	Meaning
Auto Migration Monitoring To Time	02:00	Monitoring data for 5:00 a.m. to 2:00 a.m.
Auto Migration Utilization Calculation	0	Average of all monitoring data
Auto Migration Utilization from Highest Points	0	Average of all monitoring data
Auto Migration Plan Execution Time	04:30	Migration time is 4:30 a.m.
Auto Migration Max Duration for Execution Plan	60	60 Minutes
Auto Migration Utilization for Destination Volume During Migration	60	60%
Auto Migration Max Volumes That Can Be Migrated During One Execution of Plan	1	1 LDEV

## Auto Migration Class Detail Screen

The Auto Migration Class Detail screen displays classes and their details.

Clicking **Class** on the Auto Migration screen displays the Auto Migration Class Detail screen.

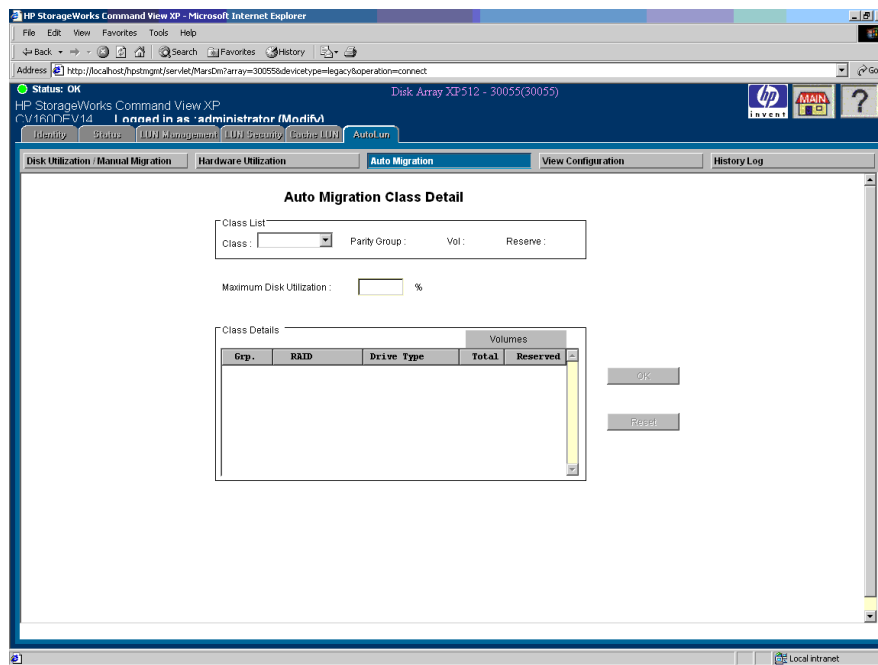


Figure 161: Auto Migration Class Detail screen

## Display

The Auto Migration Class Detail screen consists of the following items:

### Class List area

- **Class:** The classification type for class, for example, A, B, and so forth. It is followed by a summary of class details, for example, the number of parity groups it has, total number of volumes, and how many volumes are reserved.
- **Maximum Disk Utilization:** The threshold utilization for selected class type. When the utilization during the monitoring term exceeds this threshold, it becomes eligible for migration.

### Class Details area

- **Grp:** Shows parity group name.
- **RAID:** RAID type of particular parity group.
- **Drive Type:** Hardware display name for drive type.

- **Total:** Total number of LDEV in a particular parity group.
- **Reserved:** Total number of reserved volumes in a particular parity group.

#### Buttons

- **OK button:** Sets the maximum utilization for the selected class. The page becomes inactive to user input until the result of changing threshold is displayed.
- **Reset button:** Restores the maximum threshold value for the selected class if changed before set.

## Fix Parity Group Attributes Screen

The following figure shows the Fix Parity Group Attributes screen with parity group attributes as fixed or nonfixed.

Clicking **PG Attribute** on the Auto Migration screen displays the Fix Parity Group Attributes screen.

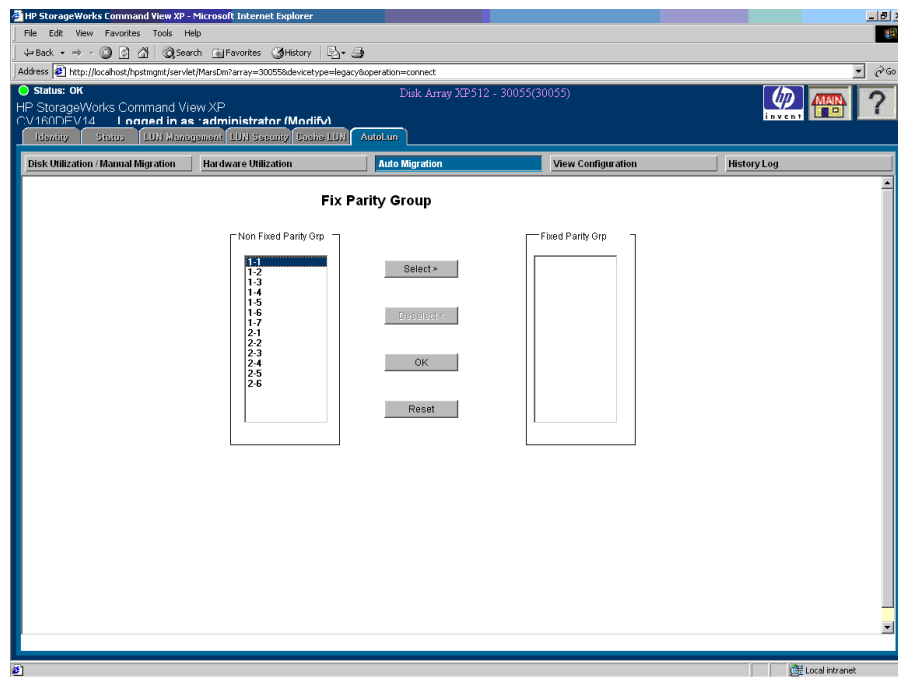


Figure 162: Fix Parity Group Attributes screen

The LDEV of a fixed parity group is not taken into consideration while making the migration plan. For example, the LDEV cannot be migrated through Auto Migration. The LDEV of a nonfixed parity group can be migrated only through a migration plan.

## Display

The Fix Parity Group Attributes screen consists of the following items:

- **Non-Fixed Parity Group:** Select a fixed parity group from the list.
- **Fixed Parity Group:** Select a fixed parity group from the list.
- **Select button:** Moves parity groups from fixed group to nonfixed group.
- **Deselect button:** Restores the maximum threshold value for the selected class if changed before set.
- **OK button:** Sets the changes done to parity groups. The screen becomes inactive to user input until the result of changing parity group attribute is displayed.
- **Reset button:** Restores the fixed and nonfixed group values, if changed before performing the set operation.

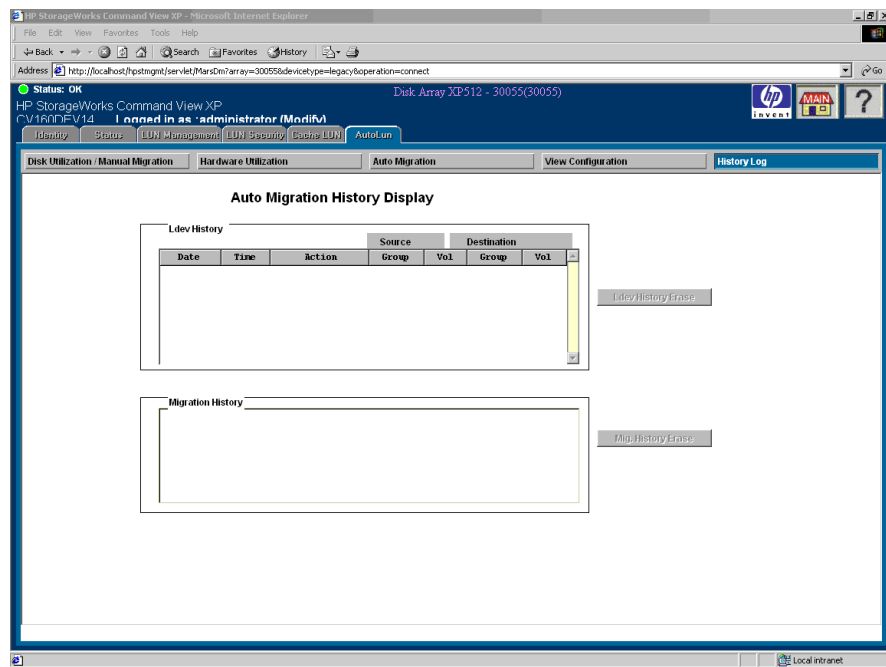


## History Log

The disk array provides two types of history logs by which you can view migration activities:

- LDEV migration history displays the source and destination LDEV details.
- Migration history shows the activities relating to creating migration plans, changing migration parameters, success/failure in executing migration plans, etc.

Clicking the **Auto LUN** tab and then **History Log** displays the Auto Migration History Display screen.



**Figure 163: Auto Migration History Display screen**

## Display

The Auto Migration History Display screen consists of the following items:

### **Ldev History area**

- **Source and Destination button:** Shows the date, time, and other details of the LDEV history.
- **Ldev History Erase button:** Erases the LDEV history that is displayed.

### **Migration History area**

You can view the following types of migration activities:

- **Auto Migration Process**
  - Success/failure during setting migration parameters
  - Creation and execution of migration plans
  - Status of migration plan execution
- **Volume Migration:** This LDEV auto migration history contains the information about the source and destination volumes used during auto migration.
- **Migration History Erase button:** Erases the migration history that is displayed.

To refresh the history display, go to the Disk Utilization screen and click **Refresh**, as there is no refresh operation for history.

# Auto LUN for the XP128/XP1024

19

Use Auto LUN to optimize data storage and retrieval on the disk array. Auto LUN monitors resources in the disk array and also monitors hosts connected to the disk array. You can analyze information provided by Auto LUN to optimize the performance of your system.

Auto LUN works with both open system and mainframe volumes. You can use Auto LUN tuning operations to resolve bottlenecks of activity and optimize volume allocation.

When you have a migration plan (a set of detailed user-specified parameters) in place, Auto LUN automatically migrates logical volumes in the disk array.

Auto LUN operations are completely non-disruptive. The data being migrated remains online to all hosts for read and write I/O operations throughout the entire volume migration process.

Auto LUN also supports manual volume migration operations and estimates performance improvements prior to migration.

You begin by obtaining usage statistics about physical hard disk drives, logical volumes, processors and other resources in the disk array. Then, using manual or automatic migration, Auto LUN balances the workload among hard disk drives, logical volumes and processors in order to improve system performance.

## Auto LUN Statistics

Auto LUN monitors your disk array for you. Auto LUN obtains usage statistics about resources such as front-end and back-end processors, hard disk drives, and logical volumes every 15 minutes. The statistics are automatically collected by the disk array twice a day (once in the morning and once in the afternoon).

Auto LUN displays statistics collected for the last three months. Statistics over three months old are discarded.

If you specify a certain period of time, you will be able to view a graph that illustrates how the usage rate changes within the specified period. You will also be able to view the average and the maximum usage rates.

You can analyze information displayed on the screen and identify the overloaded resources. If necessary, you should take load-balancing measures to improve the performance of your system.

Auto LUN displays the following types of information:

- **Usage statistics about parity groups.** If Auto LUN data shows overall high parity group usage, you should consider installing additional HDDs and using Auto LUN to migrate the high-usage volumes to the new parity groups. If the monitor data shows that parity group usage is not balanced, you can use Auto LUN to migrate volumes from high-usage parity groups to low-usage parity groups.
- **Usage statistics about logical volumes.** Auto LUN displays the average and maximum usage, including sequential and random access, of each LDEV in a parity group. The logical volume usage is the time in use (sequential and random access) of the physical drives of each LDEV, averaged by the number of physical drives in the parity group.

If the Auto LUN data shows overall high logical volume usage, you should consider installing additional hardware (for example HDDs, DKAs, cache). If the monitor data shows that volume usage is not balanced, you can use Auto LUN to migrate high-usage volumes to higher HDD classes and/or to lower-usage parity groups. You can also use the logical volume usage data to analyze the access characteristics of volumes and determine the appropriate RAID level and/or HDD type for the volumes.

- **Usage statistics about channel adapters and channel processors.** A channel adapter (CHA) processes host commands and controls data transfer between hosts and the cache. A channel adapter contains multiple channel processors (CHPs), which process host commands and control data transfer.

If the Auto LUN data shows overall high CHA usage, you should consider installing additional CHAs. If the data shows that CHP usage is not balanced, you should consider moving some devices that are defined on overloaded ports to ports with lower-usage CHPs to balance front-end usage.

- **Usage statistics about disk adapters and disk processors.** A disk adapter (DKA) controls data transfer between the cache and the disk devices. A disk adapter contains multiple disk processors (DKPs), which controls data transfer.

If Auto LUN data shows overall high DKP usage, you should consider installing additional HDDs and/or DKAs, and then using Auto LUN to migrate the high-write-usage volumes (especially sequential writes) to the

new parity groups. If the data shows that DKP usage is not balanced, you can use Auto LUN to migrate logical volumes from high-usage parity groups to low-usage parity groups.

Auto LUN cannot estimate DKP usage. Use Auto LUN migration only for obvious cases of high or unbalanced DKP usage. Auto LUN migration may not provide any performance improvement for cases in which DKP usage values vary only slightly, or for cases in which overall DRR usage values are relatively high.

- **Usage statistics about disaster recovery and regeneration processors.** A disaster recovery and regeneration processor (DRR) is a microprocessor (located on the DKAs), which is used to generate parity data for RAID-5 parity groups. The DRR uses “old data + new data + old parity” to generate new parity.

If Auto LUN data shows overall high DRR usage, this can indicate a high write penalty. Please consult your HP representative about high write penalty conditions. If the monitor data shows that DRR usage is not balanced, you should consider relocating volumes using Auto LUN to balance DRR usage within the disk array.

- **Write pending rate.** The write pending rate indicates the ratio of write-pending data to the cache memory capacity. The Auto LUN screen displays the average and the maximum write pending rate for the specified period of time. The screen also displays a graph that indicates how the write pending rate changes within that period.
- **Usage statistics about access paths.** An access path is a path through which data and commands are transferred within a disk array.

In a disk array, channel adapters control data transfer between hosts and the cache memory. Also, disk adapters control data transfer between the cache memory and disk drives. Data transfer does not occur between channel adapters and disk adapters. Data is transferred via the cache switch (CSW) to the cache memory.

When hosts issue commands, the commands are transferred via channel adapters to the shared memory (SM). Disk adapters check the content of the shared memory.

Auto LUN monitors and displays the usage rate for the following access paths:

- Paths between channel adapters and the cache switch
- Paths between disk adapters and the cache switch

- Paths between the cache switch and the cache memory
- Paths between channel adapters and the shared memory
- Paths between disk adapters and the shared memory

- **Statistics about logical devices.** Auto LUN displays statistics about logical devices. For example, you can check whether I/O operations converge on particular logical volumes. You can also check how much data is read from logical volumes into the cache memory.

Auto LUN displays the following information:

- The number of read requests and write requests that have been made to logical devices (or parity groups)
- The number of data transfers that have been occurred between logical devices (or parity groups) and the cache memory
- The size of data transferred to logical devices (or parity groups)
- The read hit rate
- The write hit rate

For a read I/O, when the requested data is already in cache, the operation is classified as a read hit. For example, if ten read requests have been made from hosts to devices in a time period and the read data was already in cache memory in three times out of ten, the read hit rate for that time period is 30 percent. Higher read hit rates imply higher processing speed because fewer data transfers are made between devices and the cache memory.

For a write I/O, when the requested data is already in cache, the operation is classified as a write hit. For example, if ten write requests were made from hosts to devices in a time period and the write data was already on the cache memory in three cases out of ten, the write hit rate for that time period is 30 percent. Higher write hit rates imply higher processing speed because fewer data transfers are made between devices and the cache memory.

- **Statistics about traffic at ports.** Auto LUN monitors host ports and disk array ports to obtain statistics about I/O rates and transfer rates at these ports. If you analyze these I/O rates and transfer rates, you will be able to find out which host issues many I/O requests to the disk and to find out which host transfers a lot of data to the disk.

- **Statistics about traffic at LU paths.** Auto LUN monitors LU paths to obtain statistics about I/O rates and transfer rates at these LU paths. If you analyze these I/O rates and transfer rates, you will be able to detect LU paths through which many of the I/O requests are made to the disk, and to detect LU paths through which many of data are transferred to the disk.

## Auto LUN Uses

- **Load balancing disk array resources to improve performance.** Balancing resource utilization can significantly improve the disk array performance. The data provided by Auto LUN can optimize several areas of performance, including front-end and back-end processor usage and the allocation of logical volumes to physical disk drives and RAID level.
- **Optimizing disk drive access patterns.** Auto LUN collects and analyzes information about disk drive access patterns and can migrate volumes to optimize host access to the data. For example, RAID-1 technology may provide better performance than RAID-5 under certain conditions, and one disk drive type may provide better performance than another for certain types of access. The Auto LUN feature fine-tunes the logical volume allocation.
- **Graphical analysis of disk array usage.** Auto LUN displays performance data graphically to highlight peaks and trends. You can identify bottlenecks of activity.
- **Better utilization of RAID levels and HDD types.** The XP128/XP1024 supports both RAID-1 and RAID-5 technologies as well as an inter mix of RAID-1 and RAID-5 parity groups. The XP128/XP1024 also supports several types of hard disk drives (HDDs) and allows an intermix of HDD types within each disk array domain to provide maximum flexibility in configuration. Auto LUN operations take into account the RAID level and physical HDD performance of each parity group, enabling reallocation of logical volumes and optimization with respect to both RAID level and HDD type. The proper combination of RAID level and HDD type for the logical volumes can significantly improve disk array performance for the user's environment.

## Reserve Volumes

The reserve volume function reserves target volumes for automatic and manual migration operations. After you have reserved a number of target volumes, Auto LUN maintains this number of reserved volumes by swapping the reserve attribute after each migration operation (following the migration operation, the original source volume becomes a reserved volume).

## Volume Migration

Auto LUN volume migration operation consists of two steps:

- Copy the data on the Auto LUN source volume to the Auto LUN target volume.
- Transfer host access to the target volume to complete the migration.

The Auto LUN source volume can be online to hosts during migration. The target volume is reserved prior to migration to prevent host access during migration. The source and target volumes can be located anywhere in the disk array.

The Auto LUN copy operation copies the entire contents of the source volume to the target volume. If the source volume is updated by write I/Os during the copy operation, the XP128/XP1024 keeps track of the updates on a cylinder map and performs additional copy operations after the initial copy is complete to duplicate the updates at the target volume.

When the volumes are fully synchronized (no differential data on source volume), the XP128/XP1024 completes the migration by swapping the reserve attribute (target becomes normal and source becomes reserved) and redirecting host access to the target volume. Auto LUN performs all migration operations sequentially (one volume migration at a time).

Typical copy times for open system volumes (with no other I/O activity) are: OPEN-K/3 = 1.1/1.5 minutes, OPEN-8/9 = 4.5 minutes, OPEN-E = 9 minutes, and OPEN-V = variable.

For automatic and manual migration operations, Auto LUN checks the current write pending rate and cancels a migration if the write pending rate is higher than 60%. For auto migration, Auto LUN also checks the current disk utilization of the source volumes and source and target parity groups, and cancels the auto migration operation if current disk utilization is higher than the user-specified maximum disk utilization for auto migration.

## Estimating Usage Rates

The estimate function calculates the expected usage of the source and target parity groups after a proposed volume migration. The estimate function uses the subsystem usage data collected by the monitor function in addition to the HDD performance characteristics and RAID level to estimate expected usage rates. Both the auto migration and manual migration functions use these estimated values to verify proposed migrations.



Auto LUN automatically estimates the expected usage rates for the source and target parity groups for each proposed migration operation. The estimate function calculates the expected results of a proposed volume migration based on the RAID450 monitor data collected during the user-specified monitor data term. The Auto LUN estimate function takes the RAID level and HDD type into account when estimating expected usage rates (RAID-1 and RAID-5 have different access characteristics).

The Auto LUN estimate function is a critical component of the auto migration function. The estimate function calculates the expected parity group usage for both the source and target parity groups, and the auto migration function uses these estimated values to verify proposed migrations. If any condition prevents Auto LUN from estimating an expected usage rate (for example invalid monitor data), the auto migration function will not schedule the migration operation.

For manual migration operations, when you select the source volume for a manual migration, Auto LUN displays the expected usage rates for the source parity group, so that you can see the predicted effect of migrating the selected volume out of its group. When you select the target volume for a manual migration, Auto LUN displays the expected usage rates for the target parity group, so that you can see the predicted effect of adding the selected source volume to the selected parity group.

Auto LUN does not estimate processor or access path usage. Auto LUN migration operations can be used to improve DKP and DRR usage, but do not address CHP or access path usage.

Auto LUN migration should be performed only when you can expect a large improvement in disk array performance. Auto LUN migration may not provide significant improvement for cases in which parity group or volume usage varies only slightly, or for cases in which overall DKP or DRR usage is relatively high. Also keep in mind that the disk array tuning operations can improve performance in one area while at the same time decreasing performance in another. For example, let's say that parity groups A and B have average usage values of 20% and 90%, respectively. Auto LUN estimates that if one logical volume is migrated from parity group B to parity group A, the usage values will become 55% and 55%. If you perform this migration operation, the I/O response time for parity group B will probably decrease, and the I/O response time for parity group A may increase, while the overall throughput may increase or decrease.

## Automatic Migration

Auto migration is the primary tuning method for the disk array.

Auto migration analyzes data and executes migration plans automatically, based on user-specified parameters. Use Auto LUN to schedule the auto migration operations, select the data to be analyzed, and specify the maximum time and maximum performance impact of the auto migration operations. Auto LUN displays a detailed log of auto migration activities.

Auto migration operations are based on the following three major parameters:

- **Hierarchy of parity groups.** Auto LUN arranges the parity groups in the XP128/XP1024 in a hierarchy, or ordering, based on HDD type. Auto LUN assigns each parity group to a class based on the performance of its HDD type, and the classes are ordered from highest performance drive (class A) to lowest performance drive (class B, C or higher depending on the number of HDD types available). The auto migration function uses this hierarchy to identify target volumes for auto migration operations.

The auto migration function can also specify “fixed” parity groups that are to be excluded from auto migration operations.

- **Maximum disk usage.** The auto migration function specifies the maximum disk usage rate for each HDD class in the XP128/XP1024, and then uses these limits to identify source volumes for auto migration operations.

You must identify and specify disk usage limits for your environment. When you use the same maximum disk usage rate for all HDD classes, the performance of the HDD is the only factor used in determining auto migration plans. When you specify different usage limits for the HDD classes, you can bias the auto migration function to favor (or avoid) certain HDD types. The migration of high-usage volumes to higher HDD classes should significantly improve host access to the volumes, which in itself can also have a large effect on disk array performance.

The auto migration function also specifies the maximum disk usage rate during auto migration operations, so that you can control the impact of Auto LUN copy operations on disk array performance. If the use of the source or target parity group exceeds the specified limit during migration, the auto migration operation is canceled.

Do not perform manual migration operations while the auto migration function is active. Always turn off the auto migration function and cancel any existing auto migration plan before performing manual migration operations.

## Storage Management by Maximum Disk Usage

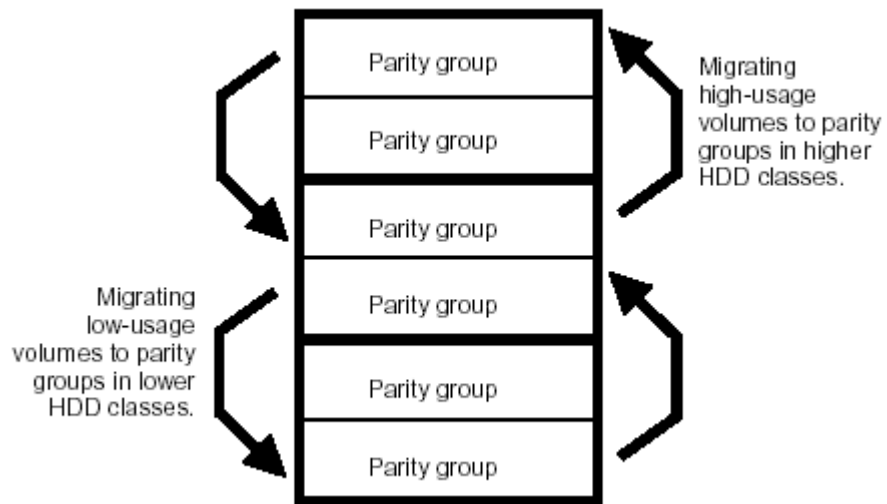
Use the auto migration function to specify the maximum usage rate for each HDD class in the XP128/XP1024. When a parity group exceeds this limit, the auto migration function makes a plan to migrate one or more volumes in this parity group to another parity group in a higher HDD class or to a parity group in the same HDD class with lower utilization.

This storage tuning method addresses and can eliminate bottlenecks of disk drive activity. Auto LUN uses its estimated usage rates to verify each proposed auto migration, and will not perform a migration operation that might result in a target parity group exceeding the user-specified maximum disk usage rate.

Auto migration function identifies parity groups that exceed the user-specified usage limit, and then selects the high-usage volumes as the source volumes to be migrated to parity groups in higher HDD classes or to other parity groups in the same HDD class but with lower utilization.

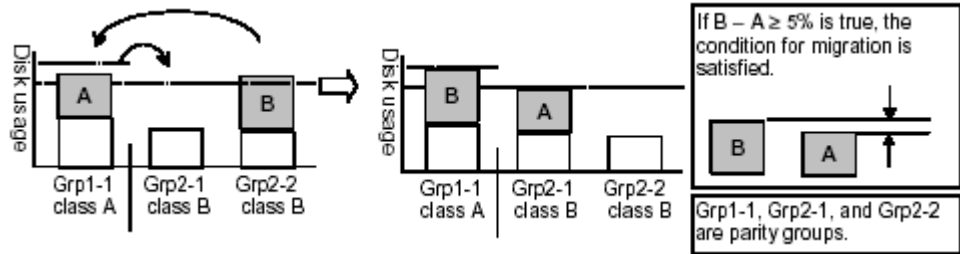
## Keep Reserved Volumes in High HDD Classes

When the parity groups in the highest HDD classes start to run out of reserved (empty) volumes, Auto LUN automatically migrates low-usage volumes from higher HDD class groups to lower HDD class groups to maintain available reserve volumes.



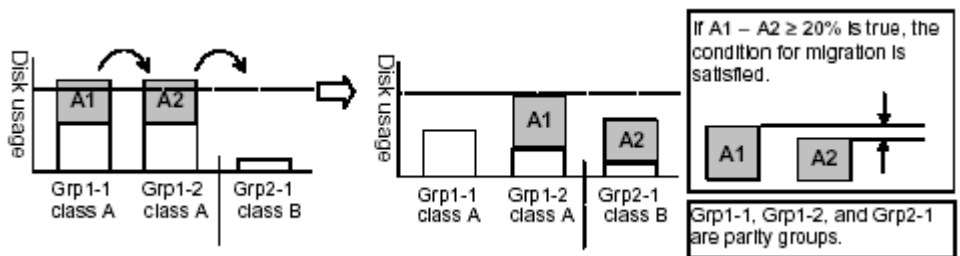
**Figure 164: Moving volumes to another class based on usage**

The auto migration function can move a high-usage volume to a higher HDD class group, forcing a low-usage volume out of that HDD class group. To be able to move one volume into a different HDD class group and then force another volume out of that class group, the auto migration function requires a minimum of five percent difference in estimated disk usage between the two volumes. If the difference in disk usage is less than 5%, this migration is considered ineffective, and the volume is not moved.



**Figure 165: Auto migration function example 1**

The auto migration function can also move a volume from one parity group to another group of the same HDD class, forcing another volume out of the destination parity group. To be able to move one volume into a parity group of the same HDD class and force another volume out of that parity group, the auto migration function requires a minimum of twenty percent difference in estimated disk usage between the two volumes. If the difference in disk usage is less than 20%, this migration is considered ineffective, and the volume is not moved.



**Figure 166: Auto migration function example 2**

## Auto Migration Sequence of Events

This is the typical sequence of steps you will follow to set up a plan for auto migration:

1. Analyze monitor data. You specify the monitor data term to be analyzed.
2. Make the auto migration plan. You specify the parameters of the auto migration plan.
3. Perform auto migration plan. You specify when the auto migration plan is executed.
4. Analyze monitor data to confirm tuning results.

## Manual Migration

Use manual migration to select and migrate logical volumes under direct, manual control. The function displays the estimated results of your proposed migration operations, which you can use to determine expected performance improvements prior to actual migration.

While auto migration operations are based on disk usage and hierarchy of parity groups, you can use manual migration operations to address back-end processor usage (DKPs and DRRs) as well as volume and parity group usage. If monitoring shows high or unbalanced processor usage, you can use manual migration operations to tune the processor performance of the XP128/XP1024.

## Requirements and Restrictions

### Logical Volumes

The source and target volumes must be in the same XP128/XP1024 and have the same emulation type and capacity.

### Source Volumes

The following volumes cannot be used as source volumes:

- Volumes set as command devices (reserved for use by a host).
- Volumes that are in an abnormal or inaccessible condition (for example, fenced).
- Volumes that have Cache LUN data stored in cache.
- **Continuous Access.** If the status of a CA volume is PSUS, PSUE, or SMPL, the volume can be used as a source volume. If not, the volume cannot be used as a source volume. When a CA pair is deleted from the MCU, the status of both volumes changes to SMPL, and both volumes can be used as source volumes. When a CA pair is deleted from the RCU, the status of the P-VOL changes to PSUS and the status of the S-VOL changes to SMPL, and both volumes can be used as source volumes.
- **Business Copy.** Use of a BC volume as a source volume depends on the status and cascade configuration of the volume. If the status of a BC volume is not split-pending COPY(SP) or PSUS(SP), the volume can be used as a source volume. If the status is COPY(SP) or PSUS(SP), the volume cannot be used as a source volume. This applies to cascaded and non-cascaded volumes.

The following table shows which non-cascaded volumes can be used as source volumes.

**Table 43: Non-cascaded volumes that can be used as source volumes (XP128/XP1024)**

Pair Configuration	Can P-VOL be used as a source volume?	Can S-VOLs be used as source volumes?
Ratio of P-VOL to S-VOLs is 1:1	Yes	Yes
Ratio of P-VOL to S-VOLs is 1:2	Yes	Yes
Ratio of P-VOL to S-VOLs is 1:3	No	Yes

The following table shows which cascaded volumes can be used as source volumes.

**Table 44: Cascaded volumes that can be used as source volumes (XP128/XP1024)**

Pair Configuration	Can P-VOL be used as a source volume?	Can S-VOLs be used as source volumes?
L1 pair, ratio of P-VOL to S-VOLs is 1:1	Yes	Yes
L1 pair, ratio of P-VOL to S-VOLs is 1:2	Yes	Yes
L1 pair, ratio of P-VOL to S-VOLs is 1:3	No	Yes
L2 pair, ratio of P-VOL to S-VOLs is 1:1	Yes	No
L2 pair, ratio of P-VOL to S-VOLs is 1:2	No	No

If either of the following operations is performed on an Auto LUN source volume during migration, the Auto LUN volume migration process stops:

- CA operations that change the volume status to something other than PSUS, PSUE, or SMPL.
- BC operations that change the volume status to COPY(SP) or PSUS(SP).

## LUSE Source Volumes

If you want to specify a LUSE source volume for migration, you can specify individual LDEVs within the LUSE volume (for example LDEVs with high usage), and Auto LUN will migrate only the specified LDEVs. If needed, you can also specify all LDEVs of the LUSE volume to relocate the entire LUSE volume. In this case, you must make sure that the required reserved target LDEVs are available.

## Target Volumes

Target volumes must be reserved prior to migration. Hosts cannot access reserved volumes. The following volumes cannot be reserved:

- Logical Unit Size Expansion (LUSE) volumes
- Volumes that are set as command devices
- Volumes that are assigned to BC or CA pairs
- Volumes that are reserved for BC operations
- Volumes that have Cache LUN data stored in cache

- Volumes that are in an abnormal or inaccessible condition (for example, fenced)

## Number of Volumes

The maximum number of Auto LUN copy operations that can be requested at the same time is 36. Auto LUN performs migration operations sequentially (one volume at a time).

The maximum number of Auto LUN copy operations plus BC pairs is 1024.

## Auto Migration Planning

Auto LUN will not plan an auto migration when:

- There is no reserve volume with the same emulation type and capacity as the source volume in the same or next higher/lower HDD class (auto migration is performed only between consecutive classes or within the same class).
- The usage rate for the target parity group cannot be estimated because some condition is preventing Auto LUN from estimating expected usage (for example, invalid monitor data).
- The estimated usage of the target parity group or volume is over the user-specified maximum disk utilization value for that HDD class.
- The estimated performance improvement is not large enough.

## Auto Migration Execution

Auto LUN will not execute an auto migration operation when:

- The current usage (last 15 min.) of the source or target parity group or volume is over the maximum disk utilization rate for auto migration.
- The current write pending rate for the disk array is 60% or higher.

## Manual Migration Execution

Auto LUN will execute a manual migration operation when the current write pending rate for the disk array is 60% or higher.

## Maintenance

Do not perform Auto LUN migration operations during disk array maintenance activities (for example, cache or drive installation, replacement, or de-installation).



## Auto Migration Parameters

Auto migration parameters are initialized when a change is made to the disk array configuration. For example, the parameters are initialized when new drives or LDEVs are installed. The parameters include the disk usage limit and the migration time. After a change is made to the subsystem configuration, you must specify auto migration parameters again.

## Additional Notes on Powering Off the Disk Array

If you want to turn the power off at the disk array, confirm whether volume migration is finished. If migration is not finished, it is strongly recommended that you do not turn off the power until the migration is finished.

If you turn the power off when migration is in progress, data migration stops and some of the data are not migrated. If you turn the power on later, Auto LUN resumes data migration. If the data remains in the shared memory, which is a volatile memory, Auto LUN attempts to copy only the data that have not been migrated to the migration destination. However, if data is lost from the shared memory, Auto LUN attempts to copy all the data to the migration destination and thus the copy operation would take more time. Auto LUN attempts to copy data that have not been migrated, and also attempts to copy data that have already been copied to the migration destination.

If you want to power off your disk array, obtain the monitoring results first. If you forget to obtain the monitoring results before powering off the disk array, the **Physical** tab will not display some of the monitoring results. For example, if 4:00 a.m. and p.m. is specified in the **Gathering Time** option in the Auto LUN Monitoring Options screen and you turn off the power to the disk array at 5:00 p.m., the **Physical** tab will not display the monitoring results from 4:00 p.m. to 5:00 p.m.

## Starting Auto LUN

To start Auto LUN:

1. From the Launch screen, click an XP128 or XP1024.
2. Click the **Auto LUN** tab. The Auto LUN main screen is displayed.

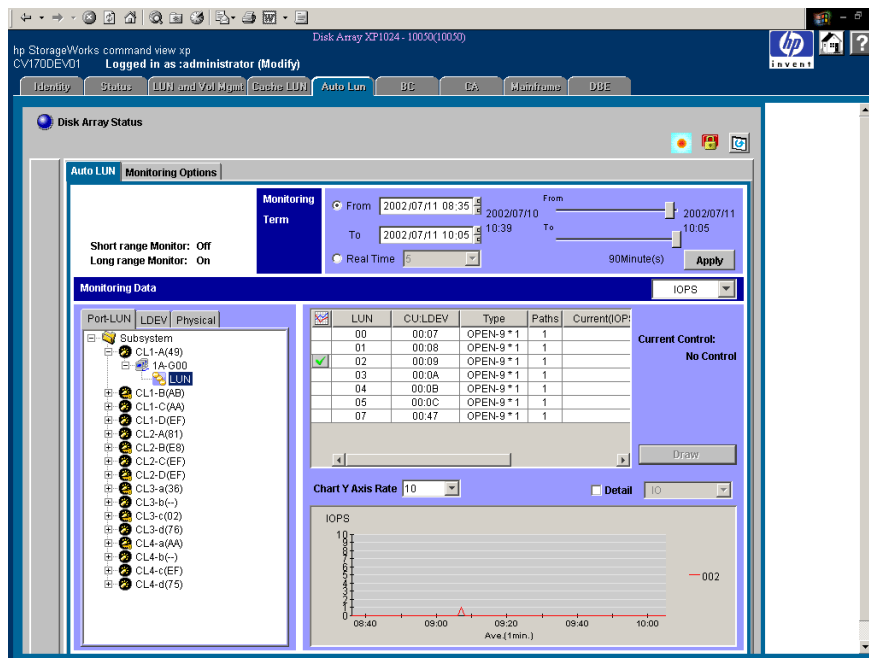


Figure 167: Auto LUN main screen

3. The default screen has the **Auto LUN** tab selected. To display the Auto LUN Monitoring Options screen, click the **Monitoring Options** tab from the Auto LUN main screen.

## Auto LUN Main Screen

The Auto LUN main screen is the performance management screen, and displays usage rates for parity groups, logical volumes, channel processors, disk processors, and so forth. The screen has several sections.

### Tabs and Selection trees

When you click one of the tabs (**Port-LUN**, **LDEV**, or **Physical**) in the lower-left portion of the screen, the screen will display different trees of items you can click.

### Monitoring Term section

Use the monitoring term section to specify the monitoring period.

Use the **From** box and the slide bar to specify the starting date for the monitoring period. Use the **To** box and the slide bar to specify the ending date for the monitoring period.

Clicking **Real Time** displays workload statistics in real time. This check box is grayed out when the **Physical** tab is active.

The **Apply** button applies the monitoring period settings to the disk array.

### Table section

The **Monitoring Data** field has a drop-down list, where you can specify the units in which usage will be displayed (MB/s, IOPS, etc.).

The table section displays:

- Traffic statistics about WWNs and ports if the **Port-LUN** tab is active.
- Workload statistics about logical volumes if the **LDEV** tab is active.
- Statistics about parity group usage, processor usage, and so forth if the **Physical** tab is active.

The **Plan** button is displayed when the **Physical** tab is active. Clicking this button displays a new window containing the Plan screens, which are accessed by clicking one of the four tabs: **Manual Migration**, **Auto Migration**, **Attribute**, and **History** tabs.

The **Draw** button draws a graph in the graph section of the screen. The graph charts the statistics displayed in the table section.

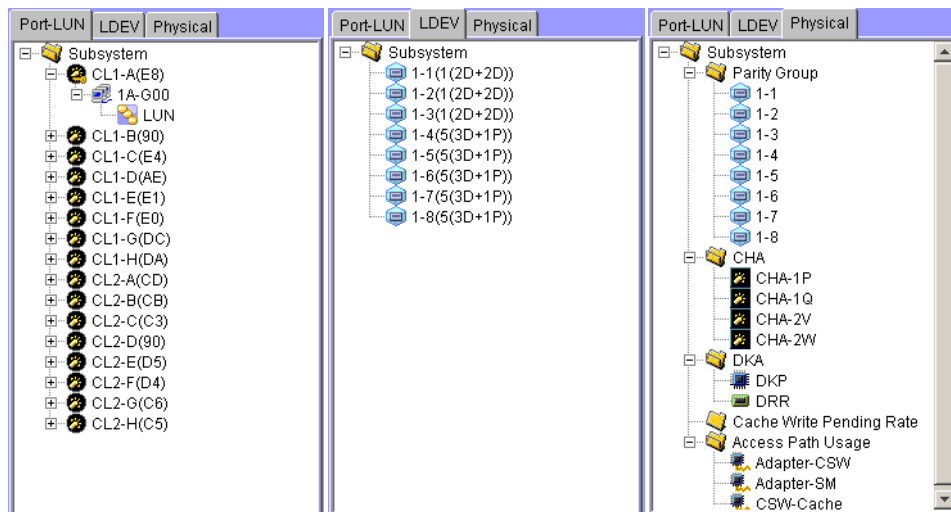
### Graph section

The graph displays statistics displayed in the table. The vertical axis shows the usage values and the horizontal axis shows date or time.

Use the **Chart Y Axis Rate** drop-down list to select the highest value of the Y-axis (the vertical axis) of the graph. This drop-down list is not displayed when the **Plan** button is active.

If you select the **Detail** check box, the graph displays detailed statistics. This check box is displayed when either the **Port-LUN** or **LDEV** tab is active.

## Port-LUN, LDEV, and Physical Tabs



**Figure 168: Port-LUN, LDEV, and Physical tabs**









Click one of the tabs (**Port-LUN**, **LDEV**, or **Physical**) in the lower-left portion of the screen to view data about ports, LDEVs, or physical components.

When you click a tab, the selection tree in the lower-left portion of the screen changes. You can then click entities to display information in the table section and in the graph section of the screen.

### Port-LUN tab

Click the **Port-LUN** tab to display ports. The tree view can display the following icons:


**Table 45: Auto LUN - Port-LUN tab icons (XP128/XP1024)**

Icon	Status
	A short-wave Fibre Channel port in standard mode with LUN security. If the port name is followed by its fibre address, the port is a Fibre Channel port. For example, CL1-A(EF) indicates that the CL1-A port is a Fibre Channel port.
	A short-wave Fibre Channel port in standard mode without LUN security.
	A short-wave Fibre Channel port in high-speed or high-speed (2 port) mode with LUN security.
	A short-wave Fibre Channel port in high-speed or high-speed (2 port) mode without LUN security.
	A long-wave Fibre Channel port in standard mode with LUN security.
	A long-wave Fibre Channel port in standard mode without LUN security.
	A long-wave Fibre Channel port in high-speed or high-speed (2 port) mode with LUN security.
	A long-wave Fibre Channel port in high-speed or high-speed (2 port) mode without LUN security.

**Note:** High-speed (2 port) mode is available only if the XP disk array has firmware version 21.06.22 or later installed.

### LDEV tab

Click the **LDEV** tab to display parity groups. Double-clicking a parity group displays the logical volumes in the parity group in the table. If a parity group ID starts with the letter E, the logical volumes in the parity group are external LUs.

The parity group icon () represents either a single parity group, or two or more parity groups connected together. If two or more parity groups are connected together, logical volumes can be striped across two or more drives. Therefore, connected parity groups provide faster access (particularly, faster sequential access) to data.










If the parity group icon represents a single parity group 1-3, the text 1-3 is displayed on the right of the icon. If the parity group icon represents two or more parity groups connected together, all the connected parity groups are displayed to

the right of the icon. For example, if the parity group 1-3 is connected with the parity group 1-4, the text 1-3[1-4] is displayed on the right of the parity group icon. All the parity groups connected with 1-3 are enclosed by square brackets.

### Physical tab

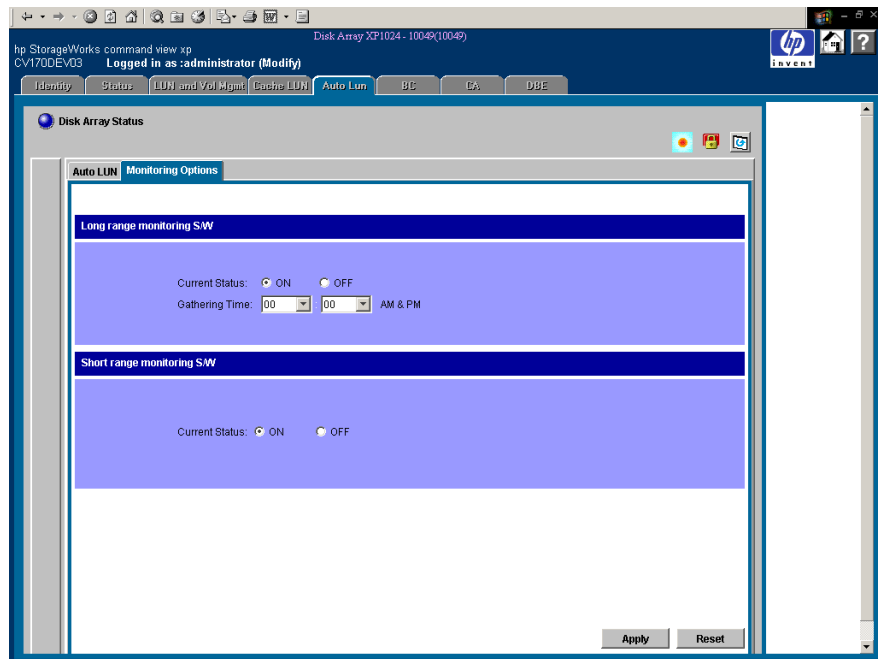
Click the **Physical** tab to display parity groups, CHAs, DKAs, and other related items. The tree view can display the following icons:

**Table 46: Auto LUN - Physical tab icons (XP128/XP1024)**

Icon	Description
	A parity group.
	An ESCON or FICON channel adapter.
	A short-wave Fibre Channel adapter in standard mode.
	A short-wave Fibre Channel adapter in high-speed or high-speed (2 port) mode.
	A long-wave Fibre Channel adapter in standard mode.
	A long-wave Fibre Channel adapter in high-speed or high-speed (2 port) mode.
	A disk processor (DKP).
	A disaster recovery and regeneration processor (DRR).
	An access path.

**Note:** High-speed (2 port) mode is available only if the XP disk array has firmware version 21.06.22 or later installed.

## Auto LUN Monitoring Options Screen



**Figure 169: Auto LUN Monitoring Options screen**

Use the Auto LUN Monitoring Options screen to set the gathering time for monitoring. This screen contains the following items:

- **Long range monitoring S/W:** Monitors resources in the disk array to obtain usage statistics.
  - **Current Status:** Specifies whether to monitor the disk array. Click **ON** to start monitoring the disk array. Click **OFF** to stop monitoring the disk array. The default is **OFF**.
  - **Gathering Time:** Specifies when statistics are collected. If Current Status is **ON**, statistics are collected at the time you specify in the field (once in the morning and once in the afternoon). The default is **0:00** (0:00 a.m. and 0:00 p.m.).
- **Short range monitoring S/W:** Monitors disks, ports, and LU paths to obtain workload statistics, and measures traffic between host bus adapters and ports.

- **Current Status:** Specifies whether to monitor the disk array. Click **ON** to start monitoring the disk array. Click **OFF** to stop monitoring the disk array. The default is **OFF**.

If you click **ON** for the Current Status option, the option setting automatically changes to **OFF** 24 hours later.

If the **Physical** tab is displayed and the monitoring term exceeds one day, data in the graph might be subject to a margin of error. To display the graph correctly, ensure that the monitoring term does not exceed one day. In the **Physical** tab, a maximum of 96 data points are plotted to form a single graph line, and the values of the data points can differ depending on whether the monitoring term exceeds one day.

If the **LDEV** or **Port-LUN** tab is displayed and the monitoring term exceeds 90 minutes, data in the graph might be subject to a margin of error. To display the graph correctly, ensure that the monitoring term does not exceed 90 minutes. In the **LDEV** or **Port-LUN** tab, a maximum of 90 data points are plotted to form a single graph line, and the values of the data points can differ depending on whether the monitoring term exceeds 90 minutes.



## Usage Statistics

### Collecting Usage Statistics About Disk Array Resources

To obtain usage statistics about resources in the disk array, complete the following instructions to start monitoring the disk array.

**To start monitoring the disk array:**

1. From the Auto LUN main screen, click the **Monitoring Options** tab. The Monitoring Options screen is displayed.
2. Under Long range monitoring S/W, click **ON** for the Current Status option.
3. Use the two drop-down lists in Gathering Time to specify the time when the disk array collects statistics.
4. Click **Apply**. Auto LUN starts monitoring the disk array.

To stop monitoring the disk array, complete the following instructions. If you stop monitoring, Auto LUN stops collecting statistics.

**To stop monitoring the disk array:**


1. From the Auto LUN main screen, click the **Monitoring Options** tab. The Monitoring Options screen is displayed.
2. Under Long range monitoring S/W, click **OFF** for the Current Status option.
3. Click **Apply**.

### Viewing Parity Group Usage Statistics

Auto LUN monitors parity groups, and displays the average and the maximum usage rate for the specified period. Auto LUN also displays a graph that illustrates changes in parity group usage within that period.

**To view usage statistics about parity groups:**

1. From the Auto LUN main screen, click the **Physical** tab and then click the Parity Group folder. The table displays usage statistics about parity groups.


	PG			Usage(%)	
		RAID	Drive Type	Ave.(Total)	Max.
	1-1	5(3D+1P)	DKR2D-J072...	-	-
	1-2	5(3D+1P)	DKR2D-J072...	-	-
	1-3	5(3D+1P)	DKR2D-J072...	-	-
	1-4	5(3D+1P)	DKR2D-J072...	-	-
	1-5	5(3D+1P)	DKR2D-J072...	-	-
	1-6	5(7D+1P)	DKR2D-J072...	-	-
	2-1	5(3D+1P)	DKR2D-J072...	-	-
	2-2	5(3D+1P)	DKR2D-J072...	-	-
	2-3	1(2D+2D)	DKR2D-J072...	-	-

**Figure 170: Parity group usage statistics**

**Note:** If an exclamation mark (!) is displayed before a usage rate, the reported parity group usage rate is likely to be inaccurate because the configuration has changed (for example, volumes have been moved by a migration plan or changed by VSC).

2. If you want to display a graph that illustrates changes in usage rate for parity groups, click the parity groups in the table and then click **Draw**.

The table displays the following items:


- **Graph column:** The “check mark” icon () indicates the graph is currently illustrating data for that item.
- **PG:** The ID of parity group.
- **RAID:** The RAID level (RAID-5 or RAID-1).
- **Drive Type:** The hard disk drive type.
- **Usage:** The Ave. column displays the average usage rate in the specified period. The Max. column displays the maximum usage rate in the specified period.

## Viewing Logical Volume Usage Statistics

**To view usage statistics about logical volumes in a parity group:**

1. From the Auto LUN main screen, click the **Physical** tab and then double-click the Parity Group folder. The folder opens. A list of parity groups is displayed below the folder.

- Click the parity group. The table displays usage statistics about logical volumes in the specified parity group.


	LDEV	Emulation	Usage(%)		Read Rate(%)		Write Rate(%)		Grp.Use[Exp](%)	
			Ave.	Max.	Rnd.	Seq.	Rnd.	Seq.	Ave.	Max.
	0:00	OPEN-3	110	120	30	40	50	60	10 -> 70	81 -> 80
	0:01	OPEN-3	15	25	35	45	55	65	10 -> 75	81 -> 85
	0:02	OPEN-3	0	0	0	0	0	0	10 -> 0	81 -> 0
	0:03	OPEN-3	0	0	0	0	0	0	10 -> 0	81 -> 0
	0:04	OPEN-3	0	0	0	0	0	0	10 -> 0	81 -> 0
	0:05	OPEN-3	0	0	0	0	0	0	10 -> 0	81 -> 0
	0:06	OPEN-3	0	0	0	0	0	0	10 -> 0	81 -> 0
	0:07	OPEN-3	0	0	0	0	0	0	10 -> 0	81 -> 0

**Figure 171: Logical volume usage statistics**

**Note:** If an exclamation mark (!) is displayed before a usage rate, the reported parity group usage rate is likely to be inaccurate because the configuration has changed (for example, volumes have been moved by a migration plan or changed by VSC).

- If you want to display a graph that illustrates changes in usage rate for parity groups, click the parity groups in the table and then click **Draw**.

The table displays the following items:

- **Graph column:** The “check mark” icon () indicates the graph is currently illustrating data for that item.
- **LDEV:** Logical volumes (LDEVs). The number on the left of the colon is the CU image number. The number of the right of the colon is the LDEV number.
- **Emulation:** Device emulation type.
- **Usage:** The Ave. column displays the average usage rate in the specified period. The Max. column displays the maximum usage rate in the specified period.
- **Read Rate:** The Rnd. column indicates random read rates. A random read rate is the ratio of random read requests to read and write requests. The Seq. column indicates sequential read rates. A sequential read rate is the ratio of sequential read requests to read and write requests.
- **Write Rate:** The Rnd. column indicates random write rates. A random write rate is the ratio of random write requests to read and write requests. The Seq. column indicates sequential write rates. A sequential write rate is the ratio of sequential write requests to read and write requests.


- **Grp. Use:** The expected (estimated) average and maximum usage rates of the parity group, if the volume were migrated out of the group (or de-installed). The Ave. column indicates an estimated change in the average usage rate. The Max. column indicates an estimated change in the maximum usage rate. For example, if the Ave. box for the volume 0:01 displays “20 -> 18,” the average usage rate of the parity group that the volume belongs to is 20 percent. If the volume were migrated out of the parity group, the average usage rate of that group is expected to drop to 18 percent.

## Viewing Channel Adapter (CHA) Usage Statistics

Auto LUN monitors channel adapters, and displays the average and the maximum usage rate in the specified period.

### To view usage statistics about channel adapters:


1. From the Auto LUN main screen, click the **Physical** tab and then click the **CHA** folder. The table displays usage statistics about channel adapters (CHAs).

	ID	Usage(%)	
		Ave.(Total)	Max.
	CHP00-1P	-	-
	CHP01-1P	-	-
	CHP02-1P	-	-
	CHP03-1P	-	-
	CHP40-2V	-	-
	CHP41-2V	-	-
	CHP42-2V	-	-
	CHP43-2V	-	-

**Figure 172: CHA usage statistics**

2. If you want to display a graph that illustrates changes in usage rate for channel adapters, click the channel adapters in the table and then click **Draw**.

The table displays the following items:

- **Graph column:** The “check mark” icon () indicates the graph is currently illustrating data for that item.
- **ID:** ID numbers for channel processors.


- **Usage:** The Ave. column displays the average usage rate in the specified period. The Max. column displays the maximum usage rate in the specified period.

## Viewing Channel Processor (CHP) Usage Statistics

Auto LUN monitors channel processors in each channel adapter, and displays the average and the maximum usage rate in the specified period.

### To view usage statistics about channel processors:

1. From the Auto LUN main screen, click the **Physical** tab and then double-click the CHA folder. The CHA folder opens and displays a list of channel adapters.
2. Click a channel adapter. The table displays usage statistics about channel processors in the selected channel adapter.

	ID	Usage(%)	
		Ave.	Max.
<input checked="" type="checkbox"/>	CHP00-1P	20	82
<input type="checkbox"/>	CHP01-1P	20	82
<input type="checkbox"/>	CHP02-1P	20	82
<input type="checkbox"/>	CHP03-1P	20	82

**Figure 173: CHP usage statistics**

3. If you want to display a graph that illustrates changes in usage rates for channel processors, click the channel processors in the table and then click **Draw**.

The table displays the following items:

- **Graph column:** The “check mark” icon () indicates the graph is currently illustrating data for that item.
- **ID:** ID numbers for channel processors.
- **Usage:** The Ave. column displays the average usage rate in the specified period. The Max. column displays the maximum usage rate in the specified period.

## Viewing Disk Adapter (DKA) Usage Statistics

Auto LUN monitors disk adapters, and displays the average and the maximum usage rate in the specified period. If you click the DKA folder, the table displays a list of disk adapters and whether each disk adapter is located in Cluster-1 or Cluster-2.

### To view usage statistics about disk adapters:

- From the Auto LUN main screen, click the **Physical** tab and then click the DKA folder. The table displays a list of disk adapters.

Adapter	Cluster-1	Cluster-2
DKA-1B	0	-
DKA-1C	0	-
DKA-2H	-	0
DKA-2J	-	0

**Figure 174: DKA usage statistics**

The table displays the following items:


- **Adapter:** ID numbers for disk adapters.
- **Cluster-1:** If the Cluster-1 column displays 0 and the Cluster-2 column displays a hyphen, the disk adapter is located in Cluster-1.
- **Cluster-2:** If the Cluster-2 column displays 0 and the Cluster-1 column displays a hyphen, the disk adapter is located in Cluster-2.

## Viewing Disk Processor (DKP) Usage Statistics

Auto LUN monitors disk processors, and displays the average and the maximum usage rate in the specified period.

### To view usage statistics about disk processors:

1. From the Auto LUN main screen, click the **Physical** tab and then double-click the DKA folder to open the folder.
2. Click the DKP. The table displays usage statistics about disk processors in the disk adapter.

	ID	Usage(%)	
		Ave.	Max.
<input checked="" type="checkbox"/>	DKP80-1B	30	83
<input type="checkbox"/>	DKP81-1B	30	83
<input type="checkbox"/>	DKP82-1B	30	83
<input type="checkbox"/>	DKP83-1B	30	83

**Figure 175: DKP usage statistics**

3. If you want to display a graph that illustrates changes in usage rate for disk processors, click the disk processors in the table and then click **Draw**.

The table displays the following items:


- **Graph column:** The “check mark” icon () indicates the graph is currently illustrating data for that item.
- **ID:** ID numbers for disk processors.
- **Usage:** The Ave. column displays the average usage rate in the specified period. The Max. column displays the maximum usage rate in the specified period.

## Viewing Disaster Recovery and Regeneration Processor (DRR) Usage Statistics

Auto LUN monitors DRRs (disaster recovery and regeneration processors), and displays the average and the maximum usage rate in the specified period.

### To view usage statistics about DRRs:

1. From the Auto LUN main screen, click the **Physical** tab and then double-click the DKA folder to open the folder.
2. Click the DRR from below the disk adapter. The table displays usage statistics about DRRs in the disk adapter.

	ID	Usage(%)	
		Ave.	Max.
<input checked="" type="checkbox"/>	DRR80-1B	40	84
<input type="checkbox"/>	DRR81-1B	40	84
<input type="checkbox"/>	DRR82-1B	40	84
<input type="checkbox"/>	DRR83-1B	40	84

**Figure 176: DRR usage statistics**

- If you want to display a graph that illustrates changes in usage rate for DRRs, click the DRRs in the table and then click **Draw**.

The table displays the following items:


- **Graph column:** The “check mark” icon () indicates the graph is currently illustrating data for that item.
- **ID:** This column displays ID numbers for DRRs.
- **Usage:** The Ave. column displays the average usage rate in the specified period. The Max. column displays the maximum usage rate in the specified period.

## Viewing Write Pending Rates

You can use Auto LUN to display write pending rates. The write pending rate indicates the ratio of write-pending data to the cache memory capacity. Auto LUN displays the average and the maximum write pending rate in the specified period.

**To view the write pending rate:**

- From the Auto LUN main screen, click the **Physical** tab and then click the Cache Write Pending Rate folder.

	Cache Write Pending Rate(%)	
	Ave.	Max.
<input checked="" type="checkbox"/>	88	99

**Figure 177: Write pending rates**

- If you want to display a graph that illustrates changes in the write pending rate, click the write pending rate in the table and then click **Draw**.

The table displays the following items:



- **Graph column:** The “check mark” icon (☑) indicates the graph is currently illustrating data for that item.
- **Cache Write Pending Rate:** The Ave. column displays the average write pending rate for the specified period. The Moment Max. column displays the maximum write pending rate for the specified period.

## Viewing Access Path Usage Statistics

The channel adapters (CHAs) and the disk adapters (DKAs) transfer data to the cache switch (CSW) and the shared memory (SM) when I/O requests are issued from hosts to the disk array. Also, the cache switch transfers data to cache memory.

Auto LUN monitors these data transfer paths, and displays the average and the maximum usage rate for the paths in a specified period.

### To view usage statistics about paths:

1. From the Auto LUN main screen, click the **Physical** tab and then double-click the Access Path Usage folder.
2. Do any of the following:
  - To check usage statistics about paths between adapters (CHAs and DKAs) and the cache switch, click **Adapter-CSW** from below the Access Path Usage folder.

	Adapter	CSW	Usage(%)	
			Ave.	Max.
	CHA-1P	CSW-1N	60	86
	CHA-1P	CSW-1A	60	86
	CHA-1Q	CSW-1N	60	86
	CHA-1Q	CSW-1A	60	86
	CHA-1R	CSW-1N	60	86
	CHA-1R	CSW-1A	60	86
	CHA-1S	CSW-1N	60	86
	CHA-1S	CSW-1A	60	86
	CHA-2V	CSW-2M	60	86

**Figure 178: Usage statistics about paths between adapters and the cache switch**

- To check usage statistics about paths between adapters (CHAs and DKAs) and the shared memory, click **Adapter-SM** from below the Access Path Usage folder.

	Adapter	SM	Usage(%)		
			Ave.	Max.	
	CHA-1P	Side-A	50	85	▲
	CHA-1P	Side-B	50	85	
	CHA-1Q	Side-A	50	85	
	CHA-1Q	Side-B	50	85	
	CHA-1R	Side-A	50	85	
	CHA-1R	Side-B	50	85	
	CHA-1S	Side-A	50	85	
	CHA-1S	Side-B	50	85	
	CHA-2V	Side-A	50	85	▼

**Figure 179: Usage statistics about paths between adapters and the shared memory**


- To check usage statistics about paths between cache switches and the cache memory, click **CSW-Cache** from below the Access Path Usage folder.

	CSW	Cache	Usage(%)		
			Ave.	Max.	
	CSW-1N	CACHE-1T	70	87	▲
	CSW-1A	CACHE-1T	70	87	
	CSW-2M	CACHE-1T	70	87	
	CSW-2Z	CACHE-1T	70	87	
	CSW-1N	CACHE-1U	70	87	
	CSW-1A	CACHE-1U	70	87	
	CSW-2M	CACHE-1U	70	87	
	CSW-2Z	CACHE-1U	70	87	
	CSW-1N	CACHE-2G	70	87	▼

**Figure 180: Usage statistics about paths between cache switches and the cache memory**

- If you want to display a graph that illustrates changes in usage statistics about paths, click the paths in the table and then click **Draw**.

The table displays the following items:

- **Graph column:** The “check mark” icon () indicates the graph is currently illustrating data for that item.
- **Usage:** The Ave. column displays the average path usage rate in the specified period. The Max. column displays the maximum path usage rate in the specified period.

---

## Workload and Traffic Statistics

### Collecting Workload and Traffic Statistics About Disk Drives, Ports, and LU Paths

To obtain usage statistics about workloads, port traffic, LU path traffic, and traffic between host bus adapters and ports, complete the following instructions to start monitoring the disk array.

**To start monitoring the disk array:**

1. From the Auto LUN main screen, click the **Monitoring Options** tab. The Monitoring Options screen is displayed.
2. Under Short range monitoring S/W, click **ON** for the Current Status option.
3. Use the two drop-down lists in Gathering Time to specify the time when the disk array collects statistics.
4. Click **Apply**. Auto LUN starts monitoring the disk array.

To stop monitoring the disk array, complete the following instructions. If you stop monitoring, Auto LUN stops collecting statistics.

**To stop monitoring the disk array:**

1. From the Auto LUN main screen, click the **Monitoring Options** tab. The Monitoring Options screen is displayed.
2. Under Short range monitoring S/W, click **OFF** for the Current Status option.
3. Click **Apply**.

### Viewing Disk Drive Workload Statistics


Click the **LDEV** tab of the Auto LUN main screen to check workloads on physical disk drives (parity groups) or on logical volumes. The screen displays the following information:

- Number of I/O requests issued to parity groups and logical volumes
- Amount of data transferred to parity groups and logical volumes
- Read hit rate
- Write hit rate

- Number of data transfers between parity groups (or logical volumes) and cache memory


**To view workload statistics on disk drives:**

1. From the Auto LUN main screen, click the **LDEV** tab. The LDEV tree displays a list of parity groups.
2. In the drop-down list on the right, click **IOPS** to specify I/Os per second or **MB** for performance in megabytes transferred per second.
3. In the LDEV tree, do either of the following:
  - To check workload statistics for parity groups, click the folder containing the parity groups.

	Group	IO Rate...	Read...	Write...	Read Hit...	Write Hit...	Back Tra...
	1-3	0	0	0	0	0	0
	1-4	0	0	0	0	0	0
	12-32	0	0	0	0	0	0

**Figure 181: Workload statistics for parity groups**

- To check workload statistics for logical volumes in a parity group, click the parity group. The table displays the statistics for the selected parity group:


	LDEV	Type	IO R...	Read...	Write...	Read H...	Write H...	Ba...
	01:10	OPEN-3	0	0	0	0	0	0
	01:11	OPEN-3	0	0	0	0	0	0
	01:12	OPEN-3	0	0	0	0	0	0
	01:13	OPEN-3	0	0	0	0	0	0
	01:14	OPEN-3	0	0	0	0	0	0

**Figure 182: Workload statistics for logical volumes in a parity group**

4. To display a graph, click the parity groups or logical volumes you want, use the drop-down list on the lower-right side of the table to select the type of information you want to view in the graph, and then click **Draw**. A graph is displayed below the table. The horizontal axis indicates the time.
5. If you want to view more detailed information in the graph, select the **Detail** check box on the lower-right side of the table and then click **Draw**. The graph contents change. If you specify more than one parity group or logical volume, you cannot select the **Detail** check box to view detailed information.

If the graph does not display changes in the workload statistics, you should change the value in the **Chart Y Axis Rate** drop-down list. For example, if the largest value in the table is 200 and the value in Chart Y Axis Rate is 100, select a value larger than 200 from Chart Y Axis Rate.

The table displays the following:


- **Graph column:** The “check mark” icon () indicates the graph is currently illustrating data for that item.
- **Group:** Parity group ID. If the ID starts with the letter E, logical volumes in the parity group are external LUs.
- **LDEV:** Logical volume ID. If the ID ends with the symbol #, the logical volume is an external LU.
- **Type:** Emulation type.
- **IO Rate:** The number of I/O requests to the parity group (or the logical volume) per second. This column is displayed when IOPS is selected in the drop-down list on the upper-right side of the table.
- **Read:** The number of read accesses to the parity group (or the logical volume) per second. This column is displayed when IOPS is selected in the drop-down list on the upper-right side of the table.
- **Write:** The number of write accesses to the parity group (or the logical volume) per second. This column is displayed when IOPS is selected in the drop-down list on the upper-right side of the table.
- **Trans. Rate:** The size (in megabytes) of data transferred to the parity group (or the logical volume) per second. This column is displayed when MB/s is selected in the drop-down list on the upper-right side of the table.
- **Read Hit:** The read hit rate.
- **Write Hit:** The write hit rate.
- **Back Trans.:** The number of data transfers between the parity group (or the logical volume) and cache memory.

## Viewing Disk Array Port Traffic Statistics

**To view traffic statistics about disk array ports:**


1. From the Auto LUN main screen, click the **Port-LUN** tab. The Port-LUN tree lists ports on the disk array. When you double-click a port, a list of host groups for the port is displayed. When you double-click a host group, the LUN icon is displayed.

2. To check the number of I/Os, click **IOPS** in the drop-down list on the right side of the screen. To check the size of transferred data, click **MB/s**.
3. In the Port-LUN tree, do one of the following:
  - To view traffic statistics about ports in the disk array, click the root.

	Port	Current(IOPS)	Ave.(IOPS)...	Max...	Attribute
	All Prio.	-	-	-	Prio.
	All Non-Prio.	-	-	-	Non-Prio.
	CL1-A(EF)	534	534	597	Prio.
	CL1-B(E8)	535	535	598	Prio.
	CL1-C(E4)	536	536	599	Non-Prio.
	CL1-D(E2)	537	537	600	Non-Prio.


**Figure 183: Traffic statistics about ports in the disk array**

- To view traffic statistics about host ports to which a disk array port is connected, click the disk array port.

	WWN	FPC Name	Curr...	Ave....	Max...	Attribute
	0000000000000003	NAME0003	-	293	293	Non-Prio.
	0000000000000006	NAME0006	-	290	290	Prio.
	0000000000000007	NAME0007	-	289	289	Non-Prio.
	0000000000000004	NAME0004	-	292	292	Prio.
	0000000000000005	NAME0005	-	291	291	Non-Prio.


**Figure 184: Traffic statistics about host ports to which a disk array port is connected**

- To view traffic statistics about host ports in a host group, click the host group.

	WWN	Nickname	Current...	Ave...	Max...	Attribute
	0000000000000003	M1	-	293	293	Non-Prio.
	0000000000000004	M4	-	292	292	Prio.
	0000000000000005	M5	-	291	291	Non-Prio.

**Figure 185: Traffic statistics about host ports in a host group**


- To view traffic statistics about LU paths, click the **LUN** icon.

	LUN	CU:LDEV	Type	Paths	Current(IOPS)	Ave....	Max....
	000	00:05	OPEN-3 ...	1	0	0	0
	001	00:06	OPEN-3 ...	1	0	0	0

**Figure 186: Traffic statistics about LU paths**

4. To find out how the traffic has changed, click the ports, WWNs, or LUNs that you want, and then click **Draw**. A graph is displayed below the table.
5. If you want to view more detailed information in the graph, select the **Detail** check box on the lower-right side of the table and then click **Draw**. The graph contents change.

The table displays the following:

- **Graph column:** The “check mark” icon () indicates the graph is currently illustrating data for that item.
- **Port:** Indicates ports on the disk array.
- **WWN:** Indicates WWNs of the host bus adapters.
- **LUN:** Indicates LUNs (logical unit numbers).
- **PPC Name:** Indicates PPC names of the host bus adapters. PPC is not used in Command View.
- **Nickname:** Indicates the nickname for the host bus adapters. LUN Management allows you to assign a nickname to each host bus adapter so that you can easily identify each host bus adapter in the LUN Management screens.
- **CU:LDEV:** Indicates logical volumes IDs. The number of the left of the colon is the CU image number. The number of the right of the colon is the LDEV number. If the ID of a logical volume ends with the symbol #, the logical volume is an external LU.
- **Type:** Indicates emulation types.
- **Paths:** Indicates the number of LU paths.
- **Current:** Indicates the current I/O rate.
- **Ave.:** Indicates the average I/O rate for the specified period.
- **Max.:** Indicates the maximum I/O rate for the specified period.
- **Attribute:** Indicates the priority of each port. Prio. indicates a prioritized port. Non-Prio. indicates a non-prioritized port.

# Creating and Executing Migration Plans

## Accessing the Plan Screens

To access the Plan screens:

1. From the Auto LUN main screen, click the **Physical** tab.
2. Click **Plan**. The Plan - Manual Migration screen is displayed.

There are four tabs: **Manual Migration**, **Auto Migration**, **Attribute**, and **History** tabs. Click any of the tabs to access that screen. By default, the Manual Migration screen is displayed.

## Manual Migration Screen

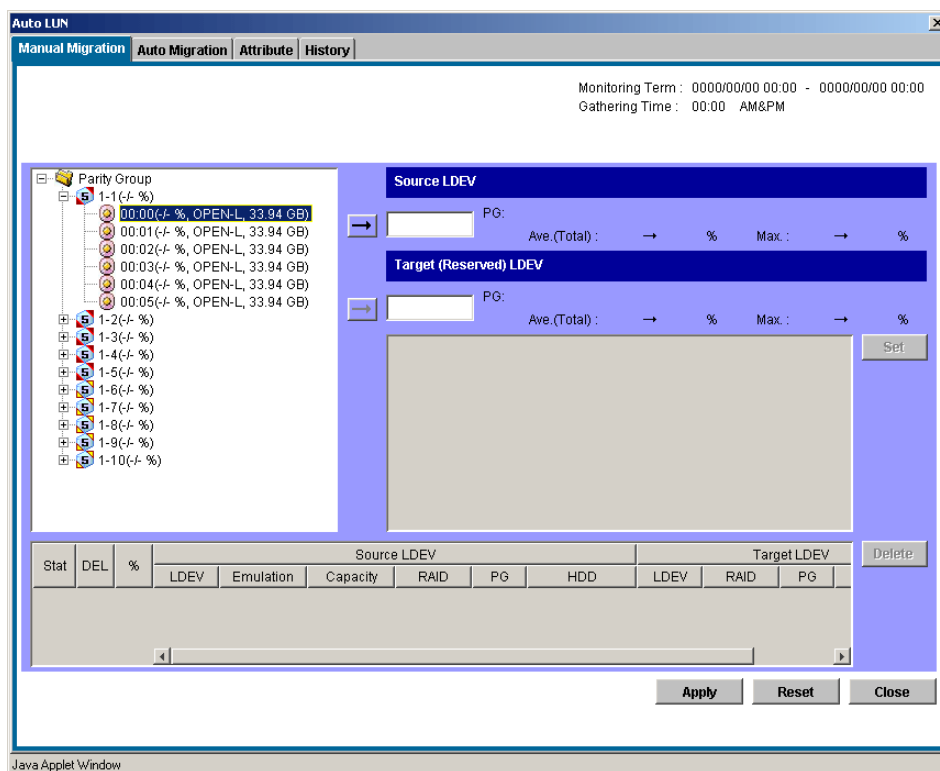


Figure 187: Manual Migration screen



Use the Manual Migration screen to create and execute migration plans for manually migrating volumes. This screen contains the following items:

- **Monitoring Term:** Displays the monitoring period specified in the Auto LUN main screen, analyzes disk usage information collected by Auto LUN during the monitoring period, and then calculates estimated usage rates of the source and target parity groups after a proposed volume migration.
- **Gathering Time:** Displays the time specified in the Auto LUN Monitoring Options screen. The disk array collects usage statistics about resources (such as hard disk drives) at the specified gathering time. Then Auto LUN uses the collected usage statistics to estimate usage rates of parity groups after a proposed volume migration.
- **Source LDEV section:** Used to specify the source volume (the logical volume that you want to migrate). On the right are the current usage rate for the parity group that the source volume belongs to and an estimated usage rate for the parity group after a proposed volume migration.
- **Target (Reserved) LDEV section:** Used to specify the target volume (where you want to migrate the source volume). On the right are the current usage rate for the parity group that the target volume belongs to and an estimated usage rate for the parity group after a proposed volume migration.

#### Tree view

The tree view lists parity groups in the disk array. Double-clicking a parity group icon displays the logical volumes in that parity group.

#### Table view

- **Plan Columns:**
  - **Stat:** Displays an error code if an error occurs during execution of a migration plan. To view detailed information about an error, select and right-click the error code, and then click **Details** from the pop-up menu.
  - **DEL:** Displays the character “D” if you delete a migration plan that is waiting for execution. Migration plans indicated by “D” are actually deleted when you click **Apply**.
  - **%:** The progress of the manual migration.
- **Source LDEV columns:**
  - **LDEV:** Logical volume ID.
  - **Emulation:** Emulation type of the logical volume.
  - **Capacity:** Capacity of the logical volume.

- **RAID:** RAID type.
- **PG:** Parity group ID (frame and group number).
- **HDD:** The type of hard disk drive.
- **Target LDEV columns:**
  - **LDEV:** Logical volume ID.
  - **RAID:** RAID type.
  - **PG:** Parity group ID (frame and group number).
  - **HDD:** The type of hard disk drive.

### Buttons

- **Set button:** Adds a new manual migration plan to the table. The new manual migration plan consists of the logical volume in SourceLDEV and the logical volume in TargetLDEV. Each row in the table indicates a migration plan.
- **Delete button:** Deletes the migration plan (that is, a row in the table). If you select a migration plan in black (a migration plan that is waiting for execution or is being executed) and click **Delete**, the DEL column displays the character “D.” The selected migration plan will not be deleted until you click **Apply**.
- **Apply button:** Applies manual migration plans in the table to the disk array.
- **Source LDEV addition button:** The “→” button below the Source LDEV section.
- **Target LDEV addition button:** The “→” button below the Target (Reserved) LDEV section.
- **Reset button:** Cancels execution of the manual migration plan.
- **Close button:** Closes this screen.

## Migrating Volumes Manually

To migrate volumes manually, you must create migration plans. A migration plan is a pair of volumes—a source volume and a corresponding target (destination) volume. If you want to migrate more than one logical volume, you must create multiple migration plans.



**Caution:** Do not perform manual migration operations while the auto migration function is active. Turn off auto migration and cancel any auto migration plan before doing a manual migration.

**To migrate volumes manually:**

1. From the Auto LUN main screen, click the **Physical** tab.
2. Click **Plan**. The Manual Migration screen is displayed.
3. Before migrating logical volume manually, click the **Auto Migration** tab to turn off Auto Migration.
4. In Auto Migration Plans, click **Delete All** to remove all the auto migration plans.
5. In Auto Migration Function, click **OFF** and then click **Set**.
6. Click the **Manual Migration** tab.
7. In the tree, double-click a parity group. A list of logical volumes in that parity group is displayed. Click the source volume (the logical volume you want to migrate).
8. Click the “→” button below the Source LDEV section. The **Source LDEV** text box displays the volume.
9. In the tree, double-click the parity group to which you want to migrate the source volume. A list of logical volumes in that parity group is displayed. Click the target (destination) volume. You can only use reserved volumes as migration destinations.
10. Click the “→” button below the Target (Reserved) LDEV section.

Auto LUN calculates the estimated usage rate of the source and target parity group. The estimated results are displayed on the right of the Source LDEV and the **Target (Reserved) LDEV** text box and in the graph.
11. Check the estimated results in Source LDEV, Target (Reserved) LDEV, and the graph. If you think you will be able to get the necessary disk performance, go to the next step. If not, return to [step 7](#) or [step 9](#) to change the source or target volume.
12. Click **Set**.

A new migration plan, consisting of the specified source and target volumes, is added to the table. The new migration plan is shown in blue.

If you want to migrate more than one volume manually, repeat the steps to add migration plans.

13. Click **Apply**.

The migration plans are applied to the disk array and wait for execution. The font color of the migration plans changes from blue to black.

When a logical volume starts migration, the % column displays the progress of the migration.

## Deleting Manual Migration Plans

To delete a migration plan, click a migration plan and then click **Delete**.

If you select a migration plan in black (a migration plan that is waiting for execution or being executed) and then click Delete, the character “D” is displayed in the DEL column, and the migration plan will not be deleted until you click **Apply**.



**Caution:** If you delete a migration plan that is being executed, the integrity of the data on the target volume cannot be guaranteed.

---

When an error condition exists on the disk array, resource usage can increase or become unbalanced. Do not use usage statistics collected during an error condition as the basis for planning migration operations.

## Auto Migration Screen

Auto LUN

Manual Migration | **Auto Migration** | Attribute | History

Monitoring Term : 0000/00/00 00:00 - 0000/00/00 00:00  
Gathering Time : 00:00 AM&PM

**Auto Migration Plans**

Auto Migration : OFF      Migration Status : Not planned yet      Auto Refresh  
Plan Creation :      Next Migration :       ON  OFF

%	Source LDEV					Target LDEV				Re-make	
	LDEV	Emulation	Capacity	RAID	PG	HDD	LDEV	RAID	PG		HDD
											Delete
											Delete All

**Auto Plan Parameters**

Auto Migration Function:  ON  OFF      **Default**

**Sampling Term**

Date:  None  Every day  Once every X days: 2   
 Once a week: Sunday  Once a month: 1

Time: From: 06 : 00 To: 02 : 00

Number of Sampling Points:  All sampling points  X highest sampling points: 1

Migration Time: 04 : 30

**Auto Migration Condition**

Max. Migration duration: 60 min.  
Max. disk utilization: 50 %  
Max. number of vols for migration: 1

**Set**  
**Reset**  
**Close**

Java Applet Window

**Figure 188: Auto Migration screen**

The Auto Migration screen is where you make settings for automating volume migrations. This screen contains the following items:

- **Monitoring Term:** Displays the monitoring period specified in the Auto LUN main screen, analyzes disk usage information collected by Auto LUN during the monitoring period, and then calculates estimated usage rates of the source and target parity groups after a proposed volume migration.
- **Gathering Time:** Displays the time specified in the Auto LUN Monitoring Options screen. The disk array collects usage statistics about resources (such as hard disk drives) at the specified gathering time. Then Auto LUN uses the collected usage statistics to estimate usage rates of parity groups after a proposed volume migration.

### Auto Migration Plans section

- **Auto Migration Function:** If Auto Migration Function is ON, auto migrations will take place at the next migration time.
- **Migration Status:** Indicates the progress of auto migration plans.
  - **Not planned yet:** Has not yet created auto migration plans.
  - **Not performed yet:** Has created auto migration plans but hasn't executed them.
  - **Failed to make plan:** Failed to create auto migration plans.
  - **Under migration:** Is executing an auto migration plan.
  - **Last migration has canceled (Please see log file):** Has canceled the plan.
  - **Migration successfully ended. Plan has done:** Successfully executed the plans.
- **Plan Creation Time:** Indicates when the auto migration plans were created.
- **Next Migration Time:** Indicates when the next auto migrations will be performed.
- **Re-make button:** Discards the existing auto migration plans and then creates new auto migration plans.
- **Delete button:** Deletes the auto migration plan selected in the table.
- **Delete All button:** Deletes all the auto migration plans in the table.

### Auto Plan Parameter section

- **Auto Migration Function:** If you click **ON**, logical volumes are automatically migrated. If you click **OFF**, they are not.
- **Sampling Term:** The auto migration function analyzes resource usage within the Sampling Term and creates auto migration plans based on that analysis. Use Sampling Term to narrow resource usage statistics to be analyzed.
- **Date and Time:** These fields let you specify a date/time frequency for analyzing resource usage.
- **Number of Sampling Points:** Click **All sampling points** or **X highest sampling points**. With X highest sampling points, Auto LUN uses the Xth highest average usage rate during the sampling period to determine disk usage. Use the drop-down list to specify the value of X.
- **Migration Time:** Used to specify the time when auto migration starts.
- **Auto Migration Condition:** Used to specify three auto migration conditions:

- **Max. migration duration:** The time limit (10-120 minutes) for an auto migration plan. If the migration is not complete within this limit, the remaining migration operations are performed at the next scheduled execution time.
- **Max. disk utilization:** The disk usage limit (10-100%) during auto migration. If the most recent usage for any source or target parity group is over this limit when auto migration starts, Auto LUN cancels the auto migration plan and will retry the plan at the next execution time.
- **Max. number of vols for migration:** Used to specify the maximum number of volumes (1-40) that can be migrated during one auto migration plan.
- **Default button:** Sets the parameters to their default values and applies them to the disk array.
- **Set button:** Applies parameter to the disk array.
- **Reset button:** Restores each parameter to the value before change.
- **Close button:** Closes this screen.

## Setting Auto Migration Parameters

### To configure auto migration parameters:

1. From the Auto LUN main screen, click the **Physical** tab.
2. Click **Plan**. The Manual Migration screen is displayed.
3. Click the **Auto Migration** tab. The Auto Migration screen is displayed.
4. Use the **Date** and **Time** boxes in Sampling Term to specify a period to analyze resource usage statistics.

Make sure that the data term and the auto migration execution time are separated by at least an hour. For example, if the sampling term is from 10:00 to 14:00, auto migration should not be performed between 09:00 and 15:00.

5. In Number of Sampling Points, click **All sampling points** or **X highest sampling points**, and then click the value of X in the drop-down list.
6. In Migration Time, specify when to start auto migration operations.

The following scheduling restrictions apply to the Migration Time:

- Must be at least 15 minutes plus the specified maximum migration duration earlier than disk array auto-reboot or data gathering.

- Must be at least 30 minutes later than disk array auto-reboot or data gathering.
  - Must be at least 15 minutes plus the specified maximum migration duration earlier than the specified Data Term start time.
  - Must be at least 60 minutes later than the specified Data Term end time.
7. If necessary, set the auto migration parameters as follows:

Use the **Max. migration duration** drop-down list to set a time limit for auto migrations. If auto migration is not complete within this limit, Auto LUN cancels incomplete operations.

Use the **Max. disk utilization** drop-down list to set a disk usage limit.

Use the **Max. number of vols for migration** drop-down list to specify the maximum number of volumes that can be auto migrated at the same time.
  8. In the Auto Migration Function, click **ON**.
  9. Click **Set**.
  10. Click **Close**.

## Deleting Auto Migration Plans

**To delete auto migration plans from the Auto Migration screen:**

- To delete auto migration plans, click **Delete All**.
- To delete a single auto migration plan, click the plan in the table and then click **Delete**.

## Remaking Auto Migration Plans

If auto migration operations do not produce enough improvements in disk access performance, you can discard the current migration plans and remake new auto migration plans.

**To make new auto migration plans:**

1. From the Auto LUN main screen, click the **Physical** tab.
2. Click **Plan**. The Manual Migration screen is displayed.
3. Click the **Auto Migration** tab. The Auto Migration screen is displayed.
4. From the Auto Migration screen, change the limit on the disk utilization rate for HDD classes.



5. Make any other changes you want in the Auto Plan Parameters section of the screen.
6. Click **Re-make**. The existing auto migration plans are deleted and new auto migration plans are created.
7. Click **Close**.

## Attribute Screen

The screenshot shows the 'Attribute' tab in the 'Auto LUN' application. The interface includes a tree view on the left under 'Class A (Threshold: 60 %)' with sub-items 1-1 through 2-5. The main area is a table with the following data:





LDEV	Emulation	Capacity	Ave.%(Total)	Max.%(Total)
00:00	OPEN-9	6.87 GB	-	-
00:01	OPEN-9	6.87 GB	-	-
00:02	OPEN-9	6.87 GB	-	-
00:03	OPEN-9	6.87 GB	-	-
00:04	OPEN-9	6.87 GB	-	-
00:05	OPEN-9	6.87 GB	-	-
00:06	OPEN-9	6.87 GB	-	-
00:07	OPEN-9	6.87 GB	-	-
00:08	OPEN-9	6.87 GB	-	-
00:09	OPEN-9	6.87 GB	-	-
00:0A	OPEN-9	6.87 GB	-	-
00:0B	OPEN-9	6.87 GB	-	-
00:0C	OPEN-9	6.87 GB	-	-
00:0D	OPEN-9	6.87 GB	-	-
00:0E	OPEN-9	6.87 GB	-	-
00:0F	OPEN-9	6.87 GB	-	-
00:10	OPEN-9	6.87 GB	-	-
00:11	OPEN-9	6.87 GB	-	-
00:12	OPEN-9	6.87 GB	-	-
00:13	OPEN-9	6.87 GB	-	-
00:14	OPEN-9	6.87 GB	-	-
00:15	OPEN-9	6.87 GB	-	-
00:16	OPEN-9	6.87 GB	-	-
00:17	OPEN-9	6.87 GB	-	-
00:18	OPEN-9	6.87 GB	-	-
00:19	OPEN-9	6.87 GB	-	-
00:1A	OPEN-9	6.87 GB	-	-

At the bottom of the window are buttons for 'Apply', 'Reset', and 'Close'. The status bar at the very bottom indicates 'Java Applet Window'.

**Figure 189: Attribute screen**

The Attribute screen is where you find out which parity group belongs to which HDD class. The tab also displays information about parity groups, such as parity group usage, logical volume capacity, and RAID type. This screen contains the following items:









- **Monitoring Term:** Displays the monitoring period specified in the Auto LUN main screen, analyzes disk usage information collected by Auto LUN during the monitoring period, and then calculates estimated usage rates of the source and target parity groups after a proposed volume migration.
- **Gathering Time:** Displays the time specified in the Auto LUN Monitoring Options screen. The disk array collects usage statistics about resources (such as hard disk drives) at the specified gathering time. Then Auto LUN uses the collected usage statistics to estimate usage rates of parity groups after a proposed volume migration.
- **Attribute tree:** Lists HDD classes. When you double-click an HDD class icon, a list of parity groups in that HDD class is displayed.
- **Apply button:** Applies the settings in the **Attribute** tab to the disk array.
- **Reset button:** Discards changes in the **Attribute** tab and restores the original settings.
- **Close button:** Closes this screen.
- **Class table fields:** When you click a class in the Attribute tree, the table displays information about parity groups in that class.

PG	HDD	Ave.(%)	Max.(%)	Total	Reserved	Free
 1-1	73FC	30	50	42	3	2
 1-2	73FC	! 20	! 30	42	0	4
 1-3	73FC	50	65	42	2	5
 1-4	73FC	70	100	42	1	0




**Figure 190: Class table fields**

- **PG:** The parity group ID.
- **HDD:** The type of hard disk drive.
- **Ave.:** The average usage rate for the parity group. If an exclamation mark (!) is displayed, the reported usage rate is likely to be inaccurate because the configuration has changed (for example, volumes have been moved by a migration plan or changed by VSC).
- **Max.:** The maximum usage rate for the parity group. If an exclamation mark (!) is displayed, the reported usage rate is likely to be inaccurate.
- **Total:** The total number of logical volumes in the parity group.
- **Reserved:** The number of reserved logical volumes.
- **Free:** The number of logical volumes that have not been reserved yet.

- **Parity group table fields:** When you click a parity group, the table displays information about logical volumes in that parity group.

LDEV	Emulation	Capacity	Ave.(%)	Max.(%)
 0:08	OPEN-9	7.21GB	!10	!20
 0:09	OPEN-9	7.21GB	15	25
 0:0A	OPEN-9	7.21GB	0	0
 0:0B	OPEN-9	7.21GB	0	0
 0:0C	OPEN-9	7.21GB	0	0
 0:0D	OPEN-9	7.21GB	0	0
 0:0E	OPEN-9	7.21GB	0	0
 0:0F	OPEN-9	7.21GB	0	0

**Figure 191: Parity group table fields**




- **Icons:** Indicates a reserved volume () , which can be used as a migration destination; a normal volume () , which cannot be used as a migration destination, or free space () , etc.
- **LDEV:** The logical volume ID.
- **Emulation:** The emulation type of the logical volume.
- **Capacity:** The capacity of the logical volume.
- **Ave.:** The average usage rate for the logical volume. If an exclamation mark (!) is displayed, the reported usage rate is likely to be inaccurate.
- **Max.:** The maximum usage rate for the logical volume. If an exclamation mark (!) is displayed, the reported usage rate is likely to be inaccurate.



## Reserving Target Volumes

To be able to migrate volumes, you must reserve logical volumes as migration destinations (“targets”). You must reserve volumes regardless of migration method (manual or automatic). Migration will not take place if no logical volume is reserved.

### To reserve target volumes:

1. From the Auto LUN main screen, click the **Physical** tab.
2. Click **Plan**. The Manual Migration screen is displayed.
3. Click the **Attribute** tab. The Attribute screen is displayed.

4. In the Attribute tree, locate a logical volume that you want to use as a migration destination. First click an HDD class to display a list of parity groups in that class. Next, click a parity group to display a list of logical volumes in that group.
5. In the table on the right, locate logical volumes preceded by  icons or  icons. From those logical volumes choose the logical volume and right-click.
6. Click **Reserved LDEV** from the pop-up menu. The icon changes to .
7. Click **Apply**. The settings in the screen are applied to the disk array. The specified logical volume is reserved as a migration destination.

If you right-click logical volumes preceded by the  icon (reserved volume) or the  icon (free space) and then click **Normal LDEV** from the pop-up menu, you will not be able to use the volumes as a migration destination.

## Setting (“Fixing”) a Parity Group

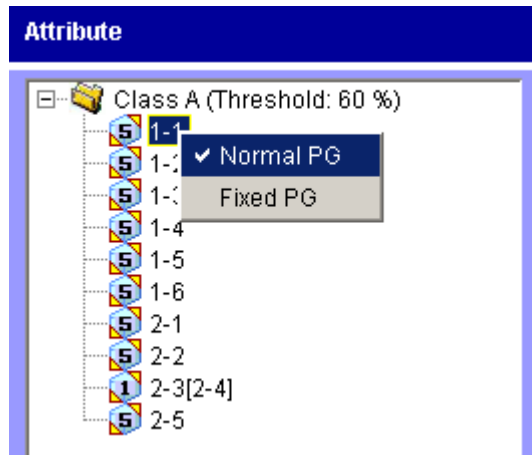
A fixed parity group is one that is excluded by the auto migration function. However, volumes in a “fixed” parity group can be used for manual migration operations.

### To fix a parity group so that it cannot be migrated manually:

1. From the Auto LUN main screen, click the **Physical** tab.
2. Click **Plan**. The Manual Migration screen is displayed.
3. Click the **Attribute** tab. The Attribute screen is displayed.
4. In the tree, double-click an HDD class folder.

The table on the right displays a list of parity groups in the HDD class. An icon indicates parity groups that can include source or target volumes. A different icon indicates “fixed” parity groups, which cannot include source nor target volumes.

5. Right-click the parity group you want to fix.



6. Click **Fixed PG** from the pop-up menu. The parity group becomes “fixed” and is marked with an icon.
7. Click **Apply**.

## Releasing (“Unfixing”) a Parity Group

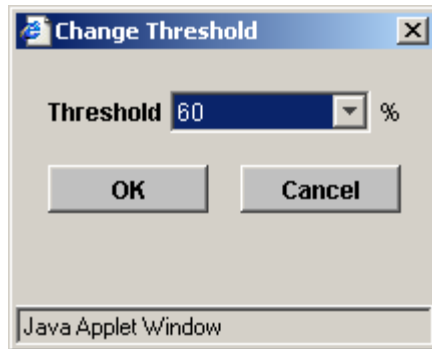
To enable logical volumes in a fixed parity group to be moved to another parity group, change the fixed parity group to be a “normal” parity group. To do this, go to the Attribute screen, right-click the fixed parity group and then click **Normal PG** from the pop-up menu.

## Changing the Maximum Disk Usage Rate for an HDD Class

Each HDD class has a default disk usage rate. This limit affects auto migration behavior. You can change the limit on disk usage rate.

**To change the limit on disk usage rate for an HDD class:**

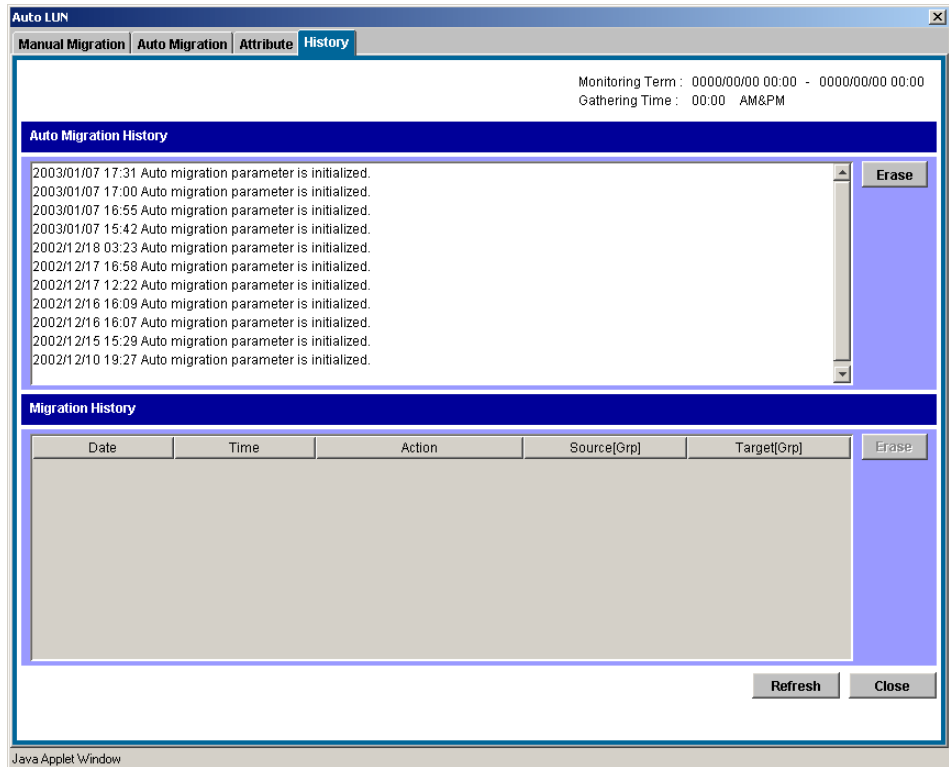
1. From the Auto LUN main screen, click the **Physical** tab.
2. Click **Plan**. The Manual Migration screen is displayed.
3. Click the **Attribute** tab. The Attribute screen is displayed.
4. In the Attribute tree, right-click an HDD class folder and then click **Change Class Threshold** from the pop-up menu. The Change Threshold window is displayed.



**Figure 192: Change Threshold window**

5. Click the value that you want to use as the limit.
6. Click **OK**. In the Attribute tree, the selected value is displayed to the right of the specified class.
7. Click **Apply**. The new limit is applied to the disk array.

## History Screen



**Figure 193: History screen**

Clicking the **History** tab displays information about auto migration operations and manual migration operations in the past. You can find out when migration operations took place and also see whether migration operation finished successfully. This screen contains the following items:

- Monitoring Term:** Displays the monitoring period specified in the Auto LUN main screen, analyzes disk usage information collected by Auto LUN during the monitoring period, and then calculates estimated usage rates of the source and target parity groups after a proposed volume migration.

- **Gathering Time:** Displays the time specified in the Auto LUN Monitoring Options screen. The disk array collects usage statistics about resources (such as hard disk drives) at the specified gathering time. Then Auto LUN uses the collected usage statistics to estimate usage rates of parity groups after a proposed volume migration.
- **Auto Migration History:** Displays log information, showing the creation and execution of auto migration plans.
- **Erase button:** Erases the information in the Auto Migration History pane.
- **Migration History:** Displays logs of volume migration events. The table displays the following information:
  - **Date:** Event date.
  - **Time:** Event time.
  - **Action:** A description of the migration operation or event.
  - **Source:** Source volume and parity group.
  - **Destination:** Target volume and parity group.
- **Refresh button:** Updates information in the **History** tab.
- **Close button:** Closes this screen.

## Viewing the Migration History Log

The History screen displays logs of auto migration operations and manual migration operations.

### To view migration logs:

1. From the Auto LUN main screen, click the **Physical** tab.
2. Click **Plan**. The Manual Migration screen is displayed.
3. Click the **History** tab. The History screen is displayed.

To view logs of auto migration operations, look at **Auto Migration History**.

To view logs of manual migration operations, look at **Migration History**.

The migration logs may display the following messages.



**Normal end of migration:**

Migration Complete (CU:LDEV->CU:LDEV) Start:yyyy/mm/dd hh:min:sec -> End:yyyy/mm/dd hh:min:sec  
(a) (b) (c) (d)

- (a) Source volume
- (b) Target volume
- (c) Copy start time
- (d) Copy end time

**Migration was canceled (over the limit duration):**

Migration Canceled (CU:LDEV->CU:LDEV) Start:yyyy/mm/dd hh:min:sec -> End:yyyy/mm/dd hh:min:sec  
(a) (b) (c) (d)

- (a) Source volume
- (b) Target volume
- (c) Copy start time
- (d) Copy end time

**Migration was canceled (invalid parity group):**

Migration Canceled (CU:LDEV (X-X)->CU:LDEV (X-X)) yyyy/mm/dd hh:min:sec (Invalid Parity Group)  
(a) (b) (c) (d) (e)

- (a) Source volume
- (b) Parity group of the source volume
- (c) Target volume
- (d) Parity group of the target volume
- (e) Canceled time

**Migration was stopped (other reason):**

Migration Stopped (CU:LDEV->CU:LDEV) yyyy/mm/dd hh:min:sec (XXXXXXXXXXXX)

(a) (b) (c) (d)

(a) Source volume

(b) Target volume

(c) Canceled time

(d) Reason for cancellation:

- No reserve volume. No reserved volume is set. Please make another plan.
- Reserve volume emulation is different. The reserved volume's emulation type is different.
- Utilization check. The usage rate is over the limit, or there is no monitor data.
- Migration failed. Error code: XXXX. The migration operation failed.
- Reserve volume size is different. Reserve volume size is different.
- Reserve volume emulation is not supported. The emulation type of reserved volume is not supported.
- Utilization check failed. The check of the usage rate finished abnormally.
- Reserve volume check failed. The check of the reserved volume finished abnormally.

**Migration plan was deleted (because the previous plan had been deleted):**

Migration Plan deleted (CU:LDEV->CU:LDEV) yyyy/mm/dd hh:min:sec (Pre-Plan is deleted)

(a) (b) (c)

(a) Source volume

(b) Target volume

(c) Canceled time

**Started making an auto migration plan:**

yyyy/mm/dd hh:min : MakePlan function starts

(a)

(a) Start time

**Finished making an auto migration plan:**

yyyy/mm/dd hh:min : MakePlan function finishes

(a)

(a) End time

**Output the auto migration plans:**

X plans are output

(a)

(a) Number of plans

**Contents of auto migration plan:**

PlanXXX: Src LDEV CU:LDEV in Grp X-X, Dst LDEV CU:LDEV in Grp X-X

(a)

(b)

(c)

(d)

(e)

(a) Plan number

(b) Source volume

(c) Parity group of the source volume

(d) Target volume

(e) Parity group of the target volume

**Failed making an auto migration plan:**

yyyy/mm/dd hh:min : MakePlan is terminated by error: XXXXXXXXXXXX

(a)

(b)

(a) End time

(b) Reason for failure:

- Cannot make proper migration plan: The program could not make a proper migration plan. Check the number of the reserved volumes and their locations. Check the maximum disk usage and change if necessary.
- Failed to get XXXXXXXXXXXX (information or data): The program failed to get the information or data to make a plan. In the case of information, make the initial value again by selecting [**Initialize**]. In the case of data, check the status of gathered data and get them again.
- Failed to write to XXXXXXXXXXXX (information or data): The program failed to write the information to make a plan.
- Invalid XXXXXXXXXXXX (information or data): The required information/data could not be used because the information was invalid. In the case of information, make the initial value again by selecting [**Initialize**]. In the case of data, check the status of gathered data and get them again.
- Memory allocation error: The program failed to allocate the memory to make the plan.
- "C:\dkc200\others\Auto LUNatm.ini does not exist.": Auto LUN failed to make plans because the Auto LUN atm.ini file did not exist. Click the [**Initialize**] button before making plans again.

**Log entry that the auto migration plan could not be made:**

Cannot make plan: Class X Grp X-X

(a) (b)

(a) Class

(b) Parity group

**Some monitor data samples were invalidated:**

Grp X-X: X samples are invalidated because of migration.

**New volumes have been installed:**

New entries are added for following LDEVs: CU:LDEV, CU:LDEV, ...

**Invalid data:**

Too many invalid data: invalidated all data

**Volume utilization check failed:**

Utilization check failed

Check volume usage failed because the necessary data could not be obtained. Please get the data again.

**Volume reserve attribute check failed:**

Reserve volume check failed

Check volume reserve attribute failed because the necessary data could not be obtained. Please get the data again.

The migration logs may display the following messages:

**Table 47: Migration log messages (XP128/XP1024)**

Message	Meaning
Migration Start	The migration operation started.
Migration Complete	The migration operation completed successfully.

**Table 47: Migration log messages (XP128/XP1024)**

<b>Message</b>	<b>Meaning</b>
Migration Cancel	The user canceled the migration operation.
Migration Failed	The migration operation failed.
Migration Give Up	The migration operation was canceled by Auto LUN (for example volume usage rate exceeded specified maximum).



# Business Copy (BC) for the XP128/XP1024



20

Business Copy (BC) maintains internal copies of user data on the disk array for purposes such as data backup or duplication. The duplicate volumes are created on the same disk array as the primary volume at hardware speeds. BC is used for UNIX and PC server data, and can provide up to nine duplicates of one primary volume.

This chapter provides instructions for performing BC operations using Command View. BC operations are nondisruptive and allow the primary (main) volume of each volume pair to remain online to all hosts for both read and write I/O operations.

After operations have been established, BC operations continue unattended to provide asynchronous internal data backup. Usability is further enhanced through a resynchronization capability that reduces data duplication requirements and backup time, thereby increasing user productivity. BC also supports reverse resynchronization.

BC operations can be performed in conjunction with Continuous Access (CA) operations to provide additional remote copies of BC volumes. BC also supports the VSC and Cache LUN features of the disk array, ensuring that all user data can be duplicated by BC operations. See [Combining BC with Other Data Management Operations](#) on page 523 for further information on combining BC with other data management features.

## Overview of BC Operations

BC is a storage-based hardware solution for duplicating logical volumes that reduces backup time and provides point-in-time backup. The BC primary volumes (P-VOLs) contain the original data; the BC secondary volumes (S-VOLs) contain the duplicate data. The user can make up to nine copies of each P-VOL using the BC cascaded volume function. Because each S-VOL is paired with its P-VOL independently, each S-VOL can be maintained as an independent copy set that can be split, resynchronized, and deleted separately from the other S-VOLs assigned to the same P-VOL.

## BC Components

BC operations on the Command View management station involve the primary and secondary volumes in the disk array. The following figure shows a typical BC configuration. The BC system components are:

- BC pairs (P-VOLs and S-VOLs) (see page 493)
- Command View (see page 495)



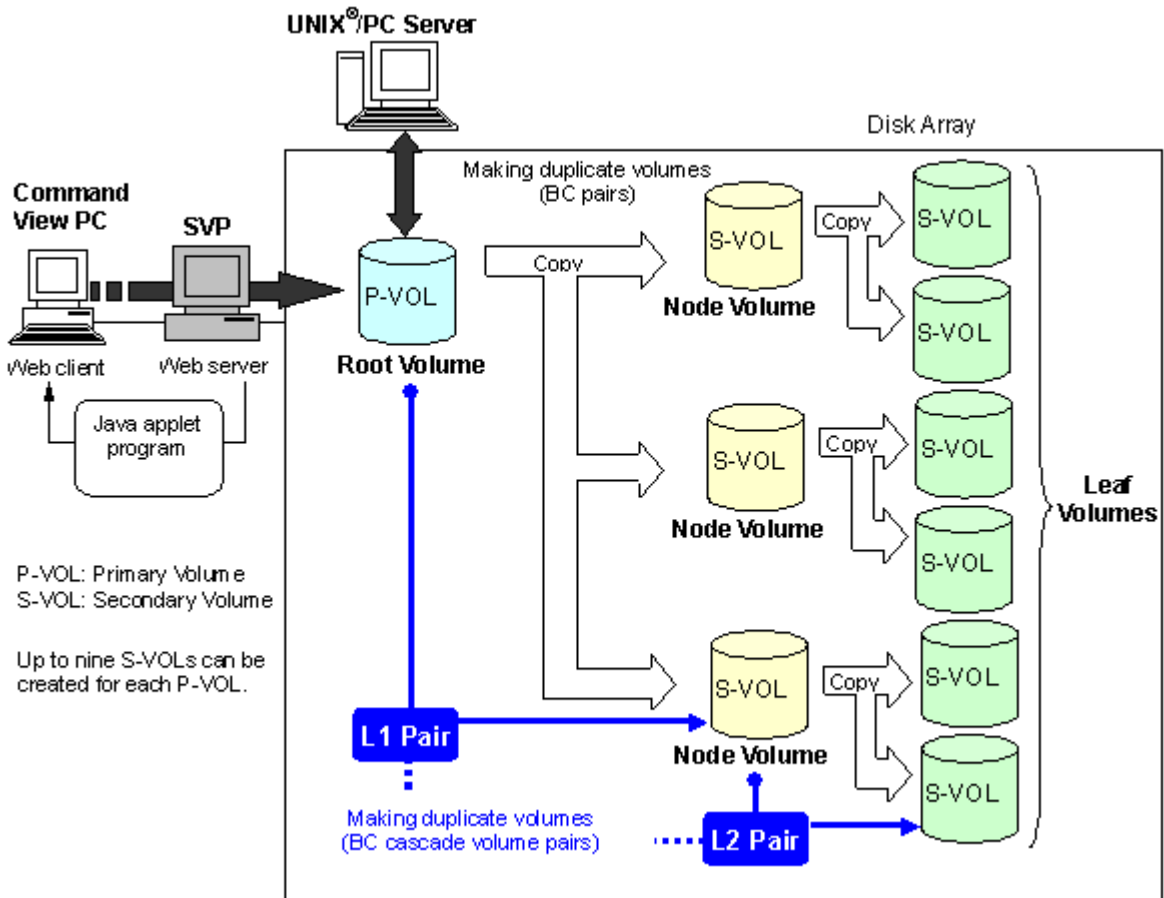


Figure 194: BC overview

## BC Volume Pairs (P-VOLs and S-VOLs)

The disk array contains and manages both the original and copied BC data. The disk array supports a maximum of 8,190 BC volumes: 4,095 pairs and the RAID Manager command device. When BC pairs include size-expanded LUs, the maximum number of pairs decreases. When pairs include more than one S-VOL, the maximum number of P-VOLs decreases.

BC performs internal copy operations for logical volume pairs established by the user. Each BC pair consists of one primary volume (P-VOL) and up to three secondary volumes (S-VOLs) which are located in the same disk array. The BC

P-VOLs are the primary volumes that contain the original data. The BC S-VOLs are the secondary or mirrored volumes that contain the backup data. Each S-VOL must be paired with only one P-VOL. During BC operations, the P-VOLs remain available to all hosts for read and write I/O operations (except during reverse resync and quick restore). The S-VOLs become available for host access only after the pair has been split.

When a BC volume pair is created, the data on the P-VOL is copied to the S-VOL to synchronize the volumes. During this initial copy operation and after the pair is synchronized, all write operations to the S-VOL are prohibited. If you need to access an S-VOL, you can “split” the pair to make the S-VOL accessible (the P-VOL is accessible except during reverse resync). While a BC pair is split, the disk array keeps track of all changes to the P-VOL and S-VOL. When you “resync” the pair, the differential data in the P-VOL (due to P-VOL and S-VOL updates) is copied to the S-VOL so that the S-VOL is again identical to the P-VOL. For reverse resync, the differential data in the S-VOL (due to P-VOL and S-VOL updates) is copied to the P-VOL so that the P-VOL is now identical to the S-VOL.

---

**Note:** BC S-VOLs are updated asynchronously. For a volume pair with PAIR status, the P-VOL and S-VOL may not be identical. For further information on BC update copy operations, please see [Paircreate Operation](#) on page 499.

BC P-VOLs or S-VOLs should not be concentrated in the same RAID group. To disperse workloads of the RAID groups, each RAID group should have both P-VOLs and S-VOLs evenly distributed. BC pairs for which BC operations are performed simultaneously should be in different RAID groups. If BC pairs are concentrated in only a few RAID groups, the host I/O performance may be degraded.

---

If the disk array is overloaded, you must increase cache, disk adapters, and/or RAID groups. Consider assigning BC S-VOLs in newly installed RAID groups. If you continue BC operations with an overloaded disk array, host I/O performance may be degraded.

### **Cascade Pairs**

The BC cascade function adds a second layer of pairs onto the first layer of original BC pairs. Use these two layers of pairs (L1 and L2) to create and maintain up to nine copies of one original BC primary volume (P-VOL). See [Cascade Function](#) on page 510 for further information on the cascade function.

## BC Software on the Command View Management Station

When installed on the Command View management station, the BC software displays BC information and perform BC operations. The Command View management station can be attached to multiple disk arrays. The Command View management station acquires status from and issues commands to both the BC P-VOLs and the BC S-VOLs.

## BC Requirements

BC operations provide disk array-internal copies of UNIX/PC server volumes (LUs) on the disk array. The following table lists and describes the operational requirements for BC.

**Table 48: BC operational requirements**

Parameter	Requirement
Pair objects	Logical devices (LDEVs): OPEN-x (such as OPEN-3, OPEN-9, OPEN-E, or OPEN-V), including custom-size devices and size-expanded LUs. Devices must be installed and configured. The P-VOL and S-VOL must be the same type (for example, OPEN-3 to OPEN-3 allowed, OPEN-3 to OPEN-9 not allowed). A custom-size/expanded P-VOL must be paired with S-VOLs of the same type and same capacity. BC does not support multiplatform devices (for example, 3390-3A, -3B, -3C). Please ask your HP account team for the latest information on supported device types.
Number of copies	Maximum three copies (S-VOLs) per primary volume (P-VOL). Maximum one P-VOL per S-VOL (P-VOLs cannot share an S-VOL). An additional six copies can be created by using the BC cascade function.
Max number of pairs	The total number of BC, ShadowImage (SI390) and Auto LUN volume pairs. For details, refer to <a href="#">Requirements on the Maximum Number of Pairs</a> on page 496.
Max number of S-VOLs	4,095
MU numbers of cascade pairs	For L1 pairs = 0, 1, and 2 (a total of 3 pairs) For L2 pairs = 1 and 2 (a total of 2 pairs)
Combinations of RAID levels (primary-secondary)	All combinations supported: RAID1-RAID1, RAID5-RAID5, RAID1-RAID5, RAID5-RAID1.
Dynamic sparing and automatic correction copy	If a failure occurs that requires the disk array to utilize dynamic sparing or automatic correction copy, the status of the paired volumes associated with the failed physical device will not be affected.

**Table 48: BC operational requirements (Continued)**

Parameter	Requirement
Physical device (PDEV) maintenance	If a PDEV requires maintenance, the status of the logical volumes associated with that PDEV will not be affected. However, if PDEV maintenance requires access to a BC S-VOL, the pair must be deleted, and the <b>Reserve</b> attribute must be reset (unreserved).
Logical device (LDEV) maintenance	LDEV maintenance cannot be performed on LDEVs that are assigned to BC pairs. If LDEV maintenance requires access to a BC LDEV, the pair must be deleted, and the <b>Reserve</b> attribute must be reset (unreserved).
Cache maintenance	If disk array cache maintenance is performed during a period of high I/O usage, one or more BC pairs may be suspended. Reduce the I/O load before cache maintenance.
Point-in-time backup	For pairs in PAIR status, host I/Os are copied to the S-VOLs asynchronously. If you want to synchronize a pair and then access the S-VOL as soon as possible, vary the P-VOL offline and then split the pair before using the S-VOL. If the P-VOL cannot be taken offline, a P.I.T. backup will still occur if a pairsplit is issued. When all the data on the P-VOL (up to the pairsplit time) has been copied to the S-VOL, the pair will be split and the S-VOL will become available for use (R/W). The operation may take longer to complete if high write activity is occurring from the host to the P-VOL. A P.I.T. can also be performed by issuing a pairsplit to P-VOLs in the SMPL (simplex) state.
Failures	When a failure of any kind prevents a BC copy operation from completing, the disk array will suspend the pair. If an LDEV failure occurs, the disk array suspends the pair. If a PDEV failure occurs, BC pair status is not affected because of the RAID architecture.
Maintenance/upgrade	Under certain conditions, BC volume pairs may need to be re-established.

## Requirements on the Maximum Number of Pairs

The number of pairs you can create depends on the emulation type and the capacity of the paired volumes. For details, refer to the following table that shows the number of pairs that can be created with volumes of each emulation type and capacity.

The following table shows the number of pairs that you can create with volumes of same emulation type and capacity. When volumes with different emulation types and capacities are paired, the number of pairs that you can create is determined according to the following condition.

- If a LU consists of one volume (when LUSE is not used):

The maximum number of pairs that can be created is the largest number that meets the equation,  $\Sigma(\alpha) \leq (\beta)$ , where:

$\Sigma(\alpha)$  stands for the total of the number of differential tables per pair, and  $(\beta)$  stands for the number of differential tables in the disk array.

$(\beta) = 2,048$  when the number of CUs is equal to or less than 4

$(\beta) = 4,096$  when the number of CUs is equal to or more than 5

For example, if you create 10 pairs of OPEN-3 volumes and 20 pairs of OPEN-V (60 GB) volumes, the total of the number of differential tables per pair,  $\Sigma(\alpha)$ , would be  $(1 \times 10) + (7 \times 20) = 150$ .

Because 150 is smaller than 2,048 (when the number of CUs is equal to or less than 4) or 4,096 (when the number of CUs is equal to or more than 5), it meets the equation,  $\Sigma(\alpha) \leq (\beta)$ , thus ensuring you that 10 pairs of OPEN-3 volumes and 20 pairs of OPEN-V (60 GB) volumes can be created.

- If a LU consists of more than one volume (when LUSE volumes are used):

The maximum number of pairs that can be created is the largest number that meets the equation,  $[\Sigma(\alpha) \times (\text{number of volumes that configure a LUSE volume})]$  is less than  $(\beta)$ , where:

$\Sigma(\alpha)$  stands for the total of the number of differential tables per pair, and

$(\beta)$  stands for the number of differential tables in the disk array.

$(\beta) = 2,048$  when the number of CUs is equal to or less than 4

$(\beta) = 4,096$  when the number of CUs is equal to or more than 5

For example, if you create 10 pairs of LUSE volumes consisting of three OPEN-3 volumes and 20 pairs of LUSE volumes consisting of five OPEN-V (60 GB) volumes,  $[\Sigma(\alpha) \times (\text{number of volumes that configure a LUSE volume})]$  would be  $(1 \times 3 \times 10) + (7 \times 5 \times 20) = 730$ .

Because 730 is smaller than 2,048 (when the number of CUs is equal to or less than 4) or 4,096 (when the number of CUs is equal to or more than 5), it meets the equation,  $[\Sigma(\alpha) \times (\text{number of volumes that configure a LUSE volume})]$  is less than  $(\beta)$ , thus ensuring you that 10 pairs of OPEN-3 volumes and 20 pairs of OPEN-V (60GB) volumes can be created.

Note that the maximum number of pairs that you can create is limited to the number of volumes that are installed.

**Table 49: Number of Pairs That Can Be Created With Volumes of Each Emulation Type and Capacity**

No.	Volume		No. of differential tables per pair needed for controlling the difference between the primary and secondary volumes	No. of pairs that can be created (If the volumes of the same emulation type and capacity are used to create all the pairs)	
	Emulation Type	Capacity		CUs is 4 or less	CUs is 5 or more
1	OPEN-3	Does not depend on the capacity	1	2,047	4,095
2	OPEN-8	Does not depend on the capacity	1	2,047	4,095
3	OPEN-9	Does not depend on the capacity	1	2,047	4,095
4	OPEN-E	7.2 GB or less	1	2,047	4,095
5		7.3 GB or more	2	1,024	2,048
6	OPEN-L	7.2 GB or less	1	2,047	4,095
7		7.3 GB – 14.4 GB	2	1,024	2,048
8		14.5 GB – 21.6 GB	3	682	1,365
9		21.7 GB – 28.9 GB	4	512	1,024
10		29.0 GB or more	5	409	819
11	OPEN-V	9.6 GB or less	1	2,047	4,095
12		9.7 GB – 19.1 GB	2	1,024	2,048
13		19.2 GB – 28.8 GB	3	682	1,365
14		28.9 GB – 38.5 GB	4	512	1,024
15		38.6 GB– 48.1 GB	5	409	819
16		48.2 GB– 57.8 GB	6	341	682
17		57.9 GB or more	7	292	585
18	OPEN-K	Does not depend on the capacity	1	2,047	4,095

## BC Operations

### Set Reserve Attribute Operation

The BC set reserve attribute operation reserves a volume so it can be used as a BC S-VOL. Reserved volumes can only be used as BC S-VOLs. The disk array rejects all write operations to reserved volumes (unless in split (PSUS) status). You can reserve up to 4,095 volumes in one disk array. Use the Set Reserve Attribute window (see [Setting the Reserve Attribute](#) on page 538) to reserve volumes for use as BC S-VOLs.

A volume might be reserved for BC to ensure it does not become mounted by a server before BC has a chance to use it in a pair. BC cannot use a volume as an S-VOL if it is being used by a server.

---

**Note:** BC leaf volumes (L2 cascade pair) also function as S-VOLs and must be reserved prior to be assigned to an L2 cascade pair.

---

### Reset Reserve Attribute Operation

The BC reset reserve attribute operation unreserves a volume so that it can be mounted and accessed by all hosts. After you reset the reserve attribute, the disk array will accept all subsequent I/O operations to the volume. Use the Reset Reserve Attribute window (see [Resetting the Reserve Attribute](#) on page 539) to unreserve volumes.

### Paircreate Operation

The BC paircreate operation establishes the new specified BC pair(s). The volume that will be the P-VOL must be in the SMPL (simplex) state, and the volume that will be the S-VOL must be SMPL before being added to a BC pair.

---

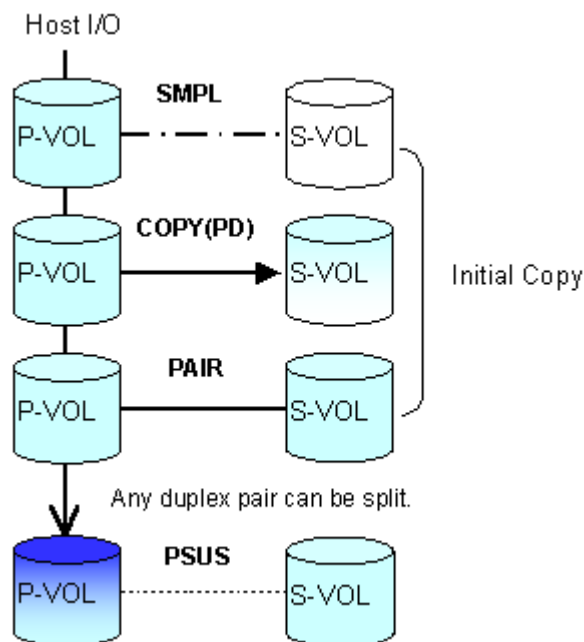
**Note:** You can reserve the S-VOL before creating a pair, but you can also create a pair with an unreserved S-VOL. Use the Paircreate window (see [Creating BC Pairs \(Paircreate\)](#) on page 540) to create new BC volume pairs.

---

## Initial Copy Operation

The BC initial copy operation takes place when you create a new volume pair (see the following figure). The BC initial copy operation copies all data on the P-VOL to the associated S-VOL. The P-VOL remains available to all hosts for read and write I/Os throughout the initial copy operation. Write operations performed on the P-VOL during the initial copy operation will be duplicated at the S-VOL by update copy operations after the initial copy is complete. The status of the pair is COPY(PD) (PD = pending) while the initial copy operation is in progress. The status changes to PAIR when the initial copy is complete.

When creating pairs, you can select the pace for the initial copy operation(s): slower, medium, and faster. The slower pace minimizes the impact of BC operations on disk array I/O performance, while the faster pace completes the initial copy operation(s) as quickly as possible.



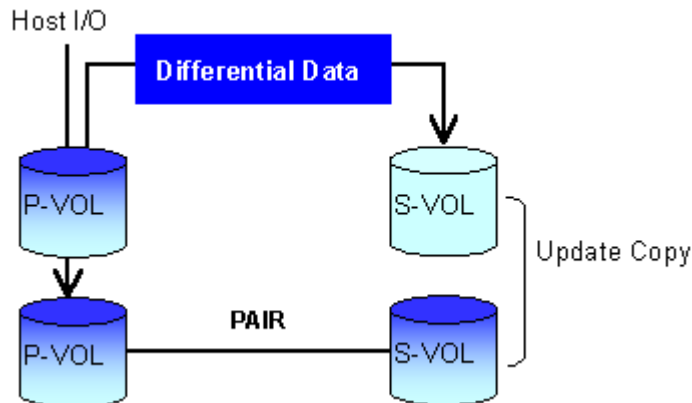
**Figure 195: Adding a pair in BC**



## Update Copy Operation

The BC update copy operation updates the S-VOL of a BC pair after the initial copy operation is complete. Update copy operations take place only for duplex pairs (status = PAIR). As write I/Os are performed on a duplex P-VOL, the disk array stores a map of the P-VOL differential data, and then performs update copy operations periodically based on the amount of differential data present on the P-VOL as well as the elapsed time between update copy operations. The following figure illustrates an update copy operation in a BC pair with only one S-VOL. Update copy operations are not performed for pairs with the following status: COPY(PD) (*pending duplex*), COPY(SP) (*steady split pending*), PSUS(SP) (*quick split pending*), PSUS (*split*), COPY(RS) (*resync*), COPY(RS-R) (*resync-reverse*), and PSUE (*suspended*).

Update copy operations do not occur every time a host issues a write I/O operation to the P-VOL of a BC pair. BC update copy operations are performed asynchronously according to the differential bitmap, which is stored in shared memory. If shared memory is lost (for example, offline micro exchange, volatile PS on), the differential bitmap is also lost. In this case the disk array treats the entire BC P-VOL (S-VOL for COPY(RS) pairs) as difference data and recopies all data to the S-VOL (P-VOL for COPY(RS) pairs) to ensure proper pair resynchronization. For pairs with COPY(SP) or PSUS(SP) status, the disk array changes the status to PSUE due to the loss of the differential bitmap, also ensuring proper resynchronization of these pairs. If shared memory has been lost, please allow extra time for BC operations.



**Figure 196: Update Copy operation**

### Cascade Function

The BC cascade function creates a second layer of BC volume pairs (L2) underneath the first layer of BC pairs (L1). Cascade pairs are created by clicking **Cascade** instead of **Set** in the Paircreate window (see [Creating BC Pairs \(Paircreate\)](#) on page 540). This cascade layering scheme creates up to nine copies of one BC P-VOL. See [Cascade Function](#) on page 510 for further information on cascade pairs and the cascade function.

### Pairsplit Operation

The BC split capability provides point-in-time backup of your data, and also facilitates real data testing by making the BC copies (S-VOLs) available for host access. The BC pairsplit operation performs all pending S-VOL updates (those issued prior to the split command and recorded in the P-VOL track map) to make the S-VOL identical to the state of the P-VOL when the split command was issued, and then provides full read/write access to the split S-VOL. You can split existing pairs as needed, and you can also use the pairsplit operation to create and split pairs in one step.

Use the Pairsplit window (see [Splitting BC Pairs \(Pairsplit\)](#) on page 545) to split existing BC pairs, or to add and split new BC pairs in one step. When the split operation is complete, the pair status changes to PSUS, and you have full read/write access to the split S-VOL (even though it is still reserved). While the pair is split, the disk array establishes a track map for the split P-VOL **and** S-VOL and records all updates to **both** volumes. The P-VOL remains fully accessible during the pairsplit operation. Pairsplit operations cannot be performed on suspended (PSUE) pairs.

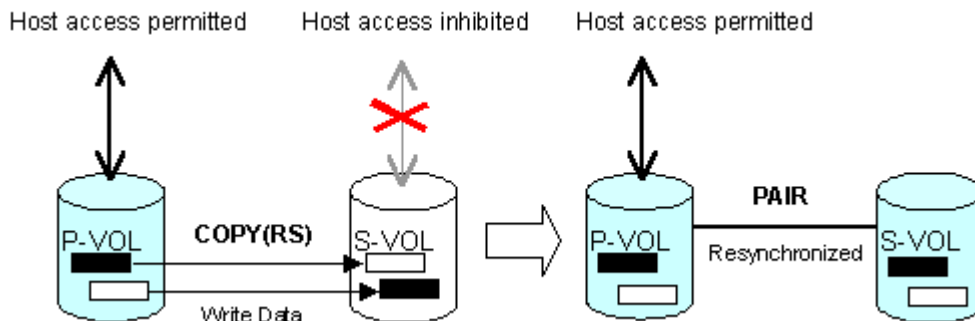
- When splitting pairs, you can select the pace for the pending update copy operation(s): **Slower**, **Medium**, and **Faster**. The slower pace minimizes the impact of BC operations on disk array I/O performance, while the faster pace splits the pair(s) as quickly as possible.
- When splitting pairs, you can also select the split type: **Quick Split** or **Steady Split**.
  - When the quick split operation starts, the pair status changes to PSUS(SP), and the S-VOL is available immediately for read and write I/Os (even though it is still reserved). The disk array performs all pending update copy operations to the S-VOL in the background. When the quick split is complete, the pair status changes to PSUS.

- When the steady split operation starts, the pair status changes to COPY(SP), and the disk array performs all pending update copy operations to the S-VOL. When the Steady Split operation is complete, the pair status changes to PSUS, and you have full read/write access to the split S-VOL (even though it is still reserved).

## Pairresync Operations

BC can perform four types of pairresync operations:

- **Normal.** The normal pairresync operation (see the following figure) resynchronizes the S-VOL with the P-VOL. The copy direction for a normal pairresync operation is P-VOL to S-VOL. The pair status during a normal resync operation is COPY(RS), and the P-VOL remains accessible to all hosts for both read and write operations during a normal pairresync.
- **Quick.** The quick pairresync operation speeds up the normal pairresync operation without copying the P-VOL data to the S-VOL. The P-VOL and the S-VOL are resynchronized when update copy operations are performed for duplex pairs (status = PAIR). The pair status during a quick pairresync operation is PSUS(SP) until the differential map is copied, and the P-VOL remains accessible to all hosts for both read and write operations. The S-VOL becomes inaccessible to all hosts during a quick pairresync operation.



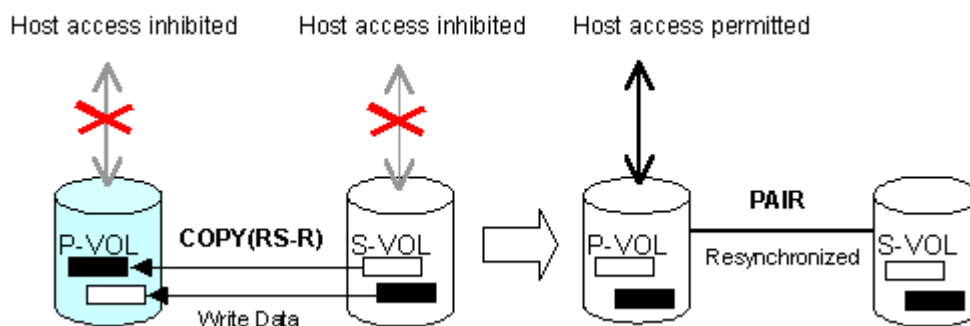
**Figure 197: Normal and quick pairresync operations**

- **Reverse.** The reverse pairresync operation (see the following figure) synchronizes the P-VOL with the S-VOL. The copy direction for a reverse pairresync operation is S-VOL to P-VOL. The following table lists the operational requirements for the reverse pairresync operation. The pair status during a reverse resync operation is COPY(RS-R), and the P-VOL and S-VOL become inaccessible to all hosts for write operations during a reverse

pairresync operation. As soon as the reverse pairresync is complete, the P-VOL becomes accessible. The reverse pairresync operation can only be performed on split pairs, not on suspended pairs. The reverse pairresync operation cannot be performed on L2 cascade pairs.

**Note:** The P-VOL remains read-enabled during the reverse pairresync operation only to enable the volume to be recognized by the host. The data on the P-VOL is not guaranteed until the reverse pairresync operation is complete and the status changes to PAIR.

- Quick Restore.** The quick restore operation (see the following figure) speeds up reverse resync by changing the volume map in the disk array to swap the contents of the P-VOL and S-VOL without copying the S-VOL data to the P-VOL. The P-VOL and S-VOL are resynchronized when update copy operations are performed for pairs in the PAIR status. The pair status during a quick restore operation is COPY(RS-R) until the volume map change is complete. The P-VOL and S-VOL become inaccessible to all hosts for write operations during a quick restore operation. Quick restore cannot be performed on L2 cascade pairs. The following table lists the operational requirements for the quick restore operation.



**Figure 198: Reverse and quick restore pair operations**

**Note:** The P-VOL remains read-enabled during the quick restore operation only to enable the volume to be recognized by the host. The data on the P-VOL is not guaranteed until the quick restore operation is complete and the status changes to PAIR.



**Caution:** During a quick restore operation, the **RAID levels, HDD types, and Cache LUN settings** of the P-VOL and S-VOL are exchanged. For example, if the P-VOL has a RAID-1 level and the S-VOL has a RAID-5 level, the quick restore operation changes the RAID level of the P-VOL to RAID-5 and of the S-VOL to RAID-1.

---

**To avoid any performance impact due to the quick restore operation:**

1. Make sure that the P-VOL and S-VOL have the same RAID level and HDD type before performing the quick restore operation. If you want to restore the original RAID levels after quick restore, stop host I/Os to the pair, split the pair, perform the quick restore operation for that pair again, and then restart the host I/Os to the pair.
2. Because the Cache LUN settings are exchanged during a quick restore operation, you must perform one of the two following operations. If you do not, the change of location of the cache residence areas may cause I/O performance to the Cache LUN data to be down.
  - a. Set the same Cache LUN settings (locations) for the P-VOL and S-VOL before performing the quick restore operation.
  - b. Release the Cache LUN settings of the P-VOL and S-VOL before the quick restore operation, and then reset the Cache LUN settings of the P-VOL and S-VOL after the pair changes to PAIR status as a result of the quick restore operation.

If you do not want the P-VOL and S-VOL to be resynchronized after the quick restore operation, you must set the Swap&Freeze option before performing the quick restore operation (see [Swap&Freeze Option](#) on page 509 and [Setting BC Options](#) on page 558).

**Table 50: BC pairresync parameter requirements**

Parameter	Requirement(s)
Reverse and quick restore pairresync commands.	<p>The specified pair must be in the PSUS state. If not, the reverse or quick restore pairresync command will be rejected.</p> <p>All other pairs that share the same P-VOL as the specified pair must also be in the PSUS or PSUE state. If not, the reverse or quick restore pairresync command will be rejected.</p>
Reverse or quick restore pairresync command issued to a shared BC/CA volume.	<ol style="list-style-type: none"> <li>1. If the BC P-VOL is also a CA P-VOL, the reverse and quick restore pairresync operations cannot be performed. (The command will be rejected.)</li> <li>2. If the BC P-VOL is also a CA S-VOL, the reverse and quick restore pairresync operations cannot be performed. (The command will be rejected.)</li> <li>3. If the BC S-VOL is also a CA P-VOL, the reverse and quick restore pairresync operations cannot be performed. (The command will be rejected.)</li> <li>4. During the reverse or quick restore pairresync operation, a CA pair cannot be created. The CA paircreate command will be rejected when the BC pair status is COPY(RS-R).</li> </ol>
Effect on other pairs that share the P-VOL.	<p>If the reverse or quick restore pairresync operation is performed on one BC pair in a 1-to-n BC configuration (<math>n &gt; 1</math>), the P-VOL and the other S-VOLs are no longer synchronized. While this reverse or quick restore pairresync is in progress, you cannot perform paircreate, pairsplit, or pairresync for any other pair that shares the same P-VOL (pairsplit-S and pairsplit-E are allowed).</p>
Reverse or quick restore resync ends abnormally; OR, Pairsplit-E (PSUE) is requested during reverse or quick restore resync.	<ol style="list-style-type: none"> <li>1. The pair status changes to PSUE.</li> <li>2. The P-VOL of the PSUE pair is read- and write-enabled for all hosts; however, the data on the P-VOL is not guaranteed. The S-VOL of the PSUE pair remains write-disabled (read-only); however, the data on the S-VOL is not guaranteed.</li> <li>3. The status of other BC pairs that share the same P-VOL does not change.</li> </ol>

Use the Pairresync window (see [Resynchronizing BC Pairs \(Pairresync\)](#) on page 549) to resynchronize split and suspended BC pairs. When the pairresync operation starts, the pair status changes to COPY(RS) or COPY(RS-R). When the pairresync is complete, the pair status changes to PAIR. The disk array resumes BC update copy operations after the pair status changes to PAIR. The P-VOL remains fully accessible during a normal pairresync operation, but becomes inaccessible to all hosts during a reverse or quick restore pairresync operation. This ensures that the data on the P-VOL is identical to the data on the S-VOL when the reverse or quick restore pairresync operation completes.

When resynchronizing pairs, you can select the pace for the pairresync operation(s): slower, medium, or faster. The slower pace minimizes the impact of BC operations on disk array I/O performance, while the faster pace resynchronizes the pair(s) as quickly as possible.

BC can perform normal/quick pairresync operations on split and suspended pairs, but reverse/quick restore pairresync operations can only be performed on split pairs:

- **Pairresync for split pair.** When a normal/quick pairresync operation is performed on a split pair (status = PSUS), the disk array copies all flagged tracks from the P-VOL to the S-VOL. When a reverse or quick restore pairresync operation is performed on a split pair, the disk array copies all flagged tracks from the S-VOL to the P-VOL. This ensures that the P-VOL and S-VOL are properly resynchronized in the desired direction, and also greatly reduces the time needed to resynchronize the pair.
- **Pairresync for suspended pair.** When a normal/quick pairresync operation is performed on a suspended pair (status = PSUE), the disk array copies all data on the P-VOL to the S-VOL, because all P-VOL tracks were flagged as difference data when the pair was suspended. Reverse and quick restore pairresync operations cannot be performed on suspended pairs. The normal pairresync operation for suspended pairs is equivalent to and takes as long as the BC initial copy operation.

## Pairsplit-E Operation (Suspend)

The BC pairsplit-E operation suspends the BC copy operations to the S-VOL of the pair. The user can suspend a BC pair at any time. When a BC pair is suspended (status = PSUE), the disk array stops performing BC copy operations to the S-VOL, continues accepting write I/O operations to the P-VOL, and marks the entire P-VOL track as difference data. When a pairresync operation is performed on a suspended pair, the entire P-VOL is copied to the S-VOL. While the pairresync operation for a split BC pair can be very fast, the pairresync operation for a suspended pair takes as long as the initial copy operation. The reverse and quick restore pairresync operations cannot be performed on suspended pairs.

The disk array will automatically suspend a BC pair when it cannot keep the pair mirrored for any reason. When the disk array suspends a pair, sense information is generated to notify the host. The disk array will automatically suspend a pair under the following conditions:

- When the volume pair has been suspended (PSUE) or deleted (SMPL) from an open system host using the RAID Manager command line interface.

- When the disk array detects an error condition related to an initial copy operation. When a volume pair with COPY(PD) status is suspended (PSUE), the disk array aborts the initial copy operation, changes the status of the P-VOL and S-VOL to SMPL, accepts all subsequent write I/Os to the S-VOL, and does not keep track of updates.
- When the disk array detects an error condition related to an update copy operation.
- When the P-VOL and/or S-VOL track map in shared memory is lost (for example, due to offline microprogram exchange). This applies to COPY(SP) and PSUS(SP) pairs only. For PAIR, PSUS, COPY(RS), or COPY(RS-R) pairs, the pair is not suspended but the entire P-VOL (S-VOL for reverse or quick restore pairresync) is marked as difference data.

Use the Pairsplit-E window (see [Suspending BC Pairs \(Pairsplit-E\)](#) on page 552) to suspend BC pairs. When a pair is suspended, the status changes to PSUE. When the pairresync operation starts, the pair status changes to COPY(RS). The P-VOL remains fully accessible while suspended and during the pairresync operation.

### Pairsplit-S Operation (Delete)

The BC pairsplit-S operation (delete pair) stops the BC copy operations to the S-VOL of the pair and changes the pair status of both volumes to SMPL. The volumes are not deleted. A BC pair can be deleted at any time except during the quick pairsplit operation (or any status except SMPL status and PSUS(SP) status). After you delete a BC pair, the S-VOL is still not available for write operations until the reserve attribute is reset.

Use the Pairsplit-S window (see [Deleting BC Pairs \(Pairsplit-S\)](#) on page 554) to delete BC pairs. When a BC pair is deleted, pending update copy operations for the pair are discarded, and the status of the P-VOL and S-VOL is changed to SMPL.



**Caution:** The S-VOL of a duplex pair (PAIR status) may not be identical to its P-VOL, due to the asynchronous BC update copy operations. See [Deleting BC Pairs \(Pairsplit-S\)](#) on page 554 for instructions on synchronizing the volumes before deleting the pair.

---



## BC Options

By using the BC options, you can extend the standard BC operations such as the paircreate and pairresync operations. The following table shows the options that are currently available.

**Table 51: BC options types and requirements**

No.	Option Type	Requirement
1	Swap&Freeze	The BC quick restore operation can be performed on the disk array. If the disk array setting disables the quick restore operation, you must change the setting (that is, enable the quick restore operation in your disk array) before using the Swap&Freeze option. Refer to <a href="#">Swap&amp;Freeze Option</a> on page 509.
2	Host I/O Performance	Refer to <a href="#">Host I/O Performance Option</a> on page 510.
3 - 32	Reserved (Currently unavailable.)	-

---

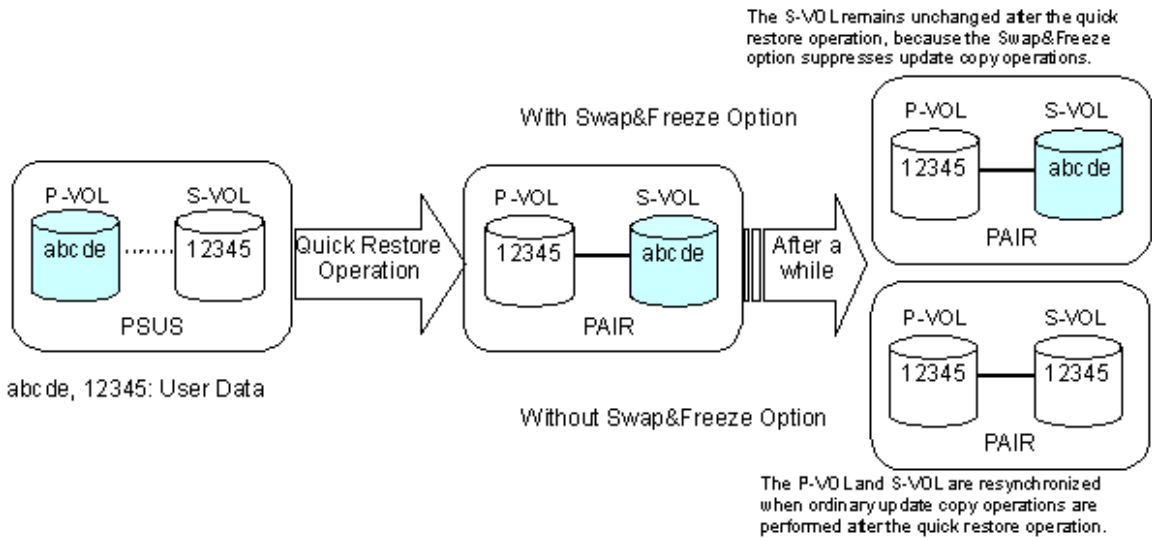
**Note:** The number of available option types depends on the user's disk array settings.

---

### Swap&Freeze Option

The Swap&Freeze option allows the S-VOLs of a BC pair to remain unchanged after the quick restore operation. If the quick restore operation is performed on a BC pair with the Swap&Freeze option, update copy operations are suppressed, thus not performed for pairs in the PAIR status after the quick restore operation. If the quick restore operation is performed without the Swap&Freeze option, the P-VOL and S-VOL are resynchronized when update copy operations are performed for pairs in the PAIR status.

The following figure shows the state of the S-VOL after the quick restore operation with or without the Swap&Freeze option.



**Figure 199: Quick Restore operation with or without Swap&Freeze option**

## Host I/O Performance Option

The Host I/O Performance option improves host I/O responses over SI390 copying processing time. When the Host I/O Performance option is used, the disk array suppresses execution of SI390 copying processing, and consequently the host I/O responses improve.

When SI390 copying processing is suppressed by the Host I/O Performance option, the time taken for copying increases. Also, if BC pairs exist, host I/O responses might not be faster. In this case, set the Host I/O Performance option for BC as well.

## Cascade Function

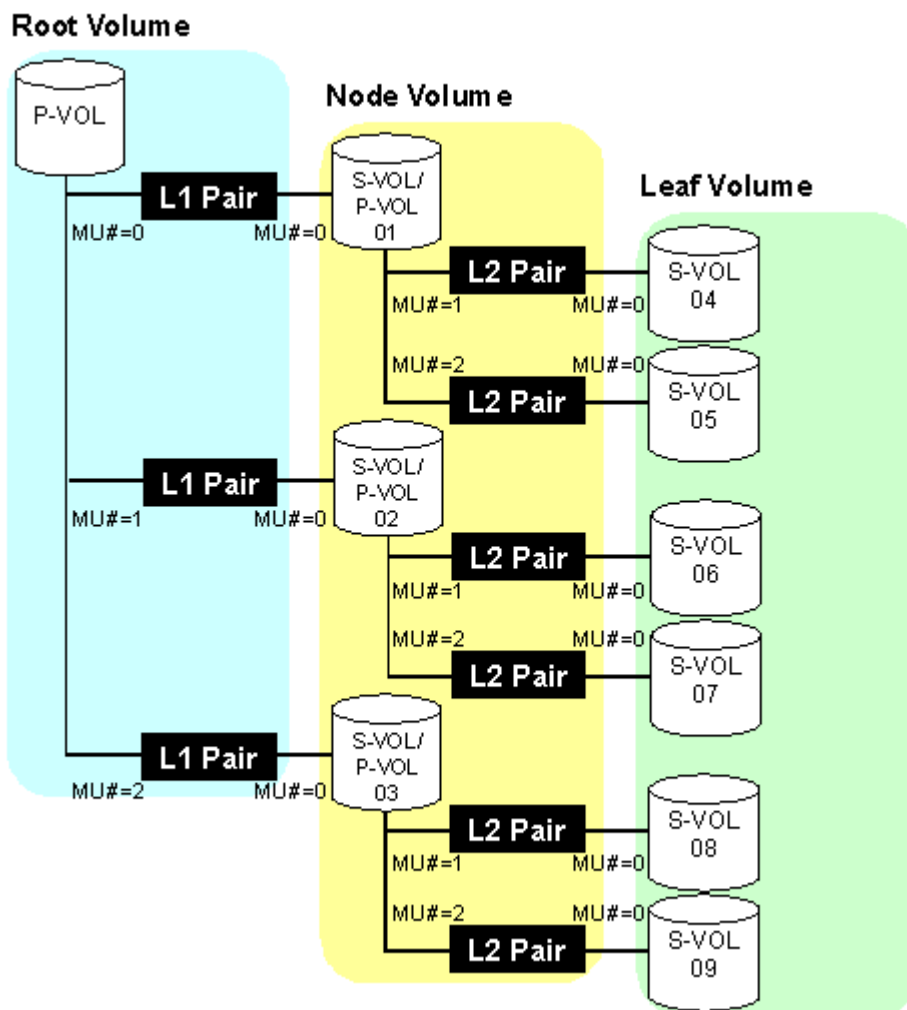
The BC cascade function creates a second layer of volume pairs underneath the first layer of BC pair(s). The following figure illustrates cascaded BC volume pairs. The first cascade layer (L1) is the original BC pair, which consists of one P-VOL (root volume) and up to three S-VOLs (node volumes). In the second cascade layer (L2), the S-VOLs of the original BC pair function as the P-VOLs of the L2 pairs, and each L2 P-VOL can have up to two S-VOLs (leaf volumes). This layering scheme can create up to nine copies of one BC primary volume (P-VOL).

Every volume can have up to three Mirror Unit (MU) numbers associated with it. The MU number designates a pair for which the volume is a member. The MU number is not the number of the pair, but of the volume. A pair is made up of two volumes of which each pair member could have the same or different MU numbers.

- MU=0 is the number of a volume for its first pair.
- MU=1 is the number of the same volume for its next pair.
- MU=2 is the number of the same volume for its third pair.
- The MU number of an S-VOL is always MU=0.

For Level 1 (L1) pairs, the root volume could have MU=0, MU=1, and MU=2. For L1 pairs, the associated S-VOLs would all have MU=0 because this would be the first pair of which they are a member.

For the Level 2 (L2) pairs, the L1 S-VOLs are now all acting as L2 P-VOLs. Because they are already a member of one pair, the next MU number for each of them is MU=1 for their first L2 pair and MU=2 for their second L2 pair. For the S-VOLs associated with each of these pairs, the MU number is once again MU=0 because this is the first pair of which they are a member.



**Figure 200: Cascade pairs**

When L1 and L2 cascade pairs are created, the P-VOLs and S-VOLs of the cascade pairs are classified using the following terms (as shown in the previous figure):

- The **root volume** is the P-VOL of the L1 pair, which is the original BC pair. You can add up to three S-VOLs (node volumes) to a root volume.

- The **node volume** is the S-VOL (reserved) of an L1 pair and the P-VOL of an L2 pair. You can add up to two S-VOLs (leaf volumes) to a node volume.
- The **leaf volume** is the S-VOL (reserved) of an L2 cascade pair.

The following table shows the relationship between the L1 pair status and the availability of BC pair operations on the associated L2 pairs. To split an L2 pair, you must first split the L1 pair (L1 status = PSUS). The reverse and quick restore pairresync operations cannot be used for L2 pairs. The table after next shows the relationship between the L2 pair status and the availability of pair operations on the associated L1 pairs. (CMD RJT = command rejected.) If you delete an L1 pair that contains an L2 pair, the L2 pair becomes the L1 pair.

**Note:** Combination of L1 and L2 pairs with the CA volumes is allowed; however, node volumes and leaf volumes are both considered secondary volumes (S-VOLs) by CA.

**Table 52: Relationship between L1 pair status and L2 pair operations**

L1 Pair Status	L2 Pair Operations					
	Paircreate	Pairsplit	Pairresync	Reverse/ Quick Restore	Pairsplit-E	Pairsplit-S
COPY(PD)	OK	NO (CMD RJT)	OK	NO (CMD RJT)	OK	OK
PAIR	OK	NO (CMD RJT)	OK	NO (CMD RJT)	OK	OK
COPY(SP)	OK	NO (CMD RJT)	OK	NO (CMD RJT)	OK	OK
PSUS(SP)	OK	NO (CMD RJT)	OK	NO (CMD RJT)	OK	OK
PSUS	OK	OK	OK	NO (CMD RJT)	OK	OK
COPY(RS)	OK	NO (CMD RJT)	OK	NO (CMD RJT)	OK	OK
COPY(RS-R)	OK	NO (CMD RJT)	OK	NO (CMD RJT)	OK	OK
PSUE	OK	NO (CMD RJT)	OK	NO (CMD RJT)	OK	OK

**Table 53: Relationship between L2 pair status and L1 pair operations**

L2 Pair Status	L1 Pair Operations					
	Paircreate	Pairsplit	Pairresync	Reverse/ Quick Restore	Pairsplit-E	Pairsplit-S
COPY(PD)	OK <sup>1</sup>	OK	OK	OK	OK	OK
PAIR	OK <sup>1</sup>	OK	OK	OK	OK	OK
COPY(SP)	NO (CMD RJT)	NO (CMD RJT)	NO (CMD RJT)	NO (CMD RJT)	OK	OK
PSUS(SP)	NO (CMD RJT)	NO (CMD RJT)	NO (CMD RJT)	NO (CMD RJT)	OK	OK
PSUS	OK <sup>1</sup>	OK	OK	OK	OK	OK
COPY(RS)	OK <sup>1</sup>	OK	OK	OK	OK	OK
PSUE	OK <sup>1</sup>	OK	OK	OK	OK	OK

1. MU# of L2 node pair member must be 1 or 2.

The read/write operation to each volume (root, node or leaf volume) from the host is enabled or disabled depending on the status of L1/L2 pairs. The read/write operation from the host can always be performed to the root volume regardless of the status of L1/L2 pairs. The following table indicates the relationship between read/write operation from the host to the node volume and the status of L1/L2 pairs. The table after next indicates the relationship between read/write operation from the host to the leaf volume and the L2 pair status.

**Table 54: Read/write operation (host to the node volume) and L1/L2 pair status**

L1 Pair Status	L2 Pair Status					
	COPY(PD)	PAIR	COPY(SP)	PSUS(SP)/ PSUS	COPY(RS)	PSUE
COPY(PD)	Read Only	Read Only	Read Only	Read Only	Read Only	Read Only
PAIR	Read Only	Read Only	Read Only	Read Only	Read Only	Read Only
COPY(SP)	Read Only	Read Only	Read Only	Read Only	Read Only	Read Only
PSUS(SP)/ PSUS	Read/Write	Read/Write	Read/Write	Read/Write	Read/Write	Read/Write
COPY(RS)	Read Only	Read Only	Read Only	Read Only	Read Only	Read Only
COPY(RS-R)	Read Only	Read Only	Read Only	Read Only	Read Only	Read Only
PSUE	Read Only	Read Only	Read Only	Read Only	Read Only	Read Only

**Table 55: Read/write operation (host to the leaf volume) and L2 pair status**

COPY	L2 Pair Status				
	PAIR	COPY(SP)	PSUS(SP)/PSUS	COPY(RS)	PSUE
Read Only	Read Only	Read Only	Read/Write	Read Only	Read Only

## At-Time Split Function

In the past, a BC pair group split each LUN pair in the group at a slightly different time. If the application data spanned multiple LUNs in the group, there was the chance of data corruption unless the application was stopped before the split. With the At-Time Split function, the LUN pairs are split at the same time within the group, which keeps the data consistent without having to stop the application.

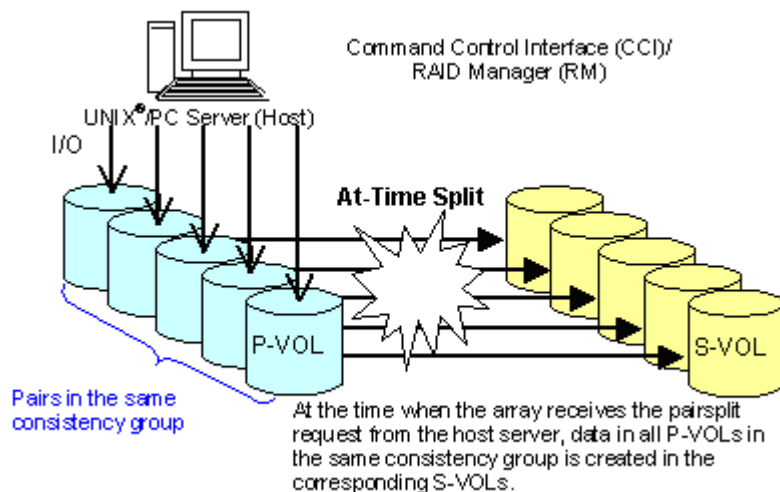
At this time, the At-Time Split operation is performed using Raid Manager on the UNIX/PC server host. You can use Command View to perform BC pair operations At-Time Split pairs created by Raid Manager. However, the At-Time Split option in Command View is disabled.

The At-Time Split function applies to BC pairs that belong to a consistency group, and creates S-VOLs of all P-VOLs in the same consistency group, at the time when the pairsplit command is executed.

A BC consistency group is a user-defined set of BC volume pairs used for the At-Time Split function and have the following restrictions:

- You can configure up to 128 consistency groups in a disk array, including the ShadowImage consistency groups.
- A number (0–127) is assigned to each consistency group. You can specify a consistency group number when you create BC pairs. If you do not specify a number, then the disk array assigns a number automatically.
- You can define up to 1,024 BC pairs in a consistency group. However, for LUSE volumes that contain n LDEVs, you should count as n volumes.
- The BC pairs and the ShadowImage pairs cannot co-exist in the same consistency group.
- To configure BC consistency groups, you can only use the RAID Manager software. However, to confirm the BC consistency group numbers, you can use BC (see [Volume List Box](#) on page 530).

When the At-Time Split function is enabled, data in all P-VOLs in the same consistency group is copied in the corresponding S-VOLs at the time when the disk array receives the pairsplit request from the host server. The following figure shows an overview of the At-Time Split function.



**Figure 201: Overview of At-Time Split function**

#### To enable the At-Time Split function using Raid Manager:

1. Create BC At-Time Split pairs as follows:
  - a. Define a consistency group for the BC pairs. You cannot define the L1 and L2 cascade pairs (see [Cascade Function](#) on page 510) that share the same node volume in a consistency group. If you specify such pairs in the same consistency group, the paircreate command will be rejected.
  - b. Specify the At-Time Split option.
  - c. Execute the paircreate command.
2. Execute the pairsplit command on the created BC At-Time Split pairs.

The At-Time Split option is enabled, and data in all P-VOLs in the same consistency group is copied in the corresponding S-VOLs at the time when the pairsplit request is received by the disk array.

When the pairsplit operation by Raid Manager ends abnormally, all the BC pairs in the same consistency group will be suspended (status = PSUE).



When the host server is down or has failed, a consistency group with no BC pairs definition might occur. If you execute the paircreate command with the At-Time Split option (-m) under such a condition, the paircreate command might be rejected. In this case, first find a consistency group number that is not used by any pairs on the BC main screen by sorting the **CTG** column (see [Volume List Box](#) on page 530). Next, specify that consistency group number explicitly and execute the paircreate command with the At-Time Split option using Raid Manager on the host server.

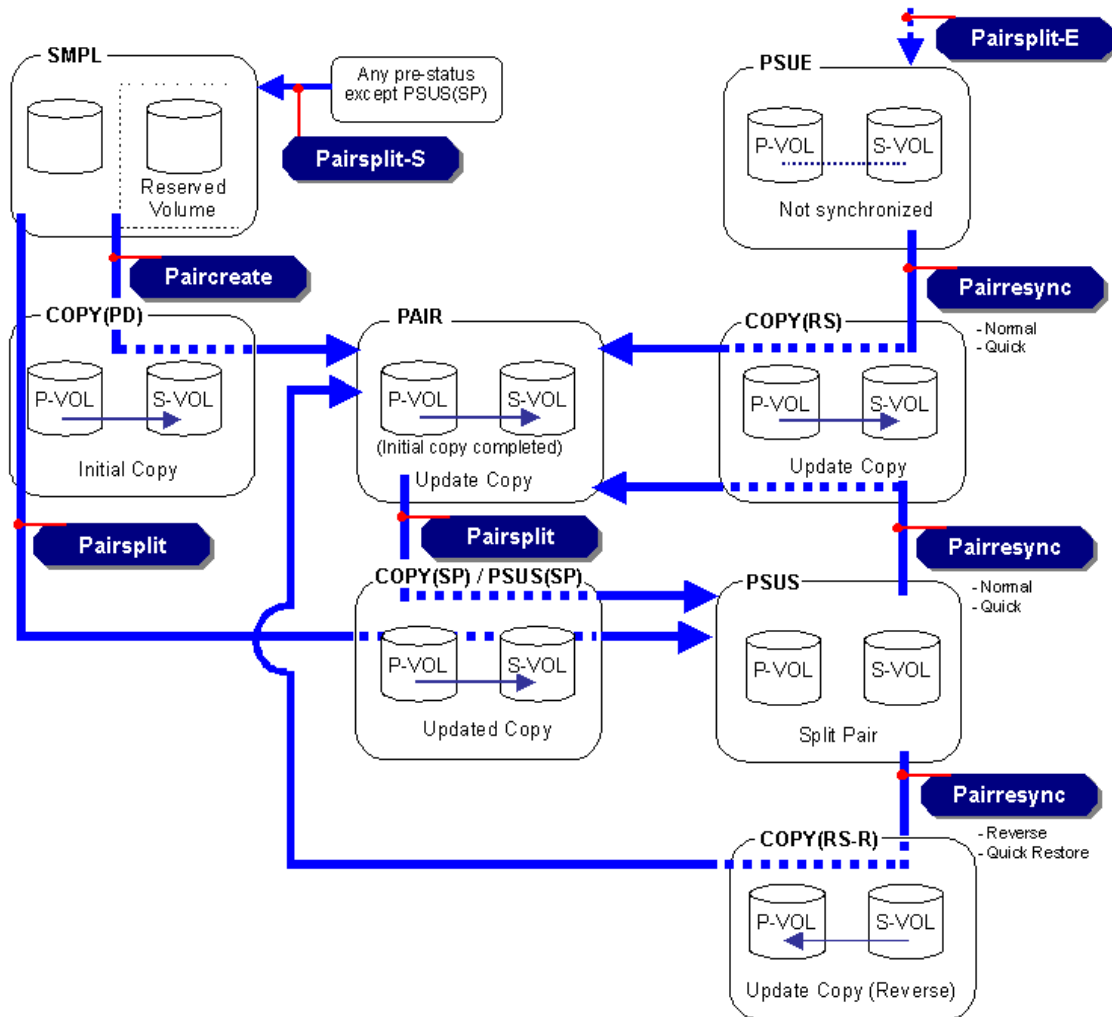
---

**Note:** Just after the pairsplit, response time of the first I/O to each logical unit (LU) can be up to approximately five seconds in the worst case. This worst case should be in a one to three BC pair situation and 36 LDEV LUSE configuration.

---

## Pair Status

The BC remote console software displays the pair status of all BC volumes (LUs) on the specified port of the connected disk array. The following figure illustrates the BC pair status transitions and the relationship between the pair status and the BC operations.



**Figure 202: BC pair status transitions**

The following table lists and describes the BC pair status conditions. If a volume is not assigned to a BC pair, its status is SMPL. When you create a BC pair, the status of the P-VOL and S-VOL changes to COPY(PD). When the initial copy operation is complete, the pair status becomes PAIR. If the disk array cannot maintain PAIR status for any reason, or if you suspend the pair (pairsplit-E), the pair status changes to PSUE. When you split a pair (pairsplit), the pair status

changes to COPY(SP) or PSUS(SP) for quick pairsplit. When the pairsplit operation is complete, the pair status changes to PSUS and you will have access the split S-VOL. When you start a pairresync operation, the pair status changes to COPY(RS). When you specify reverse or quick restore mode for a pairresync operation, the pair status changes to COPY(RS-R) (data is copied in the reverse direction from the S-VOL to the P-VOL). When the pairresync operation is complete, the pair status changes to PAIR. When you delete a pair (pairsplit-S), the pair status changes to SMPL.

**Table 56: BC pair status conditions**

Pair Status	Description	S-VOL Access
SMPL	The volume is not assigned to a BC pair. The disk array accepts read and write I/Os for all SMPL volumes that are not reserved.	N/A (there is no S-VOL yet).
COPY(PD)	The initial copy operation is in progress. The disk array continues to accept read and write operations for the P-VOL but stops accepting write operations for the S-VOL. No update copy operations are performed.	Read only.
PAIR	The initial copy operation is complete, and the disk array starts performing asynchronous update copy operations from the P-VOL to the S-VOL as needed. The P-VOL and S-VOL of a duplex pair (PAIR status) may not be identical. The disk array rejects all write I/Os for S-VOLs with the status PAIR.	Read only.
COPY(SP)	The status becomes COPY(SP) when the steady split mode is selected for the pairsplit operation. All P-VOL updates prior to the pairsplit command are being copied to the S-VOL. When these updates are complete, the split S-VOL is identical to the state of the P-VOL when the split started. The disk array rejects all write I/Os for COPY(SP) S-VOLs.	Read only.
PSUS(SP)	The status becomes PSUS(SP) when the quick split mode is selected for the pairsplit operation. Only the P-VOL differential data is being copied to the S-VOL in background. The disk array accepts writes for PSUS(SP) S-VOLs. The PSUS(SP) pairs cannot be deleted.	Read and write. The S-VOL can be mounted.
PSUS	The disk array stops performing update copy operations for PSUS (split) pairs, and starts accepting write I/Os for PSUS S-VOLs. The disk array keeps track of all updates to the split P-VOL and S-VOL, so that the pair can be resynchronized quickly.	Read and write. The S-VOL can be mounted.

**Table 56: BC pair status conditions (Continued)**

Pair Status	Description	S-VOL Access
COPY(RS)	The disk array does not accept write I/Os for COPY(RS) S-VOLs. When a split pair is resynchronized in normal mode, the disk array copies only the P-VOL differential data to the S-VOL. When a PSUE (suspended) pair is resynchronized, the disk array copies the entire P-VOL to the S-VOL. No update copy operations are performed during the pairresync operation.	Read only.
COPY(RS-R)	The disk array does not accept write I/Os for COPY(RS-R) S-VOLs. When a split pair is resynchronized in reverse or quick restore mode, the disk array copies only the S-VOL differential data to the P-VOL. No update copy operations are performed during the reverse or quick restore pairresync operation.	Read only.
PSUE	The disk array continues accepting read and write I/Os for a PSUE (suspended) P-VOL, but does not perform update copy operations to a PSUE S-VOL. The disk array marks the entire P-VOL track map as difference data, so that the entire P-VOL is copied to the S-VOL when the PSUE pair is resumed. Use the pairresync command to resume a PSUE pair.	Read only.

## Cautions on Switching Off the Power Supply

If you need to switch off the power supply of the disk array during BC operations, make sure to:

- Complete copying for the BC pair in the COPY(SP) status first to change the pair status from COPY(SP) to PSUS, and then switch off the power supply. If the shared memory is volatilized when you switch on the power supply again, the pair in the COPY(SP) status changes to PSUE.
- Establish a timetable for BC copying operations. If the shared memory is volatilized when you switch on the power supply again, the following conditions occur:
  - If the BC pair was in the COPY(PD) or COPY(SP) status, data that was already copied becomes the target data to be copied after the power supply is turned back on. Even if there is no host I/O, the data consistency rate does not reach 100% when the BC pair status changes to PAIR. When the BC pair status changes to PAIR, the target data is copied to the secondary volume.

- If the BC pair was in the PAIR status, data that was already copied becomes the target data to be copied after the power supply is turned back on. In this case, the data consistency rate is 0%, and the target data is copied to the secondary volume.
- If the BC pair was in the PSUS status, the entire volume becomes the differential data. In this case, the data consistency rate is 0%, and the entire volume is copied to the secondary volume when you perform the pairresync operation.

## Preparing for BC Operations

### System Requirements

BC operations involve the disk array containing the primary and secondary volumes and the licensed BC feature enabled on the Command View management station. The system requirements for BC are:

- Disk array. Disk array hardware, microcode, and software required for BC operations must be installed and enabled.
- Command View management station (user-supplied Windows-based PC).
- BC license key installed.

### Preparing for BC Operations

To ensure that you and your disk array(s) are ready for BC operations, you should perform the following tasks to prepare for BC operations:

- BC operations affect the I/O performance of the disk array because of the copy operations to the S-VOLs. If you have not already done so, you should consider the relative importance of the disk array's I/O performance and the BC backup copies. For example, assigning three S-VOLs to each P-VOL takes more resources than assigning only one or two. You can also use the copy pace option to control the impact of the BC initial copy operations. Using a slower copy pace minimizes the impact of BC operations on I/O performance, while a faster copy pace produces copies more quickly but may affect I/O performance.
- If you are using more than one disk array data management feature (such as BC, CA, or Cache LUN) at the same time in the same disk array, please contact HP technical support to ensure that your disk array is optimized for your configuration of concurrent operations. Each disk array feature can affect the performance of the disk array and/or the operation of other features. For example, BC and CA operations both involve initial copy operations and update copy operations to the secondary/remote volumes in addition to the host I/O workload.
- Identify the volumes (LUs) that you will be using for BC operations. For each volume, write down the full SCSI path (port, target ID (TID), LUN), whether the volume will be a P-VOL or S-VOL, and the other volume(s) in its pair (see the following table for a sample table). LUN Management displays this

information. The volumes that will be P-VOLs will remain fully accessible to all hosts throughout normal BC operations, but the volumes that will be S-VOLs will need to be unmounted before being reserved for BC operations.

**Table 57: Identifying the volumes for BC operations**

CU	Port	TID: LUN	L1 P-VOL	Assoc. L1 S-VOL(s)	L1 S-VOL	Assoc. L1 P-VOL	L2 P-VOL	Assoc. L2 S-VOL(s)	L2 S-VOL	Assoc. L2 P-VOL
0	1A	0:00	Yes	1B-0:00, 2A-0:00, 2B-0:00	No	--	No	--	No	--
0	1A	0:01	Yes	1B-0:01, 2A-0:01, 2B-0:01	No	--	No	--	No	--
etc.										
0	1B	0:00	No	--	Yes	1A-0:00	Yes	3A-0:00, 3A-0:01	No	--
0	1B	0:01	No	--	Yes	1A-0:01	Yes	3B-0:00, 3B-0:01	No	--
etc.										
0	2A	0:00	No	--	Yes	1A-0:00	Yes	4A-0:00, 3B-0:01	No	--
0	2A	0:01	No	--	Yes	1A-0:01	Yes	4B-0:00, 3B-0:01	No	--
etc.										
0	3A	0:00	No	--	No	--	No	--	Yes	1B-0:00
0	3A	0:01	No	--	No	--	No	--	Yes	1B-0:00

## Combining BC with Other Data Management Operations

BC supports concurrent operations with the following data management functions:

- LU Size Expansion (LUSE).** LUSE volumes can be assigned to BC pairs, provided that the P-VOL and S-VOL have the same LU type and the same number of LDEVs (same size). If you need to perform LUSE operations on an existing BC P-VOL or S-VOL, you must delete the pair first to return the volume to SMPL status.

- **VSC.** VSC volumes can be assigned to BC pairs, provided that the S-VOL has the same capacity as the P-VOL. If you need to perform VSC operations on an existing BC P-VOL or S-VOL, you must delete the pair first to return the volume to SMPL status.
- **LUN Security.** LUN Security operations do not affect BC operations. Volumes that are under secure ports and/or that are assigned to World Wide Name (WWN) groups and/or LUN groups can also be assigned to BC pairs. Volumes that are assigned to BC pairs can also be assigned to secure ports, WWN groups, and/or LUN groups for LUN Security.

---

**Note:** BC S-VOLs cannot be accessed by any host except when the pair is split.

---

- **Cache LUN.** Cache LUN volumes can be assigned to BC pairs, and Cache LUN operations can be performed on BC P-VOLs and S-VOLs.



**Caution:** See [Pairresync Operations](#) on page 503 for important information on performing quick restore operations on Cache LUN volumes.

---

- **CA.** CA volumes can be assigned to BC pairs, and BC volumes can be assigned to CA pairs. See [Combining BC and CA Operations](#) on page 524 for important information on BC and CA shared volume configurations.

## Combining BC and CA Operations

BC and CA can function together in the same disk array to provide both internal and remote backup for your important data.

---

**Note:** Combination of BC L1 and L2 pairs with CA volumes is allowed. Node volumes and leaf volumes are both considered secondary volumes (S-VOLs) by CA.

---

---

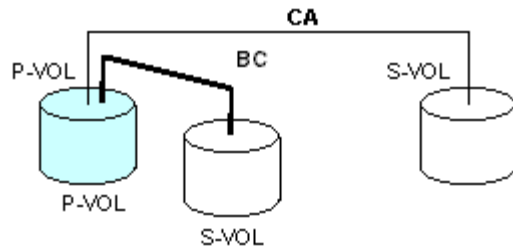
**Note:** Reverse resync and quick restore operations cannot be performed on BC/ CA shared volume pairs.

---



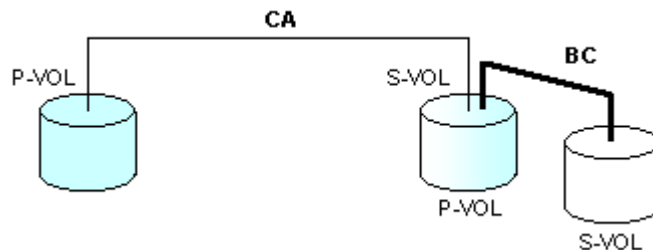
The configuration shown in the following figure is an example of a volume that is functioning as both a CA P-VOL and a BC P-VOL. With this configuration, you can:

- Use BC to provide on-site backup copies of CA P-VOLs, and/or
- Use CA to provide remote backup copies of BC P-VOLs.



**Figure 203: BC and CA: shared P-VOL/P-VOL**

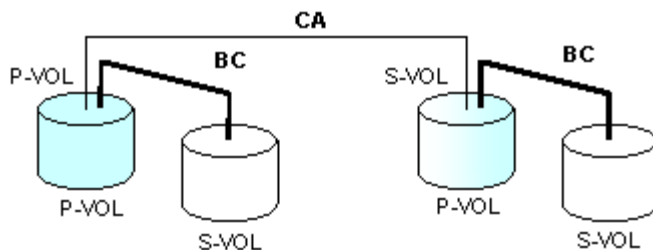
The configuration shown in the following figure is an example of a volume that is functioning as both a CA S-VOL and a BC P-VOL. With this configuration, you can use BC to provide remote copies of CA S-VOLs.



**Figure 204: BC and CA: shared P-VOL/S-VOL**

The configuration shown in the following figure is an example of a volume that is functioning as both a CA P-VOL and a BC P-VOL, while the S-VOL of the same CA pair is also functioning as the P-VOL of another BC pair. With this configuration, you can:

- Use BC to provide on-site backup copies of CA P-VOLs and S-VOLs, and/or
- Use CA to provide remote backup of BC P-VOLs.



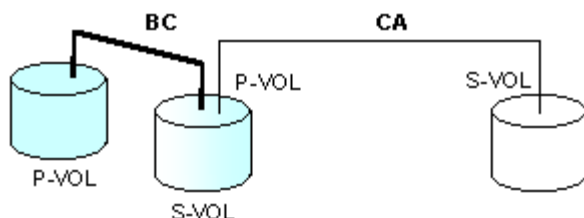
**Figure 205: BC and CA: shared P-VOL/P-VOL and P-VOL/S-VOL**

The configuration shown in the following figure is an example of a volume that is functioning as both a BC S-VOL and a CA P-VOL. With this configuration, you can use CA to provide asynchronous remote copy.

---

**Note:** This configuration does not allow BC and CA to copy at the same time. Create the BC pair first, and then split the pair before creating the CA pair. You must suspend the CA pair to resync the BC pair. The CA pair status cannot be changed when the BC pair is in the PSUS(SP) status.

---



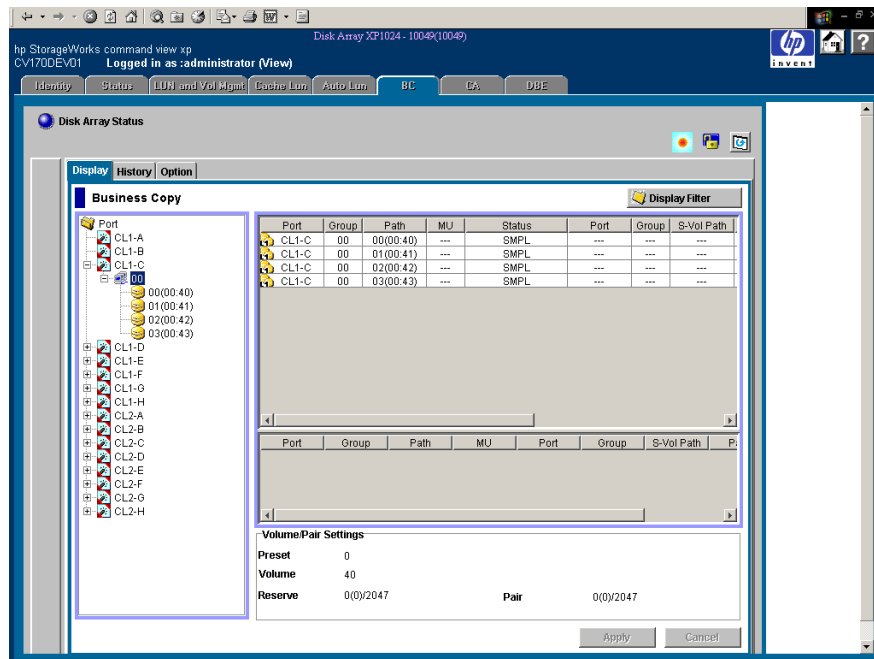
**Figure 206: BC and CA: shared S-VOL/P-VOL**

## Starting BC

After you have enabled the feature the Command View management station and prepared for BC operations, you are ready to start BC.

### To start BC:

1. From the Launch screen, click an XP128 or XP1024.
2. Click the **BC** tab. The BC main screen displays the name of the connected disk array, the currently selected port, and all of the volumes (LUs) installed under the current port.



**Figure 207: BC main screen**

You are now ready to perform BC operations. You will first need to reserve the volumes that you plan to use as BC S-VOLs (see [Setting the Reserve Attribute](#) on page 538 for instructions), and then you can start adding the BC pairs (see [Creating BC Pairs \(Paircreate\)](#) on page 540 for instructions).

## BC Main Screen

The BC main screen displays BC volume and pair information for the selected port of the connected disk array and performs all BC operations. To open the BC main screen, click the **BC** tab. There are three tabs on the BC main screen:

**Display**, **History**, and **Option** tabs.

The **Display** tab of the BC main screen has the following features:

- Use the **Tree View** box on the left side to select the port, host group, or defined P-VOL (pair).






---

**Note:** You can filter the volumes or volume pairs displayed in the Volume List box on the upper-right side of the **Display** tab, by selecting a port, a host group or a volume (P-VOL) at a time. To display all volumes and pairs, click **Port** at the top of the Tree View box.

---

- The **Volume List** box on the upper-right side displays all available volumes on the port, host group, or P-VOL that you select in the Tree View box. You can sort the volumes by port, group, path, MU#, status, port (S-VOL), group (S-VOL), S-VOL path, copy pace, progress of copying, volume emulation type, and capacity. You can also filter the volumes by reserve attribute, by pair condition, and pair status in the Display Filter window. To open the Display Filter window, click **Display Filter**, or click the **Display Filter** command from the pop-up menu.
- The following icons indicate the status of a volume or pair:

**Table 58: Status icons for BC**

Icon	LDEV status
	L1 pair
	L2 pair
	S-VOL (Node volume: <b>Secondary</b> , Leaf volume: <b>Leaf</b> )
	Reserved volume
	An error occurred during operations. This error icon is displayed in the Preset Volume List box.

- The **Volume/Pair Settings** box on the lower-right side displays:

- **Preset:** The number of operations (volume/pair information), which have not been performed in the disk array. The Preset Volume List box, which is located below the Volume List box, displays the preset operations. Click **Apply** to perform the specified operations displayed in the Preset Volume List box.
- **Volume:** The total number of volumes defined in the disk array.
- **Reserve:** X(Y)/Z, where X = total number of BC reserved volumes  
Y = total number of BC reserved vols  
Z = maximum allowable number of reserved volumes
- **Pair:** X(Y)/Z, where X = total number of BC pairs  
Y = total number of BC pairs  
Z = maximum number of pairs (BC/HHSM)

---

**Note:** The value (Y) does not include HHSM pairs. If HHSM pairs exist, it is possible for the BC paircreate operation to fail even when (Y) is less than 4,095.

---

- Use the **Display Filter** button to filter the volumes displayed in the Volume List box.
- The **Apply** button performs the BC operations displayed in the Preset Volume List box in the disk array. If the specified operations complete successfully, the Preset Volume List box will be cleared. If an error occurs during an operation, the failed operation will remain in the Preset Volume List box. You can display the error code and message for the failed operation by selecting the **Detail** command.
- The **Cancel** button cancels all operations specified on the **Display** tab.

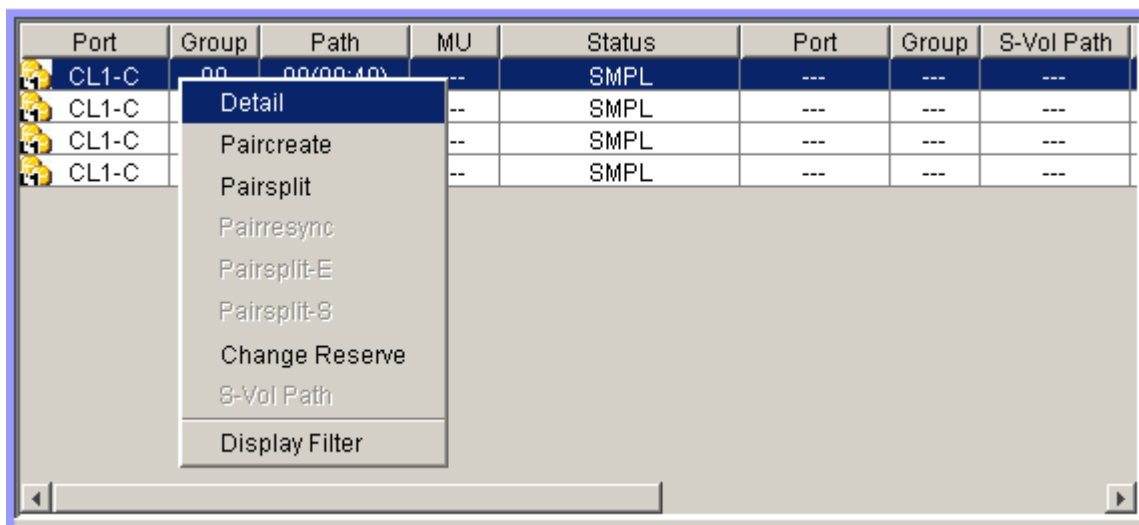
To perform BC operations for the volume(s), select one or more volumes in the Volume List box, right-click to display the pop-up menu commands (**Detail**, **Paircreate**, **Pairsplit**, **Pairresync**, **Pairsplit-E**, **Pairsplit-S**, **Change Reserve**, **S-Vol Path**, and **Display Filter**), and then select the command (see [Volume List Box](#) on page 530 and the following table).

For information about the **History** and **Option** tabs of the BC main screen, refer to [Viewing BC Pair Status and History](#) on page 556 and [Setting BC Options](#) on page 558.

## Volume List Box

The Volume List box (see the following figure) displays volume/pair information based on the filter options you select in the Tree View box (along the left side of the screen).

**Note:** You can select up to 512 volumes/pairs at a time in the Volume List box.



**Figure 208: Volume List box**

The Volume List box lists all installed volumes (LUs) on the selected port and displays the following information for each volume:

- **Port:** The port ID (cluster and channel number) of each volume. If the L2 pairs exist, an icon of the different shape is displayed. To display detailed information on the L2 pairs, double-click the corresponding S-VOL in the Volume List box.
- **Group:** The host group of each volume.
- **Path:** The CU:LDEV (control unit image:logical device ID) of each volume.
- **MU:** The MU number of a BC cascade pair formed with the volume.

- **Status:** The BC pair status of the volume pair: **SMPL**, **COPY(PD)**, **PAIR**, **PSUS**, **COPY(RS)**, **PSUE**, **COPY(SP)**, **COPY(RS-R)**, **PSUS(SP)**, **Secondary**, and **Leaf**.
- **Port:** The port ID (cluster and channel number) of the first S-VOL of each volume. If there is no S-VOL, --- is displayed.
- **Group:** The host group of the S-VOL. If there is no S-VOL, --- is displayed.
- **S-Vol Path:** The CU:LDEV (control unit image:logical device ID) of the S-VOL. If there is no S-VOL, --- is displayed.
- **CTG:** The consistency group number of the S-VOL. If no consistency group is set for the S-VOL, --- is displayed.
- **SvolMode:** The status of the S-VOL is displayed.
  - **S-VOL Write:** When the S-VOL status is **COPY(SP)**, **PSUS(SP)**, or **PSUS** and the host writes to the S-VOL, **W** is displayed.
  - **Hide Mode:** When the S-VOL is set to the hide mode, **N** is displayed.
- **Copy Pace:** The copy pace (**Slower**, **Medium**, or **Faster**) for the pair being created is displayed.
- **Progress:** If the volume pair is in the **COPY** status, the progress (%) of copying is displayed (for example, **0%** or **45%**). If there is no S-VOL, --- is displayed.
- **Type:** The device emulation type (for example, **OPEN-3** or **OPEN-K**).
- **Capacity (MB):** The storage capacity of the volume in MB.

You can perform BC operations for the volume(s) in the Volume List box, by using the following pop-up menu commands (see also the following table):

- **Detail** command: Displays pair status for the selected volume(s)/pair(s).
- **Paircreate** command: Creates or adds new BC pairs.
- **Pairsplit** command: Splits BC pairs.
- **Pairresync** command: Resynchronizes BC pairs.
- **Pairsplit-E** command: Suspends BC pairs.
- **Pairsplit-S** command: Deletes BC pairs.
- **Change Reserve** command: Sets and resets the BC reserve attribute.
- **S-Vol Path** command: Displays the S-VOL's port, group, and path (LUN) of the selected pair.

- **Display Filter** command: Filters the volumes displayed in the Volume List box. Clicking **Display Filter** is another method of accessing this command.

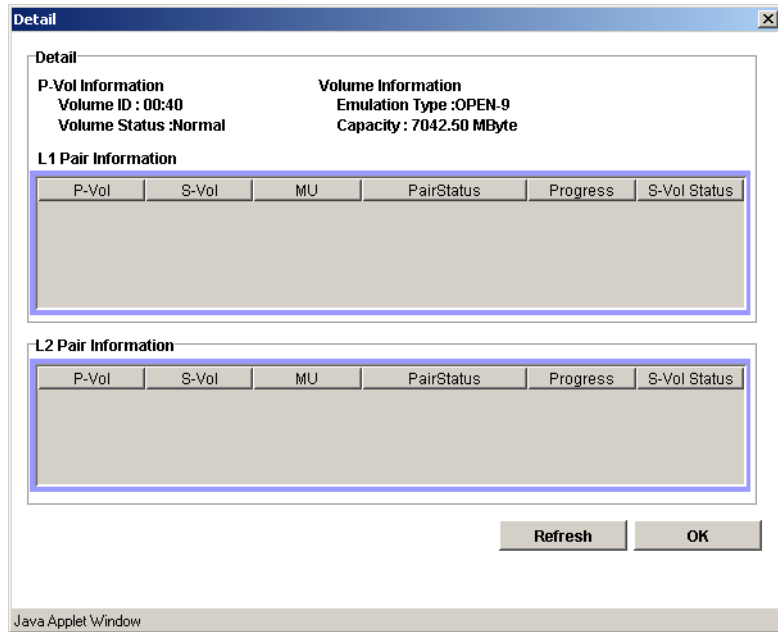
**Table 59: BC operations pop-up menu commands**

Operation	Pair Status								
	SMPL	COPY (PD)	PAIR	COPY (SP)	PSUS (SP)	PSUS	COPY (RS)	COPY (RS-R)	PSUE
Detail	Yes	Yes	Yes	Yes	Yes	Yes	Yes	Yes	Yes
Paircreate	Yes	No	No	No	No	No	No	No	No
Pairsplit	Yes	Yes	Yes	No	No	No	No	No	No
Pairresync	No	No	No	No	Yes	Yes	No	No	Yes
Pairsplit-E	No	Yes	Yes	Yes	Yes	Yes	Yes	Yes	No
Pairsplit-S	No	Yes	Yes	Yes	No	Yes	Yes	Yes	No
Change Reserve	Yes	No	No	No	No	No	No	No	No
S-Vol Path	No	Yes	Yes	Yes	Yes	Yes	Yes	Yes	Yes

## Detail Window

The Detail window displays information for the selected volume or pair. To open the Detail window, select a pair or volume in the Volume List box, right-click to display the pop-up menu, and then click **Detail**. If the P-VOL of the selected pair has two or more S-VOLs that share the same P-VOL, the Detail window displays all the S-VOLs.

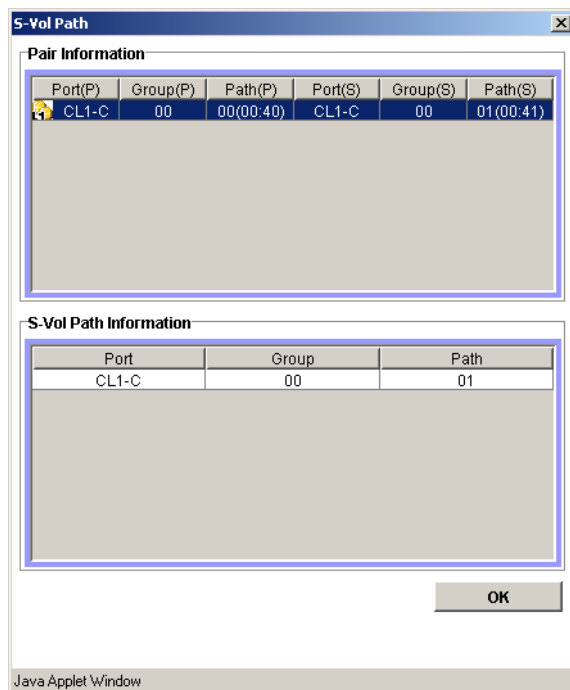




**Figure 209: Detail window**

## S-Vol Path Window

The S-Vol Path window displays information on the selected pair (all paths defined for the S-VOL). To open the S-Vol Path window, select one or more pair in the Volume List box, right-click to display the pop-up menu, and then click **S-Vol Path**.



**Figure 210: S-Vol Path window**

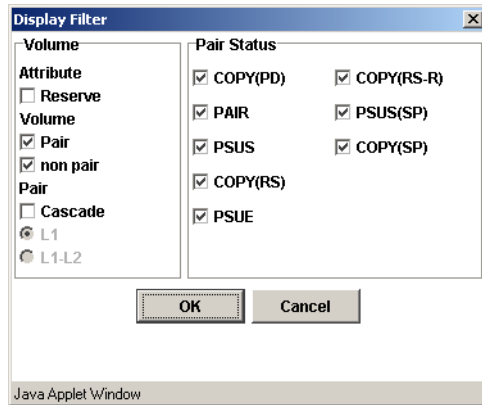
---

**Note:** The **S-Vol Path** command is not available when selecting SMPL volumes.

---

## Display Filter Window

Use the Display Filter window to filter the volumes displayed in the Volume List box by reserve attribute, by pair condition, and by pair status. To open the Display Filter window, click **Display Filter** on the BC main screen, or select any pair or volume in the Volume List box, right-click to display the pop-up menu, and then click **Display Filter**.



**Figure 211: Display Filter window**

The Display Filter window has the following features:

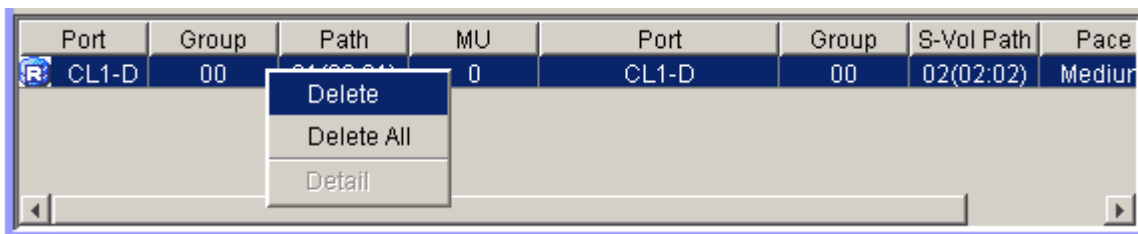
- The **Volume** box:
  - The **Reserve** check box displays reserved or unreserved volumes. If you select the **Reserve** check box, only reserved volumes are displayed in the Volume List box. If you clear the **Reserve** check box, only unreserved volumes are displayed.
  - The **Pair** check box displays paired volumes.
  - The **non pair** check box displays non-paired volumes.
  - The **Cascade** check box filters the pairs in the Volume List box by cascade level. Clicking **L1** displays L1 pairs only. Clicking **L1-L2** displays both L1 and L2 pairs.
- Use the **Pair Status** box to filter the pairs displayed in the Volume List box by pair status: **COPY(PD)**, **PAIR**, **PSUS**, **COPY(RS)**, **PSUE**, **COPY(RS-R)**, **PSUS(SP)**, and **COPY(SP)**. All check boxes are selected by default.
- The **OK** button applies the settings, and closes the Display Filter window.
- The **Cancel** button resets the settings, and closes the Display Filter window.

**Note:** The filter settings are only effective within the current BC session. If you switch to another program feature (such as LUN Management or CA), or click a button on the toolbar, the settings will be reset.

## Preset Volume List Box

The Preset Volume List box (see the following figure) is located below the Volume List box, and lists the specified operations (volume/pair information) that have not been performed in the disk array.

Use the Preset Volume List box to hold multiple settings of the same operation only. You cannot display different types of operations (for example, pairsplit and pairresync) in the Preset Volume List box at the same time. You can also cancel the operations in the Preset Volume List box.



**Figure 212: Preset Volume List box**

The Preset Volume List box displays the following information of specified operations:

- **Port:** The port ID (cluster and channel number) of each volume. If the L2 pairs exist, an icon of the different shape is displayed.
- **Group:** The host group of each volume.
- **Path:** The CU:LDEV (control unit image:logical device ID) of each volume.
- **MU:** The MU number of a BC cascade pair member volume.
- **Port:** The port ID (cluster and channel number) of the first S-VOL of each volume.
- **Group:** The host group of the S-VOL.
- **S-Vol Path:** The CU:LDEV (control unit image:logical device ID) of the S-VOL.
- **Pace:** The copying pace for all pairs being created: **Slower**, **Medium**, and **Faster**.
- **Code:** If the specified option in the Preset Volume List box is performed by clicking **Apply**, but the operation fails, the reason code is displayed.

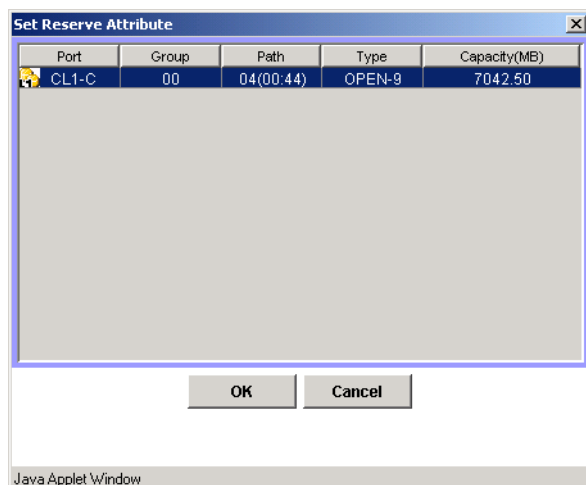
To perform the specified operations, click **Apply** on the BC main screen. When all the operations are performed successfully, the Preset Volume List box will be cleared. However, if some operations cannot be performed successfully, the failed operations will remain in the Preset Volume List box. You can also cancel one or all operations by using the following pop-up menu commands:

- The **Delete** command cancels the selected operation only. To display the **Delete** command, select a volume or pair, and then right-click with the mouse.
- The **Delete All** command cancels all operations displayed in the Preset Volume List box. To display the **All Delete** command, deselect any volume or pair, and then right-click with the mouse.
- The **Detail** command displays the Error window, which displays the error code and message for the failed operation. For the BC error codes, see [Table 61](#) on page 560.

## Performing BC Operations

### Setting the Reserve Attribute

Use the Set Reserve Attribute window to set the reserve attribute for the volume(s) selected on the BC main screen. To open the Set Reserve Attribute window, select one or more unreserved SMPL volumes in the Volume List box on the BC main screen, right-click to display the pop-up menu, and then click **Change Reserve**.



**Figure 213: Set Reserve Attribute window**

The Set Reserve Attribute window displays the unreserved volume that you selected on the BC main screen. Clicking the **OK** button sets the reserve attribute for unreserved volume.

The setting will be displayed in the Preset Volume List box on the BC main screen. The **Cancel** button closes the Set Reserve Attribute window without reflecting the settings. To apply the settings to the disk array, click **Apply** on the BC main screen.

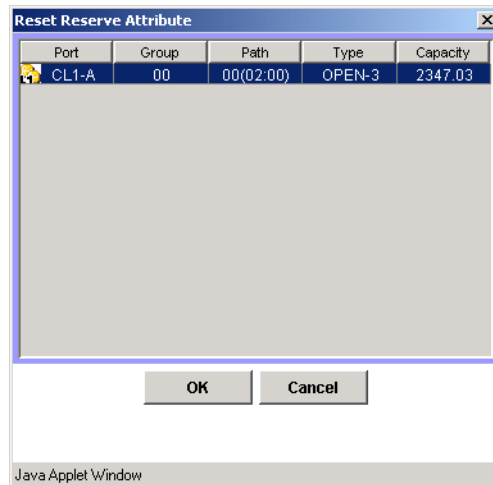
#### **To reserve one or more volumes for use as BC S-VOLs (set the reserve attribute):**

1. Unmount the volume(s) that you will be reserving. The disk array will reject all write I/Os to reserved volumes (except when in the PSUS status).
2. From the BC main screen, click the port, host group, or LUN in the Tree View box.

3. Display the unreserved SMPL volumes in the Volume List box. To display unreserved SMPL volumes, open the Display Filter window, clear the **Reserve** and **Pair** check boxes, select the **non pair** check box, and click **OK**.
4. Select the volume(s), right-click to display the pop-up menu, and then click **Change Reserve**. The Set Reserve Attribute window is displayed. If the **Change Reserve** command is not enabled, you selected paired volumes. Select only unreserved and unpaired volumes.
5. From the Set Reserve Attribute window, click the volumes you want to reserve and then click **Set**.  
The setting will be reflected in the Preset Volume List box on the BC main screen.
6. From the BC main screen, click **Apply**.
7. Verify that the settings are reflected in the disk array. To check the attribute, click **Display Filter**.

## Resetting the Reserve Attribute

Use the Reset Reserve Attribute window to reset the reserve attribute for the volume selected on the BC main screen. To open the Reset Reserve Attribute window, select one or more reserved SMPL volumes in the Volume List box on the BC main screen, right-click to display the pop-up menu, and then click **Change Reserve**.



**Figure 214: Reset Reserve Attribute window**

The Reset Reserve Attribute window displays the reserved volume that you selected on the BC main screen. Clicking the **OK** button resets the reserve attribute for reserved volume.

The settings will be displayed in the Preset Volume List box on the BC main screen. The **Cancel** button closes the Reset Reserve Attribute window without reflecting the settings. To apply the settings to the disk array, click **Apply** on the BC main screen.

**To unreserve one or more volumes (reset the reserve attribute):**

1. Make sure that the volumes you want to unreserve are no longer assigned to BC pairs as S-VOLs. See [Suspending BC Pairs \(Pairsplit-E\)](#) on page 552 for instructions on deleting BC pairs.
2. From the BC main screen, click the port, host group, or LUN in the Tree View box.
3. Display reserved SMPL volumes in the Volume List box. To display reserved SMPL volumes, open the Display Filter window, select the **Reserve** check box, and click **OK**.
4. Select the volumes, right-click to display the pop-up menu, and then click **Change Reserve**. The Reset Reserve Attribute window is displayed. If the **Change Reserve** command is not enabled, you selected paired volumes. Select only reserved and unpaired volumes.
5. From the Reset Reserve Attribute window, click the volume you want to unreserve and then click **Set**.

The setting will be reflected in the Preset Volume List box on the BC main screen.

6. From the BC main screen, click **Apply**.
7. Verify that the settings are reflected in the disk array. To check the attribute, click **Display Filter**.

## Creating BC Pairs (Paircreate)

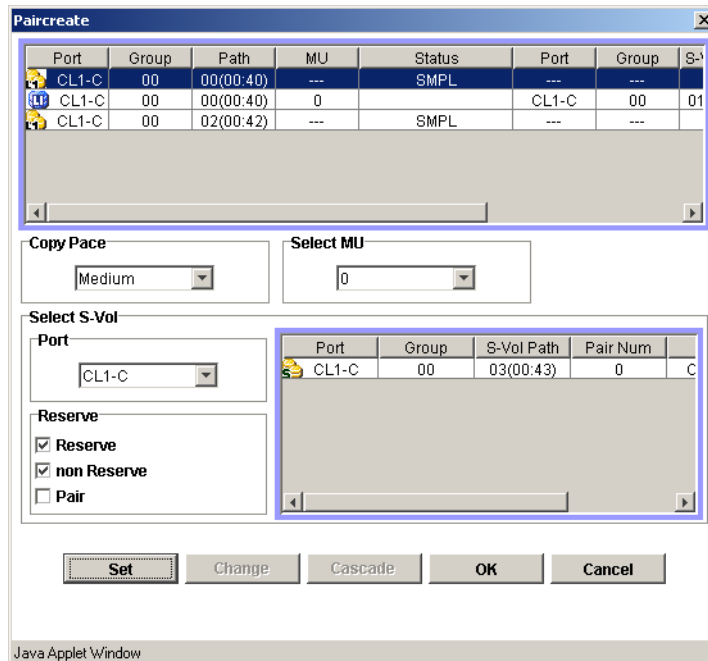


**Caution:** The BC paircreate operation overwrites all existing data on the S-VOLs. The user is responsible for backing up the data on the S-VOLs before creating BC pairs.

---



The Paircreate window displays the P-VOL and S-VOL information for the pair(s) being created (added). You can use the Paircreate window to select the S-VOL(s) for each P-VOL, set the copy pace for all pairs being created, and start the paircreate operation(s). To open the Paircreate window, select one or more SMPL volumes or PSUS pairs in the Volume List box on the BC main screen, right-click the selected volume(s) to display the pop-up menu, and then click **Paircreate**.



**Figure 215: Paircreate window**

The Paircreate window displays the P-VOL and S-VOL information for each pair being created: port, host group, path (CU:LDEV), MU#, volume status, copy pace, progress, emulation type, and capacity. The S-VOL for each P-VOL is displayed only after being selected (using **Set** or **Change**). Use the **Copy Pace** drop-down list to select the copy pace for all pairs being created: **Slower**, **Medium**, and **Faster**. Use the **Select MU** drop-down list to select the MU number for each pair being created: **0**, **1**, and **2** for L1 pairs, and **1** and **2** for L2 pairs.

The **Select S-Vol** box filters the S-VOLs displayed in the S-VOL list. Use the **Port** drop-down list and **Reserved** check boxes to display the available S-VOLs by port and by reserve attribute. Also, you can use the **Reserved** check boxes to display available pairs that can be added to the P-VOL as L2 pairs by pair attribute.

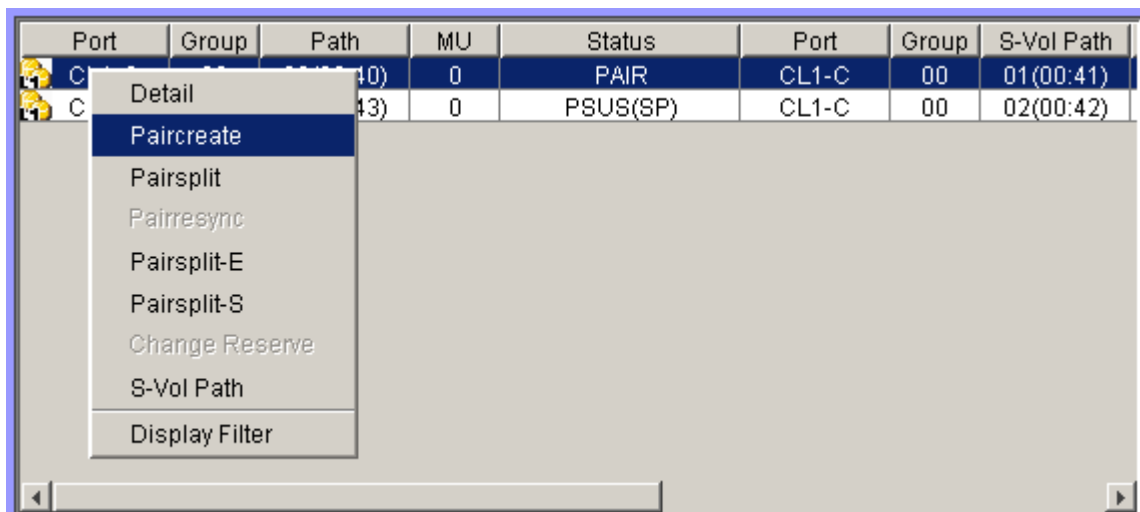
The **Set** button adds the selected L1 S-VOL to the selected L1 P-VOL. The **Change** button replaces the S-VOL of the selected pair with the selected S-VOL. The **Cascade** button adds the selected L2 S-VOL to the selected L1 pair. To use the **Cascade** button, you must select an L1 pair. To remove any volumes from the P-VOL or S-VOL list, select the volumes, right-click the selected volumes using the mouse, and then select **Delete**. The **OK** reflects the new pairs in the list to the Preset Volume List box on the BC main screen.

To create all pairs in the list, you must click **Apply** on the BC main screen. The **Cancel** button undoes the operations and closes the Paircreate window.

If you want to create new BC pairs and then split them immediately so that you can access the S-VOLs as soon as possible, use the pairsplit operation instead of the paircreate operation to establish and split new pairs at the same time (see [Splitting BC Pairs \(Pairsplit\)](#) on page 545 for instructions).

#### To create one or more new BC (L1) pairs:

1. Make sure that the S-VOL(s) are unmounted.
2. From the BC main screen, click the port, host group, or P-VOL in the Tree View box to filter the volumes displayed in the Volume List box.
3. Select the P-VOL(s) for the new pair(s), right-click the selected P-VOL(s) to display the pop-up menu, and then click **Paircreate** to open the Paircreate window.



**Note:** Do not select any reserved volumes.

---

4. Set the initial copy pace for all pairs being created: **Slower**, **Medium**, or **Faster**.
5. Verify that the Paircreate window displays the P-VOL(s). If you want to remove any volumes from the list, select the volume(s), right-click the volume(s), and then click **Delete** from the pop-up menu.
6. Select the S-VOL(s) for each P-VOL as follows:
  - a. Click the P-VOL in the Paircreate window.
  - b. In the **Select MU** drop-down list, click the MU number for the L1 pair being created: **0**, **1**, or **2**.
  - c. Click the port in the **Port** drop-down list, select the **Reserved** check box to display reserved volumes, and then click the S-VOL.


---

**Note:** You can select an unreserved volume as the S-VOL. When you create the pair, the disk array changes the reserve attribute to "reserved" automatically.

---

- d. Click **Set** to create (add) the S-VOL to the selected P-VOL. The S-VOL is now displayed next to the selected P-VOL.
  - e. To add a second and/or third S-VOL to the same P-VOL, repeat [step b](#) - [step d](#) to add each S-VOL to the selected P-VOL. Each pair to be created is displayed separately in the list of pairs in the Paircreate window.
  - f. To change an S-VOL for a pair that is already set, click the pair, click the S-VOL to replace the existing S-VOL, and then click **Change**.
7. Repeat [step 6](#) until all the pairs you want are displayed. Click **Change** to replace an S-VOL, click **Set** to add an S-VOL, and use the **Delete** command to remove pairs.
8. When the Paircreate window displays the new pair(s), click **OK** to reflect all pairs (settings) in the list to the Preset Volume List box on the BC main screen.
9. From the BC main screen, click **Apply** to create the pair(s).

When the initial copy operation(s) start, the BC main screen shows the new pairs with COPY(PD) status and the progress (%) of the initial copy operation(s).

10. Click the **Refresh** button () to monitor the progress of the initial copy operation(s).




**Caution:** The L2 paircreate operation overwrites all existing data on the L2 S-VOLs. The user is responsible for backing up the data on the S-VOLs before creating BC pairs.

---

#### To create one or more new L2 cascade pairs:

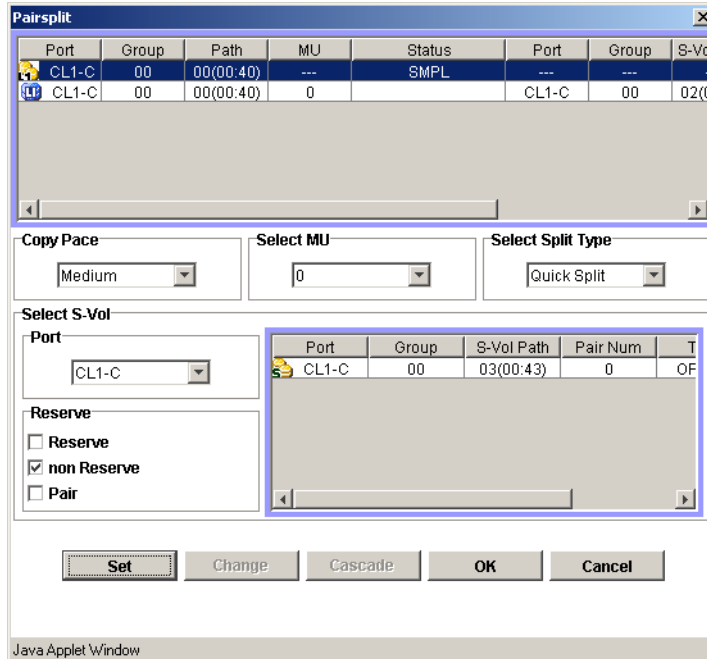
1. Make sure that the L2 S-VOLs are unmounted.
2. From the BC main screen, select the L1 pair(s) to which you want to add the L2 pair(s), right-click the selected L1 pair(s) to display the pop-up menu, and then click **Paircreate** to open the Paircreate window.
3. From the Paircreate window, click the L1 node volume, click the MU number (**1** or **2**) in the **Select MU** drop-down list, and then click the S-VOL for the new L2 pair (MU=0 was already used as the L1 S-VOL).
4. Click **Cascade** to add the L2 pair to the list of pairs.
5. Repeat until all L2 pairs are displayed. Click **Change** to replace an S-VOL, click **Cascade** to add an S-VOL, and use the **Delete** command to remove pairs.
6. When the Paircreate window displays all new pairs, click **OK** to reflect all pairs (settings) in the list to the Preset Volume List box on the BC main screen.
7. From the BC main screen, click **Apply** to create the pair(s).

When the initial copy operation(s) start, the BC main screen shows the new pairs with COPY(PD) status and the progress (%) of the initial copy operation(s).

8. Click the **Refresh** button () to monitor the progress of the initial copy operation(s).

## Splitting BC Pairs (Pairsplit)

The Pairsplit window displays volume and pair information for the volume(s) and/or pair(s) selected on the BC main screen. Use the Pairsplit window to split existing BC pairs, or to simultaneously create and split new BC pairs (see [Creating and Splitting Pairs](#) on page 547). To open the Pairsplit window, select volume(s) or pair(s) in the Volume List box on the BC main screen, right-click the selected volume(s) or pair(s) to display the pop-up menu, and then click **Pairsplit**.



**Figure 216: Pairsplit window**

The Pairsplit window lists the volume(s)/pair(s) selected on the BC main screen and shows the pair status and copy pace for each pair. Use the **Copy Pace** drop-down list to select the copy pace for all pairs that you are splitting: **Slower**, **Medium**, or **Faster**. Use the **Select MU** drop-down list to select the MU number for each pair P-VOL: **0**, **1**, and **2** for L1 pairs, and **1** and **2** for L2 pair P-VOL. Use the **Select Split Type** drop-down list to select the pairsplit type: **Quick Split** or **Steady Split**.

The **Select S-Vol** box filters the S-VOLs displayed in the S-VOL list. Use the **Port** drop-down list and **Reserved** check boxes to display the available S-VOLs by port and by reserve attribute. Also, you can use the **Reserved** check boxes to display available pairs that can be added to the P-VOL as L2 pairs by pair attribute.

The **Set** button adds the selected L1 S-VOL to the selected L1 P-VOL. The **Change** button replaces the S-VOL of the selected pair with the selected S-VOL. The **Cascade** button adds the selected L2 S-VOL to the selected L1 pair. To use the **Cascade** button, you must select a split (PSUS) L1 pair. To remove any volumes from the list, select the unneeded volumes, right-click the selected volumes to display the pop-up menu, and then click **Delete**. The **OK** button splits all pairs displayed in the list and reflects the settings to the Preset Volume List box on the BC main screen.

You must click **Apply** on the BC main screen to start the pairsplit operation for the specified pairs. The **Cancel** button undoes the operations and closes the Pairsplit window.

#### To split one or more existing BC pairs:

1. If you want the split S-VOLs to be identical to the P-VOLs, stop all write operations to the P-VOLs before splitting the pairs. This ensures that there are no updates to the P-VOLs while the pairsplit operations are synchronizing the S-VOLs to the P-VOLs.



**Caution:** The P-VOL and S-VOL are synchronized only when the pair status changes from COPY(SP) or PSUS(SP) to PSUS. Due to the BC asynchronous update copy operations, this status transition can take several minutes.


---

2. From the BC main screen, click the port, host group, or P-VOL in the Tree View box to filter the volumes displayed in the Volume List box.
3. Select the pair(s) you want to split, right-click the selected P-VOL(s) to display the pop-up menu, and then click **Pairsplit** to open the Pairsplit window. You cannot split a suspended (PSUE) pair.

Port	Group	Path	MU	Status	Port	Group	S-Vol Path
C		10)	0	PAIR	CL1-C	00	01(00:41)
C		13)	0	PSUS(SP)	CL1-C	00	02(00:42)

Detail
Paircreate
<b>Pairsplit</b>
Pairresync
Pairsplit-E
Pairsplit-S
Change Reserve
S-Vol Path
Display Filter

- From the Pairsplit window, set the copy pace (**Slower**, **Medium**, or **Faster**) for all pairs being split. If you change the setting, the last setting will become effective.
- Set the split type (**Quick Split** or **Steady Split**) for each pair being split. The split type is set for all pairs being split. If you change the setting, the latest setting is applied to all pairs.
- When the Pairsplit window displays the pair(s) you want, click **OK** to add all pairs to the Preset Volume List box on the BC main panel. Use the **Delete** command to remove any pairs from the list.
- From the BC main screen, click **Apply** to split the pair(s).  
When the pairsplit operation(s) start, the BC main screen shows the new pairs with COPY(SP) or PSUS(SP) status and the progress (%) of the update copy operation(s). The PSUS status is displayed right away if there were no pending update copy operations
- Click the **Refresh** button (  ) to monitor the progress of the pairsplit operation(s).

## Creating and Splitting Pairs

The pairsplit operation can also be used to simultaneously create and split new BC pairs. In this case, the pairsplit operation changes the pair status from SMPL to COPY(SP) or PSUS(SP), copies all data on the P-VOL to the S-VOL, and then changes the pair status to PSUS.

**To create and split one or more new BC pairs simultaneously:**

1. If you want the split S-VOLs to be identical to the P-VOLs, stop all write operations to the P-VOLs before creating and splitting the pairs. This ensures that there are no updates to the P-VOLs while the pairsplit operations are synchronizing the S-VOLs to the P-VOLs.




**Caution:** The P-VOL and S-VOL are synchronized only when the pair status changes from COPY(SP) or PSUS(SP) to PSUS. Due to the BC asynchronous update copy operations, this status transition can take several minutes.

---

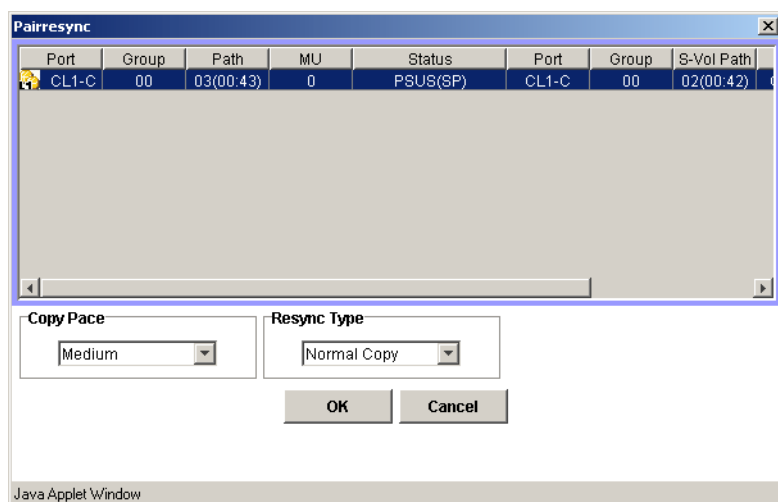
2. From the BC main screen, click the port, host group, or P-VOL in the Tree View box to filter the volumes displayed in the Volume List box.
3. Select the volume(s) that will be the P-VOL(s) of the new pairs to be created and split, right-click the selected P-VOL(s) to display the pop-up menu, and then click **Pairsplit** to open the Pairsplit window.
4. Set the copy pace (**Slower**, **Medium**, or **Faster**) and split type (**Quick** or **Steady**) for all pairs being created and split.
5. Specify the S-VOL(s) as follows:
  - a. Click the P-VOL.
  - b. In the **Select MU** drop-down list, click the MU number (**0**, **1**, or **2**) for the L1 pair to be created.
  - c. Click the port in the **Port** drop-down list, display either reserved or unreserved volumes, and then click the S-VOL.
  - d. Click **Set** to add the S-VOL to the selected P-VOL. The S-VOL is now displayed next to the selected P-VOL.
  - e. To add another S-VOL to the same P-VOL, repeat [step c](#) - [step d](#) to add the next S-VOL to the selected P-VOL. Each pair to be created and split is displayed separately in the list of pairs.
6. Repeat [step 5](#) until the L1 pair(s) is/are displayed. Click **Change** to replace S-VOLs, click **Set** to add L1 S-VOLs, and use the **Delete** command to remove pairs.
7. If you also want to create and split L2 cascade pairs, add the L2 S-VOL(s) to the L1 pairs as follows:
  - a. Click the L1 pair from the list of pairs to be created and split.



- b. Make sure that the L1 pairs are split (status = PSUS).
  - c. In the **Select MU** drop-down list, click the MU number (**1** or **2**) for the L2 pair to be created.
  - d. Click **Cascade** to add the L2 S-VOL to the selected L1 pair. The new L2 pair is now displayed.
  - e. To add another L2 S-VOL to the same L1 pair, repeat [step b](#) - [step d](#). Each L2 pair to be created and split is displayed separately in the list of pairs.
8. Repeat [step 7](#) until the pair(s) are displayed. Click **Change** to replace S-VOLs, click **Cascade** to add L2 S-VOLs, and use the **Delete** command (shown by right-clicking) to remove pairs.
  9. When the Pairsplit window displays the L1 and L2 pair(s), click **OK** to reflect the settings to the Preset Volume List box on the BC main screen.
  10. From the BC main screen, click **Apply** to create and split the pair(s).  
When the pairsplit operation(s) start, the BC main screen shows the new pairs with COPY(SP) or PSUS(SP) status.
  11. Click the **Refresh** button () to monitor the progress of the pairsplit operation(s).

## Resynchronizing BC Pairs (Pairresync)

The Pairresync window displays pair information for the pairs selected on the BC main screen. Use the Pairresync window to resynchronize the pairs. To open the Pairresync window, select one or more PSUS or PSUE pairs in the Volume List box on the BC main screen, right-click the selected pair to display the pop-up menu, and then click **Pairresync**.



**Figure 217: Pairresync window**



The Pairresync window lists the pair selected on the BC main screen and shows the pair status and copy pace for each pair. Use the **Copy Pace** drop-down list to select the copy pace for the pairs being resynchronized: **Slower**, **Medium**, or **Faster**. Use the **Resync Type** drop-down list to select the pairresync type for the pairs being resynchronized: **Normal Copy**, **Quick Resync**, **Reverse Copy**, or **Quick Restore**.

The **OK** button adds the specified pair to the Preset Volume List box on the BC main screen.

You must click **Apply** on the BC main screen to start the pairresync operation for the specified pair. The **Cancel** button exits the Pairresync window and returns you to the BC main screen.

#### To resynchronize one or more BC pairs:

1. Unmount the split (PSUS) S-VOLs before starting the pairresync operations. When the pairresync operation starts, the disk array will stop accepting write I/Os to the S-VOL.
2. From the BC main screen, click the port, host group, or P-VOL in the Tree View box to filter the volumes displayed in the Volume List box.
3. From the BC main screen, select the pair(s) you want to resync, right-click the selected pair(s) to display the pop-up menu, and then click **Pairresync** to open the Pairresync window.

Port	Group	Path	MU	Status	Port	Group	S-Vol Path
 CL1-C	00	00(00:40)	0	PAIR	CL1-C	00	01(00:41)
 CL1-C	00	03(00:43)	0	PSUS(SP)	CL1-C	00	02(00:42)

Detail
Paircreate
Pairsplit
<b>Pairresync</b>
Pairsplit-E
Pairsplit-S
Change Reserve
S-Vol Path
Display Filter

- From the Pairresync window, click the pair(s), and set the copy pace (**Slower**, **Medium**, or **Faster**) and resync type (**Normal Copy**, **Quick Resync**, **Reverse Copy**, or **Quick Restore**) for each pair. Reverse and quick restore pairresync cannot be performed on suspended pairs (PSUE) or L2 cascade pairs.



**Caution:** Make sure to select the correct resync direction (normal/quick, or reverse/quick restore).



**Caution:** During the quick restore operation, the RAID levels, HDD types, and Cache LUN settings are swapped. To avoid performance impact due to quick restore operations:

- Make sure that the P-VOL and S-VOL have the same RAID level and HDD type before performing the quick restore operation. If you want to restore the original RAID levels after quick restore, stop host I/Os to the pair, split the pair, perform the quick restore operation for that pair again, and then restart the host I/Os to the pair.
- Because the Cache LUN settings are exchanged during a quick restore operation, you must perform one of the two following operations. If you do not, the change of location of the cache residence areas may cause I/O performance to the Cache LUN data to be down.

Set the same Cache LUN settings (locations) for the P-VOL and S-VOL before performing the quick restore operation.


Release the Cache LUN settings of the P-VOL and S-VOL before the quick restore operation, and then reset the Cache LUN settings of the P-VOL and S-VOL after the pair changes to PAIR status as a result of the quick restore operation.

- 
5. Click **OK**. Repeat [step 4](#) - [step 5](#) until the Preset Volume List box on the BC main screen displays the pairs (settings).

---

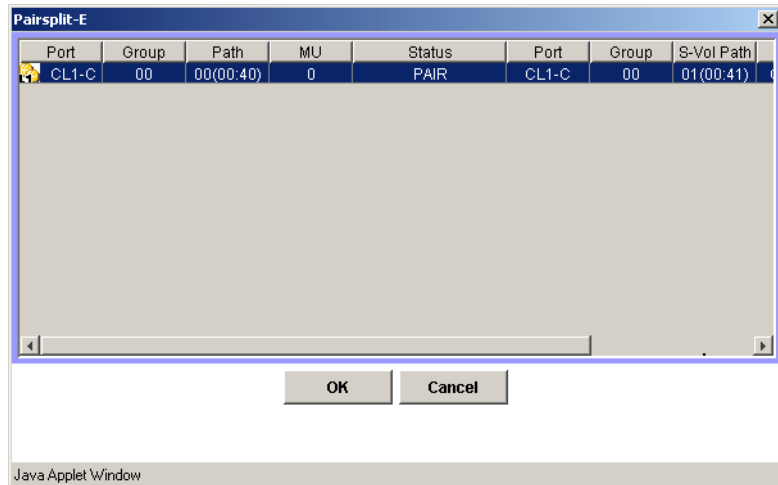
**Note:** Make sure to vary the S-VOL(s) offline before starting pairresync operations.

---

6. From the BC main screen, click **Apply** to resync the specified pair(s).  
The BC main screen now displays the result(s) of the pairresync operation(s) (that is, pair status changed to COPY(RS), COPY(RS-R), or PAIR).
7. Click the **Refresh** button (  ) to monitor the progress of the pairresync operation(s).

## Suspending BC Pairs (Pairsplit-E)

The Pairsplit-E window displays pair information for the pair(s) selected on the BC main screen. Use the Pairsplit-E window to suspend the pair(s). To open the Pairsplit-E window, select one or more pairs (except SMPL and PSUE pairs) in the Volume List box on the BC main screen, right-click the selected pair(s) to display the pop-up menu, and then click **Pairsplit-E**.



**Figure 218: Pairsplit-E window**


The Pairsplit-E window lists the pair(s) selected on the BC main screen and shows the pair status and copy pace for each pair. The **OK** button suspends the selected pair(s). The **Cancel** button closes the Pairsplit-E window and returns you to the BC main screen.

**To suspend one or more BC pairs:**

1. From the BC main screen, click the port, host group, or P-VOL in the Tree View box to filter the volumes displayed in the Volume List box.
2. Select the pair(s) that you want to suspend (or the volume(s) whose pairs you want to suspend), right-click the selected pair(s) to display the pop-up menu, and click **Pairsplit-E** to open the Pairsplit-E window.

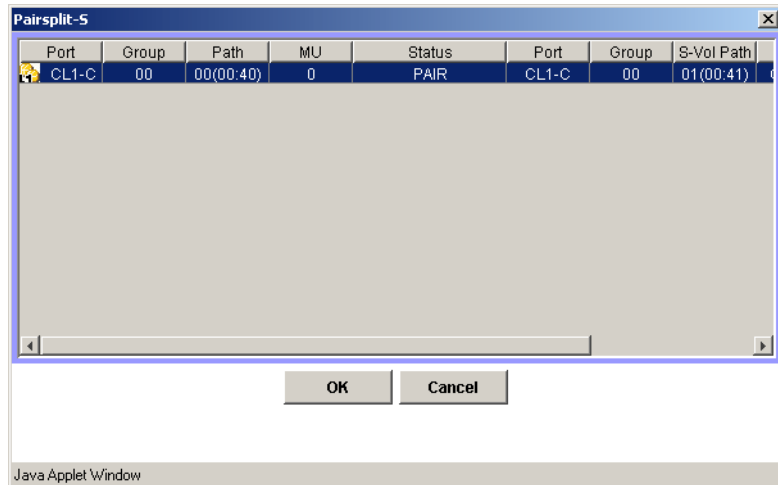
Port	Group	Path	MU	Status	Port	Group	S-Vol Path
CL1-C	00	00(00:40)	0	PAIR	CL1-C	00	01(00:41)
CL1			0	PSUS(SP)	CL1-C	00	02(00:42)

A context menu is open over the second row (CL1, PSUS(SP)). The menu items are: Detail, Paircreate, Pairsplit, Pairresync, Pairsplit-E (highlighted), Pairsplit-S, Change Reserve, S-Vol Path, and Display Filter.

- From the Pairsplit-E window, click the pair(s) you want to suspend, and click **OK** to reflect the settings to the Preset Volume List box on the BC main screen.
- To remove the pair(s) from the list, right-click while selecting the pair(s), and then click **Delete** from the pop-up menu.
- Repeat [step 2](#) - [step 3](#) to suspend additional pairs in the list.
- From the BC main screen, click **Apply** to suspend the specified pair(s).  
The BC main screen now displays the result(s) of the pairsplit-E operation(s) (that is, pair status changed to PSUE).
- Click the **Refresh** button (  ) to display the latest information.

## Deleting BC Pairs (Pairsplit-S)

The Pairsplit-S window displays pair information for the pair(s) selected on the BC main screen. Use the Pairsplit-S window to delete the pair(s). To open the Pairsplit-S window, select one or more pairs (except SMPL and PSUS(SP) pairs) in the Volume List box on the BC main screen, right-click the selected pair(s) to display the pop-up menu, and then click **Pairsplit-S**.



**Figure 219: Pairsplit-S window**

The Pairsplit-S window lists the pair(s) selected on the BC main screen and shows the pair status and copy pace for each pair. The **OK** button deletes the selected pair(s). The **Cancel** button closes the Pairsplit-S window and returns you to the BC main screen.


**To delete one or more BC pairs:**

1. If you want to synchronize the P-VOL and S-VOL before deleting the pair:
  - a. Wait until all write I/Os to the P-VOL are complete, and then take the P-VOL offline to prevent the P-VOL from being updated during or after the pairsplit-S operation.
  - b. After the P-VOL is offline, suspend the pair to copy all pending updates to the S-VOL.
  - c. When the pair status changes to PSUE, the P-VOL and S-VOL are synchronized.
2. From the BC main screen, click the port, host group, or P-VOL in the Tree View box to filter the volumes displayed in the Volume List box.
3. Select the pair(s) that you want to delete (or the volume(s) whose pairs you want to delete), right-click the selected pair(s) or volume(s) to display the pop-up menu, and then click **Pairsplit-S** to open the Pairsplit-S window.

Port	Group	Path	MU	Status	Port	Group	S-Vol Path
CL1-C			0	PAIR	CL1-C	00	01(00:41)
CL1-C			0	PSUS(SP)	CL1-C	00	02(00:42)

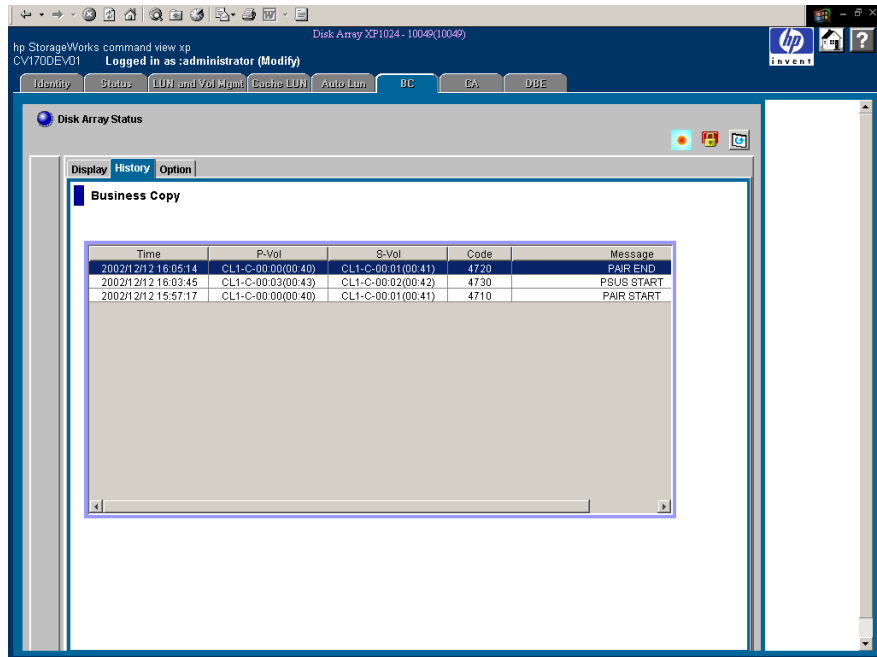
**Note:** Pairs with PSUS(SP) status cannot be deleted. To remove the pair(s) from the list, right-click while selecting the pair(s), and then click **Delete** from the pop-up menu.

4. From the Pairsplit-S window, click the pair(s) you want to delete, and click **OK** to reflect the settings to the Preset Volume List box on the BC main screen.
5. From the BC main screen, click **Apply** to delete the specified pair(s) or volume(s).  
The BC main screen now displays the result(s) of the pairsplit-S operation(s).
6. Click the **Refresh** button (  ) to display the latest information.

## Viewing BC Pair Status and History


The History screen displays current BC pair status information as well as BC pair history information for the selected port. To open the History screen, click the **History** tab on the BC main screen.





**Figure 220: History screen**

The **BC History** box displays the following information:

- BC pair activity listed by: date and time, P-VOL and S-VOL ID (CU:LDEV), BC code and message (see the following table). The **Time** button sorts the list by date and time. The **P-Vol** and **S-Vol** buttons sort the list by **P-VOL** or **S-VOL**. The **Code** button sorts by code number. The **Message** button sorts according to message type.
- The **Refresh** button () updates all information on the History screen.

**Table 60: BC pair activity codes, messages, and descriptions**

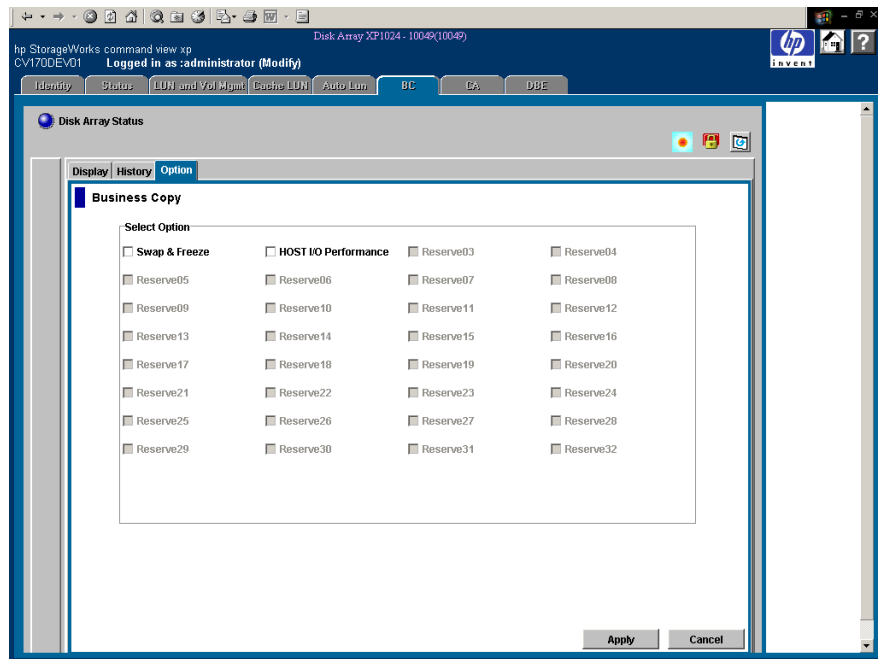
Code	Message	Description
4710 - 471F	PAIR START	The BC initial copy operation started.
4720 - 472F	PAIR END	The BC initial copy operation ended, and the pair status changed to PAIR.
4730 - 473F	PSUS START	The BC pairsplit operation started, and the pair status changed to COPY(SP) or PSUS(SP).

**Table 60: BC pair activity codes, messages, and descriptions (Continued)**

Code	Message	Description
4740 - 474F	PSUS END	The BC pairsplit operation ended, and the pair status changed to PSUS.
4750 - 475F	COPY(RS) START COPY(RS-R) START	The BC pairresync operation started, and the pair status changed to COPY(RS) or COPY(RS-R).
4760 - 476F	COPY(RS) END COPY(RS-R) END	The BC pairresync operation ended, and the pair status changed to PAIR.
4780 - 478F	SMPL	The BC pairsplit-S operation was performed, and the pair status changed to SMPL.
4790 - 479F	PSUE	The BC pairsplit-E operation was performed, and the pair status changed to PSUE.
47A0 - 47AF	COPY WARNING END	A copy ended with a warning.
47B0 - 47BF	COPY ABNORMAL END(PVOL BLOCKADE)	A copy ended abnormally due to P-VOL blockade.
47C0 - 47CF	COPY ABNORMAL END(SVOL BLOCKADE)	A copy ended abnormally due to S-VOL blockade.
47D0 - 47DF	COPY ABNORMAL END	A copy ended abnormally (reason other than above).
47E7	COMPULSION PAIR SUSPEND	A pair was suspended compulsorily.
47E9	SI SM INITIALIZATION START	The initialization of the BC extension table was started (SM = shared memory).
47EA	SI SM INITIALIZATION END	The initialization of the BC extension table was completed (SM = shared memory).
47EB	SI SM INITIALIZATION FAILED	The initialization of the BC extension table failed (SM = shared memory).
7FF1 - 02	COPY ABNORMAL END (MULTIPLE PAIRS)	Multiple copies ended abnormally. This reference code is reported at a five-minute interval (one report per five minutes). If a pair ended abnormally, the pair status changed to PSUE.
FFFF	Reference Code unknown	The reference code is unknown.

## Setting BC Options

You can set the BC options by selecting and/or clearing the option check boxes on the Option screen. To display the Option screen, click the **Option** tab on the BC main screen.



**Figure 221: Option screen**

The **Select Option** box displays the check boxes of the BC options.

---

**Note:** More options will be supported in the future. Refer to [BC Options](#) on page 509 for further information.

---

The **Apply** button applies the option setting(s) in the **Select Option** box.

**To set a BC option (Swap&Freeze option):**

1. From the BC main screen, click the **Option** tab to display the **Select Option** box.
2. Select the option check box. If you do not want to set any option, clear all check boxes in the **Select Option** box.
3. Click **Apply**. You can now perform a BC operation with the specified option.

## BC Error Codes

BC displays error messages when error conditions occur during BC operations. The BC Error window displays the BC error code and message. To display the Error window, select the failed volume in the Preset Volume List box on the BC main screen (**Display** tab), right-click to display the pop-up menu, and then click **Detail**. The following table lists and describes the BC error codes and provides instructions for resolving each error condition.

**Table 61: BC error codes**

Error Code	Description	Corrective Action
0401	A locking time-out was detected during an internal processing.	A retry may result in a normal termination. Retry about five seconds later.
0402	A command (Paircreate, Pairsplit, or Reserve Volume) could not be completed because it was not in the SMPL status internally.	A retry may result in a normal termination. Retry about five seconds later.
0801	The BC feature could not be used.	Make sure the disk array has the correct microcode level for BC, the disk array has BC installed and enabled, and the Command View management station has BC installed and enabled.
080B	The request could not be accepted.	Retry about one minute later.
0810	The specified command cannot be accepted in this status. (The command was rejected.)	Check the pair status, and make sure the pair status is correct for the command.
0811	The specified command is treated as an NOP.	The specified command is treated as an NOP. (NOP means that the command can end without errors but executes nothing.)
0812	The new pair could not be created because a path group is set.	Disconnect from the host, or cancel the CA path. On the CA main screen, confirm the specified S-VOL is simplex, specify the <b>Delete Pair by Force</b> option, and then retry the same operation.
0813	The Pairsplit command was issued to a pair in the PSUS status.	The Pairsplit command cannot be issued because the pair is already in the PSUS status.
0814	The Paircreate command was issued to the pair in the PAIR status.	The Paircreate command cannot be issued because the pair is already in the PAIR status.
0817	A Reserve volume cannot be set because a path group is set.	Disconnect the volume to be reserved from the host, or delete the CA path.

**Table 61: BC error codes (Continued)**

Error Code	Description	Corrective Action
0818	The Pairresync or Pairsplit-E command cannot be issued because a path group is set.	Unmount the S-VOL (offline from the host), or delete the CA path.
081F	Command Reject. P-VOL is used from HOST or by CA.	Disconnect from the host, or cancel the CA path.
0830	A pair cannot be created because the track format is different.	Make sure that the emulation type of the P-VOL and S-VOL is the same.
0831	A pair cannot be created because a number of slots is different.	Make sure that the capacity of the P-VOL and S-VOL is the same.
0834	The emulation type of the specified P-VOL is not supported by BC.	Make sure that the emulation type of the P-VOL is supported by the BC.
0835	The emulation type of the specified S-VOL is not supported by BC.	Make sure that the emulation type of the S-VOL is supported by BC.
0836	The pair cannot be created.	The emulation type of the P-VOL and S-VOL is not the same.
0840	Logical contradiction.	Call HP technical support for assistance.
0841	Logical contradiction.	Call HP technical support for assistance.
0842	Logical contradiction.	Call HP technical support for assistance.
0848	Logical contradiction.	Call HP technical support for assistance.
0849	Logical contradiction.	Call HP technical support for assistance.
084A	Logical contradiction.	Call HP technical support for assistance.
084B	Logical contradiction.	Call HP technical support for assistance.
0852	Command Reject. P-VOL and S-VOL are used from HOST or by CA.	Disconnect from the host, or cancel the CA path.
0880-08FF	Logical contradiction.	Call HP technical support for assistance.
0C70	A P-VOL is not installed.	Volumes that are not installed cannot be processed.
0C71	The P-VOL cannot be used.	Call HP technical support to make the P-VOL status normal.
0C72	The P-VOL is being formatted.	Wait until the formatting of the P-VOL completes.
0C80	The S-VOL is not installed.	Volumes that are not installed cannot be processed.

**Table 61: BC error codes (Continued)**

Error Code	Description	Corrective Action
0C81	The S-VOL cannot be used.	Call HP technical support to make the P-VOL status normal.
0C82	The S-VOL is being formatted.	Wait until the formatting of the S-VOL completes.
0C90	The volume to be Reserved is not installed.	Volumes that are not installed cannot be processed.
0C91	The volume to be Reserved cannot be used.	Call HP technical support to make the volume status normal.
0C92	The volume to be Reserved is being formatted.	Wait until the formatting of the volume completes.
1001	Logical contradiction.	Call HP technical support for assistance.
1002	Logical contradiction.	Call HP technical support for assistance.
1003	Logical contradiction.	Call HP technical support for assistance.
1004	Logical contradiction.	Call HP technical support for assistance.
1005	Logical contradiction.	Call HP technical support for assistance.
1007	Logical contradiction.	Call HP technical support for assistance.
1009	The number of BC pairs exceeded the maximum.	Delete some of the pairs.
1010	Logical contradiction.	Call HP technical support for assistance.
1011	The number of the volume specified to be a Reserve volume has already been used for a Reserve volume.	Change the volume number for specifying a Reserve volume.
1012	The number of the volume specified to be a Reserve volume has already been used for a primary BC volume.	Change the volume number for specifying a Reserve volume.
1013	The number of the volume specified to be a Reserve volume has already been used for a hierarchical control primary volume.	Change the volume number for specifying a Reserve volume.

**Table 61: BC error codes (Continued)**

Error Code	Description	Corrective Action
1014	The number of the volume specified to be a Reserve volume has already been used for a hierarchical control destination volume.	Change the volume number for specifying a Reserve volume.
1015	The volume specified to be a Reserve volume is not set as a Reserve volume.	Check the volume status.
1016	The volume can appropriately be allocated as an S-VOL does not exist among Reserve volumes.	Delete any Reserve volume that can be allocated as an S-VOL.
1017	A Reserve volume cannot be set because the max. number of Reserve volumes was exceeded.	Delete any of the Reserve volumes
101E	The Reserve volume itself does not exist in the system.	Set one or more Reserve volumes.
1026	It is impossible to make a pair any more because the volume that was specified as P-VOL is root volume already.	Delete some of the pairs of root volume.
1027	It is impossible to make a pair any more because the volume that was specified as P-VOL is node volume already.	Delete some of the pairs of node volume.
1028	It is impossible to make a pair because the volume that was specified as P-VOL is leaf volume already.	Confirm a pair condition.
1029	It is impossible to make a pair because the volume that was specified as S-VOL is leaf volume already.	Confirm a pair condition.
102E	P-VOL is used as source volume for HIHSM.	Confirm a matching condition.
102F	P-VOL is used as destination volume for HIHSM.	Confirm a matching condition.
1030	The specified P-VOL number does not exist.	Retry after refreshing the screen.

**Table 61: BC error codes (Continued)**

Error Code	Description	Corrective Action
1031	The specified P-VOL has been set as a Reserve volume.	Check the pair status.
1032	No more pair can be created for the specified P-VOL.	Delete any of the pairs formed by the P-VOL.
1033	The specified P-VOL is not really a P-VOL.	Check the pair status.
1037	The specified P-VOL has been set as a BC S-VOL.	Check the pair status.
103A	The Pairresync command was issued to a device in the SMPL status.	Check the pair status.
103B	It is impossible to make a pair because volume that was specified as S-VOL is root volume already.	Confirm a pair condition.
103C	It is impossible to make a pair because volume that was specified as S-VOL is node volume already.	Confirm a pair condition.
103D	It is impossible for L2 pair to require a split because L1 pair is not in the split condition.	After making L1 pair a split condition, re-execute.
103E	A new pair was created with a P-VOL forming the CA cooperation pattern.	Place the BC pair in the SMPL status, or place the CA pair that uses the BC S-VOL as a P-VOL in the SMPL status.
103F	A pair status cannot be changed to form the CA cooperation pattern.	Place the CA pair that uses the BC S-VOL as a P-VOL in the PSUE or SMPL status.
1040	The specified S-VOL does not exist.	Set one or more Reserve volumes.
1042	S-VOL is used as destination volume for HIHSM.	Confirms a matching condition.
1043	The specified S-VOL number has already been used as that of an S-VOL.	Check the pair status.
1044	The specified S-VOL is not a BC S-VOL.	Check the pair status.



**Table 61: BC error codes (Continued)**

Error Code	Description	Corrective Action
1046	The specified secondary volume is being used as a CA P-VOL.	Delete the CA pair.
1047	The specified secondary volume is being used as a CA S-VOL.	Delete the CA pair.
104A	The specified secondary volume is being used as a BC P-VOL.	Check the pair status.
104B	S-VOL is used as source volume for HIHSM.	Confirm a matching condition.
104E	The volume specified as a Reserve volume is being used as a CA P-VOL.	Delete the CA pair.
104F	The volume specified as a Reserve volume is being used as a CA S-VOL.	Delete the CA pair.
1050	The specified P-VOL and S-VOL are not a BC pair.	Check the pair status.
1051	The volume numbers of the specified P-VOL and S-VOL are the same.	Retry after refreshing the screen.
1053	Request could not be accepted	Confirm a matching condition.
1054	Request could not be accepted	Confirm a matching condition.
1058	S-VOL is node volume whose L2 status is SP-Pend.	Confirm a matching condition.
1070	The status mode specification (status modcc) in the Status Check command is incorrect.	Call HP technical support for assistance.
1071	The status classification (statusindc) in the Status Check command is incorrect.	Call HP technical support for assistance.
1072	The CU number specified by the Status Check command (volume status) does not exist.	Call HP technical support for assistance.
1084	Volume was used for reserve volume of HIHSM.	Check the volume, or cancel the reserve volume of HIHSM.
1085	P-VOL was used for reserve volume of HIHSM.	Check the P-VOL, or cancel the reserve volume of HIHSM.

**Table 61: BC error codes (Continued)**

Error Code	Description	Corrective Action
1086	S-VOL was used for reserve volume of HIHSM.	Check the S-VOL, or cancel the reserve volume of HIHSM.
1087	P-VOL is used as source volume for HIHSM.	Confirm a matching condition.
1095	Request could not be accepted because status of pair who shared with P-VOL was Reverse-copy.	Confirm a matching condition.
1096	Request could not be accepted because L1 pair status was Reverse-copy.	Confirm a matching condition.
1097	Request could not be accepted because L2 pair status was Reverse-copy.	Confirm a matching condition.
1098	Reverse-Copy could not be accepted because pair status was not Split.	Confirm a matching condition.
1099	Reverse-copy to L2 pair could not be accepted because status of pair who shared with P-VOL was neither Split nor Suspend.	Confirm a matching condition.
109A	Reverse-copy could not be accepted because P-VOL was shared with CA P-VOL whose status was not Suspend.	Confirm a matching condition.
109B	Reverse-copy could not be accepted because P-VOL was shared with CA S-VOL whose status was not Suspend.	Confirm a matching condition.
109C	Reverse-copy could not be accepted because S-VOL was shared with CA P-VOL.	Confirm a matching condition.

# Continuous Access (CA) for the XP128/XP1024

21

Continuous Access (CA) creates and maintains duplicate copies of user data from a local disk array on a remote disk array. These copies are useful for data duplication, backup, and disaster recovery. CA has synchronous and asynchronous copy modes to accommodate a wide variety of user requirements and data copy/movement scenarios. CA is used for open systems data.

In the event of a system failure or disaster at the primary (main) site, CA simplifies and expedites disaster recovery procedures.

CA operations are nondisruptive and allow the primary (main) volume of each CA volume pair to remain online to all hosts for both read and write I/O operations. After operations have been established, CA operations continue unattended to provide continuous, real-time data backup. CA operations can be performed across distances of up to 500 meters with a direct connection, 10 km (6.6 miles) using single-mode longwave optical fibre cables in a switch configuration, 30 km (18.6 miles) using single-mode fiber with long-haul lasers in a switched connection and up to 100 km using DWDM in a switched configuration. For serial interface connection, CA operations can be performed across distances of up to 43 km (26.7 miles) using standard ESCON support. Long-distance solutions are provided, based on user requirements and workload characteristics, using approved channel extenders and communication lines.

CA operations can be performed in conjunction with Business Copy XP operations (see [Overview of CA Operations](#) on page 568) to provide multiple internal copies of CA volumes. CA also supports LU Size Expansion (LUSE), VSC, and HP Cache LUN volumes. See [Combining CA with Other Data Management Operations](#) on page 612 for more information.

## Overview of CA Operations

CA provides a storage-based hardware solution for disaster recovery, which enables fast and accurate system recovery. After CA operations are established, duplicate copies of data are automatically maintained for backup and disaster recovery purposes. During normal CA operations, the primary volumes remain online to all hosts and continue to process both read and write I/O operations. In the event of a disaster or system failure, the secondary copy of data can be rapidly invoked to allow recovery with a very high level of data integrity. CA can also be used for data duplication and migration tasks.

CA Synchronous provides volume-based real-time data replication and is ideal for high-priority data backup, duplication, and migration tasks. In the event of a disaster or system failure at the primary site, the secondary CA Synchronous data can be rapidly invoked to allow recovery at the volume level with an extremely high level of data integrity and currency. Up to a distance of approximately 7-9 km, CA Synchronous provides the highest theoretical throughput.

CA Asynchronous represents a unique and outstanding disaster recovery solution for large amounts of data, which span multiple volumes. The CA Asynchronous group-based update sequence consistency solution enables fast and accurate database recovery after a disaster, without the need for time-consuming data recovery procedures. The CA Asynchronous (CA Async) volume groups at the remote site can be recovered with full update sequence consistency, but data currency may be behind the primary site due to the asynchronous remote copy operations.

CA Asynchronous provides update sequence consistency for user-defined groups of volumes (such as large databases) as well as protection for write-dependent applications in the event of a disaster. Beyond a distance of 7-9 km, CA Asynchronous provides the highest possible theoretical throughput.

This overview of CA operations describes:

- CA components (see page 569)
- CA operations (see page 577)
- CA Asynchronous recordset operations (see page 580)
- CA Asynchronous consistency group operations (see page 585)
- CA volume pair status and split/suspend types (see page 587)

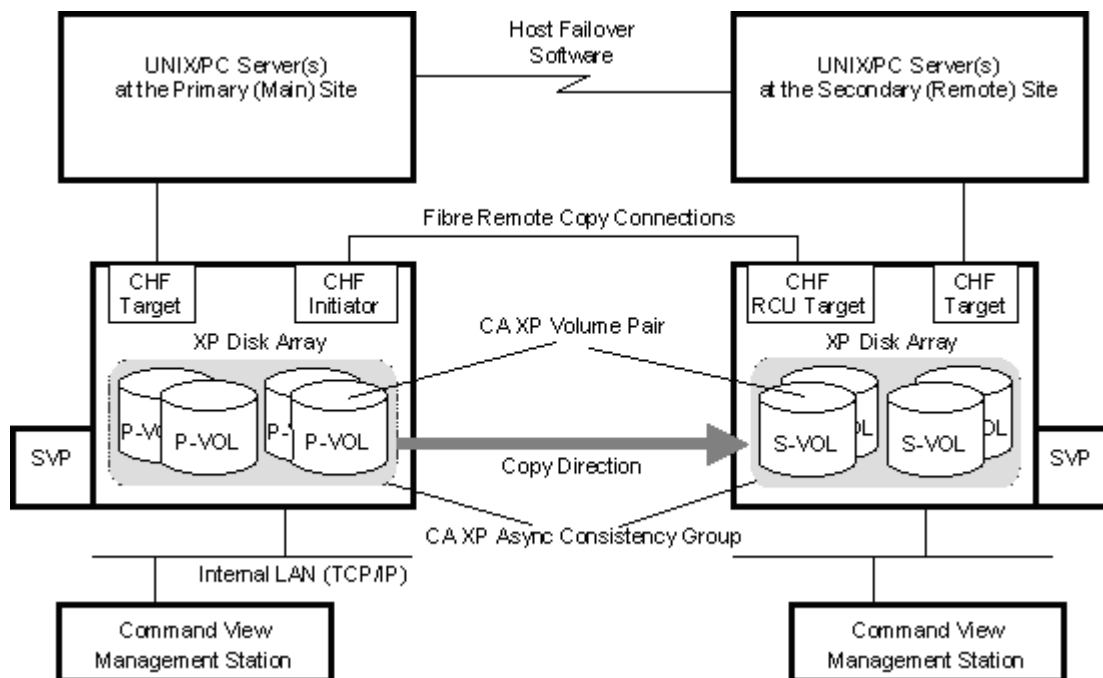
## Components

CA operations involve the XP128/XP1024 at a primary and a secondary (remote) site, the physical communications paths between these disk arrays, and Command View. CA copies online data at the primary site to volumes at the secondary site via the dedicated Fibre Channel and/or ESCON remote copy connections.

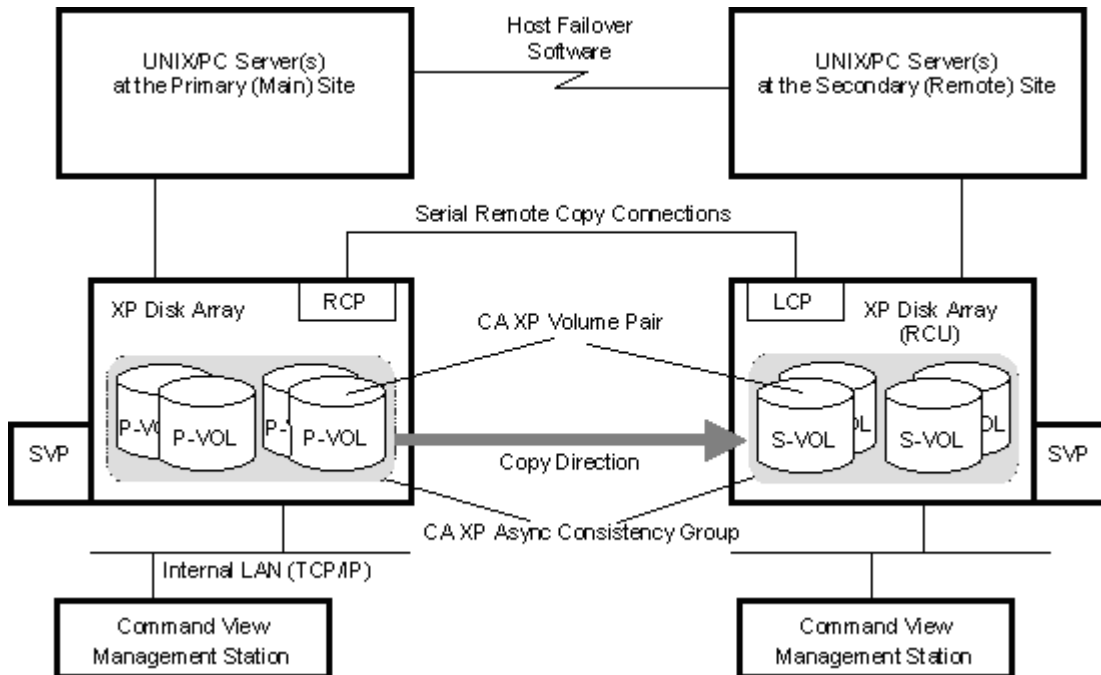
Host failover software is required for effective disaster recovery with CA.

The following figure shows the CA components and their functions:

- XP128/XP1024
- Main and remote control units (MCU and RCU)
- Volume pairs (P-VOLs and S-VOLs)
- CA Asynchronous consistency groups
- Remote copy connections
- Ordinary target ports, initiator ports, and RCU target ports for Fibre Channel interface
- Remote control ports (RCPs) and local control ports (LCPs) for serial interface
- Command View management station
- Host failover software



**Figure 222: CA components for Fibre Channel connection**



**Figure 223: CA components for Serial (ESCON) connection**

## XP128/XP1024

CA operations involve the primary (main) disk arrays and the secondary (remote) disk arrays (MCUs and RCUs). This document covers CA operations in which the main disk array is an XP128/XP1024 and the remote disk array is an XP128/XP1024. The MCUs contain the CA primary volumes (P-VOLs), which contain the original data and are online to the host(s). The RCUs contain the CA secondary volumes (S-VOLs), which are the synchronous or asynchronous copies of the P-VOLs. CA supports all CU images and logical volumes of the disk array. CA also supports all physical hard drive options. CA supports RAID1 and RAID5 configurations for the XP128/XP1024.

To provide greater flexibility and to enable the disk array to be tailored to unique customer operating requirements, additional operational parameters, or optional modes, are available for the disk array. At installation, the modes are set to their default values, so make sure to discuss these settings with your HP support team. The modes can only be changed by your HP support team representative.

Please contact your HP support team representative for the latest mode information.

## Main and Remote Control Units (MCUs and RCUs)

The main control unit (MCU) and remote control unit (RCU) control CA operations:

- The MCU is the control unit in the primary disk array that controls the P-VOLs of the CA volume pairs. The Command View management station must be LAN-attached to the MCU of each CA pair. The MCU communicates with the RCU via the dedicated Fibre Channel remote copy connections. The MCU controls the host I/O operations to the CA P-VOLs as well as the CA initial copy and remote copy operations between the P-VOLs and S-VOLs. The MCU also manages the CA pair status and configuration information.
- The RCU is the CU in the remote disk array that controls the S-VOLs of the CA volume pairs. The RCU assists in managing the CA pair status and configuration (for example, rejects write I/Os to CA S-VOLs). The RCU executes the remote copy operations issued by the MCU. The secondary Command View management station should be LAN-attached to the RCUs at the remote site. The RCUs should also be attached to a host system to allow sense information to be reported in case of a problem with a secondary volume or remote disk array and to provide disaster recovery capabilities.

The MCU and RCU can be defined separately for each CA volume pair. The XP128/XP1024 CU can function simultaneously as an MCU for one or more P-VOLs and as an RCU for one or more S-VOLs, provided the remote copy connections and Fibre Channel or serial interface ports are properly configured. The XP128/XP1024 provides up to 32 logical CU images (0-1F), with each CU image controlling up to 256 logical devices (LDEVs). You can use CA to select the CU image in the connected MCU and specify the CU image in the RCU. CA operations can be performed on all LDEVs except for the XP128/XP1024 command device.

---

**Note:** When serial interface connection is used for remote copy operations, the controller emulation of the connected ports of the MCU and RCU can be different. However, when the MCU and RCU are connected to the same host, the controller emulation of the host-connected ports of the MCU and RCU must be the same.

---



## Volume Pairs (P-VOLs and S-VOLs)

CA performs remote copy operations for logical volume pairs created by the user. Each CA pair consists of one primary volume (P-VOL) and one secondary volume (S-VOL), which can be located in the same disk array (synchronous only) or in different disk arrays. The CA P-VOLs are the primary volumes (LUs) that contain the original data, and the CA S-VOLs are the secondary or mirrored volumes (LUs) that contain the replicated or duplicate data. The volumes are copied on an Open volume basis, and the logical volumes should have the same format and capacity (SCSI path definition is required). During normal CA operations, the P-VOL remains available to all hosts at all times for read and write I/O operations. During normal CA operations, the RCU rejects all host-requested write I/Os for the S-VOLs. The S-VOL write enable option allows write access to an S-VOL while the pair is split and uses the S-VOL and P-VOL cylinder maps to resynchronize the pair (see [S-VOL Write Option](#) on page 580).

CA supports the basic logical unit (LU) types available on the XP128/XP1024. CA also supports the LU Size Expansion (LUSE), VSC, and HP Cache LUN XP features, ensuring that all user data can be backed up or duplicated. See [Logical Unit \(LU\) Types](#) on page 600 for further information on LU requirements and support.

CA supports a maximum of 8,192 CA pairs (entire RCU). When CA pairs include size-expanded LUs, the maximum number of pairs decreases. When the Raid Manager command device is defined, the maximum number of CA pairs in the XP1024 is 8,191 (4095 in the XP128).

CA supports the following RAID level configurations.

**Table 62: CA supported RAID level configurations**

For P-VOL	For S-VOL
RAID 1	RAID 1
RAID 5	RAID 5
RAID 1	RAID 5
RAID 5	RAID 1

## CA Asynchronous Consistency Groups

A CA Asynchronous consistency group is a user-defined set of volume pairs across which update sequence consistency is maintained and ensured at the remote site. Each CA Async volume pair must be assigned to a consistency group. CA can configure up to 128 consistency groups (0-7F) for each MCU and

provides group-based operations for consistency groups (for example, split and resync group). You can use consistency groups to maintain update sequence consistency for databases that span multiple volumes, allowing immediate database recovery at the remote site when needed. See [CA Asynchronous Consistency Group Operations](#) on page 585 for further information on CA Asynchronous consistency group operations.

## Remote Copy Connections

The remote copy connections are the physical paths used by the MCUs to communicate with the RCUs. The number of physical paths in the MCU is limited to eight per logical CU image. The MCUs and RCUs are connected via Fibre Channel interface or serial (ESCON) interface cables.

- When Fibre Channel interface connections are used, switches are required for distances greater than 0.5 km (1,640 feet). Distances up to 1.5 km (4,920 feet, 0.93 miles) are supported with dual switches utilizing shortwave connections. Distances up to 10 km (6.2 miles) are supported using dual switches with longwave connections. Distances up to 30 km (18.6 miles) are supported using dual switches with longhaul connections and distances up to 100 km are supported using dual switches with DWDM. See [Fibre Channel Remote Copy Connections](#) on page 603 for further information on installing and configuring the Fibre Channel remote copy connections.
- When serial interface connections are used, ESCON directors (ESCDs) and/or ESCON repeaters are required for distances greater than 3 km (1.9 miles). CA operations can be performed at distances of up to 43 km (26.7 miles) using standard ESCON support. Long-distance solutions are provided, based on user requirements and workload characteristics, using approved protocol converters and communication lines, such as T1/T3/ATM. See [Serial Remote Copy Connections](#) on page 606 for further information on installing and configuring the serial remote copy connections.

The MCU-to-RCU remote copy configuration for CA Asynchronous has different requirements than the CA Synchronous configuration, as follows:

- CA Synchronous supports 1-to-n and n-to-1 remote copy connections ( $n \leq 4$ ). One MCU can be connected to as many as four RCUs, and one RCU can be connected to as many as four MCUs (one MCU/RCU = one physical CU, including all sixteen CU images).

- CA Asynchronous supports 1-to-1 remote copy connections within the same consistency group. The P-VOLs and S-VOLs of the pairs in a consistency group must be located within one physical MCU and one physical RCU. This configuration ensures backup integrity for a data set that is spread across multiple volumes within one XP128/XP1024 (such as large databases).

CA Asynchronous 1-to-n and n-to-1 ( $n \leq 4$ ) configurations (one main disk array and multiple remote disk arrays) are valid for CA Asynchronous, as long as all volumes belonging to any single consistency group are only 1-to-1.

- With direct connect Fibre Channel (no switch), fibre remote copy supports 1-to-1 remote copy connections. One XP128/XP1024 as an MCU can be connected to only one XP128/XP1024 as an RCU via optical fibre cables. For the CU images within one XP128/XP1024, 1-to-4 and 4-to-1 remote copy connections are supported via either direct connects or a FC switch.

HP strongly recommends that you establish at least two independent remote copy connections (one per cluster) between each MCU and RCU to provide hardware redundancy for this critical communications path.

## Initiator Ports and RCU Target Ports

The initiator ports are the dedicated Fibre Channel interface ports on the main disk array (MCU) to which the RCUs (RCU target ports) are connected. The initiator ports connect to the RCUs to send write I/O operations directly to the RCUs. Any Fibre Channel interface port of the XP128/XP1024 can be configured as an initiator port. Use the Port Change operation (see [Port Change Operation](#) on page 657) to change the configuration of the XP128/XP1024 Fibre Channel ports (ordinary target port, initiator port, or RCU target port) as needed.

---

**Note:** The initiator ports cannot communicate with hosts, but are used exclusively as CA talkers. Ordinary target ports are only to be used for host connect (not for CA).

---

The RCU target ports are the (CA) dedicated Fibre Channel interface ports on the remote disk array (RCU) to which the MCU (initiator ports) are connected. Any Fibre Channel interface port of the XP128/XP1024 can be configured as an RCU target port. For performance reasons, the RCU target ports should not be shared with host connects.

## Remote Control Ports (RCPs) and Local Control Ports (LCPs)

The remote control ports (RCPs) are the dedicated serial interface ports on the MCU to which the RCUs are connected. The RCPs emulate host processor channels to enable the MCUs to send write I/O operations directly to the RCUs. The RCPs support the dynamic switching capability provided by the ESCDs. Any serial interface port of the disk array can be configured as an RCP. You can use CA to change the configuration of the disk array serial ports (LCP or RCP) as needed (see [Port Change Operation](#) on page 657).

The local control ports (LCPs) are used for host processor channel interface. All serial interface ports on the disk array have a default setting of LCP. An RCU port connected to an MCU must be in LCP mode to receive remote copy I/O operations from the MCU.

Two or more RCPs must be configured before you can add the RCUs and create the CA volume pairs. The RCPs cannot communicate with the host processor channels and are dedicated to CA operations. The host channel interface paths must be connected to the other interface ports on the disk array.

The serial interface ports, 1S-1Z and 2S-2Z, cannot be specified as RCPs.

The CHA package port that is added to DKA slot cannot be specified as RCPs.

## Command View Management Station

The Command View management station is attached to the XP128/XP1024 on the internal LAN via a TCP/IP connection. The Command View management station communicates with each attached XP128/XP1024.

The Command View management station at the primary site must be connected to the MCU of each CA pair. A second Command View management station should also be installed at the remote site and connected to the RCUs. With another Command View management station at the remote site, you can modify the CA Asynchronous options of the RCU (pending update data rate, offloading timer) and access the CA S-VOLs (for example, to perform media maintenance). If you need to perform CA operations in the reverse direction from the remote site to the primary site (for example, disaster recovery), CA simplifies and expedites this process.

## Host Failover Software

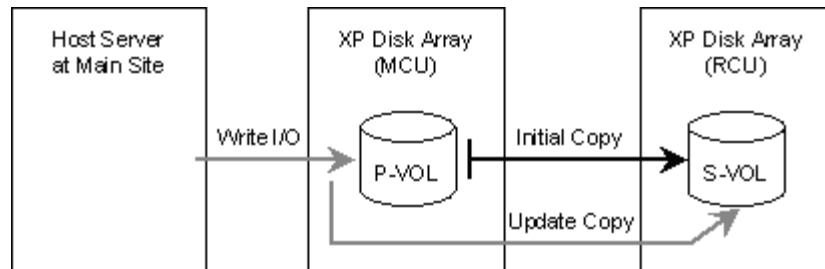
Host failover software, which transfers information between host servers at the primary and remote sites, is a critical component of any disaster recovery effort. Host failover is configured using the host failover software product for the

platform (such as Microsoft Cluster Server or HP Cluster Extension XP), depending on your installation requirements and standards. Command View does not provide any host failover functions.

When CA is used as a data migration tool, host failover is recommended but not required. When CA is used as a disaster recovery tool, host failover is required to ensure effective disaster recovery operations. When a CA pair is suspended due to an error condition, the MCU generates sense information that should be transferred to the remote site via the host failover software for effective disaster detection and recovery.

## Remote Copy Operations

There are two types of CA remote copy operations: initial copy and update copy.



**Figure 224: Remote copy operations**

### Initial Copy Operation

The initial copy operation synchronizes the P-VOL and S-VOL independently of host I/O processes. The initial copy operation is the same for CA Sync and CA Async pairs. A CA initial copy operation takes place when you add a pair (paircreate) or resume a split/suspended pair (pairresync). When a new pair is created, the entire contents of the P-VOL are copied to the S-VOL cylinder by cylinder, except for the diagnostic and unassigned alternate tracks. You can also select **No Copy** for the **Initial Copy** field of the initial copy parameters, which copies only cylinder #0 to the S-VOL. If **No Copy** is selected, the user is responsible for ensuring that the P-VOL and S-VOL are already identical. The MCU cannot verify the contents of the volumes. When a split/suspended pair is resumed (pairresync), only cylinder #0 and out-of-sync cylinders (updated by write I/Os during split/suspension) are copied to the S-VOL. When the CA S-VOL write enable function is used, the RCU keeps track of S-VOL updates and sends

the S-VOL cylinder bitmap to the MCU when the split pair is resumed. In this case the MCU merges the P-VOL and S-VOL bitmaps to identify the out-of-sync cylinders.

For additional flexibility, CA provides the following options for initial copy:

- Use the **Initial Copy Pace** field of the initial copy parameters to specify how many tracks are copied simultaneously by the CA initial copy operation when creating/resuming a CA pair. This option can only be specified using CA.
- Use the **Priority** field of the initial copy parameters specify the order in which the initial copy operations are performed when creating/resuming multiple CA pairs. This option can only be specified using CA.
- Use the **Maximum Initial Copy Activity** option to specify the maximum number of concurrent initial copy operations that each MCU can perform (not pair-specific). This option can only be specified using CA.

## Update Copy Operation

An update copy operation occurs when the host issues a write I/O operation to the P-VOL of an established CA pair. The update copy operation duplicates the P-VOL write I/O at the S-VOL to keep the volume pair synchronized. CA provides two modes for update copy operations: synchronous and asynchronous. The update copy mode is specified when you add a CA pair and is unchangeable for the life of the pair.

For synchronous update copy mode, the MCU can ensure that the P-VOL and S-VOL are synchronized at all times. When using fence level “data” the MCU does not return final ending status for the P-VOL write I/O until the outcome of the P-VOL write and its associated update copy operation at the RCU are known. For synchronous mode, the MCU starts the update copy operation when it receives:

- A write command whose data length is short enough not to pass the track-end, or
- Write data to the track-end, whose total length is long enough to pass the track-end, or
- Write data to the last track for the command.

---

**Note:** No matter how long the write data is, update copy is executed for each track.

---

For asynchronous update copy mode, the MCU stores the P-VOL updates along with additional control information in cache, and sends the updates and control information to the RCU completely independent of the host I/O processes. These updates along with their associated control information are called recordsets. The RCU stores the recordsets in cache and performs the updates to the S-VOLs in the same order as they were performed at the MCU(s) according to the sequence information stored in the recordset. For further information on recordset operations, see [CA Asynchronous Recordset Operations](#) on page 580.

**Priority of initial and update copy:** In both CA Synchronous and CA Asynchronous, update copy has higher priority than initial copy. However, initial copy is executed based on the copy pace (3 or 15 tracks), therefore, update copy must wait this interval if initial copy is being executed. For example, if the copy pace is 15 tracks, the update copy may wait up to 15 tracks (1 cylinder). In the case of CA Asynchronous, update copy is executed asynchronously, but the same scheduling conflict can occur between the asynchronous update copy (write recordset) and initial copy.

## Read and Write I/O Operations for CA Volumes

When an MCU receives a read command for a CA P-VOL, the MCU completes the read from the P-VOL. The MCU will not read the CA S-VOL over the link if a failure has rendered the P-VOL inaccessible.

When an MCU receives a write command for a CA Synchronous P-VOL with COPY status and the track has already been copied to the S-VOL, the MCU performs a synchronous update copy operation to complete the write at the S-VOL. When an MCU receives a write command for a CA Asynchronous P-VOL with COPY status and the track has already been copied to the S-VOL, the MCU performs an asynchronous update copy operation.

When an MCU receives a write command for a CA P-VOL with PAIR status, the user-selected update copy mode (synchronous or asynchronous) determines the sequence of events:

- **Synchronous Mode:** The MCU performs the write operation on the P-VOL, starts the update copy operation for the S-VOL, and then reports final ending status to the host only after the results of the update copy operation are known. If the P-VOL write or S-VOL update copy operation fails, the MCU reports a unit check, and the host system and application program will regard that write operation to the P-VOL as failed.
- **Asynchronous Mode:** The MCU completes P-VOL write operations independently of the associated update copy operations at the S-VOL. The RCU manages the S-VOL updates according to the recordset information and

maintains sequence ordered data consistency for the S-VOLs. If the P-VOL write operation fails, the MCU reports a unit check and does not create the CA asynchronous recordset for this operation. If the update copy operation fails, the RCU optionally suspends either the affected pair or all pairs in the consistency group, depending on the type of failure. When the suspended pair or group is resumed (pairresync), the MCU and RCU negotiate the resynchronization of the pair(s). See [CA Suspend Types](#) on page 593 for further information on suspended CA Async pairs.

The RCU does not allow a CA S-VOL to be online (mounted) during normal CA operations and rejects all host-requested write I/O operations for an S-VOL. The special CA S-VOL write enable option enables write access to an S-VOL while the pair is split (see [S-VOL Write Option](#) on page 580). The S-VOL write option can only be enabled when you split the pair from the MCU.

To reduce the overhead associated with CA remote copy operations, the XP128/XP1024 uses a special write command that is allowed only for CA initial and update copy operations. This CA command transfers the control parameters and the FBA-format data, which includes consecutive updated records in each track, using a single write operation. This capability eliminates the overhead required for performing FBA-to-CKD and CKD-to-FBA conversions.

## S-VOL Write Option

CA provides an S-VOL write option that enables write access to the S-VOL of a split CA pair. The S-VOL write option can be selected by the user during the pairsplit-r operation and applies only to the selected pair(s). The S-VOL write option can be accessed only when you are connected to the MCU. When you resync a split CA pair that has the S-VOL write option enabled, the RCU sends the S-VOL cylinder bitmap to the MCU, and the MCU merges the P-VOL and S-VOL bitmaps to determine which cylinders are out-of sync. This ensures proper resynchronization of the pair.

## CA Asynchronous Recordset Operations

The CA Asynchronous recordsets contain the P-VOL updates and the associated control information, including the sequence number of the P-VOL update, which enables the RCU to maintain update consistency of the S-VOLs. CA Recordset operations include:

- Creating and storing recordsets at the MCU
- Sending recordsets to the RCU
- Storing recordsets at the RCU



- Selecting and settling recordsets at the RCU
- Types of recordsets
- Inflow control for sidefiles

## Creating and Storing Recordsets at the MCU

When an MCU performs an update (host-requested write I/O) on a P-VOL, the MCU creates a recordset that contains: the updated record, sequence number, record location (device, cylinder, track, record number), and record length. The recordsets are queued in the cache storage of the MCU and sent to the RCU independent of host I/O processes. The RCU utilizes the sequence number information in the recordsets to update the S-VOL(s) in the same order as the P-VOL(s).

The sequence number indicates the number of recordsets that the MCU has created for each consistency group. The recordset information, except for the updated records, is stored and queued in an area of cache known as sidefile cache (see [Inflow Control of Recordsets](#) on page 583).

---

**Note:** CA Asynchronous operations continue uninterrupted if the disk array reboots or even if the disk array's internal Service Processor (SVP) fails.

---

## Sending Recordsets to the RCU

The MCU sends the asynchronous CA recordsets to the RCU in a similar manner as the CA synchronous updates. The MCU's initiator ports act as host processor channels and issue special I/O operations, called remote I/Os (RIOs), to the RCU. The RIO transfers the recordsets in FBA format (not CKD) using a single channel command, eliminating the overhead associated with FBA-CKD conversion and thus providing more efficient transfer of data. The MCU can send several recordsets using a single RIO, even if their sequence numbers are not contiguous. Therefore, recordsets are usually sent to the RCU in a different order than the arrivals at the MCU. The RCU ensures that records are applied to the S-VOLs in the correct sequence. This method of remote I/O provides the most efficient use of MCU-to-RCU link resources.

The parameter length and detailed specification of the CA Asynchronous channel command are different than for CA Synchronous RIOs. You must make sure that your channel extenders are capable of supporting this command. For further details, please contact your HP account team.

## Storing Recordsets at the RCU

The RCU maintains queues to control the storing of recordsets in the sidefile and commitment of updating records in the S-VOLs. The RCU queuing mechanism for CA Async uses sequence numbers provided by the MCU to check for missing updates.

The MCU does not remove the sidefile entry for a recordset from its cache until it receives an I/O completion signal (device end) from the RCU. This is true even if the MCU and RCU are connected via a channel extender product. If a recordset is lost in transmission from the MCU to the RCU, the MCU's cylinder bitmap ensures that the missing recordset is identified and resent to the RCU.

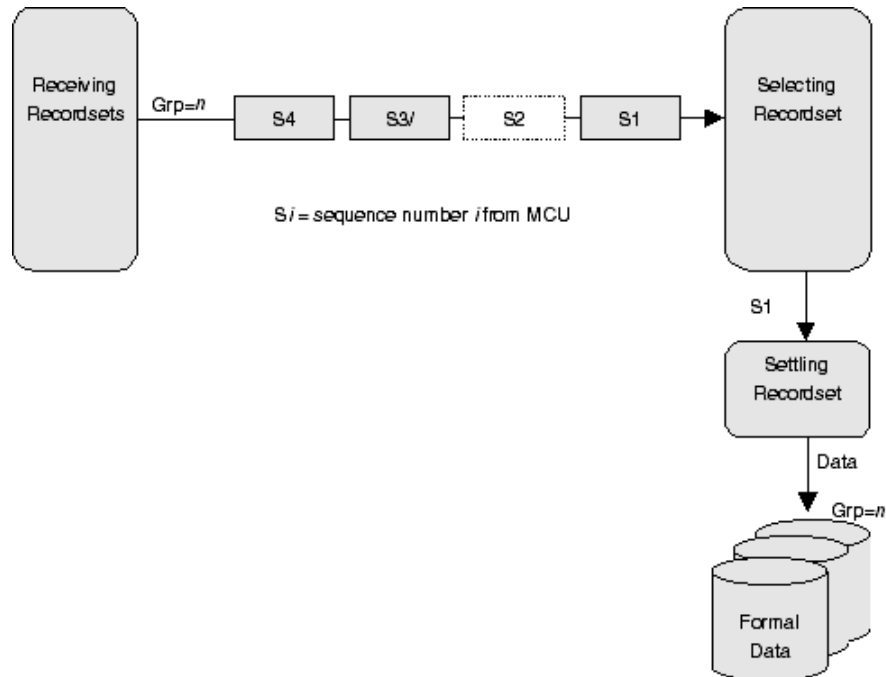
## Selecting and Settling Recordsets at the RCU

The RCU selects the recordset to be promoted to formal data (or “settled”) as follows:

1. The RCU checks for a valid entry at the top of each queue in the consistency group. If the top of any queue is empty (recordset not yet received), the RCU waits for that entry.
2. When the top of each queue contains a valid entry (recordset), the RCU selects the entry that has the earliest sequence number, and then settles this recordset.
3. The RCU repeats this process to select and settle CA Asynchronous recordsets.

The following figure illustrates recordset selection and settling at the RCU. In this example, the top of the queue contains a valid entry: S1. The RCU selects recordset S1 to be settled, because S1 is the earliest sequence number. When S1 is removed from the MCU queue, recordset S2 becomes the top entry, but it is empty. When recordset S2 arrives the RCU selects S2 as the next recordset to be settled. The recordset selected by the RCU is marked as “host-dirty” and treated as formal data. The RCU settles the updated records in the recordset as follows:

- If the corresponding track is in cache (track-hit), the updated records in the recordset are copied to the existing cached track, and the cache space for the sidefile is released.
- If the corresponding track is not in cache (track-miss), the RCU changes the cache designation of the sidefile to formal data. The data is not physically moved.



**Figure 225: Selecting and settling CA Async recordsets at the RCU**

## Types of Recordsets

In addition to host update recordsets, the MCU passes control information to the RCU in special non-update recordsets. These special recordsets indicate when volume pair status changes and when an MCU power-off sequence is initiated, and also maintain sequence numbers in periods of low host activities.

## Inflow Control of Recordsets

As described in the previous sections, both the MCU and RCU create sidefiles for storing CA Asynchronous recordsets. Because the sidefiles occupy exclusive space in cache, both the MCU and RCU perform inflow control to prevent an overload of the disk array's cache resources. The XP128/XP1024 use certain parameters for CA Asynchronous cache inflow control. Use the CA Async Option window (see [Asynchronous Copy Option](#) on page 668) to modify the following parameters:

- **Pending Update Data Rate (%)**: Sidefile (CA) threshold = maximum cache % available for use by CA Asynchronous sidefiles.

- **Offloading Timer (sec.):** Maximum time between CA Async recordset transfers.
- **I/O Delay Start (%):** The threshold, which is the maximum amount of cache for starting the I/O inflow control.
- **I/O Delay Increase (%):** The threshold, which is the maximum amount of cache for starting to strengthen control over the I/O inflow.

**Inflow Control by MCU.** When the amount of MCU sidefile cache reaches the user-specified threshold (*I/O delay start*), the disk array's I/O response is delayed. When the amount of MCU sidefile cache reaches the user-specified threshold (*I/O delay increase*), the disk array's I/O delay starts to increase. If the MCU is not able to send a recordset to the RCU within the user-specified *offloading timer* value, the MCU suspends all affected CA Async volume pairs and resets the SCP condition to avoid hanging up the system.

**Inflow Control by RCU.** When the amount of RCU sidefile cache reaches the user-specified threshold, the RCU responds with channel-command-retry requests to the RIO commands that transfer the recordsets from the MCU. The only recordset accepted by the RCU is the recordset with the sequence number required to continue settling the pending recordsets. If the RCU is not able to settle a recordset within the user-specified offloading timer value, the RCU suspends all CA Asynchronous volume pairs and resets the channel-command-retry condition to avoid hanging up the MCU.

The following table shows the sidefile threshold values for CA Asynchronous operations and write pending operations and describes the actions that occur when each threshold is reached.

**Table 63: Sidefile threshold values for CA Asynchronous operations and write pending operations**

Operation	Threshold(s)	Action(s)
CA Asynchronous	I/O Delay Start (threshold) = 30%. Threshold can be adjusted (to the desired value between 0 and 70% in 1% increment) using CA. Specify a value not exceeding the value of I/O Delay Increase, and Sidefile threshold for the I/O Delay Start threshold.	MCU reaches threshold: I/O delay starts. If the sidefile threshold is set between 0 to 30%, the influence to the I/O delay is kept low. RCU reaches threshold: No action.
CA Asynchronous	I/O Delay Increase (threshold) = 40%. Threshold can be adjusted (to the desired value between 0 and 70% in 1% increment) using CA. Specify the value within range of the I/O Delay Start threshold to the Sidefile threshold for the I/O Delay Increase threshold.	MCU reaches threshold: I/O delay increases. If the sidefile threshold is set between 0 to 30%, the influence to the I/O delay is kept low. RCU reaches threshold: No action.
CA Asynchronous	Sidefile threshold = 50%. Threshold can be adjusted using CA (30, 40, 50, 60, 70%).	MCU reaches threshold: I/O delay. RCU reaches threshold: command retry to MCU.
Write Pending	[write pending] / [avail cache - sidefile] = 70%	Command retry.

HP Cache LUN XP operations may decrease the total amount of cache available for CA Asynchronous operations but do not directly affect sidefile cache usage. Available cache is defined as the amount of physical cache memory installed on the disk array minus any cache reserved for the HP Cache LUN XP feature.

If you do not want to control the inflow into a sidefile, specify the value the same as the Pending Update Data Rate for both values of I/O Delay Start and I/O Delay Increase, and 0 second for the Offloading Timer.

## CA Asynchronous Consistency Group Operations

CA Asynchronous consistency groups enable update sequence consistency to be maintained across an aggregated data set that spans a group of volumes. Both the P-VOLs and S-VOLs of the pairs in a consistency group must be located within one physical MCU and one physical RCU (1-to-1 requirement). The CA consistency group operations include:

- Group options
- Group consistency time

- Group operations

## Group Options

CA provides the following options for each consistency group: **copy pending timeout**, and **RCU ready** timeout. These options are selected when you add a group, and can only be modified when the group does not contain any P-VOLs in the MCU.

**Copy pending timeout.** This group option specifies the maximum delay allowed for CA Async copy operations. The RCU will suspend all S-VOLs in the group when:

- The RCU has not had any communication from the MCU within the specified time. This situation could indicate a disaster or failure at the primary site.
- The RCU has been receiving recordsets from the MCU(s) but has not been able to settle a particular recordset within the specified time. This situation may indicate that the RCU does not have enough resources to handle the remote copy and I/O workloads.

**RCU ready timeout.** This group option specifies the maximum delay allowed for re-establishing MCU-RCU communications following MCU power-off. During MCU power-on, the MCU re-establishes communication with all registered RCUs. If the MCU is not able to re-establish communication with an RCU within the specified time, the MCU suspends all affected CA Asynchronous volume pairs.

## Group Operations

CA Asynchronous provides the following group-based operations to simplify and expedite disaster/failure recovery procedures:

- Group operations at the MCU:
  - Split (pairsplit-r) all pairs in a consistency group. See [Splitting CA Pairs \(Pairsplit-r\)](#) on page 693 for a description of the **Suspend Range-Group** pairsplit-r option.
  - Resume (pairresync) all split or suspended pairs in a group. See [Resuming CA Volume Pairs \(Pairresync\)](#) on page 697 for a description of the CA **Resume Range-Group** pairresync option.
  - Delete (pairsplit-S) all pairs in a group. See [Deleting CA Volume Pairs \(Pairsplit-S\)](#) on page 701 for a description of the **Delete Range-Group** pairsplit-S option.
- Group operations at the RCU:

- Split (pairsplit-r) all pairs in a consistency group. See [Splitting CA Pairs \(Pairsplit-r\)](#) on page 693 for a description of the **Suspend Range-Group** pairsplit-r option.
- Delete (pairsplit-S) all split/suspended pairs in a consistency group except for any inconsistent pairs. See [Deleting CA Volume Pairs \(Pairsplit-S\)](#) on page 701 for a description of the **Delete Range-C/T** pairsplit-S option.
- Delete (pairsplit-S) all pairs in a group regardless of their consistency status. See [Deleting CA Volume Pairs \(Pairsplit-S\)](#) on page 701 for a description of the **Delete Range-Group** pairsplit-S option.

CA also provides the **Error Level** pair option (see [CA Initial Copy and Pair Options of the Paircreate Window](#) on page 691), which is used to trigger automatic suspension of an entire consistency group. When a CA Async pair is suspended due to failure (not user-requested), this CA pair option determines whether all pairs in the same consistency group will also be suspended. If you selected the Group error level for the CA Async pair, all pairs in the same group will be suspended. If you selected the **LU** error level, only the affected CA Async pair will be suspended.

The **Error Level** pair option is very important for managing CA Asynchronous groups and planning for disaster recovery. The Group error level should be selected for all CA Async volumes that are essential to disaster recovery. Suspended CA Async S-VOLs that have the LU error level should not be used for disaster recovery because they will not be consistent with the rest of the volume group.

## CA Volume Pair Status

CA displays the pair status for each volume in the selected logical CU image (CUI) of the connected XP128/XP1024. The following table lists and describes the CA pair status descriptions. The MCU maintains the status of the P-VOL and can change the pair status of the P-VOL and S-VOL. The RCU maintains the status of the S-VOL and can change the pair status of the S-VOL but not the P-VOL. The MCU will detect when the RCU changes the S-VOL status (if the path status is normal) and will change the P-VOL status accordingly. You can display detailed pair status information at the Command View management station (CA Pairdisplay window) or at the UNIX/PC server host (RAID Manager Pairdisplay command).

A volume that is not assigned to a CA pair has the status **SMPL**. When a CA pair is started, the MCU changes the status of the P-VOL and S-VOL to **COPY**. When the initial copy operation is complete, the MCU changes the status of both

volumes to **PAIR**. When a CA pair is split by the user (pairsplit-r), the MCU/RCU changes the status of the P-VOL and S-VOL to **PSUS** (if the path status is normal). When a pair is suspended due to an error condition, the MCU/RCU changes the P-VOL and S-VOL status to **PSUE** (if the path status is normal). When a pair is deleted by the user from the MCU (pairsplit-S), the MCU changes the status of the P-VOL and S-VOL to **SMPL** (if path status is normal). When a pair is deleted from the RCU, the RCU changes the S-VOL status to **SMPL**, and the MCU detects the pair deletion (if path status is normal) and changes the P-VOL status to **PSUS**.

When a CA pair is split or suspended, the MCU generates a service information message (SIM) to notify the host(s). This SIM results in a trap that indicates the reason for suspension.

### CA LUSE Pair Status

For CA LUSE pairs only, the **PDUB** (dubious) status indicates that the status of the CA LUSE volume pair is **COPY** or **PAIR**, but the status of one or more individual LDEV pairs within the CA LUSE pair is **SMPL** or **PSUE** (due to some error condition).

### CA Asynchronous Pair Status

The **Suspending** and **Deleting** transitional states occur when a request to change CA Async pair status has been accepted, but the change to the requested status (**PSUS**, **PSUE**, or **SMPL**) is not yet complete. These states are not reported to the host. In the case of **Suspending**, both the user and the MCU can request the status change. In the case of **Deleting**, only the user can request the status change. If the user requested the status change, the final status is reported at the end of the transition. If an error caused the status to change to **PSUE**, the suspended status is reported at the beginning of the transition.



**Table 64: CA Asynchronous pair status descriptions**

Pair Status	Description	P-VOL Access	S-VOL Access
SMPL (simplex)	This volume is not currently assigned to a CA volume pair. When this volume is added to a CA pair, its status will change to COPY.	Read/write	Read/write
COPY	The initial copy operation for this pair is in progress. This pair is not yet synchronized. When the initial copy is complete, the status changes to PAIR.	Read/write	Read only
PAIR	This pair is synchronized. Updates to the P-VOL are duplicated on the S-VOL.	Read/write	Read only
PSUS (pair suspended-split) (see the following table for split types)	<p>This pair is not synchronized, because the user has split this pair (pairsplit-r), or because the user has deleted this pair from the RCU (pairsplit-S). For CA Async pairs, the MCU and RCU keep track of any recordsets that were discarded during the pairsplit-r operation. While a pair is split, the MCU and RCU keep track of the P-VOL and S-VOL cylinders that are updated.</p> <ul style="list-style-type: none"> <li>■ When you split a pair from the MCU, the MCU changes the status of the P-VOL and S-VOL to PSUS. When you split a pair from the RCU, the RCU changes the status of the S-VOL to PSUS. The MCU detects this (if path status is normal) and changes P-VOL status to PSUS.</li> <li>■ When you delete a pair from the RCU, the RCU changes the S-VOL status to SMPL. The MCU detects this (if the path status is normal) and changes the P-VOL status to PSUS. You must delete the pair from the MCU in order to change the P-VOL status to SMPL.</li> </ul>	Read/write	Read only; Read and write, if write enable split option is selected.

**Table 64: CA Asynchronous pair status descriptions (Continued)**

Pair Status	Description	P-VOL Access	S-VOL Access
PSUE (pair suspended-error) (see the table in <a href="#">CA Suspend Types</a> on page 593 for suspend types)	<p>This pair is not synchronized, because the MCU or RCU has suspended the pair due to an error condition. For CA Async pairs the MCU and RCU keep track of any recordsets that were discarded during the suspension operation. The MCU keeps track of the P-VOL cylinders that are updated while the pair is suspended.</p> <ul style="list-style-type: none"> <li>■ For CA Synchronous pairs, if the MCU cannot keep the pair synchronized for any reason, the MCU changes the status of the P-VOL and S-VOL (if possible) to PSUE.</li> <li>■ For CA Asynchronous pairs, if the MCU detects a suspension condition (see <a href="#">CA Asynchronous Suspension Conditions</a> on page 595), the MCU changes the P-VOL and S-VOL status (if possible) to PSUE.</li> <li>■ For CA Asynchronous pairs, if the RCU detects a suspension condition (see <a href="#">CA Asynchronous Suspension Conditions</a> on page 595), the RCU changes the S-VOL status to PSUE, and the MCU detects this (if the path status is normal) and changes the P-VOL status to PSUE.</li> </ul>	Read/write; Read only if fenced.	Read only
<b>Pair Status for CA LUSE volumes only:</b>			
PDUB	This CA pair consists of LUSE volumes (for example, OPEN3*n), and an individual LDEV within this CA LUSE pair has failed due to some error condition. The status of the CA LUSE volume is PAIR or COPY, and the status of one or more LDEV pairs is PSUE or SMPL.	Read/write	Read only

**Table 64: CA Asynchronous pair status descriptions (Continued)**

Pair Status	Description	P-VOL Access	S-VOL Access
<b>Pair Status for CA Asynchronous only:</b>			
Suspending	This pair is not synchronized. This pair is in transition from PAIR or COPY to PSUS/PSUE. When the split/suspend pair operation is requested, the status of all affected pairs changes to <b>Suspending</b> . When the split/suspend operation is complete, the status changes to PSUS/PSUE.	Read/write	Read only
Deleting	This pair is not synchronized. This pair is in transition from PAIR, COPY, or PSUS/PSUE to SMPL. When the pairsplit-S operation is requested, the status of all affected pairs changes to <b>Deleting</b> . When the pairsplit-S operation is complete, the status changes to SMPL.	Read/write	Read only

### CA Split Types (PSUS)

The following table lists and describes the CA split types. A CA pair can be split by the user at any time after the initial copy operation is complete. The user must split a CA pair in order to perform media maintenance on the P-VOL or to alter the S-VOL (S-VOL write enable).

When a CA Synchronous pair is split by the user, the MCU ensures synchronization by completing any pending update copy operation before changing the status to PSUS. After the pair status changes to PSUS, the MCU stops performing update copy operations to the S-VOL and may or may not continue accepting write I/Os for the P-VOL, depending on the P-VOL fence level and pairsplit-r options. If the P-VOL accepts write operations while the pair is split, the MCU keeps track of the P-VOL cylinders that are updated. If you enabled the S-VOL write option when you split the pair, the RCU keeps track of the S-VOL cylinders that are updated while the pair is split. When the pair is resumed (pairresync), the RCU sends the S-VOL cylinder bitmap to the MCU, and the MCU merges the P-VOL and S-VOL bitmaps to determine which cylinders are out-of-sync.

When a CA Asynchronous pair is split by the user, the MCU and RCU ensure synchronization by either completing or discarding any pending update copy operations according to the user-specified drain/purge pairsplit option. The MCU and RCU keep track of any recordsets that were discarded during the pairsplit operation. After the pair status changes to PSUS, the MCU stops performing recordset operations for the pair, continues accepting write I/Os for the split CA

Async P-VOL, and keeps track of the P-VOL cylinders that are updated while the pair is split. If you enabled the S-VOL write option when you split the pair, the RCU also keeps track of the S-VOL cylinders that are updated while the pair is split. When the pair is resumed, the RCU sends the S-VOL cylinder bitmap to the MCU, and the MCU merges the P-VOL and S-VOL bitmaps to determine which cylinders are out-of-sync.

A split (or suspended) CA Async S-VOL has an additional status called the consistency status. The consistency status is displayed only at the RCU and indicates the S-VOL's update sequence consistency with respect to the other S-VOLs in the same group.

**Table 65: CA split types (PSUS)**

Type	Applies to	Description
PSUS, P-VOL by Operator	P-VOL (CA Sync only)	The user split the pair from the MCU using the <b>P-VOL Failure</b> option. The S-VOL split type is <b>PSUS-by MCU</b> .
PSUS, S-VOL by Operator	P-VOL, S-VOL	The user split the pair from the MCU or RCU using the <b>S-VOL</b> option.
PSUS, by MCU	S-VOL	The RCU received a request from the MCU to split the pair. The P-VOL split type is <b>PSUS-P-VOL by Operator</b> or <b>PSUS-S-VOL by Operator</b> .
PSUS, Delete pair to RCU	P-VOL	The MCU detected that the S-VOL status changed to <b>SMPL</b> because the user deleted the pair (pairsplit-S) from the RCU. The pair cannot be resumed because the S-VOL does not have the <b>PSUS/PSUE</b> status.

The following table lists and describes the consistency status descriptions for split or suspended CA Async S-VOLs (the consistency status is displayed only at the RCU).

**Table 66: Consistency status descriptions for split/suspended CA Async S-VOLs**

Consistency Status (displayed at RCU)	Description
Volume	<p>This CA Asynchronous volume pair was probably split or suspended alone. Update sequence consistency between this S-VOL and other S-VOLs in this consistency group is not ensured. This S-VOL cannot be used for disaster recovery at the secondary site. This status is indicated when:</p> <ul style="list-style-type: none"> <li>■ This pair was split by the user using the <b>Suspend Range-LU</b> pairsplit-r option.</li> <li>■ This pair was suspended due to a failure that did not affect the entire consistency group, and the <b>Error Level</b> pair option for this pair is set to <b>LU</b>.</li> </ul>
Group	<p>This CA Asynchronous volume pair was split or suspended along with the other pairs in its consistency group. Update sequence consistency between this S-VOL and other S-VOLs in this consistency group is ensured. This S-VOL can be used for disaster recovery at the secondary (remote) system (after deleting the CA Async pair from the RCU). This status is indicated when:</p> <ul style="list-style-type: none"> <li>■ This pair was split by the user using the <b>Suspend Range-Group</b> pairsplit-r option.</li> <li>■ All pairs in this consistency group were suspended due to a failure that affected the entire consistency group, not just one pair (for example, MCU-RCU communication failure).</li> <li>■ One pair in the group was suspended due to a failure that did not affect the entire group, and the <b>Error Level</b> pair option for this pair is set to <b>Group</b>.</li> </ul>

## CA Suspend Types

The following table lists and describes the CA suspend types, which indicate the reason for the suspension. CA Synchronous pairs can only be suspended by the MCU. CA Asynchronous pairs can be suspended by the MCU or by the RCU. For further information on CA Async suspension conditions, please see [CA Asynchronous Suspension Conditions](#) on page 595.

The MCU suspends a CA pair when it detects any of the following suspension conditions:

- When the MCU detects that the user has deleted the volume pair from the RCU,
- When the MCU detects an error condition related to the RCU, S-VOL, or a CA update copy operation,
- When the MCU is unable to communicate with the RCU, or
- When the MCU detects a CA Asynchronous suspension condition.

When a CA Sync pair is suspended, the MCU stops performing update copy operations to the S-VOL and may or may not continue accepting write I/Os for the P-VOL, depending on the P-VOL fence level pair option. If a synchronous update copy operation fails, the MCU maintains exact synchronization by reporting a unit check and decommitting the P-VOL update, so that the host system and application program regard that write operation to the P-VOL as failed. If the MCU accepts write I/Os for a suspended P-VOL, the MCU keeps track of the P-VOL cylinders that are updated while the pair is suspended. When a suspended sync pair is resumed, the MCU copies the out-of-sync P-VOL cylinders to the S-VOL. CA does not allow access to an S-VOL while the pair is suspended (only when split).

You must stop host I/Os before suspending CA Synchronous pairs with the Data fence level and the following conditions: CA Synchronous and Asynchronous pairs exist in the same disk array, and there are host I/Os to the CA Asynchronous pairs. If you do not stop host I/Os, the pairs might be forcibly suspended because of a time-out error, and host I/Os will be rejected.

When a CA Asynchronous (CA Async) pair is suspended, the MCU stops performing CA Async recordset operations for the pair. The MCU continues accepting write I/Os for the suspended P-VOL and keeps track of the P-VOL cylinders that are updated while the pair is suspended. The MCU and RCU also keep track of any recordsets that were discarded during the pair suspension. When a suspended CA Async pair is resumed, the RCU sends the S-VOL cylinder bitmap to the MCU, and the MCU merges the P-VOL and S-VOL bitmaps to determine which cylinders are out-of-sync. This method ensures that all cylinders that contain recordsets that were discarded at the RCU are resynchronized at this time.

A suspended (or split) CA Async S-VOL has an additional status called the consistency status. The consistency status is displayed only at the RCU and indicates the S-VOL's update sequence consistency with respect to the other S-VOLs in the same group. Refer to the previous table for a description of the consistency status for suspended/split CA Async S-VOLs.

**Table 67: CA suspend types**

Type	Applies to	Description
PSUE, by RCU	P-VOL, S-VOL	The MCU detected an error condition at the RCU that caused the MCU to suspend the CA volume pair. The S-VOL suspend type is <b>PSUE-S-VOL Failure</b> .
PSUE, S-VOL Failure	P-VOL, S-VOL	The MCU detected an error during RCU communication or an error during update copy. In this case, the S-VOL suspend type is usually <b>PSUE-S-VOL Failure</b> . This suspend type is also used when the number of paths falls below the minimum number of paths setting on the RCU Option window.
PSUE, MCU IMPL	P-VOL, S-VOL	The MCU could not find valid control information in its nonvolatile memory during IMPL. This condition occurs only if the MCU is without power for more than 48 hours (power failure and fully discharged backup batteries).
PSUE, Initial Copy Failed	P-VOL, S-VOL	The CA pair was suspended before the initial copy operation was complete. The data on the S-VOL is not identical to the data on the P-VOL.
PSUE, MCU P/S OFF	S-VOL (CA Async only)	The RCU received a request from the MCU to suspend the S-VOL due to MCU power-off. The RCU stops expecting recordsets from that MCU. The P-VOL status does not change due to MCU power-off.
PSUS, Sidefile overflow (CA Async only)	P-VOL, S-VOL	The amount of sidefile exceeds the specified "current pending update data rate", and the RCU data is not transferred within the specified "offloading timer".

## CA Asynchronous Suspension Conditions

CA Asynchronous operations involve additional suspension conditions related to the recordset operations. Both the MCU and RCU can detect CA Async suspension conditions and suspend CA Async pairs. When a CA Async pair is suspended, the cylinders that contain the following records are marked in the cylinder bitmap as modified (to be copied during the pairresync operation):

- The recordsets that were created by the MCU but not yet sent to the RCU. After marking these P-VOL cylinders as modified, the MCU discards these recordsets.
- The recordsets that were sent to the RCU but not acknowledged by the RCU. The MCU marks these P-VOL cylinders as modified and discards these recordsets. This ensures that recordsets that are lost during transmission to the RCU are identified and marked.

- The recordsets that reached the RCU but have not yet been settled. After marking these S-VOL cylinders as modified, the RCU discards these recordsets.
- The P-VOL records updated by host-requested write I/Os after the pair was suspended (same function as for CA Synchronous pairs).

If a recordset is lost in transmission from the MCU to the RCU, the MCU's cylinder bitmap ensures that the missing recordset is marked. After the MCU sends the recordset to the RCU, the MCU does not remove the sidefile entry for the recordset from its cache until it receives an I/O completion signal (device end) from the RCU.

The following table describes the CA Asynchronous suspension conditions and indicates which CU detects the condition and which pairs are suspended. The CA offloading timer option (see [Asynchronous Copy Option](#) on page 668) and timeout group options (see [Modifying Consistency Group Options \(CT Group Option\)](#) on page 665) are used to control the CA Asynchronous suspension conditions. See [Table 184](#) on page 1287 for troubleshooting information for CA Asynchronous suspension conditions.

**Table 68: CA Asynchronous suspension conditions**

Suspension Condition	Detected by	CA ASYNC Pairs to be Suspended
The MCU could not send a pending recordset to the RCU before the offloading timer async option expired.	MCU	All CA ASYNC pairs with P-VOLs in the MCU.
During MCU power-on, the MCU could not establish communication with the RCU before the RCU ready timeout group option expired.	MCU	All CA ASYNC pairs with P-VOLs in the MCU.
The RCU could not settle a pending recordset before the copy pending timeout group option expired.	RCU	All CA ASYNC S-VOLs in the consistency group.
The RCU could not communicate with the MCU before the copy pending timeout group option expired (see <a href="#">Modifying Consistency Group Options (CT Group Option)</a> on page 665).	RCU	All CA ASYNC S-VOLs in the consistency group.



**Table 68: CA Asynchronous suspension conditions (Continued)**

Suspension Condition	Detected by	CA ASYNC Pairs to be Suspended
The RCU could not receive the recordset successfully due to a hardware failure.	RCU	Only the affected S-VOL.
The RCU detected a logical error while selecting the recordset to be settled.	RCU	All CA ASYNC S-VOLs in the consistency group, or only the affected S-VOL, depending on the type of failure and the error level CA ASYNC pair option.
The RCU could not settle the recordset due to a hardware failure, track condition, or logical error.	RCU	

## Preparing for CA Operations

### System Requirements

CA operations involve the MCUs and RCUs containing the primary and secondary volumes, the remote copy connections between the MCUs and RCUs, the UNIX and/or PC server host(s) at the primary and remote sites, CA, and the Command View management station. The CA system requirements are:

- **MCU:** disk array with CA installed.
- **RCU:** disk array with CA installed.
- **UNIX-based and/or PC server platforms:** The disk array supports CA operations for a variety of UNIX and PC-server platforms, including the Sun Solaris, IBM AIX, HP-UX, and Windows NT platforms. Please contact your HP account team for the latest information on XP128/XP1024 platform support for CA.
- **Remote copy connections – Fibre Channel:**
  - Multimode optical fibre cables are required at both the MCU and RCU.
  - For distances from 0.5 km to 11 km, multimode shortwave Fibre Channel interface cables with up to two switches are required.
  - For distances greater than 11 km, approved third-party channel extender (or DWDM) products and telecommunications lines are required.
- **Remote copy connections – serial:**
  - Multimode serial interface (ESCON) cables are required at both the MCU and RCU.
  - For distances from 3 km to 43 km (1.9 to 26.7 miles), single-mode serial interface cables with ESCON directors (ESCDs) and/or ESCON repeaters are required.
  - For distances greater than 9 km (5.6 miles), the extended distance facility (XDF) provided by the ESCDs and/or ESCON repeaters is required.
  - For distances greater than 43 km (26.7 miles), approved third-party channel extender products and telecommunications lines are required. Long-distance solutions are provided based on user requirements and workload characteristics. Usage of channel extenders may require additional disk array configuration.

- **Command View management station:** The Web browser is required to operate Command View and CA. Also the CA license key codes are required. If you are using CA for disaster recovery, install a second Command View management station at the remote site.

---

**Note:** You must operate Command View in Modify mode to perform CA operations. Users in view mode can only view CA information.

---

## Requirements and Restrictions

CA has the following requirements and restrictions:

- One-to-one volume copy operations
- Logical unit (LU) type (also called device emulation or type)
- Consistency groups
- Accessing CA P-VOLs and S-VOLs
- Cache and NVS
- Host failover software
- Duplicate volume
- Host system crash

### One-to-One Volume Copy Operations

CA requires a one-to-one relationship between the logical volumes of the volume pairs. A volume (LU) can only be assigned to one CA pair at a time. CA does not support operations in which one P-VOL is copied to more than one S-VOL, or more than one P-VOL is copied to one S-VOL. Because CA operates on logical volumes rather than on files, multivolume files require special attention. For complete duplication and recovery of a multivolume file (such as a large database file that spans several volumes), make sure that all volumes of the file are copied to CA S-VOLs, and use CA Asynchronous to ensure update sequence consistency across this group of S-VOLs.

## Logical Unit (LU) Types

CA supports the basic LU types that can be configured on the disk array. CA displays the LU type of the P-VOLs and S-VOLs. A CA pair must consist of LUs of the same type and capacity (for example, OPEN-3 to OPEN-3). Mainframe volumes (for example, 3390-3A/B/C, 3380-KA/B/C) cannot be assigned to CA pairs.

---

**Note:** Please contact your HP account team for the latest information on supported devices for your platform.

---

CA supports the LU Size Expansion (LUSE) feature of the disk array, which configures expanded LUs using two or more contiguous LDEVs (up to 36). When LUSE volumes are assigned to a CA pair, the P-VOL and S-VOL must contain the same type and number of LDEVs (for example, OPEN-3\*6 to OPEN-3\*6). The number of LDEV pairs in a CA LUSE pair equals the number of LDEVs in each LUSE volume. When the status of all LDEV pairs within one CA LUSE pair is not the same (for example, one LDEV pair is suspended), the pair status of the CA LUSE pair changes to PDUB.

CA also supports the VSC feature of the disk array, which configures custom-size LUs that are smaller than standard-size LUs. When custom-size LUs are assigned to a CA pair, the S-VOL must have the same capacity as the P-VOL.

## Consistency Groups

The CA Asynchronous consistency groups have the following requirements:

- Each CA Async pair must be assigned to one and only one consistency group.
- The maximum number of volume pairs in one consistency group is 4,096 (entire RCU) (4,095 when the Raid Manager command device is defined).
- The maximum number of consistency groups established for one MCU-RCU pair is 128 (00-7F). The RCU supports a maximum of 128 groups. This limit of 128 groups includes both CA Async groups and Mainframe mirroring Asynchronous groups (for example, 64 CA Async + 64 mainframe).
- A CA consistency group must consist only of CA Async pairs (no mainframe pairs).

## Accessing CA P-VOLs and S-VOLs

To ensure maximum data integrity during normal CA operations, the RCU rejects all write operations issued by a host to a CA S-VOL. If you need write access to a CA S-VOL, you must split the pair using the S-VOL write option (see [S-VOL Write Option](#) on page 580). When you resume (resync) the split pair, the RCU will send the S-VOL cylinder bitmap to the MCU to ensure proper resynchronization of the pair.

## Cache and Nonvolatile Storage (NVS)

Cache and nonvolatile storage (NVS) must be operable for both the MCU and RCU of a CA volume pair. If not, the CA paircreate operation will fail. The remote disk array cache should be configured to adequately support the CA remote copy workloads as well as any local workload activity.

## Host Failover Software

Host failover software is a critical component of any disaster recovery effort. When an MCU fails to maintain synchronization of a CA pair, the MCU generates sense information. It is very important that this information be transferred to the remote site via the host failover software for effective disaster recovery.

## Duplicate Volumes

Because the contents of the P-VOL and S-VOL of a CA pair are identical, the S-VOL can be considered a duplicate of the P-VOL. Because the host operating system does not allow duplicate volumes, the host system administrator must take precautions to prevent system problems related to duplicate volumes. You must define the CA S-VOLs so they do not auto-mount or come online to the same host at the same time as the P-VOLs (see the following **CAUTION**).

CA does not allow the S-VOL to be online (except when the pair is split). If the S-VOL is online, the CA paircreate operation will fail.



**Caution:** If the CA S-VOLs are physically attached to the same host server(s) as the CA P-VOLs, the following problem can occur:

When a CA pair is deleted, the old S-VOL is usually offline. If the host is then restarted, the system administrator may be offered both volumes and asked which volume should be left offline. This can be confusing and is prone to error.

If the CA S-VOLs and P-VOLs are connected to the same host(s), HP strongly recommends that the S-VOLs are defined to remain offline (or created with the Raid Manager 'no read' option) to avoid this problem.

---

## Host System Crash

The contents of the P-VOL and S-VOL of a CA pair may become inconsistent if the host system hangs (crashes) while a write operation is being performed on the CA P-VOL, and the write operation cannot be retried because of the following reasons:

- A check condition is reported to the host due to a failure in the disk array when the write command for the CA pair is issued.
- A reset command is issued from the host and the write operation is stopped (the write operation is incomplete).

If these conditions occur, you must retry the job to complete the write operation.

## Installing the Hardware

Initial installation of the CA hardware is performed by the user and the HP representative. The hardware configurations for CA Synchronous and CA Asynchronous are the same.

### To install the hardware required for CA operations:

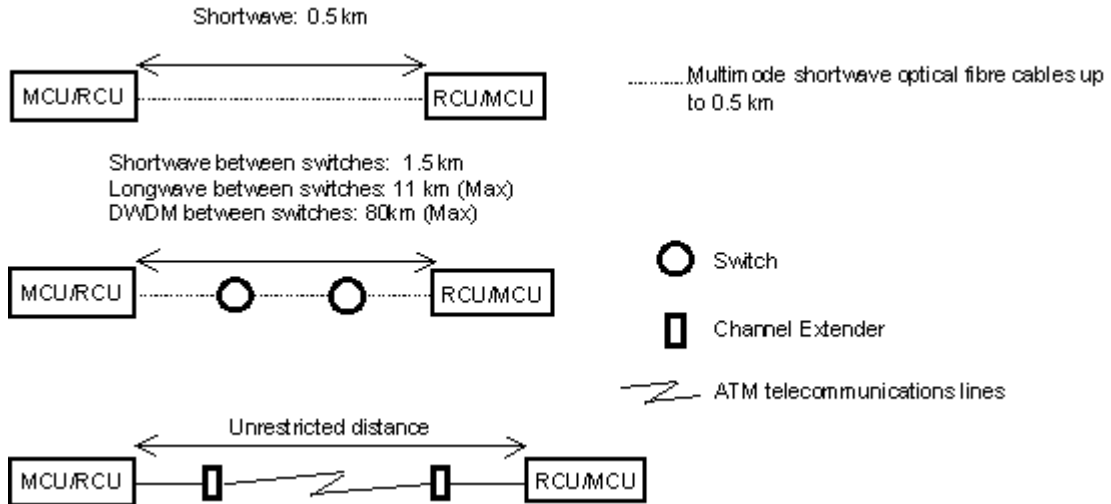
1. **User:** Identify the locations of the CA primary and secondary volumes (P-VOLs and S-VOLs), so that the Performance Advisor hardware can be installed and configured properly.
2. **User and HP representative:** Install the Command View management station near the CA MCU(s), and connect the Command View management station to the MCU(s) via the internal LAN. HP recommends that you also install a Command View management station connected to the RCUs at the remote site.

3. **HP representative:** Make sure that the MCUs and RCUs are properly configured for CA operations (for example, cache, NVS) (see [Cache and Nonvolatile Storage \(NVS\)](#) on page 601). Make sure that adequate cache is installed and available for all open systems and mainframe asynchronous mirroring operations. You must also consider the amount of HP Cache LUN XP data to be stored in cache when determining the required amount of cache.
4. **HP representative:** Make sure the MCUs are configured to report sense information to the host(s). The RCUs should also be attached to a host server to enable reporting of sense information in case of a problem with an S-VOL or RCU. If the remote site is unattended, the RCUs should be attached to a host server at the primary site, so that the system administrator can monitor the operational condition of the RCUs.
5. **HP representative:** If power sequence control cables are used, set the power select switch for the cluster to LOCAL to prevent the MCU from being powered off by the host. Also make sure the RCU will not be powered off during CA operations. See [Powering Off/On CA Components](#) on page 709 for further information on powering off/on the MCUs and RCUs.
6. **HP representative:** For Fibre Channel interface connections, install the Fibre Channel adapter features. For serial interface connections, install the serial port adapter features. If the MCU and RCU are multiplatform disk arrays, there may be available serial interfaces, and additional serial port adapter features may not be required.
7. **HP representative:** Install the CA remote copy connections between the MCU(s) and RCU(s). This hardware (optical fibre cables, switches, ESCON cables, etc.) is supplied by the user. See [Fibre Channel Remote Copy Connections](#) on page 603 for remote copy configurations. Distribute the paths between different storage clusters and switches to provide maximum flexibility and availability. The logical paths between the MCU and RCU must be separate from the logical paths between the host and RCU. For Fibre Channel and serial interface connections, only CA activities (Sync and Async) can share the same direct connect or switch zoned fibre remote copy connections (future support will eliminate this restriction).

## Fibre Channel Remote Copy Connections

The following figure shows the remote copy connection configurations for Fibre Channel interface CA operations. The MCU and RCU of each CA pair must be connected via multimode shortwave optical fibre cables. Using multimode shortwave optical fibre cables, fibre cables up to 1.5 km in length and up to two switches are required for distances greater than 0.5 km. If you use single-mode

longwave optical fibre cables between the two switches, fibre cables up to 11 km in length can be used (.5km+10km+.5km). The use of DWDM between the two FC switches can allow a distance of 80km or more. Long-distance solutions are provided using approved channel extenders and communication lines.



**Figure 226: Fibre Channel remote copy connections**

---

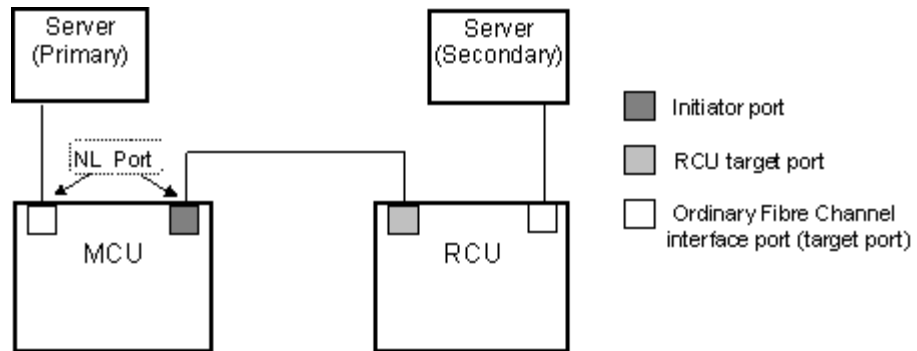
**Note:** For Fibre Channel interface connections, you can use the switches as ordinary switch connections. No special settings are required for the XP128/XP1024.

---

Fibre Channel interface connection provides three different configurations:

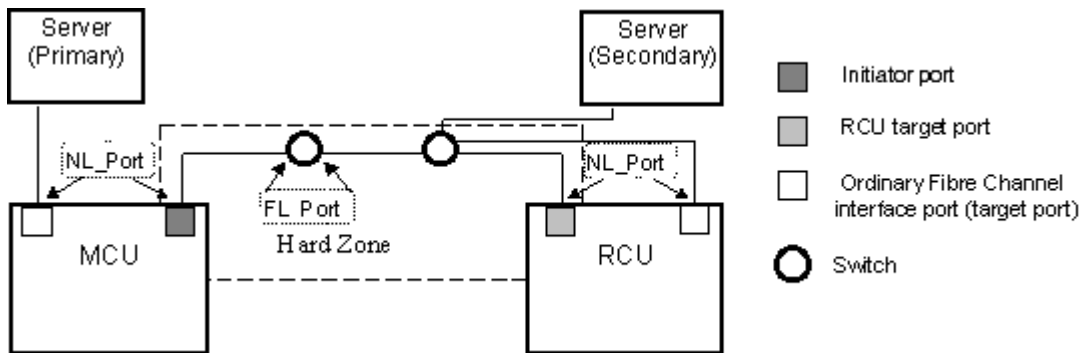
- **Direct connection:** Two devices are connected directly together.





**Figure 227: Direct connection**

- **Switch connection:** Up to three optical fibre cables (per hard zone) are connected together via the switches to connect the devices. Up to two switches can be used.



**Figure 228: Switch connection**

- **Extender connection:** Protocol converters and switches are used to connect the devices across large distances.

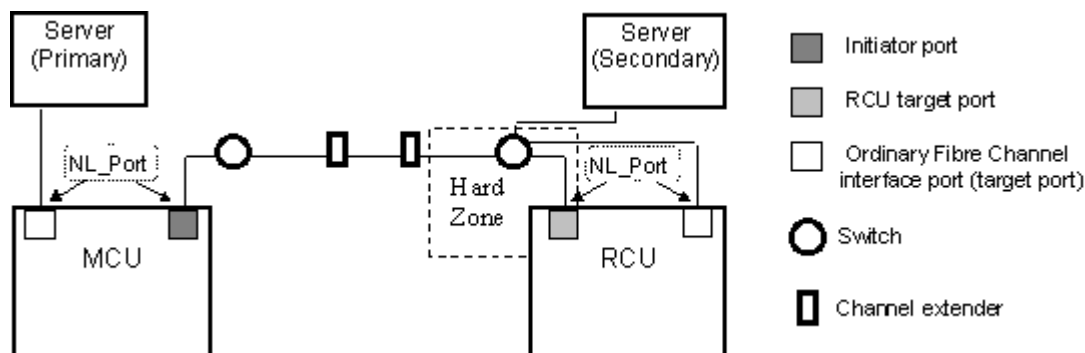
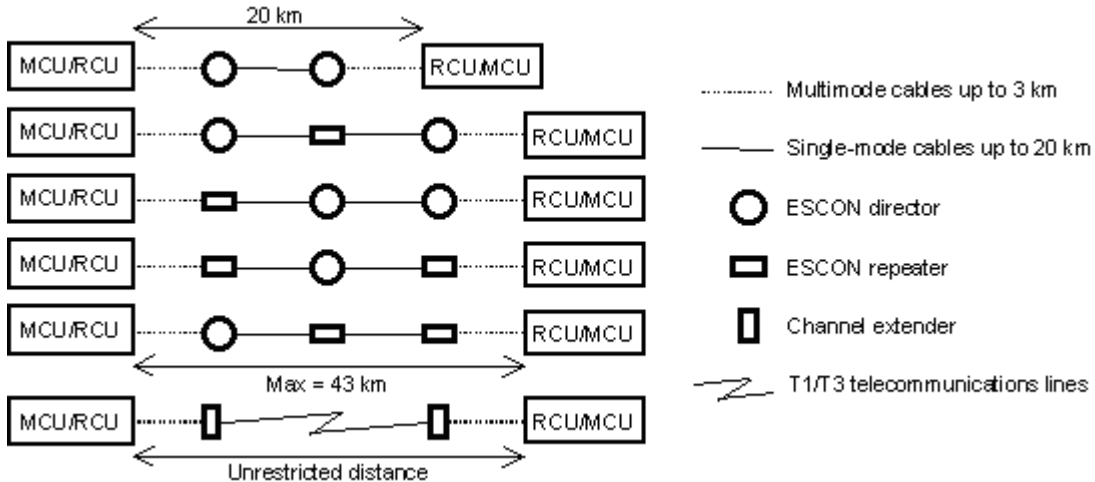


Figure 229: Extender connection

## Serial Remote Copy Connections

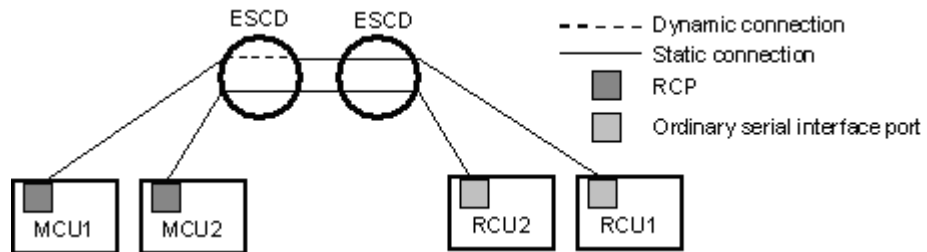
The following figure shows the CA serial remote copy connection configurations. The MCU and RCU of each pair must be connected via multimode ESCON cables. For distances greater than 3 km, single-mode cables up to 20 km in length and ESCDs and/or ESCON repeaters are required. ESCDs support the extended distance facility (XDF), which uses single-mode ESCON cables up to 20 km. ESCON repeaters support single-mode-to-single-mode connection or single-mode-to-multimode connection. When the disk arrays running CA are more than 9 km apart, the XDF connections provided by the ESCDs or ESCON repeaters are required. CA operations can be performed at distances of up to 43 km (26.7 miles) using standard ESCON support. Long-distance solutions are provided using approved channel extenders and communication lines.



**Figure 230: Serial remote copy connections**

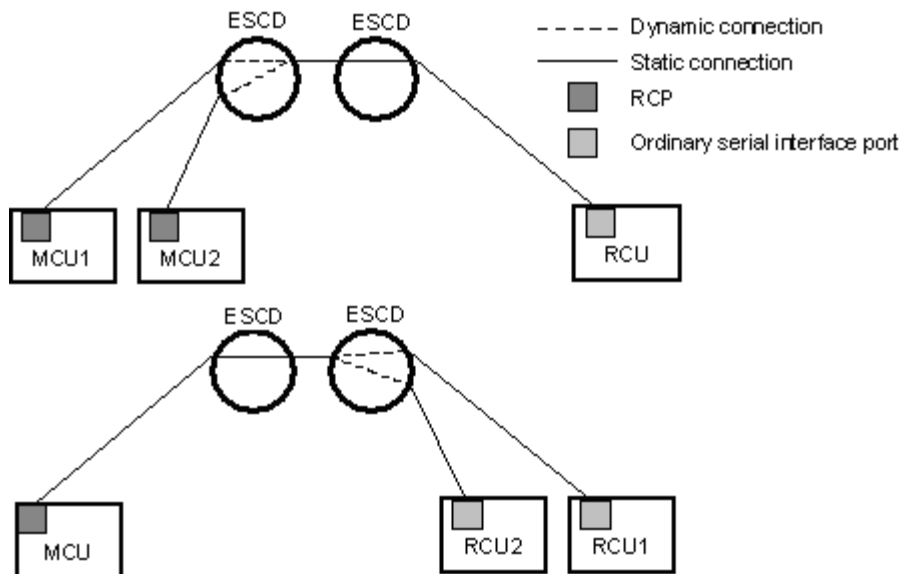
Dedicated ESCON channels may be installed, or existing ESCON channels connected by ESCDs may be used. The logical paths between the MCU and RCU must be separate from the logical paths between the host and RCU. All remote copy activities between two XP disk arrays can share the same remote copy connections.

The ESCDs can accommodate multiple MCU-RCU remote copy connections (see [Figure 231](#)).



**Figure 231: N pairs of remote copy connections**

N-to-1 or 1-to-n remote copy connections ( $n \leq 4$ ) can also be configured by using the dynamic switching capability of the ESCDs to share the physical interface cables between the components (see [Figure 232](#)).



**Figure 232: N-to-1 and 1-to-n remote copy connections ( $n \leq 4$ )**

---

**Note:** 1-to-n configurations (one main disk array and multiple remote disk arrays) are valid for CA Asynchronous, as long as a consistency group does not span remote disk arrays.

---

In addition, the ESCDs can accommodate channel-to-MCU and channel-to-RCU connections in addition to the remote copy connections (see [Figure 233](#)).

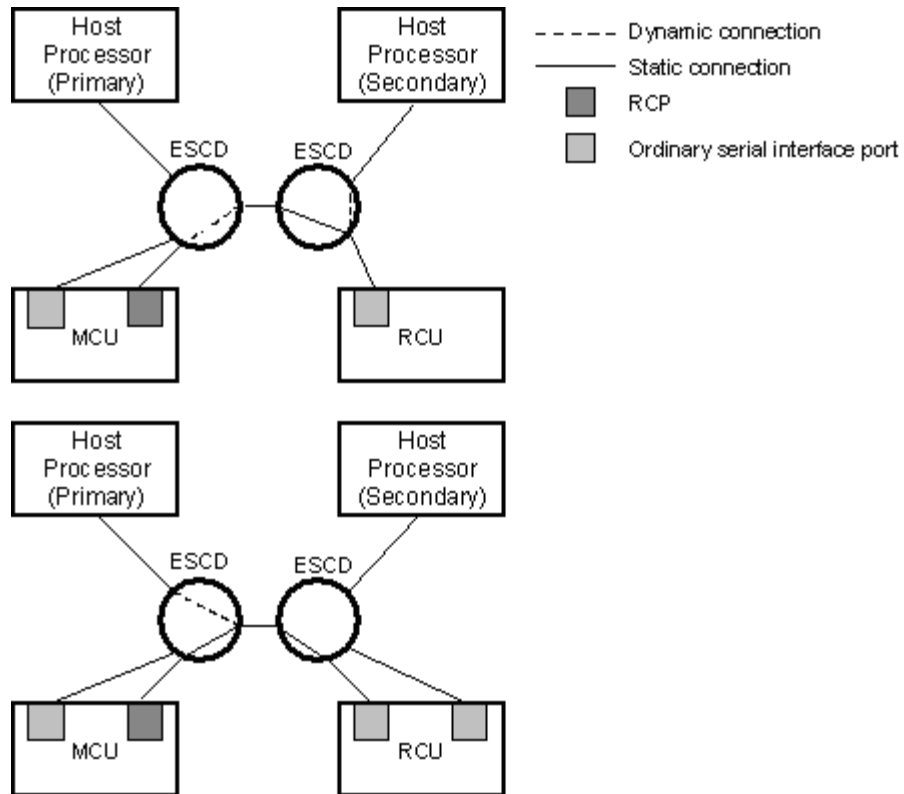


Figure 233: Remote copy connections shared with channel-to-RCU connections

## Configuring the MCUs and RCUs for CA Operations

After you have prepared the hardware and software, you can configure the MCUs and RCUs for CA operations.

### Fibre Channel and Serial Interface Configuration

**To configure the MCUs and RCUs for CA operations:**

1. Identify the volumes that will become the CA P-VOLs and S-VOLs. You need to know the disk array S/N, SSID, and CU image of each CA volume, so that you can configure the MCUs and RCUs correctly for your pairs and async groups. When you create the pairs, you will need to know the port, target ID, and LUN of each volume.

2. If Performance Advisor (PA) is connected to the disk array to be configured as a CA MCU, disconnect PA to avoid contention on the internal LAN.
3. For FC configurations, at the RCUs, use CA to configure the Fibre Channel ports that are connected to the MCUs as RCU target ports (see [Port Change Operation](#) on page 657 for instructions).
4. Connect to the disk array that you want to configure as a CA MCU.

---

**Note:** You must operate Command View in Modify mode to perform CA operations. Users in view mode can only view CA information.

---

5. Click the **CA** tab to start CA. The CA main screen is displayed (see [Figure 240](#)).
6. For FC configurations, configure the Fibre Channel ports that are connected to the RCUs as initiator ports. For serial interface configurations, configure the serial channel ports that are connected to the RCUs as RCPs. For instructions, see [Port Change Operation](#) on page 657.
7. Register the RCU(s) to the current MCU CU image using the Add RCU window. Set the options for the registering RCU using the RCU Option window (see [Registering an RCU \(Add RCU\)](#) on page 642 for instructions).

**Add RCU**

RCU S/N:

Controller ID:

Logical Adr.(RCU CU#):

SSID:

**MCU-RCU Path**

MCU Port	RCU Port
<input type="text"/>	<input type="text"/>
<input type="text"/>	<input type="text"/>
<input type="text"/>	<input type="text"/>
<input type="text"/>	<input type="text"/>
<input type="text"/>	<input type="text"/>
<input type="text"/>	<input type="text"/>
<input type="text"/>	<input type="text"/>
<input type="text"/>	<input type="text"/>
<input type="text"/>	<input type="text"/>
<input type="text"/>	<input type="text"/>

Option Cancel

Java Applet Window

**RCU Option**

Minimum Paths:

Maximum Initial Copy Activity

4 Volumes  16 Volumes

RIO MIH Time (sec.):

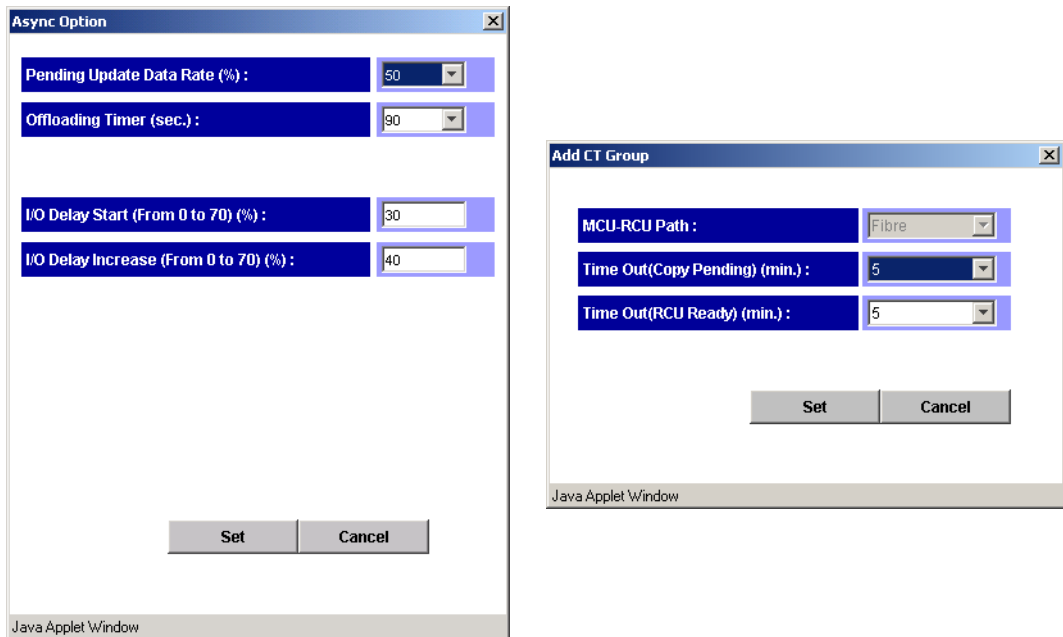
Path Blockade Watch (sec.):

Set Cancel

Java Applet Window

**Figure 234: Add RCU and RCU Option windows**

- If you plan to create CA Async pairs with P-VOLs in this MCU, configure the Async options using the Async Option window (see [Asynchronous Copy Option](#) on page 668 for instructions). Then register the consistency group(s) to the MCU using the Add CT Group window (see [Adding Consistency Groups \(Add CT Group\)](#) on page 663 for instructions).



**Figure 235: Async Option and Add CT Group windows**

9. When you are finished configuring this MCU, exit the CA main screen, and disconnect the Command View management station from the disk array.
10. If needed, you can reconnect Performance Advisor to this disk array now (running PA at the same time is not supported).
11. Repeat [step 4](#) - [step 9](#) for each disk array, which will function as a CA MCU. After you have configured the MCUs, registered the RCUs, and configured the CA async options and consistency groups, you are ready to begin CA volume pair operations.

## Combining CA with Other Data Management Operations

CA supports concurrent operations with the following data management functions:



- **LU Size Expansion (LUSE).** LUSE volumes can be assigned to CA pairs, provided that the P-VOL and S-VOL have the same LU type and the same number of LDEVs. If you need to perform LUSE operations on an existing CA P-VOL or S-VOL, you must delete the pair first to return the volume to SMPL status.
- **VSC.** Custom volumes can be assigned to CA pairs, provided that the S-VOL has the same capacity than the P-VOL. If you need to perform VSC operations on an existing CA P-VOL or S-VOL, you must delete the pair first to return the volume to SMPL status.
- **HP Cache LUN XP.** HP Cache LUN XP volumes can be assigned to CA pairs, and HP Cache LUN XP operations can be performed on CA P-VOLs and S-VOLs.
- **LUN Security.** LUN Security operations do not affect CA operations. Volumes that are under secure ports and/or that are assigned to World Wide Name (WWN) groups and/or LUN groups can also be assigned to CA pairs. Volumes that are assigned to CA pairs can also be assigned to secure ports, WWN groups, and/or LUN groups for LUN Security.

---

**Note:** CA S-VOLs cannot be accessed by any UNIX/PC server host except when the pair is split.

---

- **BC.** BC volumes can be assigned to CA pairs, and CA volumes can be assigned to BC pairs. See [Combining CA and BC](#) on page 613 for information on CA and BC shared volume configurations.  
  
BC is recommended for intra-disk array copy operations. If BC is not installed, CA (Synchronous only) can be used to copy within the same disk array. This configuration requires at least one external fibre cable or ESCON loop.
- **Prioritized Port Control.** The initiator ports in the MCU do not support the Prioritized Port/WWN Control option.

## Combining CA and BC

Continuous Access and Business Copy can be used together in the same disk array and on the same volumes to provide multiple copies of data at the primary and/or remote sites. The following table describes the host pair status reporting for CA volumes, BC volumes, and CA/BC shared volumes. The table after next shows the currency of the data on a shared CA/BC volume based on CA and BC pair status.

- For shared CA/BC volumes, the CA pair status is reported to the host if you query the CA P-VOL or S-VOL. To obtain the BC pair status, query the P-VOL of the BC pair.
- BC supports multiple S-VOLs for each P-VOL. If you issue a pair status query to a BC P-VOL (for example, pairdisplay), the status for only one BC pair is reported (the pair with the S-VOL with the lowest LDEV ID). To obtain the pair status for the BC pair(s) with the other S-VOL(s), you must direct the host query to the specific S-VOL using the S-VOL's LDEV ID in the host command. The BC remote console software displays the LDEV ID and BC pair status of all S-VOLs associated with a P-VOL.

**Table 69: Host pair status reporting for CA, BC, and CA/BC shared volumes**

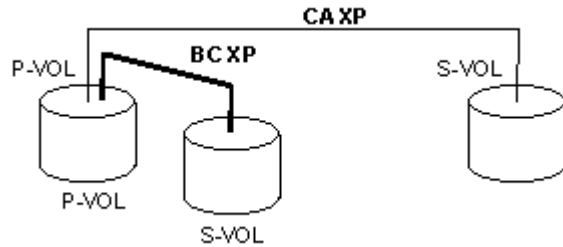
Number of CA Pairs	Number of BC S-VOLs	Pair Status Reported by the Disk Array
0	0	Simplex
0	1	BC pair status
0	2 or more	BC pair status for the pair whose S-VOL has the lowest LDEV ID
1	0	CA pair status
1	1	CA pair status
1	2 or more	CA pair status

**Table 70: Data Currency of a shared CA/BC volume**

CA Pair Status	BC Pair Status					
	COPY (PD)	PAIR	COPY (SP)	PSUS	COPY (RS/RS-R)	PSUE
COPY	Not current	Not current	Not current	CURRENT	Not current	Not current
PAIR	Not current	Not current	Not current	CURRENT	Not current	Not current
PSUS/PSUE	Not current	CURRENT	CURRENT	CURRENT	CURRENT	Not current

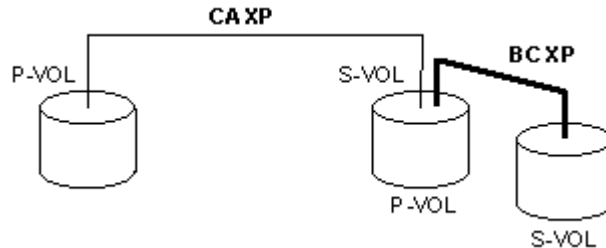
The following figures show the various CA/BC configurations that share volumes. CA supports synchronous and asynchronous operations for shared CA/BC volumes.

- The following figure shows an example of a CA P-VOL that is also functioning as a BC P-VOL. With this configuration, you can use BC for on-site data backup in case of a CA failure, and use CA to provide remote backup of the BC P-VOL in case of a BC failure.



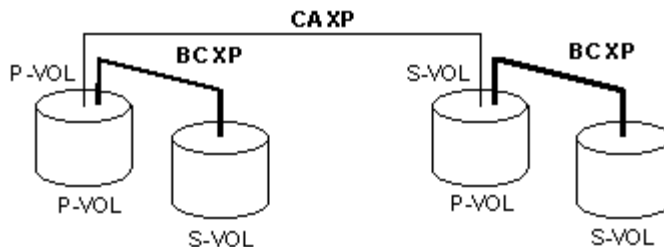
**Figure 236: Shared CA P-VOL and shared BC P-VOL**

- The following figure shows an example of a CA S-VOL that is also functioning as a BC P-VOL. With this configuration, you can use BC to provide multiple backup copies of a single CA P-VOL.



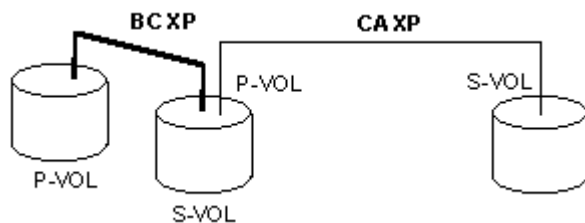
**Figure 237: Shared CA S-VOL and shared BC P-VOL**

- The following figure combines the configurations shown in the two previous figures. Within a single CA pair, the P-VOL and S-VOL are both functioning as BC P-VOLs, providing multiple copies at the primary and remote sites.



**Figure 238: Shared CA/BC P-VOL and shared CA S-VOL/BC P-VOL**

- The following figure shows an example of a BC S-VOL that is also used as a CA P-VOL.



**Figure 239: Shared BC S-VOL/CA P-VOL**



**Caution:** This configuration requires that the BC pair be established in duplex mode (PAIR) and then split (PSUS) before the CA pair is created (and both BC and CA being in PAIR state at the same time is not allowed).

---

## Starting CA

You must operate Command View in Modify mode to perform CA operations. Users in view mode can only view CA information.

### To start CA:

1. From the Launch screen, click an XP128 or XP1024.
2. Click the **CA** tab. The CA main screen is displayed.

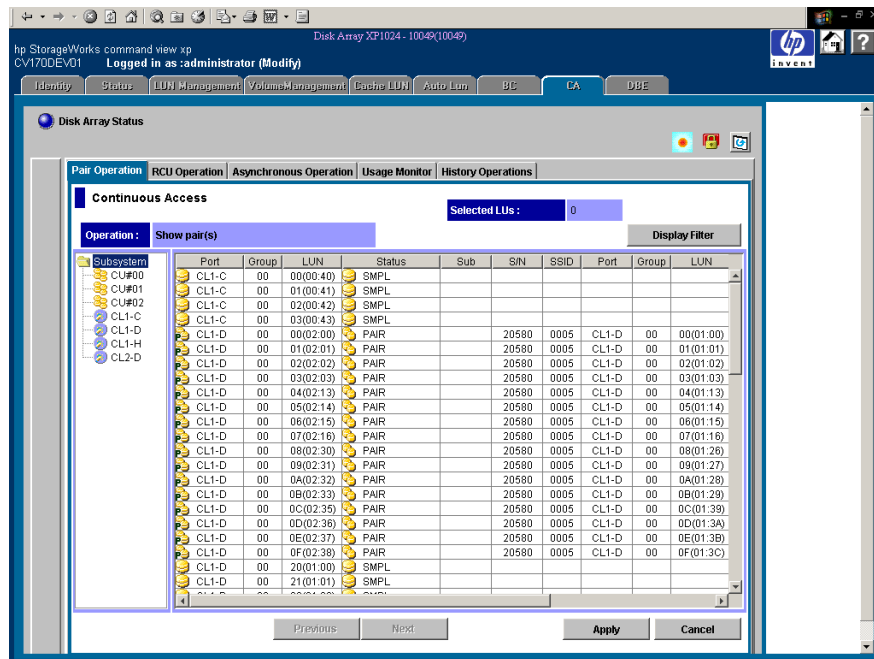


Figure 240: CA main screen

## CA Screens

To access any of the CA screens, click one of the following tabs: **Pair Operation**, **RCU Operation**, **Asynchronous Operation**, **Usage Monitor**, and **History Operations** tabs.

The CA main screen (also known as the Pair Operation screen) is displayed by clicking the **Pair Operation** tab. This screen shows the information for the selected CU image of the connected disk array and provides access to all CA functions.

The following table shows the CA functions of each tab. To apply the settings you made on the CA function tabs, click **Apply**.

**Table 71: CA functions**

Tab	Menu Command	Description
Pair Operation	Pairstatus	Displays the CU information, path information, pair status, and settings information of the CA pairs. Monitoring LDEV status is not supported.
	Paircreate > Synchronous	Sets new CA Synchronous pairs.
	Paircreate > Asynchronous	Sets new CA Asynchronous pairs.
	Pairsplit - S	Deletes the CA pairs that are already set.
	Pairsplit - r	Splits or suspends the CA pairs.
	Pairresync	Resumes the CA pairs that are split or suspended. Resuming in LDEVs is not supported.
	Change Pair Option	Modifies the pair options that are originally set (Fence level or Error level).
RCU Operation	RCU Status	Displays the RCU status and CA port numbers that are already set.
	RCU Operation > Add RCU	Registers the RCU at the remote disk array. RCU controls the S-VOL of the CA volume pair.
	RCU Operation > Delete RCU	Deletes the RCU that is already registered.
	RCU Operation > Change RCU Option	Modifies the options for RCUs that are already registered.
	Edit SSIS(s) & Path(s) > Add Path	Adds the paths to RCUs.
	Edit SSIS(s) & Path(s) > Delete Path	Deletes the paths to RCUs.
	Edit SSIS(s) & Path(s) > Add SSID	Adds the SSIDs of RCUs that are connected to MCU.
	Edit SSIS(s) & Path(s) > Delete SSID	Deletes the SSIDs of RCUs that are already connected to MCU.
	Port	Changes the port types for the connected disk array.

**Table 71: CA functions (Continued)**

Tab	Menu Command	Description
Asynchronous Operation	CT Group Operation > CT Group Status	Displays the information of the consistency groups that are already registered.
	CT Group Operation > Add CT Group	Assigns the CUs to the consistency groups.
	CT Group Operation > CT Group Option	Modifies the settings for the consistency groups that are already assigned.
	CT Group Operation > Delete CT Group	Deletes the consistency groups that are already assigned.
	Async Option	Sets and modifies the asynchronous copy options.
Usage Monitor	--	Collects and displays I/O statistics using the Remote Copy Monitoring function.
History Operations	--	Displays the operation history of the CA volume pairs.

---


**Note:** The scripting function is not supported for this version.

---

## CA Main Screen (Pair Operation Screen)

The first screen that is displayed after clicking the **CA** tab is the CA main screen, also known as the Pair Operation screen. To display this screen at any time, click the **Pair Operation** tab from any of the other CA screens.

The CA main screen displays information for the selected CU image of the connected disk array. From this screen, you can configure the volume pairs. This section describes the components of the CA main screen. For information about CA volume pair configuration, see [Performing CA Pair Operations](#) on page 680.

Information displayed on the CA main screen is updated when the CA main screen is opened, when the tab is switched from one to another, and when the **Refresh** button () is clicked. The pair information is also updated by clicking **Apply**.

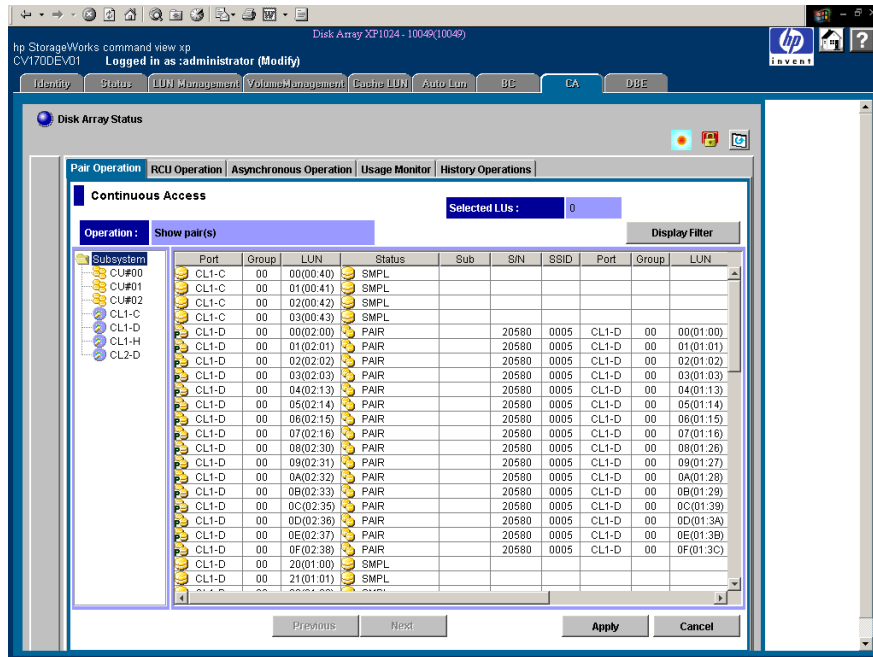


Figure 241: CA main screen (Pair Operation screen)

The CA main screen contains the following items:

- **CU Number/Port Number tree:** Contains the Subsystem folder, which displays the CUs, ports, and host groups. Only the CU/Port that contain the LUs are shown in the CU Number/Port Number tree. A CU number or a port number can be selected in the CU Number/Port Number tree to specify the information displayed in the Volume list. More than one CU number or port number cannot be selected. When a CU includes a volume pair of error suspended status, error icon (🚫) is shown on the CU number/port number.
- **Volume list:** Displays information for each volume (LU) of the connected disk array (see [Volume List](#) on page 621). The information displayed in this list is sorted in the order of the Port number by default. The information for the LUs, which are defined for several paths, are displayed in several rows as many as the path defined.
- **Display Filter button:** Opens the Display Filter window (see [Display Filter](#) on page 623), which you can use to select the volumes displayed on the Volume list. The volumes can be selected specifying pair status, pair type, and group number.



- Previous/Next button:** In the Volume list, eight to twelve rows of LU information are displayed at once. The 256 rows can be displayed using the scroll bar. The **Previous/Next** buttons switches the Volume list to the previous or next 256 rows.

## Volume List

The Volume list displays information about each volume (LU) of the connected disk array. The information displayed in this list is sorted in the order of the Port number by default. Each item can be sorted in ascending order or descending order. To sort the items, click the column heading (such as Status or Port). Not all of the items of the Volume list can be displayed at once. To see all the items of the list, use the scroll bar below the Volume list.




**Note:** The number of items can be displayed without scrolling is changeable by the font size used.

Port	Group	LUN	Status	Sub	S/N	SSID	Port	Group	LUN
CL1-C	00	00(00:40)	SMPL						
CL1-C	00	01(00:41)	SMPL						
CL1-C	00	02(00:42)	SMPL						
CL1-C	00	03(00:43)	SMPL						
CL1-D	00	00(02:00)	PAIR		20580	0005	CL1-D	00	00(01:00)
CL1-D	00	01(02:01)	PAIR		20580	0005	CL1-D	00	01(01:01)
CL1-D	00	02(02:02)	PAIR		20580	0005	CL1-D	00	02(01:02)
CL1-D	00	03(02:03)	PAIR		20580	0005	CL1-D	00	03(01:03)
CL1-D	00	04(02:13)	PAIR		20580	0005	CL1-D	00	04(01:13)
CL1-D	00	05(02:14)	PAIR		20580	0005	CL1-D	00	05(01:14)
CL1-D	00	06(02:15)	PAIR		20580	0005	CL1-D	00	06(01:15)
CL1-D	00	07(02:16)	PAIR		20580	0005	CL1-D	00	07(01:16)
CL1-D	00	08(02:30)	PAIR		20580	0005	CL1-D	00	08(01:26)
CL1-D	00	09(02:31)	PAIR		20580	0005	CL1-D	00	09(01:27)
CL1-D	00	0A(02:32)	PAIR		20580	0005	CL1-D	00	0A(01:28)
CL1-D	00	0B(02:33)	PAIR		20580	0005	CL1-D	00	0B(01:29)
CL1-D	00	0C(02:35)	PAIR		20580	0005	CL1-D	00	0C(01:39)
CL1-D	00	0D(02:36)	PAIR		20580	0005	CL1-D	00	0D(01:3A)
CL1-D	00	0E(02:37)	PAIR		20580	0005	CL1-D	00	0E(01:3B)
CL1-D	00	0F(02:38)	PAIR		20580	0005	CL1-D	00	0F(01:3C)
CL1-D	00	20(01:00)	SMPL						
CL1-D	00	21(01:01)	SMPL						

**Figure 242: Volume list (partial view)**









- Volume icon:** Indicates the status of volumes. The following table shows each of the icons:

**Table 72: Volume icons for CA operations**

Icon	Explanation
	SMPL
	P-VOL
	S-VOL

- **Port, Group, and LUN:** Port number, Host Group number of the LU, and LU number (LUN).
- **Status:** See [CA Volume Pair Status](#) on page 587 for further information on CA pair status. The following table shows each of the icons:

**Table 73: Status icons for CA operations**

Icon	Explanation
	SMPL. The volume is not currently assigned to a CA pair. When the initial copy is started by a paircreate operation, the volume status changes to COPY.
	COPY. The CA initial copy operation is in progress. Data on the pair is not fully identical. When the initial copy is complete, the status will change to PAIR.
	PAIR. The volume is currently assigned to a CA pair, and the pair is 100% synchronized. All updates from the host to the P-VOL are duplicated at the S-VOL.
	PSUE. The pair has been suspended by the MCU or RCU due to an error condition. The volumes in this pair are not synchronized.
	PSUS. The pair has been split by the user (pairsplit-r), or the pair has been deleted by the user from the RCU (pairsplit-S). The volumes in this pair are not synchronized.
	PDUB. This CA LUSE pair is in the COPY or PAIR state, but at least one LDEV pair within the CA LUSE pair is in the SMPL or PSUE state.
	Suspending. CA Asynchronous only. This pair is not synchronized. This pair is in transition from the PAIR or COPY state to the PSUS/PSUE state.
	Deleting. CA Asynchronous only. This pair is not synchronized. This pair is in transition from the PAIR, COPY, or PSUS/PSUE state to the SMPL state.

- **Sub:** Suspend Sub Status.
  - **Grp:** Sequence number of the current volume is same as that of the consistency group.

- **LU**: Sequence number of the current volume is not same as that of the consistency group.
- **OFF**: Suspended by the PS OFF by the MCU.
- **S/N** and **SSID** of the other disk array (MCU or RCU) of the volume pair.
- **Port, Group, and LUN**: Port number, Host Group number of the LU, and LUN of the other volume of the volume pair.
- **Type**: Pair mode, Synchronous or Asynchronous.
- **Fence**: The P-VOL fence level of the CA volume pair: data, status, or never. See [Considering the P-VOL Fence-Level Setting](#) on page 713 for a complete description of the CA P-VOL fence-level parameter.
- **Diff**: The information about the differential data.
- **CTG**: Consistency Group number of the pair (only for the Asynchronous pairs).
- **ErrLvl**: Error level of the pair (only for the Asynchronous pairs).

---

**Note:** The **S/N**, **SSID**, and **Fence** columns might become blank while the pair is in transition from a pair status to SMPL. To display the latest information in these columns, you must refresh the screen.

---

---

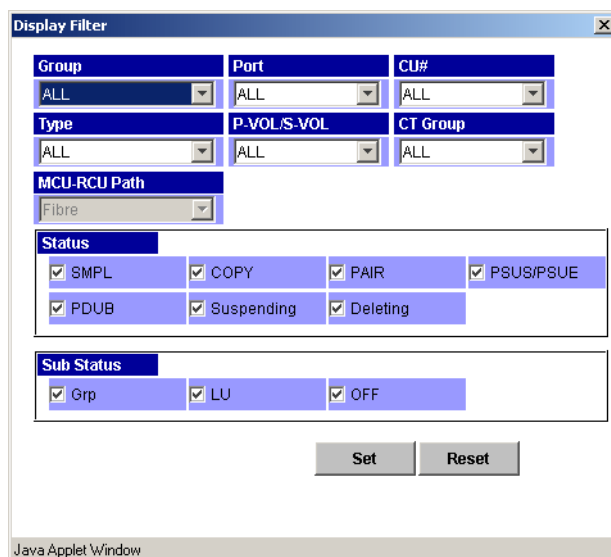
**Note:** The first LDEV number of LU is not displayed.

---

## Display Filter

Clicking the **Display Filter** button opens the Display Filter window, which you can use to select which volumes to display on the Volume list. You can select the Group number, Port number, CU number, Pair mode, Volume type, Consistency group number, Port type, and Pair status.

When you select the CU number or the Port number on the CU Number/Port Number tree on the CA main screen, the selection in the CU Number/Port Number tree has precedence over the specification in the Display Filter window. When the CU number or the Group number is selected in the tree, the specification on the Display Filter window for the CU number or the Group number is not available. To make all the settings on the Display Filter window available, click **Subsystem** in the CU Number/Port Number tree.



**Figure 243: Display Filter window**

The Display Filter window contains the following drop-down lists:

- **Group, Port, and CU#:** Used to specify the number of the group, port, and CU to be displayed.
- **Type:** Used to specify the pair type, synchronous or asynchronous.
- **P-VOL/S-VOL:** Used to specify the Volume type, P-VOL or S-VOL.
- **CT Group:** Used to specify the number of the consistency group to be displayed. This specification is available only for the Asynchronous pair.
- **MCU-RCU Path:** Used to specify the port type, fibre or serial.

The Display Filter window also contains the following items:

- **Status area:** Selecting the check boxes in this area displays only volumes that have the selected pair status: **SMPL**, **COPY**, **PAIR**, **PSUS/PSUE**, **PDUB** (LUSE only), **Suspending** (async only), and/or **Deleting** (async only). The **PDUB** check box displays only CA LUSE volumes with the **PDUB** status. When this box is selected, simplex volumes are not displayed.
- **Sub Status area:** Used to select the consistency status of Asynchronous pairs.
- The **Set** button applies your selections to the Volume list and closes the Display Filter window.

- The **Reset** button clears your selections and displays the default settings (**ALL**).

The settings on the Display Filter window are always available while you are using CA until you reset the settings.

---

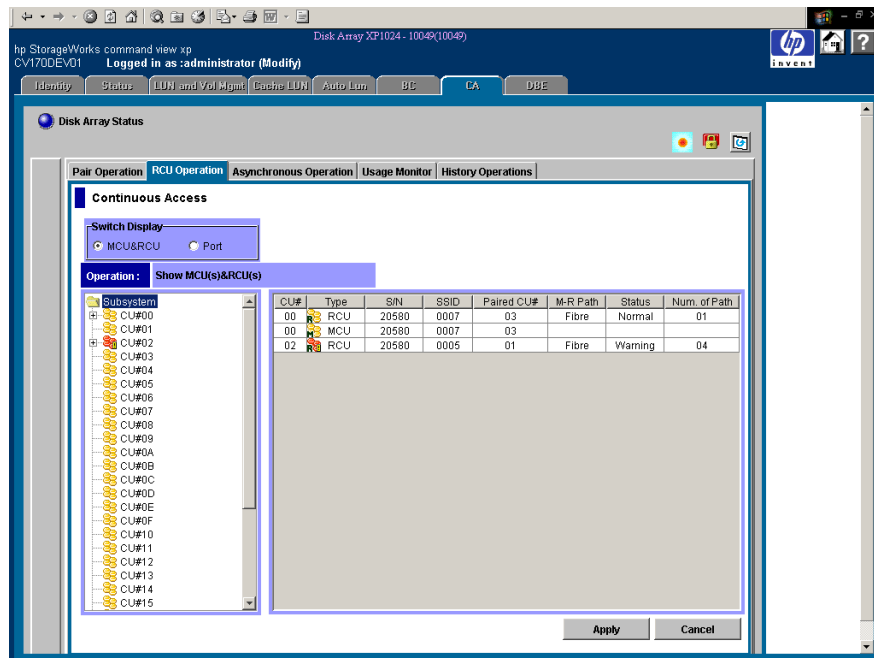
**Note:** You cannot use other windows without closing the Display Filter window.

---

## RCU Operation Screen

Clicking the **RCU Operation** tab displays the RCU Operation screen, which shows RCU information and provides access to the CA RCU setting operations (see [RCU Operations](#) on page 638).

The RCU Operation screen is updated when the tab is switched from one to another, when the **Refresh** button is clicked, and when the settings for the RCU are applied. For the RCU settings operation, see [RCU Operations](#) on page 638.



**Figure 244:** RCU Operation screen


The RCU Operation screen contains the following items:

■ **Switch Display option buttons:**

- **MCU&RCU:** Displays the CU Number tree and the MCU/RCU list. See [CU Number Tree and MCU/RCU List](#) on page 626. MCU/RCU list is displayed by default.
- **Port:** Displays the Package tree and the Port list. See [Port Tree and Port List](#) on page 627.

- **Operation:** Displays the current operation performed by the RCU Operation screen.

## CU Number Tree and MCU/RCU List

Click **MCU&RCU** in the Switch Display box to display the CU Number tree and the MCU/RCU list. In the CU Number tree, only the CU numbers, which include active MCUs or RCUs, are displayed. There is no branch under the CU Number tree. When the CU contains an RCU that has the failed path, the error icon () is shown for the CU number in the CU Number tree.

In the CU Number tree, the CU number can be selected to display the specified information in the MCU/RCU list. You can select only one CU number on the CU Number tree.

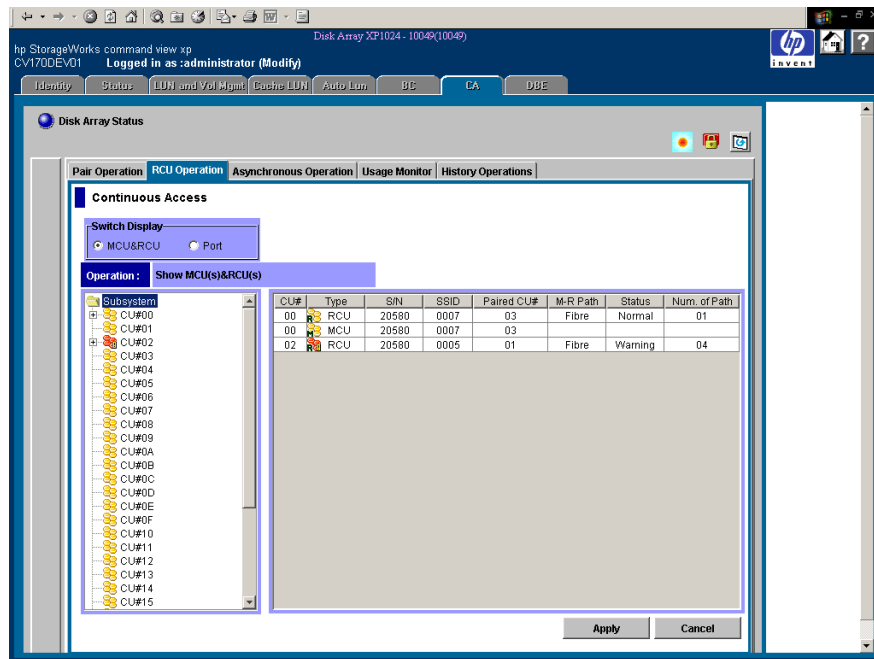
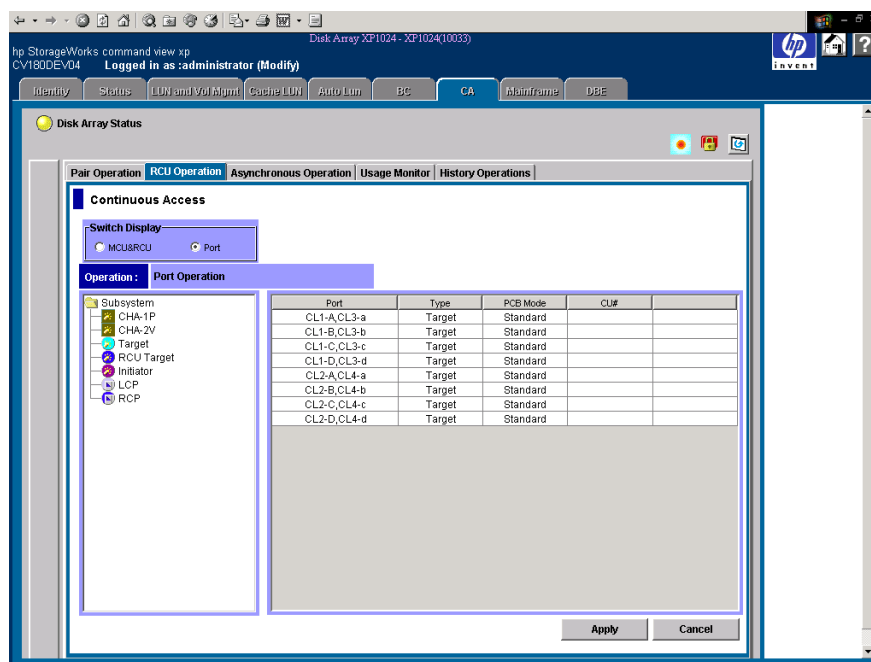


Figure 245: RCU Operation screen with the MCU&RCU option button selected

- **CU#:** CU number that is selected on the tree.
- **Type:** MCU or RCU.
- **S/N and SSID:** Serial number and SSID of the other CU of the pair.
- **Paired CU#:** CU number of the other CU of the pair.
- **M-R Path:** Path channel type (fibre or serial) between the other CU of the pair.
- **Status:** **Normal** indicates no failure path between the RCU. **Failed** indicates that there is failure paths between the RCU. This column becomes blank when the pair CU is MCU.
- **Num. of Path:** Number of paths (become blank when the pair CU is MCU).

## Port Tree and Port List

Click **Port** in the Switch Display box to display the Port tree and the Port list. The Port tree displays the channel adapters and the port types. Only ports that can be selected for remote copy operations are displayed.



**Figure 246: RCU Operation screen with the Port option button selected**

- **Port:** Cluster and port number (1A-2R).  
 When the speed mode is standard, two port numbers are displayed in a row and the speed mode can be modified on a two ports basis.  
 When speed mode is high, the port number is displayed on a package basis and the speed mode can be modified on a package basis.
- **Type:** Port type (Initiator, Target, RCU Target, External, RCP, or LCP).
- **PCB Mode:** Speed mode of the port (only for the fibre packages), standard, high-speed, or high-speed (2 port).
- **CU#:** Range of CU images (00-0F or 10-1F), displayed only for serial ports.

---

**Note:** High-speed (2 port) mode is available only if the XP disk array has firmware version 21.06.22 or later installed.

---

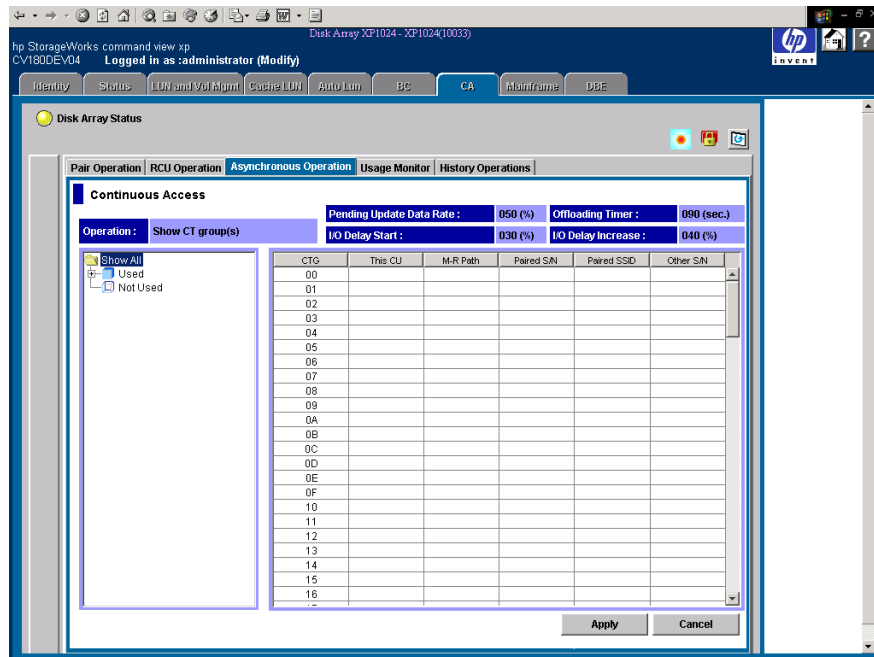


In the Port tree, the port type can be selected to display the specified information in the Port list. For example: When **Initiator** is selected in the Port tree, the system look for ports of Initiator from all the ports entered, and list the Initiator ports in the Port list. Only one port type can be selected in the tree.

## Asynchronous Operation Screen

Clicking the **Asynchronous Operation** tab displays the Asynchronous Operation screen, which shows consistency group information for the connected disk array and provides access to the CA Asynchronous pair operation (see [CA Asynchronous Operations](#) on page 660).

The Asynchronous Operation screen is updated when the tab is switched from one to another, when the **Refresh** button is clicked, and when the settings are applied.



**Figure 247: Asynchronous Operation screen**

The Asynchronous Operation screen contains the following items:

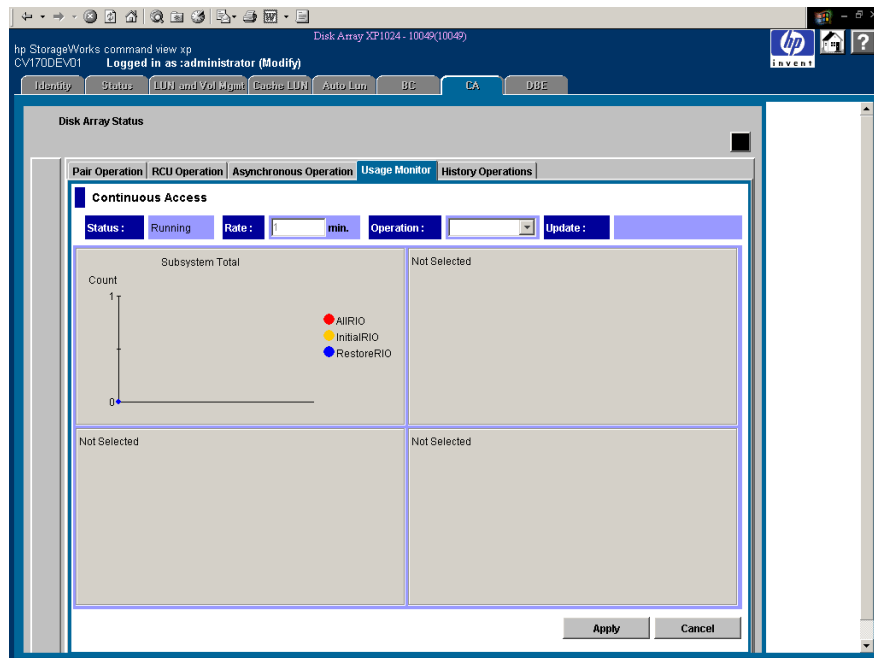
- **Operation:** Displays the current operation performed by the **Asynchronous Operation** tab.

- **Pending Update Data Rate:** Displays the maximum cache % available for use by CA Async sidefiles.
- **Offloading Timer:** Displays the maximum time between CA Async recordset transfers.
- **I/O Delay Start** (Firmware version 21.07.04 or later only): Indicates the threshold for starting the response delay to the host.
- **I/O Delay Increase** (Firmware version 21.07.04 or later only): Indicates the threshold for increasing the response delay to the host.
- **Consistency Group tree:** Displays all consistency groups (default), or only the consistency groups that are already in use (Used), or the consistency groups that are available for use (Not Used).
- **Consistency Group** list consists of the following items:
  - **CTG:** Consistency group number.
  - **This CU:** The CU that initially registered the consistency group. When the consistency group is not registered, the column become blank. **MCU:** The local CU registered the consistency group. **RCU:** The consistency group is registered from the paired CU (the local CU is RCU). **M&R:** MCU and RCU are in the same disk array.
  - **M-R Path:** Fibre Channel or serial. When the consistency group is not registered, the column become blank.
  - **Paired S/N:** Serial number of the paired disk array (the disk array with the lowest serial number). When the consistency group is not registered, the column become blank.
  - **Paired SSID:** SSID (Storage disk array ID) of paired disk array (the disk array with the lowest SSID). When the consistency group is not registered, the column become blank.
  - **Other S/N: Exist:** indicates that there are RCU other than the one with the lowest serial number. When there is no other RCU, the column become blank.

## Usage Monitor Screen

Clicking the **Usage Monitor** tab displays the Usage Monitor screen, which shows the user-selected remote copy I/O statistics and the status of remote copy usage monitoring, and provides access to the CA usage monitor operations (see [Usage Monitor Operations](#) on page 672).

The Usage Monitor screen is updated when the tab is switched from one to another, when the **Refresh** button is clicked, and when the settings are applied.



**Figure 248: Usage Monitor screen**

The Usage Monitor screen contains the following items:

- **Status:** Displays **Running** when monitoring is on and **Stop** when monitoring is off. When monitoring is stopped, the usage monitor graph is closed. The usage monitor graph can only be displayed when monitoring is running.
- **Rate:** Displays the data collection rate for usage monitoring.
- **Operation:** Used to select a usage monitor operation.
- **Update:** Displays the most recent data sample time of the data on the graph.

## History Operations Screen

Clicking the **History Operations** tab displays the History Operations screen, which shows history information for the CA pairs. The history information includes the records of the main status changes (such as pair creation, deletion, and so forth) of the CA pairs.

The History Operations screen is updated when the tab is switched from one to another, when the **Refresh** button is clicked, and when the settings are applied.

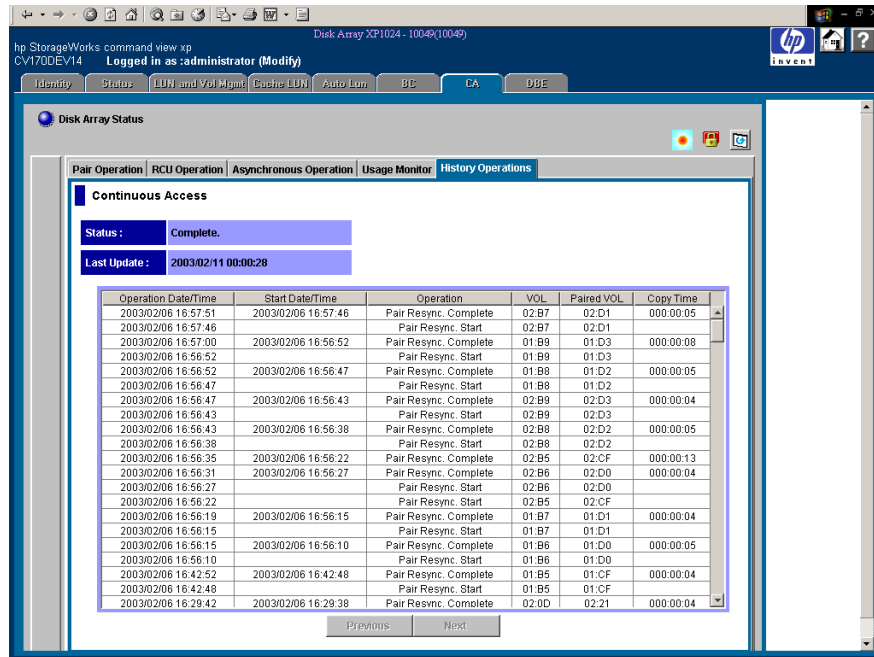


Figure 249: History Operations screen

The History Operations screen contains the following items:

- **Status:** Displays the current status of the history file:
  - **No history file exist:** The history file does not exist.
  - **Reading a history failed:** A failure occurred during referring to the history file.
  - **Update history ... n (%):** Updating of the history file is now in progress. “n (%)” indicates the progress (in %) of the updating process of the history file.
  - **Complete:** Updating of the history file has been completed.

When the updating process is in progress, the checking process automatically continues until the updating process finishes. The updating process is checked at ten-second intervals.

- **Last Update:** Displays the updated date and time of the history file.

- **History List:** Displays the history information for the CA pairs in the connected disk array. CA history information is saved for seven days, and the maximum number of the information that can be saved is 65,535. By default, the list is in the order in which the information are received from the disk array.

History information older than seven days is automatically deleted. However, if the number of operations exceeds 65,535, the oldest operations are deleted in chronological order to keep the number at 65,535, even if the operations occurred within the last week. The history file always contains the most recent operations up to a maximum of 65,535 operations. The maintenance information for an entire week may not always be available.

The history information can be sorted by column and in ascending or descending order.

The History List displays the following information:

- **Operation Date/Time:** The date and time when the operation was completed.
- **Start Date/Time:** The date and time when the operation was started.
- **Operation:** The operations are:
  - Pairing Start:** Add pair operation was started.
  - Pairing Complete:** Add pair operation was completed.
  - Pair Delete:** The pair was deleted.
  - Suspend Operation:** Pair suspending operation was performed.
  - Pair Suspend (Failure):** The pair was suspended because of a failure.
  - Pair Resync. Start:** Resume pair operation was started.
  - Pair Resync. Complete:** Resume pair operation was completed.
- **VOL:** CU number and LDEV number of the operated volume.
- **Paired VOL:** CU number and LDEV number of the paired volume.
- **Copy Time:** The time taken for the operation (from the start of the operation to the end). Displayed only for **Pairing Complete** and **Pair Resync. Complete** operations.

---

**Note:** For CA pairs consisting of LUN Expansion (LUSE) volumes, the number of **Pair Suspend (Failure)** rows in the history list does not correspond to the number of LDEVs in the LUSE volume. For LUSE volumes with three or more LDEVs, only two rows showing **Pair Suspend (Failure)** are displayed.

---

- **Previous and Next buttons:** The list displays up to a maximum of 16,384 operations at a time. Use these buttons to display the previous or next 16,384 operations.

The dates and times displayed on the History screen are the disk array's date and time, which may or may not correspond to the local time or host time.

## Performing CA Configuration Operations

The CA configuration operations include the MCU operations, RCU operations, CA Asynchronous control operations, and discontinuing CA operations. The CA main screen (see page 617) provides access to all CA configuration operations.

MCU operations (see page 636) configure the MCUs for CA operations:

- Configuring the MCU Fibre Channel interface ports

RCU operations (see page 638) configure the RCUs for CA operations:

- Registering the RCUs
- Setting the RCU options
- Adding/deleting logical paths to an RCU
- Adding/deleting SSIDs for an RCU
- Viewing RCU status
- Deleting RCUs

CA Asynchronous operations (see page 660) configure the CA Asynchronous groups and options:

- Setting the MCU async options
- Adding consistency groups
- Setting the consistency group options
- Viewing consistency group status
- Deleting consistency groups

Usage Monitor operations (see page 672) collect the I/O statistics for the LDEVs on a disk array.

History operations display the CA history file.

Optimize CA operations and disk array performance by selecting the appropriate CA settings and options for your operational environment and also by addressing conditions, which can affect disk array performance. For more information, see [Optimizing CA Operations and Disk Array Performance](#) on page 677.

If you want to discontinue CA operations, you must perform the required CA operations (for example, pair deletion, RCU deletion, port reconfiguration, etc.) in a specific order to ensure smooth operations and avoid command rejects and error conditions. For more information, see [Discontinuing CA Operations](#) on page 679.

The CA main screen also provides access to all CA volume pair operations: creating pairs, splitting and resyncing pairs, and viewing pair status. [Performing CA Pair Operations](#) on page 680 describes and provides instructions for performing the CA volume pair operations.

## MCU Operations

The MCUs are the disk control units that control the P-VOLs of the CA volume pairs. Each disk array that is attached to the Command View management station on the internal LAN can function as an MCU. The MCUs receive and process user-requested CA commands from the Command View management station, and send the remote copy operations to the RCUs. The MCUs can also function as RCUs, provided the remote copy connections are properly configured.

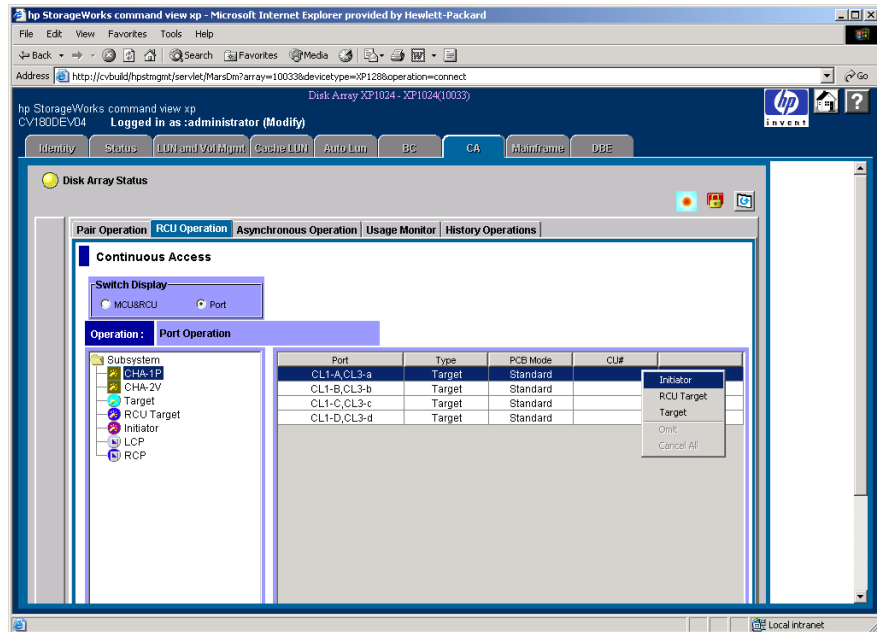
To set a disk array as an MCU, you need to configure the MCU ports.

## Configuring the MCU Ports

All Fibre Channel interface ports on the disk array have a default setting of Target port (CHF). Target mode is used for host processor channel interface. The Fibre Channel ports that will be used for CA communications to the RCUs must be configured as Initiator ports. The Fibre Channel interface ports in the RCU that will be used to communicate with the MCU must be configured as RCU target ports. Initiator mode emulates a host channel to enable the MCU to send write I/O operations directly to the RCU target port. You can use CA to change the configuration of the ports as needed to accommodate the host and CA communications paths. Two or more Initiator ports must be configured before you can register the RCUs and create the CA pairs. For further information on the Initiator ports, see [Initiator Ports and RCU Target Ports](#) on page 575.

The Port tree and the Port list on the RCU Operation screen can be used to configure the MCU ports. Clicking **Port** in the Switch Display box changes the tree to the Port tree and the list to the Port list.





**Figure 250: Configuring the MCU ports**

**To configure the MCU ports:**

1. From the CA main screen, click the **RCU Operation** tab.
2. Click **Port** in the Switch Display box to change the tree to the Port tree and the list to the Port list.
3. Click a package or a port type from the Port tree. Only the selected package or the selected port type is displayed in the Port list.
4. Click the port(s), which is/are the port(s) of the CU that you want to configure as MCU(s), from the Port list.
5. Right-click to display the pop-up menu. The pop-up menu consists of **Initiator**, **RCU Target**, and **Target** for the Fibre Channel.
6. Click a port type (**Initiator**) from the pop-up menu.

For the port change operation, there is no separate window and the list keeps displaying the Port list. For more information to change the port mode, see [Port Change Operation](#) on page 657.

## RCU Operations

The RCUs are the control units that control the S-VOLs of the volume pairs. The RCUs are connected to the MCUs via the remote copy connections and receive and process commands from the MCUs. For CA operations, the secondary Command View management station at the remote site should be connected to the RCUs to allow CA commands to be issued directly to the RCU (for example, in case of disaster or failure at the primary site).

RCU operations are performed separately for each CU image of each MCU and RCU to provide maximum flexibility in CA configurations. The RCU operations are:

- Viewing RCU status (see page 639)
- Registering RCUs (see page 642)
- Setting the RCU options (see page 642)  
The RCU options apply to all CU images of the MCU.
- Modifying the RCU options (see page 648)
- Deleting RCUs (see page 650)
- Determining the RCU path parameters (see page 651)
- Adding and deleting logical paths to an RCU (see page 652)
- Adding and deleting SSIDs for an RCU (see page 655)

From the RCU Operation screen, you can perform the RCU operations. All the operations that can be performed from the RCU Operation screen have a common procedure.

### To perform the RCU operations from the RCU Operation screen:

1. Click a CU number or a Package number to be operated in the tree.
2. Click one or more RCU or Package to be operated in the list. For registering RCU operation, the RCU does not have to be selected. For this step, the list can be blank.
3. Right-click the list to display the pop-up menu.
  - a. Clicking **MCU&RCU** in the Switch Display box displays the following commands in the pop-up menu:
    - **RCU Status:** Displays the RCU status.
    - **RCU Operation:** The RCU settings operation.
    - **Edit SSID(s)&Path(s):** The SSID and Path settings operation.

When the list is blank, the **RCU Operation** command can only be activated.

- b. Clicking **Port** in the Switch Display box displays the following commands in the pop-up menu: **Initiator**, **RCU Target**, and **Target** for fibre or **RCP** and **LCP** for serial (see [Port Change Operation](#) on page 657).
4. Click a command. When two or more RCUs are selected in [step 2](#), the **RCU Operation** command can only be selected.

There is no separate window for the port change operation. Select the port type, and go back to the Volume list (go to [step 6](#)).

5. Click **Set**. The window closes and the MCU/RCU list changes to the RCU Settings Parameter list. The RCUs selected in [step 2](#) are only listed and items in the list depend on the selected command.

---

**Note:** After being set, the options can be modified and/or canceled (see [Modifying Parameters and Deleting Settings](#) on page 659).

---

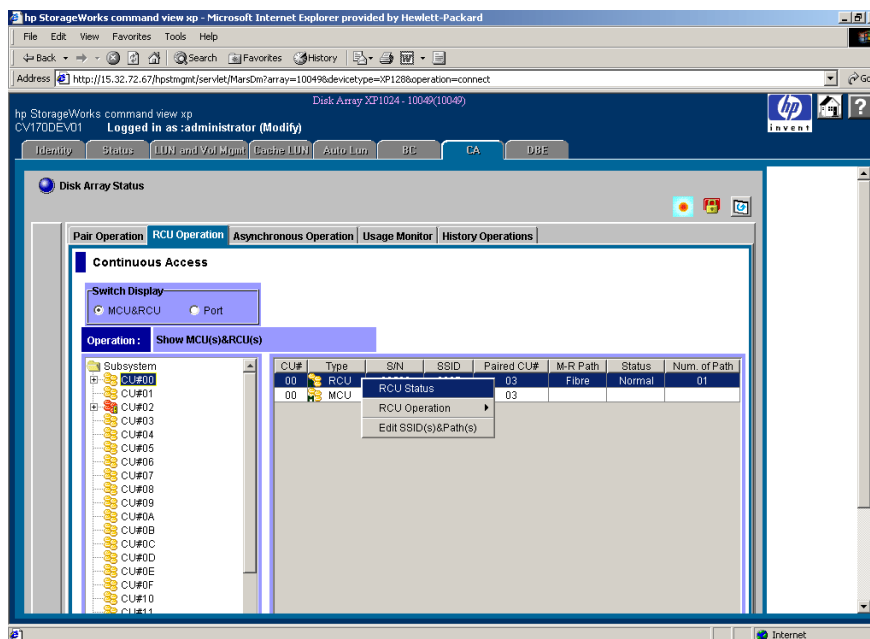
6. Click **Apply** on the CA main screen to apply the settings to the disk array.  
The following sections describe in detail for each command and operation.

## Viewing RCU Status (RCU Status)

The **RCU Status** command can be used to display the RCU status information.

### To display the RCU status information:

1. From the RCU Operation screen, click **MCU&RCU** in the Switch Display box.
2. In the CU Number/Port tree, click a CU number that includes the RCU that you want to display the status information.
3. From the MCU/RCU list, select an RCU and right-click to display the pop-up menu.



**Figure 251: Displaying RCU status information**

4. Click **RCU Status** from the pop-up menu. The RCU Status window is displayed.

If you select more than one RCU in [step 2](#), the **RCU Operation** command can only be selected from the pop-up menu. Select one RCU in [step 2](#) to display the status information.

The screenshot shows a window titled "RCU Status" with a table and a list of parameters. The table has four columns: No., Path Status, MCU Port, and RCU Port. The first row contains the values 1, Normal, CL1-B, and CL2-E. Below the table is a list of parameters with their corresponding values.

No.	Path Status	MCU Port	RCU Port
1	Normal	CL1-B	CL2-E

RCU S/N :	20580
SSID :	0007
RCU CU# :	03
MCU-RCU Path :	Fibre
Minimum Paths :	1
Maximum Initial Copy Activity :	16 (Volumes)
RIO MIH Time :	15 (sec.)
Path Blockade Watch :	40 (sec.)
RCU Registered :	12/04/2002 10:11:36
Last Updated :	12/04/2002 10:11:36

Buttons: Refresh, Close

Java Applet Window

**Figure 252: RCU Status window**

- **Path list:**
  - **No.:** Path number (serial number of the list).
  - **Path Status:** Path status. **Normal** is displayed when the path status is normal.
- **RCU S/N:** Serial number of the RCU.
- **SSID:** SSID of the RCU.
- **RCU CU#:** CU number of the RCU.
- **MCU-RCU Path:** Channel type, fibre or serial.
- **Minimum Paths:** Minimum number of paths required for the selected RCU connected to the MCU.
- **Maximum Initial Copy Activity:** Number of concurrent initial copy operations.
- **RIO MIH Time:** Time value for the remote I/O (RIO) missing interrupt handler (MIH), which is the wait time until data transfer from the MCU to RCU is complete.

- **Path Blockade Watch:** Time for monitoring blockade in the Fibre Channel paths on the MCU side.
- **RCU Registered:** Date and time when the RCU is registered.
- **Last Updated:** Date and time when the RCU is last updated.
- The **Refresh** button refreshes the information displayed on the window. The **Close** button closes the window.

The **Path Status** field lists the path status and the following table describes each status. For troubleshooting information about MCU-RCU paths, see [Troubleshooting RCU Path Status Problems](#) on page 1282.

**Table 74: Logical path status**

Status Description	Condition
Normal	This logical path has been successfully established and can be used for CA copy activities.
Initialization Failed	The link initialization procedure with the RCU has failed because either the physical path connection between the MCU and the RCU or the connection between the MCU and the host was missing.
Communication Timeout	A timeout error has occurred between the MCU and RCU.
Resource Shortage	The establish logical path link function has been rejected by the RCU. All logical path resources in the RCU might be used for other connections.
Serial Number Mismatch	The serial number of the control unit that is connected to this logical path does not match the serial number specified by the Add RCU window.
Invalid Port	The serial interface port specified is not in the RCP or Initiator mode.
RCU Port Number Mismatch	There are three possible factors as follows: The specified port in the RCU is physically disconnected from the MCU. The port is not configured as an RCU target port. The specified port number is not available.
RCU Port Type Mismatch	The microprogram at the RCU side does not support the fibre remote copy function. Or the specified port type is not RCU Target.
Communication Failed	A timeout error has occurred on the path between MCU and RCU.

### Registering an RCU (Add RCU)

You can register up to four RCUs to each MCU, and establish up to eight paths to each RCU. You must register each CU image as a separate RCU. The logical paths are established for the CU images of the MCU and RCU separately. The

maximum number of logical paths for each MCU is 32 (8 paths per RCU  $\times$  4 RCUs per MCU). The remote copy connections and MCU ports must be properly installed and configured before you can register an RCU. When you register an RCU, the current CU image of the MCU registers the specified CU image as a CA RCU and establishes the specified number of logical paths to the RCU. After you have registered an RCU (and path status is normal), you can create CA pairs that have S-VOLs in the newly registered RCU.

Use the Add RCU window to register the RCU(s) to the current CU image of the connected MCU. When the **Add RCU** command is selected, the Add RCU window is displayed.

**Note:** If four RCUs (the maximum number of RCUs you can register) have already been registered, the **Add RCU** command cannot be selected.

MCU-RCU Path	
MCU Port	RCU Port

**Figure 253: Add RCU window**

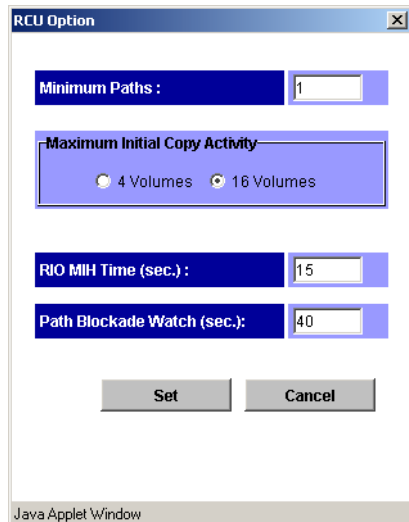
Use the **RCU S/N**, **Controller ID**, and **Logical Adr. (RCU CU#)** fields to enter the serial number, Controller ID and CU number of the RCU being registered. S/N is in five-digit and CU number is 0-1F.

Use the **SSID** fields to enter the SSID(s) of the RCU being registered. The XP128/XP1024 uses one SSID for each set of 256 volumes and four SSIDs per CU image. SSID is 4-FFFE in hexadecimal.

The **MCU-RCU Path** field includes:

- The **MCU Port** field, which you use to enter the MCU port number. Only the Initiators are listed in the drop-down list and you can select the MCU port from the list.
- The **RCU Port** field, which you use to enter the RCU port number. The RCU Target port must be selected.
- The **Link Address** field, which you use to enter a link address from 0 - FD in hexadecimal numbers (serial only). For dynamic link of remote copy connections, enter the destination port address on the ESCD. For static connections, enter **0**.

The **Option** button opens the RCU Option window. The **Cancel** button cancels the settings you made on the Add RCU window, and closes the window.



**Figure 254: RCU Option window**

Use the RCU Option window to set the options for the RCU.



Use the **Minimum Paths** option to specify the minimum number of paths required for each RCU connected to the current MCU. The default setting is one. If you specify a larger number than the number of paths you have set on the Register RCU window, or if the number of paths falls below this number (for example, failed path), an error occurs. When the error occurs, the MCU suspends all affected CA (and any mainframe) pairs to prevent remote copy operations from adversely affecting performance due to the inadequate number of paths. If the MCU contains CA pairs, which contain critical data for disaster recovery, set the minimum number of paths to one, so that CA operations continue even if there is only one path to an RCU. If you need high performance at the MCU, set the minimum number of paths to two or more (up to eight per CU image), depending on the number of pairs managed by the MCU.



**Caution:** If CA volume pairs are suspended because the number of paths has dropped below this setting, the P-VOL fence-level pair option (see [Creating CA Volume Pairs \(Paircreate\)](#) on page 686) determines whether the CA Synchronous P-VOLs are fenced (that is, reject all write operations).

---

The **Maximum Initial Copy Activity** setting specifies the number of concurrent initial copy operations: **4 Volumes** or **16 Volumes**. The default setting is **4 Volumes**. CA initial copy activities can impact the performance of the main disk array, depending on the amount of I/O activity and the number of pairs being registered at the same time. The maximum initial copy activity setting of **4 Volumes** limits the impact of initial copy activities on disk array performance. For example, if you set the maximum initial copy activity to **4 Volumes** and then register five CA pairs at the same time, the MCU starts the first four pairs and will not start the fifth pair until one of the first four pairs is synchronized (PAIR status). When you change the maximum initial copy activity setting, the new setting applies to pairs created after the setting was changed, not to existing pairs.

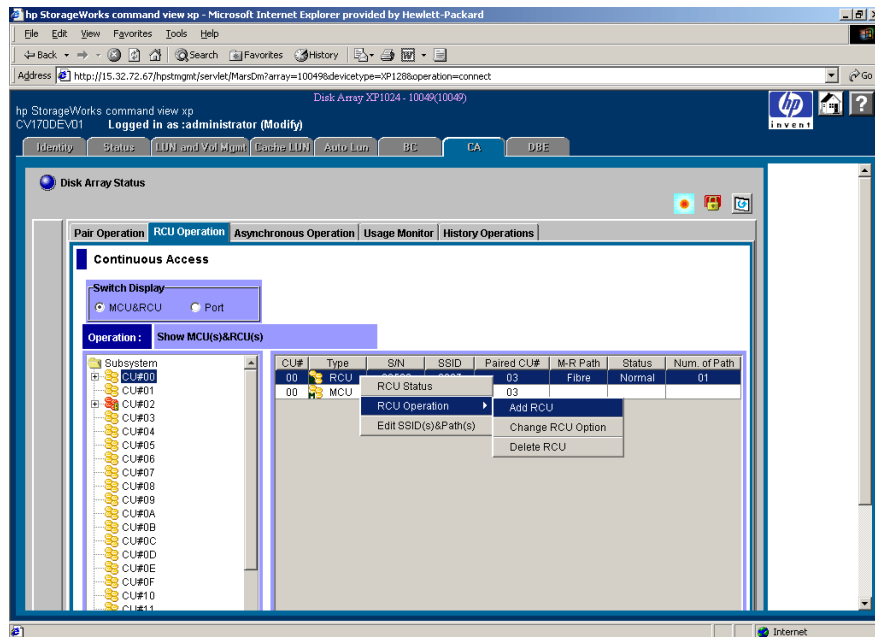
The **RIO MIH Time** setting specifies the time value for the remote I/O (RIO) missing interrupt handler (MIH), which is the wait time until data transfer from the MCU to RCU is complete. The RIO MIH time value must be from 10 to 100 seconds. The default setting is 15 seconds. This setting is available for both serial and Fibre Channel interfaces.

The **Path Blockade Watch** setting specifies the time for monitoring blockade in the Fibre Channel paths on the MCU side. The path blockade watch value must be from 0 to 45 seconds. The default setting is 40 seconds. This setting is available for Fibre Channel interface only.

The **Cancel** button cancels the registering RCU operation. The **Set** button sets the registering RCU operation with the option you set on the RCU Option window.

**To register an RCU to the connected MCU:**

1. Make sure the remote copy connections and MCU ports are properly configured. Get the S/N of the RCU and the SSID(s) for the CU image in the RCU. The register RCU operation will fail without this information. The disk array should have a label or tag indicating its S/N and SSIDs. The HP representative can also get the RCU S/N and SSIDs using the RCU’s service processor (at the remote site).
2. From the RCU Operation screen, click **MCU&RCU** in the Switch Display box.
3. In the CU number/Port tree, click the correct CU image. For this step, the list can be blank. You must register/add RCUs to each CU image separately.
4. In the MCU/RCU list, right-click to display the pop-up menu. For registering RCU operation, the RCU does not have to be selected on the list.
5. From the pop-up menu, click **RCU Operation**, and then click **Add RCU**. The Add RCU window is displayed.



**Figure 255: Registering an RCU to the connected MCU**

6. In the Add RCU window, enter the S/N of the RCU and the Controller ID, CU number and SSID(s) for the CU image. The MCU verifies the S/N when the paths are established, and verifies the SSIDs when the volume pairs are created. If needed, you can add and delete SSIDs later using the Add SSID window (see [Adding and Deleting SSIDs for an RCU \(Add SSID/Delete SSID\)](#) on page 655).
7. Click the MCU and RCU ports from the drop-down lists. The MCU will not establish less than the minimum number of paths as specified on the RCU Option window (see [Modifying RCU Options \(Change RCU Option\)](#) on page 648). If needed, you can add and delete paths later using the Add Path window (see [Adding and Deleting Logical Paths for an RCU \(Add Path/Delete Path\)](#) on page 652).
8. Click **Option** to open the RCU Option window. Click **Cancel** to cancel the settings you made on the Add RCU window.
9. From the RCU Option window, enter or select the settings for **Minimum Paths**, **Maximum Initial Copy Activity**, and **RIO MIH Time**. For Fibre Channel interface, also specify the **Path Blockade Watch** setting.
10. From the RCU Option window, make sure to click **Set** (even if you made no changes). Click **Cancel** if you want to cancel the settings. The list changes to the RCU Settings Parameter list.
11. The new RCU is displayed in the RCU Settings Parameter list. To check the path status for this RCU, select the RCU, right-click to display the pop-up menu, and then click **RCU Status**. Refer to the table in [Troubleshooting RCU Path Status Problems](#) on page 1282 for detailed information on the path status.

---

**Note:** After being set, the options can be modified and/or canceled (see [Modifying Parameters and Deleting Settings](#) on page 659).

---

When the pair option is set (the RCU Option window is closed), the list changes to the RCU Settings Parameter list. The following figure shows the items of the RCU Settings Parameter list.

S/N	SSID1	SSID2	SSID3	SSID4	M-R Path	Num. of Path	
62492	0005				Fibre	01	
MCU Port1	RCU Port1	MCU Port2	RCU Port2	MCU Port3	RCU Port3	MCU Port4	RCU Port4
CL1-B	CL1-B						
MCU Port5	RCU Port5	MCU Port6	RCU Port6	MCU Port7	RCU Port7	MCU Port8	RCU Port8
Min.Path	Activity	MIH Time	Path Watch				
01	04	015	40				

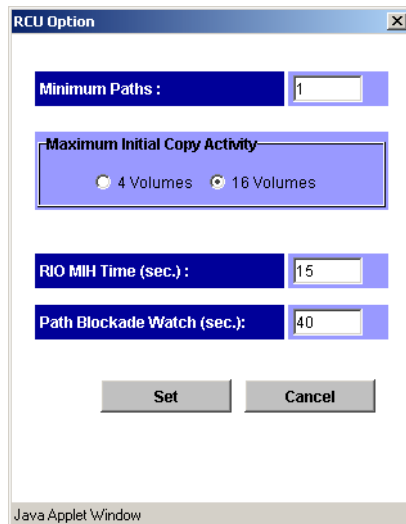
**Figure 256: RCU Settings Parameter list**

- **S/N:** RCU Serial number.
- **SSID 1 to SSID 4:** Selected SSID from SSID 1 to SSID 4.
- **M-R Path:** Channel type.
- **Num. of Path:** Number of the path(s) used.
- **MCU Port 1 to MCU Port 8:** Port number on the MCU side from one to eight.
- **RCU Port 1 to RCU Port 8:** Port number on the RCU side from one to eight.
- **Min.Path:** Minimum number of paths required for each RCU connected to the current MCU.
- **Activity:** Number of concurrent initial copy operations.
- **MIH Time:** Time value for the remote I/O (RIO) missing interrupt handler (MIH).
- **Path Watch:** Time for monitoring blockade in the Fibre Channel paths on the MCU side.

## Modifying RCU Options (Change RCU Option)

The RCU Option window can also be opened by the **Change RCU Option** command and is used to modify the RCU options that are set when you registered the RCU. When the RCU Option window is opened by the **Change RCU Option** command, all the fields become blank. You have to fill the fields you need to modify; it is not necessary to fill all the fields. The fields left blank keep the settings you have made for the registering RCU operation.

The RCU options apply to all CU images of the current MCU and to all RCUs connected to the MCU.



**Figure 257: RCU Option window**

For further information on the RCU Option window, please refer to [Registering an RCU \(Add RCU\)](#) on page 642.

**To modify the RCU option:**

1. From the CU number/Port tree on the RCU Operation screen, make sure the correct CU image is selected.
2. From the MCU/RCU list, click RCU whose options you want to modify.
3. Right-click to display the pop-up menu, click **RCU Operation**, and then click **Change RCU Option**. The RCU Option window is displayed.
4. From the RCU Option window, modify the RCU options. When the RCU Option window is opened, all the fields become blank. Fill in the fields you want to modify the RCU options.
5. Click **Set** to set the modification you made. The list changes to the RCU Settings Parameter list (RCU Option) view. Click **Cancel** to cancel all the modifications you made.

---

**Note:** After being set, the options can be modified and/or canceled (see [Modifying Parameters and Deleting Settings](#) on page 659).

---

- Click **Apply** on the CA main screen to apply the modification to the disk array.

When the modification is set (the RCU Option window is closed), the **MCU/RCU** list changes to the RCU Settings Parameter list (RCU Option) view. The following figure shows the items of the RCU Settings Parameter list (RCU Option) view.

S/N	SSID	M-R Path	Min.Path	Activity	MIH Time	Path Watch
62492	0005	Fibre	01	16	015	40

**Figure 258: RCU Settings Parameter list (RCU Option)**

- **S/N, SSID:** RCU Serial number and SSID.
- **M-R Path:** Channel type.
- **Min.Path:** Minimum number of paths required for each RCU connected to the current MCU.
- **Activity:** Number of concurrent initial copy operations.
- **MIH Time:** Time value for the remote I/O (RIO) missing interrupt handler (MIH).
- **Path Watch:** Time for monitoring blockade in the Fibre Channel paths on the MCU side.

## Deleting an RCU (Delete RCU)

You can delete an RCU from an MCU only after all CA volume pairs between the MCU CU image and RCU CU image have been deleted. When you delete an RCU from an MCU, the MCU deletes all logical paths from the current MCU CU image to the selected RCU CU image. Deleting an RCU does not affect the CA operations between the other MCU CU images and that RCU. After an RCU has been deleted, you can reconfigure the remote copy connections to add another RCU to the MCU, or you can remove the remote copy connections and reconfigure the MCU ports (initiator ports to ordinary target ports for fibre, RCPs to LCPs for serial) to provide additional host channels for the MCU.

Use the **Delete RCU** command to delete the selected RCU from the current MCU CU image. If all affected pairs have not been deleted, the MCU will reject the delete RCU operation to prevent accidental deletion of CA pairs.

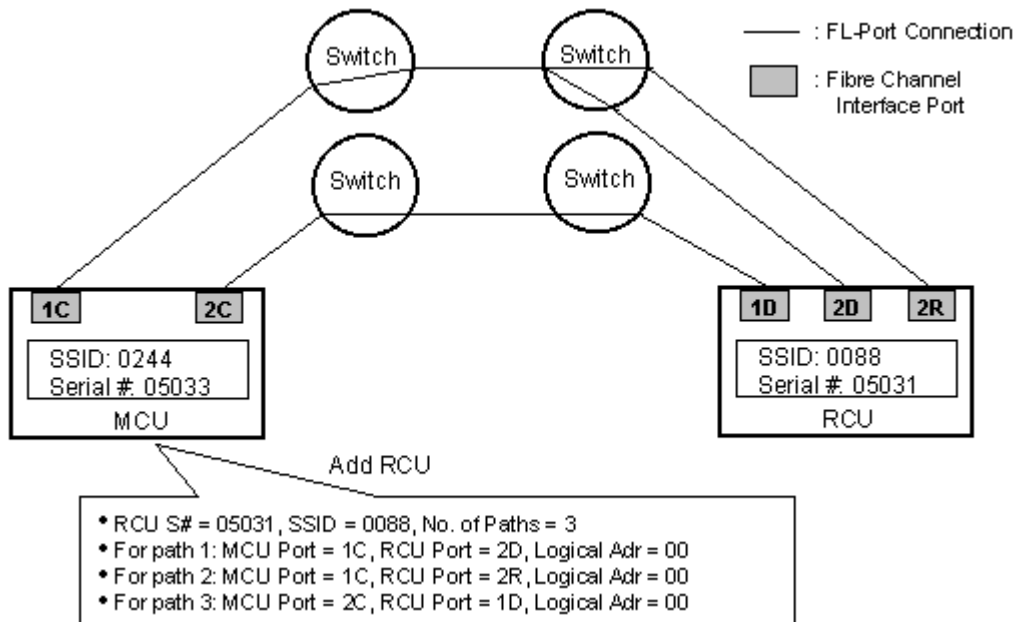
### To delete an RCU from an MCU:

- Connect to the MCU.

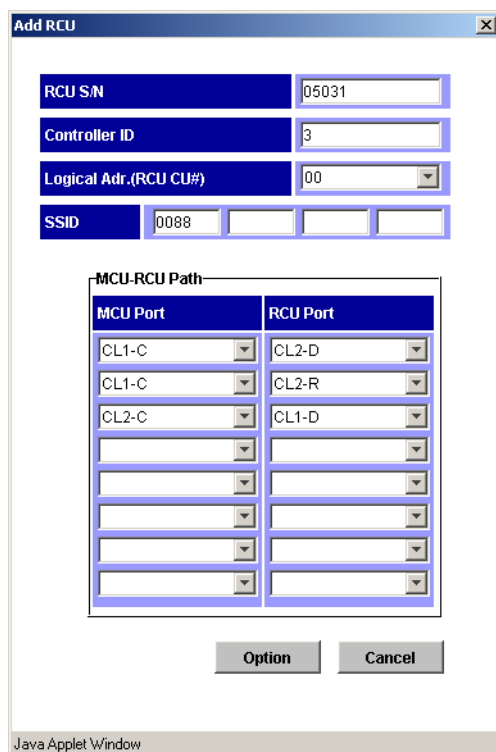
2. Make sure that all affected CA volume pairs have been deleted. The volume pairs, which consist of a P-VOL in the connected MCU and CU image, and an S-VOL in the selected RCU, must be deleted.
3. From the CU number/Port tree on the RCU Operation screen, make sure the correct CU image is selected.
4. From the **MCU/RCU** list, click the RCU that you want to delete.
5. Right-click to display the pop-up menu, click **RCU Operation**, and then click **Delete RCU**.
6. Click **Apply** on the CA main screen to apply the deletion to the disk array.

## RCU Path Parameters

For the Fibre Channel interface, two types of CHF P/K (Fibre Channel packages) are provided: 4-port and 2-port packages. The port mode depends on the package type. Also, each port may have a different PCB mode setting (standard or high-speed). Therefore, when you configure paths among the initiator ports, target ports, and RCU target ports, please study the port modes and specify the correct mode for each port. The following figures show Fibre Channel interface connections going through switches and the CA window used for this configuration.



**Figure 259: Fibre Channel interface connections going through switches**



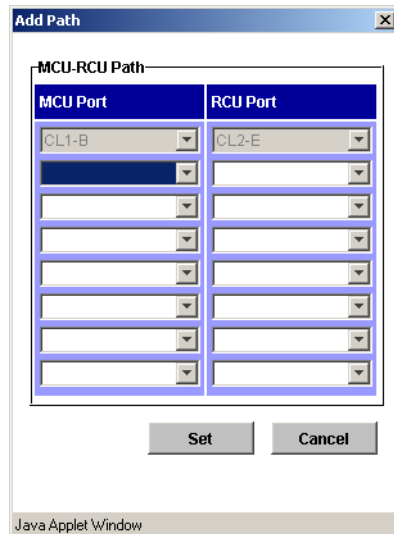
**Figure 260: Add RCU window used for configuration in Figure 259**

### Adding and Deleting Logical Paths for an RCU (Add Path/Delete Path)

Before adding a path to an RCU, make sure that the remote copy connection is properly installed, that the appropriate MCU ports are configured as Initiator ports (fibre) or RCPs (serial), and that the appropriate MCU CU image is selected. You can add up to four RCUs to each MCU CU image and establish up to eight paths to each RCU. When you add a path to an RCU, CA will automatically start using the new path to perform CA copy activities.

Use the **Add Path** and **Delete Path** to add and delete the paths for an RCU. When the **Add Path** command is selected, the Add Path window is displayed.





**Figure 261: Add Path window**

The **MCU-RCU Path** field includes:

- The **MCU Port** field, which you use to enter the MCU port number. The Initiator and the RCP are listed in the drop-down list and can be selected.
- The **RCU Port** field, which you use to enter the RCU port number. The RCU Target port must be specified.
- The **Link Address** field, which you use to enter a link address (serial only), the destination port address on the ESCD (00-FD, 00 for static link to RCU).

The **Cancel** button cancels the settings you made. The **Set** button applies the settings you made and changes the list.

---

**Note:** The maximum number of the paths is eight. Each item has the seven fields to enter the paths, but you cannot enter the paths more than eight of total.

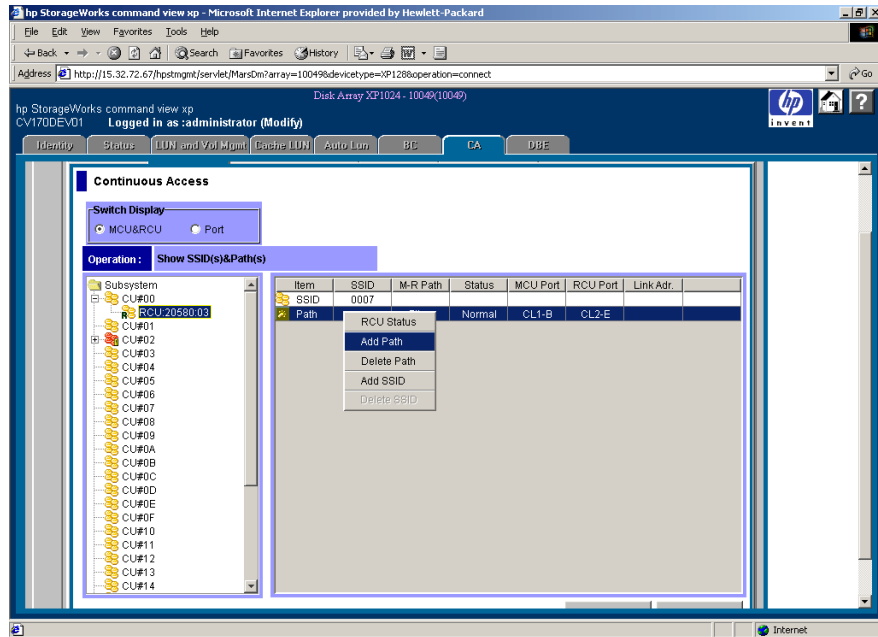
---

Refer to [Table 182](#) on page 1283 for further information on the path status.

**To add a new logical path from the connected MCU to an existing RCU:**

1. From the CU Number/Port tree on the RCU Operation screen, make sure the correct CU image is selected.

2. From the MCU/RCU list, click the RCU to which you want to set the path.
3. Right-click to display the pop-up menu and click **Edit SSID(s)&Path(s)**.
4. Right-click again and click **Add Path** from the pop-up menu (see the following figure). The Add Path window is displayed.



**Figure 262: Adding a new logical path from the connected MCU to an existing RCU**

5. From the Add Path window, enter the new path(s). Each item has seven fields to enter, but you can only enter the number of paths left (the maximum number of the paths is eight).
6. Click **Set** in the Add Path window to set the paths. The list changes to the Path Settings Parameter list.

---

**Note:** After being set, the options can be modified and/or canceled (see [Modifying Parameters and Deleting Settings](#) on page 659).

---

7. Click **Apply** on the CA main screen to apply the settings to the disk array. The MCU will automatically begin using the new logical path for CA activities.

Before deleting a path to an RCU, make sure that the remaining number of paths will be equal to or greater than the minimum number of paths setting (selected on the RCU Option window). The delete path operation will fail if the number of remaining paths is less than the minimum number of paths.

**To delete a path from the connected MCU to an existing RCU:**

1. Open the RCU Option window, and check the minimum number of paths setting. If the remaining number of paths will be less than this value, the delete path operation will fail. If needed, change the minimum number of paths so that you can delete the path.
2. From the CU Number/Port tree on the RCU Operation screen, make sure the correct CU image is selected.
3. From the MCU/RCU list, click the RCU of which you want to delete the path.
4. Right-click to display the pop-up menu and click **Edit SSID(s)&Path(s)**.
5. Right-click again and click **Delete Path** from the pop-up menu. The list changes to the Path Settings Parameter list. Only the RCUs that were selected are listed.

---

**Note:** After being set, the options can be modified and/or canceled (see [Modifying Parameters and Deleting Settings](#) on page 659).

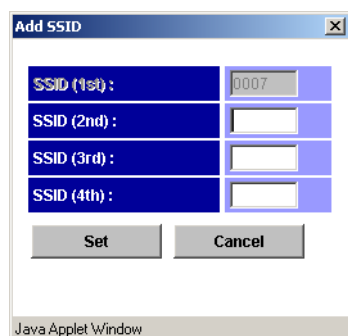
---

6. Click **Apply** on the CA main screen to apply the deletion to the disk array.

## **Adding and Deleting SSIDs for an RCU (Add SSID/Delete SSID)**

Before adding an SSID, make sure that the remote copy connection is properly installed. You can add three SSIDs to each RCU. Before deleting an SSID, make sure the remaining SSIDs are still valid, or the connection between the MCU and RCU may be lost.

Use the **Add SSID** and **Delete SSID** commands to add and delete the SSIDs for an existing RCU. When the **Add SSID** command is selected, the Add SSID window is displayed, which you can use to add three SSIDs at once to the selected RCU CU image.



**Figure 263: Add SSID window**

The Add SSID window displays three **SSID** fields to enter. You can enter up to three SSIDs at once with the Add SSID window. You can add up to four SSIDs (the maximum number of the SSID) in total.

The **Cancel** button cancels the settings you made. The **Set** button applies the settings you made and changes the list.

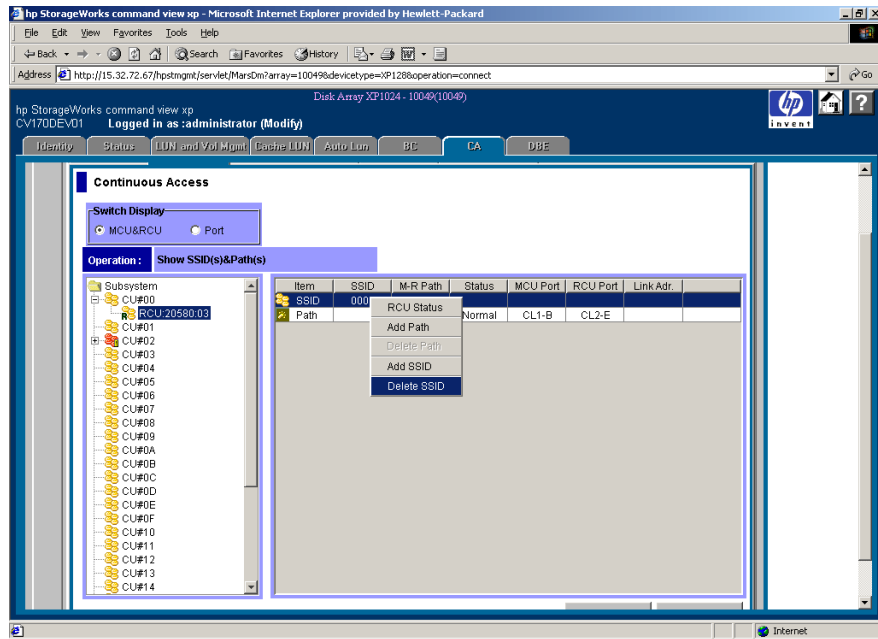
**To add or delete an SSID for an existing RCU:**

1. From the CU Number/Port tree on the RCU Operation screen, make sure the correct CU image is selected.
2. From the MCU/RCU list, click the RCU that you want to add or delete the SSID(s).
3. To add an SSID:
  - a. Right-click to display the pop-up menu and click **Edit SSID(s)&Path(s)**.
  - b. Right-click again and click **Add SSID** from the pop-up menu. The Add SSID window is displayed.
  - c. From the Add SSID window, enter the new SSID(s) in the **SSID** fields. You can add up to four SSIDs (in total) to the RCU.
  - d. Click **Set** to add the SSIDs. The list changes to the SSID Settings Parameter list. The added SSIDs are listed.

---

**Note:** After being set, the options can be modified and/or canceled (see [Modifying Parameters and Deleting Settings](#) on page 659).

---



**Figure 264: Adding/Deleting an SSID for an existing RCU**

4. To delete the SSID(s):
  - a. Right-click to display the pop-up menu and click **Edit SSID(s)&Path(s)**.
  - b. Right-click again and click **Delete SSID** from the pop-up menu (see the previous figure). The list changes to the SSID Settings Parameter list. Only the RCUs, which are to be deleted, are listed.

---

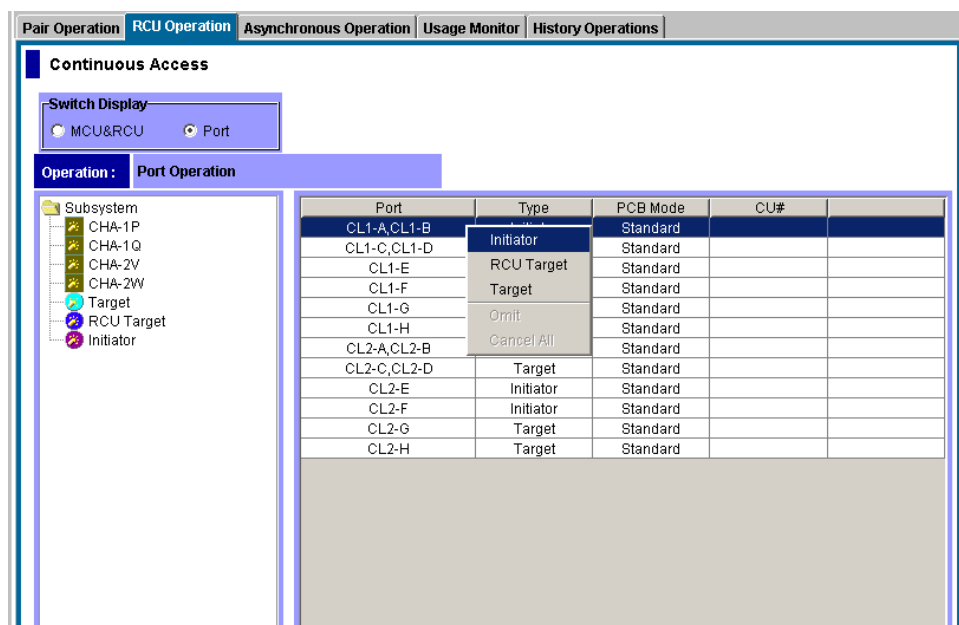
**Note:** After being set, the options can be modified and/or canceled (see [Modifying Parameters and Deleting Settings](#) on page 659).

---

5. Click **Apply** on the CA main screen to apply the settings to the disk array.

## Port Change Operation

The **RCU Operation** tab can be used to change the port mode. Clicking **Port** in the Switch Display box changes the tree to the Port tree and the list to the Port list. Use the Port tree and the Port list to change the port type.



**Figure 265: Changing the port type**

**To change the port type:**

1. Click **Port** in the Switch Display box to change the tree to the Port tree and the list to the Port list.
2. Click a port or a port type from the Port tree. Only the selected port or the selected port type is displayed in the Port list.
3. Click the port(s) you want to change from the Port list.
4. Right-click to display the pop-up menu and select a port type.

For the port change operation, there is no separate window and the list keeps displaying the Port list.

**Note:**

- Before changing the operation type of a Fibre Channel port from **Target** or **RCU Target** to **Initiator**, disconnect the port from the host, delete all affected CA pairs, delete all paths from the port (if RCU target) to the MCU, and then remove all channel paths to the port.
  - Before changing the operation type of a Fibre Channel port from **Initiator** to **Target** or **RCU Target**, delete all affected CA pairs, delete all paths to the RCU from the initiator port, and then delete the RCU from the MCU.
  - Before changing the operation mode of a serial port from **LCP** to **RCP**, remove all channel paths to the specified port.
  - Before changing the mode of a port from **RCP** to **LCP**, delete all affected CA pairs, delete all paths to the RCU from that RCP, and then delete the RCU from the MCU.
- 

Please limit the number of hosts connected to an RCU target port to 128 or fewer to avoid mistaken disconnection. If more than 128 hosts are connected to an ordinary target, some hosts may be disconnected after changing the type from **Target** to **RCU Target**. For performance reasons, try to avoid using the same FC card for CA and host connect.

## Modifying Parameters and Deleting Settings

After the RCU, Path, and/or SSID operation, the parameters can be modified individually. Also the RCUs, Paths, and/or SSIDs, which you have set by the each operation, can be deleted.

**To modify the parameters:**

1. Click a RCU, Path, or SSID whose parameters to be modified on the list.
2. Right-click to display the pop-up menu, and click **Modify** to modify the parameters. A window for each operation is displayed.
3. Modify the parameters and click **Set**.
4. Click **Apply** on the CA main screen to apply the modification.

---

**Note:** After the delete operation of the RCU, Path, and/or SSID operation, the **Modify** command is not available.

---

**To delete the RCUs, Paths, or SSIDs:**

1. Click the RCUs, Paths, or SSIDs to be deleted on the list.
2. Right-click to display the pop-up menu, and click **Omit**. The RCUs, Paths, or SSIDs selected in [step 1](#) are deleted from the list, and the deleted RCUs, Paths, or SSIDs are out of the operations.
3. Click **Apply** on CA main screen to apply the deletion.

The **Cancel All** command deletes all the RCUs, Paths, or SSIDs on the list, and all the RCUs, Paths, or SSIDs become out of the operations. All the RCUs, Paths, or SSIDs can also be deleted using the **Omit** command by selecting all of the RCUs, Paths, or SSIDs on the list. When all the RCUs, Paths, or SSIDs are deleted (by the **Cancel All** command, or the **Omit** command), the list status becomes the Volume list.

## CA Asynchronous Operations

The CA Asynchronous operations include:

- Viewing consistency group status (see page 662)
- Adding consistency groups (see page 663)
- Modifying the consistency group options (see page 665)
- Deleting consistency groups (see page 667)
- Setting the Asynchronous copy options (see page 668)

From the Asynchronous Operation screen (see page 629), you can perform the asynchronous operations. All the operations that can be performed from the Asynchronous Operation screen have a common procedure.

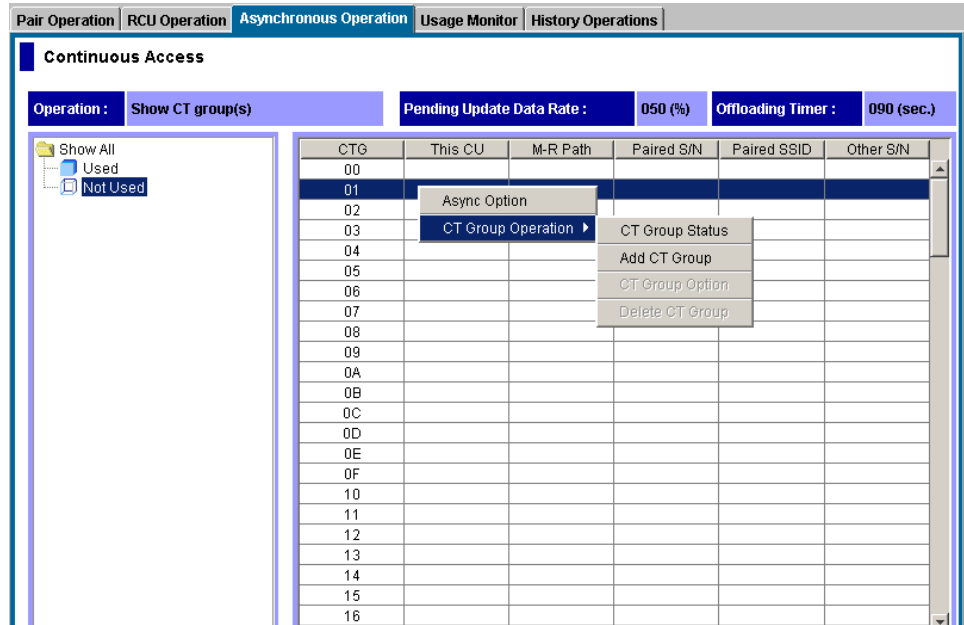
**To perform asynchronous operations:**

1. Click a consistency group mode (**Show ALL**, **Used**, or **Not Used**) to be operated in the Consistency Group tree.
2. Click one or more consistency group to be operated in the Consistency Group list.
3. Right-click to display the pop-up menu. The pop-up menu consists of:
  - **CT Group Operation:** Performs the following consistency group operations: **CT Group Status** (see [Viewing Consistency Group Status \(CT Group Status\)](#) on page 662), **Add CT Group** (see [Adding Consistency Groups \(Add CT Group\)](#) on page 663), **CT Group Option**



(see [Modifying Consistency Group Options \(CT Group Option\)](#) on page 665), and **Delete CT Group** (see [Deleting Consistency Groups \(Delete CT Group\)](#) on page 667).

- **Async Option:** Set the parameters for the asynchronous copy operation (see [Asynchronous Copy Option](#) on page 668).



**Figure 266: Performing asynchronous operations**

4. Click a command and use the window to make your settings.
5. Click **Set**. The Consistency Group list changes to the Consistency Group Settings Parameter list or the Asynchronous Options Settings Parameter list. The consistency groups selected in [step 2](#) are only listed and items in the list depend on the selected command.

**Note:** After being set, the options can be modified and/or canceled (see [Modifying Parameters and Deleting Consistency Groups](#) on page 671).

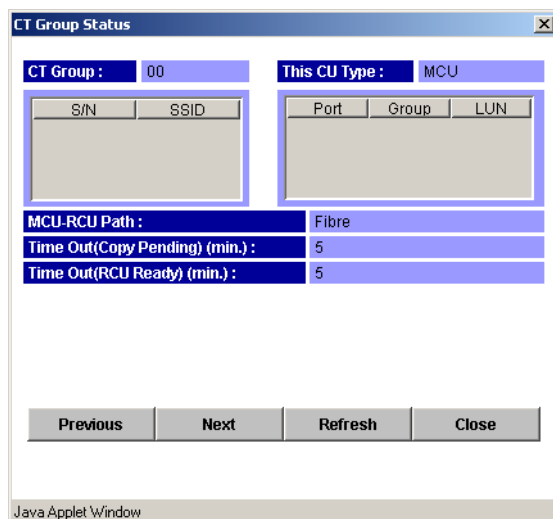
6. Click **Apply** on the CA main screen to apply the settings to the disk array.

## Viewing Consistency Group Status (CT Group Status)

The **CT Group Status** command can be used to display the consistency group status information.

### To display the consistency group status information:

1. From the Consistency Group tree, click a consistency group mode that includes the consistency group that you want to display the consistency group status information.
2. From the Consistency Group list, click only one consistency group.
3. Right-click to display the pop-up menu, click **CT Group Operation**, and then click **CT Group Status**. The CT Group Status window is displayed.



**Figure 267: CT Group Status window**

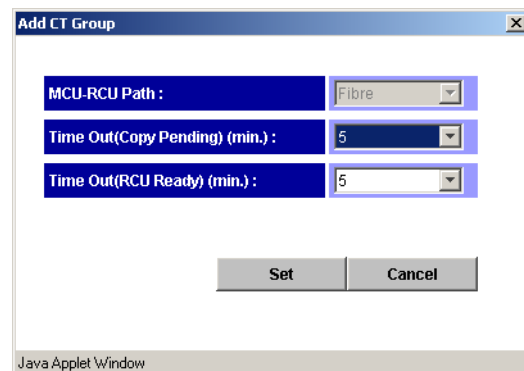
- **CT Group:** Consistency group number of the selected consistency group in the list.
- **This CU Type:** Registering side (MCU or RCU) of the consistency group.
- **S/N, SSID:** Serial number and SSID of the CUs that are the components of the selected consistency group.

- **Port, Group, LUN:** Pairs in the connected CU that are in the selected consistency group. The Group column shows the host group name in parentheses and the LUN column shows the CU:LDEV in parentheses. For LUs with more than one path, only the first path is listed.
- **MCU-RCU Path:** Channel type, fibre or serial.
- **Time Out (Copy Pending):** Maximum delay allowed for CA Async copy (see [Adding Consistency Groups \(Add CT Group\)](#) on page 663).
- **Time Out (RCU Ready):** Maximum delay allowed for re-establishing MCU-RCU communications following MCU power-off (see [Adding Consistency Groups \(Add CT Group\)](#) on page 663).

The **Previous** button displays information about the consistency group before the current consistency group. The **Next** button displays information about the consistency group after the current consistency group. The **Refresh** button refreshes the displayed information. The **Close** button closes the CT Group Status window.

## Adding Consistency Groups (Add CT Group)

Use the **Add CT Group** command to add a consistency group to the connected MCU. When the **Add CT Group** command is selected, the Add CT Group window is displayed. The Add CT Group window selects the group options for the group.



**Figure 268: Add CT Group window**

Use the **MCU-RCU Path** field to select the path type for the remote copy connections.

Use the **Time Out (Copy Pending) (min.)** field to select the maximum delay allowed for CA Async copy (none or from 1 to 15 min., none = no timeout for CA Async copy pending). The default setting is five minutes. If the delay between the CA Async P-VOL update and the corresponding S-VOL update reaches the specified time, the RCU will suspend all S-VOLs in the group. A timeout occurs when the RCU was not able to settle a recordset within the specified time, or when the RCU has not had any communication from one of the MCUs in the group within the specified time.

---

**Note:** The copy pending timeout value should be less than the I/O timeout value of the host system.

---

Use the **Time Out (RCU ready) (min.)** field to select the maximum delay allowed for re-establishing MCU-RCU communications following MCU power-off (none or from 1 to 10 min., none = no timeout for CA Async RCU ready). The default setting is five minutes. If the MCU is not able to re-establish communication with the RCU within the specified time, the MCU suspends all P-VOLs in the group.

The **Cancel** button cancels the settings you made. The **Set** button sets the consistency group options you set.

**To add a consistency group:**

1. Connect to the MCU.
2. Make sure that the async options are configured as needed (see [Asynchronous Copy Option](#) on page 668).
3. From the Consistency Group tree, click a consistency group mode that includes the consistency group that you want to add.
4. From the Consistency Group list, click the consistency group(s) to add. Make sure to select more than one group that is not registered yet.
5. Right-click to display the pop-up menu, click **CT Group Operation**, and then click Add CT Group. The Add CT Group window is displayed.
6. From the Add CT Group window, click the port type (fibre) and group options: copy pending timeout and RCU ready timeout. Remember that you will not be able to modify the port type of the group, after you assign a pair to the group.
7. Click **Set** in the Add CT Group window. The Add CT Group window is closed and the list changes to the Consistency Group Settings Parameter list.

---

**Note:** After being set, the options can be modified and/or canceled (see [Modifying Parameters and Deleting Consistency Groups](#) on page 671).

---

8. Click **Apply** on the CA main screen to apply the settings to the disk array.

When the Add CT Group window is closed, the list changes to the Consistency Group Settings Parameter list. However, the columns other than the CTG become blank. For further information about the Consistency Group Settings Parameter list, see [Modifying Consistency Group Options \(CT Group Option\)](#) on page 665.

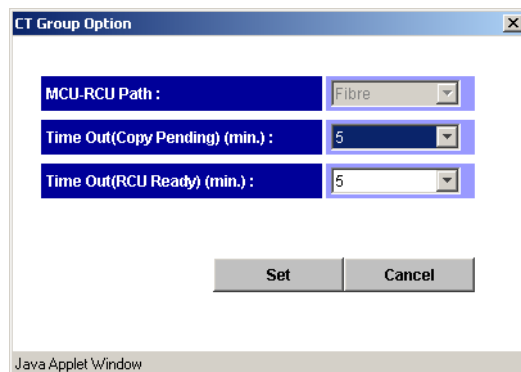
## Modifying Consistency Group Options (CT Group Option)

Use the **CT Group Option** command to modify the consistency group options you have set when the consistency group is added. When the **CT Group Option** command is selected, the CT Group Option window is displayed. The CT Group Option window consists of the same fields as the Add CT Group window (see [Adding Consistency Groups \(Add CT Group\)](#) on page 663).

---

**Note:** If you want to change the group options, you must split all pairs in the group first.

---



**Figure 269:** CT Group Option window

The **MCU-RCU Path** drop-down list indicates the selected port type for the remote copy connections. You cannot change the port type on the CT Group Option window.

Use the **Time Out (Copy Pending) (min.)** field to select the maximum delay (copy pending timeout) allowed for CA Async copy (none or from 1 to 15 min., none = no timeout for CA Async copy pending). The default setting is five minutes. If the delay between the CA Async P-VOL update and the corresponding S-VOL update reaches the specified time, the RCU will suspend all S-VOLs in the group. A timeout occurs when the RCU was not able to settle a recordset within the specified time, or when the RCU has not had any communication from one of the MCUs in the group within the specified time.

---

**Note:** The copy pending timeout value should be less than the I/O timeout value of the host system.

---

Use the **Time Out (RCU Ready) (min.)** field to select the maximum delay allowed for reestablishing MCU-RCU communications following MCU power-off (none or from 1 to 10 min., none = no timeout for CA Async RCU ready). The default setting is five minutes. If the MCU is not able to re-establish communication with the RCU within the specified time, the MCU suspends all P-VOLs in the group.

The **Cancel** button cancels the settings you made. The **Set** button sets the consistency group options you set.

**To change the group options:**

1. Connect to the MCU.
2. Split all pairs in the group (Pairsplit-r), so that you can change the group options.
3. From the Consistency Group tree, click a consistency group mode that includes the consistency group that you want to modify the consistency group option.
4. From the Consistency Group list, click the consistency group(s) to modify the option. Make sure to select more than one consistency group whose **This CU** column indicates **MCU**.
5. Right-click to display the pop-up menu, click **CT Group Operation**, and then click **CT Group Option**. The CT Group Option window is displayed. If the **CT Group Option** command is not enabled, you need to split the remaining pairs in this consistency group.
6. Change the group options as needed.

- Click **Set** in the CT Group Option window. The CT Group Option window is closed and the list changes to the **Consistency Group Settings Parameter** list. The settings are applied to the list.

---

**Note:** After being set, the options can be modified and/or canceled (see [Modifying Parameters and Deleting Consistency Groups](#) on page 671).

---

- Click **Apply** on the CA main screen to apply the settings to the disk array.
- When you are finished changing group options, resync all pairs in the group (pairresync).

When the CT Group Option window is closed, the list changes to the Consistency Group Settings Parameter list.

CTG	M-R Path	Time Out(Pending)	Time Out(Ready)
<i>00</i>	<i>Fibre</i>	<i>005</i>	<i>None</i>

**Figure 270: Consistency Group Settings Parameter list**

- **CTG:** Consistency group number.
- **M-R Path:** Channel type.
- **Time Out (Pending):** Copy pending time out (maximum delay) allowed for CA Async copy (in minutes).
- **Time Out (Ready):** RCU ready timeout (maximum delay) allowed for re-establishing MCU-RCU communications following MCU power-off (in minute).

## Deleting Consistency Groups (Delete CT Group)

A consistency group can be deleted only from the MCU and only if the MCU does not contain any P-VOLs still assigned to the group. Deleting a consistency group from an MCU does not affect the consistency groups registered at other MCUs. The RCU will automatically delete a consistency group when the last volume pair in the group is deleted.

Use the **Delete CT Group** command to delete the selected group from the current MCU. You cannot delete a group that still has P-VOLs in the current MCU.

### To delete a consistency group from an MCU:

- Connect to the MCU.

2. From the Consistency Group tree, click a consistency group mode that includes the consistency group that you want to delete.
3. From the Consistency Group list, click the consistency group(s) to delete. Make sure to select more than one consistency group whose This CU column indicates MCU.
4. Right-click to display the pop-up menu, click **CT Group Operation**, and then click **Delete CT Group**. The list changes to the Consistency Group Settings Parameter list. If the **Delete CT Group** command is not enabled, the selected group still contains P-VOLs in this MCU.

---

**Note:** After being set, the options can be modified and/or canceled (see [Modifying Parameters and Deleting Consistency Groups](#) on page 671).

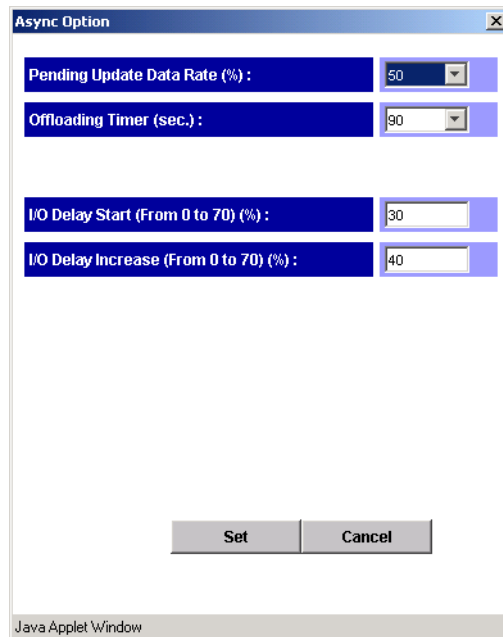
---

5. Click **Apply** on the CA main screen to apply the deletion to the disk array.

## Asynchronous Copy Option

Use the **Async Option** command to select the parameters for the CA asynchronous copy operation. When the **Async Option** command is selected, the Async Option window is displayed. Use the Async Option window to specify the CA asynchronous copy option parameters for the connected disk array. The async options apply to the entire physical control unit, including all CA P-VOLs and S-VOLs behind the control unit.





**Figure 271: Async Option window**

All the default settings indicate the current settings.

Use the **Pending Update Data Rate (%)** field to specify the CA Asynchronous sidefile threshold, which is the maximum amount of cache that can be used for storing CA Async recordsets (sidefiles). You can select any value between 30% and 70% (10% increments) (see [Inflow Control of Recordsets](#) on page 583).

The current pending update data rate is common to both CA and TC390 operations. The most recently entered value will be applied to all TrueCopy Async operations.

If one or more consistency groups exist, this setting cannot be changed. This setting can only be changed when no CT groups are assigned.

You can specify the Pending Update Data Rate from the Async Option window of TC390. If the value of the specified Pending Update Data Rate is less than the value of the I/O Delay Start or the I/O Delay Increase that you specified from the Async Option window of CA, the Pending Update Data Rate is available.

Use the **Offloading Timer (sec.)** field to specify the amount of time (0-255 seconds) that the MCU will wait to send a CA Async recordset to the RCU. The MCU will suspend all affected CA Async volume pairs, if it has not been able to offload a recordset to the RCU within the specified time (for example, the RCU is still responding channel-command-retry).

The offloading timer value should be set less than the HBA I/O timeout value.

When channel-extenders are used for CA Async, the offloading timer should be set to 35 seconds or less to avoid affecting host I/O performance.

**Available in firmware version 21.07.04 or later:**

Use the **I/O Delay Start** option to specify the threshold (0-70%), which is the maximum amount of cache for starting the inflow control for the asynchronous copy. When the amount of cache that is used for async recordsets reaches the specified value of threshold, the MCU controls the cash inflow.

Use the **I/O Delay Increase** option to specify the threshold (0-70%), which is the maximum amount of cache for starting to strengthen control over the inflow for the asynchronous copy. When the amount of cache that is used for async recordsets reaches the specified value of threshold, the MCU controls the cash inflow.

Specify a value not exceeding the value of I/O Delay Increase for the value of I/O Delay Start. Specify a value not exceeding the value of Pending Update Data Rate for the value of I/O Delay Increase. If the sidefile threshold is set between 0 to 30%, the influence to the I/O delay is kept low.

We recommend that you change the values of I/O Delay Start and I/O Delay Increase when all asynchronous pairs of CA are suspended, or neither the host I/O nor sidefiles exist. If you do not want to control the inflow into a sidefile, specify a value the same as the Pending Update Data Rate for both values of I/O Delay Start and I/O Delay Increase, and 0 second for the Offloading Timer.

**To set the asynchronous option parameters:**

1. From the Consistency Group list, right-click to display the pop-up menu, and click **Async Option**. The Async Option window is displayed.

---

**Note:** You do not have to select a consistency group on the list.

---

2. From the Async Option window, select the parameters.

- Click **Set** to set the parameters. The list changes to the Asynchronous Option Settings Parameter list.

---

**Note:** After being set, the options can be modified and/or canceled (see [Modifying Parameters and Deleting Consistency Groups](#) on page 671).

---

- Click **Apply** on the CA main screen to apply the option settings to the disk array.

When the Async Option window is closed, the list changes to the Asynchronous Option Settings Parameter list.

Pending Rate	Offloading	Delay Start	Delay Increase
<b>050</b>	<b>090</b>	<b>030</b>	<b>040</b>

**Figure 272: Asynchronous Option Settings Parameter list**

- **Pending Rate:** Sidefile allocation in %. This indicates the sidefile threshold, which is the maximum amount of cache that can be used for storing CA asynchronous recordsets (sidefiles).
- **Offloading:** Offloading timer in second. This indicates that the MCU will wait to send a CA Async recordset to the RCU.
- **Delay Start** (Firmware version 21.07.04 or later only): The maximum amount of cache for starting the inflow control for the asynchronous copy.
- **Delay Increase** (Firmware version 21.07.04 or later only): The maximum amount of cache for starting to strengthen control over the inflow for the asynchronous copy.

## Modifying Parameters and Deleting Consistency Groups

After the Consistency Group (CT Group) and/or Asynchronous Option operation, the parameters can be modified individually. Also the consistency groups, which you have set by the operation, can be deleted.

### To modify the parameters:

- After you have performed the CT Group operation, click a consistency group whose parameters to be modified on the list. To modify the parameters for Async Option operation you do not have to select the row on the list.
- Right-click to display the pop-up menu, and click **Modify** to modify the parameters. A window for each operation is displayed.

3. Modify the parameters as you need, and click **Set**.
4. Click **Apply** on the CA main screen to apply the modification to the disk array.

**To delete the Consistency Groups:**

1. Click the Consistency Groups to be deleted on the list.
2. Right-click to display the pop-up menu, and click **Delete**. The Consistency Groups selected in [step 1](#) are deleted from the list, and the deleted Consistency Groups are out of the operations.
3. Click **Apply** on the CA main screen to apply the deletion to the disk array.

For the CT Group operation, the **Cancel All** command deletes all the consistency groups on the list, and all the consistency groups become out of the operations. All the consistency groups can also be deleted using the **Delete** command by selecting all of the consistency groups on the list. When all the consistency groups are deleted (by the **Cancel All** command or the **Delete** command), the list status becomes the **Volume** list.

For the Asynchronous Option operation, the **Delete** command is not available. You can modify the options you have set, or you can cancel all the option settings you made.

---

**Note:** After the delete operation of the **CT Group Operation** command, the **Modify** command is not available.

---

## Usage Monitor Operations

Click the **Usage Monitor** tab to perform the remote copy usage monitoring operations for the connected disk array. The usage monitoring function collects I/O statistics for all LDEVs on the connected disk array.

The usage monitor operations are:

- Starting and stopping monitoring (see page 673)
- Displaying the usage monitor graph (see page 673)

## Starting and Stopping Monitoring

At each data sampling time interval, the usage monitoring function collects 480 pieces of data for each LDEV and up to 16,385 pieces of data for the entire disk array.

### To start remote copy usage monitoring:

1. Click the **Usage Monitor** tab.
2. Enter the desired sampling time interval (from 1 to 540 minutes) from the **Rate** field. A rate of five minutes or more is recommended.
3. Click **Run** in the **Operation** drop-down list.
4. To start monitoring, click **Apply**. When the confirmation dialog box is displayed, click **OK** to confirm. The Status will change from Stop to Running. To cancel your settings, click **Cancel**.

The collection of monitoring data continues, even if the window is closed, until you stop monitoring operations. Monitoring data collection continues even if the disk array is rebooted.

### To stop remote copy usage monitoring:

1. Click the **Usage Monitor** tab.
2. Click **Stop** in the **Operation** drop-down list.
3. To stop monitoring, click **Apply**. When the confirmation dialog box is displayed, click **OK** to confirm. The Status field will change from Running to Stop. To cancel your setting, click **Cancel**.

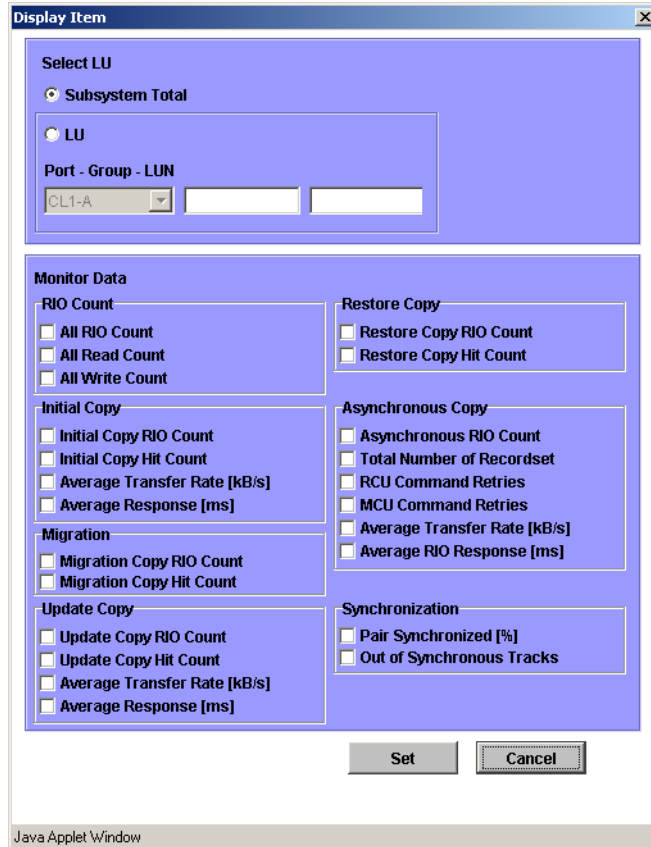
## Displaying the Usage Monitor Graph

When usage monitoring is running, clicking the Usage Monitor tab can display user-selected remote copy I/O statistics in real time. The I/O statistics data is collected according to the data-sampling rate indicated in the **Rate** field.

The usage monitor graph plots the user-selected I/O statistics (up to 65 data points) on an x-y graph. The x-axis displays time. The y-axis displays the number of I/Os during the last sampling period. The legend on the right side of the graph indicates the data being displayed. If a value on the y-axis exceeds 10,000,000, the value is displayed in exponential notation. For example,  $1E7 = 1 \times 10^7 = 10,000,000$  or  $2E8 = 2 \times 10^8 = 200,000,000$ . The **Update** area displays the most recent data sample time for the data on the graph.

**To display the usage monitor graph:**

1. Click the **Usage Monitor** tab.
2. Verify that usage monitoring is running (Status = Running). The usage monitor graph can only be displayed when monitoring is on.
3. Right-click the graph area to display the pop-up menu and click **Display Item**. The Display Item window is displayed.



**Figure 273: Display Item window**

4. To display I/O statistics for all LDEVs in the subsystem, click **Subsystem Total**. To display I/O statistics for a specific LU, click **LU** and then enter the LU by selecting the port from the drop-down list and entering the group (00-7F) and LUN (00-FF).

5. In the Monitor Data area, select the I/O statistics data that you want to display on the graph. You must select at least two check boxes. [Table 75](#) describes the I/O statistics data.

---

**Note:** To display Average Transfer Rate, Average Response, or Pair Synchronized, do not select any other statistics at the same time. The graph can only display one type of data at a time: I/O count, rate, response time, or percent.

---

6. Click **Set** to display a graph showing the selected I/O statistics data for the selected LU(s).
7. Complete any of the following tasks if needed:
  - To enlarge the displayed graph, right-click the graph to display the pop-up menu and click **Large Size**.
  - To return the graph to normal size, right-click the graph to display the pop-up menu and click **Normal Size**.
  - To stop displaying the usage monitor graph, right-click the graph to display the pop-up menu and click **Close**. To stop displaying all graphs, click **Close All**.

**Table 75: Remote copy I/O statistics**

Statistic	Description
RIO count	
All RIO count	Total number of remote I/Os.
All read count	Total number of remote read I/Os.
All write count	Total number of remote write I/Os.
Initial copy	
Initial copy RIO count	Number of initial copy remote I/Os.
Initial copy hit count	Number of initial copy hits.
Average transfer rate (kB/s)	Average transfer rate (kB/sec) for initial copy remote I/Os.
Average response (ms)	Average response time (msec) for initial copy remote I/Os.
Migration Copy	
Migration copy RIO count	Number of migration copy remote I/Os.
Migration copy hit count	Number of migration copy hits.

**Table 75: Remote copy I/O statistics (Continued)**

Statistic	Description
Update Copy	
Update copy RIO count	Number of update copy remote I/Os.
Update copy hit count	Number of update copy hits.
Average transfer rate (kB/s)	Average transfer rate (kB/sec) for update copy remote I/Os.
Average response (ms)	Average response time (msec) for update copy remote I/Os.
Restore Copy	
Restore copy RIO count	Number of restore copy remote I/Os.
Restore copy hit count	Number of restore copy hits.
Asynchronous Copy	
Asynchronous RIO count	Number of asynchronous update copy remote I/Os.
Total number of recordsets	Number of asynchronous recordsets.
RCU command retries	Number of command retries due to RCU channel-command-retry messages.
MCU command retries	Number of command retries due to MCU state-change-pending (SCP) messages.
Average transfer rate (kB/s)	Average transfer rate (kB/sec) for CA Async update copy remote I/Os.
Average RIO response (ms)	(Total RIO process time on a subsystem or selected volume for a certain interval period) / (Asynchronous RIO count); where RIO process time = time between the async data transfer request and the actual transfer of the recordset(s) to the RCU.
Synchronization	
Pair Synchronized (%)	Percent completion of initial copy operations. For example, number of synchronized pairs/total number of pairs.
Out of Sync Tracks	Number of tracks that have not yet been copied by the initial copy or resync copy operation. This applies only when suspended during initial copy or during resync copy.

The usage monitor graph closes automatically in the following cases:

- Stopping the usage monitoring function by clicking **Stop** in the **Operation** drop-down list and then clicking **Apply**.
- Clicking another tab.
- Exiting Command View.



## Optimizing CA Operations and Disk Array Performance

CA operations result in increased utilization of the disk array's channel resources because of the additional write (remote copy) operations to the secondary volumes. The CA update copy mode (synchronous or asynchronous) determines exactly how the remote copy operations will impact disk array performance as follows:

- **Synchronous** copy mode has an additional effect on disk array performance: increased service and disconnect time for write I/Os to CA P-VOLs due to the delay between channel-end and device-end. The length of this delay increases as the distance between the P-VOL and S-VOL increases, so that the longest delay occurs when the primary and secondary volumes are the maximum distance apart.
- **Asynchronous** copy mode (CA Asynchronous) eliminates all delays associated with CA Synchronous operations while providing protection for write-dependent applications in the event of a disaster. Write I/Os for CA Async P-VOLs are processed in the same way as writes for simplex volumes, without any increase in service or disconnect time. The asynchronous S-VOL updates are performed completely independent of all host I/O processes at the P-VOLs, and there are no restrictions on subsequent read/write operations to CA Async P-VOLs. The only performance concerns for CA Asynchronous are (1) ensuring that adequate cache resources are available for sidefiles that are used to store the recordsets at both the MCUs and RCUs, and (2) ensuring that sufficient Fibre Channel paths are defined for copy operations.

In addition to the CA update copy mode, several other factors can also affect disk array performance. You can optimize both the CA operations and the I/O performance of the disk arrays by analyzing workloads and addressing system-level conditions (for example, number of Fibre Channel paths) which can affect disk array performance. You can also control the impact of CA operations on disk array performance by selecting the appropriate RCU options for each MCU (see [Registering an RCU \(Add RCU\)](#) on page 642 and [Modifying RCU Options \(Change RCU Option\)](#) on page 648) and the appropriate update copy mode (synchronous or asynchronous) and pair options (see [Creating CA Volume Pairs \(Paircreate\)](#) on page 686) for each CA pair. In addition, you can upgrade the CA hardware components and/or adjust the configuration of the components to improve disk array performance under a wide range of operating conditions.

The following table lists some of the conditions that affect disk array performance and provides recommendations for addressing these conditions.

**Table 76: Disk array performance conditions and recommendations**

Condition	Description	Recommendation(s)
Write-intensive workloads	Write-intensive workloads, such as database logging volumes, can have a significant impact on disk array I/O response times.	Spread write-intensive data across several volumes to minimize queuing. Also consider increasing the duplex write line (DWL) of the disk array using Performance Advisor (Performance Advisor running at the same time is not supported).
Large block size	Workloads with large write block sizes, such as DB deferred writes, can impact performance.	Spread workloads with large write block sizes across several volumes.
High host channel demand	The demand on the MCU's host channels can affect performance.	Spread the workload across several disk arrays to utilize additional channels.
Sequential write operations	CA operations can have a negative impact on workloads with a high percentage of sequential write operations, such as batch processing operations (for example, dump/restore, sort operations).	Avoid performing restore operations to volumes that belong to CA pairs. Instead, restore data to a scratch volume and then create the CA volume pair.
Cache size	Large cache size improves read hit performance, which allows more disk array resources to be devoted to write operations. The resulting performance improvement can offset some or all of the performance loss due to the CA remote copy operations.  CA Asynchronous requires additional cache for sidefile data. Insufficient cache resources can result in command retries, state-change-pending (SCP) notifications, and puncture conditions.	Consider increasing the cache size of the CA disk arrays to handle cache sidefile operations and to improve overall disk array performance. For best results, the cache and NVS capacity of the primary and secondary disk arrays should be the same (for CA Asynchronous the RCU sidefile requirements are twice that of the MCU) to enable the remote site to function adequately during disaster recovery.
RCU capacity	The performance of the RCUs directly affects the performance of the MCUs. If an RCU becomes overloaded with heavy update activity, MCU and system performance can also be degraded.	Distribute CA remote copy operations among several remote disk arrays to avoid overloading any one RCU.
Paths	An inadequate number of paths may decrease disk array performance. Performing CA Synchronous operations over long distances can also degrade performance. CA Asynchronous is recommended for long distances.	Make sure to install an adequate number of paths between the primary and secondary disk arrays. This is especially important for disk arrays that contain both P-VOLs and S-VOLs.

## Discontinuing CA Operations

If you plan to use CA for nondisruptive data migration or duplication (see [Using CA for Data Migration and Duplication](#) on page 707), you will configure and establish CA operations, allow CA to synchronize the volumes, redirect application I/Os (if migrating), and then discontinue CA operations. When you are ready to discontinue CA operations, you will need to perform CA operations in the correct order to avoid generating error messages. For example, CA will not delete an RCU path until you have deleted all CA pairs still using that path, and you cannot delete a group until you have deleted all CA Asynchronous pairs in that group.

### To discontinue all CA operations:

1. Delete all CA pairs from the MCU(s) (pairsplit-S, see [Deleting CA Volume Pairs \(Pairsplit-S\)](#) on page 701). For CA Async pairs, you can use the **Delete Range-Group** option to delete all pairs in a group using just one operation. Verify that the pair status has changed to SMPL for all CA volumes before continuing.
2. Delete the CA Async group(s) from the MCU(s) (see [Deleting Consistency Groups \(Delete CT Group\)](#) on page 667). The RCU will automatically delete a group when all pairs in the group have been deleted.
3. Delete the RCUs (see [Deleting an RCU \(Delete RCU\)](#) on page 650). Check each CU image of each MCU to make sure that all RCUs have been deleted before continuing.
4. Remove the remote copy connections (physical paths). If you are not familiar with the operation of the remote copy hardware components, please call HP technical support for assistance.
5. For Fibre Channel interface, reset the initiator port(s) to ordinary target(s) at the MCU(s) (see [Port Change Operation](#) on page 657).

## Performing CA Pair Operations

### Preparing for CA Volume Pair Operations

Before starting CA operations, you must consider the relative importance of disk array I/O performance and disaster recovery preparation. As described in [Optimizing CA Operations and Disk Array Performance](#) on page 677, remote copy operations can affect the I/O performance of the MCUs and RCUs. CA provides many options (initial copy options, pair options, group options, async options) to control the impact of CA operations on I/O performance. These options can be set separately for each pair, for each CA Async group, and for each MCU to provide maximum flexibility. You can select options that minimize the impact of CA operations on disk array performance, or options that maximize the effectiveness of CA operations to ensure the best level of backup data integrity. System-level factors (for example, number of paths) can also affect CA operations and disk array performance (see the previous table).

For CA disaster recovery operations, you should make sure that the RCUs are attached to a host server to enable reporting of sense information and transfer of host failover information. If the remote site is unattended, you should attach the RCUs to a host server at the main site, so that the system administrator can monitor the operational condition of the RCUs.

To prepare for CA volume pair operations, you need to identify the volumes (by port, TID, and LUN and/or by LDEV ID) for which you want to establish CA remote copy operations. You should identify volumes that are required for system operation as well as volumes that contain important data to be backed up (for example, DB log files). Copying these volumes to the remote site will enable faster disaster recovery than maintaining a current version of these files at the remote site. For large databases that span multiple volumes, you should plan to establish a CA Asynchronous consistency group for each database, so that the update sequence consistency of the database can be ensured at the remote site.

You can start creating the CA volume pairs as soon as you have:

- Identified the volumes (LUs) that will become the CA P-VOLs (and S-VOLs).
- Ensured that all system and CA requirements have been met ([System Requirements](#) on page 598 and [Requirements and Restrictions](#) on page 599).
- Completed hardware and software installation (see [Installing the Hardware](#) on page 602 and [Fibre Channel Remote Copy Connections](#) on page 603).
- Configured the MCUs and RCUs for CA operations (see [Configuring the MCUs and RCUs for CA Operations](#) on page 609).

If you will be using CA to perform remote copy operations, the Command View management station must be LAN-attached to the MCU of each CA volume pair. You should also install and attach a Command View management station to the RCUs at your remote site. If you will be using RAID Manager commands instead of CA, please contact your HP representative for information on CA configuration services.

## Common Procedure for CA Pair Operation

From the CA main screen, you can perform the pair setting operations. All the operations that can be performed from the CA main screen have a common procedure.

### To perform the pair settings operation:

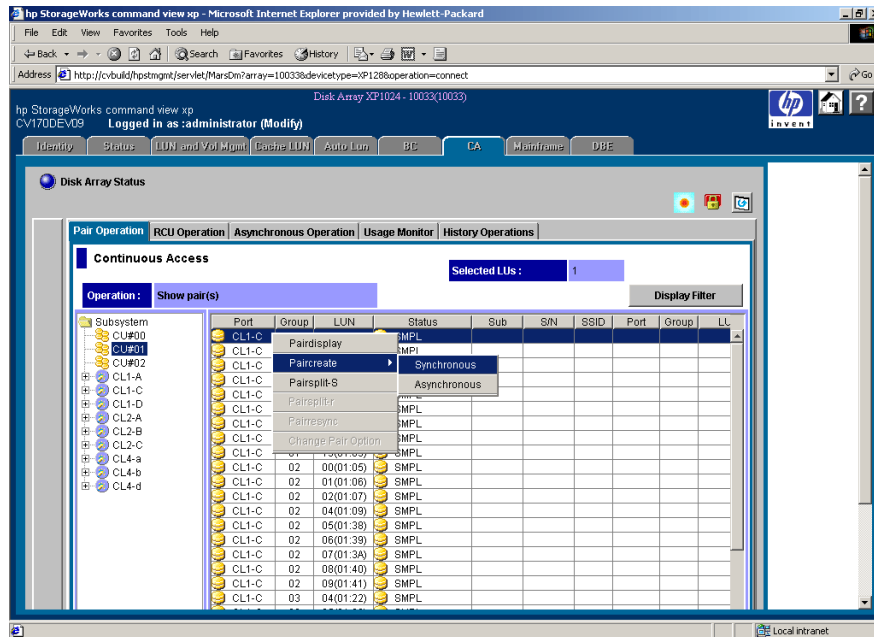
1. Click a CU number to be operated in the CU Number/Port Number tree.

---

**Note:** A CU number must be selected in the tree. When a Port number is selected in the tree, the pair setting operations cannot be performed.

---

2. Click one or more LUs or pairs to be operated in the Volume list.
3. Right-click to display the pop-up menu (see the following figure). The pop-up menu consists of:
  - **Pairedisplay:** Displays the LU status (see [Viewing CA Pair Status for LUs and LDEVs \(Pairedisplay\)](#) on page 684).
  - **Paircreate:** Creates a volume pair using the following commands: **Synchronous** and **Asynchronous** (see [Creating CA Volume Pairs \(Paircreate\)](#) on page 686).
  - **Pairsplit-S:** Deletes the pairs (see [Deleting CA Volume Pairs \(Pairsplit-S\)](#) on page 701).
  - **Pairsplit-r:** Splits (Suspends) the pairs (see [Splitting CA Pairs \(Pairsplit-r\)](#) on page 693).
  - **Pairresync:** Resumes the pairs (see [Resuming CA Volume Pairs \(Pairresync\)](#) on page 697).
  - **Change Pair Option:** Changes the pair option (see [Changing the Pair Options \(Change Pair Option\)](#) on page 705).



**Figure 274: Performing the pair settings operation**

4. Click a command and use the window to make your settings.
5. Click **Set**. The **Set** button sets the parameter to the list. The **Cancel** button closes the window, but does not set the settings. The **Cancel All** button returns you to the Volume list.

**Note:** After being set, the options can be modified and/or canceled (see [Modifying Parameters and Deleting LUs](#) on page 683).

6. Click **Apply** on the CA main screen to apply the settings to the disk array.
- The active commands of the pop-up menu displayed in [step 3](#) are in the black letters. The inactive commands are in the gray letters. The status of the commands (active or inactive) depend on the status of the LUs selected in the Volume list.
- The following sections describe in detail for each command and operation.

## List after the Command Selection

After the window is closed, only the LUs that are selected in [step 2](#) of the procedure described in the [Common Procedure for CA Pair Operation](#) on page 681 are displayed in the list. The items of the list are also changed. The Volume list that is in this status is called the Pair Settings Parameter list. The items of the Pair Settings Parameter list depend on the command clicked from the pop-up menu and the operation you performed. The items for each command are described in the sections.

The **Set** button on each parameter window presets the parameters to the Pair Settings Parameter list. To apply the parameters to the system, click **Apply** on the CA main screen.

The **Cancel** button closes the window, but does not set the parameters. The **Cancel All** button returns you to the Volume list.

## Modifying Parameters and Deleting LUs

After the pair settings operation, the LU parameters can be modified individually. Also the LUs that are selected to be the pairs can be deleted.

### To modify the parameters of an LU:

1. Click a LU whose parameters to be modified on the Pair Settings Parameter list.
2. Right-click to display the pop-up menu and click **Modify** to modify the parameters. A window is displayed.
3. Modify the parameters and click **Set**.
4. Click **Apply** on CA main screen to apply the modification.

### To delete the LUs:

1. Click the LUs to be deleted on the Pair Settings Parameter list.
2. Right-click to display the pop-up menu and click **Omit**. The LUs selected in [step 1](#) are deleted from the Pair Settings Parameter list, and the deleted LUs are out of the pair settings operations.
3. Click **Apply** on the CA main screen to apply the deletion.

The **Cancel All** command deletes all the LUs listed on the Pair Settings Parameter list, and all the LUs become out of the pair settings operations. All the LUs can also be deleted using the **Omit** command by selecting all of the LUs on the Pair Settings Parameter list. When all the LUs are deleted (by the **Cancel All** command or the **Omit** command), the list status becomes the Volume list.

## Viewing CA Pair Status for LUs and LDEVs (Pairdisplay)

The **Pairdisplay** command displays detailed CA pair status information.

**To display the CA pair status information:**

1. From the Volume list, click a LU whose pair status information to be displayed.
2. Right-click and click **Pairdisplay** from the pop-up menu. The Pairdisplay window is displayed. The **Pairdisplay** command can be selected whichever **Subsystem**, **CU number**, or **Port number** is selected in the tree.



**Figure 275: Pairdisplay window**

- **P-VOL and S-VOL:**



- Port - host group ID (host group name) - LUN (lowest LDEV number for a LUSE pair). Only the host group name of the primary site is displayed. The host group name of the secondary site is not displayed.
- Device emulation name.
- Capacity in MB (up to two decimal places).
- **Pair Status:** SMPL, COPY, PAIR, PSUE, PSUS, PDUB, Suspending, or Deleting (see [CA Volume Pair Status](#) on page 587 for further information for CA pair status). If the pair is split or suspended, the split/suspended type is also displayed.
- **Pair Synchronized:** Display how far the copy operation progressed in percentage and the progress bar.
- **RCU S/N and SSID:** Serial number and SSID of the RCU (or MCU if S-VOL is selected).
- **MCU-RCU Path:** Channel type of the path interface between the disk arrays (fibre or serial).
- **Update Type:** Synchronous or Asynchronous.
- **Initial Copy Pace:** 1-15 tracks (disabled when status becomes PAIR).
- **Initial Copy Priority:** 1-256 (disabled when the status becomes PAIR).
- **P-VOL Fence Level:** Conditions under which the MCU will reject write operations to the P-VOL. **Never:** Never fence the operation, **Data:** Fence when the MCU cannot successfully execute an update copy operation for any reason, **Status:** Fences only if the MCU is not able to change the S-VOL status to the same status as the P-VOL.
- **S-VOL Write:** Enabled or disabled for this pair (enabled only when the pair is split).
- **Pair Established:** Date and time that the volume pair was created.
- **Last Updated:** Date and time that the volume pair status was last updated.
- **Difference Management:** Auto, Cylinder, or Track.
- **Asynchronous Parameter** box consists of:
  - **CT Group:** Consistency group to which the CA Async pair is assigned.
  - **Error Level:** Error level for the CA Async pair(s).
  - **Suspended by:** Consistency status (group or LU) of the split or suspended CA Async pair (see [CA Volume Pair Status](#) on page 587) (displayed only at the RCU).

- **Consistency time:** Consistency time of the group to which the CA Async pair is assigned.
- The **Previous** button changes the displayed pair status information to that of the previous LU on the Volume list (the LU of the row above). The **Next** button changes the displayed pair status information to that of the next LU on the Volume list (the LU of the row below). The **Refresh** button refreshes the pair status information. The **Close** button closes the Pairdisplay window.

---

**Note:** The Display Filter settings can affect how **Previous** or **Next** is recognized. The Volume list can display 256 rows at once. Use the **Previous** and **Next** buttons to display the previous or next 256 rows.

---

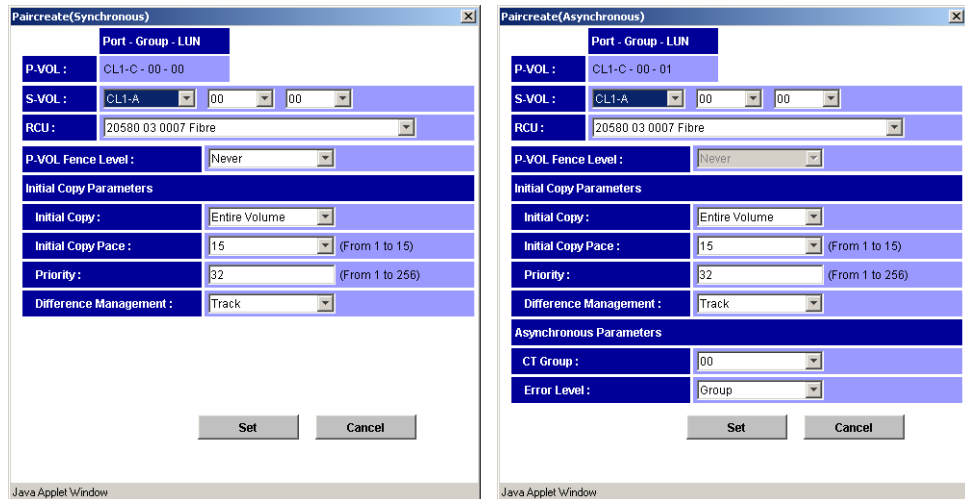
## Creating CA Volume Pairs (Paircreate)

Use the **Paircreate** command to create one or more new CA pairs. When the **Paircreate** command is selected, the Paircreate window is displayed. Use the Paircreate window to select the S-VOL, RCU, and initial copy options for the pair(s) being created.

---

**Note:** Make sure to select the appropriate CU image before creating any CA pairs.

---



**Figure 276: Paircreate window**

■ **Port - Group - LUN:**

- **P-VOL:** Displays the Port - Group - LUN of the Primary volume (P-VOL).
- **S-VOL:** Select a Secondary volume (S-VOL). Specify each item as follows, Port: 1A-2R, Group: 00-7F, LUN: 00-FF. If you select two or more LUs as P-VOLs in the Volume list, select an S-VOL for the P-VOL of the lowest LUN. The S-VOLs for the remainder of the P-VOLs are automatically assigned according to the LUN. For example, if you select three LUs on the Volume list and select LUN01 as S-VOL for the first P-VOL, S-VOLs of the following P-VOLs are LUN02 and LUN03.

**Note:** Make sure all the assigned S-VOLs are available. If the automatically assigned S-VOLs are already used for the other operation, you have to modify the S-VOL individually (see [Modifying Parameters and Deleting LUs](#) on page 683 for instructions).

- **RCU:** Select an RCU (Serial number, CU number, SSID, and Port type) for the CA pair(s) being created. The RCUs, which are already registered, can be selected from the drop-down list. The RCU must be the same for all pairs being created during this operation.

- **P-VOL Fence level:** Select the fence level that is the conditions under which the MCU will reject write operations to the P-VOL.
  - **Never:** Never fence the operation. When the asynchronous pair(s) is being created, **Never** is set automatically.
  - **Data:** Fence when the MCU cannot successfully execute an update copy operation for any reason.
  - **Status:** Fences only if the MCU is not able to change the S-VOL status to the same status as the P-VOL. This option is only for the synchronous mode.
- **Initial Copy Parameters:** Select the initial copy options.
  - **Initial Copy:** Specify the initial copy mode. **Entire:** Copy all the data. **No Copy:** Not copy. The default setting is **Entire**.
  - **Initial Copy Pace (From 1 to 15):** Select the number of the tracks 1-15 for initial copy. The default setting is 15.
  - **Priority (From 1 to 256):** Set the priority (scheduling order) of the initial copy operation. It can be set in the number of 1-256. The default setting is 32.
- **Difference Management:** Select **Auto**, **Cylinder**, or **Track**. The default setting is Auto. When you select Auto, either Cylinder or Track is selected depending on the basic size of the logical unit (LU).
- **Asynchronous Parameters:** Can be selected only for the Asynchronous pair(s).
  - **CT Group:** Select a consistency group that is already registered.
  - **Error Level:** Specifies the error level for the CA Async pair(s), Group or LU.
- The **Cancel** button cancels the settings you have made and closes the Paircreate window. The **Set** button sets the parameters and closes the Paircreate window.

When you are creating two or more pairs at the same time, the initial copy options will be the same for all the pairs. You can modify these initial copy options for individual pairs as needed. For the procedure to modify the options, see [Modifying Parameters and Deleting LUs](#) on page 683. For further information on the initial copy options, see [CA Initial Copy and Pair Options of the Paircreate Window](#) on page 691.

The **Use Time-Saving Mode** option executes the specified paircreate operations quickly (that is, requests for multiple pairs are entered simultaneously).

**To create one or more new CA volume pairs:**

1. Make sure that the volumes that will be the CA S-VOLs are offline from all hosts.
2. Connect to the disk array that contains the P-VOLs of the pair(s) you are creating, and start CA. The RCPs or Initiator ports must be configured (see [Configuring the MCU Ports](#) on page 636), and the RCU(s) must be registered already (see [Registering an RCU \(Add RCU\)](#) on page 642).
3. From the Volume list on the CA main screen, click the LU(s) that will be the P-VOL(s) of the CA volume pair(s). You can select one or more volumes and establish one or more pairs at a time only if the S-VOLs are in the same RCU and the pairs will have the same copy mode (Sync or Async). You cannot start CA Sync and CA Async pairs at the same time.
4. Right-click to display the pop-up menu, click **Paircreate**, and then click the pair mode (**Synchronous** or **Asynchronous**). The Paircreate window is displayed.

Pair mode specifies the update copy mode (see [Update Copy Operation](#) on page 578) for the new pair(s): **Synchronous** or **Asynchronous**. The selection of mode has the greatest impact on performance and must be considered carefully. Factors in mode selection include (but are not limited to) the use of CA (for disaster recovery or migration), the number of pairs, and the write I/O activity to the P-VOLs.

5. From the Paircreate window, enter the S-VOL for the pair, select the RCU, and select the initial copy options for the pair(s) being created (see [Creating CA Volume Pairs \(Paircreate\)](#) on page 686).
6. Click **Set** to close the Paircreate window and set the parameters.

The list changes to the Pair Settings Parameter list (Paircreate). The Pair Settings Parameter list (Paircreate) is updated by the parameter settings and displays all pairs being created. The initial copy options and pair options you selected are applied to all pairs, but you can modify the options for each pair individually as needed (see [Modifying Parameters and Deleting LUs](#) on page 683).

7. From the Pair Settings Parameter list (Paircreate), check the RCU S/N and SSID, S-VOL, and copy options for each pair. You can modify the options as you need (see [Modifying Parameters and Deleting LUs](#) on page 683). Make sure that all CA options for each new pair are correct.

8. If you want to execute the paircreate requests quickly, select the **Use Time-Saving Mode** check box above the Pair Settings Parameter list (Paircreate).
9. Click **Apply** on the CA main screen to create (start) the specified CA pair(s). The MCU will start the initial copy operations according to the initial copy priority and the maximum initial copy activities setting of the RCU.
10. From the CA main screen, verify that the new CA pair(s) is/are displayed correctly (COPY status) in the Volume list. To monitor the status of the new pair(s), click **Refresh** to update the information in the Volume list, or use the Pairdisplay window (see [Viewing CA Pair Status for LUs and LDEVs \(Pairdisplay\)](#) on page 684) to monitor the detailed status of each pair.

The Paircreate operation will be rejected if the P-VOL is in the correction access or correction copy state. If this occurs, wait for the volume state to change and then repeat this procedure. If the status is not displaying correctly, make sure that the correct CU image is selected. See [Troubleshooting Suspended CA Pairs](#) on page 1285 for troubleshooting information.



**Caution:** If a timeout error occurs when the **Use Time-Saving Mode** option is selected, confirm on the CA main screen for which volumes the paircreate operation could not be performed. Deselect the **Use Time-Saving Mode** option for the failed volumes, and retry the paircreate operation.

After the Paircreate window is closed, the list changes to the Pair Settings Parameter list (Paircreate).

Port	Group	LUN	S/N	SSID	Port	Group
CL1-C	00	00	20580	0007	CL1-E	03

LUN	Type	Mode	Fence	Pace	Priority	Diff	Error Code
02	Sync	Entire	Never	15	032	Track	

**Figure 277: Pair Settings Parameter list (Paircreate)**

- **Port, Group, and LUN** of the LU in the connected disk array.
- **S/N and SSID** of the RCU (MCU if you are connected to the RCU).
- **Port, Group, and LUN** of the LU to be the S-VOL.
- **Type:** **Synchronous** or **Asynchronous** of the pair created.
- **Mode:** **Entire:** Copy all cylinders. **No Copy:** Not copy.

- **Fence:** The conditions under which the MCU will reject write operations to the P-VOL. Never, Data, or Status.
- **Pace:** Number of the tracks 1-15 for initial copy.
- **Priority:** Priority (scheduling order) of the initial copy operation.
- **Diff:** In the measurement of the **Cylinder** or the **Track**, CA manages the differentials among data.
- **CTG:** Consistency group that is used for the pair created (Asynchronous pairs only).
- **ErrLvl:** Error level, **Group** or **LU**. When a failure occurs, the pairs in the same group or in an LU is/are suspended (Asynchronous pairs only).

## CA Initial Copy and Pair Options of the Paircreate Window

The CA initial copy and pair options you specify the fence level, initial copy parameters, and asynchronous parameters. The initial copy and pair options are selected on the Paircreate window. While the initial copy operation is in progress, the initial copy options cannot be changed unless you delete (pairsplit-S) and then restart (paircreate) the pair. After the initial copy operation is complete, you can only change the CA pair options (Fence Level and Error Level).

### Fence Level (CA Synchronous only)

**Fence Level:** Specifies the conditions under which the MCU will reject write operations to the P-VOL, which is known as “fencing.” This option is very important for disaster recovery planning (see [Considering the P-VOL Fence-Level Setting](#) on page 713).

- If **Never** is selected, the P-VOL will never be fenced. If the CA volume pair is split or suspended, write operations to the P-VOL will be accepted.
- If **Data** is selected, the P-VOL will be fenced when the MCU cannot successfully execute an update copy operation for any reason.
- If **Status** is selected, the P-VOL will be fenced only if the MCU is not able to change the S-VOL status to suspended when an update copy operation fails. If the MCU changes the S-VOL status to suspended, subsequent write operations to the P-VOL will be accepted, and the MCU will keep track of all P-VOL updates while the pair is suspended.

### Initial Copy Parameters

**Initial Copy:** Specifies the initial copy mode for the new pair(s). The default is **Entire Volume**.

- If **Entire Volume** is selected, the initial copy operation will copy all cylinders on the P-VOL (except diagnostic and unassigned alternate tracks) to the S-VOL.
- If **No Copy** is selected, the initial copy operation will not be performed. The MCU will begin performing update copy operations as needed.



**Caution:** The user must ensure that the P-VOL and S-VOL are already identical when using this setting.

---

**Initial Copy Pace:** Specifies the maximum number of tracks (**1-15**) that can be copied at one time by the CA initial copy operation before the MCU accepts another host request for that P-VOL. A high setting (for example, 15 tracks) speeds up the initial copy operation but may affect the disk array's I/O performance if the P-VOL is experiencing high write I/O activity. A lower setting (for example, 3 tracks) slows down the initial copy operation to minimize the impact of the initial copy operation on the disk array's I/O performance.

**Priority:** Specifies the order in which the initial copy operations will be performed, if the number of requested initial copy operations is greater than the maximum initial copy activity setting on the RCU Option window (see [Registering an RCU \(Add RCU\)](#) on page 642). The highest priority is 1, and the lowest priority is 256 (current default = 32). The CA initial copy priority option can be used to spread initial copy operations across disk array groups and/or disk array domains (ACP pairs) to reduce initial copy time as well as host I/O contention.

*Example:* Let's say that the maximum initial copy activity setting is four, and you add six CA pairs at the same time (for LUNs 00 through 05) with the initial copy priority set as follows:

P-VOL of pair	Priority	
LUN 03	1	The MCU will start the initial copy operations for LUNs 03, 05, 00, and 04 immediately, then start LUN 01 when one of the first four initial copy operations is complete, and then start LUN 02 when the next initial copy operation is complete. If more CA pairs are created, the MCU also prioritizes the initial copy operations by time requested, so that all pairs in the first group are started before any pair in the next group is started.
LUN 05	2	
LUN 00	3	
LUN 04	4	
LUN 01, 02	5	



**Difference Management:** Specifies the measurement method that CA will use to manage the differential data for the pair: Auto, Cylinder, or Track. The default setting is Auto. When you select Auto, either Cylinder or Track is selected depending on the basic size of the logical unit (LU).

### **Asynchronous Parameters**

**C/T Group:** Specifies the consistency group for the new pair(s) (Async only). All CA Asynchronous pairs must be assigned to a consistency group.

**Error level:** Specifies the error level for the CA Async pair(s).

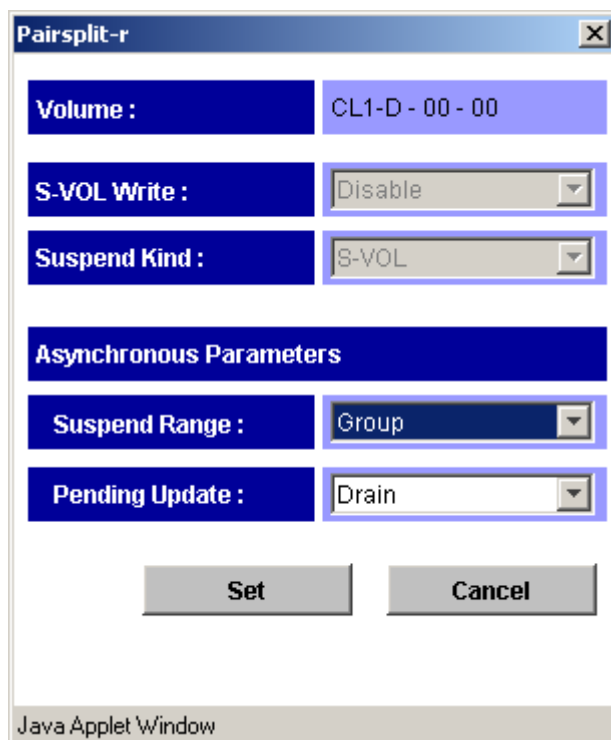
- **Group:** When the specified pair is suspended, all CA Async pairs in the same group will be suspended, even if the failure affects only that pair and not the entire group.

Select the **Group** error level for all CA Async volumes that are essential to disaster recovery. Suspended CA Async S-VOLs that have the **LU** error level should not be used for disaster recovery.

- **LU:** If the failure affects only the specified pair, then only that pair will be suspended. A failure that affects an entire group will always result in the suspension of all pairs in the group, as well as all other affected CA pairs.

## **Splitting CA Pairs (Pairsplit-r)**

Use the **Pairsplit-r** command to split CA pairs. When the **Pairsplit-r** command is selected, the Pairsplit-r window is displayed. Use the Pairsplit-r window to select the Pairsplit-r options for the pair(s). You can split a CA pair only after the initial copy operation is complete. For further information on split CA pairs, see [CA Split Types \(PSUS\)](#) on page 591.



**Figure 278: Pairsplit-r window**

The Pairsplit-r window selects the pairsplit-r options for the pair(s):

- **S-VOL Write:** The default setting is **Disable**.
  - **Enable:** The S-VOL of this CA pair will be available to receive read and write I/Os while the CA pair is split. If you select **Enable** and you want to resync the pair later, you should select the **S-VOL** suspend kind option to ensure that the P-VOL and S-VOL bitmaps are merged at the MCU. This option is available only when the selected volume is a CA P-VOL.
  - **Disable:** The S-VOL of this pair will accept only I/Os while the pair is split.
- **Suspend Kind:** The default setting is **S-VOL**.
  - **S-VOL:** The P-VOL will accept all subsequent write I/O operations, and the MCU will keep track of updates while the pair is split. Subsequent write I/O operations to the P-VOL will be permitted or rejected,

depending on the fence level of the pair. This setting is available from the MCU and RCU, and should be used if you need to keep the P-VOL online. All CA Asynchronous pairs have this setting.

- **P-VOL Failure** (available only for CA Synchronous and only when connected to the MCU): The MCU will reject all write I/O operations to the P-VOL while the pair is split, regardless of the P-VOL fence-level setting. This setting should be used if you need to maintain synchronization of the CA pair.

- **Asynchronous Parameters:**

- **Suspend Range:**

**Group:** The MCU/RCU will split all other CA Async pairs in the same consistency group as the specified pair(s). This option is available only when one pair is selected.

**LU:** The MCU/RCU will split only the specified CA Async pair(s) (even if the error level of the pair is group).

- **Pending Update:**

**Drain:** The MCU will change the CA Async pair status from **Suspending** to **PSUS** only after the RCU accepts the pairsplit operation and completes the following steps:

- (a) Finish settling all pending recordsets for the pair, and
- (b) Complete the negotiation with all MCUs (report ready-for-suspension to all MCUs and receive their acknowledgements) without further recordsets generated.

If the RCU is not able to complete these actions within the copy pending timeout setting, the RCU will discontinue the original pairsplit-r request and forcibly suspend the affected CA Async pairs. Thus, you can use the copy pending timeout parameter to limit the amount of time it takes to complete the split-drain operation.

**Purge:** The MCU will change the CA Async pair status from **Suspending** to **PSUS** as soon as the RCU accepts the pairsplit operation. The MCU and RCU discard any pending recordsets and mark the cylinders that contain discarded recordsets as modified in the P-VOL and S-VOL bitmaps, respectively. When the pair is resumed (pairresync), the P-VOL and S-VOL bitmaps will be merged at the MCU, and all cylinders marked as modified will be copied to the S-VOL.

If the MCU does not receive acknowledgement of the pairsplit-r operation from the RCU within the copy pending timeout setting, the MCU will forcibly suspend all affected CA Async pairs.

**To split one or more CA volume pairs:**

1. Connect to the MCU (or RCU) of the volume pair(s) to be split. You do not need to vary the P-VOL(s) offline. If you want to use the S-VOL write enable option, you must connect to the MCU and select the P-VOL of the pair.
2. From the CU Number/Port Number tree on the CA main screen, click the number of the correct CU image.
3. From the Volume list on the CA main screen, click the CA volume pair(s) that you want to split. Select either CA Synchronous or CA Asynchronous pairs, but not both. The pair status must be **PAIR**.
4. Right-click to display the pop-up menu, and click **Pairsplit-r**. The Pairsplit-r window is displayed.
5. From the Pairsplit-r window, click the options for the pair(s), and click **Set** to close the Pairsplit-r window and set the parameters. The list changes to the Pair Settings Parameter list (Pairsplit-r). You can modify the options, as you need (see [Modifying Parameters and Deleting LUs](#) on page 683). Make sure that the pairsplit options for each pair are correct. The suspend kind option (**S-VOL** or **P-VOL failure**) and fence level pair option determine whether the P-VOL will accept write I/O operations after the pair is split.



**Caution:** If you need to split a pair and the P-VOL is required for system operation, do not use the P-VOL Failure suspend kind option. Make sure to use the S-VOL suspend kind option so that the P-VOL continues accepting I/Os.

---

6. If you want to execute the pairsplit requests quickly, select the **Use Time-Saving Mode** check box above the Pair Settings Parameter list (Pairsplit-r).
7. Click **Apply** on the CA main screen to split the specified pair(s). For the CA Synchronous pairs, the MCU will complete all P-VOL write operations in progress and the associated update copy operations at the S-VOL before splitting the pair, so that the pair is synchronized at the time of pairsplit.

8. From the CA main screen, verify that the CA pair(s) is/are displayed correctly (**PSUS** status) in the Volume list. Use the **Pairresync** command (see [Resuming CA Volume Pairs \(Pairresync\)](#) on page 697) to resync split CA volume pair(s).



**Caution:** If a timeout error occurs when the **Use Time-Saving Mode** option is selected, confirm on the CA main screen for which volumes the pairsplit-r operation could not be performed. Deselect the **Use Time-Saving Mode** option for the failed volumes, and retry the pairsplit-r operation.

When the Pairsplit-r window is closed, the list changes to the Pair Settings Parameter list (Pairsplit-r).

Port	Group	LUN	S/N	SSID	S-VOL Wrt
<i>CL1-D</i>	<i>00</i>	<i>00</i>	<i>20030</i>	<i>0005</i>	<i>Disable</i>

Kind	Range	Mode	Error Code
<i>S-VOL</i>	<i>Group</i>	<i>Drain</i>	

**Figure 279: Pair Settings Parameter list (Pairsplit-r)**

The Pair Settings Parameter list (Pairsplit-r) displays the following information for the selected pair(s):

- **Port, Group** (TID), and **LUN** of the LU in the connected disk array.
- **S/N** and **SSID** of the RCU (MCU if you are connected to the RCU).
- **S-VOL Wrt:** Disable or enable. Enable means that the S-VOL is available to receive read and write I/Os.
- **Kind:** S-VOL or P-VOL Failure. The type of the suspend operation.
- **Range:** Split the pair(s) in what measure, Group or LU (Async only).
- **Mode:** Drain or purge pairsplit-r option (Async only).

## Resuming CA Volume Pairs (Pairresync)

While a CA pair is split or suspended, the MCU does not perform any update copy operations to the S-VOL.

- For a split/suspended CA Synchronous pair, the MCU may or may not continue accepting write I/Os for the P-VOL depending on the P-VOL fence level and pairsplit options (if user-requested) (see [Creating CA Volume Pairs \(Paircreate\)](#) on page 686 and [Splitting CA Pairs \(Pairsplit-r\)](#) on page 693).
- For a split/suspended CA Async pair, the MCU and RCU keep track of any recordsets that were discarded during pairsplit/suspension, and the MCU continues to accept write I/Os for the P-VOL. The MCU keeps track of the P-VOL cylinders that are updated while the pair is split/suspended.

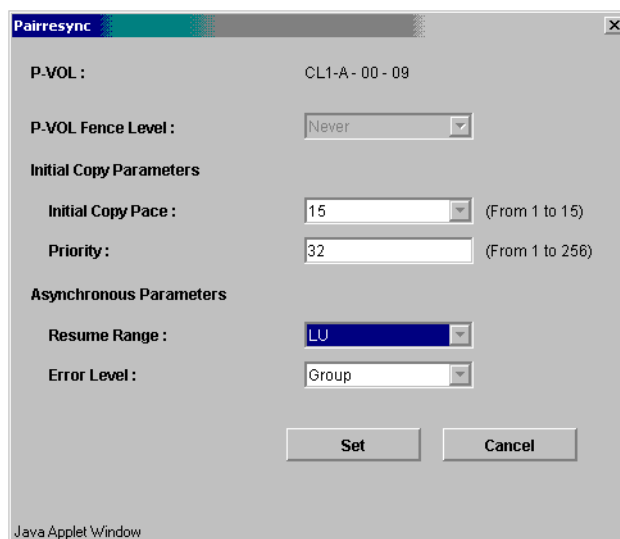
If the RCU accepts write I/Os for a split S-VOL (S-VOL write enable), the RCU also keeps track of the S-VOL cylinders that are updated. When the split/suspended pair is resumed, the MCU merges the P-VOL and S-VOL cylinder bitmaps to determine the out-of-sync cylinders.

Use the **Pairresync** command to resume split/suspended CA pairs. When the **Pairresync** command is selected, the Pairresync window is displayed. Use the Pairresync window to change the pair options and select the resync range option (asynchronous) for the selected pair(s).

---

**Note:** Resyncing of the suspended LDEV pairs within a CA LUSE pair is not supported.

---



**Figure 280: Pairresync window**

- **P-VOL Fence Level:** Select the fence level. **Never:** Never fence the operation, **Data:** Fence when the MCU cannot successfully execute an update copy operation for any reason, **Status:** Fences only if the MCU is not able to change the S-VOL status to the same status as the P-VOL. For synchronous mode only. When the asynchronous pair(s) is being created, **Never** is set automatically.
- **Initial Copy Parameters:**
  - **Initial Copy Pace (From 1 to 15):** Select the number of the tracks 1-15 for resume copy. The default setting is 15.
  - **Priority (From 1 to 256):** Set the priority (1-256) for the resync operation, which determines the order in which the resync operations will be performed.
- **Asynchronous Parameters:**
  - **Resume Range:** When **Group** is selected, resync all split or suspended CA Async pairs in the same group as the selected pair. When **LU** is selected, resync only the selected CA Async pair(s).
  - **Error Level:** The **Error Level** option specifies the error level for the CA Async pair(s): Group or LU. This option is available only when **LU** is selected for the Resume Range.

For more information about the option parameters, see [CA Initial Copy and Pair Options of the Paircreate Window](#) on page 691.

---

**Note:** If an MCU/RCU is powered off and its backup batteries are fully discharged while CA pairs are suspended, the P-VOL/S-VOL cylinder bitmaps will not be retained. In this unlikely case, the MCU/RCU will mark all cylinders of all split or suspended CA volumes as modified, so that the MCU will perform the equivalent of an entire initial copy operation when the pairs are resynced.

---

#### **To resync one or more split or suspended CA volume pairs:**

1. If any pair was suspended due to an error condition (use the Pairdisplay window to view the suspend type), make sure that the error condition has been removed (see [CA Error Codes](#) on page 722 for troubleshooting instructions). The MCU will not resync the pair(s) until the error condition has been removed.
2. Connect to the MCU of the pair(s) to be resynced, and start CA.

3. From the CU number/Port Number tree on the CA main screen, click the number of the correct CU image.
4. If you are resyncing split or suspended LUs, click the pair(s) on the **Volume** list on the CA main screen. Select PSUS or PSUE pairs (not both). Select either Sync or Async pairs (not both). If you plan to use the **Resume Range** option, select only one CA Async pair in the group.

---

**Note:** Resyncing of the suspended LDEV pairs within a CA LUSE pair is not supported.

---

5. Right-click to display the pop-up menu, and click **Pairresync**. The Pairresync window is displayed.
6. From the Pairresync window, click the pair options, and click **Set** to close the Pairresync window and set the parameters. The list changes to the Pair Settings Parameter list (Pairresync). Make sure that all resync options and pair options for each pair are correct.

---

**Note:** After being set, the options can be modified and/or canceled (see [Modifying Parameters and Deleting LUs](#) on page 683).

If you want to resync all split/suspended CA Async pairs in a consistency group, make sure that the **Resume range** option on the Pairresync window is set to **Group**.

---

7. If you want to execute the pairresync requests quickly, select the **Use Time-Saving Mode** check box above the Pair Settings Parameter list (Pairresync) view.
8. Click **Apply** on the CA main screen to resync the specified pair(s).
9. From the CA main screen, verify that the CA pair(s) is/are displayed correctly (**COPY** or **PAIR** status) in the Volume list.



**Caution:** If a timeout error occurs when the **Use Time-Saving Mode** option is selected, confirm on the CA main screen for which volumes the pairresync operation could not be performed. Deselect the **Use Time-Saving Mode** option for the failed volumes, and retry the pairresync operation.

---

When the Pairresync window is closed, the list changes to the Pair Settings Parameter list (Pairresync).



Port	Group	LUN	S/N	SSID	Priority	Pace
CL2-A	0F	04	62492	0023	032	15

Fence	ErrLvl	Range	Error Code
Never	Group	Group	

**Figure 281: Pair Settings Parameter list (Pairresync)**

The Pair Settings Parameter list (Pairresync) view displays the following information for the selected pair(s):

- **Port, Group, and LUN** of the selected LU.
- **S/N and SSID** of the RCU (MCU if you are connected to the RCU).
- **Priority**: Initial copy priority (blank after initial copy operation is complete).
- **Pace**: Number of the tracks 1-15 for the copy.
- **Fence**: Fence level. **Never**: Never fence the operation, **Data**: Fence when the MCU cannot successfully execute an update copy operation for any reason, **Status**: Fences only if the MCU is not able to change the S-VOL status to the same status as the P-VOL. For synchronous mode only.
- **ErrLvl**: The error level of the pair (**Group** or **LU**) (Async LUs only).
- **Range: Group**: Resync all split or suspended CA Async pairs in the same group as the selected pair. **LU**: Resync only the selected CA Async pair(s).

## Deleting CA Volume Pairs (Pairsplit-S)

A CA pair should be deleted from the MCU only when it is no longer necessary to maintain a remote copy of the P-VOL. When a CA pair is deleted from the MCU, the MCU stops all CA copy operations for that pair and changes the pair status of the P-VOL and S-VOL to SMPL. After a CA pair is deleted, the MCU continues to accept all subsequent write I/O operations to the P-VOL and will not keep track of the P-VOL updates.

A CA pair should be deleted from the RCU only for disaster recovery (see [CA Disaster Recovery Operations](#) on page 712). When a CA pair is deleted from the RCU, the RCU changes the S-VOL pair status to SMPL but does not change the pair status of the corresponding P-VOL. When the MCU performs the next CA operation, the MCU detects that the S-VOL status has changed and changes the P-VOL status to **PSUS-pairsplit-S to RCU**. To restart a pair that was deleted

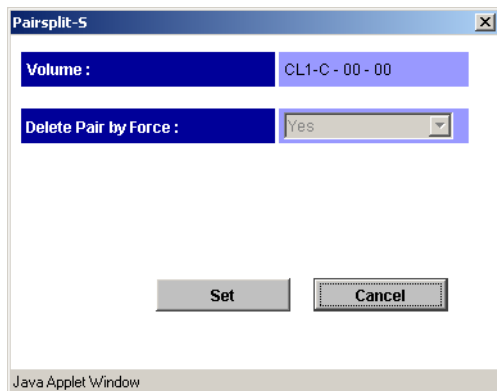
from the RCU, you must first delete the pair from the MCU, and then create the pair from the MCU using the appropriate initial copy option (**Entire** or **No Copy**) to restart the pair.

If you want to delete all CA Async pairs in a consistency group, delete the pairs from the MCU. The CA pair status will change to **Deleting** when the pairsplit-S operation is accepted by the MCU and RCU, and then to **SMPL** after the internal pairsplit-S process is complete. If you want to delete CA Async pairs according to their consistency status (for example, for disaster recovery), you must delete the pairs from the RCU.



**Caution:** When you delete a CA pair from the RCU, remember that the S-VOL and P-VOL are identical (for example, same volume label), and take appropriate precautions to prevent a system problem due to duplicate volumes.

Use the **Pairsplit-S** command to delete one or more CA pairs. When the **Pairsplit-S** command is selected, the Pairsplit-S window is displayed. Use the Pairsplit-S window to change the Pairsplit-S options (by force, and CA Async delete range) for the pair(s) selected on the Volume list on the CA main screen.



**Figure 282: Pairsplit-S window**

- **Volume:** Displays Port - Group - LUN of the selected volume.
- **Delete Pair by Force:** Select the restriction on deleting a CA volume pair.

- **Yes:** The pair(s) will be deleted even if the MCU is unable to communicate with the RCU. This option may be used to free a host waiting for device-end from an MCU that cannot communicate with its RCU, thus allowing host operations to continue.
- **No:** The pair(s) will only be deleted if the MCU is able to change the pair status of the P-VOL and S-VOL to **SMPL**.

When the status of the pair, which is deleted, is **SMPL** or **Deleting**, the default setting is **Yes** (cannot be changed). When the status of the pair is not **SMPL** or **Deleting**, the default setting is **No**.

- **Asynchronous Parameters: Delete Range:** Select the CA Asynchronous delete range option. This option simplifies disaster recovery operations for CA Async consistency groups at the RCU (secondary (remote) disk array).

The CA delete range options are:

- **Group** (MCU or RCU): The MCU/RCU will delete all CA Async pairs in the same consistency group as the specified pair, regardless of pair status and consistency status.



**Caution:** Do not use this option when deleting pairs at the RCU during disaster recovery. This option is available only when one pair is selected.

---

- **C/T** (RCU only): The RCU will delete all CA Async pairs that have the same consistency time.
- **LU** (MCU or RCU): The MCU/RCU will delete only the specified CA Async pair(s). This option can be used to remove individual volumes from consistency groups.

The default settings are as follows:

- More than one pairs are selected: **LU**.
- One pair is selected and the pair is P-VOL: **Group**.
- One pair is selected and the pair is S-VOL: **C/T**.

---

**Note:** When an asynchronous pair is forcibly deleted, the CA delete range option must be **Group**. Therefore, more than one pair cannot be forcibly deleted.

---

**To delete one or more CA volume pairs:**

1. Connect to the MCU or RCU of the pair(s) to be deleted, and start CA. If you plan to use the CA Async C/T delete range option, you must connect to the RCU.
2. From the CU Number/Port Number tree on the CA main screen, click the number of the correct CU image.
3. From the Volume list, click the CA volume pair(s) that you want to delete. Select either CA Sync or Async pairs, but not both. If you plan to use the CA Async C/T or **Group** delete range option, select only one CA Async pair in the group.
4. Right-click to display the pop-up menu, and click **Pairsplit-S**. The Pairsplit-S window is displayed.
5. From the Pairsplit-S window, click the pairsplit-S options for the selected pair(s), and click **Set** to close the Pairsplit-S window and set the parameters. The list changes to the Pair Settings Parameter list (Pairsplit-S). Repeat this step as needed to set the pairsplit-S options for the pair(s).

---

**Note:** After being set, the options can be modified and/or canceled (see [Modifying Parameters and Deleting LUs](#) on page 683).

---

6. If you want to execute the pairsplit-S requests quickly, select the **Use Time-Saving Mode** check box above the Pair Settings Parameter list (Pairsplit-S) view.
7. Click **Apply** on the CA main screen to delete the specified pair(s).
8. When deleting CA Asynchronous pairs, verify that the pairsplit-S request was completed successfully by checking the detailed CA pair status information on the Pairedisplay window (should be **SMPL**, not **Deleting** or **Suspended**).  
When deleting CA Sync pairs, verify that the pairsplit-S request was completed successfully by checking the pair status on the **Pair Operation** tab (**SMPL** status).
9. To restart a pair that was deleted from the RCU, first delete the pair from the MCU, and then use the **Paircreate** command with the appropriate CA initial copy option (**Entire** or **No Copy**) to restart the pair.



**Caution:** If a timeout error occurs when the **Use Time-Saving Mode** option is selected, confirm on the CA main screen for which volumes the pairsplit-S operation could not be performed. Deselect the **Use Time-Saving Mode** option for the failed volumes, and retry the pairsplit-S operation.

When the Pairsplit-S window is closed, the list changes to the Pair Settings Parameter list (Pairsplit-S).

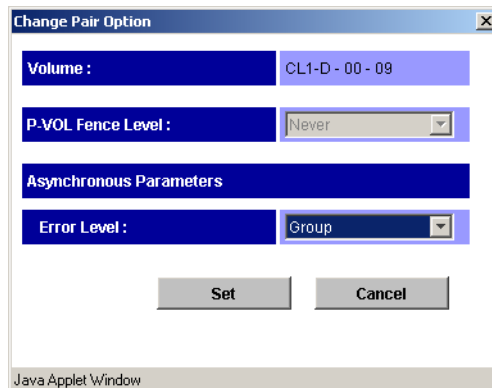
Port	Group	LUN	S/N	SSID	Port	Group	LUN	Mode	Error Code
CL1-C	00	00						Yes	

**Figure 283: Pair Settings Parameter list (Pairsplit-S)**

- **Port, Group, and LUN** of the selected LU number.
- **S/N and SSID** of the RCU (MCU if you are connected to the RCU).
- **Mode:** Yes (delete forcibly) or No (delete normally).
- **Range:** Range for deleting of the asynchronous pair. **Group, LU, or C/T.**

## Changing the Pair Options (Change Pair Option)

Use the **Change Pair Option** command to change the pair options, **Fence level** and **Error level** (asynchronous pairs only). When the **Change Pair Option** command is selected, the Change Pair Option window is displayed. From the Change Pair Option window, the pair options can be changed.



**Figure 284: Change Pair Option window**

- **P-VOL Fence level:** Select the fence level that is the conditions under which the MCU will reject write operations to the P-VOL. **Never:** Never fence the operation, **Data:** Fence when the MCU cannot successfully execute an update copy operation for any reason, **Status:** Fences only if the MCU is not able to change the S-VOL status to the same status as the P-VOL. This option is only for the synchronous mode. When the asynchronous pair(s) is being created, **Never** is set automatically.
- **Asynchronous Parameters:**
  - Error level:** Error level. **Group** or **LU.** When a failure occurs, the pairs in the same group or in an LU is/are suspended

**To change the pair options for one or more CA volume pairs:**

1. Connect to the MCU or RCU of the pair(s) to be changed the options, and start CA.
2. From the CU Number/Port Number tree on the CA main screen, click the number of the correct CU image.
3. From the Volume list, click the CA volume pair(s) that you want to modify the options. Select either CA Sync or Async pairs, but not both.
4. Right-click to display the pop-up menu, and click **Change Pair Option.** The Change Pair Option window is displayed.
5. From the Change Pair Option window, click the pair options for the selected pair(s), and click **Set** to close the Change Pair Option window and set the parameters. The list changes to the Pair Settings Parameter list (Change Pair Option). Repeat this step as needed to change the pair options for the pair(s).

---

**Note:** After being set, the options can be modified and/or canceled (see [Modifying Parameters and Deleting LUs](#) on page 683).

---

6. If you want to execute the pair option change requests quickly, select the **Use Time-Saving Model** check box above the Pair Settings Parameter list (Change Pair Option).
7. Click **Apply** on the CA main screen to change the options for the specified pair(s).
8. From the CA main screen, verify that the pair option change was completed successfully.

When the Pair Option window is closed, the list changes to the Pair Settings Parameter list (Pair Option).

Port	Group	LUN	S/N	SSID	Fence	ErrLvl	Error Code
<i>CL1-D</i>	<i>00</i>	<i>09</i>	<i>20030</i>	<i>0005</i>	<i>Never</i>	<i>Group</i>	

**Figure 285: Pair Settings Parameter list (Pair Option)**

- **Port, Group, and LUN** of the selected LU number.
- **S/N and SSID** of the RCU (MCU if you are connected to the RCU).
- **Fence:** Fence level. **Never:** Never fence the operation, **Data:** Fence when the MCU cannot successfully execute an update copy operation for any reason, **Status:** Fences only if the MCU is not able to change the S-VOL status to the same status as the P-VOL. For synchronous mode only.
- **ErrLvl:** The error level of the pair (**Group** or **LU**) (Async LUs only).

## Using CA for Data Migration and Duplication

### Data Migration Using CA Synchronous

CA Synchronous can be used for device or workload migration with minimal impact to host applications. You may need to migrate data from one volume to another for any of the following reasons:

- To load data onto new or scratch volumes (for example, new or upgraded disk array),
- To temporarily move data off a volume to accommodate other activities (for example, repair), or
- To relocate volumes to balance workloads and distribute I/O activity evenly within and across disk arrays for the purpose of improving disk array and system performance.

The CA initial copy operation copies the entire contents of the P-VOL to the S-VOL. The P-VOL and S-VOL are identical and synchronized when the initial copy operation completes and the pair status changes from COPY to PAIR. The CA pair is then deleted to change the state of the devices to SMPL, and host high-availability (HA) software can then be used to complete the data migration nondisruptively. To support host-based application automation, data migration using CA must be managed by integrating the Raid Manager software with CA operations and the host HA software functions.

**Note:** If you need to migrate data from other vendors' storage disk arrays onto the disk array, please contact your HP account team.

---

**To use CA Synchronous to migrate data from one volume to another:**

1. Vary the S-VOL(s) offline from all attached hosts. The S-VOLs are the target volumes onto which you are migrating the data. The P-VOLs (source volumes) can remain online.
2. Connect to the disk array containing the volume(s) to be migrated, and then start CA. If not already done, install the remote copy connections and configure the ports (initiator ports for fibre, RCPs for serial), if migrating between disk arrays, and then register the RCUs.
3. On the CA main screen, click the CU image and the LU(s) to be migrated, and start the CA Sync pair(s) by going to the CA main screen and using the **Paircreate** command (see [Creating CA Volume Pairs \(Paircreate\)](#) on page 686).
4. Monitor the progress of the initial copy operation(s) and the status of the pair(s) on the **Pair Operation** tab of the CA main screen. Refresh the tab as needed. When the status has changed from COPY to PAIR, the P-VOL and S-VOL are identical and synchronized.
5. If you are not using Raid Manager commands and host software to complete the migration, use the following procedure to stop using the P-VOL(s) and switch to the S-VOL(s):
  - a. Stop all host updates to the P-VOL(s).
  - b. When all update activity to the P-VOL(s) has stopped, connect to the MCU, click the correct CU image, and delete the CA volume pair(s) (see [Deleting CA Volume Pairs \(Pairsplit-S\)](#) on page 701).
  - c. If the P-VOL(s) and S-VOL(s) are attached to the same host, vary the P-VOL(s) offline first, and then vary the S-VOL(s) online. The P-VOL(s) and S-VOL(s) have the same volume labels and cannot be online to the same host(s) at the same time.
  - d. If you want to keep the volumes synchronized, establish the same CA pair(s) in the reverse direction using the **No Copy** initial copy option (see [CA Initial Copy and Pair Options of the Paircreate Window](#) on page 691). If the original P-VOL(s) will be temporarily unavailable for update copy operations, you can split the new pair(s) (pairsplit-r) so that the new MCU keeps track of changes.



- e. Start the applications with the S-VOL(s). When the original P-VOL(s) become available, you can resume the pair(s) using the Pair List (Pairresync) window (see [Resuming CA Volume Pairs \(Pairresync\)](#) on page 697).

## Point-in-Time Data Duplication Using CA Asynchronous

Use CA Asynchronous (CA Async) to make Point-in-Time (PiT) duplicates of groups of volumes. The CA Async **Group** and **Drain** pairsplit-r options can be used together to create a PiT copy, relative to an application, of an entire CA Async consistency group of volumes.

### To produce a PiT duplicate of an existing CA Async consistency group:

1. Stop all host updates to all CA Async P-VOLs in the group.
2. After all P-VOL updates have completed, split the CA Async group using the **Group** and **Drain** pairsplit-r options. If you are splitting the group at the main site, issue the pairsplit-r/group command to one P-VOL in the MCU. If you are splitting the group at the remote site, issue the pairsplit-r/group command to one S-VOL in the RCU.

The copy pending timeout setting for the group determines the maximum amount of time that the pairsplit-r/drain operation can take (see description of **Drain** above).

3. When the status of all CA Async pairs in the group has changed to **PSUS**, the duplicate set of volumes is complete. If needed, you can restart the application at the main site.

## Powering Off/On CA Components

The user is responsible for controlling power-off activities for disk arrays involved in CA operations. If you need to power off the disk array, please call your HP representative or HP technical support for assistance. The following sections provide instructions for performing planned outages of CA components.

If power is removed from an MCU while CA operations are in progress, the CA pairs are not affected, but the update sequence consistency of the CA Async groups at the RCU may be affected (see [Planned Outage of the MCU](#) on page 710 for further information). When power is restored to an MCU, the MCU communicates with its RCU(s) to confirm the pair status of the S-VOLs. Make sure that CA communications are fully restored (all paths have normal status) before beginning I/O operations to the P-VOLs. If the MCU accepts a write I/O

operation for a P-VOL before this confirmation is complete, the MCU will suspend the pair and change the status of the P-VOL to *suspended-by RCU* (the MCU will not be able to change the pair status of the S-VOL).

If power is removed from an RCU or remote copy connection while CA operations are in progress, the MCU(s) will detect the communication failure, suspend all affected pairs, and generate SIMs reporting the failures. The MCU will change the status of the P-VOLs to *suspended-by RCU* but will not be able to change the status of the S-VOLs.

If an MCU/RCU is powered off and its backup batteries are fully discharged while CA pairs are suspended, the P-VOL/S-VOL cylinder maps will not be retained. In this unlikely case, the MCU/RCU will mark all cylinders of all suspended CA volumes as modified, so that the MCU will perform the equivalent of an entire initial copy operation when the pairs are resumed. (The S-VOL cylinder map is used for CA Async operations and for the CA S-VOL write enable option.)

## Planned Outage of the MCU

A planned MCU outage does not affect CA Synchronous. For CA Asynchronous operations, the MCU must communicate with the RCU even when there are no P-VOL update I/Os from the primary system. During the power-off sequence, the MCU will automatically suspend all CA Async pairs in the PAIR and COPY states (suspend type = MCU P/S-OFF). During power-on-reset sequence, the MCU will automatically resume these suspended pairs (pairs with other suspend types are not automatically resumed).

## Planned Outage of the RCU or Remote Copy Connection

You must split all affected CA pairs prior to a planned outage of an RCU or of a remote copy connection component (for example, Fibre Channel switches). If you do not split the pairs first, the MCU(s) will detect the communication failure, suspend all affected pairs, and generate SIMs reporting the failures.

### **To perform a planned outage of a CA RCU or remote copy connection component:**

1. Identify all CA P-VOLs that will be affected by the equipment outage. You need to know the MCU, CU image, and ID (port, GID, LUN) for each of these P-VOLs.
  - a. For RCU power-off, identify all P-VOLs that are paired with S-VOLs in the RCU to be powered off.
  - b. For remote copy connection outage, identify all P-VOLs in all MCUs that use the path/component to be powered off.

2. Connect to each MCU that contains affected P-VOLs, and split all affected CA pairs. Make sure to confirm the pair status changes (the **Pair Operation** tab or the Pairdisplay window).
3. Perform the planned outage of the RCU or remote copy connection.
4. When the RCU is fully powered on and ready to resume operations, resume (pairresync) all CA pairs at each MCU. Make sure to confirm the pair status changes.

## Planned Outage of the MCU and RCU

When you plan an outage of CA MCUs and RCUs at the same time, the MCUs must be powered off before the RCUs and powered on after the RCUs.

### To perform a planned outage of a CA MCU and RCU:

1. If RCU power-on will be difficult to control (for example, Power-Control-Interface setting), you should consider increasing or disabling the **RCU ready timeout** group option (see [Group Options](#) on page 586) for each CA Async group with S-VOLs in the RCU(s) to be powered off.
2. Perform the planned outage of the MCU(s) as described in [Planned Outage of the MCU](#) on page 710. Do not power-on the MCU(s) yet.
3. If an RCU to be powered off is connected to an MCU that is not powered off, make sure to split those CA pairs before powering off the RCU.
4. Perform the planned outage of the RCU(s) as described in [Planned Outage of the RCU or Remote Copy Connection](#) on page 710.
5. Power on the RCU(s). Make sure that they are fully operational and ready to resume operations before powering on the MCUs.
6. Power on the MCU(s), and make sure that they are ready to resume operations. If you split any pairs in [step 3](#), you can also resume (pairresync) those pairs now.

## CA Disaster Recovery Operations

### Preparing for Disaster Recovery

The type of disaster and the status of the CA volume pairs will determine the best approach for disaster recovery. For example, if all CA volume pairs are in the **PAIR** state when a total system failure occurs at a single point in time, the S-VOLs are current and recovery is straightforward. Unfortunately, some disasters are not so “orderly” and involve intermittent or gradual failures occurring over a longer period of time. The user should anticipate and plan for all types of failures and disasters.

The major steps in preparing for disaster recovery are:

1. Identify the volumes and volume groups that contain important files and data for disaster recovery. In addition to supporting CA remote copy operations as well as Raid Manager commands, the disk array provides battery-backed nonvolatile duplexed cache, full hardware redundancy, dynamic sparing, and an advanced RAID-5 implementation to ensure full data integrity in the event of a sudden power outage or other failure.
2. Install the Command View management station and CA, and establish CA operations for the volumes and groups identified in [step 1](#). Make sure to select the proper CU images to access the volumes. Refer to [Preparing for CA Operations](#) on page 598 for CA installation instructions. Refer to [Performing CA Configuration Operations](#) on page 635 for instructions on performing CA configuration operations. Refer to [Performing CA Pair Operations](#) on page 680 for instructions on performing CA pair operations.
3. Use the appropriate combination of CA options for disaster recovery:
  - CA Async **offloading timer** option (see [Asynchronous Copy Option](#) on page 668) and **copy pending timeout** group option (see [Modifying Consistency Group Options \(CT Group Option\)](#) on page 665). The copy pending timeout group option can be used to limit the time duration during which updates may be lost.

---

**Note:** When channel-extenders are used for CA Async, the offloading timer should be set to 35 seconds or less to avoid affecting host I/O performance.

---

- CA Async **Error Level** pair option, and CA Synchronous **P-VOL Fence Level** pair option (see [Creating CA Volume Pairs \(Paircreate\)](#) on page 686).
4. Establish file and database recovery procedures. These procedures should already be established for recovering volumes that become inaccessible due to control unit failure.
  5. Make sure that the host system at the primary site is configured to receive sense information from the MCUs (via Raid Manager or SNMP).
  6. Install and configure host failover software between the main and remote sites. Host failover capability is essential if you use the P-VOL fence level setting of **S-VOL Status** or **Never** for any CA volume pairs.

## Considering the P-VOL Fence-Level Setting

The P-VOL fence level setting (see [Creating CA Volume Pairs \(Paircreate\)](#) on page 686) for each CA Synchronous volume pair determines whether the P-VOL will be fenced when CA remote copy operations fail. The following table summarizes the effect of the fence level setting on a CA Sync P-VOL.

---

**Note:** The P-VOL fence level setting does not apply to CA Asynchronous pairs. CA Async P-VOLs are never fenced due to suspension of the pair.

---

**Table 77: Fence level settings on a CA Sync P-VOL**

Type of Failure		Fence Level Setting		
		S-VOL Data	S-VOL Status	Never
The update copy operation failed, and the MCU was able to change the status of the S-VOL to PSUE.	Write I/O operations to the P-VOL will be:	REJECTED	Accepted	Accepted
The update copy operation failed, and the MCU was NOT able to change the status of the S-VOL to PSUE.	Write I/O operations to the P-VOL will be:	REJECTED	REJECTED	Accepted

**Data.** When **S-VOL Data** is selected, the P-VOL will be fenced if an update copy operation fails. This P-VOL fence level setting ensures that the S-VOL remains identical to the P-VOL after the CA volume pair is synchronized, but makes the

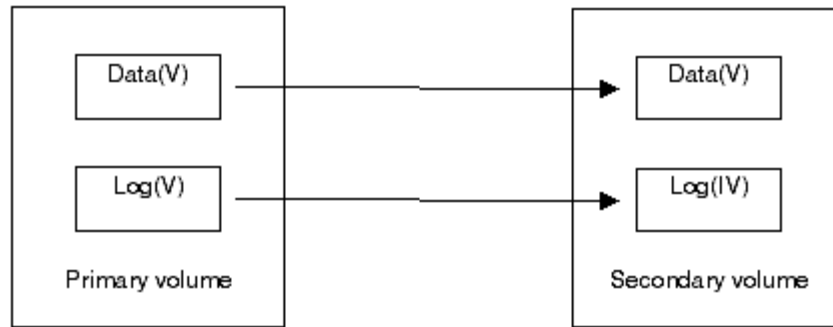
P-VOL inaccessible for updates whenever CA remote copy operations fail. This setting should be considered for the most critical volumes for disaster recovery. This setting will reduce the amount of time required to analyze the currency of the S-VOL during disaster recovery efforts. This setting is also designed for applications that can continue to operate with another device pair.

**Status.** When **S-VOL Status** is selected, the P-VOL is fenced only if the MCU is not able to change the S-VOL pair status to **PSUE**. If the MCU successfully changes the S-VOL pair status to **PSUE**, subsequent write I/O operations to the P-VOL will be accepted, and the MCU will keep track of updates to the P-VOL. This allows the volume pair to be resumed quickly using the pairresync operation (out-of-sync-cylinders only). This setting will also reduce the amount of time required to analyze the S-VOL currency during disaster recovery.

**Never.** When **Never** is selected, the P-VOL is never fenced when the pair is suspended. This P-VOL fence level setting ensures that the P-VOL remains available to applications for updates, even if all CA copy operations have failed. The S-VOL may no longer be in sync with the P-VOL, but the MCU will keep track of updates to the P-VOL while the pair is suspended. Host failover capability is essential if this fence level setting is used. For disaster recovery, the currency of the S-VOL is determined by using the sense information transferred via host failover or by comparing the S-VOL contents with other files confirmed to be current.

## Setting the Fence Level

When a take-over by the S-VOL occurs as shown in the following figure (two errors have already occurred), Data (V) remains in the rollback process at the secondary host, and full recovery cannot be performed. To avoid this situation, you can define the fence level of the Redo log file as **Data**, so that the P-VOL returns an error if a data disagreement is expected to occur concerning a write request issued from the host. The **Data** fence-level setting maintains full consistency between the Redo log file and the data file because no data is written to the data file due to the write error at the log file. However, when the fence level is defined as **Data**, a write I/O causes an error even when processing has been suspended due to an error at the S-VOL. In this case, a take-over by the S-VOL occurs, and the significance of the duplex system will be lost. Therefore, if you define the fence level as **Data**, applications must be able to cope with write I/O errors by handling them. Systems that allow disk errors by means of multiplication can function with the **Data** fence-level setting. For example, Oracle multiplies the Redo log file by itself (default = three times).



**Figure 286: Relationship between log file and data file in PAIR status**

Because most UNIX file systems (excluding JFS and VxFS) have no journal files, the P-VOL fence level should be defined as **Never**. When a take-over by the S-VOL occurs, **fsck** is executed on the volume and the file system is cleaned up, even if the S-VOL is undefined at the secondary host. The data that will be lost depends on how much differential data is contained in the P-VOL when the S-VOL is suspended. During operation, error recovery should be performed when the suspended status (PSUE) is detected (when one error occurs).

## Transferring Sense Information Between Sites

When the MCU (or RCU for CA Async) suspends a CA pair due to an error condition, the MCU/RCU sends sense information with unit check status to the appropriate host(s). This sense information is used during disaster recovery to determine the currency of the S-VOL, and must be transferred to the remote site via the host failover software.

## File and Database Recovery Procedures

When a CA Synchronous pair is suspended, or when the MCU fails due to a disaster, the S-VOL may contain in-process data. A data set could be open, or transactions may not have completed. Even if you use the **S-VOL Data** fence level for all CA Sync pairs, you need to establish file recovery procedures. These procedures should be the same as those used for recovering any volume that becomes inaccessible due to control unit failure. These procedures are more important if the **S-VOL Status** or **Never** fence level settings are used.

CA Asynchronous does not provide any procedure for detecting and retrieving lost updates. To detect and recreate lost updates, you must check other current information (for example, database journal log file that was active at the primary system when the disaster occurred). The CA Async group consistency time (C/T)

(MCU disk array service processor time) can be useful when performing this detection and retrieval. Because this detection/retrieval process can take a while, your disaster recovery scenario should be designed so that detection/retrieval of lost updates is performed after the application has been started at the secondary system.

You should prepare for file and database recovery by using:

- Files for file recovery (such as database log files that have been verified as current). To ensure the currency of these files, use the **S-VOL Data** fence level setting for the CA pairs that contain these important files.
- The sense information with local time-stamp that will be transferred via host failover.

---

**Note:** Remote copy and disaster recovery procedures are inherently complex. Consult your HP account team on sense-level settings and recovery procedures.

---

Please remember that the CA Async time-stamp and C/T information indicates MCU service processor (SVP) time, not host system time.

See [Pinned Track Recovery for CA Volumes](#) on page 723 for information on recovering a pinned track on a CA volume.

## Switching Operations to the Remote Site

If a disaster or failure occurs at the primary site, the first disaster recovery activity is to switch your operations to the secondary site. The CA Synchronous S-VOLs are recovered individually based on the pair status and P-VOL fence level information for each pair. The CA Async S-VOLs are recovered based on pair status and consistency status (at the RCU).

The basic procedures for switching operations to the remote backup site are:

1. Analyze the currency of the CA Synchronous S-VOLs (see [Analyzing the Currency of CA Synchronous S-VOLs](#) on page 717) and the consistency of the CA Asynchronous S-VOLs (see [Analyzing the Consistency of CA Asynchronous S-VOLs](#) on page 718).
2. Record the consistency time (C/T) of each CA Async group. The suspended CA Async S-VOLs with consistency status of *group* will indicate the same C/T. The consistency status and consistency time are displayed only at the RCU.



Remember that the CA Async time-stamp and C/T information indicates MCU service processor time, not host system time.

3. Perform file recovery as needed (see [File and Database Recovery Procedures](#) on page 715). The C/T of each CA Async group can be used to retrieve lost updates.
4. At the remote site, connect to each RCU, and delete all CA Synchronous pairs. For CA Asynchronous pairs, delete all consistent pairs in a group at the same time using the pairsplit-S command with the C/T delete range option. This option prevents you from accidentally using inconsistent pairs for disaster recovery.



**Caution:** After an S-VOL changes to simplex, you cannot distinguish it from a non-CA simplex volume. The CA Async C/T is also discarded when the pair is deleted.

---

5. If necessary, use the logical volume manager to change the volume labels of the S-VOLs.
6. Make sure that all required file recovery procedures have been completed before varying the S-VOLs online.
7. At this point you may start critical applications at the remote site with the previous S-VOLs taking the place of their P-VOLs.

## Analyzing the Currency of CA Synchronous S-VOLs

The following table shows how to determine the currency of a CA Synchronous S-VOL based on its pair status and P-VOL fence level setting. For CA Sync pairs with a P-VOL fence level setting of **Never**, further analysis will be required to determine the currency of these S-VOLs. The currency of these S-VOLs can be determined by using the sense information transferred via the host failover, or by comparing the contents of the S-VOL with other files that are confirmed to be current (such as database log files). These S-VOLs should be recovered using the files that are confirmed to be current.

---

**Note:** Actual data recovery must be done using recovery point data in the database redo log.

---

**Table 78: Determining CA Synchronous S-VOL currency based on its pair status and P-VOL fence level setting**

Status of S-VOL	Fence Level	Currency of S-VOL
SMPL	Data Status Never	<b>Inconsistent.</b> This S-VOL does not belong to a CA volume pair. Even if you established a CA pair for this volume, you must regard this volume as inconsistent.)
COPY	Data Status Never	<b>Inconsistent.</b> This S-VOL is not synchronized because not all cylinders have been copied from the P-VOL yet. This S-VOL must be initialized (or copied from the P-VOL at a later time).
PAIR	Data Status	<b>Current.</b> This S-VOL is synchronized with its P-VOL.
	Never	<b>Needs to be analyzed.</b> This S-VOL requires further analysis to determine its level of currency.
PSUE - initial copy failed	Data Status Never	<b>Inconsistent.</b> This S-VOL is not synchronized because not all cylinders have been copied from the P-VOL yet. This S-VOL must be initialized (or copied from the P-VOL at a later time).
PSUS - S-VOL by operator	Data Status Never	<b>Suspect.</b> This S-VOL is not synchronized with its P-VOL if any write I/Os were issued to the P-VOL after the pair was split. This pair should be restarted using the <b>Entire Volume</b> initial copy option, but the <b>None</b> option can be used if you are sure that no data on the P-VOL changed.
PSUS/PSUE - all other types	Data	<b>Current.</b> This S-VOL is synchronized with its P-VOL.
	Status Never	<b>Suspect.</b> This S-VOL is not synchronized with its P-VOL if any write I/Os were issued to the P-VOL after the pair was split or suspended. Restore the consistency of this S-VOL and update it, if required. The time of suspension indicated on the Pairdisplay window will help to determine the last time this S-VOL was updated.

### Analyzing the Consistency of CA Asynchronous S-VOLs

The following table shows how to determine the consistency of a CA Async S-VOL based on its pair status and consistency status. For CA Async S-VOLs with a consistency status of **LU**, the volume is not consistent with other volumes in the same group, and further analysis will be required to determine the currency of each of these S-VOLs. The currency of these S-VOLs can be determined by using the sense information transferred via host failover software or by comparing the contents of the S-VOL with other files that are confirmed to be current (such as database log files). These S-VOLs should be recovered using the files that are confirmed to be current.

Remember that the CA Async time-stamp and C/T information indicates MCU service processor time, not host system time.

**Note:** Actual data recovery must be done using recovery point data in the database redo log.

**Table 79: Determining CA Async S-VOL consistency based on its pair status and consistency status**

Status of S-VOL	Usable for Recovery?	Description
PAIR COPY SMPL	No	These states do not usually occur during CA Asynchronous disaster recovery, because the RCU suspends all CA Async S-VOLs when communication with the MCU is lost. CA Async S-VOLs in these states should not be used for disaster recovery.  Simplex volumes cannot be distinguished from S-VOLs that have already been deleted by the pairsplit-S operation.
PSUE-Group	Yes	The update sequence consistency across these S-VOLs is ensured at the point in time indicated by the consistency time. These S-VOLs can be used for disaster recovery at the secondary system.  Updates that were performed at the primary system after the indicated consistency time were probably lost.
PSUE-LU	No	The contents of this S-VOL may be behind the other S-VOLs in the consistency group. If this volume must be consistent with the other volumes in the same group, this S-VOL should not be used for disaster recovery.  The cause for this status is: <ul style="list-style-type: none"> <li>■ The CA Async <b>Error Level</b> pair option for this pair is <b>LU</b> (not <b>Group</b>), AND</li> <li>■ This pair was suspended before the disaster/failure, at the beginning of the rolling disaster, or during the initial copy operation.</li> </ul>

## Transferring Operations Back to the Primary Site

After the applications are running at the secondary (remote) site, the next activity is to restore the primary (main) site and transfer operations back to the primary site.

**To transfer operations to the primary site:**

1. Bring up the host server(s) at the primary site, and make sure that all CA components are fully operational.
2. At the primary site, delete all CA pairs at the MCUs. The **Delete Pair by Force** option must be **Yes** because the previous S-VOLs are in the SMPL state at the secondary site.
3. At the main site, delete all CA Async consistency groups at the MCUs.
4. At the main site, delete the RCUs. Remember to connect with each MCU and each CU image to make sure that all RCUs have been deleted.
5. At the main site, configure the MCU ports as needed. If you plan to use the same remote copy connections to copy back, change the existing RCPs to LCPs, or change the existing initiator ports to ordinary target ports.
6. If you plan to use the same channel extenders, change the operating mode to the opposite direction. The boxes/nodes connected to the MCUs must be set to channel-mode, and the boxes/nodes connected to the RCUs must be set to device-mode.
7. At the remote site, configure the appropriate ports to enable CA operations in the reverse direction (change target ports to initiator ports for fibre, change LCPs to RCPs for serial). This enables the original RCUs to send CA remote copy operations to the original MCUs to bring the original P-VOLs up to date.
8. At the remote site, establish the same CA Async groups and CA pairs in the reverse direction to synchronize the original P-VOLs with the S-VOLs. From the Paircreate parameter window, make sure to select **Entire Volume** for the **Initial Copy** field for the **Initial copy parameters** option.

## Resuming Normal Operations at the Primary Site

After the CA pairs have been established in the reverse direction, you are ready to resume normal operations at the primary (main) site. Remember that the CA terminology is now reversed: the original RCUs and S-VOLs (secondary site) are now the MCUs and P-VOLs, and the original MCUs and P-VOLs (primary site) are now the RCUs and S-VOLs.

**To resume normal operations at the primary site:**

1. At the secondary site, make sure that all CA pairs are in the PAIR (duplex) state. This indicates that the CA initial copy operations are complete.

2. Halt the applications at the remote site, and vary the P-VOLs (original S-VOLs) offline at the remote site. This maintains synchronization of the CA Sync pairs.
3. Split (pairsplit-r) all CA pairs at the MCUs (original RCUs) to destage any pending data from cache. Confirm that the pairs are split (PSUS) before proceeding. If an error occurs, resolve it before proceeding.
4. Delete all CA pairs at the MCUs (original RCUs). You do not need to use the **Delete Pair by Force** option. For CA Async pairs, the MCU and RCU complete all pending updates before changing the pair status to SMPL.
5. Change the CA settings at the MCUs (original RCUs) to prepare for normal CA operations. Delete the CA Async groups and the RCUs (original MCUs). If you plan to use the same remote copy connections, reconfigure the ports (change initiator ports back to ordinary target ports for fibre).
6. If you plan to use the same channel extenders, change the operating mode back to the original direction. The boxes/nodes connected to the MCUs must be set to channel-mode, and the boxes/nodes connected to the RCUs must be set to device-mode.
7. At the primary site, configure the RCPs or initiator ports, add the RCUs, and add the CA Async groups.
8. At the primary site, establish all CA groups and pairs in the original direction. You may use the **None** initial copy option because all P-VOLs and S-VOLs are synchronized. If there is any possibility that the volumes are not 100% synchronized, select **Entire Volume** for the **Initial Copy** field for the **Initial copy parameters** option to be safe.
9. Vary the MCU and P-VOLs online, and start the applications at the primary site.

## Error Codes and Messages

### CA Error Codes

CA displays error messages on the Command View management station when error conditions occur during CA operations. The error message describes the error. The error message may also include an SVP error code. If you need to call HP technical support for assistance, please report the CA and SVP error codes.

### Service Information Messages (SIMs)

The disk array generates a SIM when it is necessary to notify the user of a possible service requirement for the disk array. SIMs can be generated by the channel and storage path microprocessors of the disk array and by the service processor (SVP) of the disk array. The SVP reports all SIMs related to CA operations. Each time a SIM is generated, the amber **Message** LED on the disk array's front operator's window (under the **Ready** and **Alarm** LEDs) turns on as an additional alert for the user.

The SIMs are classified according to severity for reporting and logging purposes: service, moderate, serious, or acute. All SIMs are logged on the SVP and reported to Command View (**Device Health** tab). During CA operations, the MCU and RCU generate a service SIM each time the pair status of the P-VOL or S-VOL changes for any reason, including normal status transitions (for example, COPY to PAIR). SIMs generated by the MCU will include the P-VOL device ID (byte 13), and SIMs generated by the RCU will include the S-VOL device ID (byte 13).

If SIM will result in an SNMP trap being sent to the appropriate hosts.

## Pinned Track Recovery for CA Volumes

If a pinned track occurs on a CA P-VOL or S-VOL, the MCU will suspend the pair (SIM reference code = DB1x).

**To ensure full data integrity of the volume pair while recovering the pinned track:**

1. Connect to the MCU of the suspended pair, and select the correct CU image.
2. Delete the CA pair (pairsplit-S) which contains the volume with the pinned track.
3. If the volume is offline (for example, S-VOL has pinned track), vary the volume online.
4. Perform your usual procedure for recovering data from a pinned track. Refer to the pinned track recovery procedures for your operating system, or contact your HP representative for assistance in recovering the pinned track.
5. If the volume was previously offline (for example, S-VOL), make sure to vary the volume offline again.
6. Restart the volume pair using the **Paircreate** command from the **Pair Operation** tab of the CA main screen. From the Paircreate Parameter window, make sure to select **Entire** for the **Method** field of the **Initial copy parameter** (see [Creating CA Volume Pairs \(Paircreate\)](#) on page 686).





# TrueCopy for the XP128/XP1024 (Mainframe)

22

TrueCopy (TC390) creates and maintains remote copies of the S/390 data stored on the XP128/XP1024 for data duplication, backup, and disaster recovery purposes. TC390 provides synchronous and asynchronous copy modes to accommodate a wide variety of user requirements and data copy/movement scenarios. TrueCopy Asynchronous (TC390A) provides a superior hardware-based solution for data duplication, data migration, remote copy, and disaster recovery tasks.

---

**Note:** In this chapter, the term “TC390” refers to both TrueCopy Synchronous and TrueCopy Asynchronous unless otherwise noted.

---

TC390 operations are nondisruptive, allowing the main (primary) volume of each TC390 pair to remain online to all hosts for both read and write I/O operations. After operations have been established, TC390 operations continue unattended to provide continuous data backup. For serial interface connection, TC390 operations can be performed across distances of up to 43 km (26.7 miles) using standard ESCON support. For Fibre Channel connection, TC390 operations can be performed across distances of up to 30 km (18.6 miles) using single-mode longwave optical fibre cables in a switch configuration. Long-distance solutions are provided, based on user requirements and workload characteristics, using approved channel extenders and communication lines. TC390 is a key component of HP’s solutions and service offerings.

After hardware connectivity between XP128/XP1024 (or between XP128/XP1024 and other XP disk arrays) is established, TC390 operations can be performed from Command View and/or from the S/390 system software for maximum usability:

- TC390 running under Command View displays detailed TC390 information and performs all TC390 operations. In the event of a system failure or disaster at the main site, the TC390 software also simplifies and expedites disaster

recovery procedures. For operating systems that do not support Peer-to-Peer Remote Copy (PPRC) or ICKDSF PPRCOPY commands, TC390 operations are performed using Command View.

- TC390 is functionally compatible with industry-standard IBM Peer-to-Peer Remote Copy (PPRC) host software functions. PPRC TSO commands (or ICKDSF PPRCOPY commands) combined with disaster recovery PTFs may be used to perform TC390 and disaster recovery operations on XP128/XP1024. TC390 supports the PPRC/Dynamic Address Switching (P/DAS) host software function so you can use TC390 to relocate volumes nondisruptively. TC390 also supports the PPRC CGROUP TSO command, which is used with IBM's Geographically Dispersed Parallel Sysplex (GDPS) service offering.

TC390 can be performed in conjunction with ShadowImage (SI390) (see [Other Data Duplication Features](#) on page 726) to provide multiple internal copies of TC390 volumes. TC390 also supports the Virtual LVI/LUN and Cache LUN XP features of the XP128/XP1024, ensuring that all S/390 user data can be protected by TC390 remote copy operations. For more information on combining TC390 with other data management features, see [Combining TrueCopy with Other Data Management Operations](#) on page 791.

## Other Data Duplication Features

In addition to TC390, the XP128/XP1024 provides several other data duplication features that are described below. For more information about these features, contact your HP account team.

### Business Copy XP and ShadowImage

You can use the Business Copy (BC) XP and SI390 data duplication features to set up and maintain multiple copies of logical volumes within the same XP128/XP1024. BC operations for S/390 data are performed using the SI390 through Command View and can also be managed using the TSO and/or ICKDSF commands. BC operations for UNIX/PC server-based data are performed using the licensed BC software through Command View or the Raid Manager software on the UNIX/PC server host.

The RAID-protected SI390 duplicates are created within the same XP128/XP1024 at hardware speeds. SI390 can be used in conjunction with TC390 to maintain multiple copies of critical data at your primary and/or secondary (remote) sites. For more information on combining TC390 and SI390 operations, see [Combining TrueCopy and ShadowImage](#) on page 793.

## Hitachi Extended Remote Copy

The Hitachi Extended Remote Copy (HXRC) feature of the XP128/XP1024 is functionally compatible with the industry-standard IBM Extended Remote Copy (XRC) host software function and is provided as a program product. HXRC is also compatible with the DFSMS data mover that is common to the XRC environment. HXRC operations are performed in the same manner as XRC operations, by issuing XRC TSO commands from the host system to the XP128/XP1024.

This chapter provides disk array-specific HXRC information (for example, SVP modes), but does not cover XRC operations.

**SVP modes:** For important information on XP128/XP1024 SVP modes for HXRC, refer to [Table 81](#) on page 733.

**16 session support:** The XP128/XP1024 must be configured with 3990-6E emulation (no 3380 LVIs) and 256 LDEVs/SSID for 16 session (per disk array) support. APAR OW36948 must be applied. A disk array power cycle is required when the SSID boundary is changed (64↔256).

**Device blocking, load balancing:** For important information on HXRC device blocking support and load balancing control, refer to [HXRC Device Blocking and Load Balancing](#) on page 1015.

**Changing from 3990 to 2105:** For important information and instructions on changing from 3990 to 2105 emulation for disk arrays with existing HXRC volumes, refer to [CU Emulation Types](#) on page 736.

HXRC operations, as well as TC390A operations, use additional cache to store the sidefile queue of asynchronous recordsets. If you are maintaining HXRC pairs and TC390A pairs, verify that your XP128/XP1024 has adequate cache installed and available to support your asynchronous remote copy workloads. Contact your HP account team to determine how much cache will be needed for your disk array configuration.

---

**Note:** If the **ANTX5123W** console message is displayed during the RESUME operation for HXRC pairs, the operation might be unsuccessful. In this case, you must perform the XDELPAIR operation to delete the pairs, and then perform the XADDPAIR operation to create the pairs again.

---

---

**Note:** If the ANTA5107E (RC=9014, REAS=604, or REAS=608) console message is displayed during the XADDPAIR operation, the HXRC PP option may not have been installed. Verify that the HXRC PP option is installed and if not, install the HXRC PP option.

---



---

**Note:** The HXRC option is only required for the 2105 CU emulation type. You can use HXRC for the 3990 controller emulation type without enabling the HXRC option.

---

If you use HXRC with FICON, carefully set the path configuration. Refer to the following table.

**Table 80: HXRC path configuration with FICON**

Application Site Path (System - DKC)	Record Set Transfer Path (System Data Mover - DKC)	For Use
ESCON	ESCON	Supported
ESCON	FICON	Supported
FICON	ESCON	Not Recommended <sup>1</sup>
FICON	FICON	Supported

1. If you use FICON for the path of application site, you should also use FICON for the path of System Data Mover (SDM) because of the difference in performance between FICON and ESCON.

## Continuous Access XP

As an enterprise advantage, the XP128/XP1024 can be concurrently connected to mainframe and a variety of UNIX-based and PC-server hosts. Contact your HP account team for the latest information on platform and version support. You can use the Continuous Access (CA) XP feature to maintain remote copies of the UNIX/PC server data stored on the XP128/XP1024. TC390 volumes and CA volumes can exist concurrently in the same XP128/XP1024.

## Overview of TrueCopy Operations

TC390 provides a storage-based hardware solution for concurrent data duplication, migration, and disaster recovery operations. After TC390 operations are established, remote copies of data are automatically maintained for backup and disaster recovery purposes. TC390 supports both SMS- and non-SMS-managed data, is completely application-independent, and is designed to run unattended. During normal TC390 operations, the main volumes remain online to all hosts and continue to process both read and write I/O operations.

TC390 Synchronous provides:

- Volume-based, real-time data backup and is ideal for high-priority data backup, duplication, and migration tasks. In the event of a disaster or system failure at the main site, the remote (secondary) TC390 Synchronous data can be rapidly invoked to allow recovery at the volume level with an extremely high level of data integrity.

TC390 Asynchronous (TC390A) represents a unique and outstanding disaster recovery solution for large amounts of data that span multiple volumes and even multiple XP128/XP1024. TC390A's group-based update sequence consistency solution enables fast and accurate database recovery, even after a "rolling" disaster, without the need for time-consuming data recovery procedures. The TC390A volume groups at the remote site can be recovered with full update sequence consistency, but the updates will be behind the main site due to the asynchronous remote copy operations.

TC390A provides:

- Update sequence consistency for user-defined groups of volumes (such as large databases).
- Protection for write-dependent applications in the event of a disaster.

This overview of TC390 operations describes:

- TC390 components (see page 730)
- TC390 operations (see page 742)
- TC390A recordset operations (see page 747)
- TC390A consistency group operations (see page 756)
- TC390 volume pair status and suspend types (see page 759)
- PPRC support, including P/DAS and GDPS (CGROUP) operations (see page 767)

## Components

TC390 operations involve the XP128/XP1024 (and/or other XP disk arrays) at the main and remote sites, the physical communications paths between the main and remote disk arrays, and the Command View management station. The main and remote disk arrays must have the same controller emulation. TC390 copies the original online data at the main site to the offline backup volumes at the remote site through the dedicated ESCON and/or Fibre Channel remote copy connections. The Command View management station hosts the TC390 software and provides a user-friendly Windows-based graphical user interface (GUI) for all TC390 functions and operations. The I/O time-stamping host software function, provided by MVS DFSMSdfp, is required for TC390A consistency groups that span multiple disk arrays. Error reporting communications (ERC) is required for effective disaster recovery with TC390.

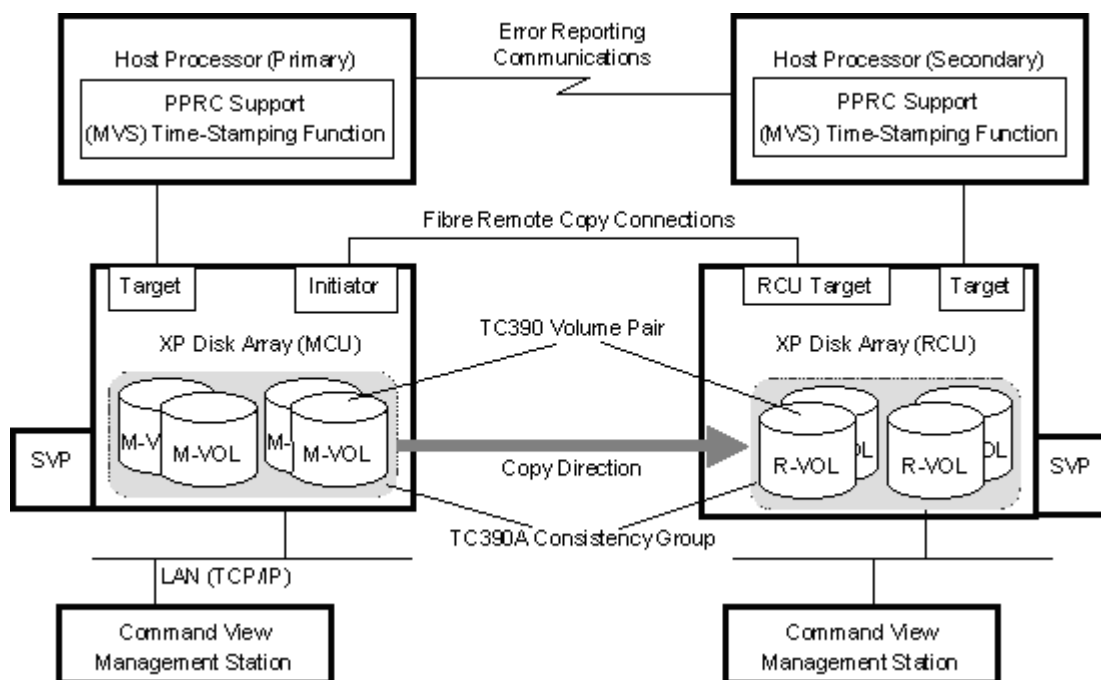
[Figure 287](#) on page 731 and [Figure 288](#) on page 732 show the TC390 components and their functions. The TC390 components are:

- XP128/XP1024
- Main and remote control units (MCUs and RCUs)
- Volume pairs (local M-VOLs and remote R-VOLs)
- TC390A consistency groups
- Host I/O time-stamping function
- Remote copy connections
- Remote control ports (RCPs) and local control ports (LCPs) for serial interface
- Ordinary target ports, initiator ports, and RCU target ports for Fibre Channel interface
- Command View management station with TC390 software
- Error reporting communications

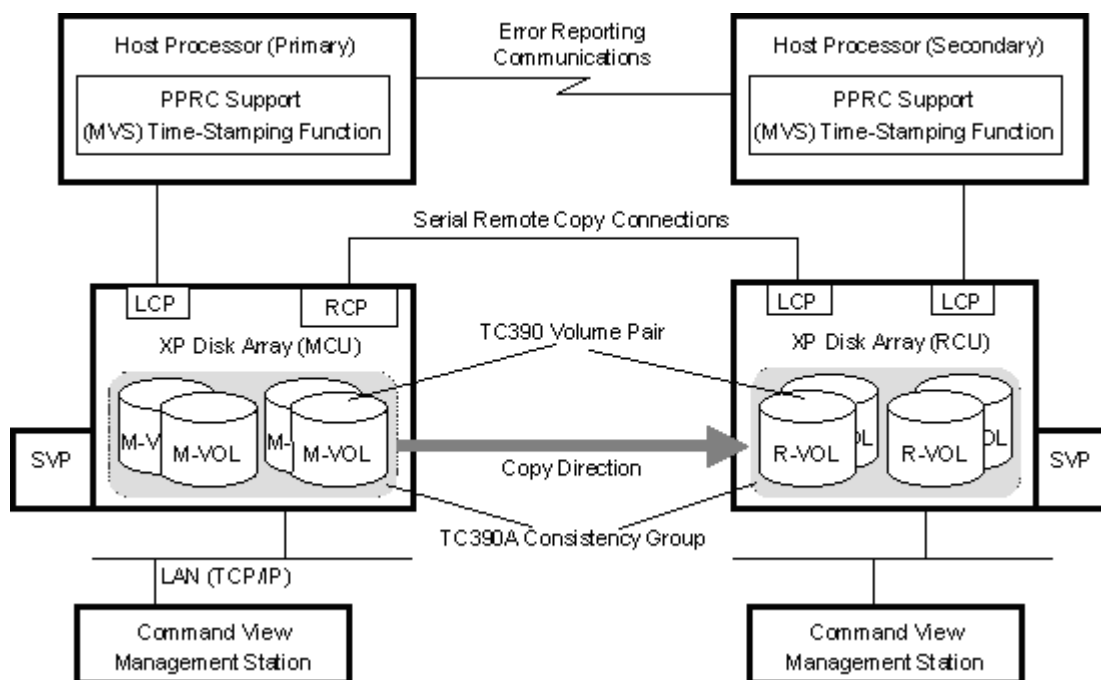
---

**Note:** You need the additional Shared Memory option to use TC390.

---



**Figure 287: TrueCopy components for serial (ESCON) connection**



**Figure 288: TrueCopy components for Fibre Channel connection**

## XP128/XP1024

TC390 operations involve the main (primary) disk arrays and the remote (secondary) disk arrays. This chapter covers TC390 operations in which the main disk array is an XP128/XP1024 and the remote disk array is either an XP128/XP1024 or other XP disk arrays. The main disk arrays contain the TC390 main volumes (M-VOLs), which contain the original data and are online to the host(s). The remote disk arrays contain the TC390 secondary volumes (R-VOLs), which are the synchronous or asynchronous copies of the M-VOLs. TC390 supports all CU images and logical volumes of the XP128/XP1024. All XP128/XP1024 with TC390 installed are compatible with the IBM PPRC host software function. For more information on PPRC, see [Using PPRC Commands for TrueCopy](#) on page 933. TC390 also supports all physical hard disk drive options and RAID5/RAID1 configurations for the XP128/XP1024.

To provide greater flexibility and to enable the XP128/XP1024 to be tailored to unique customer operating requirements, additional operational parameters, or optional modes, are available for the XP128/XP1024. At installation, the XP128/XP1024 modes are set to their default values so HP recommends that you



discuss these settings with your HP representative. Only your HP representative can change the XP128/XP1024 modes. [Table 81](#) shows the XP128/XP1024 modes related to TC390 and PPRC (and HXRC) operations.

**Note:** This mode information was current at the time of publication of this document, but it may change. Contact your HP representative for the latest XP128/XP1024 SVP mode information.

XP128/XP1024 performing TC390A operations (main and remote) use sidefiles in cache for storing the TC390A recordsets. HXRC also uses cache sidefiles. Disk arrays performing TC390A and/or HXRC must have sufficient cache installed to handle the increased sidefile usage. Insufficient cache can degrade disk array I/O performance and cause command retry requests and state-change-pending (SCP) messages. For more information on cache usage and sidefile thresholds, see [Inflow Control of Recordsets](#) on page 751.

**Table 81: XP128/XP1024 modes for TrueCopy (and HXRC)**

Mode	Description
20	Enables TC390 – R-VOL read-only function (RCU only).
21	Required ON for MCUs and RCUs that connect to channel extenders.
36	TC390 Synchronous – Selects function of CRIT=Y(ALL) or CRIT=Y(PATHS). Mode 36 ON: CRIT=Y(ALL) => equivalent to Fence Level = Data. Mode 36 OFF: CRIT=Y(PATHS) => equivalent to Fence Level = Status.
38	TC390 – Changes SSB reported against the WRITE I/O to the M-VOL in critical state. Mode 38 ON: Intervention required. Mode 38 OFF: Command rejected (PPRC specification).
45	HXRC – Sleep Wait suppressing option (see modes 61, 85, 86, 97; see <a href="#">HXRC Device Blocking and Load Balancing</a> on page 1015). When Mode 45 is ON and Mode 61 is ON, WRITE I/Os for LDEVs are blocked by the threshold specified by SDM. Mode 45 OFF: Sidefile threshold activates Sleep Wait timer at the sleep wait threshold. Mode 45 ON: Sidefile threshold does not activate Sleep Wait timer at the sleep wait threshold.
61	HXRC – Enables the DONOTBLOCK option of the XADDPAIR command (see mode 45; see <a href="#">HXRC Device Blocking and Load Balancing</a> on page 1015). <u>Must be OFF if the operating system does not support the DONOTBLOCK option.</u> Mode 61 OFF: DONOTBLOCK option ignored. Mode 61 ON: DONOTBLOCK option activated.

**Table 81: XP128/XP1024 modes for TrueCopy (and HXRC) (Continued)**

Mode	Description																		
64	TC390 CGROUP – Defines scope of CGROUP command within the XP128/XP1024. <u>Must be OFF for GDPS.</u> Mode 64 OFF: TC390 volumes behind the specified LCU pair (main and remote LCUs). Mode 64 ON: All TC390 volumes in this XP128/XP1024.																		
85, 86	HXRC – Variable sidefile threshold (see modes 45, 97, 98; see <a href="#">HXRC Device Blocking and Load Balancing</a> on page 1015). Mode 85 ON and Mode 86 OFF: Thresholds for Sleep wait/SCP/Puncture = 30/40/50% Modes 85 and 86 OFF: Thresholds for Sleep wait/SCP/Puncture = 40/50/60% Mode 85 OFF and Mode 86 ON: Thresholds for Sleep wait/SCP/Puncture = 50/60/70% Modes 85 and 86 ON: Thresholds for Sleep wait/SCP/Puncture = 60/70/80%																		
93	Graduated delay process for sidefile control (see <a href="#">Graduated Delay Sidefile Management</a> on page 753): Mode 93 OFF (default) = strong delay type Mode 93 ON = soft delay type <table border="1" data-bbox="261 782 1072 999"> <thead> <tr> <th data-bbox="261 782 611 812"><u>Amount of sidefile</u></th> <th data-bbox="618 782 811 812"><u>Strong delay type</u></th> <th data-bbox="903 782 1068 812"><u>Soft delay type</u></th> </tr> </thead> <tbody> <tr> <td data-bbox="261 821 611 850">threshold – [15-20%] (HWM)</td> <td data-bbox="618 821 811 850">100 ms x 1 time</td> <td data-bbox="903 821 1068 850">20 ms x 1 time</td> </tr> <tr> <td data-bbox="261 859 611 888">threshold – [10-15%]</td> <td data-bbox="618 859 811 888">200 ms x 1 time</td> <td data-bbox="903 859 1068 888">40 ms x 1 time</td> </tr> <tr> <td data-bbox="261 897 611 927">threshold – [5-10%]</td> <td data-bbox="618 897 811 927">300 ms x 1 time</td> <td data-bbox="903 897 1068 927">60 ms x 1 time</td> </tr> <tr> <td data-bbox="261 935 611 965">threshold – [0-5%]</td> <td data-bbox="618 935 811 965">400 ms x 1 time</td> <td data-bbox="903 935 1068 965">80 ms x 1 time</td> </tr> <tr> <td data-bbox="261 973 611 1003">threshold or higher</td> <td data-bbox="618 973 811 1003">500 ms x permanent</td> <td data-bbox="903 973 1068 1003">100 ms x permanent</td> </tr> </tbody> </table>	<u>Amount of sidefile</u>	<u>Strong delay type</u>	<u>Soft delay type</u>	threshold – [15-20%] (HWM)	100 ms x 1 time	20 ms x 1 time	threshold – [10-15%]	200 ms x 1 time	40 ms x 1 time	threshold – [5-10%]	300 ms x 1 time	60 ms x 1 time	threshold – [0-5%]	400 ms x 1 time	80 ms x 1 time	threshold or higher	500 ms x permanent	100 ms x permanent
<u>Amount of sidefile</u>	<u>Strong delay type</u>	<u>Soft delay type</u>																	
threshold – [15-20%] (HWM)	100 ms x 1 time	20 ms x 1 time																	
threshold – [10-15%]	200 ms x 1 time	40 ms x 1 time																	
threshold – [5-10%]	300 ms x 1 time	60 ms x 1 time																	
threshold – [0-5%]	400 ms x 1 time	80 ms x 1 time																	
threshold or higher	500 ms x permanent	100 ms x permanent																	
97	HXRC – Variable Sleep Wait timer duration (see modes 45, 85, 86; see <a href="#">HXRC Device Blocking and Load Balancing</a> on page 1015). Mode 97 OFF: Sleep Wait timer duration = 100 ms. Mode 97 ON: Sleep Wait timer duration = 10 ms.																		
98	HXRC – Selects SCP or session cancel (see modes 45, 85, 86; see <a href="#">HXRC Device Blocking and Load Balancing</a> on page 1015). Mode 98 OFF: SCP. Mode 98 ON: Forced session cancel.																		

**Table 81: XP128/XP1024 modes for TrueCopy (and HXRC) (Continued)**

Mode	Description
104	<p>TC390 CGROUP – Selects disk array default for CGROUP FREEZE option. Applies to 3990 emulation only.</p> <p>Mode 104 is invalid if the controller emulation is 2105. For 2105, use the CGROUP option of CESTPATH.</p> <p>Mode 104 ON: FREEZE enabled.</p> <p>Mode 104 OFF (default): FREEZE disabled.</p>
114	<p>TC390 – Allows dynamic port mode setting (RCP/LCP for serial, Initiator/RCU target for Fibre Channel) through PPRC CESTPATH and CDELPATH commands.</p> <p>Mode 114 ON: Set defined port to RCP/LCP mode (serial) or Initiator/RCU target mode (Fibre Channel) as needed.</p> <p>Mode 114 OFF (default): Port must be reconfigured using Command View management station.</p> <p>For Fibre Channel interface, do not use the CESTPATH and CDELPATH commands at the same time as the SCSI path definition function of LUN Management. The Fibre Channel interface ports need to be configured as initiator ports or RCU target ports <i>before</i> the CESTPATH and CDELPATH commands are issued.</p> <p>Before issuing the CESTPATH command, verify that the relevant paths are offline from the host(s) (for example, configure the Chipid offline, deactivate the LPAR, or block the port in the ESCD). If any active logical paths still exist, the add path operation will fail because the port mode (LCP/RCP) cannot be changed.</p>
118	<p>HXRC and TC390A – SIM notification when:</p> <ul style="list-style-type: none"> <li>■ HXRC sidefile reaches sleep wait threshold (see modes 45, 85, 86, 97).</li> <li>■ TC390A sidefile reaches high-water mark (HWM = sidefile threshold - 20%) (see mode 93).</li> </ul> <p>Mode 118 ON: Generate SIM.</p> <p>Mode 118 OFF (default): No SIM generated.</p>

## Control Units (MCUs and RCUs)

The main control unit (MCU) and remote control unit (RCU) control the following TC390 operations:

- The MCU is the control unit (CU) in the main disk array that controls the M-VOLs of the TC390 volume pairs. The Command View management station must be LAN-attached to the MCU of each TC390 pair. The MCU communicates with the RCU through the dedicated ESCON or Fibre Channel remote copy connections. The MCU controls the host I/O operations to the TC390 M-VOLs as well as the TC390 initial copy and remote copy operations between the M-VOLs and R-VOLs. The MCU also manages the TC390 pair status and configuration information.

- The RCU is the CU in the remote disk array that controls the R-VOLs of the TC390 volume pairs. The RCU assists in managing the TC390 pair status and configuration (for example, rejects write I/Os to TC390 R-VOLs). The RCU executes the remote copy operations issued by the MCU. The secondary Command View management station should be LAN-attached to the RCUs at the remote site. The RCUs should also be attached to a host system to allow sense information to be reported in case of a problem with a secondary volume or remote disk array and to provide disaster recovery capabilities.

The MCU and RCU can be defined separately for each TC390 pair. The XP128/XP1024 CU can function simultaneously as an MCU for one or more M-VOLs and as an RCU for one or more R-VOLs, provided the remote copy connections and ports are properly configured. The XP128/XP1024 CU provides up to 32 logical CU images. TC390 operations can be performed on all logical devices (LDEVs) in all logical CU images. You can use TC390 to select a CU image in the connected MCU and specify a CU image in the RCU.



**Caution:** If you are connecting the XP128/XP1024 and other XP disk arrays in a mixed configuration, verify that each disk array has a unique serial number. Although this would be extremely rare, it is possible that a serial number overlap could occur. If you have two disk arrays with the same serial number and you need to configure remote copy pairs between the two disk arrays, contact your HP account team for assistance.

---

## CU Emulation Types

TC390 supports 3990-3, 3990-6, 3990-6E, and 2105 controller emulation types for the MCU and RCU. The emulation type of the MCU and RCU can be different. The 3990-6, 3990-6E, or 2105 emulation is required for SMS I/O time-stamping of TC390A recordsets. The 2105 emulation type is required for HPAV operations.

**Changing from 3990 to 2105:** If you need to change the emulation from 3990 to 2105 for an XP128/XP1024 that has existing HXRC pairs, you must:

1. Stop all jobs and delete all HXRC pairs.
2. Change the CU emulation type of all CHA packages in the XP128/XP1024 to 2105. Do not intermix 3990 and 2105 emulations in the same disk array.
3. Restart jobs and re-establish HXRC pairs.

**Note:** The PPRC commands are different for 3990 and 2105 emulation types. For more information on using PPRC TSO commands with 2105 emulation, refer to [Using PPRC Commands for TrueCopy](#) on page 933.

---

**Note:** For important information on GDPS support and 2105 emulation, see [GDPS Support](#) on page 769.

---

## Volume Pairs (M-VOLs and R-VOLs)

TC390 performs remote copy operations for logical volume pairs established by the user. Each TC390 pair consists of one main volume (M-VOL) and one remote volume (R-VOL), which are located in different disk arrays. The TC390 M-VOLs are the primary volumes that contain the original data, and the TC390 R-VOLs are the secondary or mirrored volumes that contain the backup or duplicate data. The main and remote volumes must have the same format and capacity.

During normal TC390 operations, the TC390 M-VOL remains available to all hosts at all times for read and write I/O operations. The RCU rejects all I/Os to a TC390 R-VOL. The R-VOL read option (see [R-VOL Read Option](#) on page 746) allows read-only access to a TC390 R-VOL while the pair is suspended.

TC390 supports a maximum of 8192 pairs. TC390 supports the basic logical volume images (LVIs) available on the XP128/XP1024, such as 3390-3, 3390-3R, 3390-9, and 3390-L. For information on LVI requirements and support, see [Logical Volume Image \(LVI\)](#) on page 774.



**Caution:** Do not use M-VOLs or R-VOLs from hosts that have different CU emulation types (2105 and 3990) at the same time. If you use the M-VOLs or R-VOLs from the 2105 and 3990 hosts simultaneously, an MIH message might be reported to the 3990 host.

---

## Remote Copy Connections

The remote copy connections are the physical paths used by the TC390 MCUs to communicate with the TC390 RCUs. The maximum number of physical paths per logical CU image is eight for Fibre Channel, eight for serial with 2105 emulation, and four for serial with 3990 emulation. The MCUs and RCUs are connected through the serial interface (ESCON) or Fibre Channel interface cables.

When serial interface connections are used, ESCON directors (ESCDs) and/or ESCON repeaters are required for distances greater than 3 km (1.9 miles). TC390 operations can be performed at distances of up to 43 km (26.7 miles) using standard ESCON support. When using Fibre Channel interface (multimode shortwave) connections, two switches are required for distances greater than 0.5 km (1,640 feet). Distances up to 1.5 km (4,920 feet, 0.93 miles) are supported.

When using Fibre Channel interface (single-mode longwave) connections, two switches are required for distances greater than 10 km (6.2 miles). Distances up to 30 km (18.6 miles) are supported. Long-distance solutions are provided, based on user requirements and workload characteristics, using approved channel extenders and communication lines (for example, T1/T3/ATM).

The MCU-to-RCU remote copy configuration for TC390A has different requirements than the TC390 Synchronous configuration:

- TC390 Synchronous supports 1-to-n and n-to-1 remote copy connections ( $n \leq 4$ ). One MCU can be connected to as many as four RCUs, and one RCU can be connected to as many as four MCUs (one MCU/RCU = one physical CU, including all CU images). TC390 supports the dynamic switching capability of the ESCDs that is used to share the physical interface cables between the components. The ESCDs can accommodate channel-to-MCU and channel-to-RCU connections in addition to the remote copy connections
- TC390A supports 1-to-1 remote copy connections within the same consistency group. The M-VOLs and R-VOLs of the pairs in a consistency group must be located within one physical MCU and one physical RCU. This configuration ensures backup integrity for data which is spread across multiple volumes within one disk array.  
  
CA 1-to-n and n-to-1 configurations are valid for TC390A, as long as each consistency group does not span local or remote disk arrays.
- Fibre remote copy supports 1-to-1 remote copy connections. One disk array as an MCU can be connected to only one disk array as an RCU via optical fibre cables. For the CU images within one disk array, 1-to-4 and 4-to-1 remote copy connections are supported.

---

**Note:** HP strongly recommends that you establish at least two independent remote copy connections (one per cluster) between each MCU and RCU to provide hardware redundancy for this critical communications path.

---

For disk arrays with both TC390 and FICON host attachment, you must set the path configuration carefully. The following table lists the possible path configurations and indicates which combinations are supported.

**Table 82: TC390 configuration with FICON**

Application Site Path (System - DKC)	MCU-RCU	For Use
ESCON	ESCON	Supported
ESCON	Fibre Channel	Supported
FICON	ESCON	Not Support <sup>1</sup>
FICON	Fibre Channel	Supported

1. The configuration of FICON for channel-MCU paths and ESCON for MCU-RCU paths is not supported, because the bandwidth of FICON is greater than that of ESCON interface. If FICON is used for channel-MCU paths, use fibre-channel interface for the MCU-RCU paths.

## Initiator Ports and RCU Target Ports

The initiator ports are the dedicated Fibre Channel interface ports on the main disk array (MCU) to which the RCUs (RCU target ports) are connected. The initiator ports connect to the RCUs to send write I/O operations directly to the RCUs. Any Fibre Channel interface port of the XP128/XP1024 can be configured as an initiator port. Use the Port Change window to change the configuration of the XP128/XP1024 Fibre Channel ports (ordinary target port, initiator port, or RCU target port) as needed.

The RCU target ports are the dedicated Fibre Channel interface ports on the remote subsystem (RCU) to which the MCU (initiator ports) are connected. Any Fibre Channel interface port of the XP128/XP1024 can be configured as an RCU target port. The RCU target ports can be connected to the host channel paths via the Fibre Channel switch.

To fully support an automated environment, the XP128/XP1024 is capable of automatically configuring a Fibre Channel port as an Initiator or RCU target if required in response to the TSO CESTPATH and CDELPATH commands. See the SVP mode 114 in [Table 81](#) on page 733.

**Note:** For Fibre Channel interface, do not use the CESTPATH and CDELPATH commands at the same time as the SCSI path definition function of LUN Management. Two or more initiator ports must be configured before you can add the RCUs and create the TC390 volume pairs. The initiator ports cannot communicate with the host processor channels. To enable the host processor channels to send write I/O operations to the MCU, the host channel paths must be connected to the other Fibre Channel interface ports in the MCU. Ordinary Fibre Channel interface ports cannot be connected to the MCU. These ports (usually called target ports) can be connected to the host processor channels only.

---

## Remote Control Ports (RCPs) and Local Control Ports (LCPs)

The remote control ports (RCPs) are the dedicated serial interface ports on the main disk subsystem (MCU) to which the RCUs are connected. The RCPs emulate host processor channels to enable the MCUs to send write I/O operations directly to the RCUs. The RCPs support the dynamic switching capability provided by the ESCDs. Any serial port of the XP128/XP1024 can be configured as an RCP. You can use TC390 to change the configuration of the disk array serial ports (LCP or RCP) as needed.

The local control ports (LCPs) are used for connecting with the host processor channel interface. All serial interface ports on the XP128/XP1024 have a default setting of LCP. An RCU port connected to an MCU must be in LCP mode to receive remote copy I/O operations from the MCU.

To fully support an automated environment, the XP128/XP1024 is capable of automatically configuring a serial port as an RCP or LCP if required in response to the TSO CESTPATH and CDELPATH commands. See the SVP mode 114 in [Table 81](#) on page 733.



**Caution:** Before issuing the CESTPATH command, verify that the relevant paths are offline from the host(s) (for example, configure the Chipid offline, deactivate the LPAR, or block the port in the ESCD). If any active logical paths still exist, the add path operation will fail because the port mode (LCP/RCP) cannot be changed.

---

Two or more RCPs must be configured before you can add the RCUs and establish the TC390 volume pairs. The RCPs cannot communicate with the host processor channels and are dedicated to TC390 operations. The host channel interface paths must be connected to the other serial interface ports on the disk array.



Also, the serial interface ports, 1S-1Z and 2S-2Z, cannot be specified as RCPs.

The CHA package port that is added to DKA slot cannot be specified as RCPs. Therefore, if you specify this port number to use TSO CESTPATH command, an error will occur.

## Command View Management Station

The Command View management station communicates with each attached XP128/XP1024. The SVP at the main site must be connected to the MCU of each TC390 volume pair. A second SVP should also be installed at the remote site and connected to the RCUs. With another SVP at the remote site, you can modify the async options of the RCU (pending update data rate, offloading timer) and access the TC390 R-VOLs (for example, to perform ICKDSF). If you need to perform TC390 operations in the reverse direction from the remote site to the main site (for example, disaster recovery), using TC390 through Command View simplifies and expedites this process.

If you plan to perform TC390A operations, you must use the TC390 software to add the consistency groups and select group options and async options before you can add any TC390A pairs. These functions can be performed only using TC390 through Command View. After the consistency groups and asynchronous options have been configured, the PPRC TSO commands can be used to establish and manage TC390A pairs.

---

**Note:** For information on TC390A configuration services, contact your HP account team.

---

## Asynchronous Consistency Groups

A TC390A consistency group is a user-defined set of volume pairs across which update sequence consistency is maintained and ensured at the remote site. Each TC390A volume pair must be assigned to a consistency group. You can use TC390A to configure up to 128 consistency groups (0-7F) for each MCU and provides group-based operations for consistency groups (for example, suspend and resume group). You can use consistency groups to maintain update sequence consistency for databases that span multiple volumes, allowing immediate database recovery at the remote site when needed. For more information on TC390A consistency group operations, see [TrueCopy Asynchronous Consistency Group Operations](#) on page 756.

## Host I/O Time-Stamping Function

If you plan to establish TC390A consistency groups, the I/O time-stamping function must be installed on the host processor at the main (primary) site. The I/O time-stamp, which is provided by MVS DFSMSdfp, is the same time-stamp that is used by IBM XRC pairs. The RCU requires the I/O time-stamp information to process TC390A recordsets. The I/O time-stamping function should also be installed on the host processor at the remote (secondary) site so that time-stamps can be used when copying data in the reverse direction.

---

**Note:** If the main and/or remote system consists of several CPU complexes, a SYSPLEX timer is required to provide a common time reference for the I/O time-stamping function.

---

## Error Reporting Communications

Error reporting communications (ERC), which transfers information between host processors at the main and remote sites, is a critical component of any disaster recovery effort. You can configure ERC using channel-to-channel communications, NetView technology, or other interconnect technologies, depending on your installation requirements and standards. Neither TC390 nor Command View provides ERC between the main and remote sites.

When TC390 is used as a data migration tool, ERC is recommended but is not required. When TC390 is used as a disaster recovery tool, ERC is required to ensure effective disaster recovery operations. When a TC390 pair is suspended due to an error condition, the MCU generates sense information, which results in an IEA491E system console message. This information should be transferred to the remote site through ERC for effective disaster detection and recovery.

## Remote Copy Operations

The following figure illustrates the two types of TC390 remote copy operations: initial copy and update copy. To reduce the overhead associated with these remote copy activities and maximize data transfer, the XP128/XP1024 uses a special write command that is allowed only for TC390 initial and update copy operations. This command transfers the control parameters and the FBA-format data for consecutive updated records in a track using a single write operation. The special TC390 write command reduces interlocks on the ESCON interface protocol as well as the overhead required for performing FBA-to-CKD and CKD-to-FBA conversions.

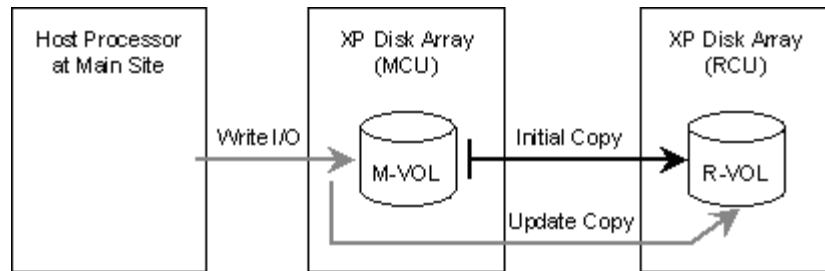


Figure 289: TrueCopy remote copy operations

## Initial Copy Operations

The initial copy operation synchronizes the M-VOL and R-VOL independently of host I/O processes. The initial copy operation is the same for TC390 Synchronous and TC390A pairs. A TC390 initial copy operation takes place when you add a new pair or resume a suspended pair. When a new pair is established, the entire contents of the M-VOL are copied to the R-VOL cylinder by cylinder, including the VTOC (volume table of contents) but not including the diagnostic and unassigned alternate tracks. For new pairs, you can also select **No Copy** or **None** for the initial copy mode, which copies only the VOLSER (volume serial number) to the R-VOL. If **No Copy** or **None** is selected, the user is responsible for ensuring that the M-VOL and R-VOL are already identical. The MCU cannot verify the contents of the volumes. When a suspended pair is resumed (also called a resync operation), only the VOLSER and out-of-sync cylinders (updated by write I/Os while the pair was suspended) are copied to the R-VOL.

For additional flexibility, TC390 provides the following options for the initial copy operation:

- Use the **number of tracks** option to specify how many tracks are copied simultaneously by the TC390 initial copy operation when adding/resuming a TC390 pair. This option can be specified using TC390 through Command View (Add Pair-Option) and the CESTPAIR TSO command (PACE parameter).
- Use the **Initial Copy Parameters: Priority** option to specify the order in which the initial copy operations are performed when adding/resuming multiple TC390 pairs. This option can only be specified using TC390 through Command View (Add Pair).

- Use the **Maximum Initial Copy Activities** option to specify the maximum number of concurrent initial copy operations that each MCU can perform (not pair-specific). This option can only be specified using TC390 through Command View (RCU Option window).

## Update Copy Operations

A TC390 update copy operation occurs when the host issues a write I/O operation to the M-VOL of a TC390 pair. The update copy operation duplicates the M-VOL write I/O at the R-VOL to keep the M-VOL and R-VOL synchronized. TC390 provides two modes for update copy operations: synchronous and asynchronous. The update copy mode is specified when you add a TC390 pair and cannot be changed. TC390 can also specify whether the cache-fast-write (CFW) data is included in the update copy operations.

For synchronous update copy mode, the MCU ensures that the M-VOL and R-VOL are synchronized at all times. The MCU does not return device-end status for the M-VOL write I/O until both the M-VOL write and its associated update copy operation at the RCU are complete. For synchronous mode, the MCU starts the update copy operation when it receives one of the following:

- The last write command in the current domain, specified by the preceding locate record command.
- A write command that requires switching to the next track.
- A write command that was not preceded by a locate record command.

---

**Note:** If many consecutive records are updated by a single CCW chain that does not use the locate record command (for example, long sequential chained write operations), disk array performance may be significantly impacted.

---

For asynchronous update copy mode, the MCU stores the M-VOL updates along with additional control information in cache, and sends the updates and control information to the RCU completely independent of the host I/O processes. These updates with their associated control information are called TC390A recordsets. The RCU stores the TC390A recordsets in cache and performs the updates to the R-VOLs in the same order as they were performed at the MCU(s) according to the TC390A time-stamp and sequence information. For more information on TC390A recordset operations, see [TrueCopy Asynchronous Recordset Operations](#) on page 747.

**Priority of initial and update copy:** In both TC390 Synchronous and TC390A, update copy has higher priority than initial copy. However, initial copy is executed based on the copy pace (3 or 15 tracks), therefore, update copy must wait this interval if initial copy is being executed. For example, if the copy pace is 15 tracks, the update copy may wait up to 15 tracks (1 cylinder). In the case of TC390A, update copy is executed asynchronously, but the same scheduling conflict can occur between the asynchronous update copy (write recordset) and initial copy.

## Read and Write I/O Operations for TrueCopy Volumes

When an MCU receives a read command for a TC390 M-VOL, the MCU completes the read from either cache or the M-VOL. If the read fails, the redundancy provided by RAID technology recovers the failure. The MCU does not read the TC390 R-VOL for recovery.

When an MCU receives a write command for a TC390 Synchronous M-VOL with *pending duplex* status (and the track has already been copied to the R-VOL), the MCU performs a synchronous update copy operation to complete the write at the R-VOL. When an MCU receives a write command for a *pending duplex* TC390A M-VOL (and the track has already been copied to the R-VOL), the MCU performs an asynchronous update copy operation.

When an MCU receives a write command for an M-VOL with *duplex* status, the user-selected update copy mode of the pair (synchronous or asynchronous) determines the sequence of events:

- **Synchronous Mode:** The MCU performs the write operation on the M-VOL, reports channel-end status to the host, starts the update copy operation for the R-VOL, and then reports device-end status to the host only after the update copy operation is complete. If the M-VOL write or R-VOL update copy operation fails, the MCU reports a unit check, and the host system and application program will regard that write operation to the M-VOL as failed. If a failure occurs at the M-VOL or the R-VOL, the corresponding volume of the TC390 pair will decommit the update to maintain exact synchronization of the volumes.
- **Asynchronous Mode:** The MCU completes M-VOL write operations independently of the associated update copy operations at the R-VOL. The RCU manages the R-VOL updates according to the TC390A recordset information and maintains time-based data consistency for the R-VOLs. If the M-VOL write operation fails, the MCU reports a unit check and does not create the TC390A recordset for this operation. If the update copy operation fails, the RCU suspends either the affected pair or all TC390A pairs in the

consistency group, depending on the type of failure. When the suspended TC390A pair or group is resumed, the MCU and RCU negotiate the resynchronization of the pair(s). For more information on suspended TC390A pairs, see [Suspended TrueCopy Asynchronous Pairs](#) on page 765.

The RCU does not allow a TC390 R-VOL to be online and rejects all host-requested read and write I/O operations for a TC390 R-VOL. The TC390 R-VOLs must be offline during normal TC390 operations. TC390 provides a special R-VOL read option that allows read-only access to the R-VOL while the pair is suspended (see [R-VOL Read Option](#) on page 746 for information on the R-VOL read option). If you need write access to a TC390 R-VOL, you must delete the pair.

## R-VOL Read Option

For additional flexibility, TC390 offers a special R-VOL read option. The HP representative enables the R-VOL read option on the RCU (mode 20). You can use the TC390 R-VOL read option to read a TC390 R-VOL only while the pair is suspended, without having to delete the pair. The RCU will change only the VOLSER of the suspended R-VOL so that the R-VOL can be online to the same host as the M-VOL while the pair is suspended. **All other write I/Os will be rejected by the RCU.** The MCU copies the M-VOL VOLSER back onto the R-VOL when the pair is resumed. When the R-VOL read option is not enabled and/or the pair is not suspended, the RCU rejects all read and write I/Os to a TC390 R-VOL. If you need write access to an R-VOL, you must delete the pair.

---

**Note:** For 2105 controller emulation, the CSUSPEND command to the R-VOL of a suspended TC390 pair will be rejected when the TC390 R-VOL read option is used.

---

## Difference Management

The differential data (updated by write I/Os during split or suspension) between M-VOL and R-VOL is stored in each cylinder bitmap. When a deleted/suspended pair is resumed (Resume Pair), the MCU merges the M-VOL and R-VOL bitmaps, and the differential data is copied to the R-VOL. The unit of data stored in the bitmap is Track or Cylinder. When adding a pair (Add Pair), you can select Track or Cylinder and you can also confirm the unit.

**Table 83: Operation of the unit of data stored in bitmap**

Program	The Unit of Data Stored in Bitmap			Confirmation
	Default (Auto) <sup>1</sup>	Track	Cylinder	
Command View	Available	Available	Available	Available
PPRC TSO	Not available	Not available	Not available	Not available

1. Default (Auto) means that Track or Cylinder is automatically set according to the capacity (number of cylinders or number of cylinders set by VLL) of the volumes used for the pairs. For volumes that have 10,019 cylinders or more, Cylinder is set. For other volumes, Track is set.

When you add a pair with the setting of Track, the number of pairs you can create is restricted. If you create the pairs more than the restricted number, a pair is automatically added with Cylinder. You can restrict the automatic change of the setting. Before using this function, contact your HP account team.

The restriction of the number of pairs depends on the capacity of the volumes used for the pairs. Both of the MCU and RCU are restricted.

The number of bitmap area in the disk array is 10,476. You can calculate the number of bitmap area. If the calculated bitmap area exceeds the number of bitmap area in the disk array, adding pairs operation is restricted.

To calculate the number of bitmap area, you can use the following equation:

$$((\uparrow (\text{Number of Cylinders} * 15) / 75,136) \uparrow) - 1$$

**Table 84: Maximum number of pairs possible for the basic LU type**

Basic Logical Unit (LU) Type	Number of Cylinders	Maximum Number of Pairs
3390-3/3A/3B/3C	3,339	8,192
3390-9	10,017	8,192
3390-L	32,760	1,746

## TrueCopy Asynchronous Recordset Operations

The TC390A recordsets contain the TC390A M-VOL updates and the associated control information, including the time-stamp of the M-VOL update, which enables the RCU to maintain update consistency of the TC390A R-VOLs. TC390A recordset operations include:

- Creating and storing recordsets at the MCU

- Sending recordsets to the RCU
- Storing recordsets at the RCU
- Selecting and settling recordsets at the RCU
- Types of recordsets
- Inflow control for sidefiles
- Dummy pair mode

## Creating and Storing Recordsets at the MCU

When an MCU performs an update (host-requested write I/O) on a TC390A M-VOL, the MCU creates a TC390A recordset that contains: the updated record, time-stamp information, sequence number, record location (device, cylinder, track, record number), and record length. The TC390A recordsets are queued in the cache storage of the MCU and sent to the RCU independent of host I/O processes. The RCU uses the time-stamp and sequence number information in the recordsets to update the R-VOL(s) in the same order as the M-VOL(s).

The time-stamp information is acquired from the (MVS) host's I/O time-stamp function. This time stamp provides a protective measure for write-dependent applications and minimizes recovery time in the event of a disaster. The sequence number indicates the number of recordsets that the MCU has created for each consistency group. The recordset information, except for the updated records, is stored and queued in an area of cache known as sidefile cache. For more information on sidefile cache, see [Inflow Control of Recordsets](#) on page 751.

## Sending Recordsets to the RCU

The MCU sends the TC390A recordsets to the RCU in a similar manner to the TC390 Synchronous updates. The MCU's RCPs and/or initiator ports act as host processor channels and issue special I/O operations, called remote I/Os (RIOs), to the RCU. The RIO transfers the recordsets in FBA format (not CKD) using a single channel command, eliminating the overhead associated with FBA-CKD conversion and thus providing more efficient transfer of user data. The MCU can send several recordsets using a single RIO, even if their sequence numbers are not contiguous. Therefore, TC390A recordsets are usually sent to the RCU in a different order than the arrivals at the MCU. The RCU ensures that records are applied to the R-VOLs in the correct sequence. This method of remote I/O provides the most efficient use of MCU-to-RCU link resources.



**Note:** The parameter length and detailed specification of this TC390A channel command are different than for TC390 Synchronous RIOs. Verify that your channel extenders are capable of supporting this command. For further details, contact your HP account team.

---

## Storing Recordsets at the RCU

The RCU maintains queues to control the storing of recordsets in the sidefile and commitment of updating records in the R-VOLs. The RCU queuing mechanism uses time-stamping to control the sequence in which R-VOL updates are applied and uses sequence numbers provided by the MCU to check for any missing updates.

**Note:** The MCU does not remove the sidefile entry for a recordset from its cache until it receives an I/O completion signal (device end) from the RCU. This is true even if the MCU and RCU are connected through a channel extender product. If a recordset is lost in transmission from the MCU to the RCU, the MCU's cylinder bitmap ensures that the missing recordset is identified and resent to the RCU.

---

## Selecting and Settling Recordsets at the RCU

The RCU selects the recordset to be promoted to formal data (or “settled”) as follows:

1. The RCU checks for a valid entry at the top of each queue in the consistency group. If the top of any queue is empty (for example, recordset not yet received), the RCU waits for that entry.
2. When the top of each queue contains a valid entry (recordset), the RCU selects the entry that has the earliest time-stamp value, and then settles this recordset.
3. The RCU repeats this process to select and settle TC390A recordsets.

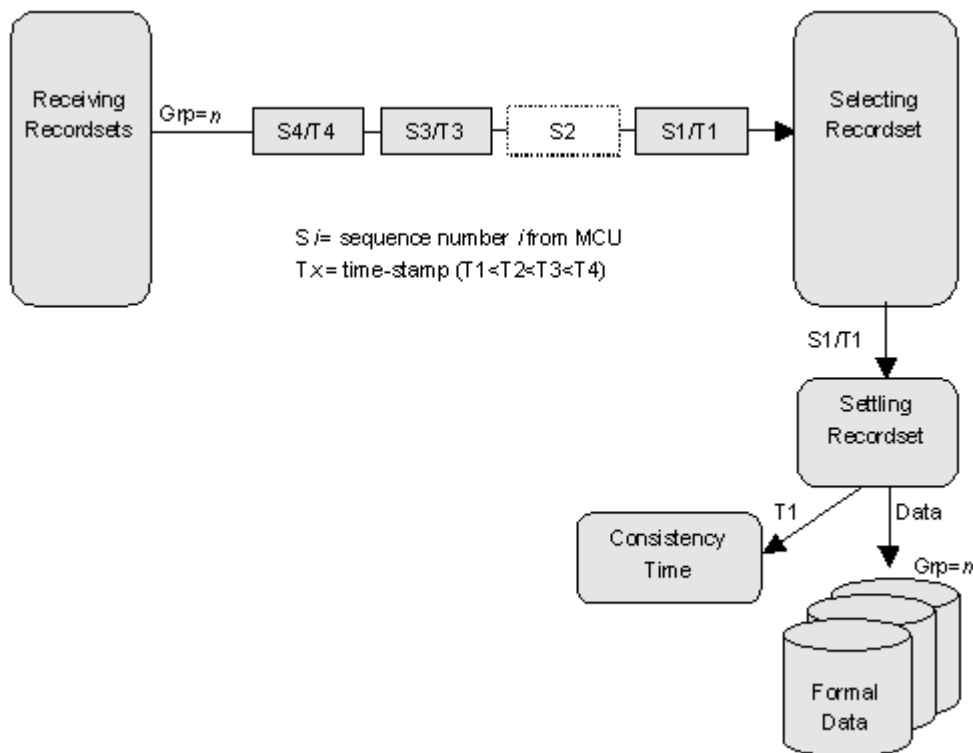
The following figure illustrates recordset selection and settling at the RCU. In this example, the top of the queue contains a valid entry: S1/T1. The RCU selects recordset S1/T1 to be settled because T1 is the earliest time-stamp. When S1/T1 is removed from the MCU queue, recordset S2 becomes the top entry, but it is empty. When recordset S2 arrives (and its time-stamp is later than T1 and earlier than T3), the RCU selects S2/T2 as the next recordset to be settled. The recordset

selected by the RCU is marked as “host-dirty” and treated as formal data. The time-stamp value of that recordset is promoted to the consistency time (C/T) of the group. The RCU settles the updated records in the recordset as follows:

- If the corresponding track is in cache (track-hit), the updated records in the recordset are copied to the existing cached track and the cache space for the sidefile is released.
- If the corresponding track is not in cache (track-miss), the RCU changes the cache designation of the sidefile to formal data. The data is not physically moved.

## Types of Recordsets

In addition to host update recordsets, the MCU passes control information to the RCU in special non-update recordsets. These special recordsets indicate when volume pair status changes and when an MCU power-off sequence is initiated, and also maintain sequence numbers in periods of low host activities.



**Figure 290: Selecting and settling TrueCopy Async recordsets at the RCU**

## Inflow Control of Recordsets

As described in the previous sections, both the MCU and RCU create sidefiles for storing TC390A recordsets. Because the sidefiles occupy exclusive space in cache, both the MCU and RCU perform inflow control to prevent an overload of the disk array's cache resources. The XP128/XP1024 uses the following parameters (specified on the TC390 Async Option window, see [Asynchronous Copy Option](#) on page 859) for TC390A cache inflow control:

- **Sidefile Threshold** = maximum cache % available for use by TC390A sidefiles. [Table 85](#) on page 752 shows the TC390A sidefile threshold values and describes the actions that occur when each threshold is reached.
  - The “high-water mark” (HWM), which is the sidefile threshold minus 20%, indicates when graduated delay begins for TC390A volume pairs (see the following section). If SVP mode 118 is ON, a warning SIM is also generated.
  - The puncture threshold, which is the sidefile threshold plus 10%, indicates when the TC390A pairs will be suspended due to sidefile overflow (see [CESTPATH](#) on page 939).
  - **Inflow control by MCU:** When the amount of MCU sidefile cache reaches the HWM, the MCU responds to update I/Os from the host with state-change-pending (SCP) or channel-command-retry requests and begins graduated delay.
  - **Inflow control by RCU:** When the amount of RCU sidefile cache reaches the HWM, the RCU responds with channel-command-retry requests to the RIO commands, which transfer the recordsets from the MCU. The only recordset accepted by the RCU is the recordset with the sequence number required to continue settling pending recordsets.
- **Offloading Timer** = maximum time between TC390A recordset transfers.
  - **Inflow control by MCU:** If the MCU is not able to send a recordset to the RCU within the user-specified offloading timer value, the MCU suspends all TC390A pairs and resets the SCP condition to avoid hanging up the system.
  - **Inflow control by RCU:** If the RCU is not able to settle a recordset within the user-specified offloading timer value, the RCU suspends all TC390A volume pairs and resets the channel-command-retry condition to avoid hanging up the MCU.

**HXRC.** HXRC operations use a different cache sidefile than TC390A. [Table 85](#) on page 752 also shows the sidefile threshold values for HXRC operations and describes the actions that occur when each threshold is reached. Disk arrays performing TC390A in combination with HXRC must have sufficient cache installed to handle the increased sidefile activity. If a “sidefile puncture” condition occurs (HXRC sidefiles reach 10% over threshold), the XRC session having the highest sidefile usage is terminated.

SIM reporting for sidefile conditions is disabled when mode 118 is OFF ([Table 81](#) on page 733).

---

**Note:** Cache LUN XP operations may decrease the total amount of cache available for TC390A and HXRC operations, but do not directly affect sidefile cache usage. Available cache is defined as the amount of physical cache memory installed on the disk array minus any cache reserved for the Cache LUN XP feature.

---

**Table 85: Sidefile thresholds**

Operation	Threshold(s)	Action(s)
TC390A	High-water mark (HWM) = sidefile threshold – 20%	MCU (RCU) reaches HWM: command retry to host (MCU), begin graduated delay. Delay times can be adjusted using mode 93 (see <a href="#">Table 81</a> on page 733).
	Sidefile threshold = 30-70% of cache, default = 50%. TC390A threshold can be adjusted from 30-70% (in 10% increments) using TC390 through Command View.	MCU (RCU) reaches threshold: command retry to host (MCU), max delay time (500 or 100 ms). Delay time can be adjusted using mode 93 (see <a href="#">Table 81</a> on page 733).
	Puncture threshold = sidefile threshold + 10%	MCU (RCU) reaches puncture: suspend affected TC390A pairs due to sidefile overflow condition.
HXRC <sup>1</sup>	$[XRC \text{ sidefile}] / [\text{avail cache}] = 40\%, 50\%, 60\%$ XRC thresholds can be adjusted by using modes 85 and 86 (see <a href="#">Table 81</a> on page 733). Threshold 1/2/3 = 30/40/50%, 40/50/60%, or 60/70/80%	Threshold 1 = command retry. Threshold 2 = SCP message. Threshold 3 = puncture condition.
Write Pending	$[\text{write pending}] / [\text{avail cache} - \text{sidefile}] = 70\%$	Command retry.

1. For more information on sidefile thresholds for HXRC operations, refer to [HXRC Device Blocking and Load Balancing](#) on page 1015.

## Graduated Delay Sidefile Management

The following figure shows the graduated delay process for TC390A sidefile management. When the TC390A sidefile value reaches the high-water mark (threshold minus 20%), the XP128/XP1024 begins command retry delay for host updates to TC390A M-VOLs and reports a warning SIM to the host. As the amount of sidefile increases, the delay increases incrementally as shown in the following figure. Use Mode 93 on the XP128/XP1024 SVP (refer to [Table 81](#) on page 733) to select the delay type (long or short). This graduated delay methodology minimizes the potential for sidefile overcommitment, while at the same time providing another level of automation control.

SIM reporting for TC390A sidefile conditions is enabled only when SVP mode 118 is ON (refer to [Table 81](#) on page 733).

You can disable the command retry delay for a limited number of critical volumes using the special “No delay” parameter for the CESTPAIR TSO command (see [CESTPAIR](#) on page 941). When this parameter is set, the XP128/XP1024 will not delay host write I/Os to the M-VOL until the TC390A sidefile amount reaches the puncture threshold (threshold + 10%). This prevents performance degradation for critical volumes and should be used only for a small number of volumes.

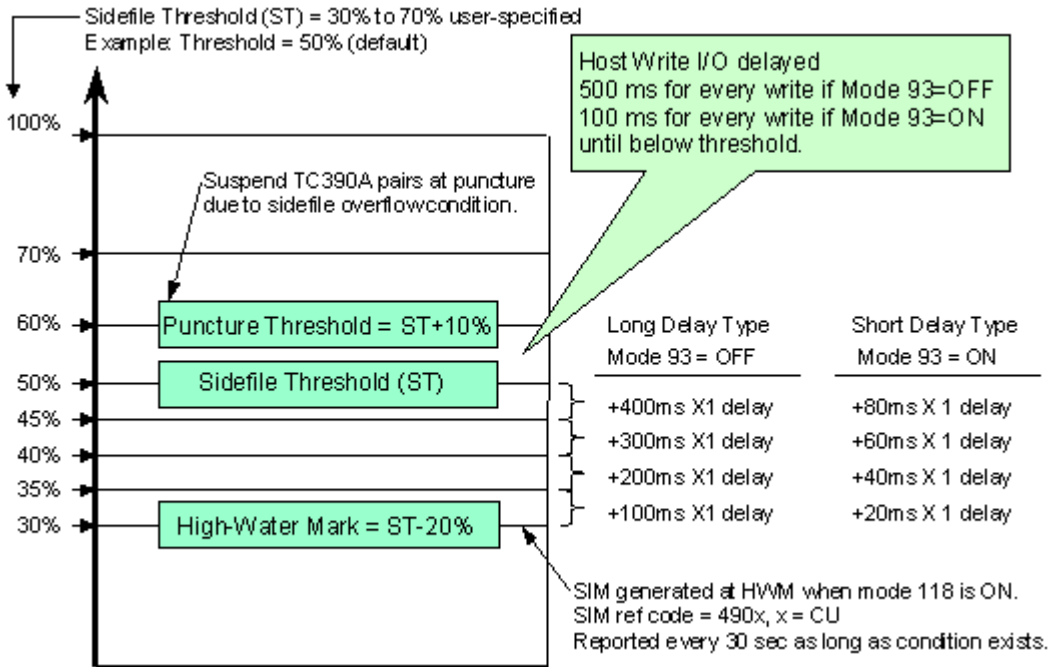
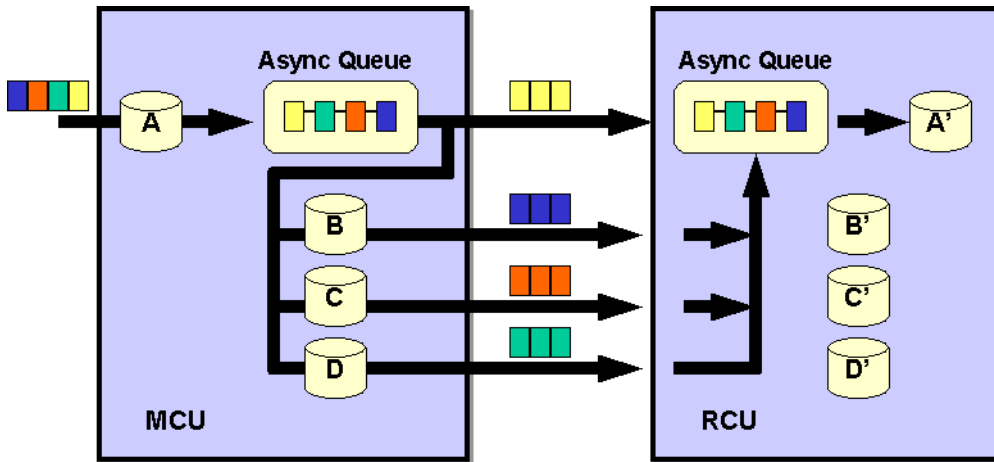


Figure 291: Graduated delay process for sidefile management

## Dummy Pair Mode

TC390A performance can be limited due to RIO response through CNT/ATM. This is because only one RIO at a time can transfer updates to remote side. RIO is issued with the device address of secondary volume. ESCON protocol allows only one I/O at a time to the same device address. Dummy pair mode addresses this limitation by providing additional device addresses for specific high-usage volumes.

In the following figure, updates to the primary volume (A) are transferred to the device addresses of its secondary volume (A') as well as the secondary volumes of dummy volume pairs (B'-D') in parallel.



**Figure 292: Dummy pair mode**

The basic specifications for dummy pair mode are:

- Up to three dummy pairs can be related to one real volume pair.
- Volumes must be assigned in both the MCU and RCU for dummy pair.
- Custom-size volumes of minimum size (one cylinder) can be used for dummy pair.
- Dummy pair volumes cannot accept host I/Os, must be offline from all host systems.
- Volumes for a dummy pair must be in the same logical CU image as the real pair.

The following table shows the main differences between dummy pair mode and HPAV operations.

**Table 86: Differences between TC390A dummy pair mode and HPAV**

	TC390A Dummy Pair	HPAV
Paralleling	TC390 Async RIO	Host I/O
Effective for	Single or independent I/O requester	Independent I/O requester (for example, Different job and extend). Due to this reason, possibly HPAV is not effective for IMS WADS.
Requires	At least minimum capacity VSC custom volume	Only LDEV address

General recommendation: When a specific TC390A volume could be a bottleneck due to high write I/O activity:

- If write I/Os are from independent I/O requester, consider dividing I/O activity to different volume (by dataset relocation, for example).
- Otherwise consider using TC390A dummy pair(s).

You can use the PPRC CESTPAIR command as follows to establish TC390A dummy pairs and relationships to real volume pairs. For detailed information on configuring master and dummy pairs using the CESTPAIR TSO command, refer to [CESTPAIR](#) on page 941.

1. CESTPAIR: Establish real volume pair (A-A')
2. CESTPAIR: Establish 1st dummy pair (B-B') for A-A'
3. CESTPAIR: Establish 2nd dummy pair (C-C') for A-A'
4. CESTPAIR: Establish 3rd dummy pair (D-D') for A-A'

## TrueCopy Asynchronous Consistency Group Operations

TC390A consistency groups enable update sequence consistency to be maintained across a group of volumes. The R-VOLs of the pairs in a consistency group must be located within one RCU (n-to-1 requirement). The TC390A consistency group operations include the following:

- Group options
- Group consistency time
- Group operations

### Group Options

TC390A provides the following options for each consistency group: **Timer Type**, **Time Out [Copy Pending]**, and **Time Out [RCU Ready]**. These options are selected when you add a group. If you want to change the **timeout** options of a group, you must suspend all pairs in the group first. If you want to change the **timer type** option, you must delete all pairs. The **Timer Type** and **Time Out [Copy Pending]** options must be the same for all MCUs that contain M-VOLs in the group. The **Time Out [RCU Ready]** option can be different at each MCU if necessary.

**Timer Type.** This group option determines how the MCU will acquire the time-stamp for the TC390A recordsets:



- **System.** When the **System** timer option is selected, the MCU acquires the time-stamp information for each recordset as follows. When a TC390A pair is established, the MCU reports state-change-interrupt (SCI) to all hosts. The host then issues a series of sense group commands to determine the device status change and the MCU returns the same response as if the device had been added to an XRC session to activate I/O time-stamping for the device. After I/O time-stamping is activated, the MVS IOS routine attaches the time-stamp information (contents of time-of-day (TOD) clock) to each write I/O operation for the device. The time-stamp indicates the time that the update was generated during start subchannel (SSCH) at the main host system and the time-stamp is transferred to the MCU at the beginning of each I/O operation.
- **Local.** The **Local** timer option enables the MCU to generate the time-stamp for each update I/O using its own internal clock, rather than using the SMS I/O time-stamp.
- **None.** The **None** timer option should only be selected when establishing TC390A pairs in the reverse direction (from secondary to primary). When the **None** option is selected, the MCU still acquires the time-stamp information from the host I/O time-stamping function.

**Time Out [Copy Pending].** This group option specifies the maximum delay allowed for TC390A copy operations. For instructions on selecting the correct **Time Out [Copy Pending]** setting for your operational environment, see [Adding Consistency Groups \(Add CT Group\)](#) on page 854.

The RCU will suspend all R-VOLs in the group when:

- The RCU has not had any communication from the MCU within the specified time. This situation could indicate a disaster or failure at the primary site.
- The RCU has been receiving recordsets from the MCU(s) but has not been able to settle a recordset within the specified time. This situation may indicate that the RCU does not have enough resources to handle the remote copy and I/O workloads.

**RCU Ready.** This option specifies the maximum delay for re-establishing MCU-RCU communications following MCU power-off. During MCU power-on, the MCU re-establishes communication with all registered RCUs. If it is not able to re-establish communication with an RCU within the specified time, the MCU suspends all affected TC390A volume pairs.

## Group Consistency Time

During normal TC390A operations, the consistency time (C/T) of a group corresponds to the time-stamp value of the most recently settled recordset at the RCU. The consistency time for the group is indicated as part of the TC390A R-VOL pair status (also displayed by the CQUERY TSO command to the R-VOL). As the main system continues to update the TC390A M-VOLs, the difference between the current system time and the group consistency time indicates the amount of time that the R-VOLs are behind the M-VOLs. The M-VOL updates that take place during this time may be lost when a disaster occurs.

When a TC390A volume pair is suspended, the C/T of the suspended R-VOL is frozen. If the RCU can ensure the update sequence consistency between the suspended R-VOL and the other R-VOLs in the consistency group, the R-VOL C/T is frozen at the latest consistency time of the group. Otherwise, the R-VOL C/T is frozen at the time-stamp value of the most recent update that was successfully copied to the R-VOL. The C/T of a suspended R-VOL may be older than the C/T of other R-VOLs in the group, and if the entire group was not also suspended, the consistency time of the group is still ticking. For suspended TC390A R-VOLs, the TC390 Pair Status window displays whether the C/T was frozen to the group or R-VOL time.

After you have established TC390A operations, you should monitor the consistency time of each group at the RCU(s). If the average delay is longer than your disaster recovery design can accept, you should consider adding remote copy resources (for example, paths or cache) and/or reducing the I/O workload to improve disk array performance. If the delay between the M-VOL update and the corresponding R-VOL update reaches the time specified by the **Time Out [Copy Pending]** group option, the MCU will suspend all affected volume pair(s) due to the heavy I/O workload (at MCU or RCU). To prevent timeout errors, you can increase the **Time Out [Copy Pending]** value, reduce I/O workload, and/or add remote copy resources.

## Group Operations

TC390A provides the following group-based operations to simplify and expedite disaster/failure recovery procedures:

- Group operations at the MCU:
  - Suspend all pairs in a consistency group. For a description of the TC390A **Group** suspend option (supported by CSUSPEND TSO command), see [Suspending TrueCopy Pairs \(Suspend Pair\)](#) on page 890.

- Resume all suspended pairs in a consistency group. For a description of the TC390A **Resume-Group** pair option (supported by the CESTPAIR TSO command with the parameter MODE=RESYNC), see [Resuming TrueCopy Volume Pairs \(Resume Pair\)](#) on page 894.
- Delete all pairs in a consistency group. For a description of the TC390A **Group** delete option (supported by CDELP AIR TSO command), see [Deleting TrueCopy Volume Pairs \(Delete Pair\)](#) on page 898.
- Group operations at the RCU:
  - Suspend all pairs in a consistency group. For a description of the TC390A **Group** suspend option (supported by CSUSPEND TSO command), see [Suspending TrueCopy Pairs \(Suspend Pair\)](#) on page 890.
  - Delete all suspended pairs in a consistency group except for any inconsistent pairs. For a description of the TC390A **C/T** delete option (not supported by CDELP AIR, CDELP AIR cannot be issued to the RCU), see [Deleting TrueCopy Volume Pairs \(Delete Pair\)](#) on page 898.
  - Delete all pairs in a consistency group regardless of their consistency status. For a description of the TC390A **Group** delete option (not supported by CDELP AIR, CDELP AIR cannot be issued to the RCU), see [Deleting TrueCopy Volume Pairs \(Delete Pair\)](#) on page 898.

TC390A also provides the **Error level** pair option (see [Creating TrueCopy Volume Pairs \(Add Pair\)](#) on page 880) that is used to trigger automatic suspension of an entire consistency group. When a TC390A pair is suspended due to failure (not user-requested), this TC390A pair option determines whether all pairs in the same consistency group will also be suspended. If you select the **Group** error level for a TC390A pair, all pairs in the same group will be suspended. If you select the **Volume** error level, only the affected TC390A pair will be suspended.

---

**Note:** The **Error level** pair option is very important for managing TC390A groups and planning for disaster recovery. The **Group** error level should be selected for all TC390A volumes that are essential to disaster recovery. Suspended TC390A R-VOLs that have the **Volume** error level should not be used for disaster recovery.

---

## TrueCopy Volume Pair Status

TC390A displays the pair status for each volume in the selected logical CU image (CUI) of the connected XP128/XP1024. The MCU maintains the status of the M-VOL and is responsible for keeping the M-VOL and its R-VOL synchronized.

The RCU maintains the status of the R-VOL. The MCU can change the pair status of the M-VOL and R-VOL. The RCU can change the pair status of the R-VOL but not the M-VOL. The MCU will detect when the RCU changes the R-VOL status (if the path status is normal) and will change the M-VOL status accordingly. The TC390 pair status can be acquired from the MCU and RCU using the TC390 software (Pair Status) and the CQUERY TSO command.

**Table 87** on page 761 lists and describes the TC390 volume pair status descriptions. A volume that is not assigned to a TC390 volume pair has the status *simplex*. When a TC390 pair is started, the MCU changes the status of both volumes (M-VOL and R-VOL) to *pending duplex*. When the initial copy operation is complete, the MCU changes the status of both volumes to *duplex*. When a pair is suspended from the MCU, the MCU changes the status of the M-VOL and R-VOL (if the path status is normal) to *suspended*. When a pair is suspended from the RCU, the RCU changes the status of the R-VOL to *suspended*, and the MCU detects the pair suspension (if the path status is normal) and changes the M-VOL status to *suspended*. When you delete a pair from the MCU, the MCU changes the status of the M-VOL and R-VOL (if the path status is normal) to *simplex*. When you delete a pair from the RCU, the RCU changes the R-VOL status to *simplex*, and the MCU detects the pair deletion (if the path status is normal) and changes the M-VOL status to *suspended*.

### **TC390A-Specific Pair Status**

The TC390A *suspending* and *deleting* transitional states occur when a request to change TC390A pair status has been accepted, but the change to the requested status (*suspended* or *simplex*) is not yet complete. These states are not reported to the host. In the case of *suspending*, both the user and the MCU can request the status change. In the case of *deleting*, only the user can request the status change. If the user requested the status change, the final status is reported at the end of the transition. If an error caused the status to change to *suspended*, the suspended status is reported at the beginning of the transition.

The TC390A *SEQCHK* status is indicated when a TC390A pair assigned to a consistency group with the **System** timer type accepts a non-time-stamped update from the primary system. The *SEQCHK* status does not affect TC390A copy activities and will be removed when the next time-stamped update is successfully copied to the R-VOL. However, if a disaster or system failure occurs before the next time-stamped update, the update sequence consistency between the R-VOL and other R-VOLs in the consistency group is not ensured. To ensure effective disaster recovery, you should detect and remove the source of the *SEQCHK* status. The *SEQCHK* status can be caused by any of the following:

- An application may issue update I/Os bypassing the MVS standard I/O procedure.
- The I/O time-stamping function may not be active at the primary system.

**Table 87: TrueCopy volume pair status**

Pair Status	Description
Simplex	This volume is not currently assigned to a TC390 volume pair. When this volume is added to a TC390 volume pair, its status will change to <i>pending duplex</i> .
Pending Duplex	The TC390 initial copy operation for this volume pair is in progress. This volume pair is not yet synchronized. When the initial copy is complete, the status changes to <i>duplex</i> .
Duplex	This volume pair is synchronized. Updates to the M-VOL are duplicated on the R-VOL.
Suspended (see <a href="#">Table 88</a> on page 764 for suspend types)	<p>This volume pair is not synchronized:</p> <ul style="list-style-type: none"> <li>■ For TC390 Synchronous only, if the MCU cannot keep the pair synchronized for any reason, the MCU changes the status of the M-VOL and R-VOL (if possible) to <i>suspended</i>.</li> <li>■ For TC390A only, if the MCU detects a TC390A suspension condition (see <a href="#">Suspended TrueCopy Asynchronous Pairs</a> on page 765), the MCU changes the M-VOL status and R-VOL status (if possible) to <i>suspended</i>.</li> <li>■ For TC390A only, when the RCU detects a TC390A suspension condition (see <a href="#">Suspended TrueCopy Asynchronous Pairs</a> on page 765), the RCU changes the R-VOL status to <i>suspended</i>.</li> <li>■ For TC390 Synchronous only, the MCU changes the status of all TC390 Synchronous pairs to <i>suspended</i> when it performs the CGROUP/RUN command (see <a href="#">CGROUP (FREEZE/RUN) Support</a> on page 950).</li> <li>■ When you suspend a pair from the MCU, the MCU changes the status of the M-VOL and R-VOL (if possible) to <i>suspended</i>. When you suspend a pair from the RCU, the RCU changes the status of the R-VOL to <i>suspended</i>.</li> <li>■ When the MCU detects that the pair was suspended or deleted from the RCU, the MCU changes the status of the M-VOL to <i>suspended</i>.</li> </ul>

**Table 87: TrueCopy volume pair status (Continued)**

Pair Status	Description
<b>Pair Status for TC390A only:</b>	
Suspending	This pair is not synchronized. This pair is in transition from <i>duplex</i> or <i>pending duplex</i> to <i>suspended</i> . When the suspension is requested (by user, MCU, or RCU), the status of all affected pairs changes to <i>suspending</i> . When the suspension is complete, the status changes to <i>suspended</i> .
Deleting	This pair is not synchronized. This pair is in transition from <i>duplex</i> , <i>pending duplex</i> , or <i>suspended</i> to <i>simplex</i> . When the delete pair operation is requested (by user), the status of all affected pairs changes to <i>deleting</i> . When the delete pair operation is complete, the status changes to <i>simplex</i> .
SEQCHK	The RCU encountered a non-time-stamped recordset for a TC390A pair using the <b>System</b> timer type option. This status can be displayed at the MCU and RCU, but the MCU may not have the most current information. Always use the pair status information displayed at the RCU for disaster recovery.

## Suspended Pairs

[Table 88](#) on page 764 lists and describes the TC390 suspend types, which indicate the reason for suspension. A user can suspend a TC390 pair at any time after the initial copy operation is complete. The user must suspend a TC390 pair to perform ICKDSF maintenance on the M-VOL or to access the R-VOL (read only mode). TC390 pairs are also suspended when the CGROUP/ RUN command is processed (see [CGROUP \(FREEZE/RUN\) Support](#) on page 950). When the user suspends a TC390 Synchronous pair, the MCU ensures synchronization by completing any pending update copy operation before changing the status to *suspended*. When the user suspends a TC390A pair, the MCU and RCU ensure synchronization by either completing or discarding any pending update copy operations according to the user-specified drain/purge suspend option.

A TC390 pair is suspended by the MCU when any of the following suspension conditions are detected. A TC390A pair can also be suspended by the RCU (see [Suspended TrueCopy Asynchronous Pairs](#) on page 765).

- When the MCU detects that the user has deleted the volume pair from the RCU (for example, to access an R-VOL at the remote site).
- When the MCU detects an error condition related to the RCU, R-VOL, a TC390 Synchronous update copy operation or a TC390A recordset operation (see [Suspended TrueCopy Asynchronous Pairs](#) on page 765).
- When the RCU cannot execute DFW (DASD fast write) to the R-VOL (only if **DFW required** is selected).

- When the MCU is unable to communicate with the RCU.

If a TC390 Synchronous update copy operation fails, the MCU maintains exact synchronization by reporting a unit check and decommitting the M-VOL update so that the host system and application program regard that write operation to the M-VOL as failed. For information on failed TC390A recordset operations, see [Suspended TrueCopy Asynchronous Pairs](#) on page 765.

When a TC390 pair is suspended, the MCU stops performing update copy operations to the R-VOL. For a suspended TC390 Synchronous pair, the MCU may or may not continue accepting write I/Os for the M-VOL depending on the M-VOL fence level and suspend option (if user-requested). If the MCU accepts write I/Os for a suspended M-VOL, the MCU keeps track of the M-VOL cylinders that are updated while the pair is suspended. For a suspended TC390A pair, the MCU and RCU keep track of any recordsets that were discarded during suspension, and the MCU continues accepting write I/Os for the M-VOL and keeps track of the M-VOL cylinders that are updated while the pair is suspended.

A suspended TC390A R-VOL has an additional status called the consistency status that is displayed only at the RCU. The consistency status of a suspended TC390A R-VOL indicates its update sequence consistency with respect to the other R-VOLs in the same group. [Table 89](#) on page 765 lists and describes the consistency status descriptions for suspended TC390A R-VOLs.

When a TC390 pair is suspended, whether user-requested or due to failure, the MCU generates sense information to notify the host(s). If the host system supports IBM PPRC and the PPRC support RCU option is enabled, this notification results in an IEA494I and/or IEA491E system console message that indicates the reason for suspension. For more information on the IEA494I and IEA491E system console messages, see [IEA494I and IEA491E Console Messages](#) on page 959.

---

**Note:** If you need write access to an R-VOL, you must delete the pair.

---

**Table 88: Suspend types**

Suspend Type	Applies to	Description
M-VOL by operator	M-VOL (TC390 Sync only)	The user suspended the pair from the MCU using the <b>M-VOL Failure</b> option. The R-VOL suspend type is <i>by MCU</i> .
R-VOL by operator	M-VOL, R-VOL	The user suspended the pair from the MCU or RCU using the <b>R-VOL</b> option.
by MCU	R-VOL	The RCU received a request from the MCU to suspend the volume pair. The M-VOL suspend type is M-VOL by Operator or R-VOL by Operator.
by RCU	M-VOL	The MCU detected an error condition at the RCU that caused the MCU to suspend the TC390 volume pair. The R-VOL suspend type is by MCU.
Delete Pair to RCU	M-VOL	The MCU detected that the R-VOL status changed to simplex because the user deleted the pair from the RCU. The pair cannot be resumed because the R-VOL does not have the suspended status.
R-VOL Failure	M-VOL	The MCU detected an error during communication with the RCU or an I/O error during update copy. In this case, the R-VOL suspend type is usually by MCU.
MCU IMPL	M-VOL, R-VOL	The MCU could not find valid control information in its nonvolatile memory during the IMPL procedure. This condition occurs only if the MCU is completely without power for more than 48 hours (for example, power failure and fully discharged backup batteries).
Initial Copy failed	M-VOL, R-VOL	The volume pair was suspended before the initial copy operation was complete. The data on the R-VOL is not identical to the data on the M-VOL.
by FREEZE	M-VOL, R-VOL (TC390 Sync only)	The volume pair was suspended by the CGROUP/RUN TSO command. See <a href="#">CGROUP (FREEZE/RUN) Support</a> on page 950.
MCU P/S-OFF	R-VOL (TC390A only)	The RCU received a request from the MCU to suspend the R-VOL due to MCU power-off. The RCU stops expecting recordsets from that MCU.
by sidefile overflow	M-VOL, R-VOL (TC390A only)	The amount of sidefile exceeds the specified "current pending update data rate" and the RCU data is not transferred within the specified "offloading timer".



**Table 89: Consistency status for suspended TrueCopy Async R-VOLs**

Consistency Status	Description
Volume	<p>This TC390A volume pair was probably suspended alone. Update sequence consistency between this R-VOL and other R-VOLs in this consistency group is not ensured. This R-VOL cannot be used for disaster recovery at the secondary system. This status is indicated when:</p> <ul style="list-style-type: none"> <li>■ This volume pair was suspended due to a failure that did not affect the entire consistency group and the <b>Error Level</b> pair option for this pair is set to <b>Volume</b>.</li> <li>■ This volume pair was suspended by a user-initiated suspend pair operation with the TC390A <b>Suspend (Async)</b> suspend option set to <b>Volume</b>.</li> </ul>
Group	<p>This TC390A volume pair was suspended along with the other pair in its consistency group. Update sequence consistency between this R-VOL and other R-VOLs in this consistency group is ensured. This R-VOL can be used for disaster recovery at the secondary system after deleting the TC390 volume pair from the RCU. This status is indicated when:</p> <ul style="list-style-type: none"> <li>■ All volume pairs in this consistency group were suspended due to a failure that affected the entire consistency group, not just one pair (for example, MCU-RCU communication failure).</li> <li>■ The volume pair was suspended due to a failure that did not affect the entire group and the <b>Error Level</b> TC390A pair option for this pair is set to <b>Group</b>.</li> <li>■ This volume pair was suspended by a user-initiated suspend pair operation with the TC390A <b>Suspend (Async)</b> suspend option set to <b>Group</b>.</li> </ul>

## Suspended TrueCopy Asynchronous Pairs

TC390A operations involve additional suspension conditions related to the asynchronous recordset operations. Both the MCU and RCU can detect TC390A suspension conditions and suspend TC390A pairs. The following table describes the TC390A suspension conditions and indicates which CU detects the condition and which volume pairs are suspended. The TC390A offloading timer asynchronous option (see [Asynchronous Copy Option](#) on page 859) and timeout group options (see [Adding Consistency Groups \(Add CT Group\)](#) on page 854) are used to control the TC390A suspension conditions. For troubleshooting information for TC390A suspension conditions, see [Table 105](#) on page 931.

**Table 90: TrueCopy Asynchronous suspension conditions**

Suspension Condition	Detected by	TC390A Pairs to be Suspended
The MCU could not send a pending recordset to the RCU before the <b>offloading timer</b> asynchronous option expired. See <a href="#">Inflow Control of Recordsets</a> on page 751.	MCU	All TC390A pairs with M-VOLs in the MCU.
During MCU power-on, the MCU could not establish communication with the RCU before the <b>RCU ready timeout</b> group option expired. See <a href="#">Group Options</a> on page 756.	MCU	All TC390A pairs with M-VOLs in the MCU.
The RCU could not settle a pending recordset before the <b>copy pending timeout</b> group option expired.	RCU	All TC390A R-VOLs in the consistency group.
The RCU could not communicate with the MCU before the <b>copy pending timeout</b> group option expired.	RCU	All TC390A R-VOLs in the consistency group.
The RCU could not receive the recordset successfully due to a hardware failure.	RCU	Only the affected R-VOL.
The RCU detected a logical error while selecting the recordset to be settled.	RCU	All TC390A R-VOLs in the group, or only the affected R-VOL, depending on the failure type and <b>error level</b> TC390A pair option.
The RCU could not settle the recordset due to a hardware failure, a track condition, or a logical error.	RCU	

The MCU stores a cylinder bitmap in cache for each TC390A M-VOL and the RCU stores a cylinder bitmap in cache for each TC390A R-VOL. When a TC390A pair is suspended, the cylinders that contain the following records are marked in the cylinder bitmap as modified (to be copied during the resume pair operation):

- The recordsets that were created by the MCU but not yet sent to the RCU. After marking these cylinders as modified, the MCU discards these recordsets.
- The recordsets that were sent to the RCU but not acknowledged by the RCU. The MCU marks these M-VOL cylinders as modified and discards these recordsets. This ensures that recordsets that are lost during transmission to the RCU are identified and marked.
- The recordsets that reached the RCU but have not yet been settled. After marking these cylinders as modified, the RCU discards these recordsets.

- The M-VOL records updated by host-requested write I/Os after the volume pair was suspended (same function as for TC390 Synchronous pairs).

When a suspended TC390A pair is resumed (resynchronized), the contents of the RCU's cylinder bitmap are sent to the MCU and merged into the MCU's cylinder bitmap. The MCU then performs the resync copy operation according to the merged bitmap. This ensures that all cylinders containing recordsets that were discarded are resynchronized at this time.

## PPRC Support

An XP128/XP1024 with TC390 installed supports IBM PPRC host software functions. You can perform most TC390 operations by issuing PPRC TSO (or ICKDSF PPRCOPY) commands from the host system console to the XP128/XP1024. Using PPRC commands, you can establish and delete remote copy communication paths; establish, suspend, resume, and delete TC390 Synchronous and TC390A pairs/groups; and view TC390 path and pair status. For more information on using PPRC TSO and ICKDSF commands with the XP128/XP1024, see [Using PPRC Commands for TrueCopy](#) on page 933.

For operating systems that do not support PPRC, TC390 through Command View is used to control and monitor TC390 operations. In this case, TC390 provides only state-change-pending (SCP) notifications with service information messages (SIMs).

**Restrictions.** If you plan to use PPRC commands instead of the TC390 software to perform TC390 operations, the following restrictions apply:

- **SVP mode 114** (see [Table 81](#) on page 733) must be enabled to allow automatic port configuration in response to PPRC commands. To fully support an automated environment, the XP128/XP1024 is capable of automatically configuring a serial port as an RCP or LCP, or a Fibre Channel port as an initiator or RCU target port if required in response to the TSO CESTPATH and CDELPATH commands. The XP128/XP1024 will verify that the specified MCU port is offline to the host and will automatically configure it as an RCP or initiator port if required. Similarly, the corresponding RCU port will also be configured as an LCP or RCU target port if required. When the CDELPATH command is issued, the TC390 logical paths are removed, and if there are no more TC390 or TC logical paths on the port, the port is automatically changed from RCP mode to LCP mode, or from initiator port mode to RCU target port mode.

**Note:** For Fibre Channel interface, do not use the CESTPATH and CDELPATH commands at the same time as the SCSI path definition function of LUN Management. The Fibre Channel interface ports need to be configured as initiator ports or RCU target ports before the CESTPATH and CDELPATH commands are issued.

---



**Caution:** Before issuing the CESTPATH command, verify that the relevant paths are offline from the host(s) (for example, configure the Chipid offline, deactivate the LPAR, or block the port in the E5CD). If any active logical paths still exist, the add path operation will fail because the port mode (LCP/RCP) cannot be changed.

---

- You cannot use the PPRC commands to:

**Change the RCU options.** The current default values are: minimum paths = 1, max. initial copy activity = 4, SCP delay time = 120 seconds, incident of RCU = to any host, PPRC support = yes, remote copy service SIM = not report, RIO MIH Time = 15 seconds. The TC390 software must be used to change these options.

**Change the TC390 async options.** The current default values are: sidefile threshold = 50%, offloading timer = 5 minutes. The TC390 software must be used to change these options.

**Configure TC390A consistency groups.** Because each TC390A pair must belong to one group, the TC390 software must be used to add and configure the groups (timer type, copy pending timeout, RCU ready timeout) before you can add any TC390A pairs. After the asynchronous options, groups, and group options are configured, the PPRC commands can be used to control/monitor TC390A pairs.

**Change the initial copy priority.** CFW data option, or DFW to R-VOL option. If CESTPAIR is used to establish a TC390 pair, the following options will be used: initial copy priority = 0, CFW data = copy to R-VOL<sup>1</sup>, and DFW to R-VOL = not required. The TC390 software must be used to change these options.

- 
1. By using Remote Copy Function Switch, you can set the following option with PPRC command: CFW data = only M-VOL. If you want to use this function, please contact your HP account team.

**Note:** The DFW to R-VOL setting does not affect the I/O performance of the M-VOLs. If one side of cache is closed due to an RCU failure, the TC390 copy operation still uses DFW. The only difference between **not required** and **required** is that new pairs cannot be established with the **DFW-to-R-VOL required** option when one side of RCU cache is closed (the add pair operation fails).

---

## P/DAS Support

TC390 Synchronous supports the IBM P/DAS host software function. You can use P/DAS to relocate or migrate data by redirecting all application I/Os from the M-VOL of a TC390 pair to the R-VOL without interrupting access to the data. TC390A does not support P/DAS SWAP.

### Restrictions

- P/DAS does not support CFW operations. You must stop CFW applications before performing P/DAS operations on TC390 volumes.
- P/DAS through channel extenders is not supported.
- P/DAS swap option #2 (switch pair and swap) is supported for P/DAS between the XP128/XP1024 and other XP disk arrays.

Contact your HP account team for the latest information on P/DAS support.

## GDPS Support

TC390 provides remote copy support for IBM's Geographically Dispersed Parallel Sysplex (GDPS) facility. GDPS is an IBM service offering for mirroring data and balancing workload on disk arrays spread across two or more sites up to 40 km (~20 miles) apart. With this support, users who are running IBM Parallel Sysplex systems can take advantage of the XP128/XP1024 suite of remote copy options for data availability.

GDPS operations feature automatic control of groups of PPRC-managed volumes using host-based scripts and PPRC commands (for example, CESTPATH CGROUP option for 2105, CGROUP (FREEZE/RUN) for 3990). GDPS support may have additional installation requirements for the XP128/XP1024 TC390 MCUs and RCUs, depending on XP128/XP1024 microcode levels and Command View software versions. Check the following items with your HP representative:

- SVP modes. For operations in a GDPS environment:
  - Mode 64 must be OFF.

Mode 104 must be ON for 3990 controller emulation (not valid for 2105 emulation).

For more information on XP128/XP1024 SVP modes related to TC390 operations, refer to [Table 81](#) on page 733.

Mode 104 must be set before any TC390 pairs are established in a GDPS environment. If TC390 pairs have already been established, you must delete all pairs and logical paths (CDELPAIR, CDELPATH), change the SSIDs and mode settings on the MCUs and RCUs, and then re-establish the paths and pairs (CESTPATH, CESTPAIR). Installation of mode 64 is nondisruptive and can be performed at any time.

# Preparing for TrueCopy Operations

## System Requirements

TC390 operations involve the XP128/XP1024 MCUs and RCUs containing the main and remote volumes, the remote copy connections between the MCUs and RCUs, the S/390 host(s) at the main and remote sites, and TC390 running through Command View.

The TC390 system requirements are:

- **MCU:** XP128/XP1024 with TC390 installed.
- **RCU:** XP128/XP1024 with TC390 installed.

---

**Note:** Other XP disk arrays with TC390 installed can be used as an RCU connected to an XP128/XP1024 MCU. For assistance with mixed disk array configurations, contact your HP representative.

TC390 can coexist with CA (all copy modes) in the same XP128/XP1024. Full Fibre Channel support will allow concurrent fibre-mode CA and TC390 operations.

The XP128/XP1024 may have additional installation requirements, such as SVP modes, hardware features such as CHF WP411-B, additional cache, and so forth. For more information on XP128/XP1024 SVP modes for TC390, refer to [Table 81](#) on page 733.

---

- **Serial remote copy connections** (see [Serial Remote Copy Connections](#) on page 781):
  - Multimode serial interface (ESCON) cables are required at both the MCU and RCU.
  - For distances from 3 km to 43 km (1.9 to 26.7 miles), single-mode serial interface cables with IBM 9032 or 9033 ESCON directors (ESCDs) and/or 9036 ESCON repeaters are required.
  - For distances greater than 9 km (5.6 miles), the extended distance facility (XDF) provided by the ESCDs and/or ESCON repeaters is required.
  - For distances greater than 43 km (26.7 miles), approved third-party channel extender products and telecommunications lines are required. Long-distance TC390 solutions are provided based on user requirements and workload characteristics.

**Note:** Use of channel extenders may require additional XP128/XP1024 configuration (for example, mode 21).

All serial remote copy activities between two XP128/XP1024s, such as TC390, TC390A, CA Sync, and CA Async, can share the same remote copy connections.

---

■ **Remote copy connections – Fibre Channel** (see [Fibre Remote Copy Connections](#) on page 778):

- Multimode or single-mode optical fibre cables are required at both the MCU and RCU.
- For distances from 0.5 km to 1.5 km (1,640 to 4,920 feet), multimode shortwave Fibre Channel interface cables with up to two switches are required.
- For distances from 10 km to 30 km (6.2 to 18.6 miles), single-mode longwave Fibre Channel interface cables with up to two switches are required.
- For distances greater than 30 km, approved third-party channel extender products and telecommunications lines are required.

■ **S/390 host:** MVS/DFP 3.2.0 + PTF, or VM/ESA 2.1.0 + PTF.

- Optional error recover procedure (ERP) functions require MVS/DFP 3.2.0 or later.
- ICKDSF R16 + PTF functions require VM/ESA 2.1.0 or later.
- If the primary and/or secondary system consists of several CPU complexes, a **SYSPLEX timer** is required to provide a common time reference for the host I/O time-stamping function.
- APAR OW36948 is required for 16-session support for HXRC.

■ **Command View management station and software.** The Command View management station is supplied by the user. The Web browser is required to operate the Command View Java Applet programs. Also, the license key code is required to operate the TC390 software.

---

**Note:** Administrator access to the Command View management station is required to perform TC390 operations. Users without administrator access can only view TC390 information.

---



- **TC390 option(s)** enabled on the XP128/XP1024 and on the Command View management station (see [Installing the TrueCopy Software](#) on page 784).

## Requirements and Restrictions

TC390 has the following requirements and restrictions:

- Track format
- One-to-one volume copy operations
- Duplicate VOLSER (Volume Serial Number)
- Logical volume image (LVI) (also called device emulation or device type)
- Accessing TC390 M-VOLs and R-VOLs
- Cache, NVS, and DASD fast write
- Consistency groups

## Track Format

TC390 has the following disk track format requirements that the user must follow. TC390 cannot detect exceptions to these requirements. The MCU will abort the TC390 initial copy operation if the track format for both the M-VOL and R-VOL does not meet the following requirements:

- The TC390 M-VOL and R-VOL must have the same track format.
- Record zero (R0) must be standard format, with key length of zero and data length of eight. The MCU will abort the initial copy operation if R0 is not standard format.
- The CCHH (logical cylinder address and logical head address) of R0 must be identical to the physical cylinder address and physical head address of the track.
- The CCHH of each user record in a track must be unique.

## One-to-One Volume Copy Operations

TC390 requires a one-to-one relationship between the logical volumes of the volume pairs. A volume can be assigned only to one TC390 pair at a time. TC390 does not support operations in which one M-VOL is copied to more than one R-VOL, or more than one M-VOL is copied to one R-VOL. Because TC390 pairs are created on logical volumes rather than datasets, multivolume datasets require special attention. For complete duplication and recovery of multivolume datasets,

verify that all volumes of a multivolume dataset are copied to TC390 R-VOLs and use TC390A to ensure update sequence consistency across the R-VOLs at the remote site.

## Duplicate VOLSER

The TC390 initial copy operation always copies the VOLSER of the M-VOL to the R-VOL, even if the **No Copy** initial copy option is selected. For this reason, the M-VOL and R-VOL of a TC390 pair must have the same VOLSER. Because the host operating system does not allow duplicate VOLSERS, the host system administrator must take precautions to prevent system problems related to duplicate VOLSERS. For example, the TC390 R-VOLs must be defined in the system generation so they do not come online automatically.



**Caution:** If the volumes that will become TC390 R-VOLs are physically attached to the same system images as the production volumes that will become the TC390 M-VOLs, the following problems can occur:

- When a TC390 pair is established using the TSO CESTPAIR command, the secondary volume might be online. PPRC allows this, but TC390 does not (see the following note). This could produce a duplex secondary online to a host image, the results of which are not predictable.
- When a TC390 pair is deleted, the old secondary volume is usually offline. If a host image is IPL'd, the operator will be offered both volumes and asked which volume should be left offline – the old duplicate volser message. This can be confusing and is prone to error.
- To avoid these problems, HP strongly recommends that the user specify OFFLINE=YES if the secondary volumes are to be generated in the production host's IOCP and system generation.

---

**Note:** If you cannot create a pair because the TC390 R-VOL is online with hosts, all paths must be offline from all hosts. If you cannot identify the hosts that are online, please contact your HP account team.

---

## Logical Volume Image (LVI)

TC390 supports basic mainframe LVIs that can be configured on the XP128/XP1024 (for example, 3390-3, -3R, -9, or -L). TC390 does not support multiplatform volumes (3390-1, -2, -3A/B/C, 3380-K, -E, -J, or -KA/B/C). TC390 can copy data between volumes with the same emulation and capacity (for

example, 3390-3R to 3390-3R), and can also copy from smaller volumes to larger volumes (for example, 3390-3 to 3390-3R) of the same emulation (VTOC expansion must be used). TC390 also supports the Virtual LVI/LUN feature of the XP128/XP1024 to establish TC390 pairs with custom-size LVIs as well as standard-size LVIs. When custom-size LVIs are assigned to TC390 pairs, the R-VOL must have the same or larger capacity than the M-VOL. TC390 displays the LVI of the M-VOLs and R-VOLs.

---

**Note:** The host I/O time-stamping function is not supported by 3380 LVIs. If you plan to use TC390A pairs, the TC390A M-VOLs and R-VOLs must be 3390 LVIs.

In the case that M-VOL or R-VOL is 3390-L LVI under the connection of the disk array, and the number of cylinders is more than 10,017, the capacity of the M-VOL and R-VOL must be the same.

---



**Caution:** If you use TC390 to copy from a smaller volume to a larger volume, you will not be able to perform TC390 operations in the reverse direction (from the secondary site to the primary site) after a disaster has occurred and the secondary site was used for production. This restriction exists because TC390 does not support copying from a larger volume to a smaller volume. HP strongly recommends that this capability (copying from a smaller volume to a larger volume) only be used for data migration purposes.

---

## Accessing TrueCopy M-VOLs and R-VOLs

Write operations to a TC390 M-VOL that specify normal authorization are duplicated on the R-VOL of the TC390 pair. Write operations with diagnostic or device support authorization, such as ICKDSF, are completed at the M-VOL but are not duplicated at the R-VOL. Therefore, you must suspend a TC390 volume pair before performing ICKDSF media maintenance on the M-VOL. For instructions on running ICKDSF on TC390 volumes, see [ICKDSF Considerations for TrueCopy Volumes](#) on page 905.

To ensure maximum data integrity during normal TC390 operations, the RCU rejects all read and write operations issued by a host to a TC390 R-VOL. If you need read-only access to a TC390 R-VOL, you must have the R-VOL read option (see [R-VOL Read Option](#) on page 746) enabled on the RCU and you must suspend the pair to read the R-VOL. The R-VOL read option can be enabled by the HP representative only. If you need write access to a TC390 R-VOL (for

example, to perform ICKDSF), you must delete the pair from the RCU to change the R-VOL pair status to *simplex*. For instructions on running ICKDSF on TC390 volumes, see [ICKDSF Considerations for TrueCopy Volumes](#) on page 905.

## Cache, NVS, and DASD Fast Write

Cache and nonvolatile storage (NVS) must be operable for both the MCU and RCU of a TC390 volume pair. If not, the Add Pair operation will fail. The remote disk array cache should be configured to adequately support the TC390 remote copy workloads as well as any local workload activity.

DASD fast write (DFW) is required at the MCU and RCU only when the **DFW-to-R-VOL required** TC390 pair option (see [Creating TrueCopy Volume Pairs \(Add Pair\)](#) on page 880) is specified. If DFW to an R-VOL is blocked and the TC390 pair was established with the **DFW-to-R-VOL required** pair option, the MCU detects DFW OFF at the R-VOL and suspends the pair. TC390 pairs that were established using PPRC commands use the default value of **not required** and therefore are not suspended when DFW to the R-VOL is blocked.

---

**Note:** The DFW to R-VOL setting does not affect the I/O performance of the M-VOLs. If one side of cache is closed due to an RCU failure, the TC390 copy operation still uses DFW. The only difference between **not required** and **required** is that new pairs cannot be established with the **DFW-to-R-VOL required** option when one side of RCU cache is closed (the add pair operation fails).

---

## Consistency Groups

The TC390A consistency groups have the following requirements:

- All TC390A pairs must be assigned to one and only one consistency group.
- The maximum number of volume pairs in one consistency group is 4,096 (entire RCU).
- The maximum number of consistency groups established for one MCU-RCU pair is 128. The RCU supports a maximum of 128 groups. This limit of 128 groups includes both TC390A groups and TC Asynchronous groups (for example, 64 TC390A + 64 CA Asynchronous).
- Each update I/O to the M-VOLs in one consistency group must be time-stamped using a common timer facility. The primary host system cannot access volume pairs of the same consistency group if the pairs do not have a common timer reference.

- A consistency group must consist of TC390A pairs or CA Asynchronous pairs, but not both.

## Installing the TrueCopy Hardware

Initial installation of the TC390 hardware is planned and performed by the user and the HP representative. To install the hardware required for TC390 operations:

1. **User:** Identify the TC390 M-VOLs and R-VOLs (main and remote volumes) so that the TC390 hardware can be installed and configured properly.
2. **User:** On the host operating system, verify that the missing interrupt handler (MIH) value (also called host I/O patrol time) is set high enough to accommodate the number of volume pairs, the cable length between the MCUs and RCUs, and the initial copy pace. The recommended MIH value for TC390 operations is 60 seconds. For MVS, the MIH value is specified in the SYS1.PARMLIB file.

---

**Note:** The recommended MIH value for HXRC is different than for TC390. If you are performing TC390 and HXRC on the same XP128/XP1024 (or other XP disk arrays) at the same time, contact your HP representative for assistance.

---

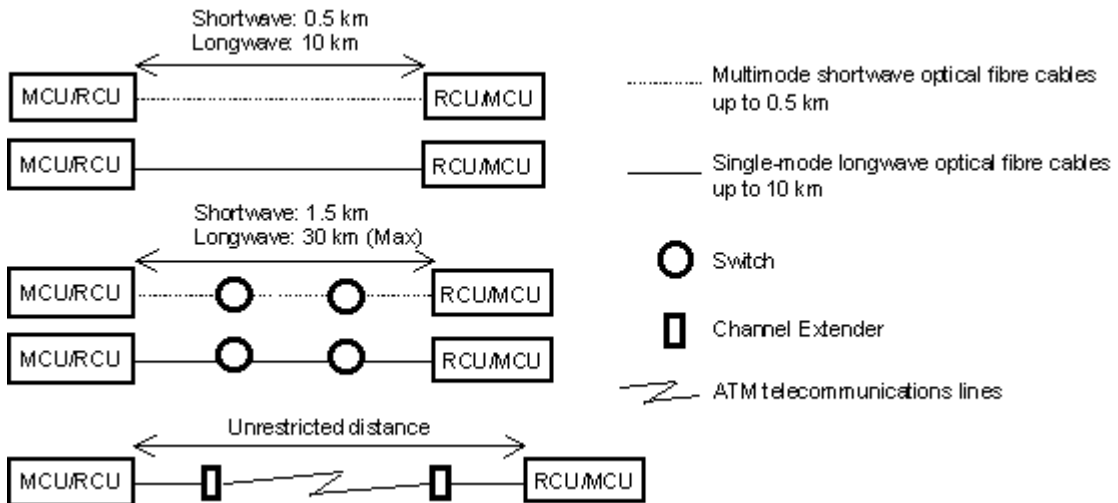
3. **User and HP Representative:** Install the Command View management station near the TC390 MCU(s) and connect the Command View management station to the TC390 MCU(s) through the LAN. HP recommends that you also install a Command View management station connected to the RCUs at the remote site.
4. **HP Representative:** Enable TC390 on all MCUs and RCUs. Verify that the cache, NVS, and DFW of the MCUs and RCUs are properly configured for TC390 operations. See [Cache, NVS, and DASD Fast Write](#) on page 776. If the user plans to perform TC390A and/or HXRC operations in the same disk array, make sure to install adequate cache to handle the increased sidefile usage. When determining the required amount of cache, you must also consider the amount of Cache LUN XP data to be stored in cache.
5. **HP Representative:** Verify that the necessary SVP modes are enabled. See [Table 81](#) on page 733.
6. **HP Representative:** Verify the MCUs are configured to report sense information to the host(s). The RCUs should also be attached to a host processor to enable reporting of sense information in case of a problem with

an R-VOL or RCU. If the remote site is unattended, the RCUs should be attached to a host processor at the main site so that the system administrator can monitor the operational condition of the RCUs.

7. **HP Representative:** For serial interface connections, install the serial port adapter features. For example, the DKC-F410I-8S serial 8-port adapter (pair of 4-port CHE cards, 1 card per cluster) provides eight ESCON links. If the MCU and RCU are multiplatform disk arrays, there may be available serial interfaces and additional serial port adapter features may not be required. For Fibre Channel interface connections, install the Fibre Channel adapter features (CHF P/K (WP411-B)).
8. **HP Representative:** If the user plans to use the **Local** TC390A timer type option, set the SVP clock to local time so that the TC390A timestamps will be correct.
9. **HP Representative:** Install the TC390 remote copy connections between the MCU(s) and RCU(s). This hardware (ESCON cables, ESCON directors, optical fibre cables, switches, and so forth) is supplied by the user. For remote copy configurations, see [Serial Remote Copy Connections](#) on page 781. Distribute the paths between different storage clusters and ESCDs or switches to provide maximum flexibility and availability. The logical paths between the MCU and RCU must be separate from the logical paths between the host and RCU. For serial interface connections, all remote copy activities between two XP128/XP1024s, such as TC390, TC390A, CA Sync, and CA Async, can share the same remote copy connections. For Fibre Channel interface connections, only TC390 activities (Sync and Async) can share the same fibre remote copy connections (future support will eliminate this restriction). For information on using channel extenders, see [Channel Extenders for Serial Remote Copy Connections](#) on page 784.

## Fibre Remote Copy Connections

The following figure shows the remote copy connection configurations for Fibre Channel interface TC390 operations. The MCU and RCU of each TC390 pair must be connected through multimode shortwave or single-mode longwave optical fibre cables. If you use multimode shortwave optical fibre cables, fibre cables up to 1.5 km in length and up to two switches are required for distances greater than 0.5 km. If you use single-mode longwave optical fibre cables, fibre cables up to 30 km in length and up to two switches are required for distances greater than 10 km. TC390 operations can be performed at distances of up to 30 km (18.6 miles) using standard single-mode longwave support. Long-distance solutions are provided using approved channel extenders and communication lines.



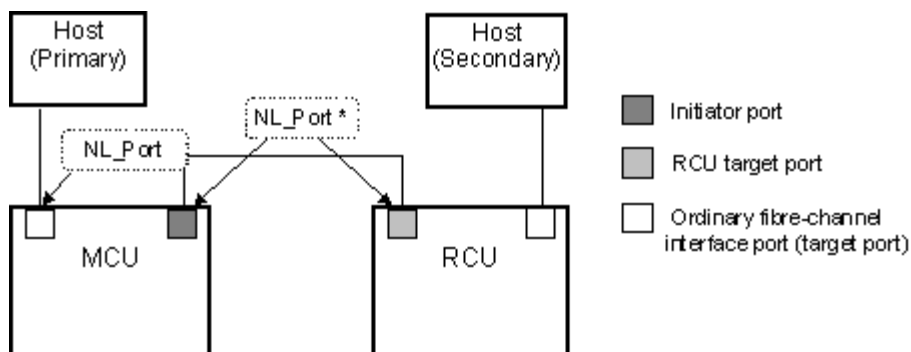
**Figure 293: Fibre Channel remote copy connection configurations**

**Note:** For Fibre Channel interface connections, you can use the switches as for ordinary switch connections and no special settings are required for the XP128/XP1024.

Fibre Channel interface connection provides three different configurations:

- **Direct connection:** Two devices are connected directly together.

In the following figure: \* To set ports, use LUN Management and set port topology to: Fab off, FC-AL.

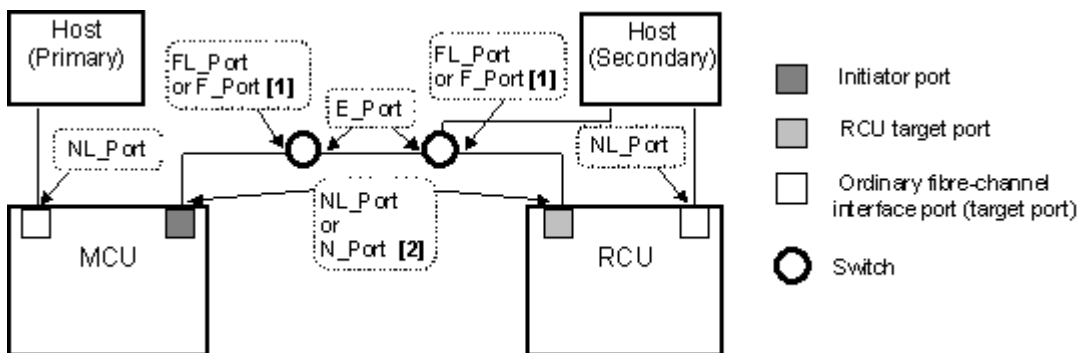


**Figure 294: Fibre Channel interface direct connection (NL port)**

- **Switch connection:** Up to three optical fibre cables are connected together through the switches to connect the devices. Up to two switches can be used.

In the following figure:

1. Some switch vendors require F port (for example, McData ED5000).
2. To set ports, use LUN Management and set port topology to:
  - NL port: Fab on, FC-AL
  - N port: Fab on, Point-to-Point



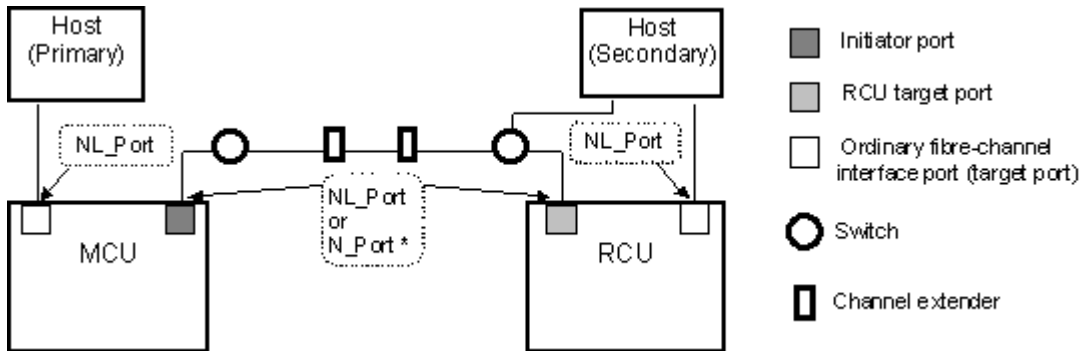
**Figure 295: Fibre Channel interface switch connection (FL port or F port)**

- **Extender connection:** Channel extenders and switches are used to connect the devices across large distances.

In the following figure: \* To set ports, use LUN Management and set port topology to:



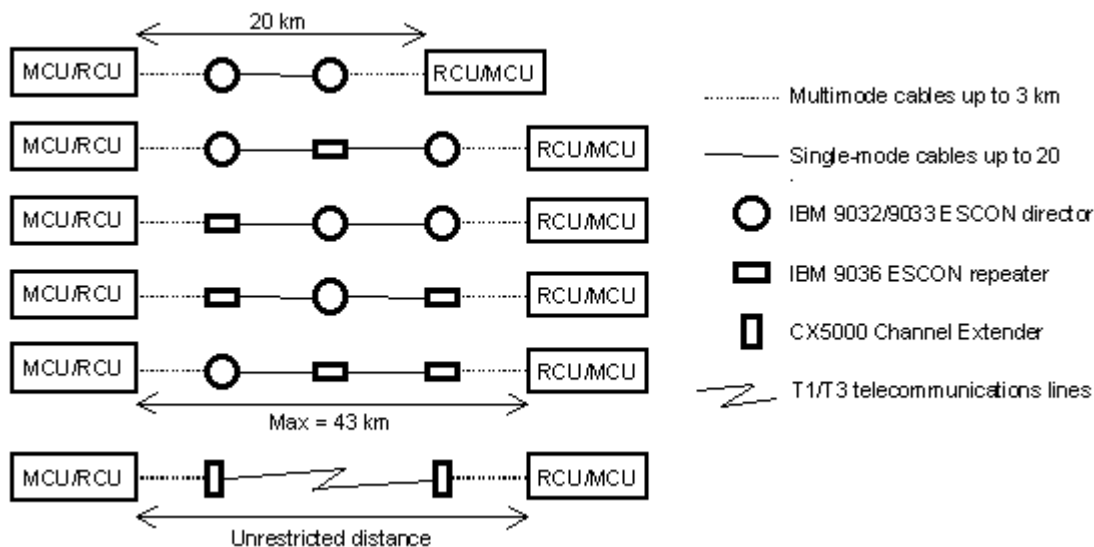
- NL port: Fab on, FC-AL
- N port: Fab on, Point-to-Point



**Figure 296: Fibre Channel interface extender connection**

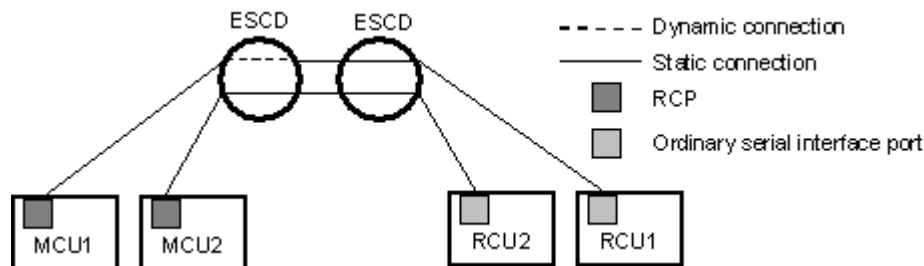
## Serial Remote Copy Connections

The following figure shows the TC390 serial remote copy connection configurations. The MCU and RCU of each TC390 pair must be connected through multimode ESCON cables. For distances greater than 3 km, single-mode cables up to 20 km in length and IBM 9032/9033 ESCDs and/or 9036 ESCON repeaters are required. Dedicated ESCON channels may be installed, or existing ESCON channels connected by ESCDs may be used. The IBM 9032/9033 ESCD supports the extended distance facility (XDF), which uses single-mode ESCON cables up to 20 km. The IBM 9036 ESCON repeater supports single-mode-to-single-mode connection or single-mode-to-multimode connection. When TC390 disk arrays are more than 9 km apart, the XDF connections provided by the ESCDs or ESCON repeaters are required. TC390 operations can be performed at distances of up to 43 km (26.7 miles) using standard ESCON support. Long-distance solutions are provided, based on user requirements and workload characteristics, using approved channel extenders and communication lines.



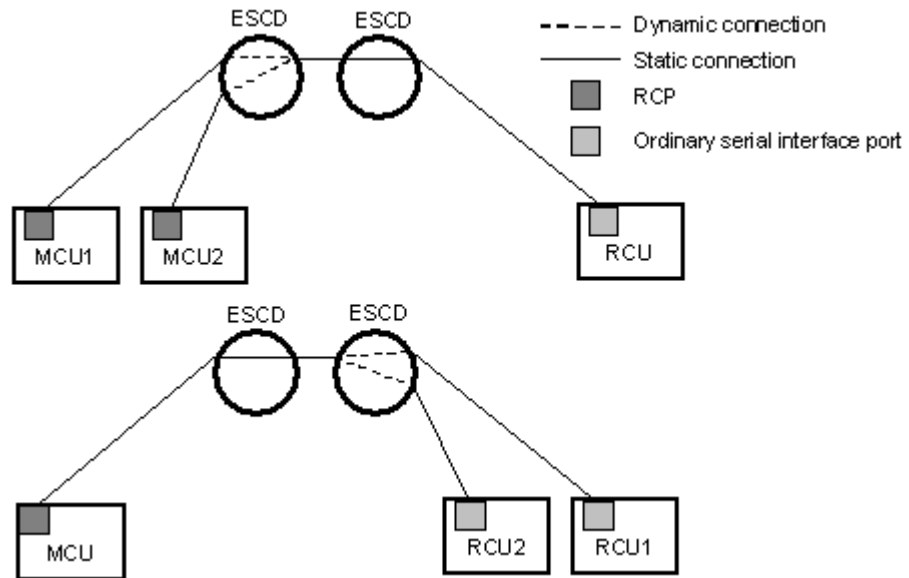
**Figure 297: Serial remote copy connection configurations**

The ESCDs can accommodate multiple MCU-RCU remote copy connections.



**Figure 298: N pairs of remote copy connections**

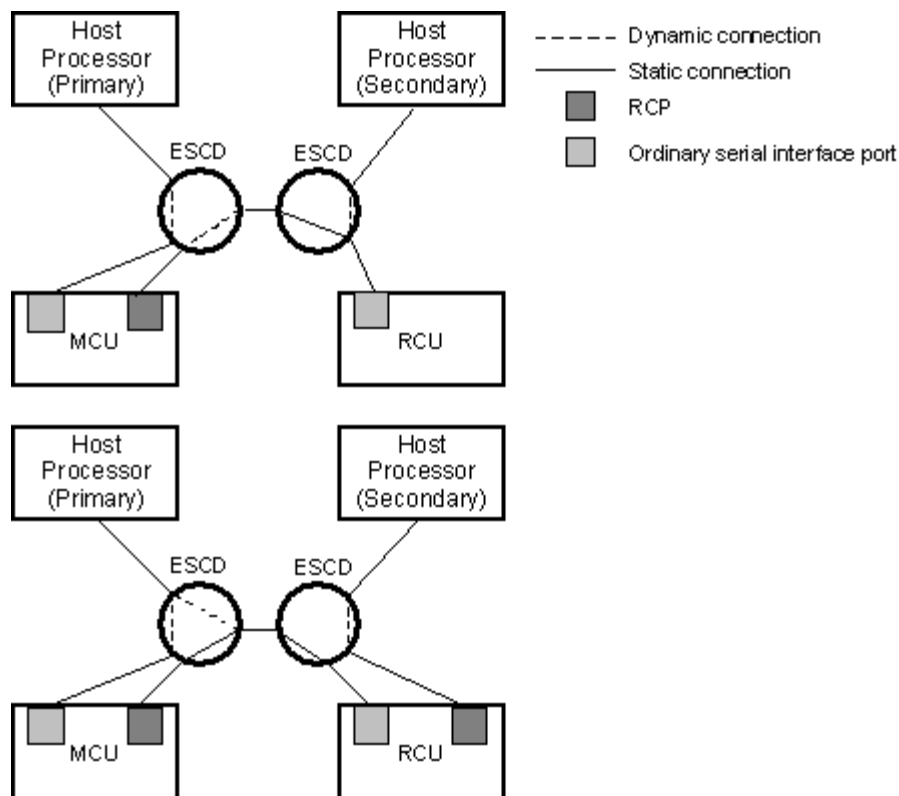
N-to-1 or 1-to-n remote copy connections ( $n \leq 4$ ) can also be configured by using the dynamic switching capability of the ESCDs to share the physical interface cables between the components.



**Figure 299: N-to-1 and 1-to-n remote copy connections ( $n \leq 4$ )**

**Note:** 1-to-n configurations (one main disk array and multiple remote disk arrays) are valid for TC390A, as long as a consistency group does not span remote disk arrays.

In addition, the ESCDs can accommodate channel-to-MCU and channel-to-RCU connections in addition to the remote copy connections.



**Figure 300: Remote copy connections shared with channel-to-RCU connections**

## Channel Extenders for Serial Remote Copy Connections

TC390A can be integrated with third-party channel extender products to provide remote data backup for distances greater than 43 km. Contact your HP account team for the latest information on channel extender support for TC390.

## Installing the TrueCopy Software

The user installs the software required for TC390 operations on the Command View management station.

### To install the TC390 software:

1. Install the Command View software on the Command View management station that is connected to the TC390 disk array(s).

2. Add each TC390 disk array to the Command View management station.
3. Enable the TC390 options on the Command View management station and on each TC390 disk array.

## Configuring the MCUs and RCUs for TrueCopy Operations

After you have installed the TC390 hardware and software, you can configure the MCUs and RCUs for TC390 operations. The configuration depends on the interface type of the remote copy connections, serial or Fibre Channel.

---

**Note:** At this time serial interface and Fibre Channel interface configurations cannot coexist for the same MCU. Future support is planned.

Serial interface connection is not supported for this version.

---

### Serial Interface Configuration


#### To configure the MCUs and RCUs for serial-interface TC390 operations:

1. Identify the volumes that will become the TC390 M-VOLs and R-VOLs. You need to know the disk array S/N, SSID, and CU image of each TC390 volume so that you can configure the MCUs and RCUs correctly for the appropriate pairs and async groups. When you create the pairs, you will need to know the port, group ID, and LUN of each volume.
2. Connect to the disk array that you want to configure as a TC390 MCU.

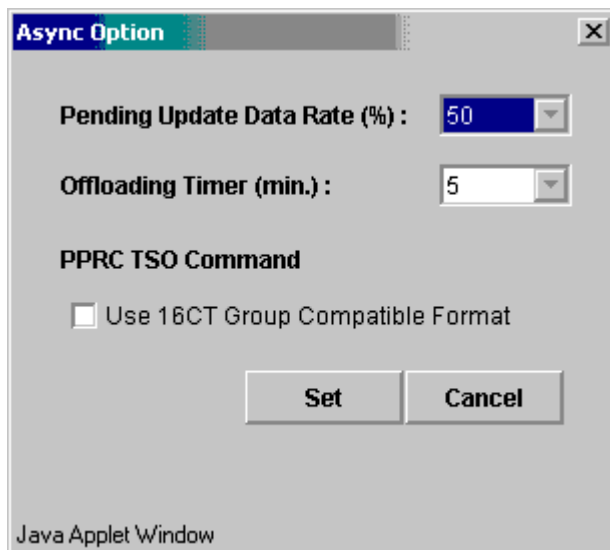
---

**Note:** You must operate the Command View management station in Modify mode to perform TC390 operations. Users in view mode can only view TC390 information.

---

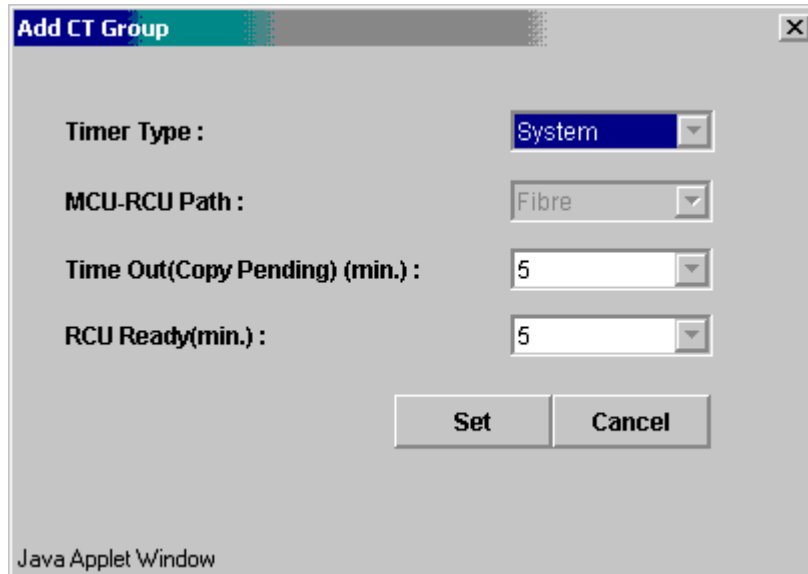
3. From the Identity screen, click the **Mainframe** tab, and then click the **TrueCopy** button () to start the TC390 software. The TrueCopy main screen is displayed and the **Pair Operations** tab is displayed at the top.
4. Configure the serial interface ports that are connected to the RCUs as RCPs by the Port Change operation.
5. Register the RCU(s) to the current MCU CU image using the Add RCU window and set the options for the registering RCU using the RCU Option window. For additional instructions, see [Registering an RCU \(Add RCU\)](#) on page 830.

6. If you plan to create TC390A pairs with M-VOLs in this MCU, configure the MCU async options as shown in the following figure. For additional instructions, see [Asynchronous Copy Option](#) on page 859.



**Figure 301: Setting the Async options**

Then register the consistency group to the MCU as shown in the following figure. For additional instructions, see [Adding Consistency Groups \(Add CT Group\)](#) on page 854.



**Figure 302: Adding the consistency groups**


7. When you are finished configuring this MCU, exit the TrueCopy main screen and close Command View.
8. Repeat [step 2](#) - [step 7](#) for each disk array that will function as a TC390 MCU. After you have configured the MCUs, registered the RCUs, and configured the TC390 Async options and consistency groups, you are ready to begin TC390 volume pair operations.

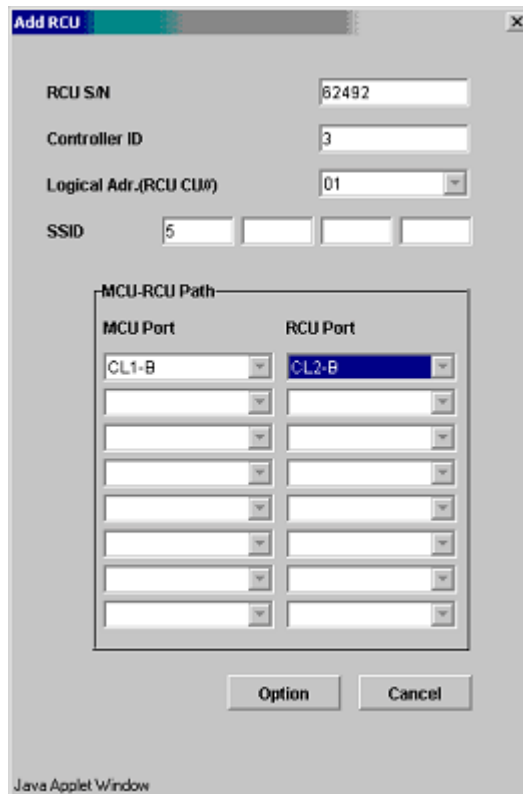
## Fibre Channel Interface Configuration

### To configure the MCUs and RCUs for TC390 Fibre Channel operations:

1. Identify the volumes that will become the TC390 M-VOLs and R-VOLs. You need to know the disk array S/N, SSID, and CU image of each TC390 volume so that you can configure the MCUs and RCUs correctly for the appropriate pairs and async groups. When you create the pairs, you will need to know the port, target ID, and LUN of each volume.
2. Connect to the disk array that you want to configure as a TC390 MCU.

**Note:** You must operate the Command View management station in Modify mode to perform TC390 operations. Users in view mode can only view TC390 information.

3. Click the **Mainframe** tab, and then click the **TrueCopy** button (  ) to start the TC390 software. The TrueCopy main screen is displayed and the **Pair Operations** tab is displayed at the top.
4. Configure the Fibre Channel interface ports that are connected to the RCUs as Initiators by the Port Change operation.
5. Register the RCU(s) to the current MCU CU image using the Add RCU window.



**Figure 303: Add the RCUs (for Fibre)**



Set the options for the registering RCU using the RCU Option window as shown in the following figure. For additional instructions, see [Registering an RCU \(Add RCU\)](#) on page 830.



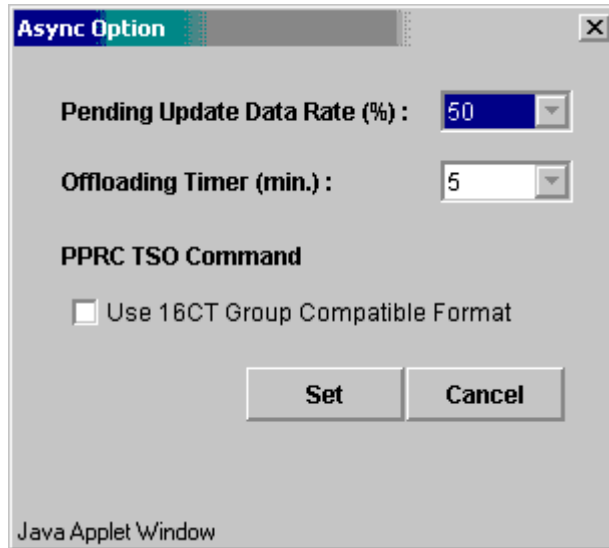
The screenshot shows a dialog box titled "RCU Option" with a close button (X) in the top right corner. The dialog contains several configuration options, each with a text input field or a dropdown menu:

- Minimum Paths : 1
- Maximum Initial Copy Activities : 4
- SCP Delay Time : 120
- RIO MIH Time (sec.) : 15
- Path Blockade Watch (sec.): 40
- Incident of RCU : to any host
- PPRC support by host : No
- Services SIM of Remote Copy : Not Report
- FREEZE option : Disable

At the bottom of the dialog, there are two buttons: "Set" and "Cancel". The text "Java Applet Window" is visible at the bottom left of the dialog box.

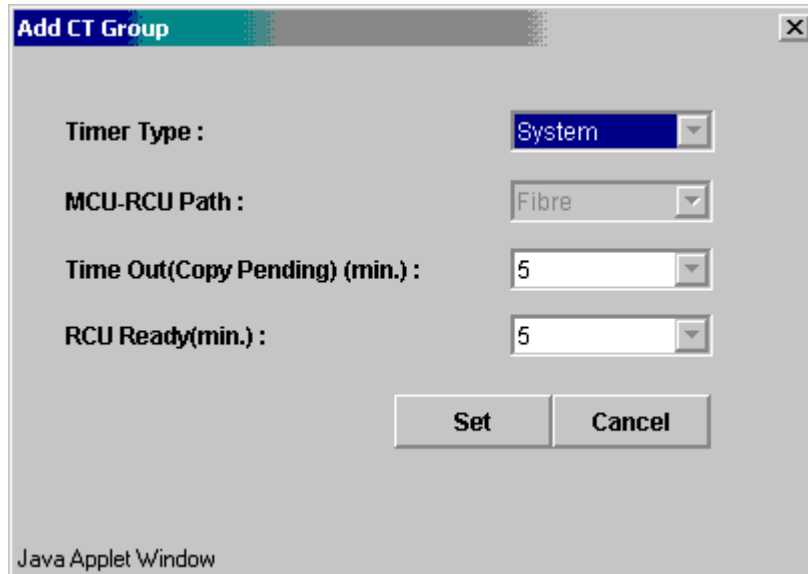
**Figure 304: Configuring the RCU options**

6. If you plan to create TC390A pairs with M-VOLs in this MCU, configure the MCU async options as shown in the following figure. For additional instructions, see [Asynchronous Copy Option](#) on page 859.



**Figure 305: Setting the Async options**

Then register the consistency group(s) to the MCU as shown in the following figure. For additional instructions, see [Adding Consistency Groups \(Add CT Group\)](#) on page 854.



**Figure 306: Adding the consistency groups**

7. When you are finished configuring this MCU, exit the TrueCopy main screen and close Command View.
8. Repeat [step 2](#) - [step 7](#) for each disk array that will function as a TC390 MCU. After you have configured the MCUs, registered the RCUs, and configured the TC390 Async options and consistency groups, you are ready to begin TC390 volume pair operations.

## Combining TrueCopy with Other Data Management Operations

TC390 supports concurrent operations with the following data management functions:

- **Virtual LVI/LUN.** Virtual LVI/LUN volumes can be assigned to TC390 pairs as long as the R-VOL has the same or larger capacity than the M-VOL. If you need to perform Virtual LVI/LUN operations on an existing TC390 M-VOL or R-VOL, you must delete the pair first to return the volume to *simplex* status.
- **Cache LUN XP.** Cache LUN XP volumes can be assigned to TC390 pairs and Cache LUN XP operations can be performed on TC390 M-VOLs and R-VOLs.

- **SANtinel - S/390.** SANtinel operations do not affect TC390 operations. Secure volumes can be assigned to TC390 pairs, and TC390 volumes can be assigned to secure ports and/or groups for SANtinel operations.

---

**Note:** TC390 R-VOLs cannot be accessed by any host except when the pair is split.

---

- **HXRC.** The XP128/XP1024 is functionally compatible with the IBM Extended Remote Copy (XRC) function. See [Table 91](#) on page 793.
- **SI390.** SI390 volumes can be assigned to TC390 pairs and TC390 volumes can be assigned to SI390 pairs. For information on TC390 and SI390 shared volume configurations, see [Combining TrueCopy with Other Data Management Operations](#) on page 791. This configuration requires at least one external ESCON or fibre cable loop.

---

**Note:** When TC390 and SI390 are both active on the same XP128/XP1024, TC390 cannot be used to copy within that disk array. SI390 is recommended for disk array-internal copy. If SI390 is not active, TC390 Synchronous supports intra-disk array copy and requires at least one external ESCON cable loop.

---

- **Prioritized Port Control.** The initiator ports in the MCU do not support the Prioritized Port/WWN Control option because they are dedicated for TC390 operations.

---

**Note:** When TC390 and CA coexist in the same XP128/XP1024, each consistency group must contain either TC390A pairs or CA Asynchronous pairs (not both), and TC390A and CA Asynchronous share the same cache sidefile area.

---

**Combining TC390 and HXRC.** The following table shows the requirements and restrictions for combining TC390 and HXRC operations on the same XP128/XP1024 device.

**Table 91: Requirements and restrictions for combining TrueCopy and HXRC**

Combination allowed?	TC390 M-VOL	TC390 R-VOL	HXRC Primary	HXRC Secondary
TC390 M-VOL	--	No	Yes for TC390 Sync No for TC390 Async	Yes
TC390 R-VOL	No	--	No	No
HXRC Primary	Yes for TC390 Sync No for TC390 Async	No	--	Yes <sup>1</sup>
HXRC Secondary	Yes	No	Yes <sup>1</sup>	--

1. An XP128/XP1024 volume that is an HXRC secondary device cannot also be an HXRC primary in the same XRC session, but it can be an HXRC primary device in another XRC session.

## Combining TrueCopy and ShadowImage

TC390 and SI390 can be used together in the same disk array and on the same volumes to provide multiple copies of data at the main and/or remote sites. The following table describes the host pair status reporting for TC390 volumes, SI390 volumes, and TC390/SI390 shared volumes. [Table 93](#) on page 794 shows the currency of the data on a shared TC390/SI390 volume based on TC390 and SI390 pair status.

- For shared TC390/SI390 volumes, the TC390 pair status is reported to the host if you query the R-VOL. To obtain the SI390 pair status, query the target volume (T-VOL) of the pair.
- SI390 supports multiple target volumes (T-VOLs) for each source volume (S-VOL). If you issue a pair status query to an SI390 S-VOL (for example, CQUERY), the status for only one SI390 pair is reported (the pair with the T-VOL with the lowest LDEV ID). To obtain the pair status for the SI390 pair(s) with the other T-VOL(s), you must direct the host query to the specific T-VOL using the T-VOL's LDEV ID in the host command (for example, CQUERY DEVN parameter). SI390 through Command View displays the LDEV ID and SI390 pair status of all T-VOLs associated with an S-VOL.

**Table 92: Host pair status reporting for TrueCopy/ShadowImage shared volumes**

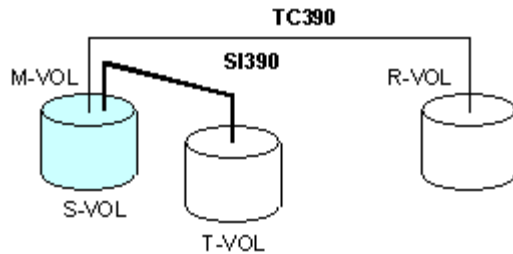
Number of TC390 Pairs	Number of SI390 T-VOLs	Pair Status Reported by XP128/XP1024
0	0	Simplex
0	1	SI390 pair status
0	2 or more	ShadowImage pair status for the pair whose T-VOL has the lowest LDEV ID
1	0	TC390 pair status
1	1	TC390 pair status
1	2 or more	TC390 pair status

**Table 93: Data currency of a shared TrueCopy/ShadowImage volume**

TC390 Pair Status	ShadowImage Pair Status					
	Pending Duplex	Duplex	Split-Pending	Split	Resync	Suspended
Pending Duplex	Not current	Not current	Not current	CURRENT	Not current	Not current
Duplex	Not current	Not current	Not current	CURRENT	Not current	Not current
Suspended	Not current	CURRENT	CURRENT	CURRENT	CURRENT	Not current

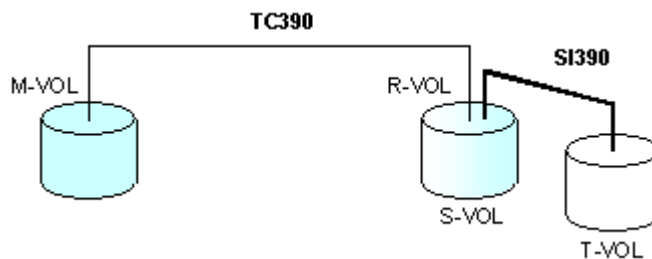
The following figures show the various TC390/ShadowImage configurations that share volumes. TC390 supports synchronous and asynchronous operations for shared volumes. The following figure shows an example of a volume that is functioning as both a TC390 M-VOL and a ShadowImage S-VOL. With this configuration, you can:

- Use TC390 to provide remote backup copies of SI390 S-VOLs.
- Use SI390 to provide on-site backup copies of TC390 M-VOLs.



**Figure 307: TrueCopy and ShadowImage: shared M-VOL/S-VOL**

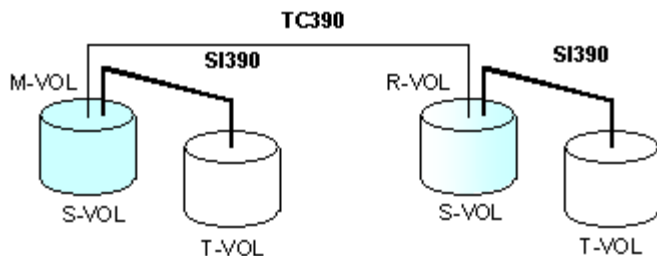
The following figure shows an example of a volume that is functioning as both a TC390 R-VOL and an SI390 S-VOL. With this configuration, you can use SI390 to provide additional remote copies of TC390 M-VOLs. This configuration is not allowed when At-Time Split is used on SI390.



**Figure 308: TrueCopy and ShadowImage: shared R-VOL/S-VOL**

The following figure shows an example of a volume that is functioning as both a TC390 M-VOL and an SI390 S-VOL, while the R-VOL of the same TC390 pair is also functioning as the S-VOL of another SI390 pair. With this configuration, you can:

- Use TC390 to provide remote backup of SI390 S-VOLs.
- Use SI390 to provide on-site backup copies of TC390 M-VOLs and R-VOLs.



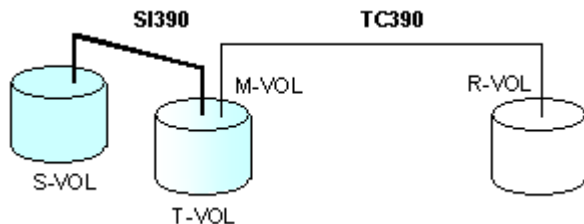
**Figure 309: TrueCopy and ShadowImage: shared M-VOL/S-VOL and R-VOL/S-VOL**

The following figure shows an example of a volume functioning as both a TC390 M-VOL and an SI390 T-VOL.

---

**Note:** This configuration does not allow SI390 and TC390 to copy at the same time. Create the SI390 pair first, and then split the pair before creating the TC390 pair. You must suspend the TC390 pair to resync the SI pair.

---




**Figure 310: TrueCopy and ShadowImage: shared M-VOL/T-VOL**



## Starting TrueCopy

You must operate the Command View management station in Modify mode to perform TC390 operations. Users in view mode can only view TC390 information.

### To access TC390:

1. From the Launch screen, click an XP128 or XP1024.
2. Click the **Mainframe** tab, and then click the **TrueCopy** button (  ). The TrueCopy main screen is displayed and the **Pair Operations** tab is displayed at the top.

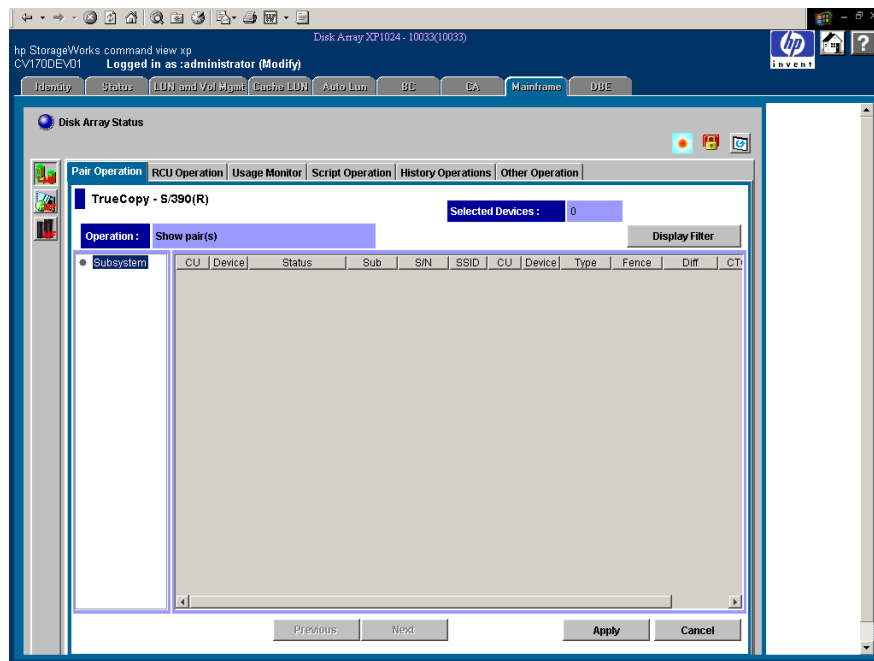


Figure 311: TrueCopy main screen



**Caution:** Do not perform TC390 operations using the TrueCopy main screen while the TC390 scripting function is being executed. To perform TC390 operations on the TrueCopy main screen, wait until the script is complete or verify that the script in execution is aborted.

## Performing TrueCopy Configuration Operations

The TC390 configuration operations include the MCU operations, RCU operations, TC390A control operations, discontinuing TC390 operations, and scripting. The TrueCopy main screen (see page 799) provides access to all TC390 configuration operations.

**RCU operations.** The RCU operations (see page 822) configure the RCUs for TC390 operations:

- Configuring host interface ports for MCU-RCU connection
- Adding the RCUs
- Setting the RCU options
- Adding/deleting logical paths to an RCU
- Adding/deleting SSIDs for an RCU
- Viewing RCU status
- Deleting RCUs

**Asynchronous operations.** The TC390A control operations (see page 850) configure the TC390A groups and options:

- Setting the async options
- Adding consistency group
- Viewing consistency group status
- Changing the consistency group options
- Changing the async options
- Deleting consistency groups

**Usage Monitor operations.** Use the usage monitor operations (see page 862) to collect the I/O statistics for the LDEVs on the disk array.

**Script operations.** Use the scripting function to specify and execute a series of TC390 operations without having to issue commands separately (see page 867).

**History operations.** Use the history operations (see page 867) to export the remote copy history file.

**Other operations.** The other operations (see page 867) include clearing SIMs.

You can optimize TC390 operations and XP128/XP1024 performance by selecting the TC390 settings and options for your operational environment and also by addressing conditions that can affect disk array performance. For more information, see [Optimizing TrueCopy Operations and Disk Array Performance](#) on page 868.

To discontinue TC390 operations, perform the required TC390 operations (for example, pair deletion, RCU deletion, port reconfiguration, and so forth) in a specific order to ensure smooth operations and avoid command rejects and error conditions. For more information, see [Discontinuing TrueCopy Operations](#) on page 870.

## TrueCopy Main Screen

To access any of the TrueCopy screens, click one of the following tabs: **Pair Operations**, **RCU Operations**, **Asynchronous Operations**, **Usage Monitor**, **Script Operations**, **History Operations**, and **Other Operations** tabs.

The TrueCopy main screen (also known as the Pair Operations screen) is displayed by clicking the **Pair Operations** tab. This screen shows the information for the selected CU image of the connected disk array and provides access to all TC390 functions.

The following table shows the TC390 functions of each tab. The function menus can be displayed by right-clicking the list. To apply the settings you made on the TC390 function tabs, click **Apply**.

**Table 94: TC390 functions**

Tab	Menu Command	Description
Pair Operations	Pair Status	Displays the CU information, path information, pair status, and settings information of the TC390 pairs.
	Add Pair > Synchronous	Sets new TC390 Synchronous pairs.
	Add Pair > Asynchronous	Sets new TC390A pairs.
	Delete Pair	Deletes the TC390 pairs that are already set.
	Suspend Pair	Suspends the TC390 pairs.
	Resume Pair	Resumes the TC390 pairs that are suspended.
	Change Pair Option	Modifies the pair options that are originally set (Fence level or Error level).
	Snapshot	Create the new snapshot file.

**Table 94: TC390 functions (Continued)**


Tab	Menu Command	Description
RCU Operations	RCU Status	Displays the RCU status and TC390 port numbers that are already set.
	RCU Operation > Add RCU	Registers the RCU at the remote disk array. RCU controls the R-VOL of the TC390 volume pair.
	RCU Operation > Delete RCU	Deletes the RCU that is already registered.
	RCU Operation > Change RCU Option	Modifies the options for RCUs that are already registered.
	Edit SSID(s) & Path(s) > Add Path	Adds the paths to RCUs.
	Edit SSID(s) & Path(s) > Delete Path	Deletes the paths to RCUs.
	Edit SSID(s) & Path(s) > Add SSID	Adds the SSIDs of RCUs that are connected to MCU.
	Edit SSID(s) & Path(s) > Delete SSID	Deletes the SSIDs of RCUs that are already connected to MCU.
	Port	Sets or changes the port type at the MCU (Target, RCU Target or Initiator).
Asynchronous Operations	Async Option	Sets and modifies the asynchronous copy options.
	CT Group Operation > CT Group Status	Displays the information of the consistency groups that are already registered.
	CT Group Operation > Add CT Group	Assigns the CUs to the consistency groups.
	CT Group Operation > CT Group Option	Modifies the settings for the consistency groups that are already assigned.
	CT Group Operation > Delete CT Group	Deletes the consistency groups that are already assigned.
Usage Monitor	-	Obtains the I/O statistics using the Remote Copy Monitoring function.
Script Operations	-	Uses the script function.
History Operations	-	Displays the operation history of TC390 volume pairs.
Other Operations	Clear SIM	Clears all the remote copy SIMs.

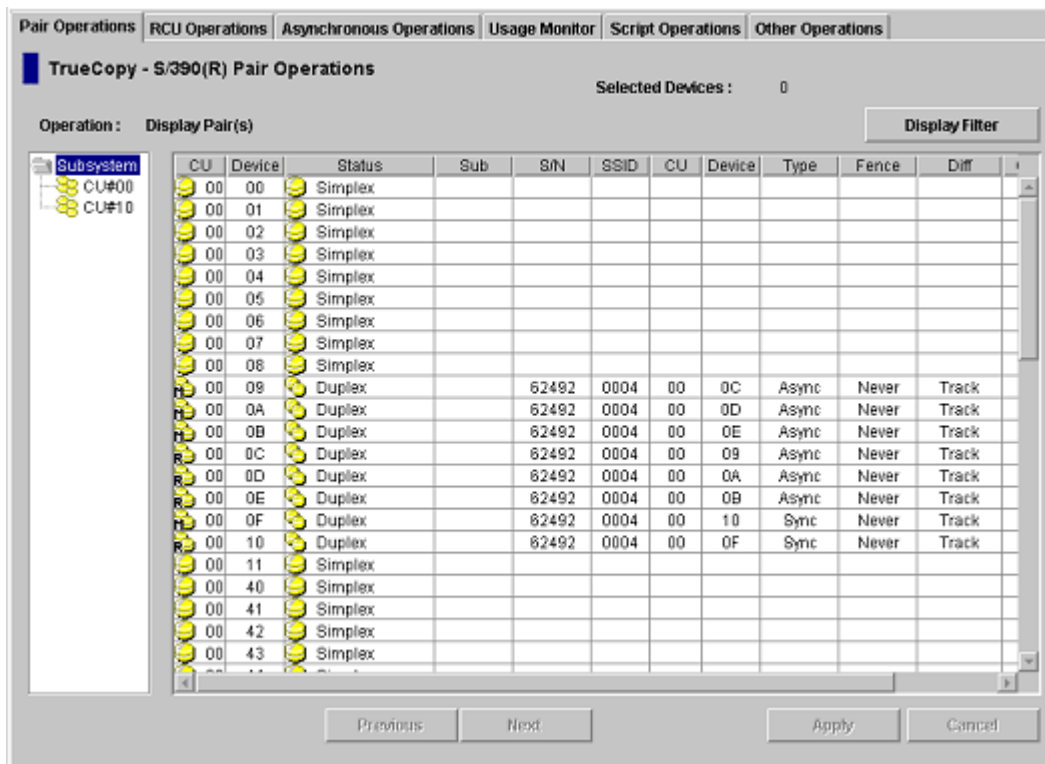
The following sections describe the configuration of each tab and how to use the tabs to operate the TC390 functions (see [Performing TrueCopy Pair Operations](#) on page 872 for TC390 volume pair configuration).

## TrueCopy Main Screen (Pair Operations Screen)

The first screen that is displayed after clicking the **TrueCopy** button is the TrueCopy main screen, also known as the Pair Operations screen. To display this screen at any time, click the **Pair Operations** tab from any of the other TrueCopy screens.

The TrueCopy main screen displays information for the selected CU image of the connected disk array. From this screen, you can configure the volume pairs. This section describes the components of the TrueCopy main screen. For the information about the TC390 volume pair configuration, see [Performing TrueCopy Pair Operations](#) on page 872.

Information displayed on the TrueCopy main screen is updated when the TrueCopy main screen is opened, when the tab is switched from one to another, and when the **Refresh** button () is clicked.



**Figure 312: TrueCopy main screen (Pair Operations screen)**

The TrueCopy main screen consists of the CU Number tree, the Volume list (see [Volume List](#) on page 803), the **Display Filter** button (see [Display Filter](#) on page 805), and the **Previous/Next** button.

**Subsystem** is selected on the CU Number tree when you first open the TrueCopy main screen. Under Subsystem, there are branches of the CU numbers (🗄). Only the CU, which contain the available volumes, are shown in the CU Number tree. A CU number can be selected in the CU Number tree to specify the information displayed in the Volume list. More than one CU number cannot be selected.

The **Volume** list displays information for each volume of the connected disk array (see [Volume List](#) on page 803). The information displayed in this list is sorted in the order of the Device number by default. The information for the volumes, which are defined for several paths, are displayed in several rows as many as the path defined.

The **Display Filter** button opens the Display Filter window (see [Display Filter](#) on page 805), which you can use to select the volumes displayed on the Volume list. The volumes can be selected specifying pair status, pair type, and group number.

In the Volume list, eight to twelve rows of volume information are displayed at once. The 256 rows can be displayed using the scroll bar. The **Previous/Next** buttons switches the Volume list to the previous or next 256 rows.










## Volume List

The Volume list displays the following information for each volume of the connected disk array. The information displayed in this list is sorted in the order of the Port number by default. Each item can be sorted in ascending order or descending order. To sort the items, click the head of the list (for example, Device or Status). Not all of the items of the Volume list can be displayed at once. To see all the items of the list, use the scroll bar below the Volume list.

**Note:** To change the number of items that can be displayed without scrolling, change the font size.

CU	Device	Status	Sub	S/N	SSID	CU	Device	Type	Fence	Diff	CTG	ErrLvl
00	00	Simplex										
00	01	Simplex										
00	02	Simplex										
00	03	Simplex										
00	04	Simplex										
00	05	Simplex										
00	06	Simplex										
00	07	Simplex										
00	08	Simplex										
00	09	Duplex		62492	0004	00	0C	Async	Never	Track	00	Group
00	0A	Duplex		62492	0004	00	0D	Async	Never	Track	00	Group
00	0B	Duplex		62492	0004	00	0E	Async	Never	Track	00	Group
00	0C	Duplex		62492	0004	00	09	Async	Never	Track	00	Group
00	0D	Duplex		62492	0004	00	0A	Async	Never	Track	00	Group
00	0E	Duplex		62492	0004	00	0B	Async	Never	Track	00	Group
00	0F	Duplex		62492	0004	00	10	Sync	Never	Track		
00	10	Duplex		62492	0004	00	0F	Sync	Never	Track		
00	11	Simplex										
00	40	Simplex										
00	41	Simplex										
00	42	Simplex										

**Figure 313: Volume list**

- **Volume icon:** Indicates the status of volumes.
  - : Simplex
  - : M-VOL
  - : R-VOL
- **CU:** CU number of the main LDEV.
- **Device:** Device number.
- **Status:** For more information on TC390 pair status, see [TrueCopy Volume Pair Status](#) on page 759.
  - : **Simplex.** The volume is not currently assigned to a TC390 pair. When the initial copy is started by an Add pair operation, the volume status changes to **Pending**.
  - : **Pending.** The TC390 initial copy operation is in progress. Data on the pair is not fully identical. When the initial copy is complete, the status will change to **Duplex**.
  - : **Duplex.** The volume is currently assigned to a TC390 pair and the pair is 100% synchronized. All updates from the host to the M-VOL are duplicated at the R-VOL.
  - : **Suspending.** The TC390A pair is being suspended. When the TC390A suspend operation is complete, *suspending* changes to *suspended*.
  - : **Suspend.** The TC390 pair has been suspended. Open the Pair Status window to view the suspend type (see [TrueCopy Volume Pair Status](#) on page 759) and detailed pair status information.
  - : **Deleting.** TC390A only. This pair is not synchronized. This pair is in transition from the **Duplex**, **Pending duplex**, or **Suspend** state to the **Simplex** state.
- **Sub:** Suspend Sub Status
  - **GRP:** Consistency time of the current volume is same as that of the consistency group.
  - **VOL:** Consistency time of the current volume is not same as that of the consistency group.
  - **OFF:** Suspended by the PS OFF by the MCU.
- **S/N** and **SSID** of the other disk array (MCU or RCU) of the volume pair.
- **CU** number of the other volume of the volume pair.



- **Device** number of the other volume of the volume pair.
- **Type**: Pair mode, Synchronous or Asynchronous.
- **Fence**: The M-VOL fence level of the TC390 volume pair: data, status, or never. For a complete description of the TC390 M-VOL fence-level parameter, see [Creating TrueCopy Volume Pairs \(Add Pair\)](#) on page 880.
- **Diff**: The information about the differential data.
- **CTG**: Consistency Group number of the pair (only for the Asynchronous pairs).
- **ErrLvl**: Error level of the pair (only for the Asynchronous pairs).
  - **Group**: When the specified pair is suspended, all TC390A pairs in the same consistency group will be suspended, even if the failure affects only that pair and not the entire group.
  - **Volume**: If the failure affects only the specified pair, then only that pair will be suspended. A failure that affects an entire group will always result in the suspension of all pairs in the group, as well as all other affected TC390 pairs.

Select the **Group** error level for all TC390A volumes that are essential to disaster recovery. Do not use suspended TC390A R-VOLs that have the **Volume** error level for disaster recovery.

---

**Note:** The **S/N**, **SSID**, and **Fence** columns might be blank while the pair is in transition from a pair status to Simplex. To display the latest information in these columns, refresh the screen.

Volumes that are currently assigned to SI390 pairs are displayed in the Volume list as simplex. The user is responsible for managing volumes assigned to SI390 and HXRC pairs.

---

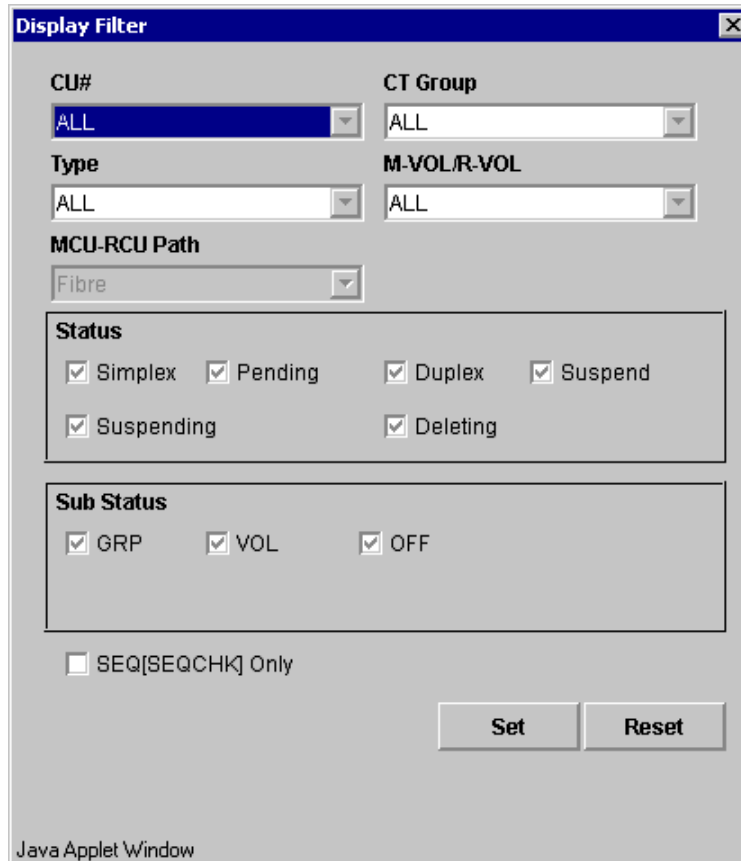
## Display Filter

The **Display Filter** button opens the Display Filter window. Use the Display Filter window to select which volumes to be displayed on the Volume list. You can select the CU number, Consistency group number, Pair type, Volume type, Copy type and Pair status.

When you select the CU number on the CU Number tree, the selection in the CU Number tree has precedence over the specification in the Display Filter window. When the CU number is selected in the tree, the specification on the Display Filter window for the CU number is not available. To make all the settings on the

Display Filter window available, select **Subsystem** in the **CU Number** view. The Display Filter settings are available while you are operating the TC390 software until you reset the settings.

**Note:** You cannot use other windows without closing the Display Filter window.



The screenshot shows a Java Applet Window titled "Display Filter". It contains several filter settings:

- CU#**: A drop-down menu with "ALL" selected.
- CT Group**: A drop-down menu with "ALL" selected.
- Type**: A drop-down menu with "ALL" selected.
- M-VOL/R-VOL**: A drop-down menu with "ALL" selected.
- MCU-RCU Path**: A drop-down menu with "Fibre" selected.
- Status**: A group of checkboxes, all of which are checked: Simplex, Pending, Duplex, Suspend, Suspending, and Deleting.
- Sub Status**: A group of checkboxes, all of which are checked: GRP, VOL, and OFF.
- SEQ[SEQCHK] Only
- Buttons**: "Set" and "Reset" buttons.

Java Applet Window

**Figure 314: Display Filter window**

Use the **CU#** drop-down list to specify the number of the CU to be displayed.

Use the **CT Group** drop-down list to specify the number of the consistency group to be displayed. This specification is available only for the Asynchronous pair.

Use the **Type** drop-down list to specify the pair type, synchronous or asynchronous.

Use the **M-VOL/R-VOL** drop-down list to specify the Volume type, M-VOL or R-VOL.

Use the **MCU-RCU Path** drop-down list to specify the channel type (Fibre).

Use the **Status** check boxes to display only volumes that have the selected pair status: **Simplex**, **Pending**, **Duplex**, **Suspend**, **Suspending** (async only), and/or **Deleting** (async only). The Simplex volumes are always displayed otherwise the **SEQ[SEQCHK]Only** check box is selected.

Use the **Sub Status** check boxes to select the consistency status of the Asynchronous pairs.

Use the **SEQ[SEQCHK]Only** check box to display only the TC390A pairs that are in the SEQCHK status. When this check box is selected, TC390 Synchronous and Simplex volumes are not displayed.

The **Reset** button clears your specifications and displays the default settings. All of the drop-down lists become **ALL**. The **Set** button applies your specifications to the Volume list and closes the Display Filter window.

## Snapshot Function

The TC390 snapshot function reports the user-selected TC390 pair status information. The reported status information is determined by your selections in the Display Filter window.

### To create a TC390 snapshot file:

1. Click **Display Filter** to display the Display Filter window.
2. Select the options you want in the Display Filter window and close the window.
3. From the Pair Operations window, right-click to display the pop-up menu and click **Snapshot**. A confirmation dialog box is displayed.
4. Click **OK** to create the snapshot file.

---

**Note:** If a snapshot file already exists, the new snapshot file data will overwrite the existing snapshot file.

---

An example of snapshot file is shown in the following figure.

```
<Snapshot at 05/10/2002 20:22:12>
```


Vol	Status	Sub	S/N	SSID	Vol	Type	Fence	Diff	CTG	EL	Prio
00:00	Simplex					:					
00:01	Duplex		12345	0001	1F:1E	Sync(M)	Data	Cylinder			032
00:02	Suspend	GRP	12345	0001	1F:1D	Asyn(R)	Never	Cylinder	OC	GRP	032

**Figure 315: Example of snapshot file**

## RCU Operations Screen

Clicking the **RCU Operations** tab displays the RCU Operations screen, which shows the RCU information and provides access to the TC390 RCU setting operations (see [RCU Operations](#) on page 822).

The RCU Operations screen consists of the **Display** buttons, the Operation information, the CU number/Port tree, the MCU/RCU list (see [CU Number Tree and MCU/RCU List](#) on page 809), and the Port list (see [Port Tree and Port List](#) on page 811). MCU/RCU list is displayed by default.

The RCU Operations screen is updated when the tab is switched from one to another, when the **Refresh** button () is clicked, and when the settings for the RCU are applied. For the RCU settings operation, see [RCU Operations](#) on page 822.

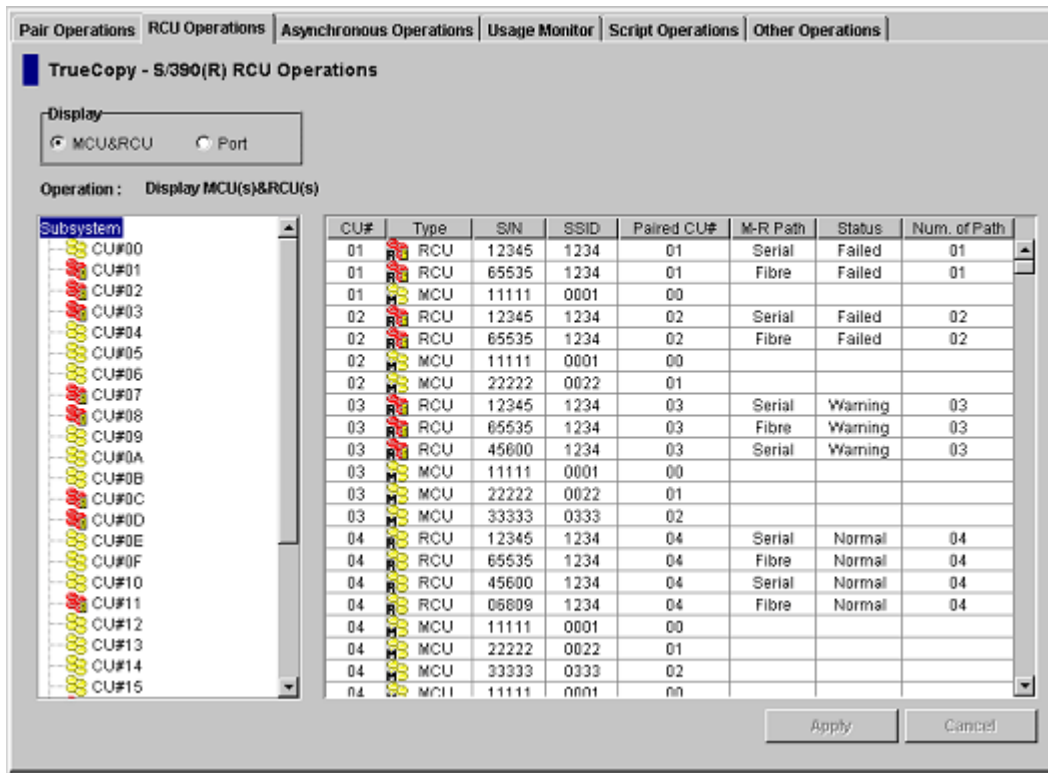


Figure 316: RCU Operations screen

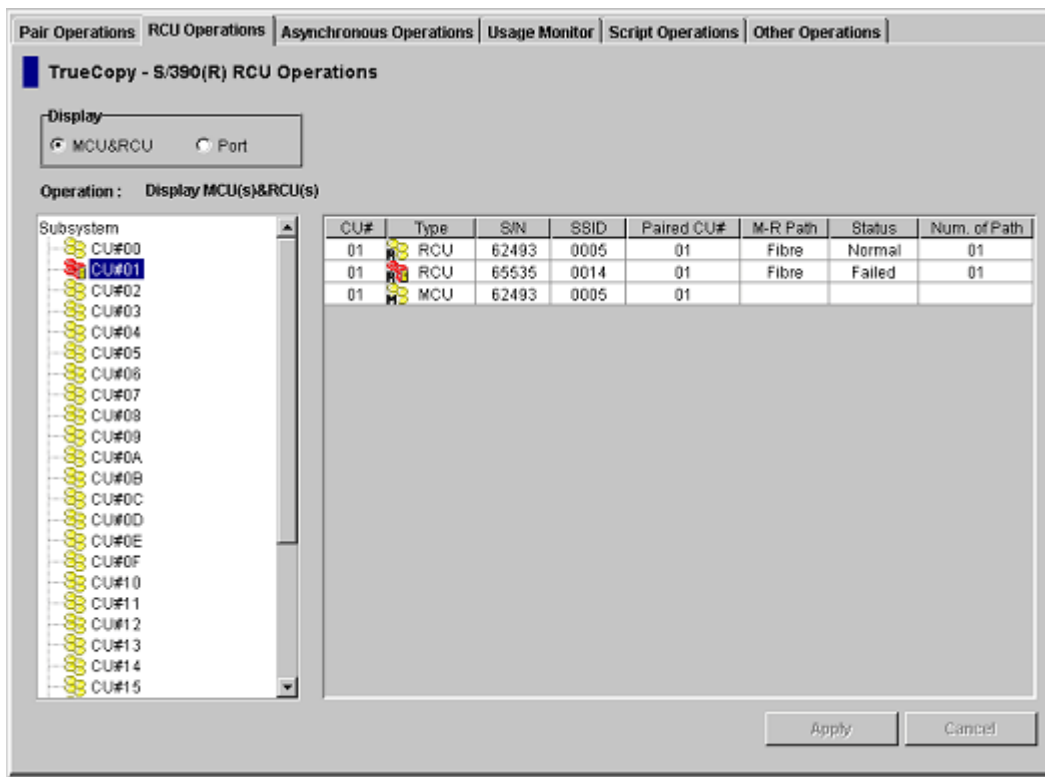
The **Display** buttons switch the contents of the tree and the list. Clicking **MCU&RCU** displays the CU Number tree and the MCU/RCU list (see [CU Number Tree and MCU/RCU List](#) on page 809). Clicking **Port** displays the Port tree and the Port list (see [Port Tree and Port List](#) on page 811).

The **Operation** information indicates the current operation performed on the RCU Operations screen.

## CU Number Tree and MCU/RCU List

The CU Number tree and the MCU/RCU list are displayed when the **MCU&RCU** option is selected in the Display box. In the CU Number tree, only the CU numbers, which include active MCUs or RCUs, are displayed. There is no branch under the CU Number tree. When the CU contains RCU that has the failed path, the error icon (🔴) is shown for the CU number in the CU Number tree.

In the CU Number tree, the CU number can be selected to display the specified information in the MCU/RCU list. You can select only one CU number on the CU Number tree.



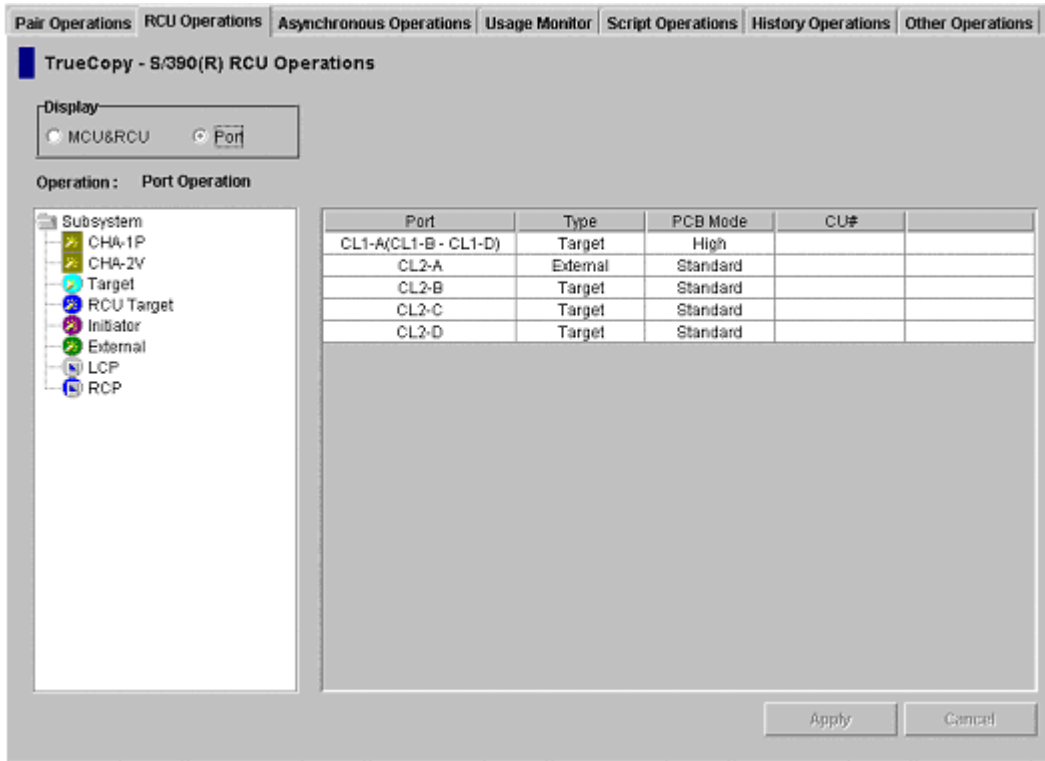
**Figure 317: RCU Operations screen with the MCU&RCU option button selected**

- **CU#:** CU number that is selected on the tree.
- **Type:** MCU (MCU icon) or RCU (RCU icon).
- **S/N and SSID:** Serial number and SSID of the other CU of the pair.
- **Paired CU#:** CU number of the other CU of the pair.
- **M-R Path:** Path channel type (Fibre or Serial) between the other CU of the pair.
- **Status:** **Normal** indicates no failure path between the RCU. **Failed** indicates that there is failure paths between the RCU. This column is blank when the pair CU is MCU.

- **Num. of Path:** Number of paths (is blank when the pair CU is MCU).

## Port Tree and Port List

Clicking **Port** in the Display box displays Port tree and the Port list. The Port tree displays the channel adapters and the port types. Only the ports that are installed and can be selected for remote copy operations are displayed.



**Figure 318: RCU Operations screen with the Port option button selected**

- **Port:** Cluster and port number (CL1-A to CL2-R).
- **Type:** Port type (Initiator, Target, RCU Target, External, RCP, or LCP).
- **PCB Mode:** Speed mode of the port, only for the Fibre ports (standard, high-speed, or high-speed (2 port)).
- **CU#:** Range of CU images: 16 CU: 00-0F (00 through 0F), 10-1F (10 through 1F).

**Note:** High-speed (2 port) mode is available only if the XP disk array has firmware version 21.06.22 or later installed.

The port information in each row depends on the type of channel adapter.

- 1 port in one row (standard).
- 2 ports in one row (standard).
- 2 ports per row (high-speed, 2 port).
- 4 ports in one row (high-speed).

Port	Type	PCB Mode	CU#	
CL2-E,CL2-F	Initiator	Standard		
CL2-G,CL2-H	RCU Target	Standard		

**Figure 319: Standard speed, two ports per row**

Port	Type	PCB Mode	CU#	
CL1-E(CL1-F)	Target	High(2Port)		

**Figure 320: High-speed (2 port), two ports per row**

Port	Type	PCB Mode	CU#	
CL1-E(CL1-F - CL1-H)	Initiator	High		

**Figure 321: High-speed, four ports per row**

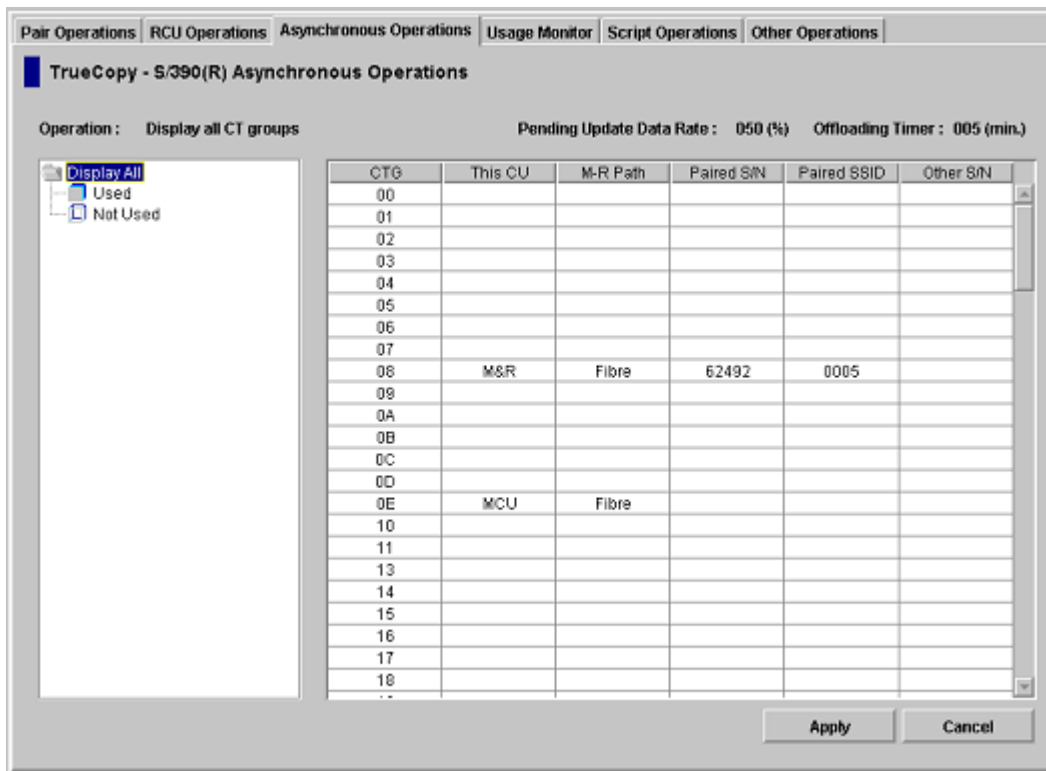


In the Port tree, the port type can be selected to display the specified information in the Port list. For example, when **RCU Target** is selected in the Port tree, the system looks for ports of Initiator from all the ports entered and lists the RCU Target ports in the Port list as shown in the following figure. Only one Port type can be selected in the tree.

## Asynchronous Operations Screen

Clicking the **Asynchronous Operations** tab displays the Asynchronous Operations screen, which shows the consistency group information for the connected disk array and provides access to the TC390A pair operations (see [Asynchronous Operations](#) on page 850).

The Asynchronous Operations screen consists of the information about the SideFile and the information about the consistency group that is displayed in the Consistency Group tree and the Consistency Group list.



**Figure 322: Asynchronous Operations screen**

The **Operation** information indicates the current operation performed on the Asynchronous Operations screen.

**Pending Update Data Rate** is always displayed and shows the maximum cache % available for use by TC390 Async sidefiles.

**Offloading Timer** indicates the maximum time between TC390 Async recordset transfers.

**Display All** is selected in the Consistency Group tree when the Asynchronous Operations screen is displayed. All consistency groups (00-7F) are listed in the Consistency Group list. When **Used** () of Consistency Group tree is selected, the consistency groups that are already registered are listed in the Consistency Group list. When **Not Used** () of Consistency Group tree is selected, the consistency groups that are not registered are listed.

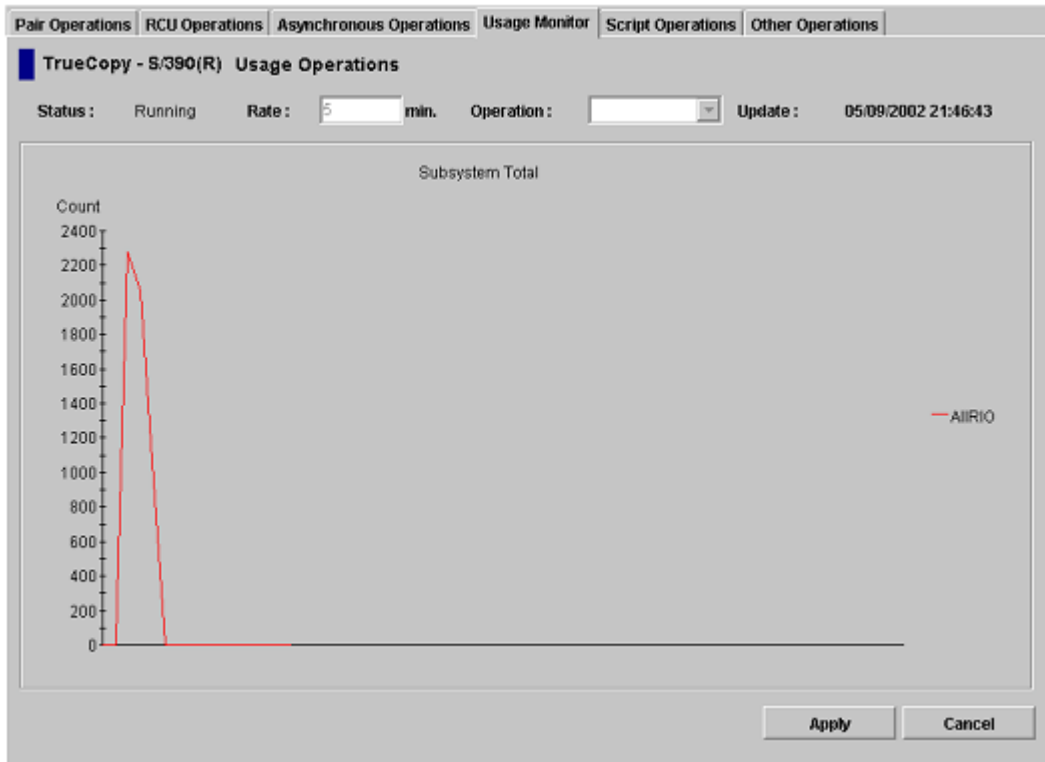
Consistency Group list consists of the following items:

- **CTG**: Consistency group number.
- **This CU**: The CU that initially registered the consistency group. When the consistency group is not registered, the column is blank. **MCU**: The local CU registered the consistency group. **RCU**: The consistency group is registered from the paired CU (the local CU is RCU). **M&R**: MCU and RCU are in the same disk array.
- **M-R Path**: Channel type, Fibre or Serial. When the consistency group is not registered, the column is blank.
- **Paired S/N**: Serial number of the paired disk array (the disk array with the lowest serial number). When the consistency group is not registered, the column is blank.
- **Paired SSID**: SSID (Storage subsystem ID) of paired disk array (the disk array with the lowest SSID). When the consistency group is not registered, the column is blank.
- **Other S/N: Exist**: indicates that there are RCU other than the one with the lowest serial number. When there is no other RCU, the column is blank.

## Usage Monitor Screen

Click the **Usage Monitor** tab to display the Usage Monitor screen and perform the Remote Copy Monitoring function. The Remote Copy Monitoring function obtains the I/O statistics for all the LDEVs on the connected disk array.

**Note:** You must operate Command View in Modify mode to perform TC390 operations. Users in view mode can only view TC390 information.



**Figure 323: Usage Monitor screen**

The Usage Monitor screen displays the following information:

- **Status:** Displays **Running** when monitoring is on and displays **Stop** when monitoring is off. When monitoring is stopped, the usage monitor graph is closed. The usage monitor graph can only be displayed when monitoring is running.
- **Rate:** Displays the data collection rate for usage monitoring (default = 5). When monitoring is stopped, the default value (5) is displayed in the Rate box.
- **Operation:** Used to select the usage monitor operation.

- **Update:** Displays the most recent data sample time of the data on the graph.

## Script Operations Screen

TC390 running on Command View supports scripting for managing pre-defined TC390 operations. The TC390 scripting function defines multiple TC390 operations in a text file that Command View reads and executes as a batch file. Use the scripting function to perform a series of TC390 operations without having to issue the commands separately. Using TC390 scripting, you can set up and execute a large number of TC390 commands within a short period of time. Use the TC390 scripting function to:

- Save time by executing multiple TC390 operations with a single command.
- Run a series of predefined and tested TC390 operations after hours or overnight.
- Allow a non-resident system administrator to set up and start an entire day's worth of TC390 operations in the limited time that the administrator is on-site.

This section describes the selection and execution of an existing TC390 script file. [TrueCopy Scripting](#) on page 979 describes and specifies the requirements for the TC390 script files.



**Caution:** Do not perform TC390 operations using the Pair Operations screen while the scripting function is being executed. To perform TC390 operations on the Pair Operations screen, wait until the script is complete, or verify that the script in execution is aborted.

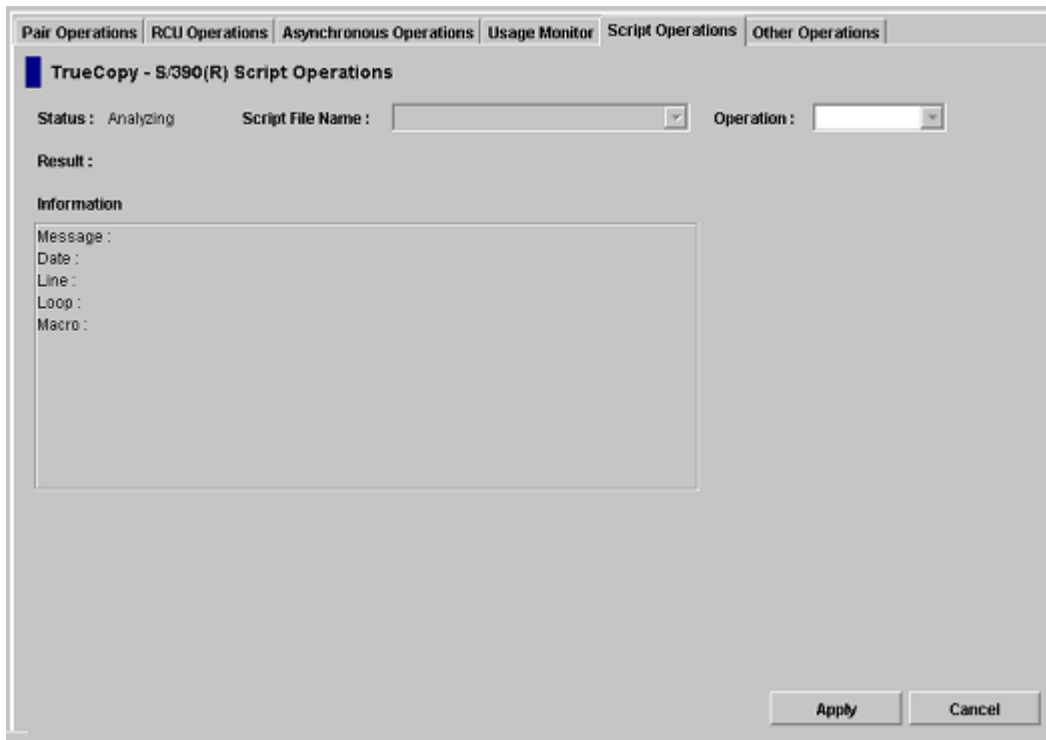
---

**Note:** The script file must be transferred to the SVP before executing the script.

---

Clicking the **Script Operations** tab displays the Script Operations screen, which shows information for the script being executed.

At this time, exporting script trace files is not supported.



**Figure 324: Script Operations screen**


The **Status** field displays the status of the script execution.

- **Stop:** The script has not been executed yet or the script execution has been completed.
- **Analyzing:** The script analysis operation is running.
- **Running:** The script is running.

In the **Script File Name** field, select the name of the TC390 script file.

In the **Operation** field, select a command. TC390 software operation mode must be the Modify mode.

- **Run:** Run the TC390 script file that is selected in the **Script File Name** field. If the script file is in the running status, **Run** cannot be selected.
- **Stop:** Stop the TC390 script file that is running. The script operation is stopped on the script line basis. If the script file execution has been completed, **Stop** cannot be selected.

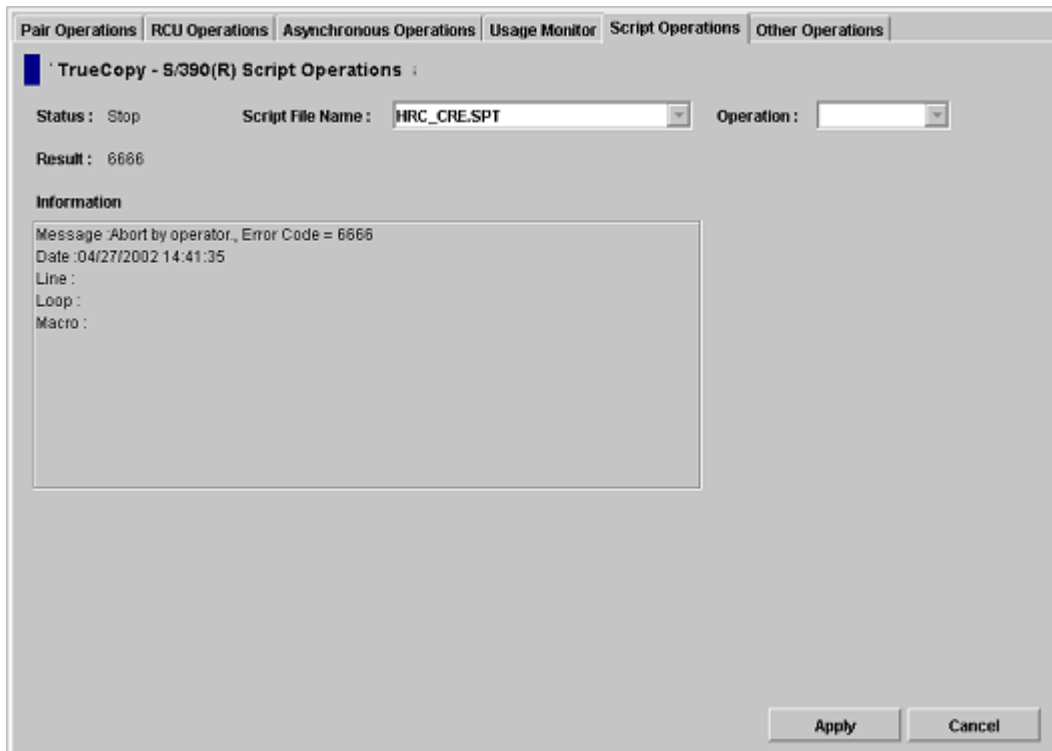
To check the status of the script file, click the **Refresh** button (). The information of the **Status** field is updated.

The **Result** field displays the error code in four-digit hexadecimal number.

The **Information** fields displays the script information.

- **Message:** The message is displayed when the script operation has been completed. **Normal End** indicates that the operation completed normally. When the script is ended abnormally because of the error in the script file, the message, which indicates the abnormal end, is displayed. When the script is stopped by the **Stop** command, **Abort by operator** is displayed.
- **Date:** The date when the script status changed.
- **Line:** The script file line number being executed.
- **Loop:** The current/total repetition count for a looped command (for example, 150/300).
- **Macro:** The macro being executed. Macros that execute a process for a device are listed: CreateHrcPair, ChangeHrcPair, SuspendHrcPair, ResumeHrcPair, and DeleteHrcPair.


The following figure shows the example of the **Script Operations** tab during the execution of a Script File.



**Figure 325: Script Operations screen during execution of a script file**

## History Screen

Click the **History Operations** tab to display the History Operations screen, which displays the history information for the TC390 pairs. Use this screen to perform TC390 history operations. The history information includes the records of the main status changes, such as pair creation and deletion, of the TC390 pairs. See section 4.6 for information and instructions on performing TrueCopy - S/390® history operations.

The History Operations screen is updated when the **Refresh** button (  ) is clicked. The information on the History Operations screen is not updated by clicking another tab and then clicking the History Operations tab again.

Pair Operations	RCU Operations	Asynchronous Operations	Usage Monitor	Script Operations	History Operations	Other Operations
<b>TrueCopy - S:390(R) History Operations</b>						
Status : Complete.						
Last Update : 2002/07/25 16:44:36						
Operation Date/Time	Start Date/Time	Operation	VOL	Paired VOL	Copy Time	
2002/07/25 14:23:54		Pair Delete	00:00	00:01		
2002/07/23 16:41:28	2002/07/23 16:39:31	Pairing Complete	00:00	00:01	000:01:57	
2002/07/23 16:39:31		Pairing Start	00:00	00:01		
2002/07/23 15:57:34		Pair Delete	00:00	00:02		
2002/07/22 16:25:02	2002/07/22 16:23:01	Pairing Complete	00:00	00:02	000:02:01	
2002/07/22 16:23:01		Pairing Start	00:00	00:02		
2002/07/19 20:09:26		Pair Delete	0A:9E	0A:BE		
2002/07/19 20:09:26		Pair Delete	0A:9F	0A:BF		
2002/07/19 20:09:23		Pair Delete	00:9E	00:BE		
2002/07/19 20:09:23		Pair Delete	00:9F	00:BF		
2002/07/19 20:02:37		Pair Delete	1A:95	1A:B3		
2002/07/19 20:02:37		Pair Delete	1A:0D	1A:AB		
2002/07/19 20:02:37		Pair Delete	1A:99	1A:B7		
2002/07/19 20:02:37		Pair Delete	1A:0C	1A:AA		
2002/07/19 20:02:37		Pair Delete	1A:0B	1A:A9		
2002/07/19 20:02:37		Pair Delete	1A:8A	1A:A8		
2002/07/19 20:02:37		Pair Delete	1A:88	1A:A6		
2002/07/19 20:02:37		Pair Delete	1A:87	1A:A5		
2002/07/19 20:02:37		Pair Delete	1A:86	1A:A4		
2002/07/19 20:02:37		Pair Delete	1A:93	1A:B1		
2002/07/19 20:02:37		Pair Delete	1A:8E	1A:AC		
<input type="button" value="Previous"/> <input type="button" value="Next"/>						

**Figure 326: History Operations screen**

The History Operations screen contains the following information:

- **Status** displays the current status of the history file:
  - **No history file exist.** The history file does not exist.
  - **Reading a history failed.** A failure occurred during referring to the history file.
  - **Update history ... n (%).** Updating of the history file is now in progress. “n (%)” indicates the progress (in %) of the updating process of the history file.
  - **Complete.** Updating of the history file has been completed.

When the updating process is in progress, the checking process automatically continues until the updating process finishes. The updating process is checked at ten-second intervals.



- **Last Update** displays the updated date and time of the history file.
- The **History List** displays the history information for the TC390 pairs in the connected disk array. By default, the list is in the order in which the information are received from the disk array.

History List shows the following information:

- **Operation Date/Time:** The date and time when the operation was completed.
- **Start Date/Time:** The date and time when the operation was started.
- **Operation:** The operations are **Pairing Start** (add pair operation was started); **Pairing Complete** (add pair operation was completed); **Pair Delete** (the pair was deleted); **Suspend Operation** (pair suspending operation was performed); **Pair Suspend (Failure)** (the pair was suspended because of a failure); **Pair Resync. Start** (resume pair operation was started); and **Pair Resync. Complete** (resume pair operation was completed).
- **VOL:** CU number and LDEV number of the operated volume.
- **Paired VOL:** CU number and LDEV number of the paired volume.
- **Copy Time:** The time taken for the operation (from the start of the operation to the end). Displayed only for **Pairing Complete** and **Pair Resync. Complete** operations.

History information older than seven days is automatically deleted. However, if the number of operations exceeds 65,535, the oldest operations are deleted in chronological order to keep the number at 65,535, even if the operations occurred within the last week. The history file always contains the most recent operations up to a maximum of 65,535 operations. The maintenance information for an entire week may not always be available.

The history information can be sorted by column and in ascending or descending order.

- **Previous** and **Next** buttons: The list displays up to a maximum of 16,384 operations at a time. Use these buttons to display the previous or next 16,384 operations.

## Other Operations Screen

Clicking the **Other Operations** tab displays the Other Operations screen, which includes the Clear SIM function. For more information, refer to [Script Operations](#) on page 867.

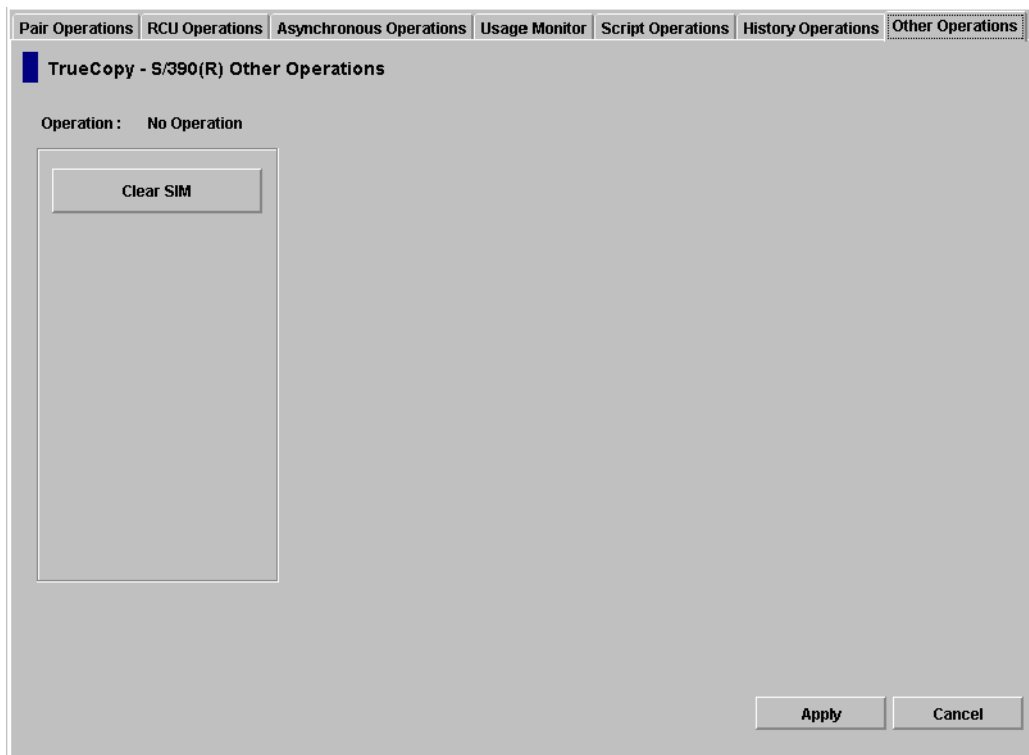


Figure 327: Other Operations screen

## RCU Operations

The RCUs are the control units that control the R-VOLs of the volume pairs. The RCUs are connected to the MCUs through the remote copy connections and receive and process commands from the MCUs. For TC390 operations, the secondary Command View management station at the remote site should be connected to the RCUs to allow TC390 commands to be issued directly to the RCU (for example, in case of disaster or failure at the primary site).

The MCUs are the control units which control the M-VOLs of the volume pairs. The MCUs receive and process user-requested TC390 commands from the Command View management station, and send the remote copy operations to the RCUs. The MCUs can also function as RCUs, provided the remote copy connections are properly configured.

The RCU operations are performed separately for each CU image of each MCU and RCU to provide maximum flexibility in TC390 configurations. The RCU operations are:

- Configuring the host interface ports for MCU-RCU connection (see page 824)
- Viewing RCU status (see page 826)
- Registering RCUs (see page 830)
- Setting the RCU options (see page 830)  
The RCU options apply to all CU images of the MCU.
- Modifying the RCU options (see page 834)
- Deleting RCUs (see page 842)
- Adding and deleting logical paths to an RCU (see page 843)
- Adding and deleting SSIDs for an RCU (see page 847)
- Modifying parameters and omitting selected settings (see page 849)

From the RCU Operations screen (see page 808), you can perform the RCU operations. All the operations that can be performed from the RCU Operations screen have a common procedure.

**To perform the RCU operations from the RCU Operations tab:**

1. Select a CU number or a Port number in the tree.
2. Select one or more RCU or Port in the list. For registering RCU operation, RCU does not have to be selected. For this step, the list can be blank.
3. Right-click the list to display the pop-up menu.
  - a. When the **MCU&RCU** button is selected in the Display box, the pop-up menu consists of the following:
    - **RCU Status:** Displays the RCU status (see [Viewing RCU Status \(RCU Status\)](#) on page 826).
    - **RCU Operation:** Performs the following RCU operations: **Add RCU (Fibre or Serial)** (see [Registering an RCU \(Add RCU\)](#) on page 830), **Change RCU Option** (see [Registering an RCU \(Add RCU\)](#) on page 830 and [Modifying RCU Options \(Change RCU Option\)](#) on page 838), and **Delete RCU** (see [Deleting an RCU \(Delete RCU\)](#) on page 842).
    - **Edit SSID(s) & Path(s):** Performs the following path settings operations: **Add Path** and **Delete Path** (see [Adding and Deleting Logical Paths for an RCU \(Add Path and Delete Path\)](#) on page 843).

Also performs the following SSID setting operations: **Add SSID** and **Delete SSID** (see [Adding and Deleting SSIDs for an RCU \(Add SSID and Delete SSID\)](#) on page 847).

When the list is blank, only the **RCU Operation** command can be activated.

- b. When the **Port** button is selected at the Display box, the pop-up menu consists of **Initiator**, **RCU Target**, **Target**, **Omit**, and **Cancel All**.
4. Select a command. If two or more RCUs are selected in [step 2](#), only the **RCU Operation** command can be selected.

There is no separate window for the port change operation. Select the port type and return to the Volume list (go to [step 6](#)).

5. Click **Set**. The window closes and the MCU/RCU list changes to the **RCU Settings Parameter list**. Only the RCUs selected in [step 2](#) are listed and items in the list depend on the selected command.

---

**Note:** The options can be modified and/or canceled after you have set them. See [Modifying Parameters and Omitting Selected Settings](#) on page 849.

---

6. Click **Apply** on the TrueCopy main screen.

The following sections describe in detail for each command and operation.

## Configuring the Host Interface Ports

You can use TC390 to change the configuration of the disk array host interface ports as needed to accommodate the host and TC390 communications paths.

The disk array Fibre Channel interface ports can be configured as target ports (default), initiator ports, or RCU target ports.

- **Target:** The Fibre Channel ports that will be connected to the host must be configured as target ports (default). Target mode is used for host processor channel interface.
- **Initiator:** The Fibre Channel ports that will be used for TC390 communications to the RCUs must be configured as initiator ports. Initiator mode emulates a host channel to enable the MCU to send write I/O operations directly to the RCU target port. Two or more initiator ports must be configured before you can add the RCUs and create the TC390 pairs.

- **RCU target:** The Fibre Channel ports in the RCU that will be used to communicate with the MCUs must be configured as RCU target ports.

The disk array serial interface ports can be configured as LCPs or RCPs.

- **LCP:** The serial ports which will be connected to the host must be configured as LCPs (default). LCP mode is used for host processor channel interface. The serial ports in the RCU that will be used to communicate with the MCUs must also be configured as LCPs.
- **RCP:** The serial ports which will be used for TC390 communications to the RCUs must be configured as RCPs. RCP mode emulates a host channel to enable the MCU to send write I/O operations directly to the RCU. The RCPs must be configured before you can add the RCUs and create the TC390 pairs.

The serial interface ports, 1S-1Z and 2S-2Z, cannot be specified as RCPs.

The External port that appears on the RCU Operations screen cannot be used with TC390.

Before changing a Fibre Channel port to an initiator port, disconnect the port from the host, delete all affected TC390 pairs, delete all paths from the port to the MCU (if RCU target), and then remove all channel paths to the port.

Also, before changing a Fibre Channel port from initiator to target or RCU target, delete all affected TC390 pairs, delete all paths from the initiator port to the RCU, and then delete the RCU from the MCU.

Before changing the operation mode of a serial port from LCP to RCP, remove all channel paths to the specified port using host system console or ESCD commands. Before changing the mode of a port from RCP to LCP, delete all affected TC390 pairs, delete all paths to the RCU from that RCP, and then delete the RCU from the MCU.

Limit the number of hosts connected to an RCU target port to 128 or fewer to avoid mistaken disconnection. If more than 128 hosts are connected to an ordinary target, some hosts may be disconnected after changing the type from target to RCU target.

#### **To configure the Fibre Channel or serial ports:**

1. Click **Port** in the Display box on the RCU Operations screen to change the tree to the Port tree and the list to the Port list.
2. Select a port or a port type from the Port tree. Only the selected port or the selected port type is displayed in the Port list.
3. Select the port(s) of the CU that you want to configure from the Port list.

4. Right-click to display the pop-up menu, which consists of **Initiator**, **RCU Target**, and **Target** for the Fibre Channel, or **RCP** and **LCP** for the Serial channel.
5. Click a port type from the pop-up menu.

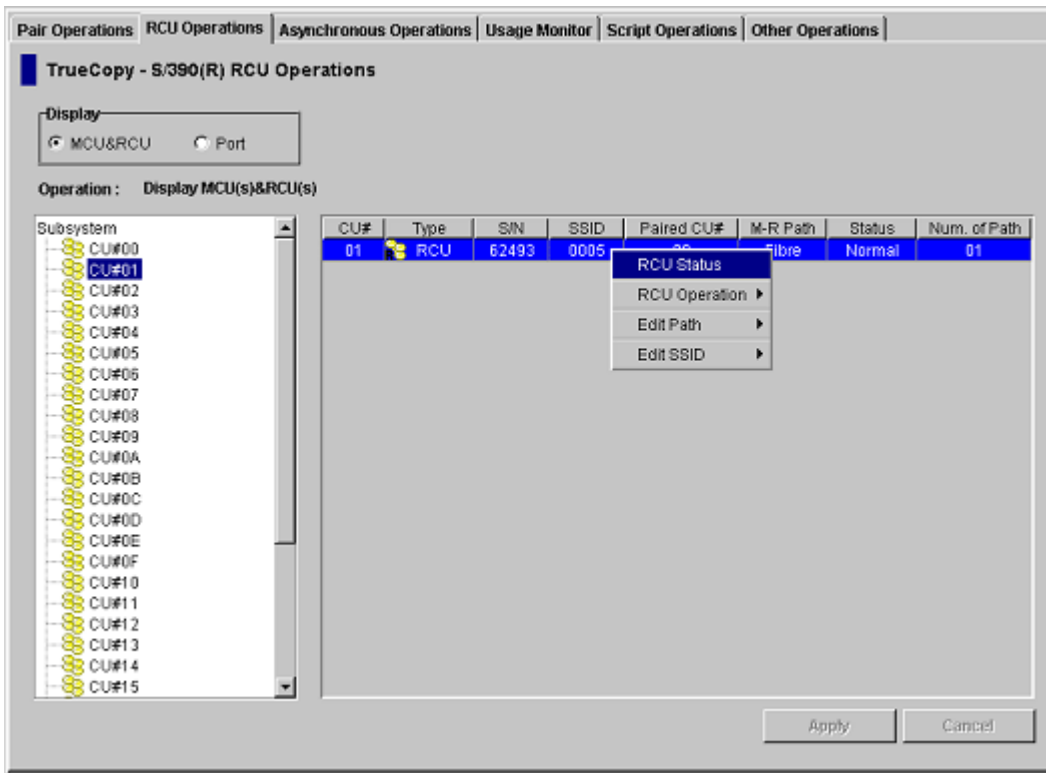
For the port change operation, there is no separate window and the list continues to display the Port list.

### Viewing RCU Status (RCU Status)

Use the **RCU Status** command to display the RCU status information.

#### To display the RCU status information:

1. Click **MCU&RCU** in the Display box.
2. From the CU Number/Port tree, select a CU number that includes the RCU that you want to display the status information.
3. From the MCU/RCU list, select an RCU and right-click to display the pop-up menu.



**Figure 328: MCU/RCU list with the RCU Status command**

- Click **RCU Status** from the pop-up menu. The RCU Status window is displayed.

---

**Note:** If you select more than one RCU in [step 2](#), only **RCU Operation** can be clicked from the pop-up menu. Select one RCU in [step 2](#) to display the status information.

---

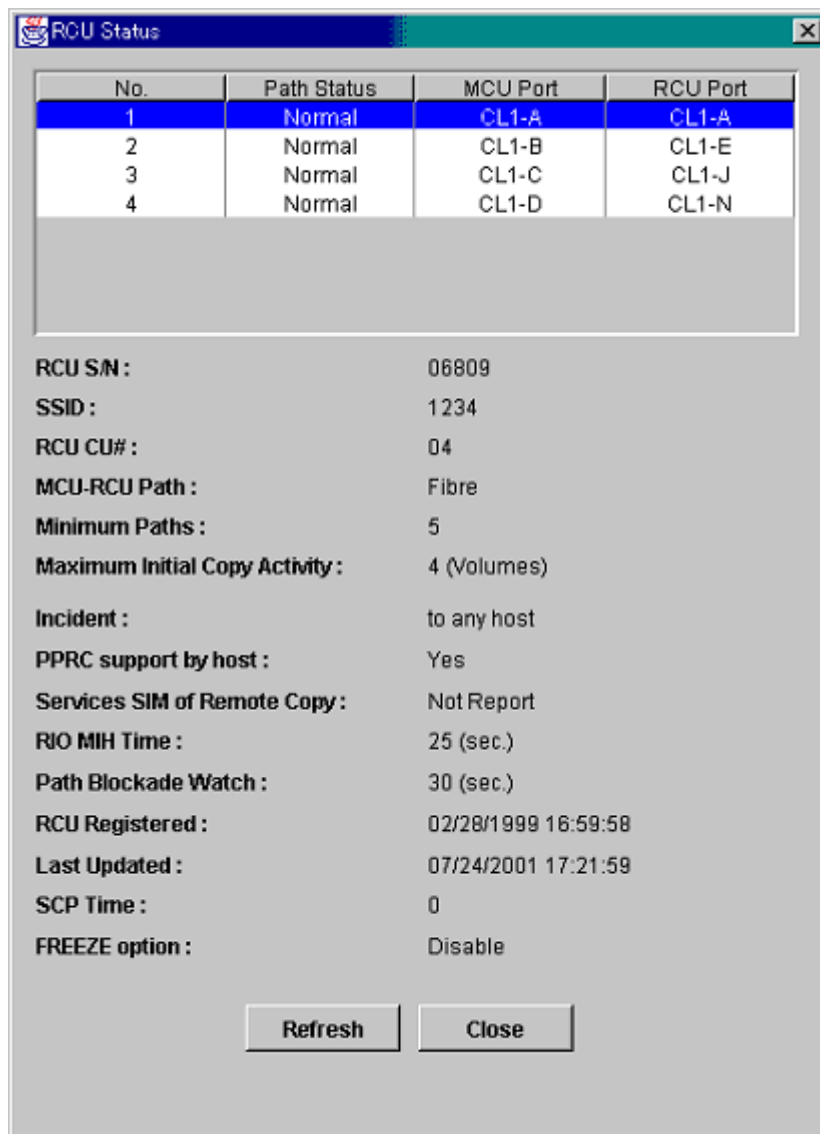


Figure 329: RCU Status window

■ **Path list:**

- **No.:** Path number (serial number of the list).



- **Path Status:** Path status. **Normal** is displayed when the path status is normal.
- **MCU Port** number and **RCU Port** number. When the channel type is serial, the link address is listed on the **RCU Port** column.
- **RCU S/N:** Serial number of the RCU.
- **SSID:** SSID of the RCU.
- **RCU CU#:** CU number of the RCU.
- **MCU-RCU Path:** Channel type of the path interface between the disk arrays (Serial or Fibre).
- **Minimum Paths:** Minimum number of paths required for the selected RCU connected to the MCU.
- **Maximum Initial Copy Activity:** Number of concurrent initial copy operations.
- **Incident:** The host(s) to which the RCUs will report link incident records.
- **PPRC Support by Host:** The host status of the PPRC support.
- **Service SIM of Remote Copy:** Whether the MCU will report the service-level remote-copy SIMs to the host(s).
- **RIO MIH Time:** Time value for the remote I/O (RIO) missing interrupt handler (MIH), which is the wait time until data transfer from the MCU to RCU is complete.
- **Path Blockade Watch:** Time for monitoring blockade in the Fibre Channel paths on the MCU side.
- **RCU Registered:** The date and time when the RCU is registered.
- **Last Updated:** The date and time when the RCU is last updated.
- **SCP Time:** State-Change-Pending (SCP) time.
- **FREEZE Option:** Support for the CGROUP (FREEZE/ RUN) PPRC TSO command.
- The **Refresh** button refreshes the information displayed on the window. The **Close** button closes the window.

The **Path Status** field lists the path status and the following table describes each status. For troubleshooting information about MCU-RCU paths, see [General TrueCopy Troubleshooting](#) on page 925.

**Table 95: Logical path status**

Status Description	Condition
Normal	This logical path has been successfully established and can be used for TC390 remote copy activities.
Initialization Failed	The link initialization procedure with the RCU has failed because either the physical path connection between the MCU and the RCU or the connection between the MCU and the host was missing.
Communication Timeout	A timeout error has occurred between the MCU and RCU.
Resource Shortage	The establish logical path link function has been rejected by the RCU. All logical path resources in the RCU might be used for other connections.
Serial Number Mismatch	The serial number of the control unit that is connected to this logical path does not match the serial number specified by the Add RCU window.
Invalid Port	The serial interface port specified is not in the RCP or Initiator mode.
RCU Port Number Mismatch	There are three possible factors as follows: <ul style="list-style-type: none"> <li>■ The specified port in the RCU is physically disconnected from the MCU.</li> <li>■ The port is not configured as an RCU target port.</li> <li>■ The specified port number is not available.</li> </ul>
RCU Port Type Mismatch	The microprogram at the RCU side does not support the Fibre remote copy function. Or the specified port type is not RCU Target.
Communication Failed	A timeout error has occurred on the Fibre path between MCU and RCU.

### Registering an RCU (Add RCU)

You can register up to four RCUs to each MCU, and establish up to eight paths to each RCU. You must register each CU image as a separate RCU. The logical paths are established for the CU images of the MCU and RCU separately. The maximum number of logical paths for each MCU is 32 (8 paths per RCU × 4 RCUs per MCU).

The remote copy connections and MCU ports must be properly installed and configured before you can register an RCU. When you register an RCU, the current CU image of the MCU registers the specified CU image as a TC390 RCU and establishes the specified number of logical paths to the RCU. After you have registered an RCU (and path status is normal), you can create TC390 pairs that have R-VOLs in the newly registered RCU.

Use the Add RCU window to register the RCU(s) to the current CU image of the connected MCU. When the **Add RCU** command for each channel type is selected, the Add RCU window is displayed and you can set the RCU(s) to be registered.

**Note:** If four RCUs (the maximum number of RCUs you can register) have already been registered, the **Add RCU** command cannot be selected.

The figure shows two side-by-side screenshots of the 'Add RCU' configuration windows. The left window is titled 'Add RCU' and the right is 'Add RCU (Serial)'. Both windows have a grey background and a title bar with a close button.

**Add RCU (Fibre) Window:**

- RCU S/N: 62492
- Controller ID: 3
- Logical Adr.(RCU CU#): 01
- SSID: 5
- MCU-RCU Path table:
 

MCU Port	RCU Port
CL1-B	CL2-B
- Buttons: Option, Cancel

**Add RCU (Serial) Window:**

- RCU S/N: 30075
- Logical Adr.(RCU CU#): 04
- SSID: 1019
- MCU-RCU Path table:
 

MCU Port	Link Address
CL1-R	C6
- Buttons: Option, Cancel

Both windows have a 'Java Applet Window' label at the bottom left.

Figure 330: Add RCU windows (Fibre and Serial)

Use the **RCU S/N**, **Controller ID**, and **Logical Adr. (RCU CU#)** fields to enter the serial number, Controller ID (subsystem family ID), and CU number of the RCU being registered. S/N is in five-digit and CU number is 0-1F. For the Controller ID (for Fibre port type), enter “2” for an XP48/XP512 or “3” for an XP128/XP1024.

Use the **SSID** fields to enter the SSID(s) of the RCU being registered. The XP128/XP1024 uses one SSID for each set of 256 volumes and four SSIDs per CU image. SSID is 4-FFFE in hexadecimal.

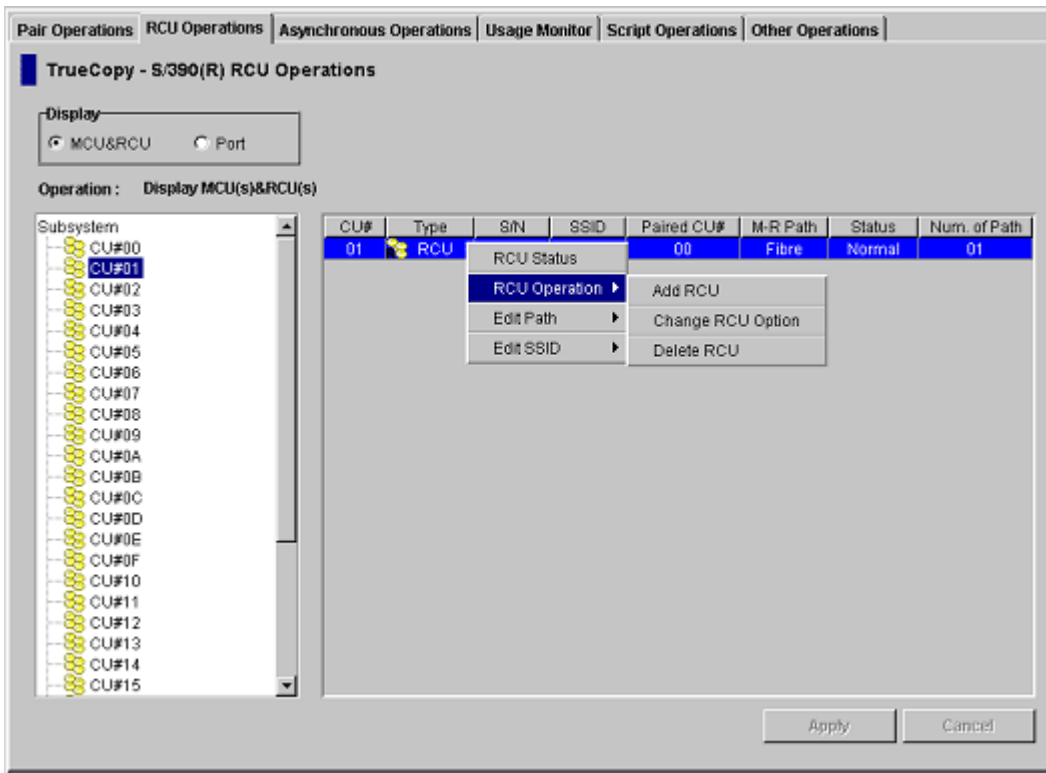
The **MCU-RCU Path** field includes:

- The **MCU Port** field, which you use to enter the MCU port number. Only the Initiators are listed in the drop-down list and you can select the MCU port from the list.
- The **RCU Port** field, which you use to enter the RCU port number. The RCU Target port must be selected. This field is for Fibre port type.
- The **Link Address** field, which you use to enter the link address. The link address is 0-FD in hexadecimal. This field is for Serial port type.

The **Option** button opens the RCU Option window. The **Cancel** button cancels the settings you made on the Add RCU window, and closes the window.

**To register an RCU to the connected MCU:**

1. Verify the remote copy connections and MCU ports are properly configured. Get the S/N of the RCU and the SSID(s) for the CU image in the RCU. The register RCU operation will fail without this information. The XP128/XP1024 should have a label or tag indicating its S/N and SSIDs. The HP representative can also get the RCU S/N and SSIDs using the RCU’s SVP at the remote site.
2. Click **MCU&RCU** in the Display box.
3. From the CU number tree on the RCU Operations screen, select the correct CU image. For this step, the list can be blank. You must register RCUs to each CU image separately.
4. From the MCU/RCU list on the RCU Operations screen, right-click to display the pop-up menu. For registering RCU operation, the RCU does not have to be selected on the list.
5. From the pop-up menu, click **RCU Operation** and then click **Add RCU** (see the following figure). The Add RCU window is displayed.



**Figure 331: MCU/RCU list with the RCU Operation command**

6. From the Add RCU window, enter the S/N of the RCU and the Controller ID, CU number, and SSID(s) for the CU image. You can enter the Controller ID for Fibre port type. The MCU verifies the S/N when the paths are established, and verifies the SSIDs when the volume pairs are created. If needed, add and delete SSIDs later using the Add SSID window (see [Adding and Deleting SSIDs for an RCU \(Add SSID and Delete SSID\)](#) on page 847).
7. Select the **MCU Port** and the **RCU Port**. The MCU will not establish less than the minimum number of paths as specified on the RCU Option window. If needed, add and delete paths later using the Add Path window (see [Adding and Deleting Logical Paths for an RCU \(Add Path and Delete Path\)](#) on page 843).
8. Click **Option** to open the RCU Option window. To cancel the settings you made on the Add RCU window, click **Cancel**.

9. From the RCU Option window, enter or select the settings for adding RCU parameters. For multiplatform XP128/XP1024 configurations with both TC390 and CA paths, set the **Maximum Initial Copy Activity** to **4 Volumes**.
10. From the RCU Option window, click the **Set** even if you made no changes. To cancel the settings, click **Cancel**. The list changes to the **RCU Settings Parameter list**.
11. The new RCU is displayed in the **RCU Settings Parameter list**. To check the path status for this RCU, select the RCU, right-click to display the pop-up menu, and then click **RCU Status**. For detailed information on the path status, refer to [Table 103](#) on page 926.

---

**Note:** The options can be modified and/or canceled after you have set them. See [Modifying Parameters and Omitting Selected Settings](#) on page 849.

---

12. Click **Apply** on the TrueCopy main screen.

## RCU Path Parameters

For serial channel interface, the RCU path parameters are similar to the channel path definitions in the I/O configuration dataset (IOCDS). In the IOCDS, a logical path is specified with a subchannel number, link destination address, and logical address for the CU. TC390 uses the “port” parameter instead of the subchannel number to specify the MCU’s port. For the XP128/XP1024, the logical address must correspond to the CU number. The following figure shows a sample TC390 serial channel configuration with two paths.

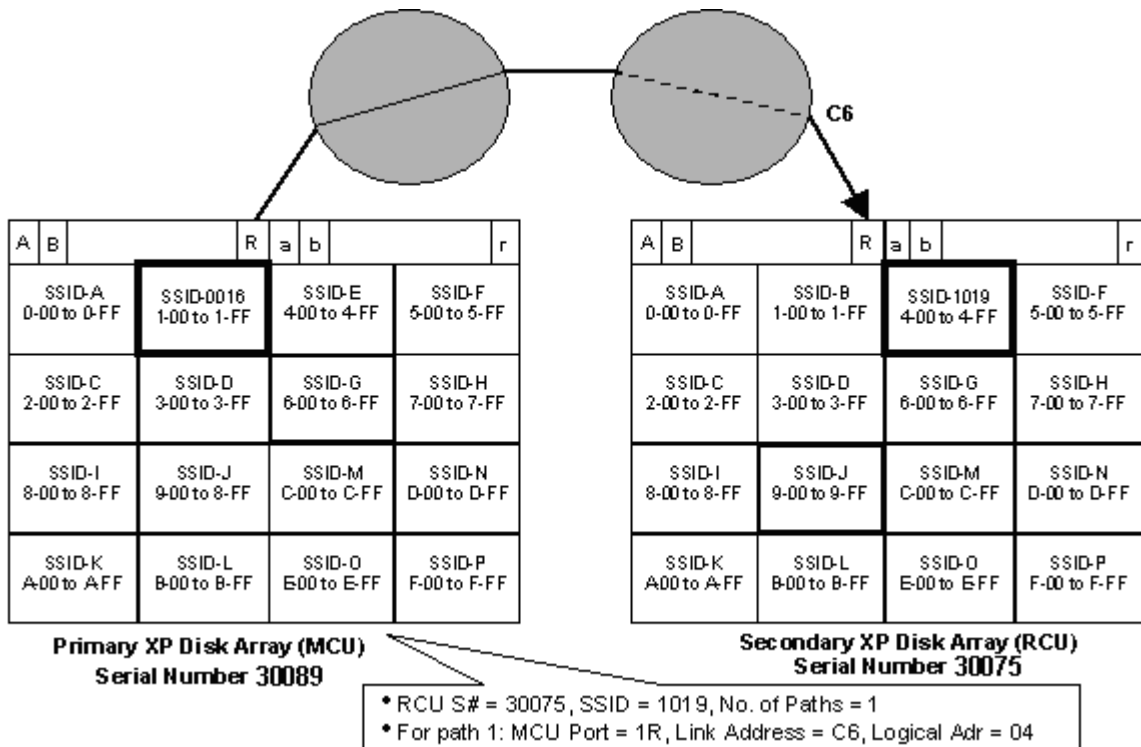


Figure 332: Typical TC390 remote copy configuration with two paths

RCU S/N: 30075

Logical Adr.(RCU CU#): 04

SSID: 1 019

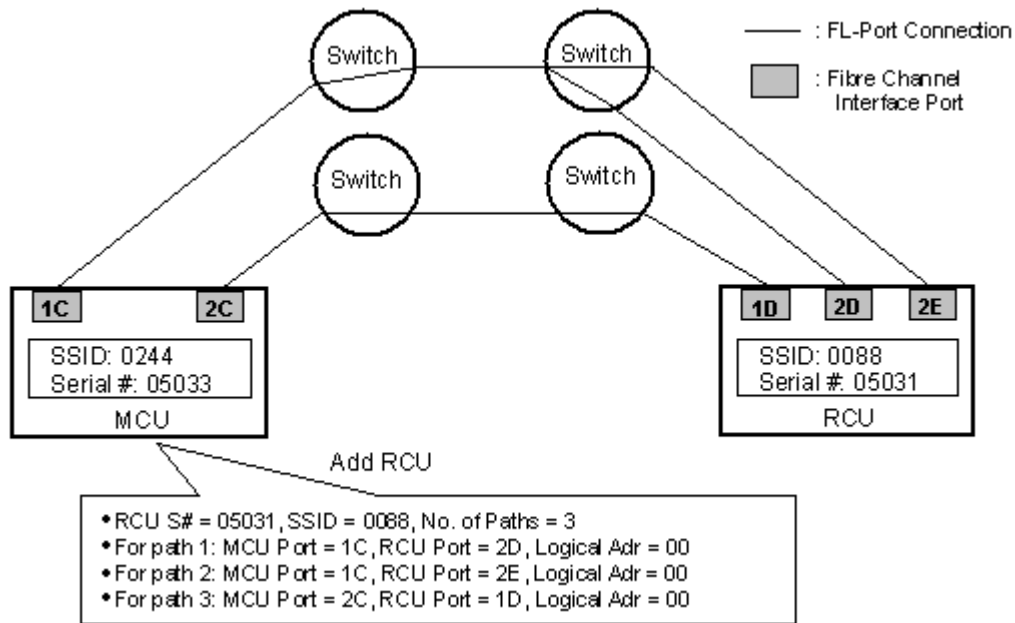
MCU Port	Link Address
CL1-R	C6

Option Cancel

**Figure 333: Add RCU window – serial interface**

For Fibre Channel interface, two types of fibre-channel ports are provided: 4-port and 2-port adapters. The port mode depends on the port type. Also, each port may have a different PCB mode setting (Standard or High). Therefore, when you configure paths among the initiator ports, target ports, and RCU target ports, please study the port modes and specify the correct mode for each port. The following figure shows a sample TC390 Fibre Channel interface configuration with connections going through switches and the TC390 Add RCU window used to define this configuration.





**Figure 334: Fibre Channel interface connections going through switches**

The screenshot shows a Java Applet Window titled "Add RCU". It contains the following fields and controls:

- RCU S/N: 05031
- Controller ID: 3
- Logical ADR.(RCU CU#): 00
- SSID: 0088
- MCU-RCU Path table:

MCU Port	RCU Port
CL1-C	CL2-D
CL1-C	CL2-E
CL2-C	CL1-D

Buttons: Option, Cancel

Java Applet Window

Figure 335: Add RCU window – FC interface

## Modifying RCU Options (Change RCU Option)

Use the RCU Option window to set the RCU options for the connected MCU. The RCU options apply to all MCU CU images and to all RCUs connected to the MCU. The RCU Option window is presented during the add RCU process, and can also be opened by right-clicking on the RCUs and clicking **RCU Operation > Change RCU Option**.

The image shows a Java Applet Window titled "RCU Option". It contains several configuration fields:

- Minimum Paths :** A text input field containing the value "1".
- Maximum Initial Copy Activities :** A dropdown menu with "4" selected.
- SCP Delay Time :** A text input field containing the value "120".
- RIO MIH Time (sec.) :** A text input field containing the value "15".
- Path Blockade Watch (sec.):** A text input field containing the value "40".
- Incident of RCU :** A dropdown menu with "to any host" selected.
- PPRC support by host :** A dropdown menu with "No" selected.
- Services SIM of Remote Copy :** A dropdown menu with "Not Report" selected.
- FREEZE option :** A dropdown menu with "Disable" selected.

At the bottom of the window, there are two buttons: "Set" and "Cancel". The text "Java Applet Window" is visible in the bottom-left corner of the dialog box.

**Figure 336: RCU Option window (Change RCU Option)**

Use the **Minimum Paths** option to specify the minimum number of paths required for each RCU connected to the current MCU. You can specify 1, 2, 3, 4, or 8 for this option. If the number of paths falls below the specified number (for example, due to a failed path), the MCU will suspend all affected TC390 (and TC) pairs to prevent remote copy operations from adversely affecting performance due to the inadequate number of paths. For TC390 pairs that contain critical data for disaster recovery, the minimum number of paths should be set to one so that TC390 operations continue even if there is only one path to an RCU. If you need to maintain high performance at the MCU, set the minimum paths to two or more (max paths = 8 for fibre, 8 for serial 2105, 4 for serial 3990), depending on the number of pairs managed by the MCU.



**Caution:** If TC390 volume pairs are suspended because the number of paths has dropped below this setting, the M-VOL fence-level pair option (see [Creating TrueCopy Volume Pairs \(Add Pair\)](#) on page 880) determines whether the TC390 Synchronous M-VOLs are fenced (that is, reject all write operations).

---

The **Maximum Initial Copy Activity** setting specifies the number of concurrent initial copy operations (minimum = 1, maximum = 4). TC390 initial copy activities can impact the performance of the main disk array, depending on the amount of I/O activity and the number of pairs being added at the same time. The maximum initial copy activity setting limits the impact of initial copy activities on disk array performance. For example, if you set the maximum initial copy activity to four and then add five TC390 pairs at the same time, the MCU starts the first four pairs and will not start the fifth pair until one of the first four pairs is synchronized. The maximum initial copy activity value can be set only when adding new pairs. After you have added a TC390 volume pair, this setting cannot be changed for that pair.

The **SCP Delay Time** setting specifies the state-change-pending (SCP) delay time in seconds (0-600 seconds). CGROUP/FREEZE uses the SCP state to suspend host I/Os to TC390 M-VOLs (see [CGROUP \(FREEZE/RUN\) Support](#) on page 950). TC390A uses the SCP state for inflow control to prevent cache storage overload (see [Inflow Control of Recordsets](#) on page 751). Make sure to set the SCP delay time after you have added all MCU-RCU paths.



**Caution:** You must click **OK** on the RCU Option window to register the **SCP Delay Time** setting, even if you did not make any changes to the RCU options. Ensure to select the appropriate SCP delay time for your TC390 system configuration.

---

The **RIO MIH Time** setting specifies the time value for the remote I/O (RIO) missing interrupt handler (MIH), which is the wait time until data transfer from the MCU to RCU is complete. The RIO MIH time value must be from 10 to 100 seconds. The default setting is 15 seconds. This setting is available for both serial and Fibre Channel interfaces. For more information on the MIH, refer to the [Installing the TrueCopy Hardware](#) on page 777.

The **Path Blockade Watch** setting specifies the time for monitoring blockade in the Fibre Channel paths on the MCU side. The path blockade watch value must be from 0 to 45 seconds. The default setting is 40 seconds. This setting is available for Fibre Channel interface only.

Use the **Incident of RCU** option to specify which host(s) the RCUs will report link incident records to. When **to any host** is selected, the RCUs will send link incident records to all RCU hosts and to all MCU hosts. When **only to RCU host** is selected, the RCUs send link incident records only to the RCU host(s). Verify that RCU link incidents are reported to the proper host(s) so that corrective action, if needed, can be taken. The **to any host** setting is recommended when TC390 is being used for disaster recovery purposes.

Use the **PPRC support** option to specify whether the MCU will generate sense information that is compatible with IBM PPRC. This option is extremely important for TC390 disaster recovery planning. If the host does not support PPRC, select **No** to configure the MCU to report SIMs. If the host system supports PPRC, select **Yes** to configure the MCU to generate PPRC-compatible sense information when a TC390 pair is suspended instead of a service information message (SIM). If **Yes** is selected, the MCU will still report moderate- and serious-level SIMs, as well as DF40 and DF48 device SIMs. For more information on PPRC support, refer to [Using PPRC Commands for TrueCopy](#) on page 933.

---

**Note:** If you plan to use the CGROUP (FREEZE/RUN) command for TC390 pairs, you must select **Yes**.

---

Use the **Service SIM of Remote Copy** option to specify whether the MCU will report the service-level remote-copy SIMs to the host(s). (The moderate-, serious-, and acute-level SIMs are always reported to the host.) Select **Report** to configure the MCU to report the service-level remote-copy SIMs to the host(s). The **Report** setting should be selected for TC390 disaster recovery planning. Select **Not Report** to suppress service-level SIM reporting. For a description of the TC390 and TC390A SIMs, see [SIM Reporting](#) on page 973. All service-level SIMs will be logged in the SSB.LOG file on the XP128/XP1024 SVP, regardless of this setting.

The **FREEZE Option** setting enables or disables support for the CGROUP (FREEZE/ RUN) PPRC TSO command (see [CGROUP \(FREEZE/RUN\) Support](#) on page 950). The FREEZE option is available only when PPRC support = Yes. If you select **Enable**, the MCU will accept and perform the CGROUP command. If you select **Disable**, the MCU will reject the CGROUP command. Enable the FREEZE option only after all MCU-RCU paths have been added.

The **Cancel** button cancels the registering RCU operation. The **Set** button sets the registering RCU operation with the option you set on the RCU Option window.

**Note:** You cannot use the PPRC commands to change the RCU options. For more information on PPRC TSO and ICKDSF commands, refer to [Using PPRC Commands for TrueCopy](#) on page 933.

---

**To modify the RCU option:**

1. From the CU Number tree on the RCU Operations screen, verify the correct CU image is selected.
2. From the MCU/RCU list on the RCU Operations screen, select RCU whose options you want to modify.
3. Right-click to display the pop-up menu, click **RCU Operation**, and then click **Change RCU Option**. The RCU Option window is displayed.
4. From the RCU Option window, modify the RCU options. When the RCU Option window is opened, all the fields display the current settings. Complete the fields with the RCU options you want to modify.
5. Click **Set** to set the changes you made. The list changes to the RCU Settings Parameter list (RCU Option). To cancel all the changes you made, click **Cancel**.

---

**Note:** The options can be modified and/or canceled after you have set them. See [Modifying Parameters and Omitting Selected Settings](#) on page 849.

---

6. Click **Apply** on the TrueCopy main screen.

## Deleting an RCU (Delete RCU)

You can delete an RCU from an MCU only after all TC390 volume pairs between the MCU CU image and RCU CU image have been deleted. When you delete an RCU from an MCU, the MCU deletes all logical paths from the current MCU CU image to the selected RCU CU image. Deleting an RCU does not affect the TC390 operations between the other MCU CU images and that RCU. After an RCU has been deleted, you can reconfigure the remote copy connections to add another RCU to the MCU, or you can remove the remote copy connections and reconfigure the MCU ports (RCPs to LCPs for serial; initiator ports to ordinary target ports for fibre) to provide additional host channels for the MCU.

Use the **Delete RCU** command to delete the selected RCU from the current MCU CU image. If all affected pairs have not been deleted, the MCU will reject the delete RCU operation to prevent accidental deletion of TC390 pairs.

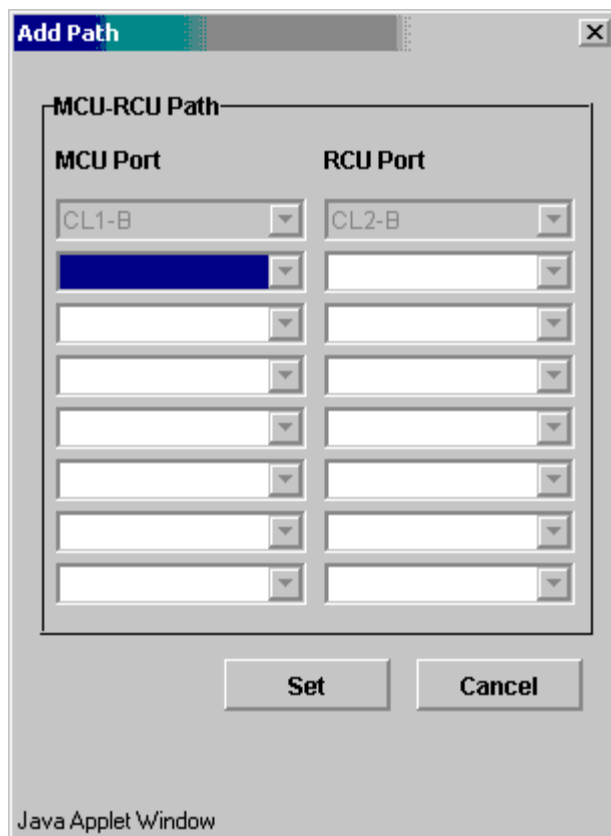
**To delete an RCU from an MCU:**

1. Connect to the MCU.
2. Verify that all affected TC390 volume pairs have been deleted. The volume pairs that consist of a M-VOL in the connected MCU and CU image and an R-VOL in the selected RCU must be deleted.
3. From the CU number/Port tree on the RCU Operations screen, verify the correct CU image is selected.
4. From the MCU/RCU list on the RCU Operations screen, select the RCU that you want to delete.
5. Right-click to display the pop-up menu, click **RCU Operation**, and then click **Delete RCU**.
6. Click **Apply** on the TrueCopy main screen.

## **Adding and Deleting Logical Paths for an RCU (Add Path and Delete Path)**

Before adding a path to an RCU, verify that the remote copy connection is properly installed, that the appropriate MCU ports are configured as RCPs (serial) or Initiator ports (fibre), and that the appropriate MCU CU image is selected. You can add up to four RCUs to each MCU CU image and establish up to eight paths to each RCU. When you add a path to an RCU, TC390 will automatically start using the new path to perform TC390 copy activities.

When the **Add Path** command is selected, the Add Path window is displayed. Use the Add Path window to set the path(s) to an RCU.



**Figure 337: Add Path window (for Fibre)**

The **MCU-RCU Path** field includes:

- The **MCU Port** fields, which you use to enter the MCU port number. The Initiator and the RCP are listed in the drop-down list and can be selected.
- The **RCU Port** fields, which you use to enter the RCU port number. The RCU Target port must be specified.
- The **Link Address** fields, which you use to enter the Link Address.

The **Cancel** button cancels the settings you made. The **Set** button applies the settings you made and changes the list.

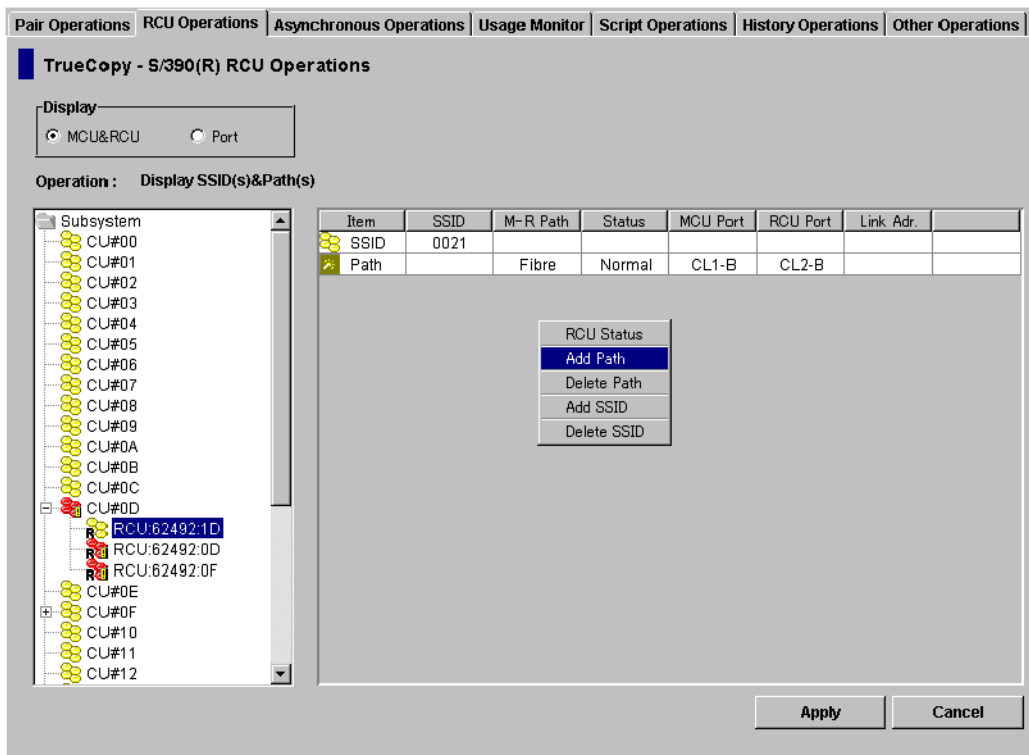


**Note:** The number of effectively displayed fields depends on the number of paths that can be added.

For more information on the path status, refer to [Table 103](#) on page 926.

**To add a new logical path from the connected MCU to an existing RCU:**

1. From the CU Number tree on the RCU Operations screen, verify the correct CU image is selected.
2. From the MCU/RCU list on the RCU Operations screen, select the RCU to which you want to add a path.
3. Right-click to display the pop-up menu, click **Edit SSID(s) & Path(s)**, and then click **Add Path** (see the following figure). The Add Path window is displayed.



**Figure 338: Opening the Add Path window**

4. From the Add Path window, enter the new path(s).
5. Click **Set** in the Add Path window to set the paths. The list changes to the **Path Settings Parameter list**.

---

**Note:** The options can be modified and/or canceled after you have set them. See [Modifying Parameters and Omitting Selected Settings](#) on page 849.

---

6. Click **Apply** on the TrueCopy main screen. The MCU will automatically begin using the new logical path for TC390 activities.

Before deleting a path to an RCU, verify that the remaining number of paths will be equal to or greater than the minimum number of paths setting (selected on the RCU Option window). The delete path operation will fail if the number of remaining paths is less than the minimum number of paths.

**To delete a path from the connected MCU to an existing RCU:**

1. Open the RCU Option window and check the minimum number of paths setting. If the remaining number of paths will be less than this value, the delete path operation will fail. If needed, change the minimum number of paths so that you can delete the appropriate path.
2. From the CU Number/Port tree on the RCU Operations screen, verify the correct CU image is selected.
3. From the MCU/RCU list on the RCU Operations screen, select the RCU with the path you want to delete.
4. Right-click to display the pop-up menu, click **Edit SSID(s) & Path(s)**, and then click **Delete Path**. The list changes to the **Path Settings Parameter list**. Only the selected RCUs are listed.

---

**Note:** The options can be modified and/or canceled after you have set them. See [Modifying Parameters and Omitting Selected Settings](#) on page 849.

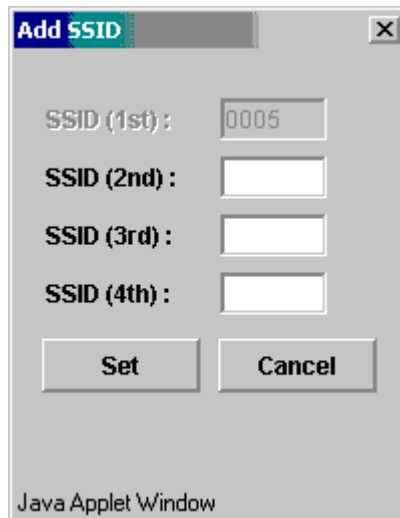
---

5. Click **Apply** on the TrueCopy main screen.

## Adding and Deleting SSIDs for an RCU (Add SSID and Delete SSID)

Before adding an SSID, verify that the remote copy connection is properly installed. You can add three SSIDs to each RCU. Before deleting an SSID, verify the remaining SSIDs are still valid, or the connection between the MCU and RCU may be lost.

When the **Add SSID** command is selected, the Add SSID window is displayed. Use the Add SSID window to add three SSIDs at once to the selected RCU CU image.



**Figure 339: Add SSID window**

The Add SSID window displays three SSID fields to enter. You can enter up to three SSIDs at once with the Add SSID window. You can add up to four SSIDs (the maximum number of the SSID) in total.

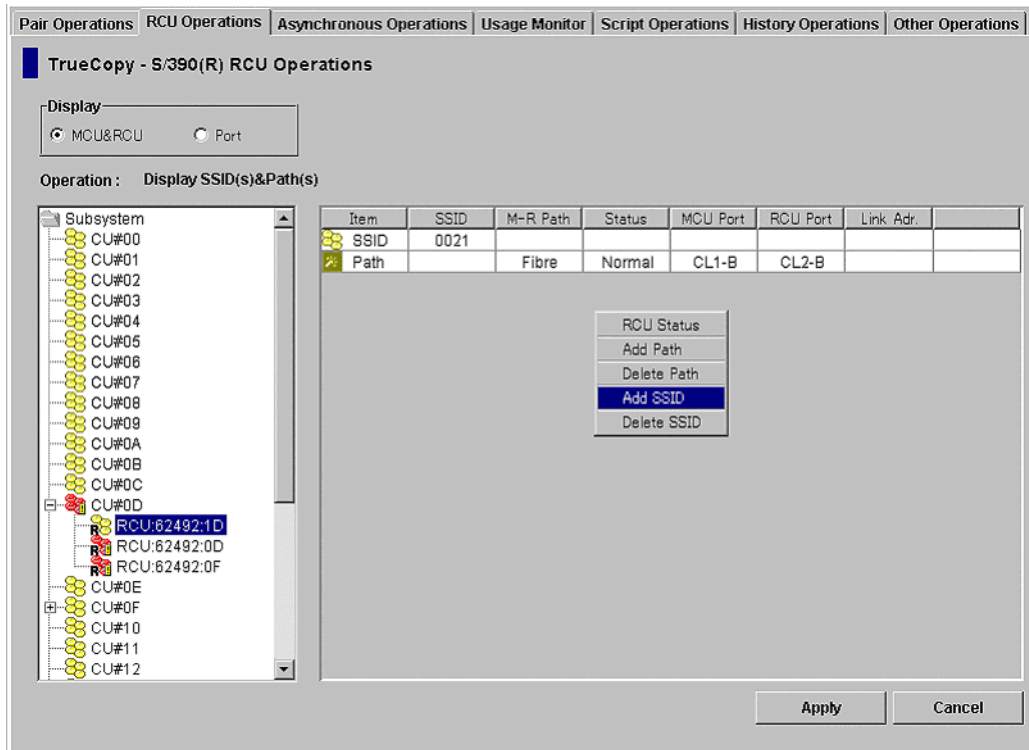
The **Cancel** button cancels the settings you made. The **Set** button applies the settings you made and changes the list.

### To add or delete an SSID for an existing RCU:

1. From the CU Number tree on the RCU Operations screen, verify the correct CU image is selected.
2. From the MCU/RCU list on the RCU Operations screen, select the RCU that you want to add or delete the SSID(s).

3. To add an SSID:
  - a. Right-click to display the pop-up menu, click **Edit SSID(s) & Path(s)**, and then click **Add SSID**. The Add SSID window is displayed.
  - b. From the Add SSID window, enter the new SSID(s) in the SSID fields. You can add up to four SSIDs (in total) to the RCU.
  - c. Click **Set** to add the SSIDs. The list changes to the **SSID Settings Parameter list**. The added SSIDs are listed.

**Note:** The options can be modified and/or canceled after you have set them. See [Modifying Parameters and Omitting Selected Settings](#) on page 849.



**Figure 340: Opening the Add SSID window**

4. To delete the SSID(s): Right-click to display the pop-up menu, click **Edit SSID(s) & Path(s)**, and then click **Delete SSID**. The list changes to the **SSID Settings Parameter list**. Only the RCUs that are to be deleted are listed.

---

**Note:** The options can be modified and/or canceled after you have set them. See [Modifying Parameters and Omitting Selected Settings](#) on page 849.

---

5. Click **Apply** on the TrueCopy main screen.

## Modifying Parameters and Omitting Selected Settings

After the RCU, Path, and/or SSID operation, the parameters can be modified individually. Also the RCUs, Paths, and/or SSIDs that you have set by the each operation can be omitted from the pair operation.

### To modify the parameters:

1. Select a RCU, Path, or SSID whose parameters you want to modify on the list.
2. Right-click to display the pop-up menu and click **Modify** to modify the parameters. A window for each operation is displayed.
3. Modify the parameters and click **Set** in the window.
4. Click **Apply** on the TrueCopy main screen.

---

**Note:** After the delete operation of the RCU, Path, and/or SSID operation, the **Modify** command is not available.

---

### To omit the RCUs, Paths, or SSIDs from the operation:

1. Select the RCUs, Paths, or SSIDs to be omitted from the operation on the list.
2. Right-click to display the pop-up menu and click **Omit**. The RCUs, Paths, or SSIDs selected in [step 1](#) are deleted from the list, and the deleted RCUs, Paths, or SSIDs have been removed from the operations.
3. Click **Apply** on TrueCopy main screen.

The **Cancel All** command deletes all the RCUs, Paths, or SSIDs on the list, and all the RCUs, Paths, or SSIDs have been removed from the operations. All the RCUs, Paths or SSIDs can also be deleted from the list using the **Omit** command by

selecting all of the RCUs, Paths, or SSIDs on the list. When all the RCUs, Paths, or SSIDs are deleted from the list (by the **Cancel All** or **Omit** command), the list status becomes the Volume list.

## Asynchronous Operations

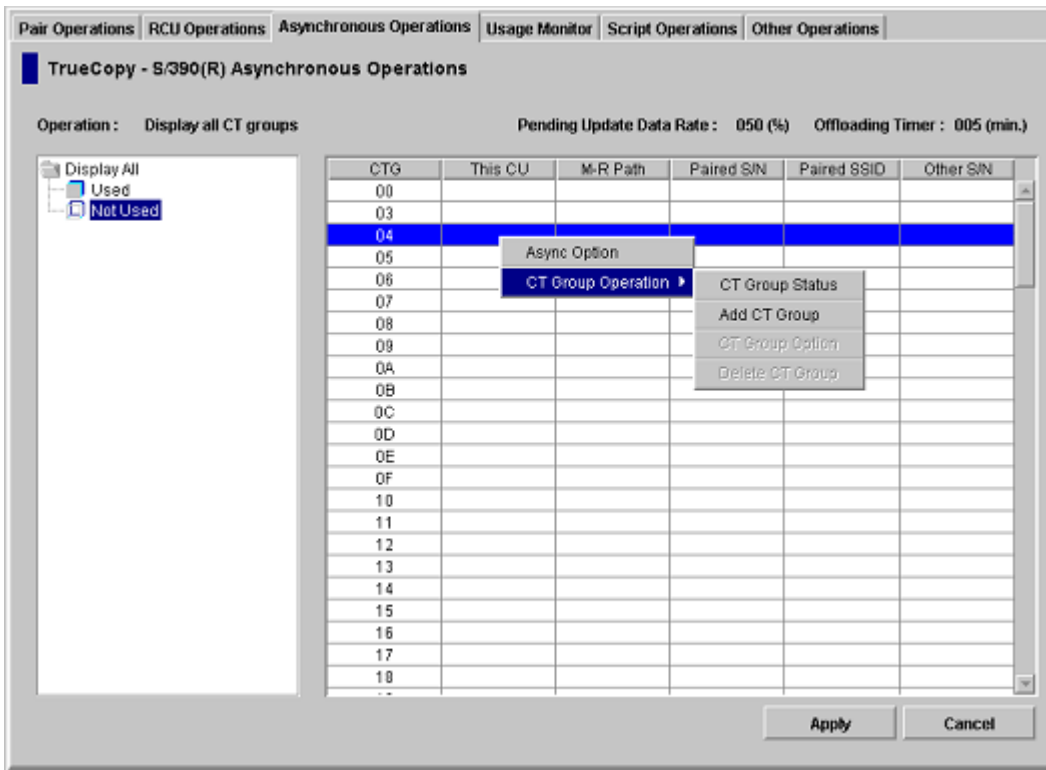
The TC390A control operations include:

- Viewing consistency group status (see page 852)
- Adding consistency groups (see page 854)
- Modifying the consistency group options (see page 856)
- Deleting consistency groups (see page 858)
- Setting the Asynchronous copy options (see page 859)
- Modifying parameters and omitting consistency groups (see page 861)

Click the **Asynchronous Operations** tab (see page 813) to perform the asynchronous operations. All the operations that can be performed from the Asynchronous Operations screen have a common procedure.

### To perform the asynchronous operations:

1. Select a consistency group mode (**Display All**, **Used**, or **Not Used**) in the Consistency Group tree.
2. Select one or more consistency group in the Consistency Group list.
3. Right-click to display the pop-up menu. The pop-up menu consists of the following:
  - **Async Option**: Sets the parameters for the asynchronous copy operation (see [Asynchronous Copy Option](#) on page 859).
  - **CT Group Operation**: Performs the following consistency group operations: **CT Group Status** (see [Viewing Consistency Group Status \(CT Group Status\)](#) on page 852), **Add CT Group** (see [Adding Consistency Groups \(Add CT Group\)](#) on page 854), **CT Group Option** (see [Modifying Consistency Group Options \(CT Group Option\)](#) on page 856), and **Delete CT Group** (see [Deleting Consistency Groups \(Delete CT Group\)](#) on page 858).



**Figure 341: Consistency Group list**

4. Select a command and use the window to make your settings.
5. Click **Set**. The Consistency Group list changes to the Consistency Group Settings Parameter list or the Asynchronous Options Settings Parameter list. Only the consistency groups selected in [step 2](#) are listed and items in the list depend on the selected command.

---

**Note:** The options can be modified and/or canceled after you have set them. See [Modifying Parameters and Omitting Consistency Groups](#) on page 861.

---

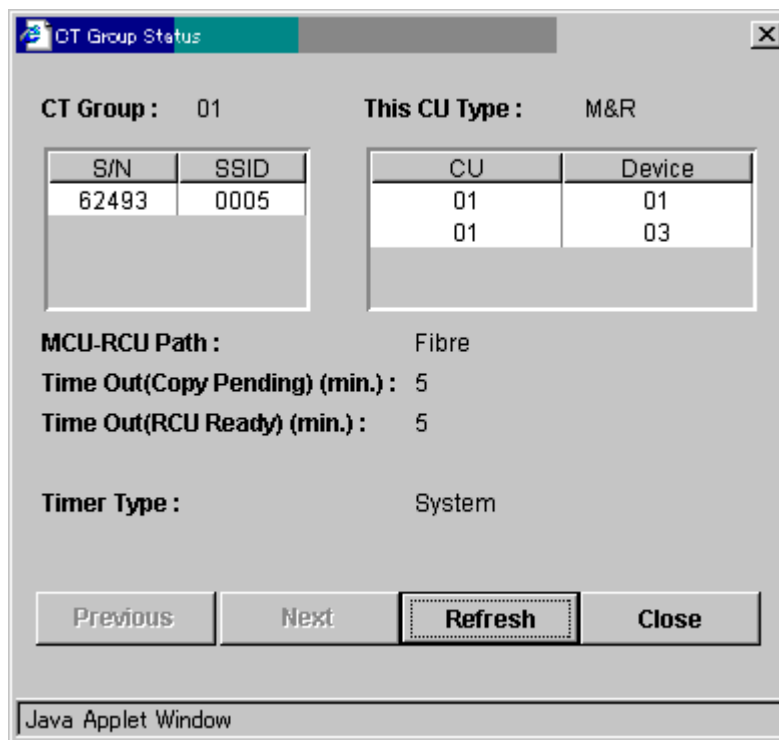
6. Click **Apply** on the TrueCopy main screen.  
The following sections describe in detail for each command and operation.

## Viewing Consistency Group Status (CT Group Status)

The **CT Group Status** command can be used to display the consistency group status information.

### To display the consistency group status information:

1. From the Consistency Group tree, select the consistency group mode that includes the consistency group with the status information you want to display.
2. From the Consistency Group list, select a consistency group. Select only one consistency group.
3. Right-click to display the pop-up menu, click **CT Group Operation** and then click **CT Group Status**. The CT Group Status window is displayed.



**Figure 342: CT Group Status window**

- **CT Group:** Consistency group number of the selected consistency group in the list.



- **This CU Type:** Registering side (MCU or RCU) of the consistency group.
- **S/N, SSID list box:** Serial number and SSID of the CUs that are the components of the selected consistency group.
- **Pair list box:** Pair list of the original CU of the selected consistency group. For a device that is set with more than one path, only the first path is listed.
- **MCU-RCU Path:** Channel type of the path interface between the disk arrays (Serial or Fibre).
- **Time Out (Copy Pending):** The maximum delay allowed for TC390A copy (see [Adding Consistency Groups \(Add CT Group\)](#) on page 854).
- **Time Out (RCU Ready):** The maximum delay allowed for re-establishing MCU-RCU communications following MCU power-off (see [Adding Consistency Groups \(Add CT Group\)](#) on page 854).
- **C/T:** Current consistency time of this group (For the TC390A pairs only).
- **Timer Type:** Specified timer type of this group (For the TC390A pairs only).
- **SEQCHK:** **Yes** indicates that at least one pair of this group has SEQCHK status (For the TC390A pairs only).

---

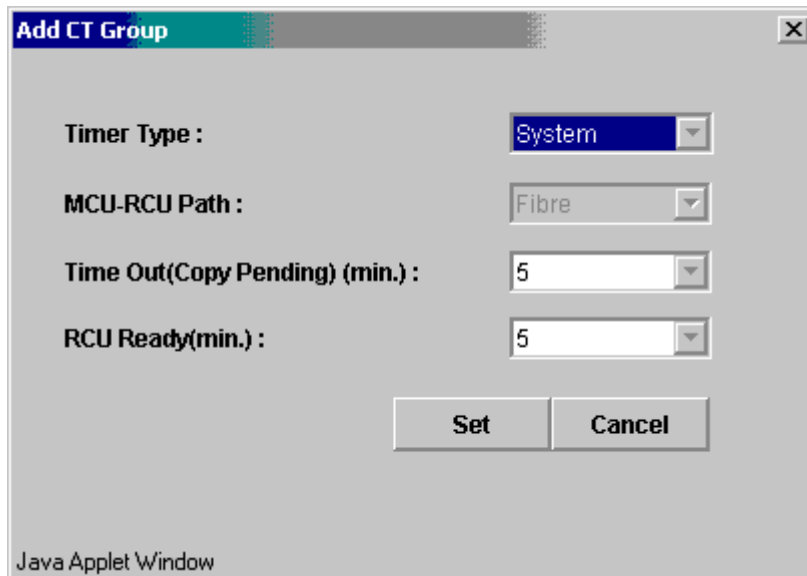
**Note:**

- The RCU manages the C/T and SEQCHK status, and the MCU acquires these from the RCU. If MCU-RCU communications are down, the MCU may not display the latest C/T and SEQCHK information. Always use the group status and R-VOL status displayed at the RCU for disaster recovery.
  - The SEQCHK status is also displayed as a TC390A pair status. To determine exactly which pair(s) in the group has the SEQCHK status, check the R-VOL pair status at the RCU.
- 

The **Previous** button displays information about the consistency group before the current consistency group. The **Next** button displays information about the consistency group after the current consistency group. The **Refresh** button refreshes the displayed information. The **Close** button closes the CT Group Status window.

## Adding Consistency Groups (Add CT Group)

The **Add CT Group** command adds a consistency group to the connected MCU. When the **Add CT Group** command is selected, the Add CT Group window is displayed. Use the Add CT Group window to select the group options for the group.



**Figure 343: Add CT Group window**

Use the **Timer Type** box to select the timer type option for the group.

- **System** = system timer (CPU TOD clock) provided by the I/O time-stamping function.
- **Local** = local timer (internal MCU TOD clock).
- **None** = system timer (CPU TOD clock) provided by the I/O time-stamping function. This timer type should be selected only when establishing TC390A pairs in the reverse direction (to copy from the secondary site back to the primary site). When **None** is selected, the MCU still acquires the time-stamp information from the host I/O time-stamping function.

Use the **MCU-RCU Path** field to select the port type (**Fibre**) for the remote copy connections.

Use the **Time Out (Copy Pending) (min.)** field to select the maximum delay allowed for TC390A copy (none or from 3 to 15 min., none = no timeout for TC390A copy pending). The default setting is five minutes. If the delay between the TC390A M-VOL update and the corresponding R-VOL update reaches the specified time, the RCU will suspend all R-VOLs in the group. A timeout occurs when the RCU was not able to settle a recordset within the specified time, or when the RCU has not had any communication from one of the MCUs in the group within the specified time.

---

**Note:** The copy pending timeout value should be less than the I/O timeout value of the host system.

---



**Caution:** For instructions on selecting the correct **Time Out (Copy Pending)** setting for your operational environment, see [step 9](#) below.

---

Use the **Time Out (RCU Ready) (min.)** field to select the maximum delay allowed for re-establishing MCU-RCU communications following MCU power-off (none or from 0 to 10 min., 0 = no timeout for TC390A RCU ready). The default setting is five minutes. If the MCU is not able to re-establish communication with the RCU within the specified time, the MCU suspends all M-VOLs in the group.

The **Cancel** button cancels the settings you made. The **Set** button sets the consistency group options you changed.

**To add a consistency group:**

1. Connect to the MCU.
2. Verify that the async options are configured as needed (refer to [Asynchronous Copy Option](#) on page 859).
3. From the Consistency Group tree, select a consistency group mode that includes the consistency group that you want to add.
4. From the Consistency Group list, select the consistency group(s) to add. Make sure to select more than one group that is not registered yet.
5. Right-click to display the pop-up menu, click **CT Group Operation**, and then click **Add CT Group**. The Add CT Group window is displayed.

6. From the Add CT Group window, select the port type (serial or fibre) and group options: copy pending timeout and RCU ready timeout. Remember that you will not be able to modify the port type of the group after you assign a pair to the group.
7. Click **Set** in the Add CT Group window. The Add CT Group window is closed and the list changes to the Consistency Group Settings Parameter list.

---

**Note:** The options can be modified and/or canceled after you have set them. See [Modifying Parameters and Omitting Consistency Groups](#) on page 861.

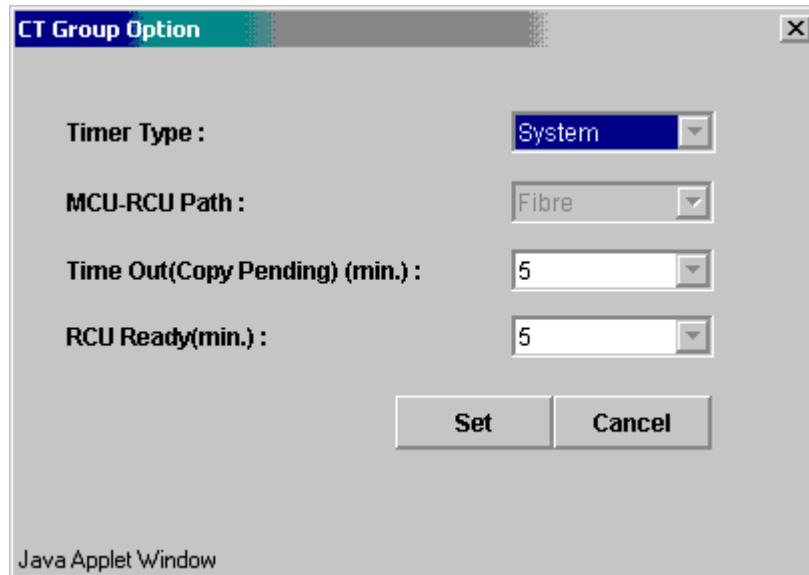
---

8. Click **Apply** on the TrueCopy main screen.
9. If you are using TC390 Async in the n-to-1 configuration, reset the **Time Out (Copy Pending)** option as follows to avoid suspension of TC390 pairs due to timeout errors:
  - a. Suspend all pairs in the group so that you can change the group options.
  - b. Select the group on the Main window, select **Group Option**, change the **Time Out (Copy Pending)** option to **None**, and select **OK**.
  - c. Resume all pairs in the group, and then perform your normal TC390 Async operations.
  - d. Acquire the current TC390 async copy delay time by calculating the difference between the host I/O time-stamp information and the consistency time shown on the CT Group Status window.
  - e. Suspend all pairs in the group again and set the **Time Out (Copy Pending)** group option to a value greater than the current copy delay time. If the value exceeds the maximum time (15 min.), reduce the host I/O rate, or set the option to **None**.
  - f. Resume all pairs in the group.

## Modifying Consistency Group Options (CT Group Option)

The **CT Group Option** command modifies the consistency group options you have set when the consistency group is added. When the **CT Group Option** command is selected, the CT Group Option window is displayed. The CT Group Option window consists of the same fields as the Add CT Group window (see [Adding Consistency Groups \(Add CT Group\)](#) on page 854).

**Note:** If you want to change the group options, you must split all pairs in the group first.



**Figure 344: CT Group Option window**

The **MCU-RCU Path** box indicates the selected port type (**Fibre**) for the remote copy connections. You cannot change the port type on the CT Group Option window.

For information about the fields you can set on the CT Group Option window, see the [Adding Consistency Groups \(Add CT Group\)](#) on page 854.

**To change the group options:**

1. Connect to the MCU.
2. Split all pairs in the group (Suspend Pair) so that you can change the group options.
3. From the Consistency Group tree, select a consistency group mode that includes the consistency group whose group option you want to modify.

4. From the Consistency Group list, select the consistency group(s) to modify the option. Make sure to select more than one consistency group whose This CU column indicates **MCU**.
5. Right-click to display the pop-up menu, click **CT Group Operation**, and then click **CT Group Option**. The CT Group Option window is displayed. If the **CT Group Option** command is not enabled, split the remaining pairs in this consistency group.
6. Change the group options as needed.
7. Click **Set** in the CT Group Option window. The CT Group Option window is closed and the list changes to the Consistency Group Settings Parameter list. The settings are applied to the list.

---

**Note:** The options can be modified and/or canceled after you have set them. See [Modifying Parameters and Omitting Consistency Groups](#) on page 861. However, Timer Type cannot be changed when there is a pair in concerned CT Group.

---

8. Click **Apply** on the TrueCopy main screen.
9. When you are finished changing group options, resume all pairs in the group (Resume Pair).

## Deleting Consistency Groups (Delete CT Group)

A consistency group can be deleted only from the MCU and only if the MCU does not contain any M-VOLs still assigned to the group. Deleting a consistency group from an MCU does not affect the consistency groups registered at other MCUs. The RCU will automatically delete a consistency group when the last volume pair in the group is deleted.

The **Delete CT Group** command deletes the selected group from the current MCU. You cannot delete a group that still has M-VOLs in the current MCU.

### To delete a consistency group from an MCU:

1. Connect to the MCU.
2. From the **Consistency Group** tree, select a consistency group mode that includes the consistency group you want to delete.
3. From the Consistency Group list, select the consistency group(s) to delete. Make sure to select more than one consistency group whose This CU column indicates **MCU**.

4. Right-click to display the pop-up menu, click **CT Group Operation**, and then click **Delete CT Group**. The list changes to the Consistency Group Settings Parameter list. If the **Delete CT Group** command is not enabled, the selected group still contains M-VOLs in this MCU.

---

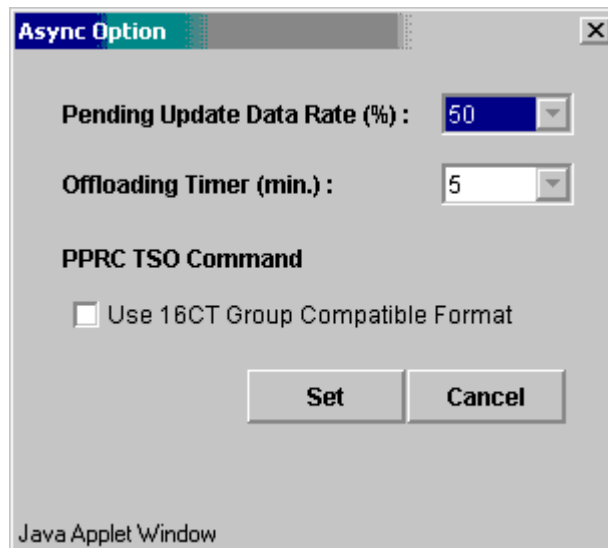
**Note:** The options can be modified and/or canceled after you have set them. See [Modifying Parameters and Omitting Consistency Groups](#) on page 861.

---

5. Click **Apply** in the TrueCopy main screen to apply the deletion to the disk array.

## Asynchronous Copy Option

Use the **Async Option** command to select the parameters for the TC390A copy operation. When the **Async Option** command is selected, the Async Option window is displayed. Use the Async Option window to specify the TC390A copy option parameters for the connected disk array. The async options apply to the entire physical control unit, including all TC390 M-VOLs and R-VOLs behind the control unit. The async options can be modified only when no TC390A pairs or groups exist in the connected CU (M-VOLs or R-VOLs).



**Figure 345: Async Option window**

All the default settings indicate the current settings.

Use the **Pending Update Data Rate (%)** field to specify the TC390A (and CA Asynchronous) sidefile threshold that is the maximum amount of cache that can be used for storing TC390 (and CA) Async recordsets (sidefiles). You can select any value between 30% and 70% (10% increments) (see [Inflow Control of Recordsets](#) on page 751). The current pending update data rate is common to both TC390 and CA operations. The most recently entered value (on the TrueCopy or CA Async Option window) will be applied to TC390A and CA Asynchronous operations. When the amount of cache being used for TC390A and CA Asynchronous recordsets reaches the specified threshold value, the MCU/RCU performs cache inflow control as follows:

- The MCU's I/O response is delayed.
- The RCU accepts only the one specific recordset that will enable it to settle the pending recordsets in the queue(s). For all other recordsets the RCU responds to the MCU with the channel-command-retry request.

---

**Note:** If one or more consistency groups exist (TC390 or CA), this setting cannot be changed. This setting can be changed only when no consistency groups are assigned.

---

Use the **Offloading Timer (min.)** field to specify the amount of time, 0-20 minutes that the MCU will wait to send a TC390A recordset to the RCU. The MCU will suspend all affected TC390A volume pairs if it has not been able to offload a recordset to the RCU within the specified time (for example, the RCU is still responding channel-command-retry).

Use the **PPRC TSO Command** option to select the XP256-compatible format for PPRC TSO commands (see [Using PPRC Commands for TrueCopy](#) on page 933). This option should be selected only if you are using XP256 as RCUs connected to this XP128/XP1024. The XP256 format limits PPRC operations to sixteen consistency groups (0-F). The disk array-compatible format (default) performs PPRC operations for all 128 consistency groups (00-7F) of the XP128/XP1024.

**To set the asynchronous option parameters:**

1. From the Consistency Group list, right-click to display the pop-up menu and click the **Async Operation** command. The Async Option window is displayed.



**Note:** You do not have to select a consistency group on the list.

---

2. From the Async Option window, select the appropriate parameters.
  3. Click **Set** to set the parameters. The list changes to the **Asynchronous Option Settings Parameter list**.
- 

**Note:** The options can be modified and/or canceled after you have set them. See [Modifying Parameters and Omitting Consistency Groups](#) on page 861.

---

4. Click **Apply** on the TrueCopy main screen to apply the option settings to the disk array.

## Modifying Parameters and Omitting Consistency Groups

After the Consistency Group (CT Group) and/or Asynchronous Option operation, the parameters can be modified individually. Also the consistency groups that you have set by the operation can be omitted.

### To modify the parameters:

1. After you have performed the **CT Group Operation**, select a consistency group whose parameters you want to modify on the list. To modify the parameters for **Async Option** operation, you do not have to select the row on the list.
2. Right-click to display the pop-up menu and click **Modify** to modify the parameters. A window for each operation is displayed.
3. Modify the parameters as needed and click **Set**.
4. Click **Apply** on the TrueCopy main screen.

### To omit the consistency groups: from the operation

1. Select the consistency groups to be omitted from the operation on the list.
2. Right-click to display the pop-up menu and click **Omit**. The Consistency Groups selected in [step 1](#) are deleted from the list and the deleted Consistency Groups have been removed from the operations.
3. Click **Apply** on the TrueCopy main screen to apply the deletion to the disk array.

For the **CT Group Operation**, the **Cancel All** command deletes all the consistency groups on the list and all the consistency groups have been removed from the operations. All the consistency groups can also be deleted using the **Omit** command by selecting all of the consistency groups on the list. When all the consistency groups are deleted (by the **Cancel All** command or the **Omit** command), the list status becomes the Volume list.

For the Asynchronous Option operation, the Delete command is not available. You can either modify the options you have set or cancel all the option settings you made.

---

**Note:** After the delete operation of the **CT Group Operation** command, the **Modify** command is not available.

---

## Usage Monitor Operations

Use the Usage Monitor screen to perform the remote copy usage monitoring operations for the connected disk array. The remote copy usage monitoring function can collect I/O statistics for all LDEVs on the connected disk array.

The usage monitor operations are:

- Starting and stopping monitoring (see page 862)
- Displaying the usage monitor graph (see page 863)

## Starting and Stopping Monitoring

At each data sampling time interval, the usage monitoring function collects 480 pieces of data for each LDEV and up to 16,385 pieces of data for the entire disk array.

### To start monitoring:

1. From the Usage Monitor screen, enter the sampling time interval in minute(s) in the **Rate** drop-down list. You can enter from 1 to 546 minutes. Entering more than five minutes is recommended.
2. Click **Run** in the **Operation** drop-down list.
3. Click **Apply**.

The collection of monitoring data continues, even if the window is closed, until you stop monitoring operations. Monitoring data collection continues even if the SVP is rebooted. If a monitor starts, the data of the sidefile usage is stored.

**To stop monitoring:**

1. From the Usage Monitor screen, click **Stop** in the **Operation** drop-down list.
2. Click **Apply**. The monitoring process is stopped.

**Displaying the Usage Monitor Graph**

When usage monitoring is running, the Usage Operations screen can display user-selected remote copy I/O statistics in real time. The I/O statistics data is collected according to the data-sampling rate selected in the Rate drop-down list.

The usage monitor graph plots the user-selected I/O statistics (up to 65 data points) on an x-y graph. The x-axis displays time and the y-axis displays the number of I/Os during the last sampling period. The legend is displayed on the right side of the graph. When the value for y-axis exceeds 10,000,000, the value is displayed in exponential notation. For example, 1E7 =  $1 \times 10^7 = 10,000,000$ ; 2E8 =  $2 \times 10^8 = 200,000,000$ . The **Update** field displays the most recent data sample time for the data graph.

**To display the usage monitor graph:**

1. Verify that the usage monitoring is running. Status should be **Running**.
2. In the graph area of the Usage Monitor window, right-click to display the pop-up menu and click **Display Item**. The Display Item window is displayed.

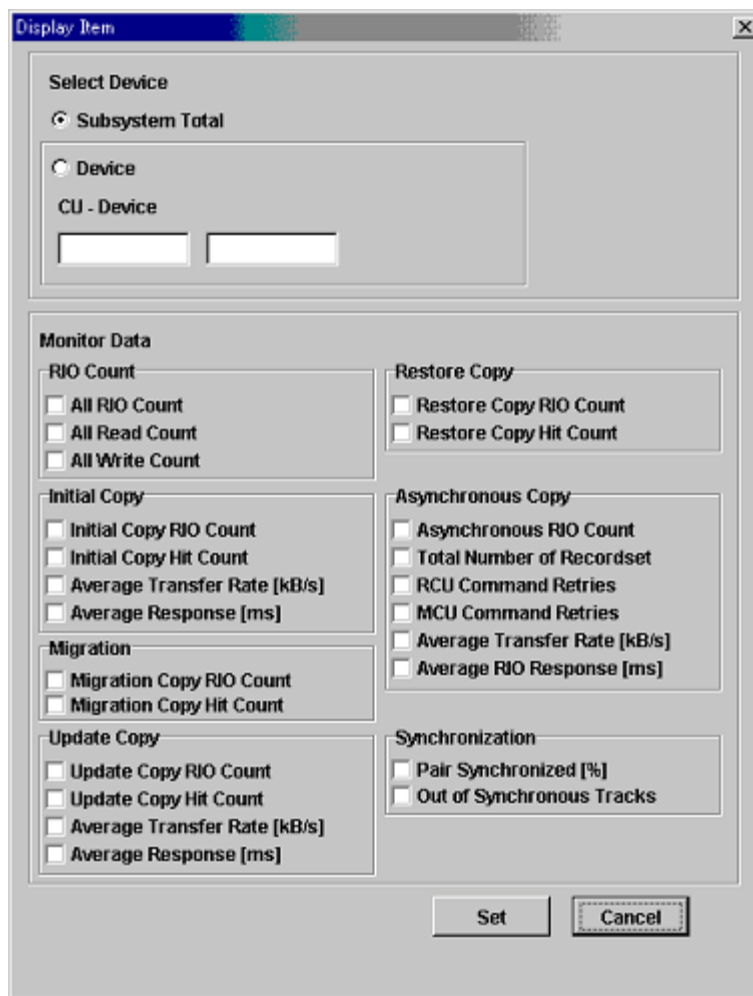


Figure 346: Display Item window

3. In the **Select Device** box of the Display Item window, click one:
  - **Subsystem Total**: The I/O statistics data of all the LDEVs in the disk array is displayed.
  - **Device**: An LDEV of the CU image can be selected. In the **CU** field, 00-1F can be entered. In the **Device** field, 00-FF can be entered. If a device that is not installed is entered, the graph is not displayed.

4. In the **Monitor Data** box of the Display Item window, select the I/O statistics data to display on the graph. More than one check box needs to be selected.
5. Click **Set** to close the Display Item window. The Usage Operations screen now displays a graph showing the selected I/O statistics data for the selected LDEV(s).

To enlarge the displayed graph, right-click on the graph and click **Large Size**. To return the graph to normal size, right-click on the graph and click **Normal Size**.

#### To close the graph:

1. In the graph display area, right-click on the graph you want to close.
2. Click **Close** from the pop-up menu, or click **Close All** to stop displaying all the graphs. A confirmation dialog box is displayed.
3. Click **OK**.

Other methods of closing the graph:

- Select another tab.
- Select another program product or exit Command View.
- Select **Stop** in the **Operation** box of the Usage Monitor window and click **Apply**.

The following table lists and describes the I/O statistics that can be selected on the **Monitor Data** box of the Display Item window.

**Table 96: I/O statistics**

Statistic	Description
<b>RIO count</b>	
All RIO count	Total number of remote I/Os
All read count	Total number of remote read I/Os
All write count	Total number of remote write I/Os
<b>Initial Copy</b>	
Initial copy RIO count	Number of initial copy remote I/Os
Initial copy hit count	Number of initial copy hits
Average transfer rate (KB/S)	Average transfer rate (KB/sec) for initial copy remote I/Os
Average response (ms)	Average response time (msec) for initial copy remote I/Os

**Table 96: I/O statistics (Continued)**

Statistic	Description
<b>Migration Copy</b>	
Migration copy RIO count	Number of migration copy remote I/Os
Migration copy hit count	Number of migration copy hits
<b>Update Copy</b>	
Update copy RIO count	Number of update copy remote I/Os
Update copy hit count	Number of update copy hits
Average transfer rate (KB/S)	Average transfer rate (KB/sec) for update copy remote I/Os
Average response (ms)	Average response time (msec) for update copy remote I/Os
<b>Restore Copy</b>	
Restore copy RIO count	Number of restore copy remote I/Os
Restore copy hit count	Number of restore copy hits
<b>Async. Copy</b>	
Async. RIO count	Number of asynchronous update copy remote I/Os
Total number of recordsets	Number of TC390A recordsets
RCU command retries	Number of command retries due to RCU channel-command-retry messages.
MCU command retries	Number of command retries due to MCU SCP messages.
Average transfer rate (kB/sec)	Average transfer rate (kB/sec) for TC390/TC async update copy remote I/Os
Average RIO response (ms)	(Total RIO process time on a subsystem or selected volume for a certain interval period) / (Asynchronous RIO count); where RIO process time = time between the asynchronous data transfer request and the actual transfer of the recordset(s) to the RCU.
<b>Synchronization</b>	
Pair Synchronized (%)	Percent completion of the initial copy operation (number of synchronized pairs / total number of pairs). For <i>duplex</i> TC390 Synchronous pairs, this value is always 100% after the initial copy operation is complete.
Out of Sync Tracks	Number of tracks that have not yet been copied by the initial copy or resync copy operation (this applies only when suspended during initial copy or during resync copy).

**Note:** Migration Copy and Restore Copy apply only to internal use. All other RIO statistics include both TC390 and TC remote copy operations (async RIO count = TC390A RIOs + TCA RIOs). However, Synchronization is not supported for this version.

---

## Script Operations

At this time, exporting script trace files is not supported. For more information about the Script Operations screen, refer to [Script Operations Screen](#) on page 816.

## History Operations

At this time, exporting history files is not supported. For more information about the History screen, refer to [History Screen](#) on page 819.

## Other Operations

Click the **Clear SIM** button on the Other Operations screen to clear all remote copy SIMs (service information messages) from the connected disk array. Remote copy SIMs include all SIMs issued for TC390 and CA operations.

The clear SIM function is intended for use during disaster recovery operations, while switching operations to the remote (secondary) backup site. Please see [Switching Operations to the Remote Site](#) on page 918 for specific instructions on clearing remote copy SIMs during disaster recovery operations.

### To clear all remote copy SIMs from the disk array:

1. Click the **Other Operations** tab, and then click **Clear SIM**.
2. From the Clear SIM confirmation window, click **Yes** to clear all remote copy SIMs from the connected disk array, or click **No** to cancel your request to clear SIMs.
3. If you clicked **Yes**, the disk array verifies that the existing SIMs are being cleared.

## Optimizing TrueCopy Operations and Disk Array Performance

All TC390 operations result in increased utilization of the disk array's channel resources because of the additional write (remote copy) operations to the secondary volumes. The TC390 update copy mode (synchronous or asynchronous) determines exactly how the remote copy operations will impact disk array performance as follows:

- **Synchronous** copy mode (TC390 Synchronous) has an additional effect on disk array performance: increased service and disconnect time for write I/Os to TC390 M-VOLs due to the delay between channel-end and device-end. The length of this delay increases as the distance between the M-VOL and R-VOL increases so that the longest delay occurs when the main and remote volumes are the maximum distance apart.
- **Asynchronous** copy mode (TC390A) eliminates all delays associated with TC390 Synchronous operations while providing increased protections for write-dependent applications in the event of a disaster. Write I/Os for TC390A M-VOLs are processed in the same way as writes for simplex volumes, without any increase in service or disconnect time. The asynchronous R-VOL updates are performed completely independent of all host I/O processes at the M-VOLs and there are no restrictions on subsequent read/write operations to TC390A M-VOLs. The only performance concerns for TC390A are ensuring that adequate cache resources are available for sidefiles that are used to store the recordsets at both the MCUs and RCUs, and ensuring that sufficient ESCON paths are defined for copy operations.

In addition to the TC390 update copy mode, several other factors can also affect XP128/XP1024 performance. You can optimize both the TC390 operations and the I/O performance of the disk arrays by analyzing workloads and addressing system-level conditions (for example, number of ESCON paths) that can affect disk array performance. You can also control the impact of TC390 operations on disk array performance by selecting the appropriate RCU options for each MCU (see [Registering an RCU \(Add RCU\)](#) on page 830) and the appropriate update copy mode (synchronous or asynchronous) and pair options (see [Creating TrueCopy Volume Pairs \(Add Pair\)](#) on page 880) for each TC390 pair. In addition, you can upgrade the TC390 hardware components and/or adjust the configuration of the components to improve disk array performance under a wide range of operating conditions. The following table lists some of the conditions that affect disk array performance and provides recommendations for addressing these conditions.



**Table 97: Optimizing TrueCopy operations and XP128/XP1024 performance**

Condition	Description	Recommendation(s)
Write-intensive workloads	Write-intensive workloads, such as SPOOL volumes and database logging volumes, can have a significant impact on disk array I/O response times.	Spread write-intensive data across several volumes to minimize queuing. Also consider increasing the duplex write line (DWL) of the disk array using Performance Manager.
Large block size	Workloads with large write block sizes, such as DB2 deferred writes, can impact performance.	Spread workloads with large write block sizes across several volumes.
High host channel demand	The demand on the MCU's host channels can affect performance.	Spread the workload across several disk arrays to use additional channels.
Sequential write operations	TC390 operations can have a negative impact on workloads with a high percentage of sequential write operations, such as batch processing operations (for example, dump/restore or sort operations).	Avoid performing restore operations to volumes that belong to TC390 pairs. Instead, restore data to a scratch volume and then establish the TC390 volume pair.

**Table 97: Optimizing TrueCopy operations and XP128/XP1024 performance (Continued)**

Condition	Description	Recommendation(s)
Cache size	<p>Large cache size improves read hit performance, which allows more disk array resources to be devoted to write operations. The resulting performance improvement can offset some or all of the performance loss due to the TC390 remote copy operations.</p> <p>TC390A and HXRC require additional cache for sidefile data. Insufficient cache resources can result in command retries, SCP notifications, and puncture conditions.</p>	<p>Consider increasing the cache size of the TC390 disk arrays to handle TC390A and HXRC sidefile operations and to improve overall disk array performance. For best results, the cache and NVS capacity of the main and remote disk arrays should be the same (for TC390A the RCU sidefile requirements are 2x that of the MCU) to enable the remote site to function adequately during disaster recovery.</p>
RCU capacity	<p>The performance of the RCUs directly affects the performance of the MCUs. If an RCU becomes overloaded with heavy update activity, MCU and system performance can also be degraded.</p>	<p>Distribute TC390 remote copy operations among several remote disk arrays to avoid overloading any one RCU.</p>
ESCON paths	<p>An inadequate number of ESCON paths may decrease disk array performance. Performing TC390 Synchronous operations over long distances can also degrade disk array performance. TC390A is recommended for long distances.</p>	<p>Make sure to install an adequate number of ESCON paths between the main and remote disk arrays. This is especially important for disk arrays that contain both M-VOLs and R-VOLs.</p>

## Discontinuing TrueCopy Operations

If you plan to use TC390 for nondisruptive data migration or duplication (see [ICKDSF Considerations for TrueCopy Volumes](#) on page 905), you will need to configure and establish TC390 operations, allow TC390 to synchronize the volumes, redirect application I/Os (if migrating), and then discontinue TC390 operations. When you are ready to discontinue TC390 operations, you will need to perform TC390 operations in the correct order to avoid generating error messages. For example, you cannot delete an RCU path until you have deleted all TC390 pairs still using that path and you cannot delete a group until you have deleted all TC390A pairs in that group.

**To discontinue all TC390 operations:**

1. Delete all TC390 pairs from the MCU(s) (Delete Pair, see [Deleting TrueCopy Volume Pairs \(Delete Pair\)](#) on page 898). For TC390A pairs, you can use the **Delete Range-Group** option to delete all pairs in a group using just one operation. Verify that the pair status has changed to Simplex for all TC390 volumes before continuing.
2. Delete the TC390A group(s) from the MCU(s) (see [Deleting Consistency Groups \(Delete CT Group\)](#) on page 858). The RCU will automatically delete a group when all pairs in the group have been deleted.
3. Delete the RCUs (see [Deleting an RCU \(Delete RCU\)](#) on page 842). Check each CU image of each MCU to verify that all RCUs have been deleted before continuing.
4. Remove the remote copy connections (physical paths). If you are not familiar with the operation of the remote copy hardware components (for example, ESCON directors, repeaters, and switches), call HP technical support for assistance.
5. For serial interface, reset the RCP(s) to LCP(s) at the MCU(s). For Fibre Channel interface, reset the initiator port(s) to ordinary target(s) at the MCU(s).

## Performing TrueCopy Pair Operations

### Preparing for TrueCopy Volume Pair Operations

Before starting TC390 operations, you must consider the relative importance of disk array I/O performance and disaster recovery preparation. As described in [Optimizing TrueCopy Operations and Disk Array Performance](#) on page 868, remote copy operations can affect the I/O performance of the MCUs and RCUs. TC390 provides many options, such as initial copy options, pair options, group options, and async options, that controls the impact of TC390 operations on I/O performance. These options can be set separately for each pair, for each TC390A group, and for each MCU to provide maximum flexibility. You can select options that minimize the impact of TC390 operations on disk array performance, or options that maximize the effectiveness of TC390 operations to ensure the best level of backup data integrity. System-level factors (for example, number of paths) can also affect TC390 operations and disk array performance (see [Table 97](#) on page 869).

For TC390 disaster recovery operations, you should verify that the RCUs are attached to a host server to enable reporting of sense information and transfer of host failover information. If the remote site is unattended, attach the RCUs to a host server at the main site so that the system administrator can monitor the operational condition of the RCUs.

To prepare for TC390 volume pair operations, you need to identify the volumes by LDEV ID for which you want to establish TC390 remote copy operations. You should identify volumes that are required for system operation as well as volumes that contain important data to be backed up (for example, DB log files). Copying these volumes to the remote site will enable faster disaster recovery than maintaining a current version of these files at the remote site. For large databases that span multiple volumes, you should plan to establish a TC390A consistency group for each database so that the update sequence consistency of the database can be ensured at the remote site.

You can start creating the TC390 volume pairs as soon as you have:

- Identified the volumes that will become the TC390 M-VOLs (and R-VOLs)
- Ensured that all system and TC390 requirements have been met (see [System Requirements](#) on page 771 and [Requirements and Restrictions](#) on page 773)
- Completed hardware and software installation (see [Installing the TrueCopy Hardware](#) on page 777 and [Installing the TrueCopy Software](#) on page 784)
- Configured the MCUs and RCUs for TC390 operations (see page 785)

**Note:** TC390 and SI390 can function together in the same XP128/XP1024 to provide both internal and remote backup for your data. If you are planning to combine TC390 and SI390, read the important configuration information in [Combining TrueCopy with Other Data Management Operations](#) on page 791.

---

If you will be using the TC390 software to perform remote copy operations, the management station must be LAN-attached to the MCU of each TC390 volume pair. You should also install and attach a management station to the RCUs at your remote site. If you will be using PPRC commands instead of Command View, contact your HP account team for information on TC390 configuration services. The following TC390 operations cannot be performed using PPRC commands: asynchronous options, group addition/deletion, and group options. For more information on using PPRC commands with the XP128/XP1024, see [Using PPRC Commands for TrueCopy](#) on page 933.

## Common Procedure for TrueCopy Pair Operation

From the Pair Operations screen (see [TrueCopy Main Screen \(Pair Operations Screen\)](#) on page 801), you can perform the pair setting operations. All the operations that can be performed from the Pair Operations screen have a common procedure.

### To perform the pair settings operation:

1. Select a CU number in the CU Number tree.

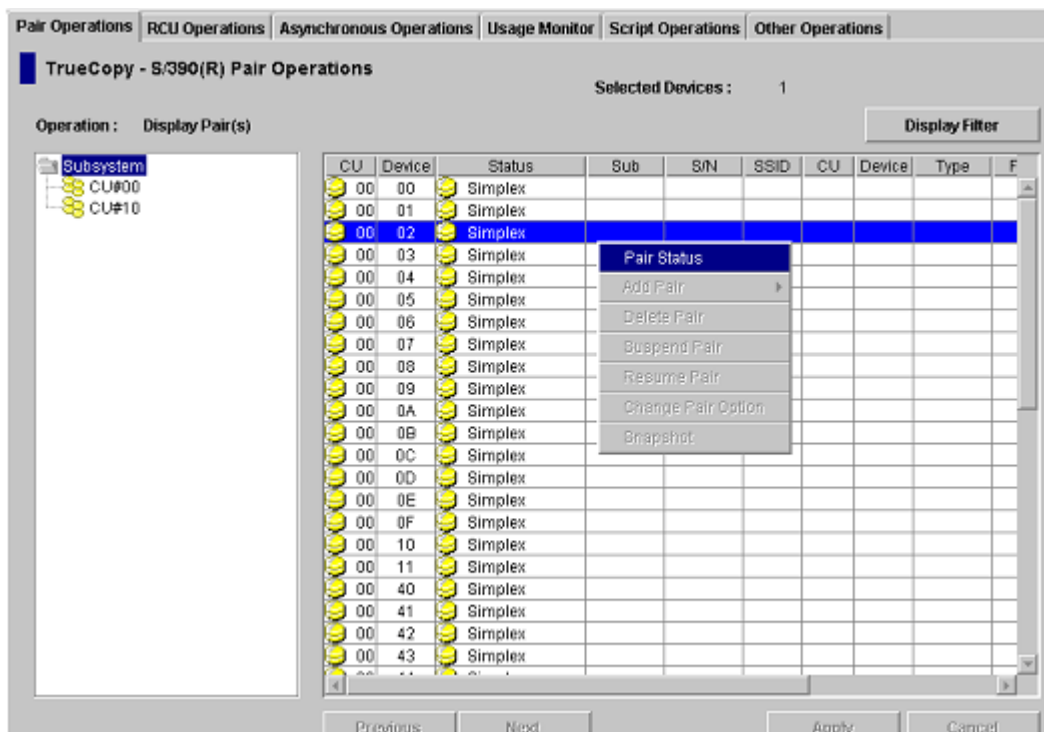
---

**Note:** A CU number must be selected in the tree.

---

2. Select one or more devices or pairs in the Volume list.
3. Right-click to display the pop-up menu (see the following figure). The pop-up menu consists of the following:
  - **Pair Status:** Displays the volume status (see [Viewing the Status of TrueCopy Volume Pairs \(Pair Status\)](#) on page 876).
  - **Add Pair:** Creates a volume pair using the following commands: **Synchronous** and **Asynchronous** (see [Creating TrueCopy Volume Pairs \(Add Pair\)](#) on page 880).

- **Delete Pair:** Deletes the pairs (see [Deleting TrueCopy Volume Pairs \(Delete Pair\)](#) on page 898).
- **Suspend Pair:** Splits (Suspends) the pairs (see [Suspending TrueCopy Pairs \(Suspend Pair\)](#) on page 890).
- **Resume Pair:** Resumes the pairs (see [Resuming TrueCopy Volume Pairs \(Resume Pair\)](#) on page 894).
- **Change Pair Option:** Changes the pair option (see [Changing the Pair Options \(Change Pair Option\)](#) on page 903).
- **Snapshot:** Creates the snapshot file (see [Snapshot Function](#) on page 807).



**Figure 347: TrueCopy main screen (Pair Operations screen)**

4. Select a command and use the window to make your settings.
5. Click **Set**.

**Note:** The options can be modified and/or canceled after you have set them. See [Modifying Parameters and Omitting Selected Volumes](#) on page 875.

---

6. Click **Apply** on the TrueCopy main screen.

The status of the command (active or inactive) depends on the status of the volumes selected in the Volume list.

The following sections describe in detail for each command and operation.

### List after the Command Selection

After the window is closed, only the Volumes selected in [step 2](#) of the procedure described in the [Common Procedure for TrueCopy Pair Operation](#) on page 873 are displayed in the list. The items of the list are also changed. The Volume list that is in this status is called the Pair Settings Parameter list. The items of the Pair Settings Parameter list depend on the command selected from the pop-up menu and the operation you performed. The items for each command are described in the sections.

Use the **Set** button on each parameter window to preset the parameters to the Pair Settings Parameter list. To apply the parameters to the system, click **Apply** on the TrueCopy main screen.

The **Cancel** button closes the window, but does not set the parameters. The **Cancel All** button returns you to the Volume list.

### Modifying Parameters and Omitting Selected Volumes

After the pair settings operation, the volume parameters can be modified individually. Also the volumes that are selected to be the pairs can be omitted from the pair operation.

#### To modify the parameters of a volume:

1. Select a volume whose parameters to be modified on the **Pair Settings Parameter list**.
2. Right-click to display the pop-up menu and click **Modify** to modify the parameters. A window is displayed.
3. Modify the parameters and click **Set**.
4. Click **Apply** on TrueCopy main screen.

**To omit the selected volumes:**

1. Select the volumes to be omitted from the operation on the **Pair Settings Parameter list**.
2. Right-click to display the pop-up menu and click **Omit**. The volumes selected in [step 1](#) are deleted from the **Pair Settings Parameter list** and the deleted volumes have been removed from the pair settings operations.
3. Click **Apply** on the TrueCopy main screen.

The **Cancel All** command deletes all the volumes listed on the **Pair Settings Parameter list** and all the volumes have been removed from the pair settings operations. All the volumes can also be deleted from the list using the **Omit** command by selecting all of the volumes on the **Pair Settings Parameter list**. When all the volumes are deleted from the list (by the **Cancel All** command or the **Omit** command), the list status becomes the Volume list.

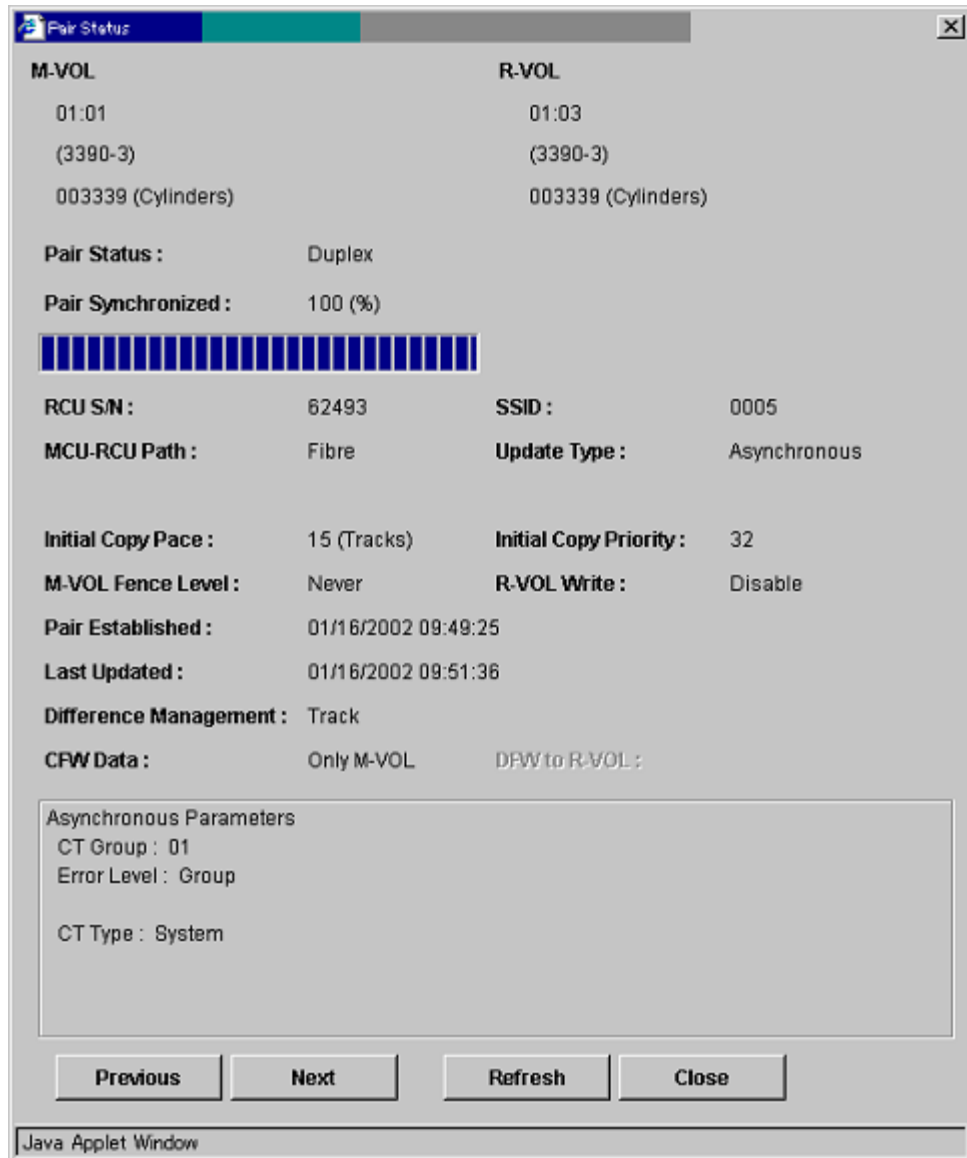
## Viewing the Status of TrueCopy Volume Pairs (Pair Status)

The **Pair Status** command can be used to display the TC390 pair status information in detail.

**To display the TC390 pair status information:**

1. From the tree, select **Display All** or a **CU number**. The **Pair Status** command can be selected when **Display All** or **CU number** is selected in the tree.
2. From the Volume list, select a volume whose pair status information to be displayed.
3. Right-click and click **Pair Status** from the pop-up menu. The Pair Status window is displayed.





**Figure 348: Pair Status window**

- **M-VOL and R-VOL:** The first row: CU number and Device ID of the selected volume. The second row: Device emulation name. The third row: Capacity in cylinders.

- **Pair Status:** Simplex, Pending, Duplex, suspended, suspending, Deleting, Suspended (Continue), or Suspending (Continue). For more information for TC390 pair status, see [TrueCopy Volume Pair Status](#) on page 759. If the pair is split or suspended, the split/suspended type is also displayed.
- **Pair Synchronized:** Displays how far the initial copy operation progressed in percentage and the progress bar.
- **RCU S/N and SSID:** Serial number and SSID of the RCU (or MCU if R-VOL is selected).
- **MCU-RCU Path:** Channel type of the path interface between the disk arrays (Serial or Fibre).
- **Update Type:** Synchronous or Asynchronous.
- **Initial Copy Pace:** 3 tracks or 15 tracks (displayed during initial copy and resume copy).
- **Initial Copy Priority:** 1 - 256 (displayed during initial copy and resume copy).
- **M-VOL Fence Level:** Conditions under which the MCU will reject write operations to the M-VOL. **Never:** Never fence the operation. **Data:** Fence when the MCU cannot successfully execute an update copy operation for any reason. **Status:** Fences only if the MCU is not able to change the R-VOL status to the same status as the M-VOL.
- **R-VOL Write:** Enabled (Write operation to the R-VOL is enabled) or disabled (Write operation to the R-VOL is disabled) for this pair. The Write operation to the R-VOL is enabled only when the Asynchronous pair is split. However, Enabled is not usually recommended. When R-VOL Write Enabled is required, contact your HP account team.
- **Pair Established:** The date and time that the volume pair was created.
- **Last Updated:** The date and time that the volume pair status was last updated.
- **Difference Management:** **Auto**, **Cylinder**, or **Track**.
- **CFW Data:** The **CFW Data** option specifies whether the CFW data will be copied to the R-VOL:
  - If **Copy to R-VOL** is selected, the MCU will copy the CFW data to the R-VOL.

- If **Only M-VOL** is selected, the MCU will not copy the CFW data to the R-VOL. This setting is recommended for two reasons: (1) copying the CFW data impacts disk array performance and (2) CFW data is typically used for temporary files (for example, sort work datasets) that are not usually required for disaster recovery.

---

**Note:** If a TC390 pair is established using PPRC commands, the CFW data option is set to the **Copy to R-VOL** setting.

---

- **DFW to R-VOL:** The **DFW to R-VOL** option (TC390 Synchronous only) specifies whether the MCU will suspend a TC390 volume pair when the RCU cannot execute DFW to the R-VOL:
  - If **DFW not required** is selected, the MCU will not suspend the TC390 volume pair when DFW on the RCU is blocked. This option is recommended if you need to maintain synchronization of the TC390 volume pair.

---

**Note:** If a TC390 pair is established using PPRC commands, the **DFW to R-VOL** option is set to **not required**.

---

- If **DFW required** is selected, the MCU will suspend the pair when DFW on the RCU is blocked. This option is recommended if you need to maintain high MCU I/O performance.



**Caution:** The interaction of the **DFW required** setting and the M-VOL fence level setting can cause a host application to fail with a permanent I/O error when attempting to update an M-VOL. Keep track of which volume pairs have the **DFW required** setting and verify that the DFW to the R-VOL is not blocked.

---

**Note:** The DFW to R-VOL setting does not affect the I/O performance of the M-VOLs. If one side of cache is closed due to an RCU failure, the TC390 copy operation still uses DFW. The only difference between **not required** and **required** is that new pairs cannot be established with the **DFW-to-R-VOL required** option when one side of RCU cache is closed (the add pair operation fails).

---

- **Asynchronous Parameter** box consists of the following:
  - **CT Group**: Consistency group to which the TC390A pair is assigned.
  - **Error Level**: Error level for the TC390A pair(s)
  - **C/T Type**: Timer type of the consistency group (System, Local or None).
  - **Consistency time**: Consistency time of the group to which the TC390A pair is assigned
  - **SEQCHK**: Displayed when the TC390A pair has the *SEQCHK* status. This status is managed by the RCU and the MCU may not have the most current information. Always use the R-VOL pair status information displayed at the RCU for disaster recovery.
- The **Previous** button changes the displayed pair status information to that of the previous Volume on the Volume list (the Volume of the row above). The **Next** button changes the displayed pair status information to that of the next Volume on the Volume list (the Volume of the row below). The **Refresh** button refreshes the pair status information. The **Close** button closes the Pair Status window.

---

**Note:** The Display Filter settings can affect how Previous or Next is recognized. The Volume list can display 256 rows at once. Therefore, the **Previous** and the **Next** buttons can be used to display the 256 rows at once.

---

## Creating TrueCopy Volume Pairs (Add Pair)

The **Add Pair** command creates one or more new TC390 pairs. When the **Add Pair** command is selected, the Add Pair window is displayed. Use the Add Pair window to select the R-VOL, RCU, and initial copy options for the pair(s) being created.

---

**Note:** Make sure to select the appropriate CU image before creating any TC390 pairs.

---

**Add Pair (Synchronous)**

**CU:Device**

M-VOL : 02:00

R-VOL : 00

RCU : 65535 1E 1234 Fibre

M-VOL Fence Level : Never

**Initial Copy Parameters**

Initial Copy : Entire

Initial Copy Pace : 15

Priority : 32 (From 1 to 256)

Difference Management : Track

CFW Data : Only M-VOL

DFW to R-VOL : DFW not Required

Set Cancel

Java Applet Window

**Figure 349: Add Pair (Synchronous) window**

**Add Pair (Asynchronous)**

**CU:Device**

M-VOL : 01.0F

R-VOL : 00

RCU : 62492 01 0005 Fibre

M-VOL Fence Level : Never

**Initial Copy Parameters**

Initial Copy : Entire

Initial Copy Pace : 15

Priority : 32 (From 1 to 256)

Difference Management : Track

CFW Data : Only M-VOL

**Asynchronous Parameters**

CT Group : 08

Error Level : Group

Set Cancel

Java Applet Window

**Figure 350: Add Pair (Asynchronous) window**

**Note:** When you set the several pairs at once and you want to keep some of the individual settings, leave the parameter box blank. Then, only the parameters you enter are available.

- **M-VOL:** Device ID of the M-VOL.
- **R-VOL:** Select the R-VOL device ID for the specified M-VOL. If you selected more than one volume, R-VOLs will automatically be assigned to the rest of the selected M-VOLs based on device ID. For example, if you select three volumes on the Volume list and select LUN01 as R-VOL for the first M-VOL, R-VOLs of the following M-VOLs are LUN02 and LUN03.

---

**Note:** Verify all the assigned R-VOLs are available. If the automatically assigned R-VOLs are already used for the other operation, you have to modify the R-VOL individually (see [Modifying Parameters and Omitting Selected Volumes](#) on page 875 for instructions).

---

- **RCU:** Select an RCU (Serial number, CU number, SSID, and Port type) for the TC390 pair(s) being created. The RCUs that are already registered can be selected from the drop-down list. The RCU must be the same for all pairs being created during this operation.
- **M-VOL Fence Level:** The **M-VOL Fence Level** option (TC390 Synchronous only) specifies the conditions under which the MCU will reject write operations to the M-VOL, which is known as “fencing.” This option is very important for disaster recovery planning (see [Considering the M-VOL Fence Level Setting](#) on page 914). TC390A M-VOLs are never fenced.
  - If **Data** is selected, the M-VOL will be fenced when the MCU cannot successfully execute an update copy operation for any reason. This setting is functionally equivalent to the CRIT(YES-ALL) parameter for the CESTPAIR command.
  - If **Status** is selected, the M-VOL will be fenced only if the MCU is not able to change the R-VOL pair status to suspended when an update copy operation fails. If the MCU changes the R-VOL pair status to suspended, subsequent write operations to the M-VOL will be permitted and the MCU will keep track of all updates to the M-VOL while the pair is suspended. This setting is functionally equivalent to the CRIT(YES-PATHS) parameter for the CESTPAIR command.
  - If **Never** is selected, the M-VOL will never be fenced. If the TC390 volume pair is suspended, write operations to the M-VOL will be accepted. This setting is functionally equivalent to the CRIT(NO) parameter for the CESTPAIR command.

■ **Initial Copy Parameters:** Select the initial copy options.

- **Initial Copy.** This option specifies the initial copy mode for the new pair(s).

If **Entire** is selected, the initial copy operation will copy all cylinders on the M-VOL (except diagnostic and unassigned alternate tracks) to the R-VOL. This setting is functionally equivalent to the `MODE=COPY` parameter for the `CESTPAIR` command.

If **No Copy** is selected, the initial copy operation will not be performed. The MCU will begin performing update copy operations as needed. This setting is functionally equivalent to the `MODE=NOCOPY` parameter for the `CESTPAIR` command.



**Caution:** The user must ensure that the M-VOL and R-VOL are already identical when using this setting.

---

- The **Initial Copy Pace** option specifies the maximum number of tracks that can be copied at one time by the TC390 initial copy operation before the MCU accepts another host request:

The **15 Tracks** setting speeds up the initial copy operation, but may affect the disk array's I/O performance if the M-VOL is experiencing high write I/O activity. This setting is functionally equivalent to the `PACE=2-255` parameter for the `CESTPAIR TSO` command.

The **3 Tracks** setting slows down the initial copy operation to minimize the impact of the initial copy operation on the disk array's I/O performance. This setting is functionally equivalent to the `PACE=1` parameter for the `CESTPAIR` command.

- **Priority (From 1 to 256):** The initial copy priority specifies the order in which the initial copy operations will be performed if the number of requested initial copy operations is greater than the maximum initial copy activity setting on the RCU Option window (see [Registering an RCU \(Add RCU\)](#) on page 830). The highest priority is 1 and the lowest priority is 256 (current default = 32). The TC390 initial copy priority option can be used to spread initial copy operations across disk array groups and/or disk array domains (ACP pairs) to reduce initial copy time as well as host I/O contention.



*Example:* The maximum initial copy activity setting is 4 and you add 6 TC390 pairs at the same time (for LDEVs 00 through 05) with the initial copy priority set as follows:

M-VOL of TC390 pair	Priority
LDEV 03	1
LDEV 05	2
LDEV 00	3
LDEV 04	4
LDEVs 01, 02	5

The MCU will start the initial copy operations for LDEVs 03, 05, 00, and 04 immediately, then start LDEV 01 when one of the first four initial copy operations is complete, and then start LDEV 02 when the next initial copy operation is complete. If additional TC390 pairs are added, the MCU also prioritizes the initial copy operations by time requested so that all TC390 pairs in the first group are started before any pair in the next group is started.

---

**Note:** The CESTPAIR TSO command does not support the initial copy priority option. When CESTPAIR is used to establish TC390 pairs, the initial copy operations are performed in the order that the CESTPAIR commands are issued.

---

- **Difference Management:** Select **Auto**, **Cylinder**, or **Track** as the basis for managing the differential data. The default is **Auto**. When you select **Auto**, either **Cylinder** or **Track** is selected depending on the basic size of the logical volume image.
- The **CFW Data** option specifies whether the CFW data will be copied to the R-VOL:
  - If **Copy to R-VOL** is selected, the MCU will copy the CFW data to the R-VOL.
  - If **Only M-VOL** is selected, the MCU will not copy the CFW data to the R-VOL. This setting is recommended for two reasons: (1) copying the CFW data impacts disk array performance and (2) CFW data is typically used for temporary files (for example, sort work datasets) that are not usually required for disaster recovery.

**Note:** If a TC390 pair is established using PPRC commands, the CFW data option is set to the **Copy to R-VOL** setting.

---

**Note:** By using Remote Copy Function Switch, you can set the following option with CESTPAIR: CFW data = only M-VOL. If you want to use this function, please contact your HP account team.

---

- The **DFW to R-VOL** option (TC390 Synchronous only) specifies whether the MCU will suspend a TC390 volume pair when the RCU cannot execute DFW to the R-VOL:

If **DFW not required** is selected, the MCU will not suspend the TC390 volume pair when DFW on the RCU is blocked. This option is recommended if you need to maintain synchronization of the TC390 volume pair.

**Note:** If a TC390 pair is established using PPRC commands, the **DFW to R-VOL** option is set to **not required**.

---

If **DFW required** is selected, the MCU will suspend the pair when DFW on the RCU is blocked. This option is recommended if you need to maintain high MCU I/O performance.



**Caution:** The interaction of the **DFW required** setting and the M-VOL fence level setting can cause a host application to fail with a permanent I/O error when attempting to update an M-VOL. Keep track of which volume pairs have the **DFW required** setting and verify that DFW to the R-VOL is not blocked.

---

**Note:** The DFW to R-VOL setting does not affect the I/O performance of the M-VOLs. If one side of cache is closed due to an RCU failure, the TC390 copy operation still uses DFW. The only difference between **not required** and **required** is that new pairs cannot be established with the **DFW-to-R-VOL required** option when one side of RCU cache is closed (the add pair operation fails).

---

- **Asynchronous Parameters:** Can be selected only for the Asynchronous pair(s).
  - **CT Group: C/T Group.** This option specifies the consistency group for the pair(s) being added (TC390A only). All TC390A pairs must be assigned to a consistency group.

---

**Note:** The CESTPAIR command can be used to start TC390A pairs and assign them to groups, but the groups must already be configured (using the Add C/T Group window, see [Adding Consistency Groups \(Add CT Group\)](#) on page 854).

---

- The **Error Level (Async)** option (TC390A only) specifies the error level for the TC390A pair(s):

**Group:** When the specified pair is suspended, all TC390A pairs in the same consistency group will be suspended, even if the failure affects only that pair and not the entire group.

Select the **Group** error level for all TC390A volumes that are essential to disaster recovery. Suspended TC390A R-VOLs that have the **Volume** error level should not be used for disaster recovery.

**Volume:** If the failure affects only the specified pair, then only that pair will be suspended. A failure that affects an entire group will always result in the suspension of all pairs in the group, as well as all other affected TC390 pairs.

---

**Note:** You can also use the CESTPAIR TSO command to specify the error level for TC390A pairs (see [Using PPRC Commands for TrueCopy](#) on page 933).

---

The **Pair Resume (Async)** option (TC390A only) is available only when the Pair Option window is opened during the resume TC390A pair operation (see [Resuming TrueCopy Volume Pairs \(Resume Pair\)](#) on page 894). Use the TC390A **Group** resume option to resume all suspended TC390A pairs in a group. Use the TC390A **Volume** resume option to resume only the selected TC390A pair(s).

- The **Cancel** button cancels the settings you have made and closes the Add Pair window. The **Set** button set the parameters and closes the Add Pair window.

When you are creating two or more pairs at the same time, the initial copy options will be the same for all the pairs. You can modify these initial copy options for individual pairs as needed. The procedure to modify the options, see [Modifying Parameters and Omitting Selected Volumes](#) on page 875.

**To create one or more new TC390 volume pairs:**

1. Verify that the volumes that will be the TC390 R-VOLs are offline from all hosts.
2. Connect to the disk array that contains the M-VOLs of the pair(s) you are creating and start the TC390 software. The RCPs or Initiator ports must be configured (see [Configuring the Host Interface Ports](#) on page 824) and the RCU(s) must be registered already (see [Registering an RCU \(Add RCU\)](#) on page 830).
3. From the CU Number tree on the TrueCopy main screen, select the CU number.
4. From the Volume list on the TrueCopy main screen, select the volume(s) that will be the M-VOL(s) of the TC390 volume pair(s). You can select one or more volumes and establish one or more pairs at a time only if the R-VOLs are in the same RCU and the pairs will have the same copy mode (Sync or Async). You cannot start TC390 Sync and TC390A pairs at the same time.
5. Right-click to display the pop-up menu, click **Add Pair**, and click the pair mode (**Synchronous** or **Asynchronous**). The Add Pair window is displayed.

---

**Note:** Pair mode specifies the update copy mode (see [Update Copy Operations](#) on page 744) for the new pair(s): **Synchronous** or **Asynchronous**. The selection of mode has the greatest impact on performance and must be considered carefully. Factors in mode selection include (but are not limited to) the use of TC390 (for disaster recovery or migration), the number of pairs, and the write I/O activity to the M-VOLs.

---

6. From the Add Pair window, enter the R-VOL for the pair, select the RCU, and select the initial copy options for the pair(s) being created (see [Creating TrueCopy Volume Pairs \(Add Pair\)](#) on page 880).
7. Click **Set** to close the Add Pair window and set the parameters.

The list changes to the Pair Settings Parameter list (Add Pair). The Pair Settings Parameter list (Add Pair) is updated by the parameter settings and displays all pairs being created. The initial copy options and pair options you

selected are applied to all pairs, but you can modify the options for each pair individually as needed (see [Modifying Parameters and Omitting Selected Volumes](#) on page 875).

8. From the Pair Settings Parameter list (Add Pair), check the RCU S/N and SSID, R-VOL, and copy options for each pair. You can modify the options as needed (see [Modifying Parameters and Omitting Selected Volumes](#) on page 875). Verify that all TC390 options for each new pair are correct.
9. If you want to execute the Add Pair requests quickly, select the **Use Time-Saving Mode** check box above the Pair Settings Parameter list (Add Pair).
10. Click **Apply** on the TrueCopy main screen to create (start) the specified TC390 pair(s). The MCU will start the initial copy operations according to the initial copy priority and the maximum initial copy activities setting of the RCU.
11. From the TrueCopy main screen, verify that the new TC390 pair(s) is/are displayed correctly (Pending status) in the Volume list. To monitor the status of the new pair(s), click **Refresh** to update the information in the Volume list or use the Pair Status window (see [Viewing the Status of TrueCopy Volume Pairs \(Pair Status\)](#) on page 876) to monitor the detailed status of each pair.

---

**Note:** The Add Pair operation will be rejected if the M-VOL is in the correction access or correction copy state. If this occurs, wait for the volume state to change and then repeat this procedure. If the status is not displaying correctly, verify that the correct CU image is selected. For information on troubleshooting suspended pairs, see [General TrueCopy Troubleshooting](#) on page 925.

---

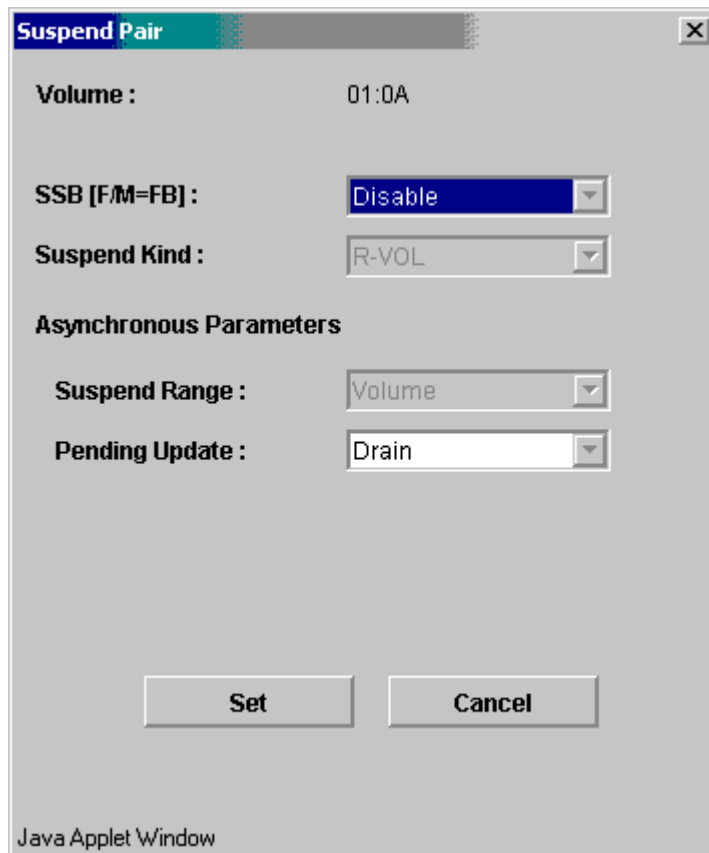


**Caution:** If a timeout error occurs after clicking the **Use Time-Saving Mode** option, confirm on the TrueCopy main screen for which volumes the Add Pair operation could not be performed. Deselect the **Use Time-Saving Mode** option for the failed volumes and retry the Add Pair operation.

---

## Suspending TrueCopy Pairs (Suspend Pair)

The **Suspend Pair** command suspends TC390 pairs. When the **Suspend Pair** command is selected, the Suspend Pair window is displayed. Use the Suspend Pair window to select the Suspend Pair options for the pair(s). You can split a TC390 pair only after the initial copy operation is complete. For more information on split TC390 pairs, see [Suspended Pairs](#) on page 762.



**Figure 351: Suspend Pair window (Asynchronous)**

**Note:** When you set the several pairs at once and you want to keep some of the individual settings, leave the parameter box blank. Then, only the parameters you enter are available.

Use the Suspend Pair window to select the Suspend Pair options for the pair(s):

- **Volume:** Device ID of M-VOL.
- **SSB [F/M = FB]:** When this option is enabled (and PPRC Support = Yes), the MCU will notify all attached hosts (IEA494I message) that the pair was suspended. This option should always be enabled.

---

**Note:** If PPRC support = No, the x'FB' sense information will not be reported to the host, even if the **SSB (F/M = FB)** suspend option is enabled.

---

- **Suspend Kind:** This option specifies the suspend type of the selected pair(s). The default setting is **R-VOL**.
  - **M-VOL Failure.** This setting can be used only for TC390 Synchronous pairs. The MCU will reject all write I/O operations to the M-VOL while the pair is suspended, regardless of the fence level setting. Use this setting if you need to maintain synchronization of the TC390 pair. This setting is functionally equivalent to CSUSPEND with the optional PRIMARY parameter (without QUIESCE).
  - **R-VOL.** The M-VOL will accept all subsequent write I/O operations and the MCU will keep track of updates while the pair is suspended. Use this setting if you need to keep the M-VOL online. This setting is functionally equivalent to CSUSPEND without the optional PRIMARY parameter.
- **Asynchronous Parameters:**
  - **Suspend Range:** Use this option to select the TC390A suspend group operation. The CSUSPEND TSO command supports the TC390A suspend group operation (see [Using PPRC Commands for TrueCopy](#) on page 933)
    - Group.** The MCU/RCU will suspend all other TC390A pairs in the same consistency group as the specified pair(s).
    - Volume.** The MCU/RCU will suspend only the specified TC390A pair(s) (even if the error level of the pair is group).

**Note:** With the setting of Volume for Suspend Range, if there are Duplex status pairs and pairs other than Duplex status in the same consistency group, unexpected suspend may occur during the pair operations (Suspend, Delete, and Resume) under the heavy I/O load conditions. You can estimate whether the I/O load condition is heavy or not from the rate of sidefile cache (around 30%), or from the frequency of the host I/O if you cannot see the rate of sidefile cache. The pair operations should be performed under the light I/O load condition.

---

- **Pending Update:** This option specifies the TC390A suspend mode. The CSUSPEND TSO command supports the TC390A suspend mode option ([Using PPRC Commands for TrueCopy](#) on page 933).

**Drain.** The RCU will finish settling all pending recordsets for the pair as soon as the RCU accepts the suspend operation. After settling all the recordsets, if there is no recordset for a fixed period of time, the MCU will change the TC390A pair status from suspending to suspended.

---

**Note:** If the RCU is not able to complete these actions within the copy pending timeout setting, the RCU will discontinue the original suspend request and forcibly suspend the affected volume pairs. Thus, you can use the copy pending timeout parameter to limit the amount of time it takes to complete the suspend/drain operation.

---

**Purge.** The MCU will change the TC390A pair status from *suspending* to *suspended* as soon as the RCU accepts the suspend operation. The MCU and RCU discard any pending recordsets and mark the cylinders that contain discarded recordsets as modified in the M-VOL and R-VOL bitmap, respectively. When the pair is resumed, the M-VOL and R-VOL bitmaps will be merged at the MCU, and all cylinders marked as modified will be copied to the R-VOL.

---

**Note:** If the MCU does not receive acknowledgement of the suspend operation from the RCU within the copy pending timeout setting, the MCU will forcibly suspend all affected pairs and report an IEA491E host console message.

---



**To suspend one or more TC390 volume pairs:**

1. Connect to the MCU (or RCU) of the volume pair(s) to be suspended. You do not need to vary the M-VOL(s) offline. If you want to use the R-VOL write enable option, you must connect to the MCU and select the M-VOL of the pair.
2. From the CU Number tree on the TrueCopy main screen, select the number of the correct CU image.
3. From the Volume list on the TrueCopy main screen, select the TC390 volume pair(s) that you want to suspend. Select either TC390 Synchronous or TC390A pairs, but not both. The pair status must be **Duplex**.
4. Right-click to display the pop-up menu and click **Suspend Pair**. The Suspend Pair window is displayed.
5. From the Suspend Pair window, select the options for the pair(s), and then click **Set** to close the Suspend Pair window and set the parameters. The list changes to the Pair Settings Parameter list (Suspend Pair). You can modify the options as needed (see [Modifying Parameters and Omitting Selected Volumes](#) on page 875). Verify that the Suspend Pair options for each pair are correct. The suspend kind option (**R-VOL** or **M-VOL failure**) and fence level pair option determine whether the M-VOL will accept write I/O operations after the pair is split.



**Caution:** If you need to split a pair and the M-VOL is required for system operation, do not use the **M-VOL Failure** suspend kind option. Make sure to use the **R-VOL** suspend kind option so that the M-VOL continues accepting I/Os.

6. If you want to execute the Suspend Pair requests quickly, select the **Use Time-Saving Mode** check box above the Pair Settings Parameter list (Suspend Pair).
7. Click **Apply** on the TrueCopy main screen to split the specified pair(s). For the TC390 Synchronous pairs, the MCU will complete all M-VOL write operations in progress and the associated update copy operations at the R-VOL before splitting the pair so that the pair is synchronized at the time of Suspend Pair.

8. From the TrueCopy main screen, verify that the TC390 pair(s) is/are displayed correctly (**Suspended** status) in the Volume list. The **Resume Pair** command (see [Resuming TrueCopy Volume Pairs \(Resume Pair\)](#) on page 894) resumes suspended TC390 volume pair(s).



**Caution:** If a timeout error occurs after clicking the **Use Time-Saving Mode** option, confirm on the TrueCopy main screen for which volumes the Suspend Pair operation could not be performed. Deselect the **Use Time-Saving Mode** option for the failed volume and retry the Suspend Pair operation.

---

## Resuming TrueCopy Volume Pairs (Resume Pair)

While a TC390 pair is suspended, the MCU does not perform any update copy operations. For a suspended TC390 Synchronous pair, the MCU may or may not continue accepting write I/Os for the M-VOL depending on the M-VOL fence level and suspend option (if user-requested). If the MCU accepts write I/Os for a suspended M-VOL, the MCU keeps track of the M-VOL cylinders that are updated while the pair is suspended, and then copies the VOLSER and out-of-sync cylinders to the R-VOL when the pair is resumed. For a suspended TC390A pair, the MCU and RCU keep track of any recordsets that were discarded during suspension, and the MCU continues accepting write I/Os for the M-VOL. When a TC390A pair is resumed, the MCU merges the M-VOL and R-VOL cylinder bitmaps and then copies the VOLSER and out-of-sync cylinders to the R-VOL to resynchronize the pair.

The **Resume Pair** command resumes split/suspended TC390 pairs. When the **Resume Pair** command is selected, the Resume Pair window is displayed. Use the Resume Pair window to change the pair options and select the resume range option (asynchronous) for the selected pair(s).

The screenshot shows a 'Resume Pair' window with the following settings:

- M-VOL :** 01:0A
- M-VOL Fence Level :** Never
- Initial Copy Parameters**
  - Initial Copy Pace :** 15
  - Priority :** 32 (From 0 to 256)
- Asynchronous Parameters**
  - Resume Range :** Volume
  - Error Level :** Group

Buttons: Set, Cancel

Java Applet Window

**Figure 352: Resume Pair window (Asynchronous)**

**Note:** When you set the several pairs at once and you want to keep some of the individual settings, leave the parameter box blank. Then, only the parameters you enter are available.

- **M-VOL:** Device ID of the M-VOL.
- **M-VOL Fence Level:** Select the fence level. **Never:** Never fence the operation. **Data:** Fence when the MCU cannot successfully execute an update copy operation for any reason. **Status:** Fences only if the MCU is not able to change the R-VOL status to the same status as the M-VOL. For synchronous mode only. When the asynchronous pair(s) is being created, **Never** is set automatically.
- **Initial Copy Parameters:**

- **Initial Copy Pace (3 or 15):** Select the number of the tracks 3 or 15 for resume copy. The default setting is 15.
- **Priority (From 0 to 256):** Set the priority (0-256) for the resume operation, which determines the order in which the resume operations will be performed.
- **Asynchronous Parameters:**
  - **Resume Range:** When **Group** is selected, resume all split or suspended TC390A pairs in the same group as the selected pair. When **Volume** is selected, resume only the selected TC390A pair(s).
  - **Error Level:** The **Error Level** option specifies the error level for the TC390A pair(s): Group or Volume. This option is available only when **Volume** is selected for the Resume Range.

---

**Note:** With the setting of Volume for Resume Range, if there are Duplex status pairs and pairs other than Duplex status in the same consistency group, unexpected suspend may occur during the pair operations (Suspend, Delete, and Resume) under the heavy I/O load conditions. You can estimate whether the I/O load condition is heavy or not from the rate of sidefile cache (around 30%), or from the frequency of the host I/O if you cannot see the rate of sidefile cache. The pair operations should be performed under the light I/O load condition.

---

For more information about the option parameters, see [Creating TrueCopy Volume Pairs \(Add Pair\)](#) on page 880.

---

**Note:** The CESTPAIR (MODE=RESYNC) command can be used to resume suspended TC390 Synchronous and TC390A pairs (see [Using PPRC Commands for TrueCopy](#) on page 933).

If an MCU/RCU is powered off and its backup batteries are fully discharged while TC390 pairs are suspended, the M-VOL/R-VOL cylinder bitmaps will not be retained. In this unlikely case, the MCU/RCU will mark all cylinders of all split or suspended TC390 volumes as modified so that the MCU will perform the equivalent of an entire initial copy operation when the pairs are resumed.

---

**To resume one or more split or suspended TC390 volume pairs:**

1. If any pair was suspended due to an error condition (use the Pair Status window to view the suspend type), verify that the error condition has been removed (see [General TrueCopy Troubleshooting](#) on page 925 for troubleshooting instructions). The MCU will not resume the pair(s) until the error condition has been removed.
2. Connect to the MCU of the pair(s) to be resumed and start the TC390 software.
3. From the CU Number tree on the TrueCopy main screen, select the number of the correct CU image.
4. If you are resuming split or suspended Volumes, select the pair(s) on the Volume list on the TrueCopy main screen. Select Suspended pairs. Select either Sync or Async pairs (not both). If you plan to use the **Resume Range** option, select only one TC390A pair in the group.
5. Right-click to display the pop-up menu and click **Resume Pair**. The Resume Pair window is displayed.
6. From the Resume Pair window, select the appropriate pair options, and click **Set** to close the Resume Pair window and set the parameters. The list changes to the Pair Settings Parameter list (Resume Pair). Verify that all resume options and pair options for each pair are correct.

---

**Note:** The options can be modified and/or canceled after you have set them. See [Modifying Parameters and Omitting Selected Volumes](#) on page 875.

If you want to resume all split/suspended TC390A pairs in a consistency group, verify that the **Resume Range** option on the Resume Pair window is set to **Group**.

---

7. If you want to execute the Resume Pair requests quickly, select the **Use Time-Saving Mode** check box above the Pair Settings Parameter list (Resume Pair).
8. Click **Apply** on the TrueCopy main screen to resume the specified pair(s).
9. From the TrueCopy main screen, verify that the TC390 pair(s) is/are displayed correctly (**Pending duplex** or **Duplex** status) in the Volume list.



**Caution:** If a timeout error occurs after clicking the **Use Time-Saving Mode** option, confirm on the TrueCopy main screen for which volumes the Resume Pair operation could not be performed. Deselect the **Use Time-Saving Mode** option for the failed volumes and retry the Resume Pair operation.

---

## Deleting TrueCopy Volume Pairs (Delete Pair)

A TC390 pair should be deleted from the MCU only when it is no longer necessary to maintain a remote copy of the M-VOL. When a TC390 volume pair is deleted from the MCU, the MCU stops all TC390 copy operations for that pair and changes the pair status of the M-VOL and R-VOL to *simplex*. After a pair is deleted, the MCU continues to accept all subsequent write I/O operations to the M-VOL and will not keep track of the M-VOL updates.

A TC390 pair should be deleted from the RCU only if you need to access the R-VOL, such as to perform ICKDSF on the R-VOL (see [ICKDSF Considerations for TrueCopy Volumes](#) on page 905) or for disaster recovery (see [TrueCopy Disaster Recovery Operations](#) on page 913). When a TC390 volume pair is deleted from the RCU, the RCU changes the R-VOL pair status to *simplex*, but does not change the pair status of the corresponding M-VOL. When the MCU performs the next TC390 operation, the MCU detects that the R-VOL status changed and changes the status of the M-VOL to *suspended-delete pair to RCU*. When you delete a pair from the RCU to access the R-VOL, remember that the R-VOL and M-VOL have the same VOLSER and take appropriate precautions to prevent a system problem due to duplicate VOLSERS. To restart a pair that was deleted from the RCU, you must first delete the pair from the MCU, and then add the pair from the MCU using the appropriate initial copy option (**Entire** or **No Copy**) to restart the pair.

You can delete all TC390 Synchronous pairs between an MCU and RCU (same CU image). You can also delete all TC390A pairs in a consistency group by connecting to the MCU. The TC390A pair status will change to *deleting* when the delete operation is accepted by the MCU and RCU, and then to *simplex* after the internal delete pair process is complete. In addition, you can delete TC390A pairs according to their consistency status (for example, for disaster recovery) by connecting to the RCU (the RCU maintains the consistency status).

**Note:** The CDELP AIR TSO command can be used to delete TC390 pairs and TC390A groups of pairs from the MCU (see [Using PPRC Commands for TrueCopy](#) on page 933).

---

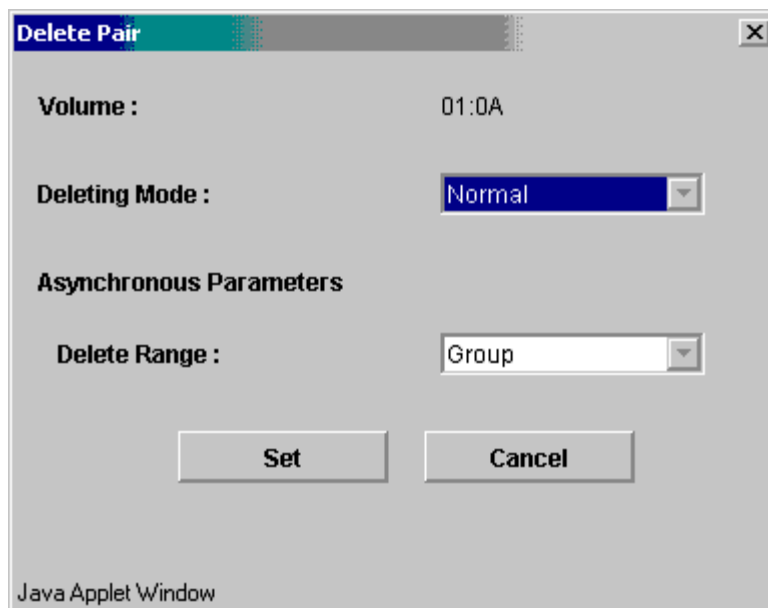


**Caution:** For information about duplicate VOLSERS, see the caution in [Duplicate VOLSER](#) on page 774.

As a general rule, when you want to delete a TC390A pair from the MCU, it is strongly recommended that you perform the Delete Pair operation after the update copy operation is completed. If you demand the Delete Pair operation while the update copy process is still in progress, it will take a long time to complete the Delete Pair operation. However, when you urgently need to delete a TC390A pair, you can perform the Delete Pair operation from the RCU. In this case, you will find the suspended status at the MCU after the Delete Pair operation from the RCU.

---

The **Delete Pair** command deletes one or more TC390 pairs. When the **Delete Pair** command is selected, the Delete Pair window is displayed. Use the Delete Pair window to change the Delete Pair options (by force and TC390A delete range) for the pair(s) selected on the Volume list of the Pair Operations screen.



**Figure 353: Delete Pair window (Asynchronous)**

**Note:** When you set the several pairs at once and you want to keep some of the individual settings, leave the parameter box blank. Then, only the parameters you enter are available.

- **Volume:** Device ID of the MCU.
- **Deleting Mode:** Select the restriction on deleting a TC390 volume pair.
  - **Normal:** Normal deleting operation is performed.
  - **All:** Deletes all TC390 Synchronous pairs with the same MCU and RCU (same CU image) as the selected pair. This option can be selected from the MCU or RCU, and the **Force** option must also be selected. This option deletes the pairs more quickly than if you select all pairs on the TrueCopy main screen and delete them.
  - **Force:** Overrides the restrictions on deleting a TC390 volume pair. If this option is selected, the pair(s) will be deleted even if the MCU is unable to communicate with the RCU. This option may be used to free a host waiting for device-end from an MCU that cannot communicate with its



RCU, thus allowing host operations to continue. If this option is not selected, the pair(s) will only be deleted if the MCU is able to change the pair status of the M-VOL and R-VOL to *simplex*.

When the status of the pair that is deleted is Simplex or Deleting, the default setting is **Force** (cannot be changed). When the status of the pair is not Simplex or Deleting, the default setting is **Normal**.

- **Asynchronous Parameters, Delete Range:** Select the TC390A delete range option. This option simplifies disaster recovery operations for TC390A consistency groups at the RCU (secondary or remote disk array).

The TC390 delete range options are:

- **Group** (MCU or RCU). When **Group** is selected, the MCU/RCU will delete all TC390A pairs in the same consistency group as the specified pair regardless of pair status and consistency status.



**Caution:** Do not use this option when deleting pairs at the RCU during disaster recovery. This option is available only when one pair is selected.

---

- **C/T** (RCU only). When **C/T** is selected, the RCU will delete all TC390A pairs that have the same consistency time.
- **Volume** (MCU or RCU). When **Volume** is selected, the MCU/RCU will delete only the specified TC390A pair(s). This option can be used to remove individual volumes from consistency groups.

---

**Note:** With the setting of Volume for Delete Range, if there are Duplex status pairs and pairs other than Duplex status in the same consistency group, unexpected suspend may occur during the pair operations (Suspend, Delete, and Resume) under the heavy I/O load conditions. You can estimate whether the I/O load condition is heavy or not from the rate of sidefile cache (around 30%), or from the frequency of the host I/O if you cannot see the rate of sidefile cache. The pair operations should be performed under the light I/O load condition.

---

The default settings are as follows:

- More than one pairs are selected: Volume.
- One pair is selected and the pair is M-VOL: Group.
- One pair is selected and the pair is R-VOL: C/T.

**Note:** When an asynchronous pair is forcibly deleted, the TC390 delete range option must be Group. Therefore, more than one pair cannot be forcibly deleted.

---

**To delete one or more TC390 volume pairs:**

1. If you need to delete the volume pair(s) from the RCU to access the R-VOL(s) (for example, to perform ICKDSF), connect to the MCU(s) and suspend the volume pair(s) first (see [Suspending TrueCopy Pairs \(Suspend Pair\)](#) on page 890 for instructions).
2. Connect to the MCU or RCU of the pair(s) to be deleted and start the TC390 software. If you plan to use the TC390A C/T delete range option, you must connect to the RCU.
3. From the CU Number tree on the TrueCopy main screen, select the CU number of the correct CU image.
4. From the Volume list on the TrueCopy main screen, select the TC390 volume pair(s) that you want to delete. Select either TC390 Sync or Async pairs, but not both. If you plan to use the TC390A C/T or **Group** delete range option, select only one TC390A pair in the group.
5. Right-click to display the pop-up menu and click **Delete Pair**. The Delete Pair window is displayed.
6. From the Delete Pair window, select the Delete Pair options for the selected pair(s), and click **Set** to close the Delete Pair window and set the parameters. The list changes to the Pair Settings Parameter list (Delete Pair). Repeat this step as needed to set Delete Pair options for the pair(s).

---

**Note:** The options can be modified and/or canceled after you have set them. See [Modifying Parameters and Omitting Selected Volumes](#) on page 875.

---

7. If you want to execute the Delete Pair requests quickly, select the **Use Time-Saving Mode** check box above the Pair Settings Parameter list (Delete Pair).
8. Click **Apply** on the TrueCopy main screen to delete the specified pair(s).
9. When deleting TC390A pairs, verify that the Delete Pair request was completed successfully by checking the detailed TC390 pair status information on the Pair Status window (should be **Simplex**, not **Deleting** or **Suspended**).

When deleting TC390 Sync pairs, verify that the Delete Pair request was completed successfully by checking the pair status on the **Pair Operations** tab (**Simplex** status).

10. To restart a pair that was deleted from the RCU, first delete the pair from the MCU, and then use the **Add Pair** command with the appropriate TC390 initial copy option (**Entire** or **No Copy**) to restart the pair.

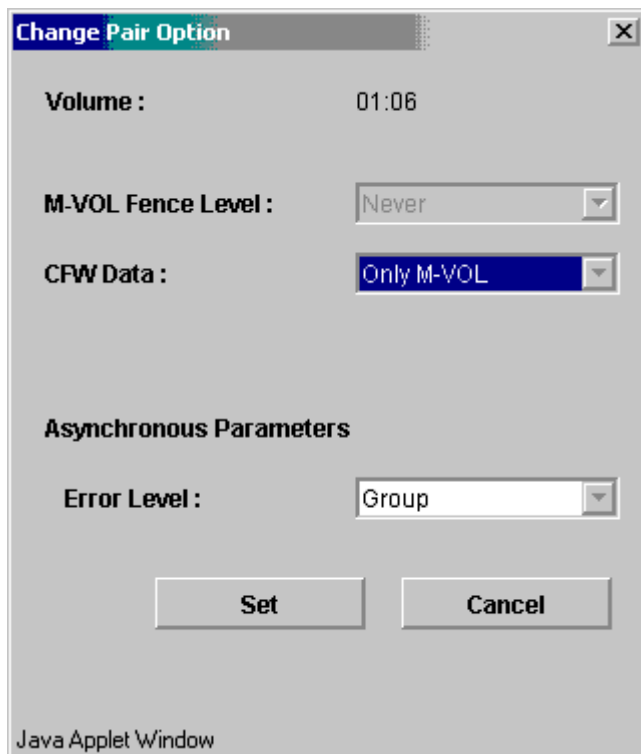


**Caution:** If a timeout error occurs after clicking the **Use Time-Saving Mode** option, confirm on the TrueCopy main screen for which volumes the Delete Pair operation could not be performed. Deselect the **Use Time-Saving Mode** option for the failed volumes and retry the Delete Pair operation.

---

## Changing the Pair Options (Change Pair Option)

The **Change Pair Option** command changes the pair options, **Fence level**, **CFW Data**, and **Error level** (asynchronous pairs only). When the **Change Pair Option** command is selected, the Change Pair Option window is displayed. From the Change Pair Option window, the pair options can be changed.



**Figure 354: Change Pair Option window (Asynchronous)**

---

**Note:** When you set the several pairs at once and you want to keep some of the individual settings, leave the parameter box blank. Then, only the parameters you enter are available.

---

- **M-VOL Fence Level:** Select the fence level. **Never:** Never fence the operation. **Data:** Fence when the MCU cannot successfully execute an update copy operation for any reason. **Status:** Fences only if the MCU is not able to change the R-VOL status to the same status as the M-VOL. This option is only for the synchronous mode. When the asynchronous pair(s) is being created, **Never** is set automatically.
- **CFW Data:** The **CFW Data** option specifies whether the CFW data will be copied to the R-VOL.
- **Asynchronous Parameters:**

**Error Level:** Error level, **Group** or **Volume**. When a failure occurs, the pairs in the same group or in a Volume are suspended.

**To change the pair options for one or more TC390 volume pairs:**

1. Connect to the MCU of the pair(s) to be changed the options and start the TC390 software.
2. From the CU Number tree on the TrueCopy main screen, select the CU number of the correct CU image.
3. From the Volume list on the TrueCopy main screen, select the TC390 volume pair(s) that you want to modify the options. Select either TC390 Sync or Async pairs, but not both.
4. Right-click to display the pop-up menu and click **Change Pair Option**. The Change Pair Option window is displayed.
5. From the Change Pair Option window, select the pair options for the selected pair(s), and click **Set** to close the Change Pair Option window and set the parameters. The list changes to the Pair Settings Parameter list (Change Pair Option). Repeat this step as needed to change the pair options for the pair(s).

---

**Note:** The options can be modified and/or canceled after you have set them. See [Modifying Parameters and Omitting Selected Volumes](#) on page 875.

---

6. If you want to execute the pair option change requests quickly, select the **Use Time-Saving Model** check box above the Pair Settings Parameter list (Change Pair Option).
7. Click **Apply** on the TrueCopy main screen to change the options for the specified pair(s).
8. From the TrueCopy main screen, verify that the pair option change was completed successfully.

## ICKDSF Considerations for TrueCopy Volumes

The XP128/XP1024 supports the use of the ICKDSF utility program. ICKDSF performs functions for the installation, use, and maintenance of DASD as well as service functions, error detection, and media maintenance.

## ICKDSF on a TrueCopy M-VOL

ICKDSF activities involve write I/O operations with device support authorization instead of normal authorization. Because the MCU does not duplicate write I/O operations with device support authorization at the R-VOL of a TC390 volume pair, you must suspend a TC390 pair before running ICKDSF on a TC390 M-VOL.

### To perform ICKDSF on a TC390 M-VOL:

1. Connect to the MCU of the volume pair, and then start the TC390 software.
2. Suspend the volume pair, if not already suspended, using the **R-VOL** suspend option and the TC390A **Volume** and **Purge** suspend options (see [Suspending TrueCopy Pairs \(Suspend Pair\)](#) on page 890). You can also use the CSUSPEND TSO command to suspend the pair.
3. After the M-VOL status changes to *suspended/R-VOL by operator*, run ICKDSF to repair the M-VOL.
4. When volume repairs are complete, resume the TC390 pair. When resuming a suspended TC390A pair, make sure to use the appropriate **Resume** level pair option (see [Resuming TrueCopy Volume Pairs \(Resume Pair\)](#) on page 894). You can also use the CESTPAIR (MODE=RESYNC) command to resume the pair.

## ICKDSF on a TrueCopy R-VOL

If you need to run ICKDSF on a TC390 R-VOL, you must change the status of the R-VOL to *simplex* to allow write access to the R-VOL. The TC390 pair must then be restarted using the appropriate initial copy options.

### To perform ICKDSF on a TC390 R-VOL:

1. For TC390 Synchronous pairs, you can stop write I/Os to the M-VOL while the R-VOL is being repaired. To do this, suspend the pair from the MCU using the **M-VOL Failure** suspend option (see [Suspending TrueCopy Pairs \(Suspend Pair\)](#) on page 890) (or use CSUSPEND to suspend the pair).
2. Connect to the disk array containing the R-VOL, and then start the TC390 software.
3. On the TrueCopy main screen, locate and select the R-VOL to be repaired, and then delete the pair. For a TC390A R-VOL, make sure to use the **Volume** delete option (see [Deleting TrueCopy Volume Pairs \(Delete Pair\)](#) on page 898). You can also use CRECOVER to delete the pair at the RCU.

4. If necessary, change the R-VOL VOLSER to avoid problems due to duplicate VOLSERs.
5. Vary the R-VOL online and run ICKDSF to repair the R-VOL. When the volume repairs are complete, vary the R-VOL offline.
6. Connect to the MCU, locate and select the M-VOL, note the group number, and delete the pair. For a TC390A M-VOL, make sure to use the **Volume** delete option.
7. Restart the pair using the Add Pair window (or CESTPAIR). Use the **Entire** initial copy option to resynchronize the M-VOL and R-VOL.

---

**Note:** If you are absolutely sure that the M-VOL and R-VOL are still identical, you can restart the pair using the **No Copy** option.

---

## Using TrueCopy for Data Migration and Duplication

### Data Migration Using TrueCopy Synchronous

TC390 Synchronous can be used for device or workload migration with minimal impact to host applications. You may need to migrate data from one volume to another for any of the following reasons:

- To load data onto new or scratch volumes, such as for a new or upgraded disk arrays.
- To temporarily move data off a volume to accommodate other activities, such as repairing.
- To relocate volumes to balance workloads and distribute I/O activity evenly within and across disk arrays for the purpose of improving disk array and system performance.

---

**Note:** TC390 operations within one XP128/XP1024 can be performed only if the S1390 option is not active on the disk array.

---

The TC390 initial copy operation copies the entire contents of the M-VOL to the R-VOL. The data migration is complete when the initial copy operation completes and the pair status changes from *pending duplex* to *duplex*. The P/DAS host software function is used with TC390 Synchronous to complete the data migration nondisruptively.

---

**Note:** If you are migrating data between disk arrays using P/DAS, both disk arrays must be the same type (XP128/XP1024 or other XP disk arrays). If you need to migrate data from other vendors' storage disk arrays onto the XP128/XP1024, contact your HP account team.

---

**To use TC390 Synchronous to migrate data from one volume to another:**

1. Vary the R-VOL(s) offline from all attached hosts. The R-VOLs are the target volumes onto which you are migrating the data. The M-VOLs (source volumes) can remain online.
2. Connect to the disk array containing the volume(s) to be migrated, and then start the TC390 software. If not already done, install the remote copy connections and configure the ports (RCPs for serial, initiator ports for fibre) (if migrating between disk arrays), and then add the RCUs.
3. On the TrueCopy main screen, select the correct CU image and the appropriate volume(s), and then start the TC390 Synchronous pair(s) using the Add Pair window (see [Creating TrueCopy Volume Pairs \(Add Pair\)](#) on page 880).
4. Monitor the progress of the initial copy operation(s) and the status of the pair(s) on the Pair Status window (see [Viewing the Status of TrueCopy Volume Pairs \(Pair Status\)](#) on page 876). Refresh the window as needed. When the status has changed from *pending duplex* to *duplex*, the M-VOL and R-VOL are identical and synchronized.
5. Use the IBM P/DAS host software function (see [P/DAS Support](#) on page 769) to redirect all application I/Os to the R-VOL(s) nondisruptively. If the host system does not support P/DAS, use the following procedure to stop using the M-VOL(s) and switch to the R-VOL(s):
  - a. Disable all applications using the M-VOL(s).
  - b. When all update activity to the M-VOL(s) has stopped, connect to the MCU, select the correct CU image, and delete the TC390 volume pair(s) (see [Deleting TrueCopy Volume Pairs \(Delete Pair\)](#) on page 898).



If the M-VOL(s) and R-VOL(s) are attached to the same host, vary the M-VOL(s) offline first, and then vary the R-VOL(s) online. The M-VOL(s) and R-VOL(s) have the same VOLSERS and cannot be online to the same host(s) at the same time.

- c. If an R-VOL contains more cylinders than its M-VOL, update the R-VOL volume table of contents (VTOC) using ICKDSF/REFORMAT.
- d. If you want to keep the volumes synchronized, establish the same TC390 pair(s) in the reverse direction using the **No Copy** initial copy option (see [Creating TrueCopy Volume Pairs \(Add Pair\)](#) on page 880). If the original M-VOL(s) will be temporarily unavailable for update copy operations, you can suspend the new pair(s) so that the new MCU keeps track of changes.
- e. Start the applications with the R-VOL(s). When the original M-VOL(s) are available, you can resume the pair(s) using the Resume Pair window (see [Resuming TrueCopy Volume Pairs \(Resume Pair\)](#) on page 894).

## Point-in-Time (PiT) Data Duplication Using TrueCopy Asynchronous

You can use TC390 to make Point-in-Time (PiT) duplicates of groups of volumes. The TC390A **Group** and **Drain** suspend options can be used together to create a PiT copy, relative to an application, of an entire TC390A consistency group of volumes.

### To produce a PiT duplicate of an existing TC390A consistency group:

1. Disable the applications accessing the TC390A M-VOLs to stop all update activity to all M-VOLs in the group.
2. After all M-VOL updates have completed, suspend the TC390A group using the **Group** and **Drain** suspend options. If you are suspending the group at the main site, issue the suspend/group command to one M-VOL in the MCU. If you are suspending the group at the remote site, issue the suspend/group command to one R-VOL in the RCU.

---

**Note:** The copy pending timeout setting for the group determines the maximum amount of time that the suspend/drain operation can take.

---

3. When the status for all TC390A pairs in the group has changed to *suspended*, the duplicate set of volumes is complete. If needed, you can restart the application at the main site.

## Powering Off/On TrueCopy Components

The user is responsible for controlling power-off activities for disk arrays involved in TC390 operations. If you need to power off the XP128/XP1024, call your HP representative or HP technical support for assistance. This section provides instructions for performing planned outages of TC390 components.

If power is removed from an MCU while TC390 operations are in progress, the TC390 pairs are not affected, but the update sequence consistency of the TC390A groups at the RCU may be affected. For more information, see [Planned Outage of the MCU](#) on page 910. When power is restored to an MCU, the MCU communicates with its RCU(s) to confirm the pair status of the R-VOLs. Verify that TC390 communications are fully restored (all RCU paths have normal status) before beginning I/O operations to the M-VOLs. If the MCU accepts a write I/O operation for an M-VOL before this confirmation is complete, the MCU will suspend the pair and change the status of the M-VOL to *suspended-by RCU* (the MCU will not be able to change the pair status of the R-VOL).

If power is removed from an RCU or remote copy connection while TC390 operations are in progress, the MCU(s) will detect the communication failure, suspend all affected pairs, and generate SIMs and console messages reporting the failures. The MCU will change the status of the M-VOLs to *suspended-by RCU*, but will not be able to change the status of the R-VOLs.

---

**Note:** If an MCU/RCU is powered off and its backup batteries are fully discharged while TC390 pairs are suspended, the M-VOL/R-VOL cylinder maps will not be retained. In this unlikely case, the MCU/RCU will mark all cylinders of all suspended TC390 volumes as modified so that the MCU will perform the equivalent of an entire initial copy operation when the pairs are resumed. (The R-VOL cylinder map is used only for TC390A operations.)

---

## Planned Outage of the MCU

A planned MCU outage does not affect TC390 Synchronous pairs. For TC390A operations, the MCU must communicate with the RCU even when there are no M-VOL update I/Os from the primary system. During the power-off sequence, the MCU will automatically suspend all TC390A pairs in the *duplex* and *duplex pending* state (suspend type = MCU P/S-OFF). During power-on-reset sequence, the MCU will automatically resume these suspended pairs (pairs with other suspend types are not automatically resumed).

If a TC390A group contains M-VOLs in the MCU being powered off and in other MCU(s) that is/are not being powered off, the pairs behind the other MCU(s) will not be suspended and will continue to be updated.

**To maintain a fully consistent group at the RCU during the planned MCU outage:**

1. Disable the applications using all M-VOLs in the consistency group.
2. Suspend the group at the RCU using the **Group** suspend option. You can use the **Purge** or **Drain** suspend option because the M-VOL updates have stopped.
3. Perform the planned outage of the TC390 MCU.
4. When the MCU is fully powered on and ready to resume operations, resume the TC390A pairs at all MCUs that were powered off (use the resume group option).

## **Planned Outage of the RCU or Remote Copy Connection**

You must suspend all affected TC390 pairs prior to a planned outage of an RCU or of a remote copy connection component (for example, ESCON director, channel extender, switch, or extender). If you do not suspend the pairs first, the MCU(s) will detect the communication failure, suspend all affected pairs, and generate SIMs and console messages reporting the failures.

**To perform a planned outage of a TC390 RCU or remote copy connection component:**

1. Identify all TC390 M-VOLs that will be affected by the equipment outage. You need to know the MCU, CU image, and LDEV ID for each of these M-VOLs.
  - For RCU power-off, identify all M-VOLs that are paired with R-VOLs in the RCU to be powered off.
  - For remote copy connection outage, identify all M-VOLs in all MCUs that use the path/component to be powered off.
2. Connect to each MCU that contains affected M-VOLs and suspend all affected TC390 pairs. Make sure to confirm the pair status changes (TC390 Pair Status window or CQUERY TSO command).
3. Perform the planned outage of the RCU or remote copy connection.
4. When the RCU is fully powered on and ready to resume operations, resume all TC390 pairs at each MCU. Make sure to confirm the pair status changes.

## Planned Outage of the MCU and RCU

When you plan an outage of TC390 MCUs and RCUs at the same time, the MCUs must be powered off before the RCUs and powered on after the RCUs.

### To perform a planned outage of a TC390 MCU and RCU:

1. If RCU power-on will be difficult to control (for example, Power-Control-Interface setting), consider increasing or disabling the **RCU ready timeout** group option (see [Group Options](#) on page 756) for each TC390A group with R-VOLs in the RCU(s) to be powered off.
2. Perform the planned outage of the MCU(s) as described in [Planned Outage of the MCU](#) on page 910. Do not power-on the MCU(s) yet.
3. If an RCU to be powered off is connected to an MCU that is not powered off, make sure to suspend those TC390 pairs before powering off the RCU as described in [Planned Outage of the RCU or Remote Copy Connection](#) on page 911.
4. Perform the planned outage of the RCU(s).
5. Power on the RCU(s). Verify that they are fully operational and ready to resume operations before powering on the MCUs.
6. Power on the MCU(s) and verify that they are ready to resume operations. If you suspended any pairs in [step 3](#), you can also resume those pairs now.

# TrueCopy Disaster Recovery Operations

## Preparing for Disaster Recovery

The type of disaster and the status of the TC390 volume pairs will determine the best approach for disaster recovery. For example, if all TC390 volume pairs are in the *duplex* state when a total system failure occurs at a single point in time, the R-VOLs are current and recovery is straightforward. Unfortunately, some disasters are not so “orderly” and involve intermittent or gradual failures occurring over a longer period of time. The user should anticipate and plan for all types of failures and disasters.

The major steps in preparing for disaster recovery are:

1. Identify the volumes and volume groups that contain important files and data for disaster recovery, such as DB2 log files, master catalog, key user catalogs, and system control data sets. In addition to supporting TC390 remote copy operations as well as PPRC commands, the XP128/XP1024 provides battery-backed nonvolatile duplexed cache, full hardware redundancy, dynamic sparing, and an advanced RAID-5 implementation to ensure full data integrity in the event of a sudden power outage or other failure.
2. Install the Command View and TC390 hardware and software, and establish TC390 operations for the volumes and groups identified in [step 1](#). Make sure to select the correct CU images to access the appropriate volumes.
3. Use the appropriate combination of TC390 options for disaster recovery:
  - RCU options: **Incident of RCU**, **PPRC Support**, **Service SIM of Remote Copy**, and **FREEZE Option** (see [Registering an RCU \(Add RCU\)](#) on page 830).
  - TC390A **offloading timer** asynchronous option (see [Asynchronous Copy Option](#) on page 859) and TC390A **copy pending timeout** group option (see [Adding Consistency Groups \(Add CT Group\)](#) on page 854). The **copy pending timeout** group option can be used to limit the time duration during which updates may be lost.
  - TC390A **Error Level** pair option and **M-VOL Fence Level** pair option for TC390 Synchronous pairs (see [Creating TrueCopy Volume Pairs \(Add Pair\)](#) on page 880).
4. Establish file and database recovery procedures. These procedures should already be established for recovering volumes that are inaccessible due to control unit failure.

5. Install and configure error reporting communications (ERC) between the main and remote sites. ERC is essential if you use the M-VOL fence level setting of **R-VOL Status** or **Never** for any TC390 volume pairs.
6. Configure the primary host system to use the IEA494I message as a trigger for automation rather than the IEA491E message. The IEA491E message is reported to only one host, whereas the IEA494I message is reported to all attached MVS hosts each time the M-VOL pair status changes. For more information on the IEA494I and IEA491E system console messages, see [IEA494I and IEA491E Console Messages](#) on page 959.

## Considering the M-VOL Fence Level Setting

The M-VOL fence level setting (see [Creating TrueCopy Volume Pairs \(Add Pair\)](#) on page 880) for each TC390 Synchronous volume pair determines whether the M-VOL will be fenced when TC390 remote copy operations fail. The following table summarizes the effect of the fence level setting on a TC390 Synchronous M-VOL.

---

**Note:** The M-VOL fence level setting does not apply to TC390A pairs. The TC390A M-VOL is never fenced due to suspension of the pair.

---

**Table 98: Fence level setting on a TrueCopy M-VOL**

Type of Failure		Fence Level Setting		
		R-VOL Data (CRIT=Y(ALL))	R-VOL Status (CRIT=Y(PATHS))	Never (CRIT=NO)
The update copy operation failed and the MCU was able to change the status of the R-VOL to <i>suspended</i> .	Write I/O operations to the M-VOL will be:	REJECTED	Accepted	Accepted
The update copy operation failed and the MCU was NOT able to change the status of the R-VOL to <i>suspended</i> .	Write I/O operations to the M-VOL will be:	REJECTED	REJECTED	Accepted

**R-VOL Data (CRIT=Y(ALL)).** When this fence level setting is selected, the M-VOL will be fenced if an update copy operation fails. This M-VOL fence level setting ensures that the R-VOL remains identical to the M-VOL after the TC390

volume pair is synchronized, but makes the M-VOL inaccessible to applications for updates whenever TC390 remote copy operations fail. This setting should be considered for the most critical volumes for disaster recovery. This setting will reduce the amount of time required to analyze the currency of the R-VOL during disaster recovery efforts. This setting is also designed for applications that can continue to operate with another device pair (for example, IMS logger dual write log files).

**R-VOL Status (CRIT=Y(PATHS)).** When this fence level is selected, the M-VOL is fenced only if the MCU is not able to change the R-VOL pair status to suspended. If the MCU successfully changes the R-VOL pair status to suspended, subsequent write I/O operations to the M-VOL will be accepted and the MCU will keep track of updates to the M-VOL. This allows the volume pair to be resumed quickly using the resync (out-of-sync-cylinders) copy operation (MODE=RESYNC). This setting will also reduce the amount of time required to analyze the R-VOL currency during disaster recovery.

**Never (CRIT=NO).** When this fence level is selected, the M-VOL is never fenced when the pair is suspended. This M-VOL fence level setting ensures that the M-VOL remains available to applications for updates, even if all TC390 copy operations have failed. The R-VOL may no longer be in sync with the M-VOL, but the MCU will keep track of updates to the M-VOL while the pair is suspended. ERC is essential if this fence level setting is used. For disaster recovery, the currency of the R-VOL is determined by using the sense information transferred through ERC or by comparing the R-VOL contents with other files confirmed to be current.

---

**Note:** To exchange CRIT=Y(ALL) and CRIT=Y(PATHS), XP128/XP1024 mode 36 can be used. For more information on the XP128/XP1024 modes, see [Table 81](#) on page 733.

---

## Transferring Sense Information Between Sites

When the MCU (or RCU for TC390A) suspends a TC390 pair due to an error condition, the MCU/RCU sends sense information with unit check status to the appropriate host(s). This sense information is used during disaster recovery to determine the currency of the R-VOL. If the host system does not support IBM PPRC, you must transfer the sense information to the remote site through the error

reporting communications (ERC). If the host system supports IBM PPRC and receives PPRC-compatible sense information related to a TC390 pair, the host operating system will:

1. Temporarily suspend all application I/O operations to the M-VOL.
2. Enter an IEA491E message in the system log (SYSLOG) that indicates the time that the M-VOL was suspended. Verify that the system log is common to both the main and remote operating systems.
3. Place specific information about the failure (SIM) in the SYS1.LOGREC dataset for use by service personnel. For more information on the TC390 SIMs, see [SIM Reporting](#) on page 973.
4. Wait for the IEA491E message to reach the remote system.
5. Resume all host application I/O operations to the M-VOL. If the M-VOL fence level setting does not allow subsequent updates, the MCU will return a unit check for all subsequent write I/O operations and the application will terminate.

---

**Note:** Verify that the MCUs and RCUs are configured to report the service-level SIMs to the host. Select the **Service SIM of Remote Copy = Report** setting on the RCU Option window.

---

## File and Database Recovery Procedures

When a TC390 Synchronous pair is suspended or when the MCU fails due to a disaster, the R-VOL may contain in-process data. A data set could be open or transactions may not have completed. Even if you use the **R-VOL Data** fence level for all TC390 Synchronous pairs, you need to establish file recovery procedures. These procedures should be the same as those used for recovering any volume that is inaccessible due to control unit failure. These procedures are more important if the **R-VOL Status** or **Never** fence level settings are used.

TC390A does not provide any procedure for detecting and retrieving lost updates. To detect and recreate lost updates, you must check other current information, such as a database journal log file that was active at the primary system when the disaster occurred. Note that the journal log file entries of most DBMS have the same system TOD clock information that is used for the I/O time-stamps (when timer type = system). The TC390A group consistency time can be extremely useful when performing this detection and retrieval. Because this



detection/retrieval process can take a while, your disaster recovery scenario should be designed so that detection and retrieval of lost updates is performed after the application has been started at the secondary system.

You should prepare for file and database recovery by using:

- Files for file recovery (for example, DB2 log files that have been verified as current). To ensure the currency of these files, use the **R-VOL Data** fence level setting for the TC390 pairs that contain these important files.
- The sense information with system time stamp that will be transferred through ERC.

Remote copy and disaster recovery procedures are inherently complex. Consult your HP account team on sense-level settings and recovery procedures.

For information on recovering a pinned track on a TC390 volume, see [Pinned Track Recovery for TrueCopy Volumes](#) on page 972.

## CSUSPEND/QUIESCE TSO Command



**Caution:** The QUIESCE option of the CSUSPEND command has been disabled by APAR OW15247 or APAR OW15248. For detailed information on the QUIESCE option of the CSUSPEND command, refer to either of these APARs. Check with your HP account team before using the CSUSPEND command with the QUIESCE option to suspend TC390 volume pairs on an XP128/XP1024 (or other XP disk array). If the CSUSPEND command with the QUIESCE option is issued to certain volumes (for example, active SPOOL, PAGE, or CATALOG datasets, or active SYSRES volume), the attached host(s) may enter a deadlock condition and may require a storage control IML to correct the condition. TC390A does not support the CSUSPEND/QUIESCE option.

---

## IEA494I System Console Message

The IEA494I message is recommended as a trigger for automation over the IEA491E message because the IEA494I message is reported to all attached MVS hosts each time the M-VOL pair status changes, whereas the IEA491E message is reported to only one host system. For more information on the IEA494I and IEA491E messages, see [IEA494I and IEA491E Console Messages](#) on page 959.

## Switching Operations to the Remote Site

If a disaster or failure occurs at the main site, the first disaster recovery activity is to switch your operations to the remote backup site. The TC390 Synchronous R-VOLs are recovered individually based on the pair status and M-VOL fence level information for each pair. The TC390A R-VOLs are recovered based on pair status, consistency status, and consistency time.

The basic procedures for switching operations to the remote backup site are:

1. Analyze the currency of the TC390 Synchronous R-VOLs (see [Analyzing the Currency of TrueCopy Synchronous R-VOLs](#) on page 919) and the consistency of the TC390A R-VOLs (see [Analyzing the Consistency of TrueCopy Asynchronous R-VOLs](#) on page 920).
2. Record the consistency time (C/T) of each group. The suspended TC390A R-VOLs with consistency status of *group* will indicate the same C/T.
3. Perform file recovery as needed (see [File and Database Recovery Procedures](#) on page 916). The C/T of each TC390A group can be used to retrieve lost updates.
4. At the remote site, suspend all pairs by issuing the CSUSPEND TSO command to the R-VOLs. This command changes the R-VOLs to the *simplex* state. Use the TC390A group and drain suspend options to destage pending updates in cache to the R-VOLs.

---

**Note:** If PPRC is not installed, connect to each RCU and delete all TC390 pairs. For TC390A pairs, use the C/T delete option to delete all consistent pairs in the group at the same time. This option prevents you from accidentally using inconsistent pairs for disaster recovery. Delete all TC390 sync pairs using the **Delete by Force** and **Delete All Pairs** options.

---



**Caution:** After an R-VOL changes to the simplex state, you cannot distinguish it from a non-TC390 simplex volume. The TC390A C/T is also discarded when the pair is deleted.

---

5. If necessary, use ICKDSF REFORMAT to change the labels (VOLSERs) of the R-VOLs.

6. Verify that all required file recovery procedures have been completed before varying the R-VOLs online. If an IPL of the remote host system is not required, bring the R-VOLs online. If an IPL is required:
  - a. Clear the remote copy SIMs from the RCUs before OS IPL. Connect to each RCU and click **Clear SIM** in the Other Operations window (see [Other Operations](#) on page 867). Please note that only an HP CE or ASE should remove SIMs.
  - b. Perform IPL of the remote host system.
  - c. Wait until the IPL is complete, and then vary the R-VOLs online (if they did not come online automatically).
7. At this point you may start critical applications at the remote site with the previous R-VOLs taking the place of their M-VOLs.

## Analyzing the Currency of TrueCopy Synchronous R-VOLs

The following table shows how to determine the currency of a TC390 Synchronous R-VOL based on its pair status and M-VOL fence level setting. For TC390 Synchronous pairs with an M-VOL fence level setting of **Never**, further analysis will be required to determine the currency of these R-VOLs. The currency of these R-VOLs can be determined by using the sense information transferred through ERC or by comparing the contents of the R-VOL with other files that are confirmed to be current (for example, DB2 log files). These R-VOLs should be recovered using the files that are confirmed to be current.

**Table 99: Analyzing the currency of TrueCopy Synchronous R-VOLs**

Status of R-VOL	Fence Level	Currency of R-VOL
Simplex	Data Status Never	<b>Inconsistent.</b> This R-VOL does not belong to a TC390 volume pair. Even if you established a TC390 pair for this volume, you must regard this volume as inconsistent.
Pending Duplex	Data Status Never	<b>Inconsistent.</b> This R-VOL is not synchronized because not all cylinders have been copied from the M-VOL yet. This R-VOL must be initialized (or copied from the M-VOL at a later time).
Duplex	Data Status	<b>Current.</b> This R-VOL is synchronized with its M-VOL.
	Never	<b>Needs to be analyzed.</b> This R-VOL requires further analysis to determine its level of currency.

**Table 99: Analyzing the currency of TrueCopy Synchronous R-VOLs (Continued)**

Status of R-VOL	Fence Level	Currency of R-VOL
Suspended - initial copy failed	Data Status Never	<b>Inconsistent.</b> This R-VOL is not synchronized because not all cylinders have been copied from the M-VOL yet. This R-VOL must be initialized (or copied from the M-VOL at a later time).
Suspended - R-VOL by operator	Data Status Never	<b>Suspect.</b> This R-VOL is not synchronized with its M-VOL if any write I/Os were issued to the M-VOL after the pair was suspended. This pair should be restarted using the <b>Entire</b> initial copy option, but the <b>No Copy</b> option can be used if you are sure no data on the M-VOL changed.
Suspended - all other types	Data	<b>Current.</b> This R-VOL is synchronized with its M-VOL.
	Status Never	<b>Suspect.</b> This R-VOL is not synchronized with its M-VOL if any write I/Os were issued to the M-VOL after the pair was suspended. Restore the consistency of this R-VOL and update it, if required. The system time stamp information transferred through ERC or the time of suspension indicated on the Pair Status window will help to determine the last time this R-VOL was updated.

### Analyzing the Consistency of TrueCopy Asynchronous R-VOLs

The following table shows how to determine the consistency of a TC390A R-VOL based on its pair status and consistency status. For TC390A R-VOLs with a consistency status of **Volume**, the volume is not consistent with other volumes in the same group and further analysis will be required to determine the currency of each of these R-VOLs. To determine the currency of these R-VOLs, use the sense information transferred through ERC or compare the contents of the R-VOL with other files that are confirmed to be current, such as DB2 log files. These R-VOLs should be recovered using the files that are confirmed to be current.

**Table 100: Analyzing the consistency of TrueCopy Asynchronous R-VOLs**

Status of R-VOL	Usable for Recovery?	Description
Duplex Pending Duplex Simplex	No No No	These states do not usually occur during TC390A disaster recovery because the RCU suspends all TC390A pairs when communication with the MCU is lost. TC390A R-VOLs in these states should not be used for disaster recovery.  Simplex volumes cannot be distinguished from R-VOLs that have already been deleted by the Delete Pair operation.
Suspended-Group	Yes	The update sequence consistency across these R-VOLs is ensured at the point in time indicated by the group consistency time. These R-VOLs can be used for disaster recovery at the secondary system.  Updates that were performed at the primary system after the indicated consistency time were probably lost.
Suspended-Volume	No	The contents of this R-VOL may be behind the other R-VOLs in the consistency group. If this volume must be consistent with the other volumes in the same group, this R-VOL should not be used for disaster recovery.  The cause for this status is: <ul style="list-style-type: none"> <li>■ The TC390A <b>Error Level</b> pair option for this pair is <b>Volume</b> (not <b>Group</b>).</li> <li>■ Also, this pair was suspended before the disaster/failure, at the beginning of the rolling disaster, or during the initial copy operation.</li> </ul>

## Transferring Operations Back to the Main Site

After the applications are running at the remote site, the next activity is to restore the main site and transfer operations back to the main site.

---

**Note:** For Fibre Channel interface, do not use the CESTPATH and CDELPATH commands at the same time as the SCSI path definition function of LUN Management. The Fibre Channel interface ports need to be configured as initiator ports or RCU target ports before the CESTPATH and CDELPATH commands are issued.

---

### To transfer operations to the main site:

1. Bring up the host system at the main (primary) site and ensure that all TC390 components are fully operational.

2. At the main site, delete all TC390 pairs at the MCUs. The **Delete Pair by Force** option must be used because the previous R-VOLs are now in the *simplex* state at the remote site. Use the **Delete All Pairs** option to delete all TC390 sync pairs in each CU image. Use the **Delete-Group** option to delete all TC390A pairs in each group. Make sure to connect with all MCUs and all CU images to delete all TC390 pairs.
3. At the main site, delete all TC390A consistency groups at the MCUs.
4. At the main site, delete the RCUs. Remember to connect with each MCU and each CU image to verify that all RCUs have been deleted.
5. At the main site, configure the MCU ports as needed. If you plan to use the same remote copy connections to copy back, change the existing RCPs to LCPs and change the existing initiator ports to RCU target ports. If SVP mode 114 is enabled on all MCUs and RCUs, the ports will reconfigure automatically if you use the CESTPATH command to add the pairs at the secondary site.
6. If you plan to use the same channel extenders, change the operating mode to the opposite direction. The boxes/nodes connected to the MCUs must be set to channel-mode and the boxes/nodes connected to the RCUs must be set to device-mode.
7. At the remote site, configure the RCU ports to enable TC390 operations in the reverse direction (change LCPs to RCPs for serial, change RCU target ports to initiator ports for fibre). This enables the original RCUs to send TC390 remote copy operations to the original MCUs to bring the original M-VOLs up to date. If SVP mode 114 is enabled on all MCUs and RCUs, the ports will reconfigure automatically if you use the TSO CESTPATH command to add the pairs at the remote site.



**Caution:** Before issuing the CESTPATH command, verify that the relevant paths are offline from the host(s) (for example, configure the Chipid offline, deactivate the LPAR, or block the port in the E3CD). If any active logical paths still exist, the add path operation will fail because the port mode (LCP/RCP) cannot be changed.

---

8. At the remote site, establish the same TC390A groups and TC390 pairs in the reverse direction to synchronize the original M-VOLs with the R-VOLs. Make sure to use the **Entire** TC390 initial copy option. The following table shows the correct timer types for performing TC390A operations in the reverse direction.

**Table 101: Selecting the correct timer type for TrueCopy Async disaster recovery**

Original Configuration		Timer Type for Copy Back	
		I/O Time-Stamp Function at Secondary System?	
MCU-RCU Configuration	Timer Type	Yes	No
n-to-1 (n>1)	System	None	None
1-to-1	System	System	None
	Local	Local	Local

## Resuming Normal Operations at the Main Site

After the TC390 pairs have been established in the reverse direction, you are ready to resume normal operations at the main site. Remember that the TC390 terminology is now reversed: the original RCUs and R-VOLs (remote site) are now the MCUs and M-VOLs, and the original MCUs and M-VOLs (main site) are now the RCUs and R-VOLs.

### To resume normal operations at the main site:

1. At the remote site, verify that all TC390 pairs are in the *duplex* state. This indicates that the TC390 initial copy operations are complete.
2. Halt the applications at the remote site and vary the M-VOLs (original R-VOLs) offline at the remote site. This maintains synchronization of the TC390 Synchronous pairs.
3. At the remote site, suspend all TC390 pairs at the MCUs (original RCUs) to destage any pending data from cache. Confirm that the pairs are suspended before proceeding. If an error occurs, resolve it before proceeding.
4. At the remote site, delete all TC390 pairs at the MCUs (original RCUs) using the **Delete All Pairs** option for TC390 sync pairs and the **Delete-Group** option for TC390A pairs. For TC390A pairs, the MCU and RCU complete all pending updates before changing the pair status to *simplex*.
5. At the remote site, change the TC390 settings at the MCUs (original RCUs) to prepare for normal TC390 operations. Delete the TC390A groups and the RCUs (original MCUs). If you plan to use the same remote copy connections, reconfigure the ports (change RCPs back to LCPs for serial, change initiator ports back to ordinary target ports for fibre). If SVP mode 114 is enabled on all MCUs and RCUs, the ports will reconfigure automatically if you use the TSO CESTPATH command to add the pairs at the main site.

---

**Note:** For Fibre Channel interface, do not use the CESTPATH and CDELPATH commands at the same time as the SCSI path definition function of LUN Management. The Fibre Channel interface ports need to be configured as initiator ports or RCU target ports before the CESTPATH and CDELPATH commands are issued.

---

6. If you plan to use the same channel extenders, change the operating mode back to the original direction. The boxes/nodes connected to the MCUs must be set to channel-mode and the boxes/nodes connected to the RCUs must be set to device-mode.
7. At the main site, configure the RCPs or initiator ports, add the RCUs, and add the TC390A groups. If SVP mode 114 is enabled on all MCUs and RCUs, the ports will reconfigure automatically if you use the TSO CESTPATH command to add the pairs at the main site.



**Caution:** Before issuing the CESTPATH command, verify that the relevant paths are offline from the host(s) (for example, configure the Chipid offline, deactivate the LPAR, or block the port in the EŠCD). If any active logical paths still exist, the add path operation will fail because the port mode (LCP/RCP) cannot be changed.

---

8. At the main site, establish all TC390A groups and TC390 pairs in the original direction. You may use the **No Copy** initial copy option because all M-VOLs and R-VOLs are synchronized. If there is any possibility that the volumes are not 100% synchronized, use the **Entire** initial copy option to be safe.
9. Vary the MCU and M-VOLs online and start the applications at the main site.



# Troubleshooting

## General TrueCopy Troubleshooting

In the unlikely event of a problem with the Command View management station or software, first verify that the problem is not being caused by the PC or Ethernet hardware or software, and then try restarting the PC. Restarting the Command View management station does not affect TC390 operations already in progress. For a description of the TC390 error messages displayed on the Command View management station, see [TrueCopy Software Error Codes](#) on page 932.

---

**Note:** Use the **FDCOPY** function to copy the Command View configuration information onto diskette and give the diskette(s) to HP service personnel.

---

The following table provides general troubleshooting information for TC390. [Table 103](#) on page 926 provides troubleshooting information for RCU paths. [Table 104](#) on page 929 and [Table 105](#) on page 931 provide troubleshooting information for suspended TC390 pairs. For troubleshooting information on TC390 scripting, see [TrueCopy Scripting](#) on page 979.

**Table 102: General TrueCopy troubleshooting**

Error	Corrective Action
TC390 operations do not function properly.	Verify that all TC390 requirements and restrictions are met (for example, track format, LVI, VOLSER, or DFW). See <a href="#">System Requirements</a> on page 771 and <a href="#">Requirements and Restrictions</a> on page 773. Verify the MCU and RCU are powered on and fully operational (NVS, cache, DFW). Check all input values and parameters to verify you entered the correct information on the Command View management station (for example, RCU S/N and SSID, path parameters, and M-VOL and R-VOL IDs).
The volume pairs and/or RCUs are not displaying correctly.	Verify that the correct CU image is selected.
An R-SIM warning is displayed on the Command View management station.	Locate the SIM using the RMCMAIN R-SIM window. For SIMs related to TC390 operations, see <a href="#">SIM Reporting</a> on page 973.

**Table 102: General TrueCopy troubleshooting (Continued)**

Error	Corrective Action
A TC390 error message is displayed on the Command View management station.	Resolve the specified error condition, and then try the TC390 operation again.
There is a problem with the Command View management station or TC390.	Verify that the problem is not the PC or LAN hardware or software. Try restarting the PC and reconnecting to the disk array.
The RCU path status is not normal.	Check the path status (RCU Status window) and see <a href="#">Table 103</a> on page 926.
The pair status is <i>suspended</i> .	Check the detailed pair status (Pair Status window) and see <a href="#">Table 103</a> on page 926 and <a href="#">Table 104</a> on page 929 for suspend types and corrective action for suspended TC390 pairs.

**Table 103: Troubleshooting RCU path status problems**

Path Status	Description	Corrective Action
Initialization Failed	The link initialization procedure to the RCU failed.	<p>Verify that you entered the correct RCU S/N and SSID and path parameters (Fibre: MCU port, RCU port, CU number and Controller ID. Serial: port, link address and logical address).</p> <p>For serial, verify that the correct MCU port is configured as an RCP and that the correct RCU port is configured as an LCP.</p> <p>For Fibre Channel interface, verify that the Fibre Channel topology settings of the MCU and RCU ports are correct.</p>
Communication Time Out	Communication between the MCU and RCU timed out.	<p>Verify that the RCU is powered on and fully functional (NVS and cache ON).</p> <p>Verify that the remote copy connection hardware is properly configured and functional, including cables, connectors, ESCDs, repeaters, extender devices, communication lines, and all other devices connected to the extenders.</p> <p>Delete the failed path. You may need to change the minimum paths setting or delete the RCU to delete the path. Then add the path/RCU using Add Path or Add RCU.</p>

**Table 103: Troubleshooting RCU path status problems (Continued)**

Path Status	Description	Corrective Action
Resource Shortage (MCU/RCU)	The MCU/RCU rejected the establish logical path link control function because all logical path resources in the MCU/RCU are being used for other connections.	<p>Delete the failed path, and also delete all paths and RCUs not currently in use. The MCU can be connected to up to four RCUs with up to eight paths (four for serial 3990) to each RCU.</p> <p>Verify all MCU and RCU ports are properly configured:</p> <ul style="list-style-type: none"> <li>■ Serial – LCPs for hosts and MCUs, RCPs for RCUs.</li> <li>■ Fibre – ordinary target ports or RCU target ports for hosts, RCU target ports for MCUs, initiator ports for RCUs.</li> </ul> <p>If necessary, connect to the RCU to delete paths/RCUs and reconfigure ports, then reconnect to the MCU.</p> <p>Add the path/RCU again using Add Path or Add RCU.</p>
Serial Number Mismatch	The RCU's S/N does not match the specified S/N.	<p>Verify that you entered the correct RCU S/N and SSID and path parameters (Fibre: MCU port, RCU port, CU number and Controller ID. Serial: port, link address and logical address).</p> <p>Delete the failed path. You may need to change the minimum paths setting or delete the RCU to delete the path. Then add the path/RCU using Add Path or Add RCU.</p> <p>For Fibre Channel interface, verify that you entered the correct Controller ID and that the Fibre Channel topology settings of the MCU and RCU ports are correct.</p>

**Table 103: Troubleshooting RCU path status problems (Continued)**

Path Status	Description	Corrective Action
Invalid Port	The specified port is not configured as an RCP or initiator port, or this path already exists.	<p>For serial, verify that the correct MCU port is configured as an RCP and that the correct RCU port is configured as an LCP.</p> <p>For Fibre Channel interface, verify that the Fibre Channel topology settings of the MCU and RCU ports are correct.</p> <p>Verify that you entered the correct RCU S/N and SSID and path parameters (Fibre: MCU port, RCU port, CU number and Controller ID. Serial: port, link address and logical address).</p> <p>Delete the failed path. You may need to change the minimum paths setting or delete the RCU to delete the path. Then add the path/RCU using Add Path or Add RCU.</p>
RCU Port Number Mismatch	The specified port in the RCU is physically disconnected from the MCU.	<p>Verify that you entered the correct RCU port number. Correct the port number if necessary.</p> <p>Verify that the MCU and RCU are physically connected.</p> <p>For Fibre Channel interface, verify that the Fibre Channel topology settings of the MCU and RCU ports are correct.</p>
RCU Port Type Mismatch	The specified port in the RCU is not configured as an RCU Target port.	Verify that the port in the RCU configured as an RCU Target port. Configure the port as an RCU Target port if necessary.
Communication failed.	The MCU connects to the RCU successfully, but logical communication time out occurred.	Verify that the RCU port and remote copy connection hardware (cables and switches) are properly configured and functioning.
Port Number Mismatch	The specified port number is not correct, or the cable is not connected to the specified port.	<p>Delete the error path.</p> <p>Verify that you entered the correct port number.</p> <p>Verify that the cable is connected.</p>
Fibre Remote Copy is not Supported	The RCU microcode does not support fibre remote copy.	Install the microcode that supports fibre remote copy at the RCU.

**Table 103: Troubleshooting RCU path status problems (Continued)**

Path Status	Description	Corrective Action
Communication Error	Communication between the MCU and RCU through the fibre path timed out.	Delete the failed path.
<blank>	This path was not established.	Delete the failed path. You may need to change the minimum paths setting or delete the RCU to delete the path. Then add the path/RCU using Add Path or Add RCU.

**Table 104: Troubleshooting suspended TrueCopy pairs**

Suspend Type	Applies to	Description	Corrective Action
M-VOL by Operator	M-VOL	The user suspended the pair from the MCU using the <b>M-VOL Failure</b> option. The R-VOL suspend type is <i>by MCU</i> .	Resume the pair from the MCU.
R-VOL by Operator	M-VOL, R-VOL	The user suspended the pair from the MCU or RCU using the <b>R-VOL</b> option.	Resume the pair from the MCU.
by MCU	R-VOL	The RCU received a request from the MCU to suspend the pair. The M-VOL suspend type is <i>M-VOL by Operator</i> or <i>R-VOL by Operator</i> .	Resume the pair from the MCU.
by RCU	M-VOL	The MCU detected an error condition at the RCU that caused the MCU to suspend the volume pair. The R-VOL suspend type is <i>by MCU</i> .	Clear the error condition at the RCU or R-VOL. If you need to access the R-VOL, delete the pair from the RCU.  If any data on the R-VOL has changed, delete the pair from the MCU and then restart the pair (Add Pair). If not, resume the pair from the MCU.
Delete Pair to RCU	M-VOL	The MCU detected that the R-VOL status changed to <i>simplex</i> because the user deleted the pair from the RCU. The pair cannot be resumed because the R-VOL does not have the <i>suspended</i> status.	Delete the pair from the MCU and then restart the pair. You should use the <b>Entire</b> initial copy option to resynchronize the pair. You can use the <b>No Copy</b> initial copy option only if no data on the M-VOL or R-VOL changed.

**Table 104: Troubleshooting suspended TrueCopy pairs (Continued)**

Suspend Type	Applies to	Description	Corrective Action
R-VOL Failure	M-VOL	The MCU detected an error during communication with the RCU or an I/O error during update copy. In this case, the suspend type for the R-VOL is usually <i>by MCU</i> .	Check the path status on the RCU Status window (see <a href="#">Table 103</a> on page 926). Clear any error conditions at the RCU/R-VOL. If you need to access the R-VOL, delete the pair from the RCU. If any data on the R-VOL has changed, delete the pair from the MCU and then restart the pair (Add Pair). If not, resume the pair from the MCU.
MCU IMPL	M-VOL, R-VOL	The MCU could not find valid control information in its nonvolatile memory during the IMPL procedure. This error occurs only if the MCU is without power for more than 48 hours (power failure and fully discharged batteries).	Resume the pair from the MCU. The MCU will perform an entire initial copy operation in response to the resume pair request.
Initial Copy Failed	M-VOL, R-VOL	The MCU suspended this pair during the initial copy operation. The data on the R-VOL is not identical to the data on the M-VOL. Invalid track format can cause this suspension.	Delete the pair from the MCU. Clear all error conditions at the MCU, M-VOL, RCU, and R-VOL. Reformat failed track using ICKDSF. Restart the initial copy operation using the Add Pair window.
by FREEZE	M-VOL, R-VOL	All TC390 Synchronous pairs in the MCU were suspended by the CGROUP/RUN command.	Resume the pair(s) from the MCU using Resume Pair or the CESTPAIR (MODE=RESYNC) TSO command.
MCU P/S-OFF	R-VOL (TC390A)	The MCU suspended all TC390A pairs due to MCU power-off.	None. The MCU will automatically resume these TC390A pairs during power-on.
by Sidefile Overflow	M-VOL, R-VOL	The amount of sidefile exceeds the specified current pending update data rate and the RCU data is not transferred within the specified offloading timer.	Add cache memory, increase the number of paths between MCU and RCU, or decrease the number of Async pairs or host I/Os.

The following table provides troubleshooting instructions for the TC390A suspension conditions caused by the offloading timer asynchronous option, the group timeout options (copy pending and RCU ready), and recordset errors. Hardware failures that affect the cache storage/shared memory of the MCU or RCU may also cause the TC390A volume pairs to be suspended.

**Table 105: Resolving TrueCopy Asynchronous suspension conditions**

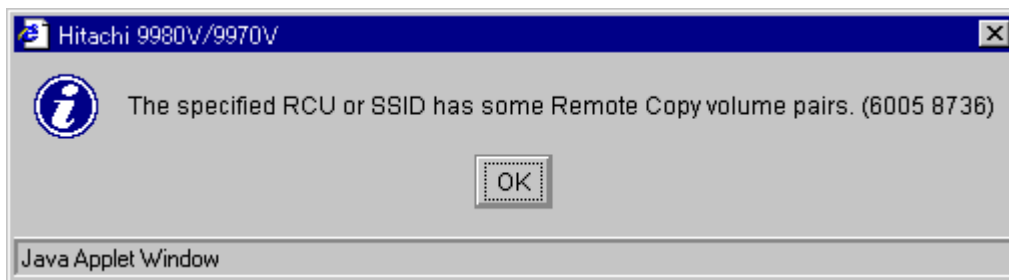
Classification	Causes of Suspension	SIM	Recovery procedure
MCU/RCU hardware	<p>Hardware redundancy has been lost due to some blockade condition. As a result, MCU-RCU communication, creating or receiving recordset, or the staging or de-staging process could not complete.</p> <p>The pending recordset cannot be retained because one side of cache storage or shared memory has been blocked due to hardware failure.</p> <p>MCU-Creating/sending recordset failed due to unrecoverable hardware failure.</p> <p>RCU-Reading/Settling recordset failed due to unrecoverable hardware failure.</p> <p>The drive parity group has been in the correction-access status while the TC390 volume pair was in pending state.</p>	DB0x DB1x DB2x	<p>According to SIM, remove the hardware blockade or failure.</p> <p>Re-establish failed volume pairs (Resume Pair).</p>
MCU-RCU communication	<p>During the power-on-reset sequence, the MCU could not communicate with the RCU within the specified RCU ready timeout.</p> <p>The RCU could not settle the pending recordset or could not communicate with the MCU before the copy pending timeout due to MCU not-ready or inoperative facilities on the remote copy connections.</p>	DB0x DB1x	<p>Remove the failed condition at the RCU/MCU or on the remote copy connection.</p> <p>Re-establish failed pairs (Resume Pair).</p>
RIO overload	<p>The unrecoverable RIO (remote I/O) timeout occurred due to overload of the RCU or the communication facilities on the remote copy connections.</p> <p>No recordset could be sent within the specified copy pending timeout.</p> <p>The RCU could not settle the pending recordset before the copy pending timeout due to overload of the RIO or the RCU itself.</p>	DB1x	<p>Delete failed pairs (Delete Pair).</p> <p>Reconsider the performance resources necessary and increase resources as needed (cache amount, number of MCU-RCU paths, and so forth).</p> <p>Re-establish failed pairs (Add Pair).</p>

**Table 105: Resolving TrueCopy Asynchronous suspension conditions (Continued)**

Classification	Causes of Suspension	SIM	Recovery procedure
RIO failure	The RIO (remote I/O) could not complete due to the failure at the RCU.	DB2x	According to SIM generated at the RCU, remove the failure. Re-establish failed pairs (Resume Pair).
MCU planned outage	The TC390A pairs were temporarily suspended due to a planned outage of the MCU.	DB8x	No recovery procedure is required. The MCU will automatically remove the suspension condition during the next power-on-reset sequence.

## TrueCopy Software Error Codes

The TC390 software displays error messages on the Command View management station when error conditions occur during TC390 operations. The error message describes the error and provides a four-digit error code. The error code may include the XP128/XP1024 SVP error code. If you need to call HP technical support for assistance, report the TC390 and SVP error codes.

**Figure 355: Example of the TC390 error message**



# Using PPRC Commands for TrueCopy

## Overview of PPRC Commands

The XP128/XP1024 supports IBM Peer-to-Peer Remote Copy (PPRC) TSO and ICKDSF commands to perform TC390 operations from the S/390 host system. PPRC TSO commands are issued from the system console to the M-VOL or R-VOL of a TC390 pair. PPRCOPY ICKDSF commands are issued from JCL job cards. The TC390 feature must be installed on the XP128/XP1024 and IBM PPRC must be installed on the host operating system. For TC390A operations, special switches and parameters are used to control and monitor TC390A pairs and groups using PPRC commands.

The following TC390 operations cannot be performed using PPRC commands: async options, and TC390A group addition/deletion. The async options and groups must be configured using the Command View management station before you can add any TC390A pairs (CESTPAIR). You also cannot change the RCU options, initial copy priority, or the DFW to R-VOL pair options using PPRC commands. For more information on the restrictions associated with using PPRC commands instead of TC390 through Command View, see [PPRC Support](#) on page 767.

Port configuration (LCP↔RCP, RCU target↔initiator) is supported through the CESTPATH and CDELPATH TSO commands only when SVP mode 114 ON (refer to [Table 81](#) on page 733). If SVP mode 114 is OFF, you must configure the ports using the licensed TC390 software on the Command View management station before adding paths and after deleting paths.

[Table 106](#) on page 935 lists the TC390 operations and describes the corresponding PPRC TSO and ICKDSF commands. [Using PPRC TSO Commands with TrueCopy Asynchronous](#) on page 938 provides instructions for using the PPRC TSO commands with TC390A pairs.

**Note:** For Fibre Channel interface, do not use the CESTPATH and CDELPATH commands at the same time as the SCSI path definition function of LUN Management. The Fibre Channel interface ports need to be configured as initiator ports or RCU target ports before the CESTPATH and CDELPATH commands are issued.

PPRC TSO command parameter support depends on the CU emulation (3990 or 2105). PPRC command extensions are supported when running with 2105 emulation. The PPRC TSO and ICKDSF commands have required and optional parameters that are not described in detail in this chapter. These commands use slightly different command/keyword names to provide equivalent PPRC functions. For example, the **CESTPAIR** TSO command is equivalent to the **PPRCOPY ESTPAIR** ICKDSF command. This chapter describes the PPRC TSO commands.

The CESTPATH RESETHP option rejects the host I/O operations. Before you use the RESETHP option of the CESTPATH command, stop the I/O operations from the host.

---

**Table 106: TrueCopy operations versus PPRC TSO and ICKDSF commands**

TC390 Operation	TSO Command	ICKDSF Command	Command Issued to:	Description
Configure Port (LCP to RCP, or RCU target to initiator)	-----		-----	<p>If SVP mode 114 is OFF, the ports must be configured using the Command View management station (or SVP). If SVP mode 114 is ON, the ports are configured automatically (LCP/RCP to RCP/LCP, RCU target/initiator to initiator/RCU target) in response to the CESTPATH and CDELPATH TSO commands.</p> <p>For Fibre Channel interface, do not use the CESTPATH and CDELPATH commands at the same time as the SCSI path definition function of LUN Management. The Fibre Channel interface ports need to be configured as initiator ports or RCU target ports <i>before</i> the CESTPATH and CDELPATH commands are issued.</p>
Add RCU	CESTPATH	PPRCOPY ESTPATH	MCU	<p>Establishes logical paths from an MCU to an RCU. The default RCU options are used (see <a href="#">PPRC Support</a> on page 767).</p> <p>For details on using CESTPATH for TC390A, see <a href="#">CESTPATH</a> on page 939.</p>
Delete RCU	CDELPATH	PPRCOPY DELPATH	M-VOL	Deletes all active paths between an MCU and an RCU.
RCU Status	CQUERY/ PATHS	PPRCOPY QUERY/ PATHS	MCU	Displays the status of all paths for the CU specified by the DEVN parameter. TC390 supports the optional FORMAT/UNFORMAT and VOLUME/PATHS parameters.
Asynchronous Options	-----	-----	MCU/RCU	The default TC390A options are used (see <a href="#">PPRC Support</a> on page 767).
Add Group	-----	-----	MCU	Must be performed using the TC390 software. The group options are selected during add group (see <a href="#">Adding Consistency Groups (Add CT Group)</a> on page 854).

**Table 106: TrueCopy operations versus PPRC TSO and ICKDSF commands (Continued)**

TC390 Operation	TSO Command	ICKDSF Command	Command Issued to:	Description
Group Status	-----	-----	MCU/RCU	Must be performed using the TC390 software (see <a href="#">Viewing Consistency Group Status (CT Group Status)</a> on page 852).
Delete Group	-----	-----	MCU	Must be performed using the TC390 software (see <a href="#">Deleting Consistency Groups (Delete CT Group)</a> on page 858).
Add Pair	CESTPAIR (MODE= COPY)	PPRCOPY ESTPAIR	M-VOL	Establishes a TC390 pair and sets the initial copy and pair options (copy mode = synchronous or asynchronous only, priority = 0, CFW data = copy to R-VOL, DFW to R-VOL = not required). TC390 supports the optional MODE, PACE, and CRIT parameters. The MSGREQ parameter defaults to NO (not applicable to TC390A). For details on using CESTPAIR for TC390A, see <a href="#">CESTPAIR</a> on page 941.
Suspend Pair	CSUSPEND	PPRCOPY SUSPEND	M-VOL or R-VOL	Suspends a TC390 pair (or TC390A group). TC390 supports the optional PRIMARY parameter. See Caution below on the QUIESCE parameter. For details on CSUSPEND for TC390A, see <a href="#">CSUSPEND</a> on page 943.
Delete Pair (to MCU)	CDELPAIR	PPRCOPY DELPAIR	M-VOL	Deletes a TC390 pair (or TC390A group) from the MCU. For details on using CDELPAIR for TC390A, see <a href="#">CDELPAIR</a> on page 945.
Delete Pair (to RCU)	CRECOVER	PPRCOPY RECOVER	R-VOL	Deletes a TC390 pair (or TC390A group) from the RCU. For details on using CRECOVER for TC390A, see <a href="#">CRECOVER</a> on page 946.

**Table 106: TrueCopy operations versus PPRC TSO and ICKDSF commands (Continued)**

TC390 Operation	TSO Command	ICKDSF Command	Command Issued to:	Description
Pair Status	CQUERY/ VOLUME	PPRCOPY QUERY/ VOLUME	M-VOL or R-VOL	Displays the TC390 and TC390A pair status of the volume. TC390 supports the optional FORMAT/UNFORMAT and VOLUME/PATHS parameters. For details on using CQUERY for TC390A, see <a href="#">CQUERY for Serial Interface</a> on page 947.
Resume Pair	CESTPAIR (MODE= RESYNC)	PPRCOPY ESTPAIR	M-VOL	Resumes a TC390 pair (or TC390A group), and sets the TC390 initial copy options and pair options. TC390 supports the optional MODE, PACE, and CRIT parameters. For details on using CESTPAIR/RESYNC for TC390A, see <a href="#">CESTPAIR</a> on page 941.
----	P/DAS SWAP	----	M-VOL and R-VOL	Supported by TC390 Synchronous. Command is rejected by TC390A pairs. Redirects application I/Os from the M-VOL to the R-VOL. For details on using P/DAS SWAP with TC390, see <a href="#">P/DAS Support</a> on page 769.
----	CGROUP (FREEZE/ RUN)	----	MCU (M-VOL or simplex)	Supported by TC390 Synchronous. Command is rejected by TC390A pairs. For details on using CGROUP (FREEZE/RUN) with TC390 Synchronous pairs, see <a href="#">CGROUP (FREEZE/RUN) Support</a> on page 950.



**Caution:** The QUIESCE option of the CSUSPEND command has been disabled by APAR OW15247 or APAR OW15248. For detailed information on the QUIESCE option of the CSUSPEND command, refer to either of these APARs. Check with your HP account team before using the CSUSPEND command with the QUIESCE option to suspend TC390 volume pairs on an XP128/XP1024 (or other XP disk array). If the CSUSPEND command with the QUIESCE option is issued to certain volumes (for example, active SPOOL, PAGE, or CATALOG datasets, or active SYSRES volume), the attached host(s) may enter a deadlock condition and may require a storage control IML to correct the condition. TC390A does not support the CSUSPEND/QUIESCE option.

## Using PPRC TSO Commands with TrueCopy Asynchronous

For TC390A operations, special switches and parameters are used to control and monitor TC390A pairs and groups using PPRC commands. This section describes this special use of PPRC TSO commands for TC390A volumes on the XP128/XP1024. [Table 107](#) on page 938 describes the typographic conventions used for the PPRC TSO commands described in this section.

---

**Note:** PPRC TSO command parameter support depends on the emulation (for example, 2105 or 3990). PPRC command extensions are supported when running with 2105 emulation.

---

Use the **PPRC TSO Command** option on the Async Option window to select the XP256-compatible format for PPRC TSO commands (groups 0-F instead of 00-3F).

---

**Note:** The DEVSERV PATHS command displays the pair status of a TC390A volume in the **DC-STATE** field. The contents of this field are the same as for TC390 Synchronous. Note that the TC390A transition states (suspending and deleting) are not displayed.

---

This section does not specifically address the equivalent PPRCOPY ICKDSF commands. Use caution when issuing ICKDSF commands to TC390A volumes.

**Table 107: Typographic conventions for PPRC TSO commands**

Typeface/Symbol	Example	Usage
Normal text	CRIT(YES)	Command/keyword names or console outputs.
Italics	<i>ssid</i>	Parameter to be replaced with an appropriate character or numeric string.
Bold	<b>cmd_param</b>	Command/keyword names, parameters, or console outputs that involve/denote special meaning for TC390A.
Square brackets	[PACE(15)]	Keywords/parameters that can be omitted.
Vertical pipe	(YES   NO)	List of keywords to be selected.
Underline	(YES   <u>NO</u> )	The default keywords/parameters.
Strikethrough	[ <del>QUIESCE</del> ]	Invalid keywords/parameters for TC390A.

## CESTPATH

Use the CESTPATH command to establish remote copy paths for the XP128/XP1024 and can be used for either serial (ESCON) or Fibre Channel interface. For fibre, the RCU controller ID is specified. The syntax for the CESTPATH command is:

For 3990-3, -6 and -6E controller emulations:

```
CESTPATH DEVN(X'dev#') PRIM(X'ssid' serial#) SEC(X'ssid' serial#)
LINK(X'aabbccdd')
```

For 2105 controller emulation ('lss' parameter for LCU no., CGROUP and RESETHP options):

```
CESTPATH DEVN(X'dev#') PRIM(X'ssid' serial# X'lss') SEC(X'ssid' serial# X'lss')
LINK(X'aabbccdd') [CGROUP(YES|NO) RESETHP(YES|NO)]
```

---

**Note:** For fibre, do not use the RESETHP option. For serial, the RESETHP option rejects host I/O operations. Before you use this option, stop the I/O operations from the host. For 2105 emulation, use the CESTPATH CGROUP option to control freeze. Do not use the CGROUP FREEZE option. If you use the FREEZE option, the CESTPATH command will be rejected.

---



**Caution:** Before issuing the CESTPATH command, verify that the relevant paths are offline from the host(s) (for example, configure the Chipid offline, deactivate the LPAR, or block the port in the E3CD). If any active paths still exist, the add path operation will fail because the port mode cannot be changed.

---

**Note:** For Fibre Channel interface, do not use the CESTPATH and CDELPATH commands at the same time as the SCSI path definition function of LUN Management. The Fibre Channel interface ports need to be configured as initiator ports or RCU target ports before the CESTPATH and CDELPATH commands are issued.

---

The following table describes the CESTPATH LINK parameter for serial and Fibre Channel interface.

**Table 108: CESTPATH LINK parameter for serial and Fibre Channel**

LINK Parameter	Serial (ESCON) Interface	Fibre Channel Interface
aa First two digits of SAID, see <a href="#">Table 109</a> on page 941.	FREEZE option 0x00:keep the status 0x01:Enabled 0x02:Disabled  When there are several paths, the same values must be specified for all the paths.	Bit 0-3: RCU controller ID x2-xF: Number stands for RCU controller ID. (x'3' is specified.) Bit 4-7: FREEZE option x0:keep the status x1:Enabled x2:Disabled  When there are several paths, the same values must be specified for all the paths.
bb Second two digits of SAID, see <a href="#">Table 109</a> on page 941.	MCU port number (0x00-0x1f)	MCU port number (0x00-0x1f)
cc	Link Adr (0x00-0xff)	RCU port number (0x00-0x1f)
dd	CU number (0x00-0x1f)	CU number (0x00-0x1f)

The following table gives the XP128/XP1024 system adapter ID (SAID) values for the CESTPATH LINK parameter.

- The last two digits of the link parameter must specify the logical CU number (00-0F for an XP128/XP1024, 00-03 for an XP256).
- For 3990 controller emulation, the first two digits can be 00, 01, or 02. This option controls freeze as follows:
  - 00 = use mode 104
  - 01 = freeze enabled
  - 02 = freeze disabled
- For 2105 emulation, the first two digits must be 00. The CGROUP option of the CESTPATH command is used to control freeze for 2105 emulation.



**Table 109: SAID values for the CESTPATH LINK parameter**

RCP or Initiator Port			RCP or Initiator Port		
Cluster	Port	SAID Value	Cluster	Port	SAID Value
1	CH'A'	X'0000'	2	CH'A'	X'0010'
	CH'B'	X'0001'		CH'B'	X'0011'
	CH'C'	X'0002'		CH'C'	X'0012'
	CH'D'	X'0003'		CH'D'	X'0013'
	CH'E'	X'0004'		CH'E'	X'0014'
	CH'F'	X'0005'		CH'F'	X'0015'
	CH'G'	X'0006'		CH'G'	X'0016'
	CH'H'	X'0007'		CH'H'	X'0017'
	CH'J'	X'0008		CH'J'	X'0018
	CH'K'	X'0009		CH'K'	X'0019
	CH'L'	X'000A		CH'L'	X'001A
	CH'M'	X'000B		CH'M'	X'001B
	CH'N'	X'000C		CH'N'	X'001C
	CH'P'	X'000D		CH'P'	X'001D
	CH'Q'	X'000E		CH'Q'	X'001E
	CH'R'	X'000F		CH'R'	X'001F

## CESTPAIR

[Table 110](#) on page 942 describes how to use the CESTPAIR command to establish TC390A pairs and resume TC390A pairs and groups. The syntax for the CESTPAIR command is:

For 3990-3, -6 and -6E controller emulations:

```
CESTPAIR DEVN(X'dev#') PRIM(X'ssid' cmd_param X'cca') SEC(X'ssid' serial# X'cca')
[MODE(COPY|INOCOPY|RESYNC)] [PACE(pace)] [CRIT(YES|NO)]
[MSGREQ(YES|NO)]
```

For 2105 controller emulation (new 'lss' parameter for LCU number):

```
CESTPAIR DEVN(X'dev#') PRIM(X'ssid' cmd_param X'cca' X'lss') SEC(X'ssid' serial#
X'cca' X'lss') [MODE(COPY|INOCOPY|RESYNC)] [PACE(pace)]
[CRIT(YES|NO)] [MSGREQ(YES|NO)]
```

**Table 110: Using CESTPAIR to establish and resume TrueCopy Async pairs**

Parameter	Contents	Description
cmd_param	<p><i>AGnnd</i>  <i>nn</i> = consistency group number (00-7F) or master volume number (00-FF: for dummy pair mode).  <i>d</i> = 0, N, or D</p>	<p>Without MODE(RESYNC): Specifies the consistency group number <i>nn</i> to which the volume pair will belong.</p> <p>With MODE(RESYNC): Specifies that all M-VOLs in the consistency group should be resynchronized (resumed).  <i>nn</i> must specify the consistency group number of the addressed device or the master volume number. For dummy pair mode, <i>nn</i> must specify the master volume number.</p> <p><i>d</i> specifies the delay option for command retry due to sidefile:  0 = normal delay for command retry starting at HWM (see <a href="#">Graduated Delay Sidefile Management</a> on page 753)  N = no delay time: no command retry delay due to sidefile for this pair. Use the <b>N</b> setting only for a limited number of critical volumes.  D = dummy pair mode (<i>nn</i> must specify the master volume number).</p>
	<p><i>AVnnd</i>  <i>nn</i> = consistency group number (00-7F) or master volume number (00-FF: for dummy pair mode).  <i>d</i> = 0, N, or D</p>	<p>With MODE(RESYNC): Specifies that only the addressed device should be re-synchronized.</p> <p><i>nn</i> must specify the consistency group number of the addressed device or the master volume number. For dummy pair mode, <i>nn</i> must specify the master volume number.</p> <p><i>d</i> specifies the delay option for command retry due to sidefile:  0 = normal delay for command retry starting at HWM (see <a href="#">Graduated Delay Sidefile Management</a> on page 753)  N = no delay time: no command retry delay due to sidefile for this pair. Use the <b>N</b> setting only for a limited number of critical volumes.  D = dummy pair mode (<i>nn</i> must specify the master volume number).</p>
PACE	( <i>pace</i> )	Specifies the pace of the initial copy operation: 1-255, default=15 tracks.
CRIT	(YES)	Specifies the Error Level (TC390A pair option) of Group.
	(NO)	Specifies the Error Level (TC390A pair option) of Volume.

- If the first digit of the **cmd\_param** is other than **A**, the disk array interprets this command as pair establishment for TC390 Synchronous or SI390.

- The consistency group *nn* must be registered prior to this command. Otherwise this command will be rejected.
- When MODE (RESYNC) is specified, the consistency group number *n* must be the consistency group number to which the addressed device belongs. If a different number is specified, this command will be rejected.
- When MODE (RESYNC) is specified, the copy mode (synchronous or asynchronous) cannot be changed. If a different copy mode is specified, this command will be rejected.
- If the consistency group requirements (see [Consistency Groups](#) on page 776) are not satisfied, this command may/may not be rejected.
- The delay option prevents command retry delay for this pair when sidefile is above the HWM (see [Graduated Delay Sidefile Management](#) on page 753). If not specified correctly, command is rejected (F/M=04).
- When *cmd\_param* AGxxx is specified, this command ends *before* the actual pair establishment/re-establishment successfully starts. Confirmation by CQUERY or IEA494I console message is recommended after this command.
- The dummy pair for each primary volume can be established only by the PPRC command. For the use of dummy pair, note the following:
  - Use the dummy pair only for a limited number of the critical volumes.
  - The dummy pair function is only for ESCON-connected TC390A pairs.
  - Up to three dummy pairs can be specified for one master pair.
  - The dummy pair should be an actual volume that has the same CU number as the master pair.
  - The dummy pair should be offline from each host.
  - The dummy pair cannot be used as a user volume.
  - Establish the master pair before establishing the dummy pair.

## CSUSPEND

[Table 111](#) on page 944 describes how to use the CSUSPEND command to suspend TC390A pairs and groups. The syntax for the CSUSPEND command is:

For 3990-3, -6 and -6E controller emulations:

```
CSUSPEND DEVN(X'dev#') PRIM(X'ssid' cmd_param X'cca') SEC(X'ssid' serial# X'cca')-
[PRIMARY] [QUIESCE]
```

For 2105 controller emulation, addressed device is M-VOL (new 'lss' parameter for LCU no.):

```
CSUSPEND DEVN(X'dev#') PRIM(X'ssid' cmd_param X'cca' X'lss') SEC(X'ssid' serial#
X'cca' X'lss') [PRIMARY] [QUIESCE]
```

For 2105 controller emulation, addressed device is R-VOL (new 'lss' parameter for LCU no.):

```
CSUSPEND DEVN(X'dev#') PRIM(X'ssid' cmd_param X'cca' X'lss') SEC(X'ssid' serial#
X'cca' X'lss') [PRIMARY] [QUIESCE]
```

---

**Note:** If you need write access to an R-VOL, you must delete the pair (CDELPAIR).

---

**Table 111: Using CSUSPEND to suspend TrueCopy Async pairs**

Parameters	Contents	Description
cmd_param	AGD00	Specifies that all the volume pairs in the consistency group should be suspended after all pending recordsets are settled ( <b>Drain</b> suspend option).
	AGP00	Specifies that all the volume pairs in the consistency group should be suspended. Pending recordsets are not always settled before suspension ( <b>Purge</b> suspend option).
	AVD00	Specifies that only addressed volume pair should be suspended after the pending recordset for addressed volume settled ( <b>Drain</b> suspend option).
	AVP00	Specifies that only the addressed volume pair should be suspended. Pending recordsets for addressed volume are not always settled ( <b>Purge</b> suspend option).
PRIMARY		Invalid keyword for TC390A volume pairs.
QUIESCE		Invalid keyword for TC390A volume pairs.

\*If the addressed device is the M-VOL, only TC390A pairs in the same disk array are suspended. Volume pairs whose M-VOLs are behind other MCUs are not affected.

- If the first digit of the **cmd\_param** is other than A, the disk array interprets this command as pair suspension for TC390 Synchronous or SI390.

- The **D** and **P** in *cmd\_param* stand for the Drain and Purge options, respectively. For a detailed description of these TC390A suspend options, see [Suspending TrueCopy Pairs \(Suspend Pair\)](#) on page 890.
- When **P** (Purge) is specified, it is not possible to determine exactly which recordset will be settled before the addressed volume pair is suspended.
- Regardless of the number of volume pairs to be suspended, this command ends *before* the actual pair suspension is successfully completed. Confirmation by CQUERY or IEA494I console message is recommended after this command.

## CDELPAIR

The following table describes how to use the CDELPAIR command to delete TC390A pairs and groups at the MCU. The syntax for the CDELPAIR command is:

For 3990-3, -6 and -6E controller emulations:

```
CDELPAIR DEVN(X'dev#') PRIM(X'ssid' cmd_param X'cca' X'ls') SEC(X'ssid' serial#
X'cca' X'ls')
```

For 2105 controller emulation (new 'ls' parameter for LCU number):

```
CDELPAIR DEVN(X'dev#') PRIM(X'ssid' cmd_param X'cca' X'ls') SEC(X'ssid' serial#
X'cca' X'ls')
```

**Table 112: Using CDELPAIR to delete TrueCopy Async pairs/groups at the MCU**

Parameters	Contents	Description
cmd_param	AG000	Specifies that all pairs in the consistency group* should be deleted. All pending recordsets will be settled before deleting the volume pairs.
	AV000	Specifies that only the addressed pair should be deleted. All pending recordsets for the addressed volume will be settled before deleting the volume pair.

\*Only TC390A pairs in the same disk array are deleted. Volume pairs whose M-VOLs are behind other MCUs are not affected.

- If the first digit of the *cmd\_param* is other than **A**, the disk array interprets this command as pair deletion for TC390 Synchronous or SI390.

- The specified pair(s) will be deleted regardless of their pair status. After the pair(s) is/are deleted, the volume(s) will not indicate their pair status before pair deletion. To delete TC390A pairs with their update sequence consistency ensured:
  - Issue the CSUSPEND command with *cmd\_param* of AGP00 or AGD00.
  - Issue CQUERY to confirm that the specified pairs have been successfully suspended with the consistency status of **Group**.
  - Issue the CDELPAIR command.
- Regardless of the number of volume pairs to be deleted, this command ends *before* the actual pair deletion is successfully completed. Confirmation by CQUERY or IEA494I console message is recommended after this command.

## CRECOVER

The following table describes how to use the CRECOVER command to delete TC390A pairs and groups at the RCU. The syntax for the CRECOVER command is:

For 3990-3, -6 and -6E controller emulations:

```
CRECOVER DEVN(X'dev#') PRIM(X'ssid' cmd_param X'cca') SEC(X'ssid' serial# X'cca'  
[ID(old_volser{new_volser})]
```

For 2105 controller emulation (new 'lss' parameter for LCU number):

```
CRECOVER DEVN(X'dev#') PRIM(X'ssid' serial# X'cca' X'lss') SEC(X'ssid' cmd_param  
X'cca' X'lss') [ID(old_volser{new_volser})]
```

**Table 113: Using CRECOVER to delete TrueCopy Async pairs/groups at the RCU**

Parameters	Contents	Description
cmd_param	AC000	AC000 Specifies that all volume pairs (R-VOLs) in the consistency group whose consistency status is Suspended-Group should be deleted.
	AGP00	AG000 Specifies that all volume pairs (R-VOLs) in the consistency group should be deleted regardless of pair status and consistency status. All pending recordsets will be settled before deleting the pairs.
	AVD00	AV000 Specifies that the addressed volume pair (R-VOL) should be deleted regardless of pair status and consistency status. All pending recordsets for the addressed pair will be settled before deleting the pair.
[ID( <i>old_volser</i> { <i>new_volser</i> })]		TC390A does not support this keyword. Depending on the timing, the write command to change the volume serial number may be rejected.

- The addressed device must be the R-VOL.
- If the first digit of the *cmd\_param* is other than A, the disk array interprets this command as pair deletion for TC390 Synchronous or SI390.
- Regardless of the number of volume pairs to be deleted, this command ends *before* the actual pair deletion is successfully completed. Confirmation by CQUERY or IEA494I console message is recommended after this command.

## CQUERY for Serial Interface

The CQUERY command can be issued to a TC390A pair to determine its detailed pair status as well as its TC390A pair and group options. The following example shows the output of the CQUERY command with the VOLUME parameter issued to a TC390A M-VOL.

---

**Note:** When the controller emulation type is 3990, the CQUERY command only displays the path types and path status of the first four paths, even if more than four paths have been added.

---

## CQUERY M-VOL/FORMAT/VOLUME

Output

Example:

```

***** PPRC REMOTE COPY CQUERY - VOLUME *****
*
*                                     (PRIMARY)   (SECONDARY) *
*                                     SSID CCA     SSID CCA     *
*DEVICE   LEVEL      STATE      PATH STATUS SERIAL#     SERIAL#     *
*-----  -----  -----  -----  -----  -----  *
* 0A32   PRIMARY..  PENDING... ACTIVE..    7700 32     7740 12     *
*          CRIT(NO)                               A00SNG030982 000000030954 *
* PATHS SAID/DEST STATUS: DESCRIPTION *
* -----  *
* 1    001D 0000 01  PATH ESTABLISHED... *
*      ---- ---- 00NO PATH..... *
*      ---- ---- 00NO PATH..... *
*      ---- ---- 00NO PATH..... *
* IF STATE = PENDING/SUSPEND:  FIRST CYL OUT OF SYNC = 00117 *
*                               LAST CYL OUT OF SYNC = 03338 *
*                               PERCENT OF COPY COMPLETE = 004% *
*****

```

The **CRIT** field is not used for TC390A (NO is always indicated).

The **FIRST/LAST CYL OUT OF SYNC** and **PERCENT OF COPY COMPLETE** fields indicate the first/last cylinder number and percentage of cylinders (including R-VOL cylinders) to be copied for pair resynchronization. For a more detailed description, see [Resuming TrueCopy Volume Pairs \(Resume Pair\)](#) on page 894.

The **PATHS**, **SSID**, **DEST**, **STATUS**, and **DESCRIPTION** fields show NO PATH for this volume pair instead of the actual path status. CQUERY with PATHS keyword provides the path status for this volume pair.

The following example shows the output of the CQUERY command with the VOLUME parameter issued to a TC390A R-VOL.



**CQUERY R-VOL/FORMAT/VOLUME**

Output

Example:

```

***** PPRC REMOTE COPY CQUERY - VOLUME *****
*
*                                     (PRIMARY)   (SECONDARY) *
*                                     SSID CCA     SSID CCA     *
*DEVICE   LEVEL      STATE      PATH STATUS  SERIAL#      SERIAL#      *
*-----
* 0B12    SECONDARY  SUSPEND(5)  ACTIVE..    7700 32     7740 12     *
*                                     ..... A00SGG030954 *
* PATHS SAID/DEST STATUS: DESCRIPTION *
*-----
* 0      ----  ----   00      NO PATH..... *
*                                     ----  ----   00      NO PATH..... *
*                                     ----  ----   00      NO PATH..... *
*                                     ----  ----   00      NO PATH..... *
* SECONDARY WAS SUSPENDED (YMD/GMT): 1998-10-17 14.18.12.242451 *
*****

```

The **SECONDARY WAS SUSPENDED (YMD/GMT)** field displays the consistency time of this pair if the pair status is Suspended or Duplex. For more information on the TC390A consistency time, see [Group Consistency Time](#) on page 758.

If the timer type for the consistency group is System, the RCU indicates the content of the time-stamp given by the primary system with no modification.

**CQUERY for Fibre Channel Interface**

The path types and path status for Fibre Channel remote copy connections can be displayed by the CQUERY command. The RCU controller ID can also be displayed.

The following example shows the output of the CQUERY command and [Table 114](#) on page 950 describes the parameters used in the example for both serial and Fibre Channel interface.

---

**Note:** When the controller emulation type is 3990, the CQUERY command only displays the path types and path status of the first four paths, even if more than four paths have been added.

---

Output CQUERY  
Example:

```

***** PPRC REMOTE COPY CQUERY - VOLUME *****
*
*                                     (PRIMARY)   (SECONDARY)*
*                                     SSID CCA    SSID CCA    *
*DEVICE   LEVEL      STATE      PATH STATUS SERIAL#      SERIAL#      *
*-----
* 0A32   PRIMARY..   PENDING... ACTIVE...   7700 32     7740 12     *
*                CRIT(NO)                A00SNG030982 000000030954 *
* PATHS SAID/DEST STATUS: DESCRIPTION
* -----
* 1    001D 0000 01    PATH ESTABLISHED...
*      ---- ---- 00    NO PATH.....
*      ---- ---- 00    NO PATH.....
*      ---- ---- 00    NO PATH.....
* IF STATE = PENDING/SUSPEND:  FIRST CYL OUT OF SYNC = 00117
*                                LAST CYL OUT OF SYNC = 03338
*                                PERCENT OF COPY COMPLETE = 004%
*****

```

Table 114: CQUERY output for serial and Fibre Channel

LINK Parameter	Serial (ESCON) Interface	Fibre Channel Interface
aa	FREEZE option 0x00:keep the status 0x01:Enabled 0x02:Disabled	Bit 0-3: RCU controller ID x2-xF: Number stands for RCU controller ID. Bit 4-7: FREEZE option x0:keep the status x1:Enabled x2:Disabled
bb	MCU port number (0x00-0x1f)	MCU port number (0x00-0x1f)
cc	Link Adr (0x00-0xff)	RCU port number (0x00-0x1f)
dd	CU number (0x00-0x1f)	CU number (0x00-0x1f)

## CGROUP (FREEZE/RUN) Support

The TC390 feature supports the CGROUP (FREEZE/RUN) TSO command for PPRC, which is also used in IBM's Geographically Dispersed Parallel Sysplex (GDPS) environment. The CGROUP TSO command is used to control I/O operations for TC390 Synchronous pairs on a specific MCU-RCU pair. The CGROUP command is supported for the XP128/XP1024 (and other XP disk arrays) functioning as TC390 MCUs. The XP disk arrays provides all required

host reporting for CGROUP operations (for example, IEA494I with extended long busy (ELB) state), which is a key component of GDPS operations. For disaster recovery implementations, you must use the XP128/XP1024 at both sites because the RCUs will become MCUs in the event of a disaster.

The CGROUP command has two parameters, FREEZE and RUN. The CGROUP/FREEZE command stops all host I/O operations to the specified TC390 M-VOLs as well as all TC390 update copy operations to their associated R-VOLs. The CGROUP/RUN command changes the pair status to *suspended* and allows the M-VOLs to start accepting host I/Os.

---

**Note:** For 2105 controller emulation, do not use the FREEZE option. Use the CGROUP option of the CESTPATH command (see [CESTPATH](#) on page 939).

---



**Caution:** The XP128/XP1024 executes the CGROUP command on TC390 Synchronous pairs. TC390A does not support the CGROUP TSO command. If CGROUP is issued to a TC390A volume, the XP128/XP1024 will reject the command. CGROUP (FREEZE/RUN) operations on TC390 Synchronous pairs do not affect TC390A pairs in any way.

---

## Requirements

The CGROUP command can be issued only to a TC390 Synchronous M-VOL or a simplex volume in the MCU. If CGROUP is issued to a TC390 R-VOL, the RCU will reject the CGROUP command (F/M=0F, TC390 error code=58). The CGROUP command must be issued to each logical CU image of the MCU, unless the XP128/XP1024's mode 64 (see description below) is enabled.

The requirements for CGROUP (FREEZE/RUN) support are:

- **MCU:** The MCUs to which the CGROUP command will be issued must be XP128/XP1024s (all-mainframe and multiplatform disk arrays are both supported). For disaster recovery implementations, you must use the XP128/XP1024 at both sites because the RCUs will become MCUs in the event of a disaster.
- **PPRC:** The host systems at the main and remote sites must have IBM PPRC support as well as the PPRC ERP PTF installed. ICKDSF does not support the CGROUP command.

- **SSIDs:** The MCUs to which the CGROUP command will be issued must have consecutive SSIDs. The HP representative configures the SSIDs on the XP128/XP1024 SVP.



**Caution:** MVS requires that the disk array be offline during SSID changes. Reconfiguring SSIDs is therefore a disruptive event that must be carefully planned.

---

- **FREEZE Option (3990 only):** The FREEZE option must be enabled on the MCUs to which the CGROUP command will be issued. If not enabled, the MCU will reject the CGROUP TSO command. The FREEZE option is enabled using the Command View management station (RCU Option window). Enable the FREEZE option only after adding all MCU-RCU paths.

---

**Note:** Mode 104 (see below) changes the default FREEZE option from disabled to enabled. Mode 104 is invalid for 2105 emulation.

For 2105 controller emulation, do not use the FREEZE option. Use the CGROUP option of the CESTPATH command (see [CESTPATH](#) on page 939).

---

The definition of the **LINK Parameter for the CESTPATH command** will be expanded to specify the FREEZE option on an **LCU pair basis**. The FREEZE option set by the CESTPATH command is effective until another CESTPATH command that specifies the same LCU pair but a different FREEZE Option is issued. The command syntax and parameter definitions are as follows (3990 only):

```
CESTPATH PRIM(x'ssid' serial#) SEC(x'ssid' serial#) LINK(x'pppplcc',  
'pppplcc',...) DEVN(x'1234')
```

where:

**pppp** = ESCON or Fibre Channel port ID of the primary CU (MCU) from which the TC390 paths should be established and the FREEZE option for the LCU pair. Note that the first two digits (FREEZE option) must be the same in a series of link parameters.

For ESCON cable:

Value	Port ID	Freeze Option
X'0000'-X'001F'	Interface 1A-2R	Default

X'0100'-X'011F'	Interface 1A-2R	Enabled
X'0200'-X'021	F'Interface 1A-2R	Disabled

For Fibre Channel cable:

Value	Port ID	Freeze Option
X'2000'-X'201F'	Interface 1A-2R	Default
X'2100'-X'211F'	Interface 1A-2R	Enabled
X'2200'-X'221F'	Interface 1A-2R	Disabled

*ll* = For ESCON cable: ESCON destination link address. The destination port number of ESCD must be specified if the TC390 link is connected through an ESCD dynamic connection. Otherwise, "00" must be specified.

For Fibre Channel cable: Fibre Channel port ID of the secondary CU (RCU) from which the paths of the TC390 should be established.

*cc* = LCU number of the secondary CU (RCU).

The parameters may be described in the GDPS DASD configuration list. The required link parameter values must be written into the list or must be given to RCMF input.

- **Mode 59 (HXRC only):** Mode 59 must be ON for HXRC (activates variable RECSIZE to provide performance improvement).
- **Mode 64 (optional):** Mode 64 extends the range of the CGROUP command to the entire MCU instead of just one logical CU image. When mode 64 is enabled, one CGROUP command to any M-VOL or simplex volume in the MCU is executed across all MCU-RCU paths and on all TC390 M-VOLs in the specified MCU, including all CU images (CU0-CU3). When mode 64 is disabled, you must issue a separate CGROUP command to an M-VOL (or simplex volume) in each logical CU image of the MCU. Although this mode can be enabled nondisruptively (that is, existing TC390 pairs do not have to be deleted), mode 64 should be enabled at the same time that mode 49 is enabled.

---

**Note:** For operations in a GDPS environment, mode 64 must be OFF.

---

- **Mode 104 (3990 only):** Mode 104 changes the default FREEZE option to *enabled*. This mode should be enabled when CGROUP is being used in the GDPS environment. When mode 104 is enabled, the FREEZE option will remain enabled after the XP128/XP1024 is powered off and then back on (for

example, due to some disaster). When mode 104 is not enabled, the FREEZE option will revert to the default value of *disabled* after the XP128/XP1024 is powered off and back on.

---

**Note:** For operations in a GDPS environment, mode 104 must be ON.

Mode 104 is invalid for 2105 emulation.

For more information on XP128/XP1024 SVP modes related to TC390 (and HXRC) operations, refer to [Table 81](#) on page 733.

---

## CGROUP (FREEZE/RUN) Command

The CGROUP TSO command specifies all of the following:

- The device (LDEV ID of TC390 M-VOL or simplex volume) (DEVN parameter).
- The MCU (S/N and lowest SSID in CU image) (PRIM parameter).
- The RCU (S/N and lowest SSID in CU image) (SEC parameter).

The CGROUP TSO command has the following two options:

- **FREEZE (3990 only):** When CGROUP is issued with the FREEZE option, the MCU:
  - Blocks the logical path(s) between the specified MCU CU image and RCU CU image to stop all TC390 update copy operations to the R-VOLs in the specified RCU.
  - Presents state change pending (SCP) with extended long busy status to host I/O requests, which causes the host to queue I/Os for the M-VOLs. SCP is indicated until the CGROUP/RUN command is issued or until the SCP delay time expires.

---

**Note:** After all logical MCU-RCU paths are established, make sure to specify the SCP delay time (0-600 seconds) for the MCU using the RCU Option window. To register the SCP delay time, select **OK** to close the RCU Option window, even if you did not make any changes.

If the specified MCU does not have any TC390 M-VOLs, the FREEZE command is executed without performing any operations (paths are not blocked, SCP is not indicated).

For 2105 emulation, use the CESTPATH CGROUP option to control freeze.

---

- **RUN:** When CGROUP is issued with the RUN option, the MCU:
  - Suspends all TC390 pairs with M-VOLs on the specified MCU CU image.
  - Presents a state-change-interrupt (SCI) to the host(s) so that the host(s) re-issue the I/Os that were waiting while the M-VOLs were in the SCP state.
  - Changes the TC390 M-VOL fence level to **Never** (PPRC CRIT=NO) so that the suspended M-VOLs accept host write I/O operations.

The following table shows the TC390 pair status for TC390 M-VOLs and R-VOLs during CGROUP (FREEZE/RUN) operations.

**Table 115: TrueCopy pair status during CGROUP (FREEZE/RUN) operations**

	Before CGROUP (FREEZE/RUN)		After CGROUP/FREEZE		After CGROUP/RUN	
	M-VOL	R-VOL	M-VOL	R-VOL	M-VOL	R-VOL
TC390 Pair Status	Simplex	---	Simplex	---	Simplex	---
	Pending	Pending	Pending	Pending	Suspended	Pending
	Duplex	Duplex	Duplex	Duplex	Suspended	Duplex
	Suspended	Suspended	Suspended	Suspended	Suspended	Suspended

## Using the CGROUP Command

The following figure shows a simplified operational example of the CGROUP (FREEZE/RUN) command implemented in a GDPS environment. The CGROUP (FREEZE/RUN) TSO command can be issued by the user or through automation (such as GDPS) to perform the following sequence of actions:

1. Suspend host updates to all TC390 M-VOLs on the specified MCU.
2. Block the specified MCU-RCU path to stop update copy operations to the R-VOLs.
3. Change all TC390 M-VOLs on the specified MCU to suspended.
4. Resume host updates to the suspended M-VOLs.
5. The add RCU operation (CESTPATH) must be performed to re-establish the blocked logical paths. After the MCU-RCU path is re-established, the resume pair operation (CESTPAIR/RESYNC) must be performed to resume the suspended pairs.

For the following figure:

1. Read/write I/Os are issued from the host.
2. A failure occurs on a TC390 M-VOL and the MCU suspends the pair.
3. Suspend and extended long busy state are reported to the host.
4. Host reports IEA494I with extended long busy state.
5. CGROUP/FREEZE commands are issued to groups.
6. SCP sense bytes are reported if an I/O is issued to a frozen volume.
7. I/Os are queued at the host.
8. Switch to remote (secondary) site.

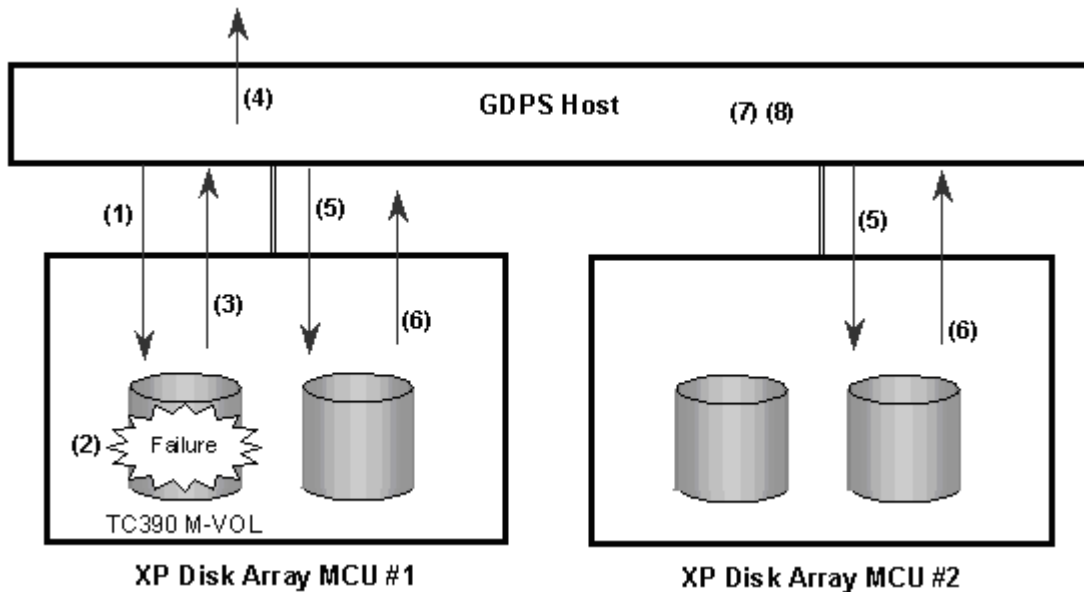


Figure 356: Overview of GDPS operations

## Using PPRC TSO Commands with CGROUP Support

**CESTPATH.** You can use the CESTPATH command to recover a blocked MCU-RCU path. Make sure to use the same parameters as when the path was established.



**CESTPAIR.** After you re-establish the MCU-RCU path that was blocked, you can use the CESTPAIR/RESYNC command to resume the TC390 pairs suspended by the CGROUP/RUN command.

**CDELPAIR.** After you re-establish the MCU-RCU path that was blocked, you can use the CDELPAIR command to delete the TC390 pairs suspended by the CGROUP/RUN command. If CDELPAIR is issued to a TC390 pair whose MCU-RCU path is still blocked, the MCU rejects the command (F/M=0F, TC390 error code=5A).

**CRECOVER.** You can use the CRECOVER command to change a suspended R-VOL to simplex. This command is issued to the R-VOL and does not affect the suspended M-VOL.

**CQUERY/PATHS.** The following example shows the output of the CQUERY command issued to a TC390 MCU to which the CGROUP/FREEZE command has been issued.

*CQUERY M-VOL/Paths/Format  
Output  
Example:*

```
***** PPRC REMOTE COPY CQUERY - PATHS *****
* PRIMARY UNIT: SERIAL#= 000000090217  SSID= 00F8 *
*          FIRST          SECOND          THIRD          FOURTH          *
*          SECONDARY      SECONDARY      SECONDARY      SECONDARY      *
*SERIAL NO: 000000090217  .....          .....          .....          *
*   SSID:    00F8          0000          0000          0000          *
*   PATHS:   1            0            0            0            *
*          SAID DEST S*   SAID DEST S*   SAID DEST S*   SAID DEST S*   *
*          ----- --   ----- --   ----- --   ----- --   *
*          1: 0020 FF04 10  ----  ----  00  ----  ----  00  ----  ----  00  *
*          2: ----  ----  00  ----  ----  00  ----  ----  00  ----  ----  00  *
*          3: ----  ----  00  ----  ----  00  ----  ----  00  ----  ----  00  *
*          4: ----  ----  00  ----  ----  00  ----  ----  00  ----  ----  00  *
*
* S* = PATH STATUS:
* 00=NO PATH          01=ESTABLISHED          02=INIT FAILED
* 03=TIME OUT        04=NO RESOURCES AT PRI 05=NO RESOURCES AT SEC
* 06=SERIAL# MISMATCH 07=(RESERVED)          08=(RESERVED)
* 09=(RESERVED)      10=CONFIGURATION ERROR
*****
```

The following example shows the output of the CQUERY command issued to the TC390 RCU that has a blocked path due to the CGROUP/FREEZE command.

**CQUERY R-VOL/Paths/Format***Output**Example:*

```

***** PPRC REMOTE COPY CQUERY - PATHS *****
* PRIMARY UNIT: SERIAL#= ..... SSID= 0000 *
*          FIRST          SECOND          THIRD          FOURTH *
*          SECONDARY      SECONDARY      SECONDARY      SECONDARY *
*SERIAL NO: 000000090217 ..... *
*   SSID:    00F8          0000          0000          0000 *
*   PATHS:   1            0            0            0 *
*           SAID DEST S*  SAID DEST S*  SAID DEST S*  SAID DEST S* *
*           ----- --  ----- --  ----- --  ----- -- *
*           1: 0020 FF04 10  ----  ----  00  ----  ----  00  ----  ----  00 *
*           2: ----  ----  00  ----  ----  00  ----  ----  00  ----  ----  00 *
*           3: ----  ----  00  ----  ----  00  ----  ----  00  ----  ----  00 *
*           4: ----  ----  00  ----  ----  00  ----  ----  00  ----  ----  00 *
*
* S* = PATH STATUS: *
* 00=NO PATH          01=ESTABLISHED          02=INIT FAILED *
* 03=TIME OUT        04=NO RESOURCES AT PRI  05=NO RESOURCES AT SEC*
* 06=SERIAL# MISMATCH 07=(RESERVED)          08=(RESERVED) *
* 09=(RESERVED)      10=CONFIGURATION ERROR *
*****

```

**CQUERY/VOLUME.** The following example shows the output of the CQUERY command issued to a TC390 M-VOL that has been suspended by the CGROUP/RUN command. As shown in the example, CQUERY issued to an M-VOL also indicates the status of the FREEZE option: CGRPLB(YES) = enabled, CGRPLB(NO) = disabled.

**CQUERY M-VOL/Volume/Format**

Output

Example:

```

***** PPRC REMOTE COPY CQUERY - VOLUME ***** TC390 M-VOL is
*
*                               (PRIMARY)   (SECONDARY) * suspended by
*                               SSID CCA     SSID CCA   * CGROUP/RUN.
*DEVICE   LEVEL      STATE      PATH STATUS  SERIAL#     SERIAL#     *
*-----  -
* 0F80    PRIMARY..  SUSPEND(A)  INACTIVE    00F8 00     00F8 02     * FREEZE option
*                               CRIT(NO)..... CGRPLB(YES) 000000090217 000000090217 * is enabled.
* PATHS SAID/DEST STATUS: DESCRIPTION * Logical path
*-----  -
* 1      0020 FF04   10      CONFIGURATION ERROR * is blocked by
*                               -----
*                               00      NO PATH..... *
*                               00      NO PATH..... *
*                               00      NO PATH..... *
*                               PERCENT OF COPY COMPLETE = 100% *
*****

```

The following example shows the output of the CQUERY command issued to a TC390 R-VOL whose M-VOL has been suspended by the CGROUP/RUN command. The pair status and path status at the RCU are not changed.

**CQUERY R-VOL/Volume/Format**

Output

Example:

```

***** PPRC REMOTE COPY CQUERY - VOLUME ***** No change to
*
*                               (PRIMARY)   (SECONDARY) * R-VOL pair
*                               SSID CCA     SSID CCA   * status.
*DEVICE   LEVEL      STATE      PATH STATUS  SERIAL#     SERIAL#     *
*-----  -
* 0F82    SECONDARY  DUPLEX....  ACTIVE..    00F8 00     00F8 02     * No change to
*                               .....          .....      000000090217 * path status.
* PATHS SAID/DEST STATUS: DESCRIPTION *
*-----  -
* 1      0020 FF04   10      CONFIGURATION ERROR *
*                               -----
*                               00      NO PATH..... *
*                               00      NO PATH..... *
*                               00      NO PATH..... *
*                               *****

```

## IEA494I and IEA491E Console Messages

When a TC390 pair is suspended, whether user-requested or due to failure, the MCU generates sense information to notify the host(s). If the PPRC ERP PTF is installed and **PPRC Support = Yes** is selected on the RCU option window, this

notification results in an IEA494I system console message as well as an IEA491E message. The IEA491E message indicates the reason for suspension. The IEA494I and IEA491E messages are generated by the S/390 host based upon SSBs (sense bytes) from the disk array and not SIMs from the disk array. Therefore, SIMs reported by the disk array to the host are not used by the GDPS scripting.

The IEA494I message is recommended as a trigger for automation over the IEA491E message. The IEA491E message is reported to only one host system, whereas the IEA494I message is reported to all attached MVS hosts each time the M-VOL pair status changes. GDPS uses the IEA494I message with extended long busy as a trigger for CGROUP (FREEZE/RUN).

---

**Note:** If **PPRC Support = No** is selected on the RCU Option window, the host generates the system console message that includes the SIM instead of the IEA494I or IEA491E message.

---

## IEA494I Message

Whenever a TC390 pair status changes, with the exception of the TC390A transition states *suspending* and *deleting*, the MCU reports state-change-interrupt (SCI) to all hosts. In response to the SCI, the IEA494I system console message is generated (if supported by the host). The XP128/XP1024 reports SCI for both online and offline devices, but the host system does not generate console messages for offline devices. Therefore, the IEA494I message is never generated with a TC390 R-VOL device address. The following figure shows an example of an IEA494I message.

- The XP128/XP1024 MCU reports SCI for all TC390A pairs whose status has changed, regardless of the Group/Volume option of the suspend or delete pair operation (if the status change was user-requested).
- The XP128/XP1024 MCU reports SCI for all TC390 M-VOLs (synchronous only) that are in the SCP state due to the CGROUP/FREEZE command. As shown in the following figure, this IEA494I message indicates the extended long busy state.
- The XP128/XP1024 MCU reports SCI for all TC390 M-VOLs (synchronous only) that are suspended due to the CGROUP/RUN command. This IEA494I message indicates the extended long busy state.

- When the FREEZE option is enabled, the XP128/XP1024 MCU reports SCI for a TC390 pair that is suspended due to a failure. When the host supports GDPS, this IEA494I message with extended long busy triggers the CGROUP (FREEZE/RUN) command.

*Output Example:* IEA494I Message with Extended Long Busy State

```
IEA494I 0FC3,RD0FC3,PPRC PAIR SUSPENDING,SSID=0FC0,CCA=03,EXTENDED LONG BUSY STATE
```

## IEA491E Message

When a TC390 pair is suspended due to a failure, the XP128/XP1024 MCU reports SCI as well as unit check status and sense bytes with F/M = FB. In response to the F/M=FB sense bytes, the IEA491E system console message is generated (if supported by the host). The following figure shows an example of an IEA491E message.

**Note:** If the host supports GDPS and the FREEZE option is enabled, the IEA494I system console message with extended long busy, which was generated in response to the SCI, triggers the CGROUP (FREEZE/RUN) command.

*Output Example:* IEA491E Message

```
IEA491E DSLFC0,PPRC SUSPENDED, SECONDARY NOT READY, INTERVENTION_REQUIRED,
(PRI)SER=0113-90797,CCA=00 (SEC)SER=0113-90217,CCA=
```

## XP128/XP1024 Response Characteristics to Failure Conditions

The XP128/XP1024 supports the CGROUP command in the GDPS environment by performing PPRC-compatible actions and returning PPRC-compatible messages to failure conditions. The following figure shows the failure conditions and the following table describes the response characteristics of the XP128/XP1024 to these failure conditions.

**Note:** The **PPRC Support=Yes** option must be selected on the RCU option window (see [Registering an RCU \(Add RCU\)](#) on page 830). If not, the host processor generates the system console message that includes the SIM instead of the IEA494I or IEA491E message.

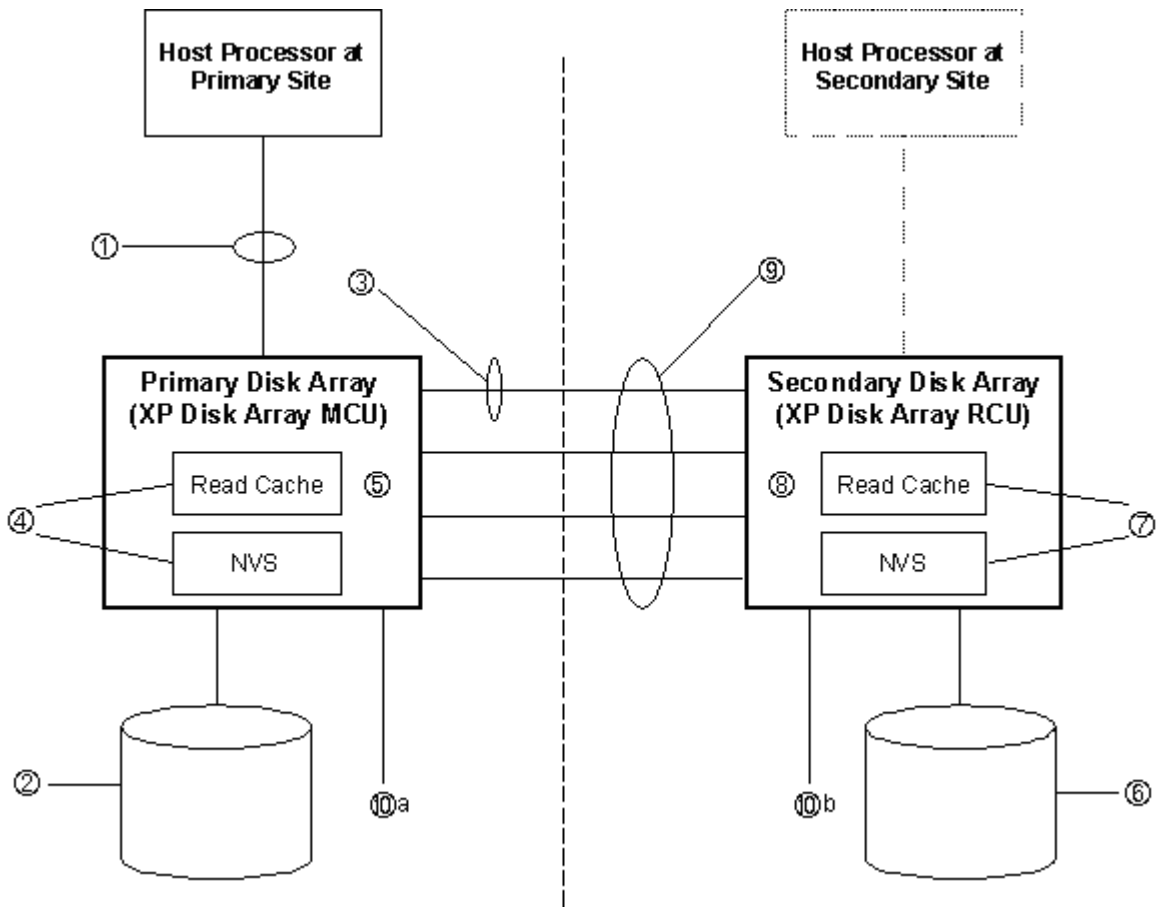


Figure 357: Failure conditions (described in Table 116)

**Table 116: XP128/XP1024 response characteristics to failure conditions**

Failure Condition	TC390 Pairs Suspended?	Expected Messages	FREEZE Function
z Failure of all channel interfaces on the MCU	No	No IEA480, IEA491, or IEA494 messages are displayed.	Not activated
j Failure of a disk on the MCU			
a. Failure of one physical device in a parity group	No	<ol style="list-style-type: none"> <li>1. IEA480 message (SIM for physical device blocked or port of physical device blocked) is displayed when the next I/O is issued to any logical volume in the parity group.</li> <li>2. No IEA491 or IEA494 messages are displayed.</li> </ol>	Not activated
b. Failure of two physical devices in a parity group	No	<ol style="list-style-type: none"> <li>1. IEA480 message (SIM for LDEV blocked) is displayed when the next I/O is issued to any logical volume in the parity group.</li> <li>2. No IEA491 or IEA494 messages are displayed.</li> </ol>	Not activated
– Failure of a link between the MCU and RCU	No	<ol style="list-style-type: none"> <li>1. IEA480 message (SIM for TC390 path blocked) is reported when the next I/O to any device in this MCU is issued.</li> <li>2. No IEA491 or IEA494 messages are displayed.</li> </ol>	Not activated
D Failure of NVS on the MCU; Failure of MCU read cache			
a. One side of MCU cache blocked due to failure	No <sup>1</sup>	<ol style="list-style-type: none"> <li>1. IEA480 (SIM for cache blocked) is reported when the next I/O to any device in this MCU is issued.</li> <li>2. No IEA491 or IEA494 messages are displayed.</li> </ol>	Not activated
b. One side of MCU cache blocked due to maintenance	No <sup>1</sup>	No IEA480, IEA491, or IEA494 messages are displayed.	Not activated

**Table 116: XP128/XP1024 response characteristics to failure conditions (Continued)**

Failure Condition	TC390 Pairs Suspended?	Expected Messages	FREEZE Function
c. One side of MCU cache blocked by SET CACHE OFF	No <sup>1</sup>	No IEA480, IEA491, or IEA494 messages are displayed.	Not activated
<i>f</i> Both sides of MCU cache blocked due to failure	No	No IEA480, IEA491, or IEA494 messages are displayed. The MCU returns CC=3 for all I/Os.	Not activated
Y Failure of a disk on the RCU			
a. Failure of one physical device in a parity group	No	<ol style="list-style-type: none"> <li>1. The RCU reports IEA480 message (SIM for physical device blocked or port of physical device blocked) to either the MCU or the host processor (whichever issues the next I/O first) when the next I/O is issued to any logical volume in the parity group. If MCU receives the SIM, it passes the SIM to the attached host processor, and the IEA480 message is reported when the next I/O to this MCU is issued to any main (primary) volume paired with the logical volume in the parity group.</li> <li>2. No IEA491 or IEA494 messages are displayed.</li> </ol>	Not activated



Table 116: XP128/XP1024 response characteristics to failure conditions (Continued)

Failure Condition	TC390 Pairs Suspended?	Expected Messages	FREEZE Function
b. Failure of two physical devices in a parity group	Yes	<ol style="list-style-type: none"> <li>1. The RCU reports IEA480 message (SIM for LDEV blocked) to either the MCU or the host processor (whichever issues the next I/O first) when the next I/O is issued to any logical volume in the parity group. If MCU receives the SIM, it passes the SIM to the attached host processor, and the IEA480 message is reported when the next I/O to this MCU is issued to any main volume paired with the logical volume in the parity group.</li> <li>2. One (or more) IEA494 messages showing EXTENDED LONG BUSY are displayed.</li> <li>3. One (or more) IEA491 and IEA494 messages showing PAIR SUSPENDED are displayed.</li> </ol>	Activated if the FREEZE option is <b>enabled</b> for the affected LCU pairs.
ý Failure of NVS on the RCU; Failure of RCU read cache			
a. One side of RCU cache blocked due to failure	No	<ol style="list-style-type: none"> <li>1. The RCU reports IEA480 message (SIM for cache blocked) to either the MCU or the host processor (whichever issues the next I/O first). If MCU receives the SIM, it passes the SIM to the attached host processor. Therefore, IEA480 is reported when the next I/O to any device in this MCU issued.</li> <li>2. No IEA491 or IEA494 messages are displayed.</li> </ol>	Not activated
b. One side of RCU cache blocked due to maintenance	No	No IEA480, IEA491, or IEA494 messages are displayed.	Not activated

**Table 116: XP128/XP1024 response characteristics to failure conditions (Continued)**

Failure Condition	TC390 Pairs Suspended?	Expected Messages	FREEZE Function
c. One side of RCU cache blocked by SET CACHE OFF	No	No IEA480, IEA491, or IEA494 messages are displayed.	Not activated
« Both sides of RCU cache blocked due to failure	Yes	<ol style="list-style-type: none"> <li>1. No IEA480 (SIM of cache blocked) is displayed.</li> <li>2. One (or more) IEA494 messages showing EXTENDED LONG BUSY are displayed.</li> <li>3. One (or more) IEA491 and IEA494 messages showing PAIR SUSPENDED are displayed.</li> <li>4. If CGROUP FREEZE and RUN are issued, IEA494 messages showing PAIR SUSPENDED are displayed when the MCU accepts CGROUP-RUN. These messages are from the TC390 pairs for which FREEZE option is enabled and from main volumes that did not already report IEA491/IEA494 at (3).</li> </ol>	Activated if the FREEZE option is <b>enabled</b> for the affected LCU pairs.
» Failure of all links between the MCU and RCU	Yes	<ol style="list-style-type: none"> <li>1. IEA480 (SIM for TC390 path blocked) message is reported when the next I/O to any device in this MCU is issued.</li> <li>2. One (or more) IEA494 messages showing EXTENDED LONG BUSY are displayed.</li> <li>3. One (or more) IEA491 and IEA494 messages showing PAIR SUSPENDED are displayed.</li> </ol>	Activated if the FREEZE option is <b>enabled</b> for the affected LCU pairs.

**Table 116: XP128/XP1024 response characteristics to failure conditions (Continued)**

Failure Condition	TC390 Pairs Suspended?	Expected Messages	FREEZE Function
... Power failure			
a. On the MCU	No	No IEA480, IEA491, or IEA494 messages are displayed.	Not activated
b. On the RCU	Yes	<ol style="list-style-type: none"> <li>1. IEA480 (SIM of TC390 path blocked) message is reported when the next I/O to any device in this MCU is issued.</li> <li>2. One (or more) IEA494 messages showing EXTENDED LONG BUSY are displayed.</li> <li>3. One (or more) IEA491 and IEA494 messages showing PAIR SUSPENDED are displayed.</li> </ol>	Activated if the FREEZE option is <b>enabled</b> for the affected LCU pairs.

1. When one side of the MCU cache is blocked, duplex TC390 pairs are not affected, but pending duplex TC390 pairs are suspended. Suspending TC390 pairs with pending duplex status provides additional protection in the unlikely event of a cache failure.

### GDPS-TC390-HXRC Matrix

The following table compares IBM 3990-6E GDPS support to XP disk array GDPS support, and also provides a comparison of TC390 and HXRC to PPRC and XRC.

---

**Note:** The information shown in the following table was current at the time of publication of this document but is expected to change over time. Contact your HP account team for the latest GDPS-TC390-HXRC matrix information.

---

**Table 117: GDPS-TC390-HXRC matrix**

S/390 Feature	IBM 3990-6E	XP128/XP1024	XP48/XP512
<b>GDPS</b>			
Planned outage	Supported	Supported	Supported
Unplanned outage through IEA494I	Supported	Supported	Supported

**Table 117: GDPS-TC390-HXRC matrix (Continued)**

S/390 Feature	IBM 3990-6E	XP128/XP1024	XP48/XP512
IEA494I Long Busy message	Default time of 120 seconds for FREEZE after IEA494I message is issued.	Default time for FREEZE is 120 seconds, optional user-defined from 0 to 600 seconds after IEA494I message is issued.	Default time for FREEZE is 120 seconds, optional user-defined from 0 to 600 seconds after IEA494I message is issued.
Peer-to-Peer Remote Copy	PPRC	TC390, TC390A	CA
Hardware based	3990-6 to 3990-6	XP128/XP1024/XP256 to XP128/XP1024/XP256. XP128/XP1024 is restricted to CPU 0-3 when attached to XP256.	XP128/XP1024/XP256 to XP128/XP1024/XP256. XP128/XP1024 is restricted to CPU 0-3 when attached to XP256.
disk array-disk array interface	ESCON – maximum of 43 km Communication through channel extenders	ESCON – maximum of 43 km Communication through channel extenders	ESCON – maximum of 43 km Communication through channel extenders
Copy modes supported	Synchronous	Synchronous, asynchronous The default for IBM software commands is synchronous.	Synchronous, semi-synchronous, asynchronous Semi-synchronous can be specified only by Remote Console PC (or SVP). The default for IBM software commands is synchronous.
Dual Copy combination support	Supported	Not Supported. Dual Copy is not supported by disk array.	Not Supported. Dual Copy is not supported by disk array.
TSO command Support	Supported	Supported. Some additional options only available through the Command View management station (or SVP).	Supported. Some additional options only available through the Remote Console PC (or SVP).
ICKDSF command support	Supported	Supported. Some additional options only available through the Command View management station (or SVP).	Supported. Some additional options only available through the Remote Console PC (or SVP).

**Table 117: GDPS-TC390-HXRC matrix (Continued)**

S/390 Feature	IBM 3990-6E	XP128/XP1024	XP48/XP512
P/DAS support	Supported	Supported	Supported
Maximum pairs	64	8,192	4,096
Maximum paths between disk arrays	4	8 per logical control unit	8 per logical control unit
Number of copy operations on initial copy	4	1 to 4, default is 4 per LCU. Requires Command View management station (or SVP) to change default.	1 to 4, default is 4 per LCU. Requires Remote Console PC (or SVP) to change default.
Dedicated interface between disk arrays	No	Requires main disk array port to be set to Target by Command View management station (or SVP) or automatically in response to establish and delete path commands.	Requires main disk array port to be set to LCP or Target by Remote Console PC (or SVP) or automatically in response to establish and delete path commands.
PACE parameter initial copy option	1-255, default is 15 (setting of 1 copies a maximum of 3 tracks at a time, 2-255 copies a maximum of 15 tracks at a time)	3 or 15, default = 15 tracks	3 or 15, default = 15 tracks
CRITICAL pair error options (Fence Level parameter)	Yes No – Default	R-VOL Data Never – Default R-VOL Status	R-VOL Data Never – Default R-VOL Status
CGROUP	FREEZE/RUN by logical controller SSID pair	FREEZE/RUN by logical controller SSID pair, or optionally by entire disk array using mode 64.	FREEZE/RUN by logical controller SSID pair, or optionally by entire disk array using mode 64.
CQUERY	Supported	Supported.	Supported. When the connected control unit is an XP48/XP512, Mode 49 must be ON to report on all the 256 LDEVs in each logical control unit.
<b>TC-Unique Features (specified through the Command View management station or SVP)</b>			
<b>RCU Options</b>			

**Table 117: GDPS-TC390-HXRC matrix (Continued)**

S/390 Feature	IBM 3990-6E	XP128/XP1024	XP48/XP512
Minimum paths	Not supported	Default = 1. If the minimum number of MCU-RCU active paths falls below this value, all pairs will be suspended based on the Fence Level option in effect.	Default = 1. If the minimum number of MCU-RCU active paths falls below this value, all pairs will be suspended based on the Fence Level option in effect.
PPRC support by host	Host must support PPRC	Default = YES - PPRC supported, optional capability to allow host support for non PPRC capable operating systems.	Default = YES - PPRC supported, optional capability to allow host support for non PPRC capable operating systems.
RCU-to-MCU SIM reporting	Not supported per the IBM document, <i>Planning for IBM Remote Copy</i> (SG24-2594-009 p.184)	To any host or only to RCU host	To any host or only to RCU host
RCU to MCU service SIM reporting	Not supported per the IBM document, <i>Planning for IBM Remote Copy</i> (SG24-2594-009 p.184)	Default = Not report; <a href="#">Table 118</a> on page 974 and <a href="#">Table 119</a> on page 975 list remote copy service SIMs. Designed for non-MVS operating systems that do not support SIM reporting.	Default = Not report; <a href="#">Table 118</a> on page 974 and <a href="#">Table 119</a> on page 975 list remote-copy service SIMs. Designed for non-MVS operating systems that do not support SIM reporting.
<b>Pair Options</b>			
Cache fast write data	Not supported	Optional to R-VOL, default = M-VOL	Optional to R-VOL, default = M-VOL
<b>Extended Remote Copy</b>	<b>XRC</b>	<b>HXRC*</b>	<b>HXRC</b>
SMS 1.3 - SDM ver. 1	Not supported	Not supported	Not supported
SMS 1.3 + PTFs - SDM ver. 2	Supported	Supported	Supported
SMS 1.4 – SDM ver. 2	Supported	Supported	Supported
SMS 1.4+ PTFs – SDM ver. 2	Supported	Supported	Supported

**Table 117: GDPS-TC390-HXRC matrix (Continued)**

S/390 Feature	IBM 3990-6E	XP128/XP1024	XP48/XP512
SMS 1.5 – SDM ver. 2	Supported	Not supported, in QA test	Not supported, in QA test
Max. sessions	4 per disk array	4 per CU image, 128 total	4 per CU image, 64 total
Max. volumes	256 per disk array	256 per CU image, 8,192 total	256 per CU image, 4,096 total
Utility volumes with Multi Reader Support #OW30183	Multiple supported	Multiple supported	Multiple supported
SIM/error messages	Per the IBM document	Per the IBM document	Per the IBM document
Primary disk array interface	Parallel or ESCON	ESCON only	ESCON only
Secondary disk array interface	Parallel or ESCON	Parallel or ESCON	Parallel or ESCON
Channel extender support	Yes	Contact your HP account team for the latest information.	Contact your HP account team for the latest information.
Maximum sidefile size	50%	50% available cache	50% available cache
Sidefile puncture %	60%	60%. Retries issued at 40% utilization, host interface blocked at 50% utilization.	60%. Retries issued at 40% utilization, host interface blocked at 50% utilization.

**Note:** For more information on HXRC device blocking and load balancing control, refer to [HXRC Device Blocking and Load Balancing](#) on page 1015.

## Pinned Track Recovery for TrueCopy Volumes

If a pinned track occurs on a TC390 M-VOL or R-VOL, the MCU will suspend the pair (SIM reference code = D41x, D42x, DB1x, DB2x). Use the following procedure to ensure full data integrity of the volume pair while recovering the pinned track:

1. Connect to the MCU of the suspended pair and select the correct CU image.
2. Delete the volume pair.
3. If the volume is offline (for example, R-VOL has pinned track), vary the volume online.
4. Perform your usual procedure for recovering data from a pinned track. Refer to the pinned track recovery procedures for your operating system. Contact HP technical support to inform them of the pinned track.
5. If the volume was previously offline (for example, R-VOL), make sure to vary the volume offline again.
6. Restart the volume pair using the Add Pair window, making sure to use the Entire initial copy option.

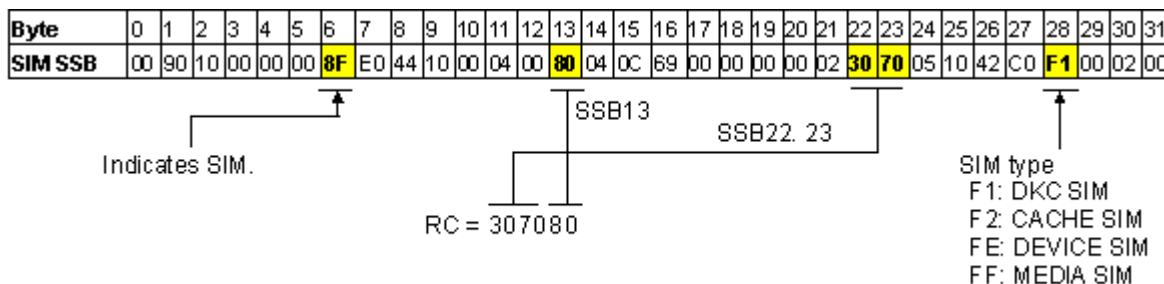


## SIM Reporting

The XP128/XP1024 reports a service information message (SIM) to the host when it is necessary to notify the user of a possible service requirement for the disk array. The SIMs are classified according to severity for reporting and logging purposes: service, moderate, serious, or acute. The SVP reports all SIMs related to TC390 operations and all SIMs are stored on the SVP for use by HP personnel. The SIMs reported to the S/390 host are logged in the SYS1.LOGREC dataset of the host operating system. Each time a SIM is generated, the amber **Message** LED on the XP128/XP1024 control window (under the **Ready** and **Alarm** LEDs) turns on as an additional alert for the user. The XP128/XP1024 also reports SIMs to the Command View management station to provide an additional source of notification for the user.

During TC390 operations, the MCU and RCU will generate a service SIM each time the pair status of the M-VOL or R-VOL changes for any reason, including normal status transitions (for example, *pending duplex* to *duplex*). For TC390A transition states (*suspending* and *deleting*), a SIM is generated when the status changes to the transition state and again when the transition is complete. SIMs generated by the MCU will include the M-VOL device ID (byte 13) and SIMs generated by the RCU will include the R-VOL device ID (byte 13). Use the RCU Option window (see [Registering an RCU \(Add RCU\)](#) on page 830) to configure each MCU to report or not report service-level SIMs to the attached host(s).

The following figure shows a typical 32-byte SIM from the XP128/XP1024. SIMs are displayed on the host console by reference code (RC) and severity. The six-digit RC (composed of bytes 22, 23, and 13) identifies the possible error and determines the severity. The SIM type (byte 28) indicates the component that experienced the error. When byte 22 = 21, the SIM is a control unit SIM. When byte 22 = Dx, the SIM is a device SIM. When byte 22 = (D5-D7, DB), the specified pair is TC390A. When byte 22 = (D8 - DC), the pair is TC390 Synchronous. The SIM reference codes DB6x, DB7x, and DB8x indicate a TC390A pair suspended by the RCU.



**Figure 358: Typical XP128/XP1024 SIM showing reference code and SIM type**

The following table lists and describes the control unit SIMs (byte 28 = F1) related to TC390 operations. [Table 119](#) on page 975 lists and describes the device SIMs (byte 28 = FE) related to TC390 operations. Both of these tables also specify the severity, host reporting, and SVP log file for each SIM.

**Note:** The SIM information for the XP128/XP1024 changes as new features and functions are added and supported. Contact your HP account team or HP technical support for the latest SIM information for the XP128/XP1024.

**Table 118: TrueCopy control unit SIMs**

Ref. Code		Severity	Description	Reported to Host	SVP Log File
22	23				
21	80	Moderate	The logical path(s) on the remote copy connection(s) was logically blocked due to an error condition.	Yes Repeat	SIM Log
21	81	Service	The logical path on the remote copy connection has recovered from the blocked condition.	Yes* Once	SSB Log
21	82	Moderate	MCU received notification of an error detection for communication line from the extender.	Yes Repeat	SIM Log

This SIM is not reported to the host system when the **Service SIM=Not Report** RCU option is selected.

Table 119: TrueCopy device SIMs

Ref. Code		Severity	Description	Reported to Host	Generated by	Log File
22	23					
D0	0x	Service	TC390 started the initial copy for this volume, or was out of sync for this volume.	Yes <sup>1</sup> Once	MCU	SSB Log
D0 D8	1x	Service	TC390 completed the initial copy for this volume.	Yes <sup>1</sup> Once	MCU	SSB Log
D0	2x	Service	TC390 for this volume was deleted as requested by the Command View management station, SVP, or host.	Yes <sup>1</sup> Once	MCU	SSB Log
D0	3x	Service	The MCU changed the volume pair status as requested by the Command View management station, SVP, or host.	Yes <sup>1</sup> Once	MCU	SSB Log
D1	sx	Service	Status of the R-VOL has changed as requested by the MCU. The third digit of the reference code "s" indicates change of states as follows: 0: from simplex to pending 1: from simplex to duplex 2: from pending to duplex 3: from pending to suspended 4: from duplex to suspended 5: from duplex to simplex 6: from pending to simplex 7: from suspended to simplex 8: from suspended to pending.	Yes <sup>1</sup> Once	RCU	SSB Log
D2	0x	Service	The RCU changed the R-VOL status to <i>suspended</i> as requested by Command View management station, SVP, or host.	No	RCU	SSB Log
D2	1x	Service	The R-VOL status changed from <i>suspended</i> to <i>simplex</i> as requested by Command View management station, SVP, or host.	No	RCU	SSB Log
D2	2x	Service	The R-VOL status has changed from <i>duplex</i> to <i>simplex</i> .	No	RCU	SSB Log

**Table 119: TrueCopy device SIMs (Continued)**

Ref. Code		Severity	Description	Reported to Host	Generated by	Log File
22	23					
D2	3x	Service	The TC390 R-VOL status has changed from <i>pending duplex</i> to <i>simplex</i> .	No	RCU	SSB Log
D4	0x	Serious	TC390 for this volume was suspended due to a failure on the remote copy connection.	Yes <sup>2</sup> Repeat	MCU	SIM Log
D4	1x	Serious	TC390 for this volume was suspended due to a failure on the M-VOL or remote copy.	Yes <sup>2</sup> Repeat	MCU	SIM Log
D4	2x	Serious	TC390 for this volume was suspended due to a failure on the R-VOL.	Yes <sup>2</sup> Repeat	MCU	SIM Log
D4	3x	Serious	TC390 for this volume was suspended because DFW to the R-VOL was blocked.	Yes <sup>2</sup> Repeat	MCU	SIM Log
D4	4x	Serious	TC390 for this volume was suspended due to an internal error condition detected by the RCU.	Yes <sup>2</sup> Repeat	MCU	SIM Log
D4	5x	Serious	TC390 for this volume was suspended because the operator deleted the volume pair from the RCU.	Yes <sup>2</sup> Repeat	MCU	SIM Log
D4	Cx	Service	The MCU detected a service-level SIM at the RCU.	Yes <sup>1</sup> Once	RCU	SSB Log
D4	Dx	Moderate	The MCU detected a moderate-level SIM at the RCU.	Yes <sup>1</sup> Repeat	RCU	SIM Log
D4	Ex	Serious	The MCU detected an acute- or serious-level SIM at the RCU.	Yes <sup>1</sup> Repeat	RCU	SIM Log
D4	Fx	Serious	The status of the M-VOL is not consistent with the status of the R-VOL.	Yes <sup>2</sup> Repeat	MCU	SIM Log
D5	0x	Service	TC390 started the initial copy for this volume, or was out of sync for this volume.	Yes <sup>1</sup> Once	MCU	SSB Log
D5	1x	Service	TC390 completed the initial copy for this volume.	Yes <sup>1</sup> Once	MCU	SSB Log
D5	2x	Service	The volume pair accepted Delete Pair operation.	Yes <sup>1</sup> Once	MCU	SSB Log

Table 119: TrueCopy device SIMs (Continued)

Ref. Code		Severity	Description	Reported to Host	Generated by	Log File
22	23					
D5	3x	Service	The volume pair accepted Suspend Pair operation.	Yes <sup>1</sup> Once	MCU	SSB Log
D5	4x	Service	Delete Pair operation for this volume pair has completed.	Yes <sup>1</sup> Once	MCU	SSB Log
D5	5x	Service	Suspend Pair operation for this volume pair has completed	Yes <sup>1</sup> Once	MCU	SSB Log
D6	sx	Service	The R-VOL status has changed as requested by the MCU. The third digit of the reference code "s" indicates change of states as follows: 0: from simplex to pending 1: from simplex to duplex 2: from pending to duplex 3: from pending to suspended 4: from duplex to suspended 5: from duplex to simplex 6: from pending to simplex 7: from suspended to simplex 8: from suspended to pending	Yes <sup>1</sup> Once	RCU	SSB Log
D7	sx	Service	The R-VOL has accepted/completed state change as requested by operation. The third digit of the reference code "s" indicates the events as follows: 0: Accepted Suspend Pair operation. 1: Accepted Delete Pair operation. R-VOL is suspended. 2: Accepted Delete Pair operation. R-VOL is duplex. 3: Accepted Delete Pair operation. R-VOL is pending. 4: Completed Suspend Pair operation. 5: Completed Delete Pair operation.	No	RCU	SSB Log

**Table 119: TrueCopy device SIMs (Continued)**

Ref. Code		Severity	Description	Reported to Host	Generated by	Log File
22	23					
DB	0x	Serious	The volume pair was suspended due to a failure on the remote copy connections.	Yes <sup>2</sup> Repeat	MCU	SIM log
DB	1x	Serious	The volume pair was suspended due to a failure on the M-VOL or remote copy.	Yes <sup>2</sup> Repeat	MCU	SIM log
DB	2x	Serious	The volume pair was suspended due to a failure on the R-VOL.	Yes <sup>2</sup> Repeat	MCU	SIM log
DB	3x	Serious	The volume pair was suspended because DFW to the R-VOL was blocked.	Yes <sup>2</sup> Repeat	MCU	SIM log
DB	4x	Serious	The M-VOL has changed to suspended state due to an internal error condition detected by the RCU.	Yes <sup>2</sup> Repeat	MCU	SIM log
DB	5x	Serious	The M-VOL has changed to suspended state because the operator deleted the volume pair from the RCU.	Yes <sup>2</sup> Repeat	MCU	SIM log
DB	6x	Serious	The RCU has suspended all R-VOLs in the consistency group due to time out failure defined by the maximum copy delay time.	Yes <sup>2</sup> Repeat	RCU	SIM log
DB	7x	Serious	The RCU has suspended all R-VOLs in the consistency group due to the internal logic error.	Yes <sup>2</sup> Repeat	RCU	SIM log
DB	8x	Service	The R-VOL was suspended due to MCU power-off event.	Yes <sup>1</sup> Once	RCU	SSB Log
DB	Fx	Serious	The status of the M-VOL is not consistent with the status of the R-VOL.	Yes <sup>2</sup> Repeat	MCU	SIM log

1. These SIMs are reported to the host only if the Service SIM=Report and PPRC Support=No RCU options are both selected.
2. These SIMs are reported to the host system only if the PPRC Support=No RCU option is selected.

# TrueCopy Scripting

## Overview of Scripting

An added benefit of the TC390 feature is its support for scripting operations. This capability provides the user with additional flexibility in managing their TC390 environment. A TC390 script file contains a list of macros (commands) that describes a series of TC390 pair operations. The TC390 scripting macros are defined in a text file, and Command View reads the text file and executes the specified TC390 pair operations.

---

**Note:** This section assumes that the user is familiar with batch files and does not provide instructions for writing or editing batch files. The macro commands and parameters listed in this section are the only commands recognized by the TC390 scripting function.

---



**Caution:** The user is responsible for testing the TC390 scripting function before running any TC390 scripts. If a TC390 script is run without prior testing and the script ends abnormally, data loss could occur. Before testing a TC390 script, back up the data and vary the volumes offline. If the volumes must remain online, back up the data and confirm that the target volume pair defined in the TC390 script is correct. The results of a TC390 script can be confirmed by checking the latest TC390 pair status update (**Last Updated** field on TC390 Pair Status window).

---

[Table 120](#) on page 980 lists the TC390 pair macro commands. [Table 121](#) on page 981 lists the internal macro commands for TC390 scripting. The following TC390 operations cannot be performed using TC390 scripting:

- Configure serial/fibre ports ([Configuring the Host Interface Ports](#) on page 824).
- Monitor remote copy activity ([Usage Monitor Screen](#) on page 814).
- Clear remote copy SIMs ([Other Operations](#) on page 867).
- Add/delete RCU ([Registering an RCU \(Add RCU\)](#) on page 830 and [Deleting an RCU \(Delete RCU\)](#) on page 842).
- Change RCU options ([Modifying RCU Options \(Change RCU Option\)](#) on page 838).

- Add/delete path/SSID ([Adding and Deleting Logical Paths for an RCU \(Add Path and Delete Path\)](#) on page 843 and [Adding and Deleting SSIDs for an RCU \(Add SSID and Delete SSID\)](#) on page 847).
- View RCU status ([Viewing RCU Status \(RCU Status\)](#) on page 826).
- Change async options ([Asynchronous Copy Option](#) on page 859).
- Add/delete group ([Adding Consistency Groups \(Add CT Group\)](#) on page 854 and [Deleting Consistency Groups \(Delete CT Group\)](#) on page 858).
- Change group options ([Modifying Consistency Group Options \(CT Group Option\)](#) on page 856).
- View group status ([Viewing Consistency Group Status \(CT Group Status\)](#) on page 852).

---

**Note:** The scripting command names did not change between CA and TC390. Your existing CA scripting files can be used for TC390 operations.

---

**Table 120: Functional macro commands for TrueCopy scripting**

TC390 Scripting Macro	Description
CreateHrcPair	Registers a TC390 pair or pairs. (StartHrcPair is used to start the initial copy operation.)
SuspendHrcPair	Suspends a TC390 pair or pairs.
DeleteHrcPair	Deletes a TC390 pair or TC390 pairs.
ResumeHrcPair	Resumes a TC390 pair or TC390 pairs. Use with StartHrcPair.
ChangeHrcOption	Changes the pair options for a TC390 pair or TC390 pairs.
StartHrcPair	Starts remote copy operations for the new pairs and/or resumed pairs specified in the preceding scripting commands.
GetHrcStatus	Displays the status of a TC390 pair or TC390 pairs.
SelectHrcDevice	Searches TC390 paired devices.



**Table 121: Internal macro commands for TrueCopy scripting**

Type	Macro	Description
For lists	SetList	Set (define) a list of items.
	AddList	Add items to a list.
For non-lists	Start	Declares the beginning of a script.
	End	Declares the end of a script.
	Delay	Suspends script execution for the specified length of time.
	If	Executes a script conditionally.
	EndIf	Terminates a script conditionally.
	MakeString	Makes strings; converts numeric value to character string.

## Syntax for Scripting

### Syntax Overview

A TC390 script file can be written using any text editor (for example, WordPad or Notepad). A script file consists of an unlimited number of statements that consist of macros (commands), work variables, and comments (see [Operation Macro Commands](#) on page 984 and [Internal Macro Commands](#) on page 995). The first executable statement in a TC390 script file must be the Start macro and the last statement must be the End macro. Each line in a TC390 script file cannot exceed 320 bytes. A leading blank is ignored and a leading tab character (0x09) is converted to a space (0x20). A tab character (0x09) within a string is not converted to a space.

Each script file should contain all five script statements (see [Table 122](#) on page 982 and [Table 123](#) on page 982):

- A comment statement, including a short preface for the script: purpose, author, usage, description, operation, creation date, update date, and any reminder notes to the author. The comment statement is a non-execution statement. A comment statement begins with “//” and contains text (any character string) without any commands. Do not use the “//” symbol anywhere else in a script file, only at the beginning of a comment statement.
- A macro statement (see [Operation Macro Commands](#) on page 984 and [Internal Macro Commands](#) on page 995). The macro statement is an execution statement. Only one macro instruction can be set per line and a macro can span more than one line.

- A work variable statement (see [Work Variables](#) on page 999). The work variable statement is also an execution statement. Only one work variable statement can be set per line and a work variable statement cannot span more than one line.
- A blank statement (see the following table). The blank statement is a non-execution statement.
- An empty statement (see the following table). The empty statement is a non-execution statement.

**Table 122: Syntax description**

Statement Name	Description
Blank statement	Space or Tab with a return
Comment statement	One line beginning with //
Empty statement	Return only
Execution statement	Work variable statement (non-list type work variable = constant)
Macro statement	Macro name [parameter list] Refer to <a href="#">Operation Macro Commands</a> on page 984 and <a href="#">Internal Macro Commands</a> on page 995 for macro information.

**Table 123: Script components**

Component Name	Description
Macro name	Either an internal macro or a functional macro.
Parameter list	Parameter identification name (defined in each macro format) = non-list type expression.
Expression	List, constant, and work variable.
List	In a list description, a constant is enclosed in braces "{}". A comma "," is inserted between constants. Example: {1, 2, 3, 4}, or {"ABC", "qtw"}. Lists and work variables cannot be described in a list.

**Table 123: Script components (Continued)**

Component Name	Description
Constant	String or a numeric value.
String	The string covers the following lists. Enclose a list with a double-quotation mark (""). Letters (uppercase and lowercase), numbers, symbols. <ul style="list-style-type: none"> <li>■ Numeric list: List that consists of (0, 1, 2, 3, 4, 5, 6, 7, 8, 9)</li> <li>■ Hexadecimal number list: List that begins with 0x/OX of (A, B, C, D, E, F, a, b, c, d, e, f)</li> </ul>
Reserved variables	Reserved variables can be referenced in a script only. Setting a value is not possible.

## Script File Requirements

The following table lists the requirements for the components of a script file.

**Table 124: Script file requirements**

Item	Requirement
Maximum length of one line of a script	320 bytes
Maximum number of items of one list type identification name	1,024
Maximum length of one item of a list type work variable string	16 bytes
Maximum length of one item of a non-list type string	150 bytes
Maximum number of items of macro trace storage	1,000
Maximum number of items of error trace	1,000

## Script Symbols

Symbols can be used in a script to enhance or limit the power of each script command. The following table lists and describes the symbols that can be used in a script.

**Table 125: Script symbols**

Symbol <sup>1</sup>	Use
Quotation mark	Used to define the character constant by enclosing with it quotation marks.
Space	Used to delimit the before and after phrases.
Comma	Used to delimit the before and after phrases. This symbol must be placed by following each macro description rule.

**Table 125: Script symbols (Continued)**

Symbol <sup>1</sup>	Use
Brace	Used to describe a list.
Parenthesis	Only used to describe a condition in the If statement.
Exclamation mark	Used as an operator in the If statement by placing the equal sign next to it. This symbol is not useful when used alone.
Unequal sign	Used as an operator in the If statement when used alone. When the equal sign follows, nothing changes.
Equal sign	Used as a substitute sign when used alone. When the equal sign follows, it becomes an operator in the If statement.

1. The before and after phrases are split by the above symbols. Each symbol is recognized as a single word.

## Operation Macro Commands

The functional macros are the script equivalents of the following TC390 pair operations:

- Create pairs (see page 984)
- Delete pairs (see page 987)
- Suspend pairs (see page 989)
- Resume pairs (see page 990)
- Change pair options (see page 991)
- Start pairs (see page 992)
- Get pair status (see page 993)
- Select pair devices (see page 993)

### Create Pairs

Use the CreateHrcPair command to establish new TC390 volume pairs.

---

**Note:** The CreateHrcPair command only creates the pair. You must run the StartHrcPair command after establishing the pair to start the remote copy process.

---

The CreateHrcPair parameters are:

- M-VOL device list (numeric): C x 0x100 + VV, where C=CU#, VV=vol# within CU.
- Serial number list (string): RCU serial number (serial number is five digits decimal 0-9). Do not specify more than 12 RCUs.
- SSID number list (numeric): RCU SSID (four digits hexadecimal 0-F).
- R-VOL device list (numeric): C x 0x100 + VV, where C=CU#, VV=vol# within CU.
- Initial copy pace list (string): “CP\_MIDDLE” (0x01) = 3 tracks; “CP\_FAST” (0x02) = 15 tracks; default = CP\_FAST.
- Initial copy mode list (string): “E” (0x00) = entire; “N” (0x01) = none; default = E.
- Sync level list (string): “S0” or “Synchronous0” (0x00) = sync, “S2” or “Synchronous2” (0x02) = async; default = S0. S0 and S2 cannot be specified at the same time.
- CT group list (numeric): consistency group number (0x00 - 0x7F). For async pairs you must specify this parameter. For sync pairs you must omit this parameter.
- Priority list (numeric): priority of initial copy operation (1-256); default = 32.
- Fence level list (string): “N” or “Never” = (0x00); “S” or “Status” = (0x02); “D” or “Data” = (0x01); default = “Never”. For async pairs you must either specify N (never) or omit this parameter.
- CFW flag list (numeric): 0 = copy CFW data to R-VOL; 1 = only M-VOL; default = 1.
- DFW flag list (numeric): 0 = DFW not required; 1 = DFW required; default = 0. Must be omitted for async pairs.
- Error level list (string): “G” (0x00) = group; “V” (0x01) = volume; default = G. For sync pairs you must omit this parameter.
- Time-Saving Mode flag: “Yes” = The **Use Time-Saving Mode** option is enabled; “No” = The **Use Time-Saving Mode** option is disabled; default = “Yes”. This parameter is a non-list type and only one value can be specified.
- Differential management measurement flag list (string): The differential between the volumes is managed in Cylinder (“Cylinder” or “C”) or in Track (“Track” or “T”). When “Auto” or “A” is specified, the disk array selects the differential management measurement (cylinder or track) automatically. The default is Auto. If the disk array does not support the “Auto” option, “Track” is specified as the default.

The following CreateHrcPair command output shows an example of the pair macro commands needed to create the specified pairs with the parameters listed in the following table.



**Caution:** When using the CreateHrcPair command to create more than one pair, make sure to keep each line within the maximum line length (320 bytes). For script command restrictions and parameters, refer to [Script File Requirements](#) on page 983.

**Table 126: Example of CreateHrcPair parameters**

Parameter	Value	Parameter	Value
M-VOL	_ilDevA	CT group	[omit – N/A]
Serial number (RCU)	_slWorkA	Priority	_ilWorkA
SSID (RCU)	11	Fence level	Never
R-VOL	_ilDevB	CFW flag	0
Initial copy pace	_slWorkB	DFW flag	1
Initial copy mode	E	Error level	[omit – N/A]
Sync level	S0, S0, S0	Time-Saving Mode	[omit – default]

**Example: CreateHrcPair Command**

```

Start $Script="HRC",$Svr="CU-Name"

// $Dev
SetList $D =_ilDevA, $S = {0x0100,0x0101,0x0102,0x0103,0x0104,0x0105,0x0106,0x0107}
AddList $D =_ilDevA, $S = {0x0108,0x0109,0x010A,0x010B,0x010C,0x010D,0x010E,0x010F}
// $Rdev
SetList $D =_ilDevB, $S = {0x1F00,0x1F01,0x1F02,0x1F03,0x1F04,0x1F05,0x1F06,0x1F07}
AddList $D =_ilDevB, $S = {0x1F08,0x1F09,0x1F0A,0x1F0B,0x1F0C,0x1F0D,0x1F0E,0x1F0F}
// $Priority
SetList $D =_ilWorkA, $S = {1,2,3,4,16.32}
// $Fence
SetList $D =_slWorkB, $S = {"D","S","S","N"}

CreateHrcPair $Dev =_ilDevA, $RcuSn = "12345", $RcuSsid = 4, $Rdev =_ilDevB, $Priority
= _ilWorkA, $Fence = _slWorkB
StartHrcPair

// $Dev
SetList $D =_ilDevA, $S = {0x0B80,0x0B81,0x0B82}
AddList $D =_ilDevA, $S = {0x0C2A,0x0C2B,0x0C2C}
// $Rdev
SetList $D =_ilDevB, $S = {0x1045,0x1047,0x105E}
AddList $D =_ilDevB, $S = {0x1130,0x1139,0x113D}
// $RcuSn
SetList $D =_slWorkD, $S = {"32072","32072","32072","28439","28439","28439"}
// $RcuSsid
SetList $D =_ilWorkC, $S = {33,33,33,0xA74C,0xA74C,0xA74C}
// $CTG
SetList $D =_ilWorkB, $S = {0x7F,0x7F,0x7F,10,10,10}

CreateHrcPair $Dev =_ilDevA, $RcuSn =_slWorkD, $RcuSsid =_ilWorkC, $Rdev =_ilDevB,
$Sync = "S2", $CTG =_ilWorkB
StartHrcPair

End

```

**Delete Pairs**

The DeleteHrcPair command deletes TC390 pairs. The DeleteHrcPair parameters include:

- Device list (numeric): C x 0x100 + VV, where C=CU#, VV=vol# within the CU.
- Delete mode list (numeric): 0 (0x00) = normal, 1 (0x01) = delete by force; default = 0. You must specify 0 (normal) when deleting two or more async pairs.

- Delete range list (string): “G” or “Group” = group; “V” or “Volume” = volume; “C” or “C/T” = consistency time. For sync pairs you must omit this parameter.
  - When two or more volumes are specified, the default = V. If you want to delete two or more specific async pairs, you can specify V or omit this parameter.
  - When one volume is specified, the default = G under these conditions:  
Volume is an M-VOL and delete mode = 0 (normal) (any pair status); or  
Volume is an R-VOL, delete mode = 0, and pair status = suspending or deleting.  
If you want to delete an entire group by force (delete mode = 1), you must specify G.
  - When one volume is specified, the default = C/T under these conditions:  
Volume is an R-VOL, delete mode = 0, and pair status is not suspending or deleting.
- Time-Saving Mode flag: “Yes” = The **Use Time-Saving Mode** option is enabled; “No” = The **Use Time-Saving Mode** option is disabled; default = “Yes”. This parameter is a non-list type and only one value can be specified.

The following provides an example of the pair macro commands needed to delete the specified pair with delete mode = normal.

*Example:* DeleteHrcPair Command

```

Start $Script="HRC",$Svr="CU-Name"

// $Dev
SetList $D =_ilDevA, $S = {0x0800,0x0901,0x0A02}
AddList $D =_ilDevA, $S = {0x0B03,0x0C04,0x0D05,0x0E06}

// $DelMode
SetList $D = _ilWorkA, $S = {0, 1, 0}

DeleteHrcPair $Dev = _ilDevA, $DelMode = _ilWorkA

DeleteHrcPair $Dev = 0x124C, $DelRange = "Group"

End

```



## Suspend Pairs

The SuspendHrcPair command suspends TC390 pairs. The SuspendHrcPair parameters include:

- Device list (numeric): C x 0x100 + VV, where C=CU#, VV=vol# within the CU.
- Suspend mode list (string): “M” or “M-Vol” (0x00) = M-VOL failure, “R” or “R-Vol” (0x01) = R-VOL; default = R-VOL. You must specify R or omit this parameter when suspending async pairs.
- Flag list (numeric): suspend report flag: 0 = reports; 1 = no reports; default = 1.
  - When one volume is specified, the default = G. If you want to suspend only one async pair, you must specify V.
  - When two or more volumes are specified, the default = V. When two or more volumes are specified, you must either specify V or omit this parameter.
- Pending data flag list (string): “D” or “Drain” (0x00) = drain; “P” or “Purge” (0x08) = purge; default = D. For sync pairs you must omit this parameter.
- Time-Saving Mode flag: “Yes” = The **Use Time-Saving Mode** option is enabled; “No” = The **Use Time-Saving Mode** option is disabled; default = “Yes”. This parameter is a non-list type and only one value can be specified.

The following provides an example of the pair macro commands needed to suspend the specified pair with suspend mode = R-VOL and the default flag of no reports.

**Example: SuspendHrcPair Command**

```

Start $Script="HRC",$Svr="CU-Name"

// $Dev
SetList $D = _ilDevA, $S = {0x0100,0x0101,0x0102,0x0103}
AddList $D = _ilDevA, $S = {0x0104,0x0105,0x0106,0x0107,0x0108}
// $SusReport
SetList $D = _slWorkA, $S = {0, 1, 0}
// $SusMode
SetList $D = _slWorkA, $S = {"R-Vol", "M", "R", "M-Vol"}

SuspendHrcPair $Dev = _ilDevA, $SusMode = _slWorkA, $SusReport = _ilWorkA

// $Dev
SetList $D = _ilDevB, $S = {0x0900,0x0901,0x0902,0x0903}
// $PendData
SetList $D = _slWorkC, $S = {"Drain", "Purge", "P", "D"}

SuspendHrcPair $Dev = _ilDevB, $PendData = _slWorkC, $SusRange = "Volume"

End

```

**Resume Pairs**

The ResumeHrcPair command resumes TC390 pairs. The ResumeHrcPair parameters include:

- M-VOL device list (numeric): C x 0x100 + VV, where C=CU#, VV=vol# within CU.
- Priority list (numeric): priority of initial copy operation (numeric 0-256); default = 32.
- Fence level list (string): “N” or “Never” (0x00) = never; “S” or “Status” (0x02) = status; “D” or “Data” (0x01) = data; default = current value. For async pairs you must either specify N (never) or omit this parameter.
- Sync level list (string): “S0” or “Synchronous0” (0x00) = sync, “S2” or “Synchronous2” (0x02) = async; default = current value.
- Error level list (string): “G” or “Group” (0x00) = group; “V” or “Volume” (0x01) = volume; default = current value. For sync pairs you must omit this parameter.
- Resume range list (string): “G” (0x00) = group; “V” (0x01) = volume. For sync pairs you must omit this parameter.
  - When one volume is specified, the default = G. If you want to resume only one async pair, you must specify V.

— When two or more volumes are specified, the default = V. When two or more volumes are specified, you must either specify V or omit this parameter.

- Time-Saving Mode flag: “Yes” = The **Use Time-Saving Mode** option is enabled; “No” = The **Use Time-Saving Mode** option is disabled; default = “Yes”. This parameter is a non-list type and only one value can be specified.

The following provides an example of the pair macro commands needed to resume the specified pair in synchronous mode with fence level = never and priority = 1.

---

**Note:** After resuming pairs, you must run the StartHrcPair command to begin remote copy activity

---

*Example:* ResumeHrcPair Command

```

Start $Script="HRC",$Svr="CU-Name"

// $Dev
SetList $D =_ilDevA, $S = {0x0100,0x0101,0x0102,259}
// $Priority
SetList $D =_ilWorkC, $S = {24,32,0x13,8}

ResumeHrcPair $Dev = _ilDevA, $Priority = _ilWorkC
StartHrcPair

// $Dev
SetList $D =_ilDevB, $S = {0x0200,0x0201,0x0202,0x0203}
AddList $D =_ilDevB, $S = {0x0904,0x0905,0x0906,0x0907}

ResumeHrcPair $Dev = _ilDevB, $OptRsmRange = "Volume"
StartHrcPair

End

```

## Change Pair Options

Use the ChangeHrcOption command to change the pair options for TC390 pairs. The ChangeHrcOption parameters include:

- M-VOL device list (numeric): C x 0x100 + VV, where C=CU#, VV=vol# within CU.

- Fence level list (string): “N” or “Never” (0x00) = never, “S” or “Status” (0x02) = status; “D” or “Data” (0x01) = data; default = current value. For async pairs you must either specify N or omit this parameter.
- CFW flag list (numeric): 0 = copy CFW data to R-VOL; 1 = only M-VOL; default = current value.
- DFW flag list (numeric): DFW flag list is only left to maintain the compatibility of the format. The specification is not available.
- Error level list (string): “G” (0x00) = group; “V” (0x01) = volume; default = current value. For sync pairs you must omit this parameter.
- Time-Saving Mode flag: “Yes” = The **Use Time-Saving Mode** option is enabled; “No” = The **Use Time-Saving Mode** option is disabled; default = “Yes”. This parameter is a non-list type and only one value can be specified.

The following provides an example of the pair macro commands needed to change the pair options for the pair with LDEV ID 0x4a as follows: set fence level option to **Never** and set CFW option to M-VOL only.

*Example:* ChangeHrcOption Command

```

Start $Script="HRC",$Svr="CU-Name"

// $Dev
SetList $D = _ilDevA, $S = {0x0100,0x0101,0x0102,0x0103,0x0104}
AddList $D = _ilDevA, $S = {0x0117,0x0118,0x0119}
// $OptCfw
SetList $D = _slWorkA, $S = {1, 1, 0}
// $Fence
SetList $D = _slWorkA, $S = {"D", "S", "N", "Data", "Status"}

ChangeHrcOption $Dev = _ilDevA, $Fence = _slWorkA, $OptCfw = _ilWorkA

// $Dev
SetList $D = _ilDevB, $S = {0x0A00,0x0A01,0x0A02,0x0A03,0x0A04}
// $OptErrLv
SetList $D = _slWorkB, $S = {"G", "V", "Volume", "Group"}

ChangeHrcOption $Dev = _ilDevB, $OptErrLv = _slWorkB

End

```

## Starting a Pair

The StartHrcPair command starts the remote copy process for all new and resumed TC390 pairs (CreateHrcPair and ResumeHrcPair commands). The StartHrcPair command does not have any arguments or parameters. After you

have created and/or resumed all needed TC390 pairs, add the StartHrcPair command to the script to begin remote copy activity for all preceding new and resumed pairs. The following provides an example of the StartHrcPair command as it is displayed within a script file.

*Example:* StartHrcPair Command

```
:
:
StartHrcPair
```

## Getting Pair Status

The GetHrcStatus macro command obtains the status of a specific TC390 pair. The GetHrcStatus argument is:

- Device (numeric constant, non-list-type and numeric-type work variable):  
VOL = C x 0x100 + VV, where C=CU#, VV=vol# within the CU.

The GetHrcStatus command obtains the status of the pair from the XP128/XP1024 and displays the status as a reserved variable “\_HrcStatus” (see [Table 134](#) on page 1002). The following provides an example of the GetHrcStatus command for the pair with LDEV ID 0x4a.

*Example:* GetHrcStatus Command

```
GetHrcStatus $Dev=0x4a
_sMsgB=_HrcStatus_Fence
_sMsgC=_HrcStatus_Sync
_sMsgD=_HrcStatus_Sn
_iNumB=_HrcStatus_Ssid
_iNumC=_HrcStatus_DeviceR
```

## Selecting Devices

The SelectHrcDevice command searches for TC390 pairs whose status matches the specified parameters. The SelectHrcDevice argument is:

- Output list (list-type and numeric work variable)

The SelectHrcDevice parameters include:

- Device list (numeric): list of devices to be searched: C x 0x100 + VV, where C=CU#, VV=vol# within CU. Default = all possible target devices that can be specified. The maximum number of the device is 1,024. When you search for more than 1,024 devices, use this command for several times.
- Serial number list (string): RCU serial number. Default = not specific.
- SSID number list (numeric): RCU SSID. Default = not specific.

- Fence level list (string): “N” or “Never” (0x00) = never; “S” or “Status” (0x02) = status; “D” or “Data” (0x01) = data. Default = not specific.
- Sync level list (string): “S0” or “Synchronous0” (0x00) = sync, “S2” or “Synchronous2” (0x02) = async. Default = not specific.
- Pair status list (string): “Simplex”, “Pending”, “Duplex”, “Suspended0” (suspended during initial copy), “Suspended1” (suspended after initial copy), “Suspended” (all suspend types), “Suspending”, “Deleting”, “Undefined”. Default = not specific.
- Device attribute list (string): “M” or “M-Vol”, “R” or “R-Vol”. Default = not specific.
- Error level list (string): “G” or “Group”; “V” or “Volume”. Default = not specific.
- CT group list (numeric): consistency group number (0x00 - 0x7F). Default = not specific.
- SEQCHK flag list (string): “Yes” = SEQCHK on; “No” = SEQCHK off. Default = not specific.

The following SelectHrcDevice command output provides an example of the SelectHrcDevice command to find the pairs with the parameters listed in the following table.

**Table 127: Select device parameters**

Parameter	Value
Output list	_ilDevA
Device list	_ilDevB
RCU serial number	_slWorkA
RCU SSID	_ilWorkA
Fence level	N
Copy mode	S0, S0, S0
Pair status	Suspended0
Device attribute	M

**Example: SelectHrcDevice Command**

```

Start $Script="HRC",$Svr="CU-Name"

// $Dev
SetList $D = _ilDevB, $S = {0x0F00,0x0F01,0x0F02,0x0F03,0x0F04,0x0F05,0x0F06,0x0F07}
AddList $D = _ilDevB, $S = {0x0F10,0x0F11,0x0F12,0x0F13,0x0F14,0x0F15,0x0F16,0x0F17}
AddList $D = _ilDevB, $S = {0x0F20,0x0F21,0x0F22,0x0F23,0x0F24,0x0F25,0x0F26,0x0F27}
AddList $D = _ilDevB, $S = {0x0F30,0x0F31,0x0F32,0x0F33,0x0F34,0x0F35,0x0F36,0x0F37}
AddList $D = _ilDevB, $S = {0x0F40,0x0F41,0x0F42,0x0F43,0x0F44,0x0F45,0x0F46,0x0F47}
AddList $D = _ilDevB, $S = {0x0F50,0x0F51,0x0F52,0x0F53,0x0F54,0x0F55,0x0F56,0x0F57}

SelectHrcDevice $DevList = _ilDevA, $Dev = _ilDevB, $Sync = "Synchronous2", $PairStatus
= "Suspend"

DeleteHrcPair $Dev = _ilDevA

End

```

**Internal Macro Commands**

The internal macro commands are the connection agents that connects the functional macros together and produces a complete and functioning script. The internal macros are divided into two groups as shown in the following table: list types and non-list types.

**Table 128: Internal macro commands**

Type	Macro	Description
For lists	SetList	Set (define) a list of items.
	AddList	Add items to a list.
For non-lists	Start	Declares the beginning of a script.
	End	Declares the end of a script.
	Delay	Suspends script execution for the specified length of time.
	If	Executes a script conditionally.
	EndIf	Terminates a script conditionally.
	MakeString	Makes strings; converts numeric value to character string.

The **Start** and **End** commands are used together to begin and end the functions of a script. Every script must have a **Start** and **End** command. The **If/EndIf** commands are also used concurrently to string two or more functional commands together. The **If/EndIf** commands must be used together. For every **If** command in a script there must be an **EndIf** command. Use the **Delay** command to delay a

script for up to an hour. Use the **MakeString** command to assign several values to a string statement. The **MakeString** command can convert numeric values to sting values. The **SetList** command creates a list (for example, all the searchable ports in the XP128/XP1024, all the searchable LDEVs in the XP128/XP1024) and the **AddList** command expands the parameters of a list created with the **SetList** command.

## Internal Macro Command Definitions

*AddList* The **AddList** command adds a specified value to a specific list type. If you add a value to a list that exceeds the maximum number of items for that output list, the excess values will be ignored. The format for the **AddList** command is: **AddList \$D=** the output list to which you want to add a value, **,\$S=** the expressions or values to be added to the output list with a numeric range of 0x0000 to 0xffff. For example, to add these values (0, 1, 2, 3, 0x1e, and 0x1f) to the Dev (Device) B list, the **AddList** command would be:

```
AddList $D=_ilDevB
,$S={0,1,2,3,0x1e,0x1f}
```

*Delay* Use the **Delay** command to delay a script for a specified length of time. The script delay time is set in seconds (0 - 3600). The format for the **Delay** command is: **Delay \$Time=** the length of time you want to delay the script. For example, to delay a script by 60 seconds, the **Delay** command would be:  
**Delay \$Time=60**

*End* Use the **End** command to declare the end of a script. The **End** command also terminates the execution of a script. At least one **End** statement must be described in the trailing line of the script statement. The format for the **End** statement is:  
**End**

*If/EndIf* The **If/EndIf** statements are used together to verify the conditions of an expression. If the **If/EndIf** statement is successfully completed, succeeding statements will be processed. If the **If/EndIf** statement is not successfully completed, the script will abort and the succeeding statements will not be completed. When **If/EndIf** statements are used, several conditions must be met. You must end an **If** statement with an **EndIf** statement. The execution statement cannot be defined on the same line as the **If** statement. The **If** statement must contain one conditional decision statement within parentheses. The string values must be compared as ASCII character codes (see the following table). The format for an **If/EndIf** statement is:



**If** expression one compared with expression two (see the following table for comparison expressions)

macro statement, either internal or functional

**EndIf**

For example, to start a TC390 pair only if the pair was created successfully (result value of CreateHrcPair command is not 0), use the following **If/EndIf** command:

```
If (_Result!=0)
  StartHrcPair
EndIf
```

**Table 129: ASCII character codes**

Character	Code
0	0x30
1	0x31
9	0x39
A	0x41
Z	0x5a
a	0x61
z	0x7a

**Table 130: If/EndIf comparison symbols**

Sym bol	Meaning
= =	Expression 1 is equal to Expression 2.
<	Expression 1 is less than Expression 2.
<=	Expression 1 is less than or equal to Expression 2.
>	Expression 1 is greater than Expression 2.
>=	Expression 1 is greater than or equal to Expression 2.
!=	Expression 1 is not equal to Expression 2.

*MakeString* Use the **MakeString** command to edit a string and/or convert numeric values to string characters. When using the **MakeString** statement several conditions must be met. For each format control string statement there must be an \$Item statement. The format control string of expression 1 must be enclosed in quotation marks (“”). If you set a value exceeding the maximum length of a string, the extraneous

portion of the value will be not set. The following table defines the two expression statement in the **MakeString** command. The format for the **MakeString** command is:

**MakeString** \$D= output buffer, \$Fmt= expression 1, \$Item= expression 2

**Table 131: MakeString expression definitions**

Expression 1	Expression 2
<p>Expression 1 is one of three format control strings (\$Fmt):</p> <p><b>%d</b> Converts a 16-bit numeric expression to a decimal number (0 - 65535).</p> <p><b>%x</b> Converts a 16-bit numeric expression to a hexadecimal number (0 - 0xffff).</p> <p><b>%s</b> Sets a string as it is.</p>	<p>Expression 2 is any expression not containing a list reserved variable (must be constant or work variable).</p>

For example, to create a **MakeString** statement that will convert the 16-bit numeric expression to a hexadecimal number (0 - 0xffff) and set the string as it is, with an output buffer of `_sMsgB`, the command would be:

```
MakeString $D=_sMsgB
,$Fmt="EndCode=(0x%x):%s"
,$Item=_Result,_sMsgA
```

For the **MakeString** command listed above: `_sMsgB = "EndCode=(0x110f):Error Occurred"`.

*SetList* Use the **SetList** command to assign specific items to a list. The format of the **SetList** command is: **SetList** \$D= output list, \$S=expression(attribute of the items to be assigned to the list with a numeric range of 0x0000 to 0xffff). For example, to set 0, 1, 2, 0x1e, and 0x1f to be displayed in the Dev (Device) B list the command would be:

```
SetList $D=i1DevB,$S={0,1,2,0x1e,0x1f}
```

*Start* Use the **Start** command to declare the beginning of a script and check to verify that the controller name matched the connected controller. When using the **Start** command, several conditions must be met. The **Start** command must be described on the first line of the script. The **Start** statement cannot include a comment statement, an empty statement or a blank statement. The **Start** statement must be displayed at the beginning of every script. If the controller name does not match the connected controller, an error will occur and the script will be aborted. The

format of the **Start** command is: **Start \$Script=“HRC”,\$Svr=** controller name. For example, to start a script for a controller named Training XP1024 the command would be:

```
Start $Script=“HRC”,$Svr=“Training XP1024”
```

---

**Note:** The controller name check is not available for this version. Therefore, the contents of the **\$Svr** does not affect the script file execution.

---

## Work Variables

There are two types of work variables: list type and non-list type. All work variables are initialized before a script is executed.

- Numeric work variables may have a value between 0x0000 and 0xffff. Numeric work variables are initialized with 0.
- A non-list string work variable may have a string with length up to 150 bytes. A list string work variable may have strings with length up to 16 bytes each. String work variables are initialized with a null string whose length is 0.
- A list work variable may have up to 1,024 items. A non-list work variable is a constant. List work variables are initialized as empty (no items).

The work variable is part of an execution statement in a script. The following table provides a description and the storage type of each work variable statement for list and non-list types.

**Table 132: Work variables**

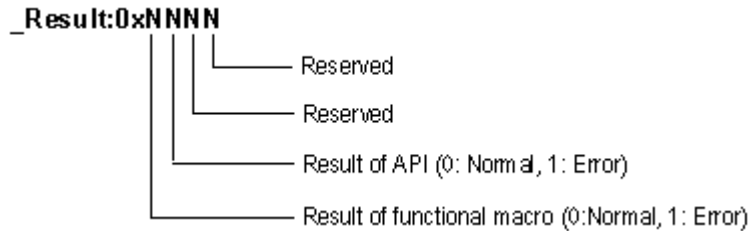
	Variable	Type	Description and Storage Type
List Type	_ilDEV	Numeri c	Stores the device number list. Expression: _ilDevA, _ilDevB, _ilDevC
	_ilPriority	Numeri c	Stores the priority number list. Expression: _ilPriorityA, _ilPriorityB, _ilPriorityC
	_ilWork	Numeri c	Stores any 16-bit numeric values. Expression: _ilWorkA, _ilWorkB, _ilWorkC, _ilWorkD, _ilWorkE, _ilWorkF
	_slWork	String	Stores any strings. Expression: _slWorkA, _slWorkB, _slWorkC, _slWorkD, _slWorkE, _slWorkF
Non-List Type	_iNum	Numeri c	Stores any 16-bit numeric value. Expression: _iNumA, _iNumB, _iNumC, _iNumD, _iNumE, _iNumF
	_sMsg	String	Stores any string. Expression: _sMsgA, _sMsgB, _sMsgC, _sMsgD, _sMsgE, _sMsgF

## Reserved Variables

Reserved variables include result variables (that is, result of macro execution) and status variables (that is, pair status of specified volume). The reserved variables are for reference use only.

### Reserved Result Variables

When a functional macro is executed (for example, CreateHrcPair), a result value (`_Result`) is issued. The following figure illustrates the result statement format, and the following table lists and defines the valid result values. When a new macro is initiated, the result value automatically resets to 0x0000. The functional macro executes on the specified number of devices. If the macro does not satisfy the execution condition, a conditional error occurs. If a conditional error is found, the result value is OR'ed with 0x1000, and the macro is logged in the error and macro trace files (see [Script Operations Screen](#) on page 816). If the return value of the API (application program interface) is not 0, an API error occurs. If an API error occurs, the result value is OR'ed with 0x0100, and the macro is logged in the error and macro trace files.

**Figure 359: Result statement format****Table 133: Reserved result variables**

Variable	Type	Description
_Result	Numeric	Stores the execution results of a macro. 0 = normal end. Other values depend on the macro.
_MsgResult	Numeric	Stores the execution results of a Message (internal) macro. 1 = OK, 6 = Yes, 7 = No.
_SelectResult	Numeric	Stores the number of devices found by SelectHrcDevice macro. 0 = no devices found.

## Reserved Status Variables

When a GetHrcStatus command is issued, the Command View management station obtains the status of the specified TC390 pair(s) from the XP128/XP1024. The results of this query are displayed in the reserved status variables. The following table lists and describes the valid reserved status variables.

**Table 134: Reserved status variables**

Variable	Type	Description
_HrcStatus _CopyType	String	Stores the copy type: "RDC" = remote copy mode; "RMC" = migration mode; "---" = other than the above modes.
_HrcStatus _DeviceAttr	String	Stores the device attribute: "M-Vol" = M-VOL; "R-Vol" = R-VOL; "---" = other than the above modes.
_HrcStatus _DeviceM	Numeric	Stores the M-VOL device number.
_HrcStatus _DeviceR	Numeric	Stores the R-VOL device number.
_HrcStatus _Sn	String	Stores the serial number of the controller for the remote copy pairs.
_HrcStatus _Ssid	Numeric	Stores the storage subsystem ID (SSID) of the controller for the remote copy pairs.
_HrcStatus _PairStatus	String	Stores the copy pair status: "Simplex" = simplex; "Duplex" = duplex; "Pending" = initial copy in progress; "Suspended0" = copy abort in initial copy; "Suspended1" = copy abort other than initial copy; "Suspending" = TC390A suspend in progress; "Deleting" = TC390A delete in progress; "Undefined" = undefined.
_HrcStatus _Fence	String	Stores the M-VOL fence level: "Never" = no fence; "Status" = fence due to an R-VOL status change failure; "Data" = fence due to a data error; "Undefined" = undefined.
_HrcStatus _Sync	String	Stores the synchronous level: "Synchronous0" = sync; "Synchronous2" = async; "Undefined" = undefined.

**Table 134: Reserved status variables (Continued)**

Variable	Type	Description
_HrcStatus _TimeOfUpdate	String	Stores the pair status update time: "MM/DD/YYYY hh:mm:ss" = MM: month, DD: day, YYYY: year, hh: hour, mm: minute, ss: second.
_HrcStatus _TimeOfEstablish	String	Stores the pair creation update time: "MM/DD/YYYY hh:mm:ss" = MM: month, DD: day, YYYY: year, hh: hour, mm: minute, ss: second.
_HrcStatus _CopyRatio	Numeric	Stores the copy progress ratio (0 – 100).
_HrcStatus _InternalStatus	Numeric	Stores the internal status code.
_HrcStatusTypeOfCT	String	Stores the timer type of the consistency group: "System" = system timer; "Local" = local (SVP) timer; "None" = no timer; "Undefined" = undefined.
_HrcStatus_CTG	Numeric	Stores the consistency group number: 0x00-0x7F.
_HrcStatus_SuspendBy	String	Stores the async suspension status: "Group" = consistency time of suspended volume matches consistency time of group; "Volume" = consistency time of suspended volume does not match the group consistency time; "Undefined" = undefined.
_HrcStatus_Errlv	String	Stores the error level (async) pair option: "Group" = all volumes in the group will be suspended if this volume is suspended; "Volume" = this volume will be suspended individually; "Undefined" = undefined.

## Optional Script Parameters

The parameters outlined in the following table are optional parameters that can be added to a script at the script creator's discretion. If any of these parameters are included in a script, the XP128/XP1024 will perform a syntactical check of the script to ensure that the syntax requirements for the parameter have been met. If no optional parameters are included, the XP128/XP1024 will not check any part

of the script. The XP128/XP1024 will run the script commands based only on what has been specified in the text of the script. The following table describes the syntax requirements that will be evaluated.

**Table 135: Syntax requirements for optional parameters**

Parameter	Syntax Requirements
Length	Check that each line does not exceed the maximum length for a script statement.
Phrases in a script statement	<p>A phrase is enclosed by the quotation symbols.</p> <p>Use of the parentheses is correct and the number of parentheses is exact.</p> <p>A statement does not terminate with an equal sign.</p> <p>The parameter identification name (phrase beginning with "\$") is always defined.</p> <p>The work variable and reserved variable (phrase beginning with "_") are always defined.</p>
Script statement	<p>The first line begins with (Start) as an execution statement.</p> <p>The lead of one line in the execution statement always begins with a macro name or an identification name for non-list type work variable.</p>
Substitute statement	<p>The number of phrases is correct.</p> <p>The equal sign is described exactly between the right side and the left side.</p> <p>The right side of the substitute statement is correct.</p>
SetList, AddList	<p>The number of phrases is not less than the minimum count.</p> <p>Duplicate parameter identification names are not specified.</p> <p>The required parameter identification name is defined.</p> <p>The equal sign is described between the right side and \$D.</p> <p>Specifying the right side is correct.</p> <p>The equal sign is described between the right side and \$\$S.</p> <p>Specifying the right side is correct.</p> <p>The parameter identification name is described immediately after the macro.</p> <p>The parameter identification names are delimited by a comma (,).</p> <p>An illegal phrase is not included in any statement.</p>



**Table 135: Syntax requirements for optional parameters (Continued)**

Parameter	Syntax Requirements
Start	<p>The number of phrases is not fewer than the minimum count.</p> <p>Duplicate parameter identification names are not specified.</p> <p>The required parameter identification name is defined.</p> <p>The equal sign is described between the right side and \$Script.</p> <p>Specifying the right side is correct.</p> <p>The equal sign is described between the right side and \$Svr.</p> <p>Specifying the right side is correct.</p> <p>The parameter identification name is described immediately after the macro.</p> <p>The parameter identification names are delimited by a comma (,).</p> <p>An illegal phrase is not included in one statement.</p>
End	<p>Check that the number of phrases matches.</p>
Delay	<p>The number of phrases matches.</p> <p>The required parameter identification name is defined.</p> <p>The equal sign is described between the right side and \$Time.</p> <p>Specifying the right side is correct.</p>
If	<p>The number of phrases matches.</p> <p>The parentheses are described in the correct location.</p> <p>Expressions 1 and 2 are correctly described.</p> <p>The attribute of expressions 1 and 2 matches.</p> <p>Specifying the right side is correct.</p> <p>The comparison operator is correctly described.</p>
EndIf	<p>The number of phrases matches.</p> <p>The macro is describe with the related If statement.</p>

**Table 135: Syntax requirements for optional parameters (Continued)**

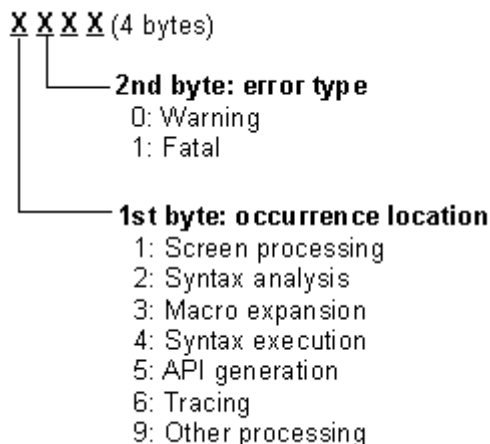
Parameter	Syntax Requirements
MakeString	<p>Duplicate parameter identification names are not specified.</p> <p>The required parameter identification name is defined.</p> <p>The equal sign is described between the right side and one of \$D, \$Fmt and \$Item.</p> <p>Specifying the right side is correct.</p> <p>The items are split by a comma (,) if multiple items are specified in \$Item.</p> <p>The parameter identification name is described immediately after the macro.</p> <p>The parameter identification names are delimited by a comma (,).</p> <p>The matching between the specification of the control string and the description of the item is correct.</p> <p>An illegal phrase is not included in any statement.</p>
Message	<p>The number of phrases is not less than the minimum count.</p> <p>Duplicate parameter identification names are not specified.</p> <p>The required parameter for the identification name is defined.</p> <p>The equal sign is described between the right side and \$Msg.</p> <p>Specifying the right side is correct.</p> <p>The equal sign is described between the right side and \$OptMsg.</p> <p>Specifying the right side is correct.</p> <p>The parameter identification name is described immediately after the macro.</p> <p>The parameter identification names are delimited by a comma (,).</p> <p>An illegal phrase is not included in one statement.</p>

**Table 135: Syntax requirements for optional parameters (Continued)**

Parameter	Syntax Requirements
Functional macro (except for StartHrcPair)	The number of phrases is not less than the minimum count. Duplicate parameter identification name is prohibited. The required parameter for the identification name is defined. The equal sign is described between the right side and the parameter identification name. Specifying the right side is correct. The parameter identification name is described immediately after the macro. The parameters for the identification names are delimited by a comma (,). An illegal phrase is not included in any statement.
StartHrcPair	Check that the number of phrases matches.
Entire check	Check that the (If) has a matching (EndIf). Check that the last line in the execution statement terminates at (END.)

## Error Reporting

The TC390 scripting error codes are slightly different from the general TC390 error codes. The following figure shows the format of the scripting error codes. The following table describes the TC390 scripting error messages. [Table 137](#) on page 1009 lists the TC390 scripting error codes. The message ID is the four-digit number displayed on the error message. The internal code is the four-digit number displayed in the fifth column of the error trace file (refer to [Script Operations Screen](#) on page 816). For additional TC390 troubleshooting information, refer to [Troubleshooting](#) on page 925.



**Figure 360: Scripting error code format**

**Table 136: Error messages**

Error Message	Conditions to Verify	Corrective Action
Syntax error	The syntax validity of the script is checked at the start of execution. An error message will be displayed if failed.	Use the scripting error code to determine which line contains the syntax error (see <a href="#">Table 137</a> on page 1009) and fix the syntax error.
Parameter error	The parameter validity of the script is checked on executing each instruction. An error message will be displayed if failed.	Use the scripting error code to determine which line contains the parameter error (see <a href="#">Table 137</a> on page 1009) and fix the parameter error.
Rejection	The result of the execution is checked on each target device. If failed, the last error status is displayed and error flag is set in the reserved variable <code>_Result</code> . Also script continues to be executed.	If you want to terminate the script or display a message of error occurrence and indication following steps, check that <code>_Result</code> is not 0 in script.
Skip if not executable	The condition of each target device is checked to be executable status. For example, the M-VOL status must be <i>simplex</i> to create a pair. If failed, error flag is set in the reserved variable <code>_Result</code> . Also script continues to be executed.	If you want to terminate the script or display a message of error occurrence and indication following steps, check that <code>_Result</code> is not 0 in script.

**Table 137: TrueCopy scripting error codes**

Message ID	Internal Code	Error Message	Error Description
2338	--	Normal End.	The script execution has completed successfully.
2339	1102	Cannot open a file by 'Memo' command.	The 'Memo' command cannot start the Write application. The Write.exe file may be absent from the Windows directory.
2340	1103, 1104	Invalid command line parameter.	An error is found in the startup parameter of the script monitor. The installation process may not have been complete.
2340	1105	Invalid command line parameter (1st parameter).	Start parameter (the 1st parameter) is invalid.
2340	1106	Invalid command line parameter (2nd parameter).	Start parameter (the 2nd parameter) is invalid.
2340	1107	Invalid command line parameter (3rd parameter).	Start parameter (the 3rd parameter) is invalid.
2340	1108	Invalid command line parameter (4th parameter).	Start parameter (the 4th parameter) is invalid.
2340	1109	Invalid command line parameter (5th parameter).	Start parameter (the 5th parameter) is invalid.
2340	110A	Invalid command line parameter (6th parameter).	Start parameter (the 6th parameter) is invalid.
2340	110B	Invalid command line parameter (Too short).	Start parameter is not enough
2340	1200	Memory allocation error.	Failed to allocate the memory.
2340	1201	Memory lock error.	Failed to lock the memory.
2341	1f01, 1f02	File I/O error (parameter).	The parameter file cannot be opened. The installation process may not have been complete.
2341	2f01, 2f02	File I/O error (script).	The specified file may be corrupt.
2341	2f03~2f05, 4101, 4102	File I/O error (temporary).	The work middle file is abnormal. The disk capacity maybe insufficient or the file may be corrupt.
2341	6101~6105	File I/O error (trace).	The macro trace file cannot be opened. The disk capacity may be insufficient or the file may be corrupt.

**Table 137: TrueCopy scripting error codes (Continued)**

Message ID	Internal Code	Error Message	Error Description
2341	6111~6115	File I/O error (trace).	The error trace file cannot be opened. The disk capacity may be insufficient or the file may be corrupt.
2342	2101	Too long line. Line = nnnn	A script line exceeds the maximum character length (240), where nnnn is the script line number.
2343	2201, 2203	Illegal 'If' and 'EndIf' pair. Line = nnnn	'If' and 'EndIf' script commands do not match, in script line nnnn
2344	2202	'End' is required. Line = nnnn	'End' does not exist at the end of the script line nnnn.
2345	2204	'Start' is required. Line = nnnn	The script line nnnn does not begin with 'Start.'
2346	2205	Illegal word is found. Line = nnnn	An illegal word was found in script line nnnn.
2347	2206	List type variable is unexpected. Line = nnnn	The list type variable is incorrect in script line nnnn.
2348	2207	Illegal quotation. Line = nnnn	A quotation mark is not found at the end of a string in script line nnnn.
2349	2208	Required value is not found. Line = nnnn	The end of line nnnn is "=".
2350	2209, 220a	Illegal '(and)' pair. Line = nnnn	The parentheses are not matched in script line nnnn.
2351	220b, 2303	Syntax error. Line = nnnn	An illegal word is included in script line nnnn.
2351	27xx	Syntax error. Line = nnnn	The parameter setting for script line nnnn is invalid.
2351	274A	Syntax error.	Syntax error for the \$Diff parameter line.
2351	274B	Syntax error.	Syntax error for the \$TimeSave parameter line.
2351	29xx	Syntax error. Line = nnnn	The macro description for script line nnnn is invalid.
2351	2axx	Syntax error. Line = nnnn	An invalid comma is used in script line nnnn.
2351	2A4B	Syntax error.	A comma is required after the \$Diff parameter.

**Table 137: TrueCopy scripting error codes (Continued)**

Message ID	Internal Code	Error Message	Error Description
2351	2A4C	Syntax error.	A comma is required after the \$TimeSave parameter.
2352	220e	Illegal expression. Line = nnnn	An unavailable operator is defined in the if statement of script line nnnn.
2353	220f	Illegal parameter. Line = nnnn	The list of the format control string and the value of the expression specified by \$Item do not match in the Make String command. Or, the format control string and the expression do not match the attributes in script line nnnn.
2353	24xx	Illegal parameter. Line = nnnn	The parameters of script line nnnn are invalid.
2354	2301	Unknown parameter. Line = nnnn	An undefined parameter is used in script line nnnn.
2355	2355	Unknown identifier. Line = nnnn	An undefined word is used to define the parameters in script line nnnn.
2356	25xx	Same parameter appears again. Line = nnnn	A duplicate parameter was found in script line nnnn.
2356	254A	Same parameter appears again.	Same parameter (\$Diff) is used more than once.
2356	254B	Same parameter appears again.	Same parameter (\$TimeSave) is used more than once.
2357	26xx	Required parameter is not found. Line = nnnn	A required parameter for script line nnnn was not found.
2358	28xx	Value type mismatch. Line = nnnn	The values on the left and right side of script line nnnn are not compatible.
2358	285C	Value type mismatch.	The value type for the \$Diff parameter are not compatible.
2358	285D	Value type mismatch.	The value type for the \$TimeSave parameter are not compatible.
2359	1001, 4111, 4112	Internal error.	An internal program error has occurred. The program installation may not have been complete.
2360	4181	Mismatch script type.	The script types specified by the Start macro and by the execution environment file are different.

**Table 137: TrueCopy scripting error codes (Continued)**

Message ID	Internal Code	Error Message	Error Description
2361	4182	Mismatch controller name.	The device names specified by the Start macro and by the execution environment file are different.
2362	5101	Parameter value error (\$Dev).	A functional macro parameter error was found. Check the setting value in the \$Dev parameter.
2362	5102	Parameter value error (\$Priority).	A functional macro parameter error was found in setting \$Priority.
2362	5103	Parameter value error (\$Fence).	A functional macro parameter error was found in setting \$Fence.
2362	5104	Parameter value error (\$Sync).	A functional macro parameter error was found in setting \$Sync.
2362	5105	Parameter value error (\$SusMode).	A functional macro parameter error was found in setting \$SusMode.
2362	5106	Parameter value error (\$SusReport).	A functional macro parameter error was found in setting \$SusReport.
2362	5107	Parameter value error (\$DelMode).	A functional macro parameter error is found in the setting \$DelMode.
2362	5108	Parameter value error (\$OptCfw).	A functional macro parameter error is found in setting \$OptCfw.
2362	5109	Parameter value error (\$OptSusDfwBlk).	A functional macro parameter error is found in setting \$OptSusDfwblk.
2362	5110	Parameter value error (\$RcuSn).	A functional macro parameter error was found in setting \$RcuSn.
2362	5111	Parameter value error (\$RcuSsid).	A functional macro parameter error was found in the setting \$RcuSsid.
2362	5112	Parameter value error (\$Rdev).	A functional macro parameter error was found in the setting \$Rdev.
2362	5113	Parameter value error (\$CopyPace).	A functional macro parameter error was found in the setting \$CopyPace.
2362	5114	Parameter value error (\$CopyMode).	A functional macro parameter error was found in the setting \$CopyMode.
2362	5115	Parameter value error (\$PairStatus).	A functional macro parameter error was found in the setting \$PairStatus.



**Table 137: TrueCopy scripting error codes (Continued)**

Message ID	Internal Code	Error Message	Error Description
2362	5116	Parameter value error (\$DevAttr).	A functional macro parameter error was found in the setting \$DevAttr.
2362	5117	Parameter value error (\$DevAttr).	A functional macro parameter error was found in the setting \$DevAttr.
2362	5118	Parameter value error (\$DevAttr).	A functional macro parameter error was found in the setting \$DevAttr.
2362	5121	Parameter value error (\$RcuSn!=\$Dev).	A functional macro parameter error was found in the \$RcuSn!=\$Dev setting.
2362	5122	Parameter value error (\$RcuSsid!=\$Dev).	A functional macro parameter error was found in the \$RcuSsid!=\$Dev settings.
2362	5123	Parameter value error (\$Rdev!=\$Dev).	A functional macro parameter error was found in the \$Rdev!=\$Dev settings.
2362	5124	Parameter value error (\$CopyMode!=\$Sync).	A functional macro parameter error is found in the \$CopyMode!=\$Sync settings.
2362	5132	Parameter value error (\$CTG). Error Code = eeee	A functional macro parameter error is found. Set the correct CT group number in the \$CTG parameter.
2362	5133	Parameter value error (\$OptErrLv). Error Code = eeee	A functional macro parameter error is found. Set the correct error level in the \$OptErrLv parameter.
2362	5134	Parameter value error (\$SusRange). Error Code = eeee	A functional macro parameter error is found. Set the correct suspend range in the \$SusRange parameter.
2362	5135	Parameter value error (\$PendData). Error Code = eeee	A functional macro parameter error is found. Set the correct pending data flag in the \$PendData parameter.
2362	5136	Parameter value error (\$DelRange). Error Code = eeee	A functional macro parameter error is found. Set the correct delete range in the \$DelRange parameter.
2362	5137	Parameter value error (\$OptRsmRange). Error Code = eeee	A functional macro parameter error is found. Set the correct resume range in the \$OptRsmRange parameter.
2362	5138	Parameter value error (\$Seqchk). Error Code = eeee	A functional macro parameter error is found. Set the correct SEQCHK flag in the \$Seqchk parameter.

**Table 137: TrueCopy scripting error codes (Continued)**

Message ID	Internal Code	Error Message	Error Description
2362	5139	Parameter value error (\$TimeSave). Error Code = eeee	A functional macro parameter error is found. Set the correct time-saving mode flag in the \$TimeSave parameter.
2362	513A	Parameter value error (\$TimeSave).	A functional macro parameter error is found. Set the correct value in the \$TimeSave parameter.
2362	513B	Parameter value error (\$Diff).	A functional macro parameter error is found. Set the correct value in the \$Diff parameter.
2995	5201	Illegal combination (\$Sync and \$OptSusDfwBlk). Error Code = eeee	A functional macro parameter combination error is found. (\$Sync and \$OptSusDfwBlk.)
2995	5203	Illegal combination (\$Sync and \$CTG). Error Code = eeee	A functional macro parameter combination error is found. (\$Sync and \$CTG.)
2995	5204	Illegal combination (\$Sync and \$OptErrLv). Error Code = eeee	A functional macro parameter combination error is found. (\$Sync and \$OptErrLv.)
2996	5301	\$CTG not found. Error Code = eeee	\$CTG is not described when asynchronous copy pair creation.

## HXRC Device Blocking and Load Balancing

The XP128/XP1024 supports the IBM-compatible specifications for XRC device blocking and load balancing control. In addition, the XP128/XP1024 provides more flexible tuning methods for load balancing control under HXRC environments as shown below.

### Device Blocking Function

The XP128/XP1024 HXRC function supports the new TSO command specifications for the XRC device blocking function.

- **DONOTBLOCK option.** DONOTBLOCK is a new option parameter that is specified by the XADDPAIR command.
  - **Not specified (Default):** The amount of write data for application programs are blocked by the threshold specified by SDM. Default value is “500”HEX RECSETS.
  - **Specified:** When the DONOTBLOCK option is specified to a logical device, the amount of write data of application programs for the logical device is not blocked.
- **XQUERY.** The number of RECSSET and the current threshold value corresponding to a logical device will be displayed by the XQUERY command.



**Caution:** If you specify the DONOTBLOCK option for too many devices, a sidefile puncture condition will occur. Use caution when determining the appropriate tuning (devices with DONOTBLOCK option, SVP modes) for your operational environment.

---

## Load Balancing Control

### Current Load Balancing Control

The XP128/XP1024 has three fixed thresholds and three levels of load balancing for varying amounts of sidefile cache as follows: Threshold 1/2/3 = 40/50/60%.

- **Level 1:** Sidefile capacity is 40% -50% of the total cache capacity. Write I/Os are blocked by “Sleep”- “Wait” logic. The following modes are set on the XP128/XP1024 SVP:

- **Mode 45:** “Sleep” -”Wait” suppression option  
**OFF** (Default): Disk array performs “Sleep”-“Wait” command retry per one write I/O to block write I/O until the amount of sidefile is less than 40% of total cache.  
**ON:** Disk array does not perform “Sleep”-“Wait” command retry.
- **Mode 97:** “Wait” timer control  
**OFF** (Default): When the amount of sidefile is over 40% of total cache capacity, the XP128/XP1024 waits 100 ms as “Sleep”-“Wait” timer for write I/O.  
**ON:** When the amount of sidefile is over 40% of total cache capacity, the XP128/XP1024 waits 10 ms as “Sleep”-“Wait” timer for write I/O.
- **Level 2:** Sidefile capacity is over 50% -60% of the total cache capacity. Write I/Os are blocked by “SCP”-“SCI” logic. The following modes are set on the XP128/XP1024 SVP:
  - **Mode 98:** “SCP” reporting suppression option  
**OFF** (Default): When the amount of sidefile is over 50% of total cache capacity, the XP128/XP1024 reports SCP status for write I/O. Operating system cannot issue the write I/O until SCI status is received. The XP128/XP1024 reports SCI when the amount of sidefile is less than 50% of the total cache capacity.  
**ON:** The XP128/XP1024 does not perform “SCP” reporting for write I/O.
- **Level 3:** Sidefile capacity exceeds 60% in the total cache capacity. Sidefile puncture occurs. The session that has the largest amount stored in sidefile cache is canceled.

---

**Note:** The XP128/XP1024 SVP mode settings are preserved, even during microprogram exchange or disk array power-off.

---

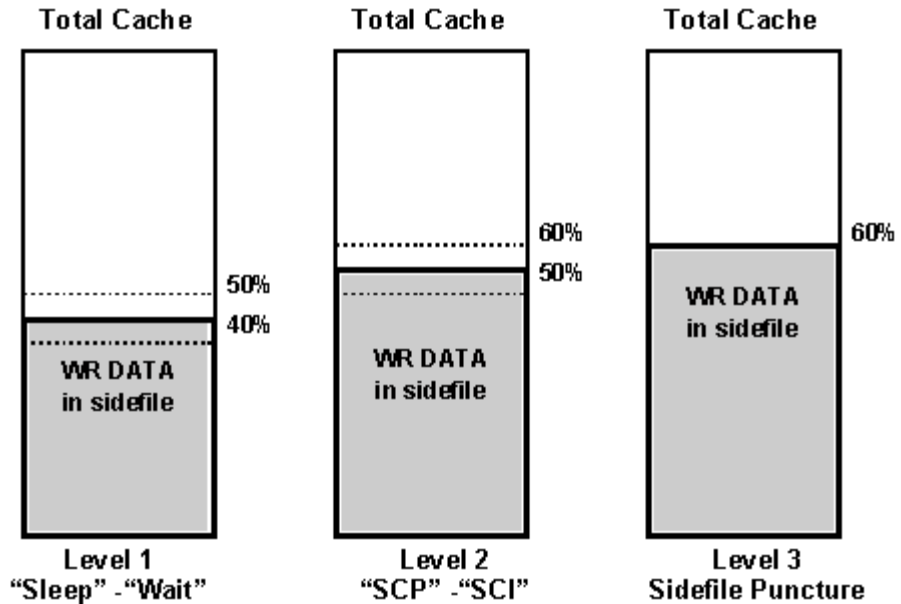


Figure 361: Current load balancing control

## New Load Balancing Control

The following conditions are required to activate the new DONOTBLOCK option for the XADDPAIR TSO command:

- The operating system must support the new DONOTBLOCK option.
- Mode 61 must be ON.  
If Mode 61 is OFF (default), the XP128/XP1024 performs current load balancing control. If the operating system does not support the DONOTBLOCK option, set Mode 61 = OFF.

**DONOTBLOCK option:** The XP128/XP1024 does not block write I/Os for the specified logical device, to avoid performance impact for application programs.



**Caution:** If you specify the DONOTBLOCK option for too many devices, a sidefile puncture condition will occur. Use caution when determining the appropriate tuning (devices with DONOTBLOCK option, SVP modes) for your operational environment.

**Load balancing control for sidefile:** When the DONOTBLOCK option is not specified, the XP128/XP1024 has four levels of load balancing for amount of sidefile. Level 0 control is new for load balancing control.

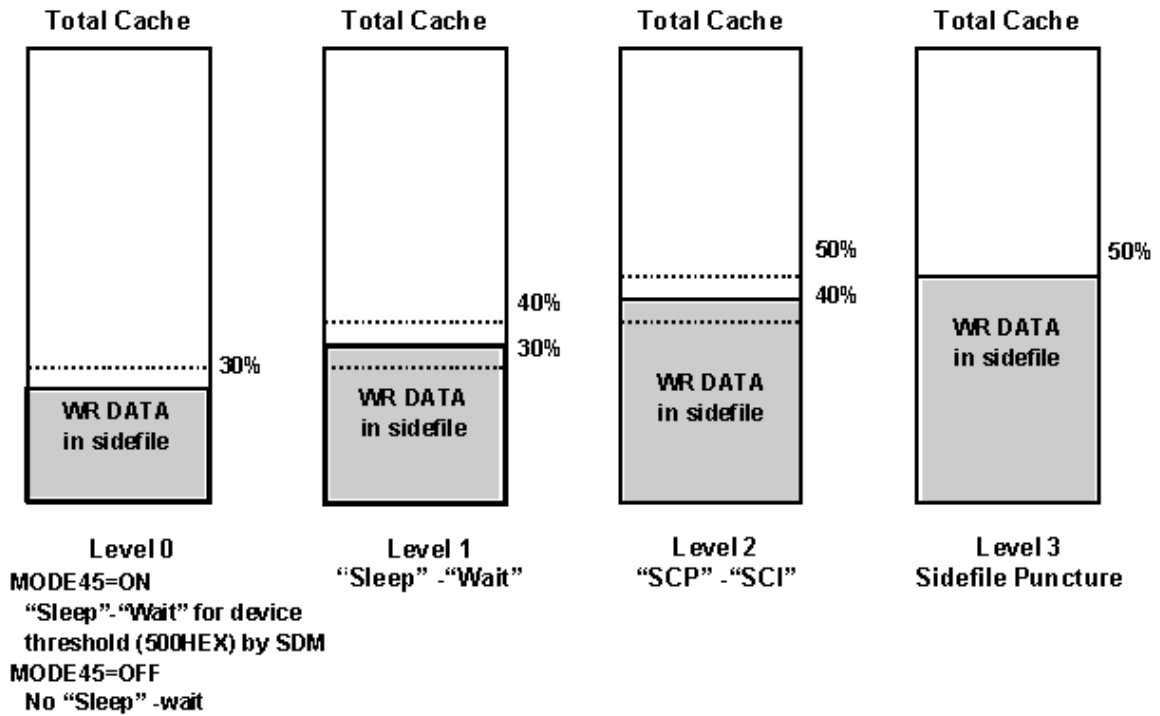
- Level 0: Sidefile capacity is less than threshold 1 in the total cache capacity.  
MODE 45 = ON: Write I/Os for logical devices are blocked (“Sleep”-“Wait” logic) by the threshold (500 HEX RECSETS) specified by SDM.  
MODE 45 = OFF: Write I/Os are not blocked.
- Level 1: Sidefile capacity is over threshold 1 - threshold 2 of the total cache capacity.  
MODE 97: “Wait” timer control. Same as level 1 in current load balancing control.
- Level 2: Sidefile capacity is over threshold 2 - threshold 3 of the total cache capacity.  
MODE 98: “SCP” reporting suppression option. Same as level 2 in current load balancing control.
- Level 3: Sidefile capacity exceeds threshold 3 of the total cache capacity.  
Sidefile puncture occurs. Same as level 3 in current load balancing control.

**Variable sidefile threshold.** Two new system options are assigned as variable sidefile threshold as follows. These options are effective whether Mode 61 = ON or OFF.

- MODE 85, 86
  - Combination 1: MODE 85,86 = ON,OFF – Threshold 1/2/3=30/40/50%
  - Combination 2: MODE 85,86 = OFF,OFF – Threshold 1/2/3=40/50/60%

**Default**

  - Combination 3: MODE 85,86 = OFF,ON – Threshold 1/2/3=50/60/70%
  - Combination 4: MODE 85,86 = ON,ON – Threshold 1/2/3=60/70/80%



**Figure 362: Combination 1: MODE 85,86 = ON,OFF; Threshold 1/2/3 = 30/40/50%**

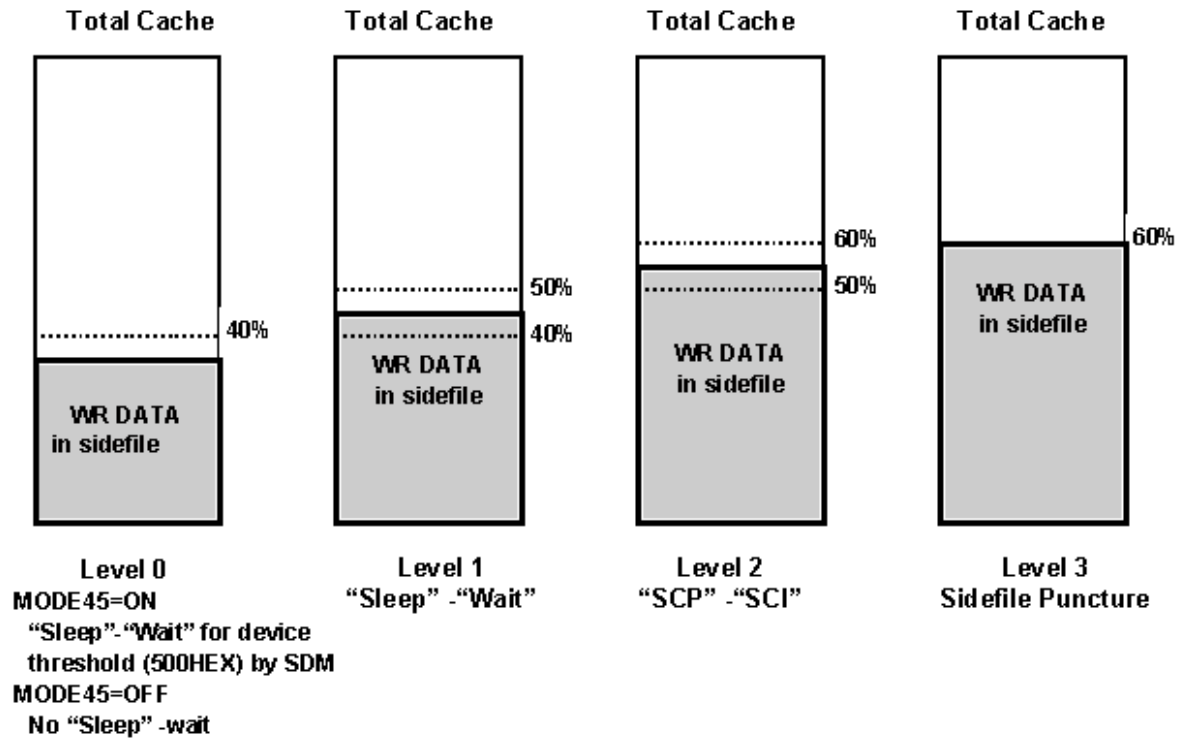


Figure 363: Combination 2 (Default): MODE 85,86 = OFF,OFF; Threshold 1/2/3 = 40/50/60%



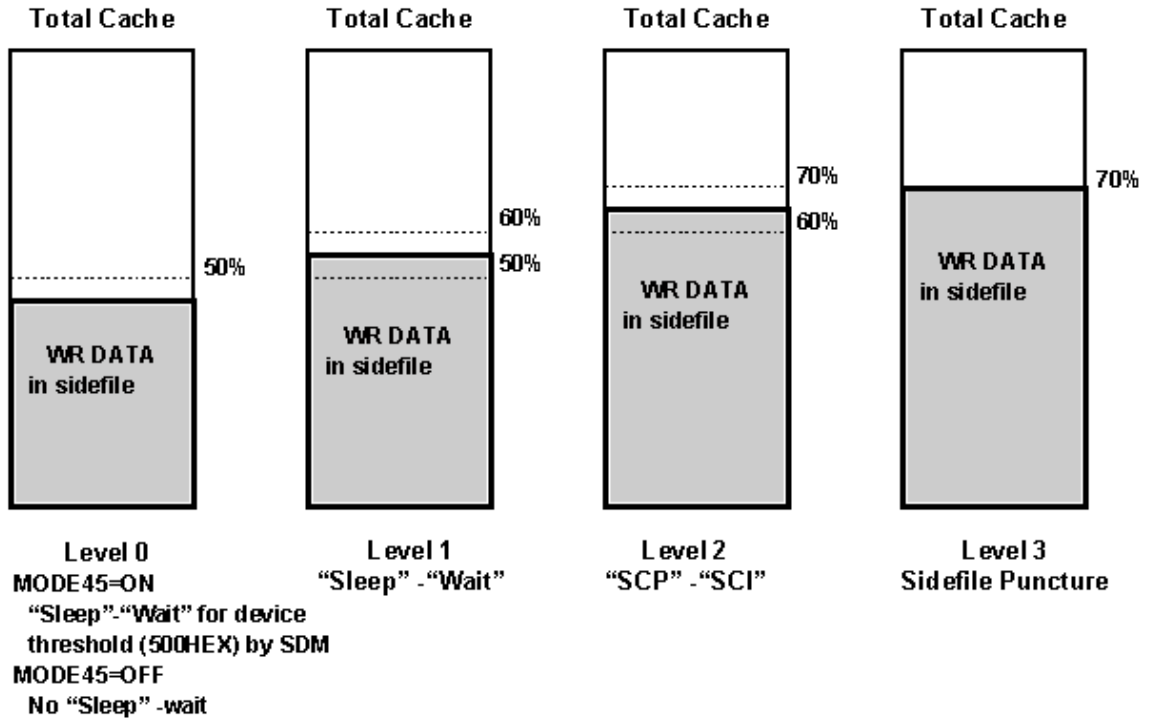


Figure 364: Combination 3: MODE 85,86 = OFF,ON – Threshold 1/2/3 = 50/60/70%

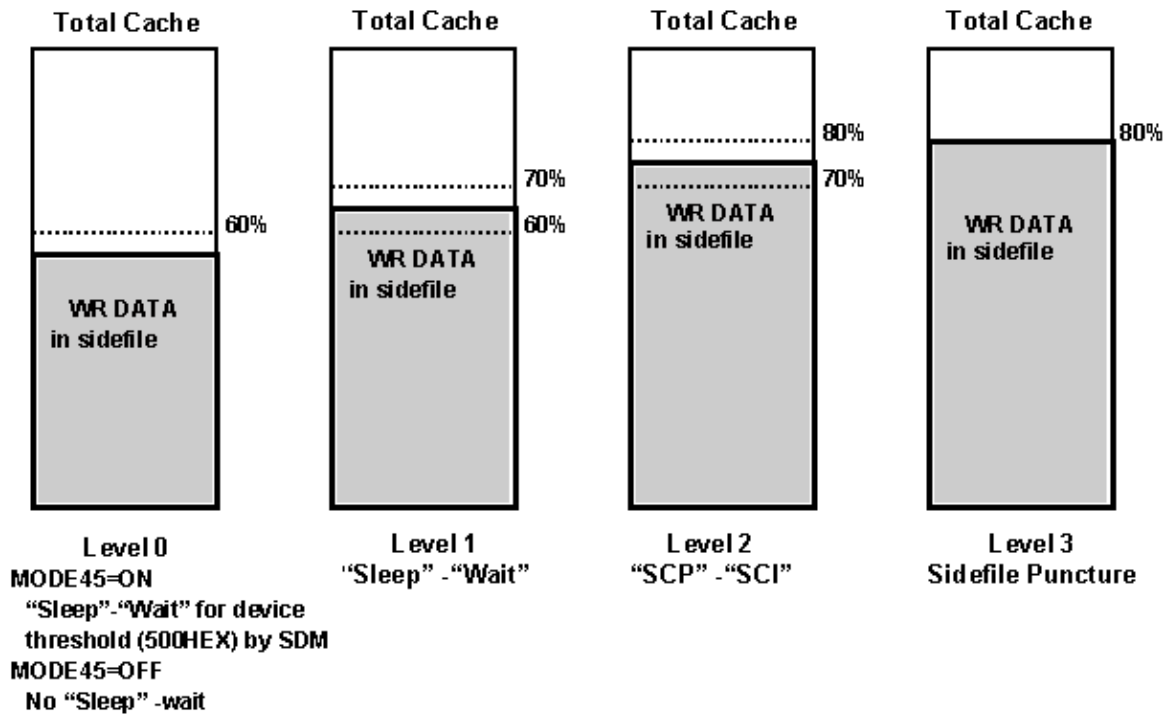


Figure 365: Combination 4: MODE 85,86 = ON,ON – Threshold 1/2/3 = 60/70/80%

# ShadowImage for the XP128/XP1024 (Mainframe)

23

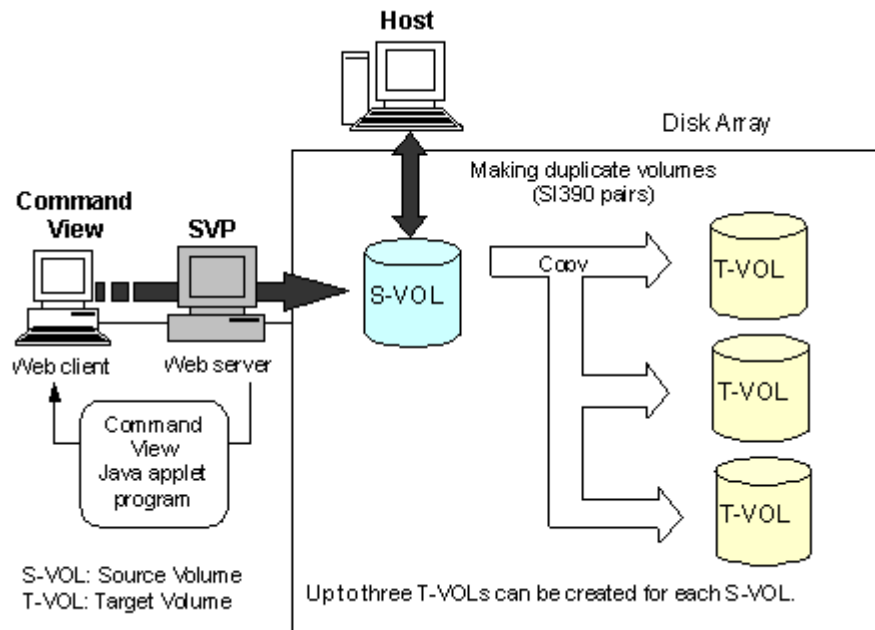
ShadowImage (SI390) is a storage-based hardware solution for duplicating logical volumes that reduces backup time and provides point-in-time backup. The SI390 source volumes (S-VOLs) contain the original data and the SI390 target volume(s) (T-VOLs) contain the duplicate data. The user can choose to make up to three copies of each S-VOL. Because each T-VOL is paired with its S-VOL independently. Each T-VOL can be maintained as an independent copy set that can be split, resynchronized, and deleted separately from the other T-VOLs assigned to the same S-VOL.

## ShadowImage Components

SI390 operations involve the source and target volumes in the XP128/XP1024, Command View XP, and optionally, the IBM PPRC host software functions. The SI390 system components are:

- SI390 volume pairs (S-VOLs and T-VOLs) (see page 1024)
- Command View
- (Optional) IBM PPRC host software functions (see page 1025)
- (Optional) IBM DFSMSDss host software functions (see on page 1025)

The following figure shows a typical SI390 configuration.



**Figure 366: Typical SI390 configuration**

## Volume Pairs (S-VOLs and T-VOLs)

The XP128/XP1024 contains and manages both the original and copied SI390 data. SI390 supports a maximum of 8,192 volumes (4,096 pairs: 4,096 S-VOLs and 4,096 T-VOLs).

SI390 performs internal copy operations for logical volume pairs established by the user. Each SI390 pair consists of one source volume (S-VOL) and up to three target volumes (T-VOLs) that are located in the same XP128/XP1024. The SI390 S-VOLs are the source volumes that contain the original data. The SI390 T-VOLs are the target or secondary (mirrored) volumes that contain the backup data. Each T-VOL must be paired with only one S-VOL. During normal SI390 operations, the S-VOLs remain available to all hosts at all times for read and write I/O operations. The T-VOLs become available for host access only after a split operation has been performed.

When an SI390 volume pair is added, the data on the S-VOL is copied to the T-VOL. During this initial copy operation and after the pair status becomes *duplex*, all write operations to the T-VOL are prohibited. If you need to access a T-VOL, you can split the pair to make the T-VOL accessible (the S-VOL is always

accessible). While an SI390 pair is split, the XP128/XP1024 keeps track of all changes to the S-VOL and T-VOL as a differential bitmap. When you resync the pair, the differential data in the S-VOL (due to S-VOL and T-VOL updates) is copied to the T-VOL so that the T-VOL is again identical to the S-VOL.

---

**Note:** SI390 T-VOLs are updated asynchronously. For a volume pair with duplex status, the S-VOL and T-VOL may not be identical. For more information on SI390 update copy operations, refer to [Add Pair Operation](#) on page 1030.

---

SI390 S-VOLs or T-VOLs should not be concentrated in the same RAID group. To disperse workloads of the RAID groups, each RAID group should have both S-VOLs and T-VOLs evenly distributed. SI390 pairs for which an SI390 operation is performed simultaneously should be in different RAID groups. If SI390 pairs are concentrated in only a few RAID groups, the host I/O performance may be degraded. To minimize effect on the host I/O performance, take the following actions:

- Specify **Slower** for the copy pace when you create, split, or resync SI390 pairs.
- If the SI390 pairs that you want to perform copy operation are in the same ECC group, reduce the number of pairs at one copy operation. For example, to split multiple SI390 pairs in the same ECC group, wait until one pair is completely split before splitting another pair.

If the XP128/XP1024 is overloaded, you must increase cache, disk adapters, and/or RAID groups. Consider assigning SI390 T-VOLs in the newly installed RAID groups. If you continue SI390 operations with an overloaded XP128/XP1024, host I/O performance may be degraded.

## IBM PPRC Host Software Functions

SI390 supports the IBM PPRC host software functions, including TSO PPRC commands and ICKDSF PPRCOPY commands. SI390 pairs can be added, split, resynced, and deleted using TSO PPRC or ICKDSF PPRCOPY commands. [Using PPRC Commands for ShadowImage](#) on page 1094 describes and provides instructions for using PPRC commands to create and maintain SI390 volume pairs on the XP128/XP1024. Also, ShadowImage - FlashCopy supports the IBM TSO PPRC commands and DFSMSdss commands. ShadowImage - FlashCopy pairs can be established by defining “relationship” using TSO PPRC or DFSMSdss

commands. [Using ShadowImage - FlashCopy](#) on page 1118 describes and provides instructions for using TSOPPRC and DFSMSDss commands to ShadowImage - FlashCopy define relationship.

## ShadowImage Requirements

SI390 operations provide disk array-internal copies of S/390 logical volume images (LVIs) on the XP128/XP1024. The following table lists and describes the operational requirements for SI390.

**Table 138: ShadowImage requirements**

Parameter	Specification
Pair objects	Logical devices (LDEVs): M/F and multiplatform devices that are supported by XP128/XP1024, including custom-size devices of Virtual LVI. Devices must be installed and formatted. The S-VOL and T-VOL must be same type and same size. For example, 3390-3R to 3390-3R is allowed, but 3380-K to 3390-9 is not allowed. A custom-size S-VOL must be paired with a T-VOL of the same type and same size. A combination of M/F and multiplatform devices for creating an SI390 pair is supported. Open volumes. For example, OPEN-3, OPEN-9, or OPEN-E are not supported.
Number of copies	Maximum three copies (T-VOLs) per source volume (S-VOL).
Maximum number of pairs	The total number of SI390, Business Copy (BC), and Auto LUN volume pairs. For details, refer to <a href="#">Requirements on the Maximum Number of Pairs</a> on page 1027.
Maximum number of reserved volumes	4,096 reserved volumes per XP128/XP1024.
Combinations of RAID levels	All combinations supported: RAID1-RAID1, RAID5-RAID5, RAID1-RAID5, and RAID5-RAID1.
Dynamic sparing and auto correction copy	If a failure occurs that requires use of dynamic sparing or automatic correction copy, the status of the paired volumes associated with the failed physical device will not be affected.
Physical device (PDEV) maintenance	If a PDEV requires maintenance, the status of the logical volumes associated with that PDEV will not be affected. However, if PDEV maintenance requires access to an SI390 pair volume, the pair must be deleted, and the <b>Reserve</b> attribute must be reset (unreserved).
Logical device maintenance	LDEV maintenance cannot be performed on LDEVs that are assigned to SI390 pairs. If LDEV maintenance requires access to an SI390 LDEV, the pair must be deleted, and the <b>Reserve</b> attribute must be reset (unreserved).

**Table 138: ShadowImage requirements (Continued)**

Parameter	Specification
Cache maintenance	If XP128/XP1024 cache maintenance is performed during a period of high I/O usage, one or more SI390 pairs may be suspended. Reduce the I/O load before cache maintenance.
Point-in-time backup	For duplex pairs, host I/Os are copied to the T-VOL asynchronously. If you want to synchronize a pair and then access the T-VOL as soon as possible, vary the S-VOL offline and then split the pair before using the T-VOL.
Failures	When a failure of any kind prevents an SI390 copy operation from completing, the pair is suspended. If an LDEV failure occurs, the pair is suspended. If a PDEV failure occurs, SI390 pair status is not affected because of the RAID architecture.
Maintenance/Update	When the disk array maintenance is performed, or the microprogram is updated, you may have to add SI390 pairs again.

### Requirements on the Maximum Number of Pairs

The number of pairs you can create depends on the emulation type and the capacity of the paired volumes. For details, refer to the following table that shows the number of pairs that can be created with volumes of each emulation type and capacity.

The following table shows the number of pairs that you can create with volumes of same emulation type and capacity. When volumes with different emulation types and capacities are paired, the number of pairs that you can create is determined according to the following condition.

The maximum number of pairs that can be created is the largest number that meets the equation,  $\Sigma(\alpha) \leq (\beta)$ , where:

$\Sigma(\alpha)$  stands for the total of the number of differential tables per pair, and

$(\beta)$  stands for the number of differential tables in the disk array.

$(\beta) = 2,048$  when the number of CUs is equal to or less than 4

$(\beta) = 4,096$  when the number of CUs is equal to or more than 5

For example, if you create 10 pairs of 3390-3 volumes and 20 pairs of 3390-L (32,760 CYL) volumes, the total of the number of differential tables per pair,  $\Sigma(\alpha)$ , would be  $(1 \times 10) + (4 \times 20) = 90$ .

Because 90 is smaller than 2,048 (when the number of CUs is equal to or less than 4) or 4,096 (when the number of CUs is equal to or more than 5), it meets the equation,  $\Sigma(\alpha) \leq (\beta)$ , thus ensuring you that 10 pairs of 3390-3 volumes and 20 pairs of 3390-L (32,760 CYL) volumes can be created.

Note that the maximum number of pairs that you can create is limited to the number of volumes that are installed.

**Table 139: Number of Pairs That Can Be Created With Volumes of Each Emulation Type and Capacity**

No.	Volume		No. of differential tables per pair needed for controlling the difference between the primary and secondary volumes	No. of pairs that can be created (If the volumes of the same emulation type and capacity are used to create all the pairs)	
	Emulation Type	Capacity		CUs is 4 or less	CUs is 5 or more
1	3390-3	Does not depend on the capacity	1	2,048	4,096
2	3390-2	Does not depend on the capacity	1	2,048	4,096
3	3390-1	Does not depend on the capacity	1	2,048	4,096
4	3390-9	Does not depend on the capacity	1	2,048	4,096
5	3380-K	Does not depend on the capacity	1	2,048	4,096
6	3380-E	Does not depend on the capacity	1	2,048	4,096
7	3380-J	Does not depend on the capacity	1	2,048	4,096



**Table 139: Number of Pairs That Can Be Created With Volumes of Each Emulation Type and Capacity**

No.	Emulation Type	Volume		No. of differential tables per pair needed for controlling the difference between the primary and secondary volumes	No. of pairs that can be created (If the volumes of the same emulation type and capacity are used to create all the pairs)	
		Capacity			CUs is 4 or less	CUs is 5 or more
8	3390-L	RAID config. is (2D+2D) or (3D+1P)	RAID config. is (7D+1P)			
9		1 - 10,043 CYL	1 - 10,041 CYL	1	2,048	4,096
10		10,044 - 20,110 CYL	10,042 - 20,109 CYL	2	1,024	2,048
11		20,111 - 30,177 CYL	20,110 - 30,174 CYL	3	682	1,365
12		30,178 CYL or more	30,175 CYL or more	4	512	1,024

## ShadowImage Operations

SI390 operations can be performed using the SI390 using the Command View Java applet program for SI390, or from the S/390 host using TSO and/or ICKDSF commands. For more information on using TSO/ICKDSF commands to set up and maintain SI390 volume pairs, refer to [Using PPRC Commands for ShadowImage](#) on page 1094. Your HP representative can also perform SI390 operations for you using the XP128/XP1024 service processor (SVP). For information on SI390 configuration services, contact your HP account team.

## Setting/Resetting Reserve Attribute Operation

The SI390 set reserve attribute operation reserves a volume so that it can be used as an SI390 T-VOL. Reserved volumes can be used only as SI390 T-VOLs. The XP128/XP1024 rejects all write operations to reserved volumes (unless in split

status). You can reserve up to 4,096 volumes in one XP128/XP1024. Use the Set Reserve Attribute window (see [Setting the Reserve Attribute](#) on page 1066) to reserve volumes for use as T-VOLs.

The SI390 reset reserve attribute operation unreserves a volume so that it can be varied online and accessed by hosts. After you reset the reserve attribute, the XP128/XP1024 will accept all subsequent read and write I/O operations to the volume. Use the Reset Reserve Attribute window (see [Resetting the Reserve Attribute](#) on page 1068) to unreserve volumes.

---

**Note:** When TSO or ICKDSF commands are used to establish SI390 pairs, the T-VOLs do not need to be reserved. The CESTPAIR and PPRCOPY ESTPAIR commands require that potential T-VOLs be offline to the host.

---

## Add Pair Operation

The SI390 add pair operation establishes the new specified SI390 pair(s). The volume that will be the S-VOL must be in the simplex state, and the volume that will be the T-VOL must be reserved (if assigned automatically) and simplex before being added to an SI390 pair. Use the Add Pair Dialog window (see [Adding ShadowImage Pairs](#) on page 1069) to add (start) new SI390 volume pairs.

---

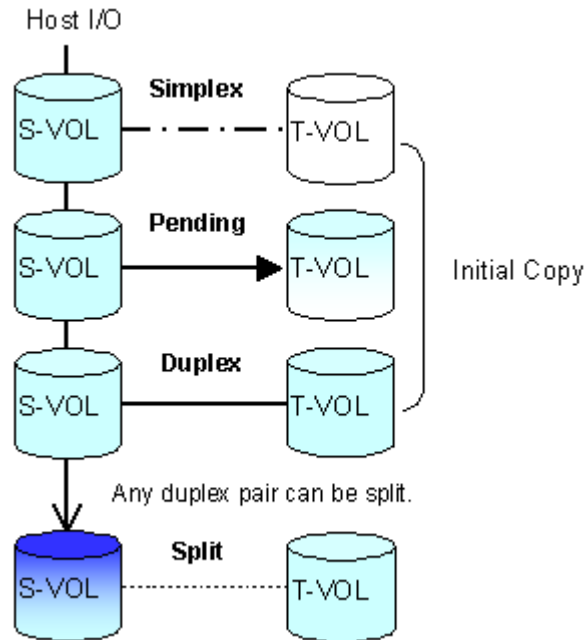
**Note:** Use the CESTPAIR and PPRCOPY ESTPAIR commands to add (start) SI390 pairs. For more information on PPRC commands, see [Using PPRC Commands for ShadowImage](#) on page 1094.

---

## Initial Copy Operation

The SI390 initial copy operation takes place when you add a new SI390 pair. The initial copy operation copies all data on the S-VOL to the associated T-VOL(s). The S-VOL remains available to all hosts for read and write I/Os throughout the initial copy operation. Write operations performed on the S-VOL during the initial copy operation will be duplicated at the T-VOL(s) by update copy operations after the initial copy is complete. The status of each pair is *pending* while the initial copy operation is in progress. The pair status changes to *duplex* when the initial copy operation is complete.

When adding pairs, you can select the pace for the initial copy operations: slower, medium, or faster. The slower pace minimizes the impact of SI390 operations on disk array I/O performance while the faster pace completes the initial copy operations as quickly as possible.

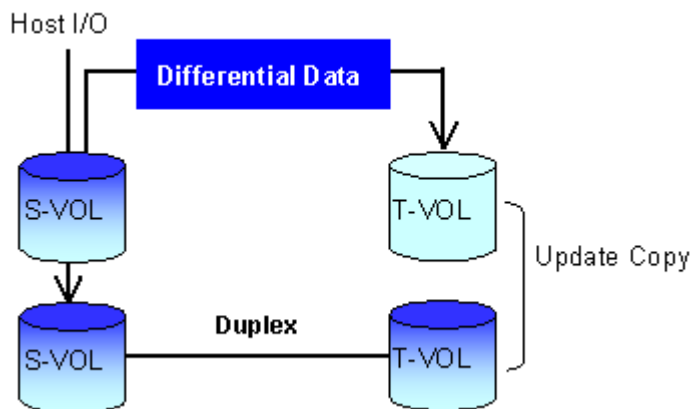


**Figure 367: Adding a pair**

### Update Copy Operation

The SI390 update copy operation updates the T-VOL of an SI390 pair after the initial copy operation is complete. Update copy operations take place only for duplex pairs. As write I/Os are performed on a duplex S-VOL, the XP128/XP1024 stores a map of the S-VOL differential data, and then performs update copy operations periodically based on the amount of differential data present on the S-VOL as well as the elapsed time between update copy operations. The following figure illustrates an update copy operation in an SI390 pair with only one T-VOL. Update copy operations are not performed for SI390 pairs with the following status: *pending*, *SP-pend*, *V-Split*, *split*, *resync*, *resync-R*, and *suspend*.

**Note:** Update copy operations do not occur every time a host issues a write I/O operation to the S-VOL of an SI390 pair. SI390 update copy operations are performed asynchronously according to the differential bitmap, which is stored in shared memory. If shared memory is lost (for example, offline micro exchange or volatile PS on), the differential bitmap is also lost. In this case, the XP128/XP1024 treats the entire S-VOL (T-VOL for resync-R pairs) as difference data and recopies all data to the T-VOL (S-VOL for resync-R pairs) to ensure proper pair resynchronization. For pairs with SP-pend or V-Split status, the XP128/XP1024 changes the status to suspend due to the loss of the differential bitmap, ensuring proper resynchronization of these pairs. If shared memory has been lost, allow extra time for SI390 operations.



**Figure 368: Update Copy operation**

## Split Pair Operation

The SI390 split capability provides point-in-time backup of your data and also facilitates real data testing by making the SI390 copies (T-VOLs) available for host access. The SI390 split operation performs all pending T-VOL updates (those issued prior to the split command and recorded in the S-VOL track map) to make the T-VOL identical to the state of the S-VOL when the split command was issued. When the split operation is complete, the pair status changes to *split*, and you have full read/write access to the split T-VOL (even though it is still reserved). While the pair is split, the disk array establishes a differential bitmap for the split S-VOL and T-VOL, and records all updates to **both** volumes. When a split pair is

resynced, the disk array copies all flagged tracks from the S-VOL to the T-VOL. This method ensures that the S-VOL and T-VOL are correctly resynchronized and also reduces the time needed to resynchronize the pair.

Use the Split Volume Pair window (see [Splitting ShadowImage Pairs](#) on page 1073) to split existing SI390 pairs, or to add and split new SI390 pairs in one step.

- When splitting pairs, you can select the pace for the pending update copy operation(s): **slower**, **medium**, and **faster**. The slower pace minimizes the impact of SI390 operations on disk array I/O performance while the faster pace splits the pairs as quickly as possible.
- When splitting pairs, you can also select the split type: **Quick Split** or **Steady Split**.
  - When the quick split operation starts, the pair status changes to *V-split*, the T-VOL is available immediately for read and write I/Os, and the XP128/XP1024 performs all pending update copy operations to the T-VOL in the background. When the quick split operation is complete, the pair status changes to *split* and you have full read/write access to the split T-VOL (even though it is still reserved). The S-VOL also remains fully accessible.
  - When the steady split operation starts, the pair status changes to *SP-pending* and the XP128/XP1024 performs all pending update copy operations to the T-VOL. When the steady split operation is complete, the pair status changes to *split* and you have full read/write access to the split T-VOL (even though it is still reserved). The S-VOL also remains fully accessible.

When the pair status changes to *split*, the XP128/XP1024 establishes a track map for the split S-VOL **and** T-VOL and records all updates to **both** volumes. Split operations cannot be performed on suspended pairs.

---

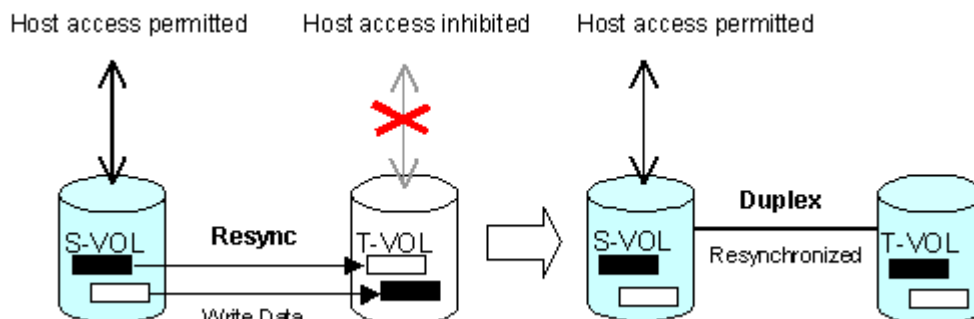
**Note:** Use the CSUSPEND and PPRCOPY SUSPEND commands to split SI390 volume pairs. For more information on using PPRC commands to perform SI390 operations on the XP128/XP1024, see [Using PPRC Commands for ShadowImage](#) on page 1094.

---

## Resynchronize Pair Operations (Normal, Quick, Reverse, Quick Restore)

SI390 performs four types of resync operations:

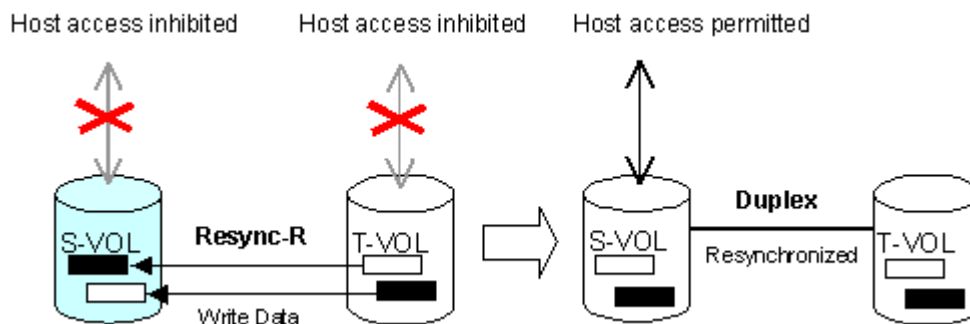
- Normal.** The normal resync operation (see the following figure) resynchronizes the T-VOL with the S-VOL. The copy direction for a normal resync operation is S-VOL to T-VOL. The pair status during a normal resync operation is *resync*, and the S-VOL remains accessible to all hosts for both read and write operations during a normal resync operation. The T-VOL becomes inaccessible to all hosts during a normal resync operation.
- Quick.** The quick resync operation (see the following figure) speeds up the normal resync operation without copying the S-VOL data to the T-VOL. The S-VOL and the T-VOL are resynchronized when update copy operations are performed for duplex pairs. The pair status during a quick resync operation is *resync*, and the S-VOL remains accessible to all hosts for both read and write operations. The T-VOL becomes inaccessible to all hosts during a quick resync operation.



**Figure 369: Normal and quick pair operations**

- Reverse.** The reverse resync operation (see the following figure) synchronizes the S-VOL with the T-VOL. The copy direction for a reverse resync operation is T-VOL to S-VOL. [Table 140](#) on page 1036 lists the operational requirements for the reverse resync operation. The pair status during a reverse resync operation is *resync-r*, and the S-VOL and T-VOL become inaccessible to all hosts for write operations during a reverse resync operation. As soon as the reverse resync operation is complete, the S-VOL becomes accessible. The reverse resync operation can be performed only on split pairs, not on suspended pairs.
- Quick Restore.** The quick restore operation (see the following figure) speeds up the reverse resync operation by changing the volume map in the XP128/XP1024 to swap the contents of the S-VOL and T-VOL without copying the T-VOL data to the S-VOL. The S-VOL and T-VOL are

resynchronized when update copy operations are performed for pairs in the *duplex* status. The pair status during a quick restore operation is *resync-r* until the volume map change is complete. The S-VOL and T-VOL become inaccessible to all hosts for write operations during a quick restore operation. [Table 140](#) on page 1036 lists the operational requirements for the quick restore operation.



**Figure 370: Reverse and quick restore pair operations**

During the quick restore operation, the RAID levels, Cache LUN XP settings, and HDD types of the S-VOL and T-VOL are exchanged. For example, if the S-VOL has a RAID-1 level and the T-VOL has a RAID-5 level, the quick restore operation changes the RAID level of the S-VOL to RAID-5 and of the T-VOL to RAID-1. To avoid any performance impact due to the quick restore operation:

1. Verify that the S-VOL and T-VOL have the same RAID level and HDD type before performing the quick restore operation. If you want to restore the original RAID levels after quick restore, stop host I/Os to the pair, split the pair, perform the quick restore operation for that pair again, and then restart the host I/Os to the pair.
2. Because the Cache LUN XP settings are exchanged during a quick restore operation, you must perform one of the two following operations. If you do not, the change of location of the cache residence areas may cause I/O performance to the Cache LUN XP data to be down.
  - a. Set the same Cache LUN XP settings (locations) for the source volume and target volume before performing the quick restore operation.

- b. Release the Cache LUN XP settings of the source and target volumes before the quick restore operation, and then reset the Cache LUN XP settings of the source and target volumes after the pair changes to *duplex* status as a result of the quick restore operation.

If you do not want the S-VOL and T-VOL to be resynchronized after the quick restore operation, you must set the Swap&Freeze option before performing the quick restore operation (see [Swap&Freeze Option](#) on page 1040 and [Setting ShadowImage Options](#) on page 1087).

**Table 140: Reverse and quick restore Pairresync requirements**

Parameter	Requirement(s)
Reverse resync or quick restore command.	The specified pair must be in the <i>split</i> state. If not, the reverse resync or quick restore command will be rejected. All other pairs that share the same S-VOL as the specified pair must also be in the <i>split</i> or <i>suspended</i> state. If not, the reverse resync or quick restore command will be rejected.
Reverse resync or quick restore command issued to a shared SI390/TC390 volume.	If the SI390 and TC390 pairs share the same volume (S-VOL = M-VOL, T-VOL = M-VOL, or S-VOL = R-VOL), and the TC390 pair is not in the <i>suspend</i> status, the reverse resync and quick restore operations cannot be performed. (The command will be rejected.) During the reverse resync or quick restore operation, a TC390 pair cannot be created. The TC390 add pair command will be rejected when the SI390 pair status is <i>resync-r</i> .
Effect on other pairs that share the S-VOL.	If the reverse resync or quick restore operation is performed on one SI390 pair in a 1-to-n configuration (n>1), the S-VOL and the other T-VOLs are no longer synchronized. While this reverse resync or quick restore is in progress, you cannot perform add, split, or resync pair for any other pair that shares the same S-VOL (delete pair and suspend pair are allowed).
Reverse resync or quick restore ends abnormally. OR Suspend pair is requested during reverse resync or quick restore.	<ol style="list-style-type: none"> <li>1. The pair status changes to <i>suspended</i>.</li> <li>2. The S-VOL of the <i>suspended</i> pair is read/write-enabled for all hosts; however, the data on the S-VOL is not guaranteed. The T-VOL of the suspended pair remains read/write-disabled.</li> <li>3. The status of other SI390 pairs that share the same S-VOL does not change.</li> </ol>

SI390 performs normal/quick resync operations on split and suspended pairs, but reverse resync operations can be performed only on split pairs:



- **Resync for split pair.** When a normal/quick resync operation is performed on a split pair, the XP128/XP1024 copies all differential data from the S-VOL to the T-VOL. When a reverse resync or quick restore operation is performed on a split pair, the disk array copies all differential data from the T-VOL to the S-VOL. This ensures that the S-VOL and T-VOL are properly resynchronized in the appropriate direction, and also greatly reduces the time needed to resynchronize the pair.
- **Resync for suspended pair.** When a normal/quick resync operation is performed on a suspended pair, the XP128/XP1024 copies all data on the S-VOL to the T-VOL because all S-VOL tracks were flagged as difference data when the pair was suspended. Reverse pairresync and quick restore operations cannot be performed on suspended pairs. The normal resync operation for suspended pairs is equivalent to and takes as long as the SI390 initial copy operation.

Use the Resynchronize Volume Pair window (see [Resynchronizing ShadowImage Pairs](#) on page 1078) to resynchronize split and suspended SI390 pairs. When the resync operation starts, the pair status changes to *resync* or *resync-r*. When the resync is complete, the pair status changes to *duplex*. The XP128/XP1024 resumes SI390 update copy operations after the pair status changes to *duplex*. The S-VOL remains fully accessible during a normal/quick resync operation, but becomes inaccessible to all hosts during a reverse resync or quick restore operation. This ensures that the data on the S-VOL is identical to the data on the T-VOL when the reverse resync or quick restore operation completes.

When resynchronizing pairs, you can select the pace for the resync operation(s): slower, medium, and faster. The slower pace minimizes the impact of SI390 operations on disk array I/O performance, while the faster pace resynchronizes the pair(s) as quickly as possible. The quick resync option provides the fastest normal resync operation.

---

**Note:** Use the CESTPAIR and PPRCOPY ESTPAIR commands to resynchronize split SI390 volume pairs. For more information on using PPRC commands to perform SI390 operations on the XP128/XP1024, see [Using PPRC Commands for ShadowImage](#) on page 1094.

After an SI390 reverse resync or quick restore operation is performed, verify that the pair status changes to duplex before performing a TC390 resume pair operation. If you perform the TC390 resume pair operation before the pair status changes to duplex, the command (resume pair operation) will be rejected.

---

## Suspend Pair Operation

The SI390 suspend pair operation suspends the update copy operations to the T-VOL of the pair. An SI390 pair can be suspended by the user at any time. When an SI390 pair is suspended, the XP128/XP1024 stops performing update copy operations to the T-VOL, continues accepting write I/O operations to the S-VOL, and marks the entire S-VOL track as difference data. When a resync operation is performed on a suspended pair, the entire S-VOL is copied to the T-VOL. Reverse resync and quick restore cannot be performed on suspended pairs. While the resync operation for a split pair can be very fast, the resync operation for a suspended pair will take as long as the initial copy operation.

The XP128/XP1024 will automatically suspend an SI390 pair when it cannot keep the pair mirrored for any reason. When the XP128/XP1024 suspends a pair, sense information is generated to notify the host. The XP128/XP1024 will automatically suspend an SI390 pair under the following conditions:

- When the XP128/XP1024 detects an error condition related to an update copy operation.
- When the S-VOL and/or T-VOL track map in shared memory is lost (for example, due to offline microprogram exchange). This applies to *SP-pend* and *V-split* pairs only. For *duplex*, *split*, *resync*, or *resync-r* pairs, the pair is not suspended but the entire S-VOL (T-VOL for reverse resync) is marked as difference data.

Use the Suspend Volume Pair window (see [Suspending ShadowImage Pairs](#) on page 1081) to suspend SI390 pairs. When a pair is suspended, the pair status changes to *suspended*. When the resync operation starts, the pair status changes to *resync*. The S-VOL remains fully accessible while suspended and during the resync operation. Use the Resynchronize Volume Pair window (see [Resynchronizing ShadowImage Pairs](#) on page 1078) to resynchronize suspended SI390 pairs.

---

**Note:** The PPRC commands do not support the SI390 suspend operation. You must use the SI390 remote console software to suspend SI390 pairs. The CSUSPEND and PPRCOPY SUSPEND commands execute an SI390 split operation instead of a suspend operation. For more information on using PPRC commands to perform SI390 operations on the XP128/XP1024, see [Using PPRC Commands for ShadowImage](#) on page 1094.

---

## Delete Pair Operation

The SI390 delete pair operation stops the SI390 update copy operations to the T-VOL of the pair and changes the pair status of both volumes to *simplex*. An SI390 pair can be deleted by the user at any time except during the quick split operation (that is, any status except *simplex* and *V-split*). After you delete an SI390 pair, the T-VOL is still not available for write operations until the reserve attribute is reset.

Use the Delete Volume Pair window (see [Deleting ShadowImage Pairs](#) on page 1083) to delete SI390 pairs. When an SI390 pair is deleted, pending update copy operations for the pair are discarded, and the status of the S-VOL and T-VOL is changed to *simplex*.



**Caution:** The T-VOL of a duplex pair may not be identical to its S-VOL, due to the asynchronous SI390 update copy operations. To synchronize the volumes before deleting the pair, you must split the pair first (see [Deleting ShadowImage Pairs](#) on page 1083 for instructions).

## ShadowImage Options

By using the SI390 options, you can extend the standard SI390 operations such as the add pair and resync pair operations. The following table shows the options that are currently available.

**Table 141: Types of ShadowImage options**

No.	Option Type	Requirement
1	Swap&Freeze	The SI390 quick restore operation can be performed on the XP128/XP1024. If the XP128/XP1024 setting disables the quick restore operation, you must change the setting to use the Swap&Freeze option. Refer to <a href="#">Swap&amp;Freeze Option</a> on page 1040.
2	Host I/O Performance	Refer to <a href="#">Host I/O Performance Option</a> on page 1041.
2 - 32	Reserved (Currently unavailable.)	-

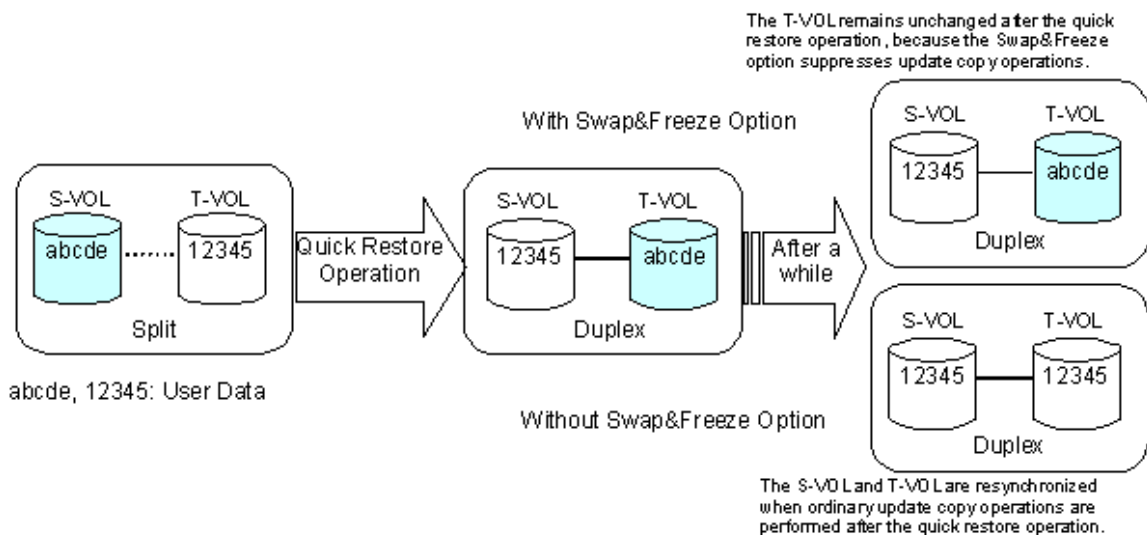
**Note:** Available option types depend on the XP128/XP1024 settings.

## Swap&Freeze Option

The Swap&Freeze option allows the S-VOLs of an SI390 pair to remain unchanged after the quick restore operation. If the quick restore operation is performed on an SI390 pair with the Swap&Freeze option, update copy operations are suppressed, and thus are not performed for pairs in the duplex status after the quick restore operation. If the quick restore operation is performed without the Swap&Freeze option, the S-VOL and T-VOL are resynchronized when update copy operations are performed for pairs in the duplex status.

**Note:** Verify that the Swap&Freeze option remains in effect until the pair status becomes duplex after the quick restore operation.

The following figure shows the state of the T-VOL after the quick restore operation with or without the Swap&Freeze option.



**Figure 371: Quick Restore operation with or without Swap&Freeze option**

## Host I/O Performance Option

The Host I/O Performance option improves host I/O responses over SI390 copying processing time. When the Host I/O Performance option is used, the disk array suppresses execution of SI390 copying processing, and consequently the host I/O responses improve.

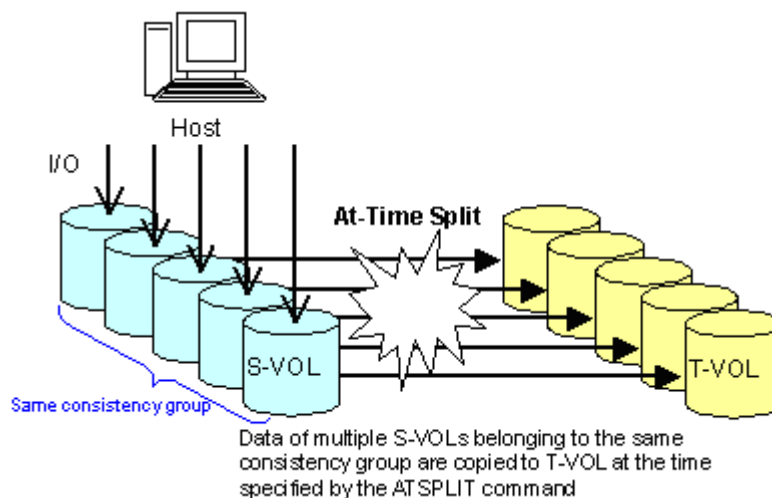
When SI390 copying processing is suppressed by the Host I/O Performance option, the time taken for copying increases. Also, if BC pairs exist, host I/O responses might not be faster. In this case, set the Host I/O Performance option for BC as well.

## At-Time Split Function

If the XP disk array has firmware version 21.06.22 or later installed, you can take advantage of the SI390 At-Time Split function, which can be applied to SI390 pairs that belong to a consistency group. This function copies data from S-VOL into T-VOL at the Split time you specify by executing the ATSPPLIT command to one or more SI390 pairs belonging to the same consistency group.

A SI390 consistency group is a user-defined set of SI390 volume pairs used for the At-Time Split function and have the following restrictions:

- You can configure up to 128 consistency groups in a disk array, including the BC consistency groups.
- A number (0-127) is assigned to each consistency group. You can specify a consistency group number when you create SI390 pairs.
- You can view the ID of the consistency groups used as the pair unit using Command View or by executing the ATQUERY command.
- You can define up to 1,024 SI390 pairs in a consistency group.
- SI390 pairs and BC pairs cannot co-exist in the same consistency group.



**Figure 372: Outline of the At-Time Split function**

The SI390 At-Time Split function can be used only by executing the PPRC TSO commands.

**To use the SI390 At-Time Split function by executing the PPRC TSO commands:**

1. Specify the ID of the consistency group you intend to use with Command View.
2. Use the TSO ESTPAIR command to create a pair by specifying the ID of the consistency group you intend to use in this command.
3. Use the AT SPLIT command to specify the ID of the consistency group and the time to execute the Split operation. By executing the AT SPLIT command, the Split time you specified will be registered.
4. After the Split time specified in the AT SPLIT command has passed, use the AT QUERY command to confirm that the pairs in the consistency group specified in the AT QUERY command have all changed their status to Split.
5. Specify the parameter CANCEL in the AT SPLIT command. By executing the AT SPLIT command where you specified the parameter CANCEL, the Split time that you have registered will be reset.

For more information about using the AT SPLIT command, see [Setting and Resetting the At-Time Split Time: AT SPLIT](#) on page 1113. For details on the method of using the AT QUERY command, see [Displaying the Status of the Consistency Group: AT QUERY](#) on page 1115.

When you execute the ATSPPLIT command, confirm beforehand that the status of all the pairs in the consistency group that you specified is either Pending or Duplex, or the ATSPPLIT command will be rejected.

If you execute the ATSPPLIT command more than once, the ATSPPLIT command you have executed last is the one that is valid.

You can perform operations for the pairs in the consistency group to which you registered the Split time only when the pairs are in the Delete Pair or Suspend status. If you perform an Add Pair, Split, or Pair Resync operation, the ATSPPLIT command will be rejected. To perform an Add Pair, Split, or Pair Resync operation, you must first reset the registration of the Split time by executing the ATSPPLIT command in which you specified the CANCEL parameter.

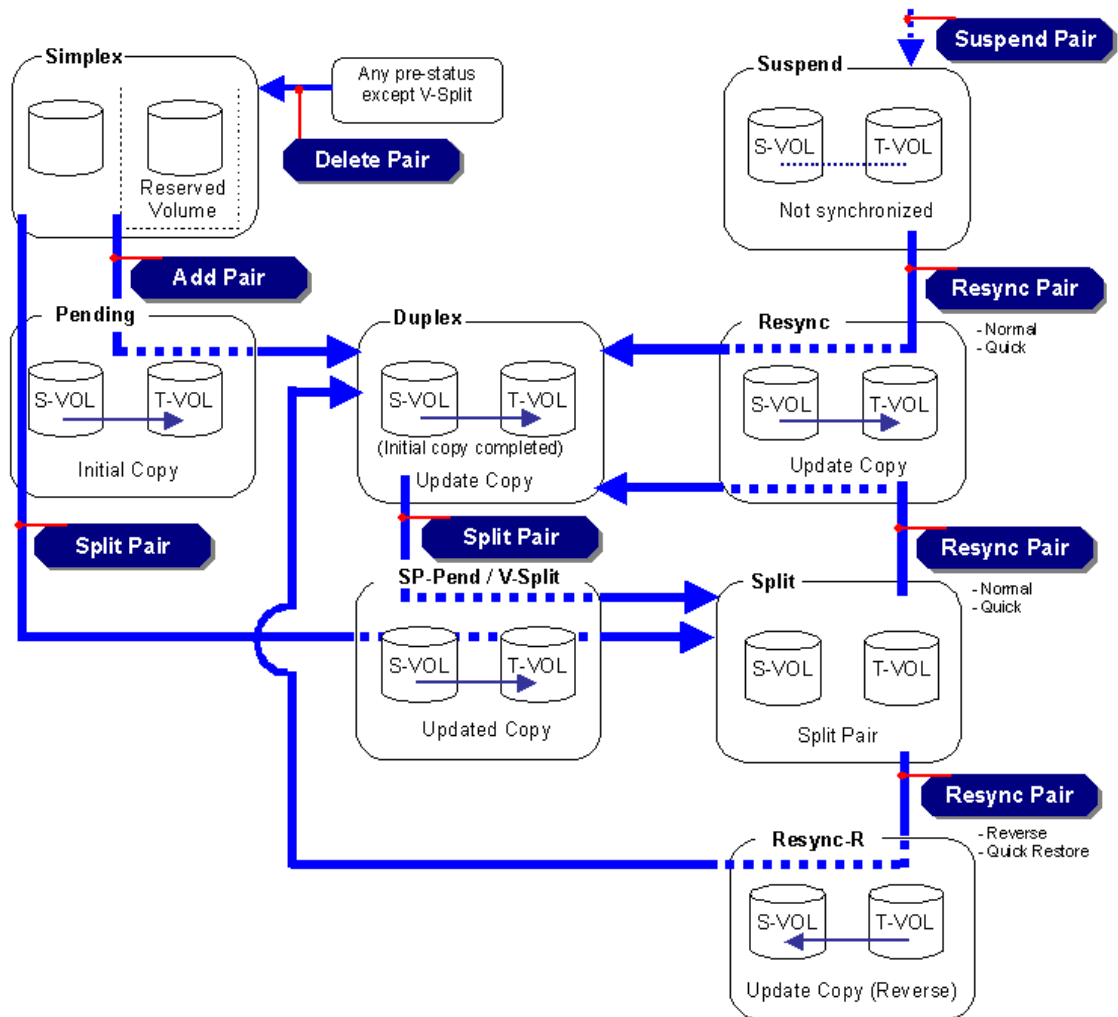
When you execute the ATSPPLIT command, confirm beforehand that no S-VOL in the consistency group you specified is used as a TC390 R-VOL, or the ATSPPLIT command will be rejected.

Confirm beforehand that the timer of the host that issues the ATSPPLIT command is correctly set. If not, the data copied to the T-VOL after the Split operation cannot be guaranteed to be the same as the data stored in the S-VOL at the time specified by the ATSPPLIT command you have executed last.

The Split time that you set by executing the ATSPPLIT command will be reset by executing PS OFF.

## ShadowImage Pair Status

The SI390 remote Command View Java applet program displays the SI390 pair status of all S/390 volumes under the specified CU image of the connected XP128/XP1024. The following figure illustrates the pair status transitions and the relationship between the pair status and the SI390 operations.



**Figure 373: ShadowImage pair status transitions**

If a volume is not assigned to a pair, its status is *simplex*. When you add an SI390 pair, the status of the S-VOL and T-VOL changes to *pending*. When the initial copy operation is complete, the pair status becomes *duplex*. If the XP128/XP1024 cannot maintain *duplex* status for any reason, or if you suspend the pair, the pair status changes to *suspend*. When you split a pair, the pair status changes to *SP-pending* for steady split or *V-Split* for quick split. When the split is complete,



the pair status changes to *split* and you can access the split T-VOL. When you start a resync operation, the pair status changes to *resync* and the T-VOL becomes inaccessible. When you specify reverse resync or quick restore, the pair status changes to *resync-r*, and the T-VOL and S-VOL are inaccessible during reverse resync/quick restore. When the resync is complete, the pair status changes to *duplex*. When you delete a pair, the pair status changes to *simplex*.

The following table shows the allowable operations for each pair status. [Table 143](#) lists and describes the SI390 pair status conditions.

**Table 142: Pair status versus allowable operations**

Operation	Pair Status								
	Simpl.	Pend.	Duplex	SP-Pend	V-Split	Split	Resync	Resync-R	Susp.
Split Pair	OK	OK	OK	x	x	x	x	x	x
Suspend Pair	x	OK	OK	OK	OK	OK	OK	OK	x
Resync Pair	x	x	x	x	OK	OK	x	x	OK
Reverse Resync Quick Restore	x	x	x	x	x	OK	x	x	x
Delete Pair	x	OK	OK	OK	x	OK	OK	OK	OK

**Table 143: ShadowImage pair status**

Status	Description	Host Status	S-VOL Access	T-VOL Access
Simplex	The volume is not assigned to an SI390 pair. The XP128/XP1024 accepts read and write I/Os for all <i>simplex</i> volumes that are not reserved.	S-VOL = SIMPLEX T-VOL = SIMPLEX	N/A There is no S-VOL yet.	N/A There is no T-VOL yet.
Pending	The initial copy operation is in progress. The XP128/XP1024 continues to accept read and write operations for the S-VOL, but stops accepting writes for the T-VOL. No update copy operations are performed.	S-VOL = PPRI-PNDG T-VOL = PSEC-PNDG	Read/write.	Read/write disabled.

**Table 143: ShadowImage pair status (Continued)**

Status	Description	Host Status	S-VOL Access	T-VOL Access
Duplex	The initial copy operation is complete and the XP128/XP1024 starts performing asynchronous update copy operations from the S-VOL to the T-VOL as needed. The S-VOL and T-VOL of a duplex pair may not be identical. The XP128/XP1024 rejects all write I/Os for T-VOLs with the status <i>duplex</i> .	S-VOL = PPRIMARY T-VOL = PSECONDRY	Read/write.	Read/write disabled.
SP-Pend	The status becomes <i>SP-Pend</i> when the Steady Split mode is selected for the split operation. All S-VOL updates prior to the split command are being copied to the T-VOL. When these updates are complete, the split T-VOL is identical to the state of the S-VOL when the split started. The XP128/XP1024 rejects writes for <i>SP-Pend</i> T-VOLs.	S-VOL = PPRI-PNDG T-VOL = PSEC-PNDG	Read/write.	Read/write disabled.
V-Split	The status becomes <i>V-Split</i> when the Quick Split mode is selected for the split operation. Only the S-VOL differential data is being copied to the T-VOL in background. The XP128/XP1024 accepts writes for <i>V-Split</i> T-VOLs. The <i>V-Split</i> pairs cannot be deleted.	S-VOL = PPRI-SUSP T-VOL = SIMPLEX	Read/write.	Read/write, can be varied online.
Split	The XP128/XP1024 stops performing update copy operations for split pairs and starts accepting write I/Os for split T-VOLs. The XP128/XP1024 keeps track of all updates to the split S-VOL and T-VOL so the pair can be resynced accurately and quickly.	S-VOL = PPRI-SUSP T-VOL = SIMPLEX	Read/write.	Read/write, can be varied online.

**Table 143: ShadowImage pair status (Continued)**

Status	Description	Host Status	S-VOL Access	T-VOL Access
Resync	The XP128/XP1024 does not accept write I/Os for <i>resync</i> T-VOLs. When a split pair is resynchronized in normal mode, only the S-VOL differential data is copied to the T-VOL. When a suspended pair is resynchronized, the entire S-VOL is copied to the T-VOL. No update copy operations are performed during resync operation.	S-VOL = PPRI-PNDG T-VOL = PSEC-PNDG	Read/write.	Read/write disabled.
Resync-R	The XP128/XP1024 does not accept write I/Os for <i>resync-r</i> T-VOLs or S-VOLs. When a split pair is reverse resynchronized, the XP128/XP1024 copies only the T-VOL differential data to the S-VOL. The reverse resync cannot be performed on suspended pairs. No update copy operations are performed during reverse resync or quick restore.	S-VOL = PPRI-PNDG T-VOL = PSEC-PNDG	Read/write disabled.	Read/write disabled.
Suspend	The XP128/XP1024 continues accepting read and write I/Os for a suspended S-VOL, but does not perform update copy operations to a suspended T-VOL. The XP128/XP1024 marks the entire S-VOL track map as differential data so the entire S-VOL is copied to the T-VOL when the pair is resumed. Use resync command to resume a suspended pair. Reverse resync and quick restore cannot be used to resume suspended pairs.	S-VOL = PPRI-SUSP T-VOL = PSEC-SUSP	Read/write.	Read/write disabled.

## Cautions on Switching Off the Power Supply

If you need to switch off the power supply of the disk array during SI390 operations, make sure to:

- Complete copying for the SI390 pair in the SP-pend status first to change the pair status from SP-pend to split, and then switch off the power supply. If the shared memory is volatilized when you switch on the power supply again, the pair in the SP-pend status changes to suspend.
- Establish a timetable for SI390 copying operations. If the shared memory is volatilized when you switch on the power supply again, the following conditions occur:
  - If the SI390 pair was in the pending or resync status, data that was already copied becomes the target data to be copied after the power supply is turned back on. Even if there is no host I/O, the data consistency rate does not reach 100% when the SI390 pair status changes to duplex. When the SI390 pair status changes to duplex, the target data is copied to the target volume.
  - If the SI390 pair was in the duplex status, data that was already copied becomes the target data to be copied after the power supply is turned back on. In this case, the data consistency rate is 0%, and the target data is copied to the target volume.
  - If the SI390 pair was in the split status, the entire volume becomes the differential data. In this case, the data consistency rate is 0%, and the entire volume is copied to the target volume when you perform the resync pair operation.

# Preparing for ShadowImage Operations

## System Requirements

SI390 operations involve the XP128/XP1024 containing the source and target volumes, the SI390 feature enabled on the Command View management station, and (optional) the S/390 host PPRC software functions. The SI390 system requirements are:

- XP128/XP1024. All XP128/XP1024 hardware, microcode, and software required for SI390 operations must be installed and enabled.
- Command View management station (user-supplied Windows-based PC).

---

**Note:** You must operate the Command View management station in Modify mode to perform SI390 operations. Users in view mode can only view SI390 information.

---

- SI390 feature license key installed.

## Preparing for ShadowImage Operations

To ensure that the XP128/XP1024 is ready for SI390 operations, perform the following tasks:

- SI390 operations affect the I/O performance of the XP128/XP1024 because of the additional write operations to the T-VOLs. If you have not already done so, you should consider the relative importance of the disk array's I/O performance and the backup SI390 copies. For example, assigning three T-VOLs to each S-VOL takes more resources than assigning only one or two. You can also use the SI390 copy pace option to reduce the impact of the SI390 initial copy operations. Using a slower copy pace minimizes the impact of SI390 operations on I/O performance, while a faster copy pace produces point-in-time copies more quickly but may affect I/O performance. The SI390 initial copy operation is performed only once to each T-VOL (unless the pair is suspended).
- Identify the volumes (LDEVs) that will be the SI390 volumes. For each volume, write down the CU image and LDEV ID, whether the volume will be an S-VOL or T-VOL, and the other volume(s) in its pair (see [Table 144](#) on page 1050 for a sample table). The S-VOLs will remain fully accessible to all hosts throughout normal SI390 operations (except during reverse resync and

quick restore). The T-VOLs will need to be varied offline before being reserved for SI390 operations. After assigned to a pair, a T-VOL rejects all write I/Os, except when the pair is split.

- SI390 and TC390 can function together in the same XP128/XP1024 to provide both internal and remote backup for your important data. If you are planning to combine SI390 and TC390, read the important configuration information in the next section.

**Table 144: Sample table for ShadowImage configuration information**

CU #	LDEV	S-VOL?	Associated T-VOL(s)	T-VOL?	Associated S-VOL
0	00	Yes	0:10, 0:11	No	--
0	01	Yes	0:12, 0:13	No	--
etc.	...	...	...	...	...
0	0F	Yes	0:2E, 0:2F	No	--
0	10	No	--	Yes	0:00
0	11	No	--	Yes	0:00
0	12	No	--	Yes	0:01
etc.	...	...	...	...	...

## Combining ShadowImage with Other Data Management Operations

SI390 supports concurrent operations with the following data management functions:

- **Virtual LVI/LUN.** Virtual LVI/LUN volumes can be assigned to SI390 pairs provided that the T-VOL has the same capacity as the S-VOL. If you need to perform Virtual LVI/LUN operations on an existing SI390 S-VOL or T-VOL, you must delete the pair first to return the volume to *simplex* status.
- **Cache LUN XP.** Cache LUN XP volumes can be assigned to SI390 pairs, and Cache LUN XP operations can be performed on existing SI390 S-VOLs and T-VOLs.



**Caution:** For important information on performing quick restore operations on Cache LUN XP volumes, see [Resynchronize Pair Operations \(Normal, Quick, Reverse, Quick Restore\)](#) on page 1033.

- **TC390.** TC390 volumes can be assigned to SI390 pairs and SI390 volumes can be assigned to TC390 pairs. For important information on SI390 and TC390 shared volume configurations, refer to [Combining ShadowImage and TrueCopy Operations](#) on page 1052.

---

**Note:** SI390 is recommended for intra-disk array copy operations. If SI390 is not installed, TC390 (synchronous only) can be used to copy within the same XP128/XP1024. This TC390 configuration requires at least one external Fibre Channel interface cable loop (minimum of two is recommended).

---

- **HXRC.** If SI390 S-VOLs and HXRC source volume (original data) share the same volumes, you cannot perform the reverse resync or quick restore operation for those volumes. Do not use HXRC target volumes (copied data) for SI390 volumes.
- **HP Auto LUN.** SI390 volumes can be assigned to migration volumes of HP Auto LUN. However, if the SI390 S-VOL is already paired with three T-VOLs, you must delete the SI390 pairs before migrating the volumes by using Auto LUN. Also, if you want to assign SI390 volumes to destination volumes of migration by using Auto LUN, or reserve SI390 volumes for Auto LUN, you must delete the SI390 volumes or unreserve SI390 volumes before using the volumes. If you assign an SI390 S-VOL that is already paired with three T-VOLs to migration volumes of Auto LUN or assign SI390 volumes to other Auto LUN volumes than migration volumes, the command will be rejected.

Also, if you split the SI390 pair that is assigned to Auto LUN migration volumes, migration of those volumes will be canceled.

---

**Note:** You cannot use migration volumes, destination volumes, and reserved volumes of Auto LUN for SI390 pair operations because the command will be rejected. If you want to use Auto LUN volumes for SI390 pair operations, you must release the volumes by using Auto LUN.

---

- **SANtinel - S/390.** SANtinel operations do not directly affect SI390 operations. Secure LDEVs can be assigned to SI390 pairs, and SI390 volumes can be secured. A secure LDEV will accept SI390 initial and update copy

operations. When an S-VOL is secured by SANTinel, this setting does not apply to the corresponding T-VOLs. SANTinel T-VOLs cannot be accessed by any host except when the pair is split.

## Combining ShadowImage and TrueCopy Operations

SI390 and TC390 can function together in the same XP128/XP1024 to provide both internal and remote backup for your important data.

- When SI390 and TC390 pairs share the same volume, to obtain the SI390 pair status, query from the host:
  - The T-VOL status of the SI390 pair if the SI390 S-VOL and TC390 M-VOL share the same volume.
  - The T-VOL status of the SI390 pair if the SI390 S-VOL and TC390 R-VOL share the same volume.
  - The S-VOL status of the SI390 pair if the SI390 T-VOL and TC390 M-VOL share the same volume.
- SI390 supports multiple T-VOLs for each S-VOL. If you issue a pair status query to an SI390 S-VOL, the status for only one SI390 pair is reported (the pair with the T-VOL with the lowest LDEV ID). To obtain the pair status for the SI390 pair(s) with the other T-VOL(s), you must direct the host query to the specific T-VOL using the T-VOL's LDEV ID in the host command. The SI390 remote console software displays the LDEV ID and SI390 pair status of all T-VOLs associated with an S-VOL.
- Reverse resync and quick restore operations can be performed on shared SI390/TC390 pairs only when the TC390 pair is suspended.

The following table describes the host pair status reporting for SI390 volumes, TC390 volumes, and SI390/TC390 shared volumes. [Table 146](#) on page 1053 lists the currency of the data on shared SI390/TC390 volumes based on the SI390 and TC390 pair status.

**Table 145: Host pair status reporting for SI390/TC390 shared volumes**

Number of SI390 S-VOLs	Number of TC390 Pairs	Pair Status Reported by XP128/XP1024
0	0	Simplex
1	0	SI390 pair status
2 or more	0	SI390 pair status for the pair whose T-VOL has the lowest LDEV ID



**Table 145: Host pair status reporting for SI390/TC390 shared volumes (Continued)**

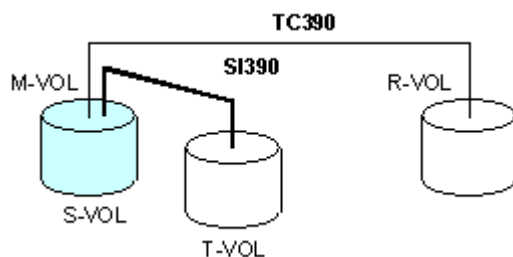
Number of SI390 S-VOLs	Number of TC390 Pairs	Pair Status Reported by XP128/XP1024
0	1	TC390 pair status
1	1	TC390 pair status
2 or more	1	TC390 pair status

**Table 146: Currency of a shared SI390 and TC390 volume**

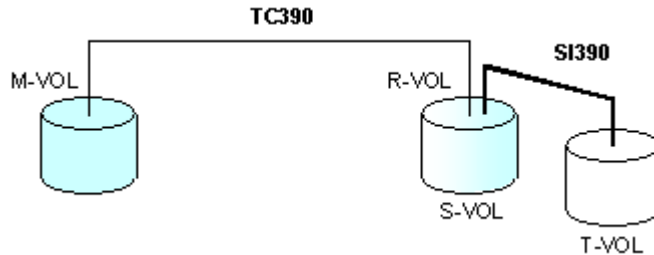
SI390 Pair Status	TC390 Pair Status		
	Pending	Duplex	Suspended
Pending	Not current	Not current	Not current
Duplex	Not current	Not current	CURRENT
SP-Pending	Not current	Not current	CURRENT
V-Split	Not current	Not current	CURRENT
Split	CURRENT	CURRENT	CURRENT
Resync	Not current	Not current	CURRENT
Resync-r	-	-	CURRENT
Suspended	Not current	Not current	Not current

The configuration shown in the following figure is an example of a volume that is functioning as both an SI390 S-VOL and a TC390 M-VOL. With this configuration, you can:

- Use SI390 to provide on-site backup copies of TC390 M-VOLs.
- Use TC390 to provide remote backup copies of SI390 S-VOLs.

**Figure 374: SI390 and TC390: shared S-VOL/M-VOL**

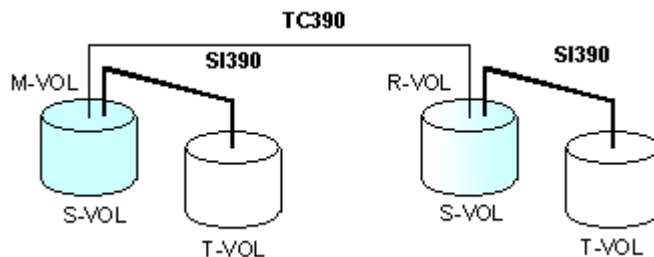
The configuration shown in the following figure is an example of a volume that is functioning as both an SI390 S-VOL and a TC390 R-VOL. With this configuration, you can use SI390 to provide additional remote copies of TC390 M-VOLs.



**Figure 375: SI390 and TC390: shared S-VOL/R-VOL**

The configuration shown in the following figure is an example of a volume that is functioning as both a TC390 M-VOL and an SI390 S-VOL, while the R-VOL of the same TC390 pair is also functioning as the S-VOL of another SI390 pair. With this configuration, you can:

- Use SI390 to provide on-site backup copies of TC390 M-VOLs and R-VOLs.
- Use TC390 to provide remote backup of SI390 S-VOLs.

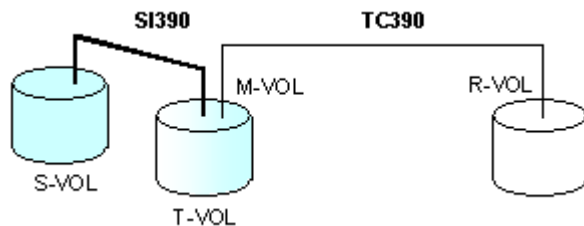


**Figure 376: SI390 and TC390: shared S-VOL/M-VOL and S-VOL/R-VOL**

The configuration shown in the following figure is an example of a volume functioning as both an SI390 T-VOL and a TC390 M-VOL.

**Note:** This configuration does not allow SI390 and TC390 to copy at the same time. Add the SI390 pair first, and then split the pair before creating the TC390 pair. You must suspend the TC390 pair to resync the SI390 pair. The TC390 pair status cannot be changed when the SI390 pair is in the V-Split status.


You cannot distinguish the Split status from the V-Split status with the PPRC command. When you use the SI390 and TC390 shared configuration shown in the following figure, you must either use the PPRC command to perform the Steady Split operation or use the Remote Console PC to confirm the pair statuses. You can perform the Steady Split operation by specifying the CSUSPEND parameters (Byte 7 = 'M', Byte 8 = 'P', Byte 9 = 'S'). For details about the PPRC commands, refer to [Using PPRC Commands for ShadowImage](#) on page 1094.

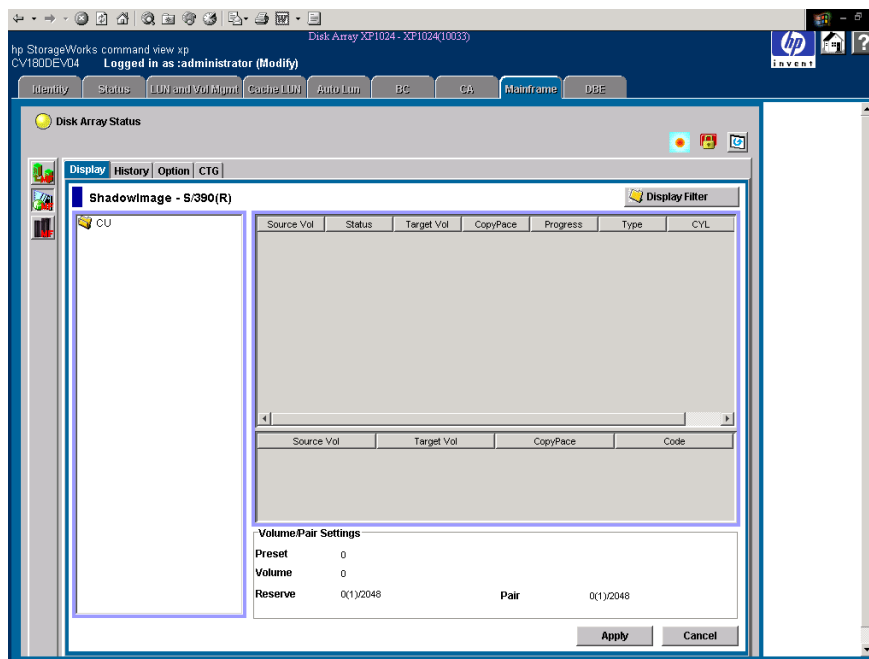


**Figure 377: SI390 and TC390: shared T-VOL/M-VOL**

## Starting ShadowImage

### To start SI390:

1. From the Launch screen, click an XP128 or XP1024.
2. Click the **Mainframe** tab, and then click the **ShadowImage** button (  ). The ShadowImage main screen displays the name of the connected XP128/XP1024, the currently selected CU image, and all of the volumes (LDEVs) installed under the current CU image.



**Figure 378: ShadowImage main screen**

To perform SI390 operations, first reserve the volumes that you plan to use as SI390 T-VOLs (see [Setting the Reserve Attribute](#) on page 1066 for instructions), and then start adding the SI390 pairs (see [Adding ShadowImage Pairs](#) on page 1069 for instructions).

## ShadowImage Main Screen

There are four tabs that you can access in ShadowImage: **Main**, **History**, **Options**, and **CTG** tabs.

---

**Note:** The **CTG** tab and its features are available only if the XP disk array has firmware version 21.07.04 or later installed.

---

This section discusses the **Main** tab. For information about the **History** tab, see [Viewing ShadowImage Pair Status and History](#) on page 1085; for the **Options** tab, see [Setting ShadowImage Options](#) on page 1087; and for the **CTG** tab, see [CTG Screen](#) on page 1089.

Clicking the **Main** tab displays the ShadowImage main screen. This screen displays SI390 volume and pair information for the selected CU image of the connected XP128/XP1024 and performs all SI390 operations.




The ShadowImage main screen contains the following items:


- Use the **Tree View** box, on the left side of the screen, to select a CU image or defined S-VOL (LDEV ID).

---

**Note:** You can filter the volumes or volume pairs displayed in the Volume List box in the upper-right corner of the **Main** tab, by selecting a CU image or a volume (LDEV ID) at a time. To display all volumes and pairs, select **CU** on the top of the Tree View box.

---

- The **Volume List** box, on the upper-right side of the screen, displays all available volumes on the CU image selected in the Tree View box. You can sort the volumes by source volume (CU:LDEV), status, target volume (CU:LDEV), copy pace, progress of copying, device emulation type, and cylinder (capacity). You can also filter the volumes by reserve attribute, by pair condition, and pair status, in the Display Filter window. To open the Display Filter window, click **Display Filter**.
- The following icons indicate the status of a volume or pair on the ShadowImage screens:
  - : S-VOL
  - : T-VOL
  - : Reserved volume

- : An error occurred during operations. This error icon is displayed in the Preset Volume List box on the ShadowImage main screen.
- Clicking the **Display Filter** button filters the volumes displayed in the Volume List box.
- The **Preset Volume List** box, which is under the Volume List box, displays the specified operations (volume/pair information). These operations have not been performed in the XP128/XP1024.

---

**Note:** You can use the Preset Volume List box to hold multiple settings of the same operation (for example, Add Pair) only. You cannot display different types of operations (for example, Split Pair and Resync Pair) in the Preset Volume List box at the same time. You can also cancel the operations in the Preset Volume List box. For information on the Preset Volume List box, refer to [The Preset Volume List Box](#) on page 1064.

---

- The **Volume/Pair Settings** box displays:
  - **Preset:** The number of operations (volume/pair information) that have not been performed in the XP128/XP1024. The Preset Volume List box, which is located below the Volume List box, displays the preset operations. Click **Apply** to perform the specified operations displayed in the Preset Volume List box.
  - **Volume:** The total number of volumes defined in the XP128/XP1024.
  - **Reserve:** X(Y)/Z, where
    - X = total number of SI390 reserved volumes
    - Y = total number of SI390 and SI reserved volumes
    - Z = maximum allowable number of reserved volumes
  - **Pair:** X(Y)/Z, where
    - X = total number of SI390 pairs
    - Y = total number of SI390 and SI pairs
    - Z = maximum number of pairs (SI390/SI/Auto LUN)

---

**Note:** The value (Y) does not include Auto LUN XP pairs. If Auto LUN pairs exist, it is possible for the SI390 add pair operation to fail even if (Y) is less than 4,096.

---

- The **Apply** button performs the SI390 operations displayed in the Preset Volume List box. If the specified operations complete successfully, the Preset Volume List box will be cleared. If an error occurs during an operation, an

icon (🔴) is displayed and the failed operation will remain in the Preset Volume List box. You can display the error code and message for the failed operation by clicking the **Detail** command.

- The **Cancel** button cancels all operations specified in the Preset Volume List box.
- The **Refresh** button (🔄) updates the information displayed on the ShadowImage main screen.

To perform SI390 operations for one or more volumes, select the volume(s) in the Volume List box, right-click to display the pop-up menu commands (**Detail**, **Add Pair**, **Split Pair**, **Resync Pair**, **Suspend Pair**, **Delete Pair**, **Change Reserve**, and **Display Filter**), and then click the appropriate command (see [The Volume List Box](#) on page 1059).

For more information about the **History** and **Options** tabs of the ShadowImage main screen, refer to [Viewing ShadowImage Pair Status and History](#) on page 1085 and [Setting ShadowImage Options](#) on page 1087.

## The Volume List Box

The Volume List box displays volume/pair information based on the filter options you select in the Tree View box. You can also filter the volumes by reserve attribute, by pair condition, and pair status by clicking **Display Filter**.

Source Vol	Status	Target Vol	CopyPace	Progress	Type	CYL	CTG
02:00	Simplex	---	---	---	3390-9	10017	---
02:01	Split	02:02	---	15%	3390-9	10017	1F
02:01	Split	02:03	---	15%	3390-9	10017	---
02:04	Simplex	---	---	---	3390-9	10017	---
02:05	Simplex	---	---	---	3390-9	10017	---
02:06	Simplex	---	---	---	3390-9	10017	---
02:07	Simplex	---	---	---	3390-9	10017	---
02:08	Simplex	---	---	---	3390-9	10017	---
02:09	Simplex	---	---	---	3390-9	10017	---
02:0A	Simplex	---	---	---	3390-9	10017	---
02:0B	Simplex	---	---	---	3390-9	10017	---
02:0C	Simplex	---	---	---	3390-9	10017	---
02:0D	Simplex	---	---	---	3390-9	10017	---

**Figure 379: Volume List box**

The Volume List box lists all installed volumes (LDEVs) on the selected CU image and displays the following information for each volume:

- **Source Vol:** The CU:LDEV (control unit image:logical device ID) of the source volume (S-VOL).
- **Status:** The SI390 pair status of the volume pair: **Simplex, Pending, Duplex, Split, Resync, Suspend, SP-Pend, Resync-R, or V-Split.**
- **Target Vol:** The CU:LDEV (control unit image:logical device ID) of the T-VOL. If there is no T-VOL, --- is displayed.
- **Copy Pace:** The specified copy pace (**Slower, Medium, or Faster**) is displayed.
- **Progress:** The information according to the pair status is displayed as shown in the following table.

**Table 147: Displayed information in progress**

Pair Status	Displayed Information
Simplex	- - - is displayed.
Pending	The progress (%) of copying.
Duplex	Identical data (%) of S-VOL and T-VOL.
SP-Pend	Copy completed data (%).
V-Split	Copy completed data (%).
Split	Identical data (%) of S-VOL and T-VOL.
Resync	Identical data (%) of S-VOL and T-VOL.
Resync-R	Identical data (%) of S-VOL and T-VOL.
Suspend	- - - is displayed.
F-Copy	Copy completed data (%).

- **Type:** The device emulation type (for example, 3390-9, 3390-3R, or 3390-3A/B/C).
- **CYL:** The number of cylinders assigned to the volume.
- **CTG:** The registered ID of the consistency group.

You can perform SI390 operations for the volume(s) in the Volume List box by using the following pop-up menu commands, which you can display by right-clicking with the mouse:



**Table 148: List of ShadowImage pop-up menu commands**

Command	Feature
Detail	Opens the Detail window, which displays information for the selected volume or pair.
Add Pair	Opens the Add Pair Dialog window, which creates (adds) new SI390 pairs.
Split Pair	Opens the Split Volume Pair window, which splits SI390 pairs.
Resync Pair	Opens the Resync Volume Pair window, which resynchronizes SI390 pairs.
Suspend Pair	Opens the Suspend Volume Pair window, which suspends SI390 pairs.
Delete Pair	Opens the Delete Volume Pair window, which deletes SI390 pairs.
Change Reserve	Opens the Set/Reset Reserve Attribute window, which sets/resets the SI390 reserve attribute.
Display Filter	Opens the Display Filter window, which filters the volumes displayed in the Volume List box.

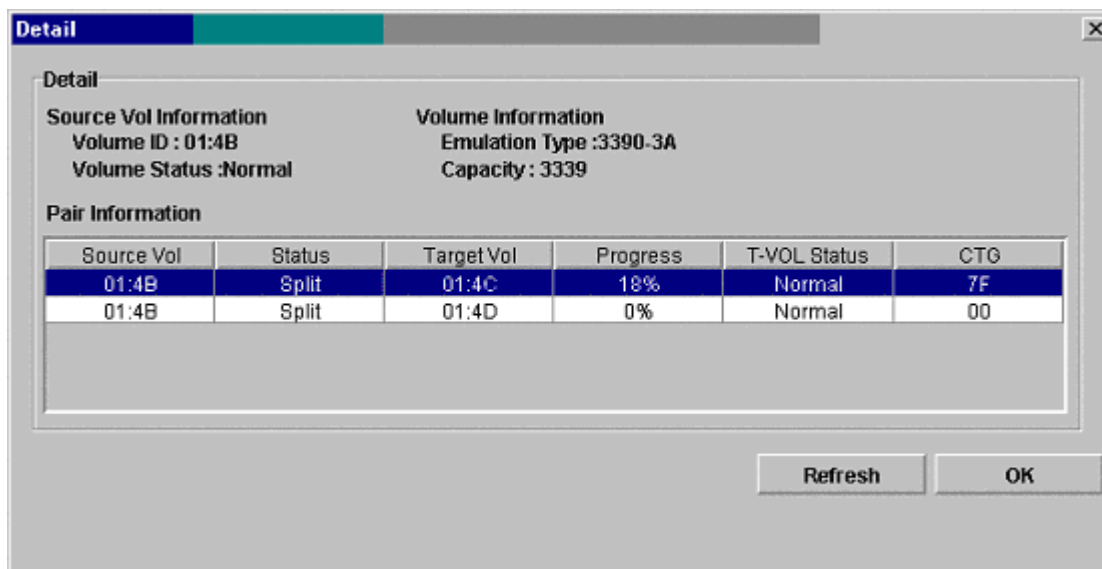
## The Detail Window

The Detail window displays information for the selected volume or pair. To open the Detail window, select a pair or volume in the Volume List box on the ShadowImage main screen, right-click to display the pop-up menu, and then click **Detail**. If the S-VOL of the selected pair has two or three T-VOLs that share the same S-VOL, the Detail window displays all the T-VOLs.

---

**Note:** SI390 supports the CQUERY/PPRCOPY QUERY commands for viewing SI390 pair status. For more information on using PPRC commands, see [Using PPRC Commands for ShadowImage](#) on page 1094.

---



**Figure 380: Detail window**

The Detail window has the following features:

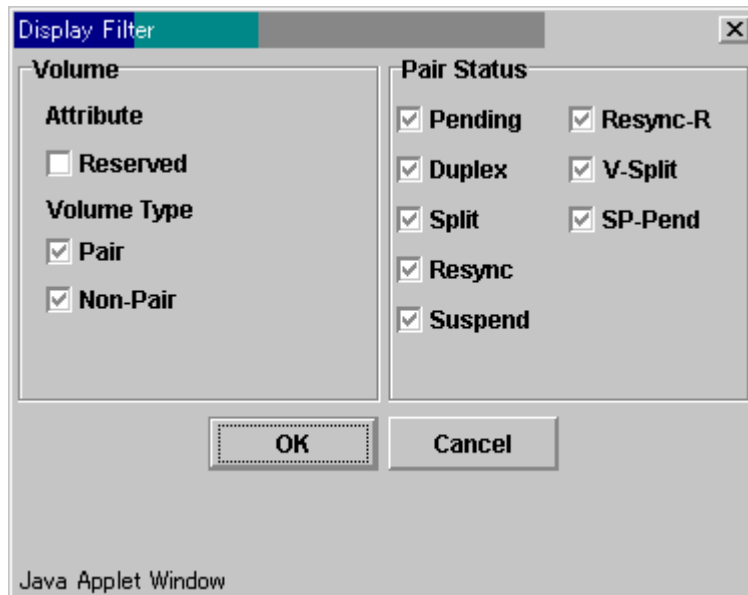
The **Detail** box displays the following:

- **Source Vol Information:** The source volume ID (CU image:LDEV ID) and the volume status.
- **Volume Information:** The emulation type and the capacity of the logical device (LDEV).
- The **Pair Information** box displays the following:
  - **Source Vol:** The source volume (S-VOL). The left of the colon (:) shows the CU image. The right of the colon (:) shows the ID of the logical device (LDEV).
  - **Status:** The status of the pair.
  - **Target Vol:** The target volume (T-VOL). The left of the colon (:) shows the CU image. The right of the colon (:) shows the ID of the logical device (LDEV).
  - **Progress:** The rate of copying in progress.
  - **T-VOL Status:** The status of the first path to the target volume.
  - **CTG:** The registered ID of the consistency group.

- The **Refresh** button updates the information displayed in the Detail window.
- The **OK** button closes the Detail window.

## The Display Filter Window

Use the Display Filter window to filter the volumes displayed in the Volume List box by reserve attribute, by pair condition, and by pair status. To open the Display Filter window, click **Display Filter** on the ShadowImage main screen. You can also open the Display Filter window by using the **Display Filter** command.



**Figure 381: Detail Filter window**

The Display Filter window has the following features:

- The **Volume** box:
  - Select the **Reserved** check box to display reserved or unreserved volumes. If you select the **Reserved** check box, only reserved volumes are displayed in the Volume List box. If you clear the **Reserved** check box, only unreserved volumes are displayed.
  - Selecting the **Pair** check box displays paired volumes.
  - Selecting the **Non-Pair** check box displays non-paired (simplex) volumes.

- Use the **Pair Status** box to filter the pairs displayed in the Volume List box by pair status: **Pending**, **Duplex**, **Split**, **Resync**, **Suspend**, **Resync-R**, **V-Split**, **SP-Pend**, and **F-Copy**.

---

**Note:** All check boxes are selected by default.

---

- The **OK** button applies the settings and closes the Display Filter window.
- The **Cancel** button resets the settings and closes the Display Filter window.

---

**Note:** The filter settings are only effective within the current SI390 operations. If you switch to another option program (for example, TC390), or click a button on the toolbar, the settings will be reset.

---





### The Preset Volume List Box

The Preset Volume List box is located below the Volume List box, and lists the specified operations (volume/pair information), which have not been performed in the XP128/XP1024.

---

**Note:** You can use the Preset Volume List box to hold multiple settings of the same operation (for example, Add Pair) only. You cannot display different types of operations (for example, Split Pair and Resync Pair) in the Preset Volume List box at the same time. You can also cancel the operations in the Preset Volume List box.


---

Source Vol	Target Vol	CopyPace	Code
 00:84	00:89	Medium	---
 00:85	00:8A	Delete	---
 00:86	00:8E	Delete All	---
 00:87	00:8F	Detail	---

**Figure 382: Preset Volume List box displaying settings (operations)**

The Preset Volume List box displays the following information of specified operations:

- **Source Vol:** The CU:LDEV (control unit image:logical device ID) of the S-VOL.
- **Target Vol:** The CU:LDEV (control unit image:logical device ID) of the T-VOL.
- **Copy Pace:** The copying pace for all pairs being created: **Slower**, **Medium**, and **Faster**.
- **Code:** The reason code is displayed if the preset operations (settings) cannot be applied successfully with the **Apply** button.

To perform the specified operations, click **Apply** on the ShadowImage main screen. When all the operations are performed successfully, the Preset Volume List box will be cleared. However, if some operations cannot be performed successfully, the failed operations will remain in the Preset Volume List box, and the error icon () is displayed. You can also cancel one or all operations by using the following pop-up menu commands:

- The **Delete** command cancels the selected operation only.

---

**Note:** To display the **Delete** command, select a volume or pair, and then right-click to display the pop-up menu.

---

- The **Delete All** command cancels all operations displayed in the Preset Volume List box.

---

**Note:** To display the **All Delete** command, deselect any volume or pair, and then right-click to display the pop-up menu.

---

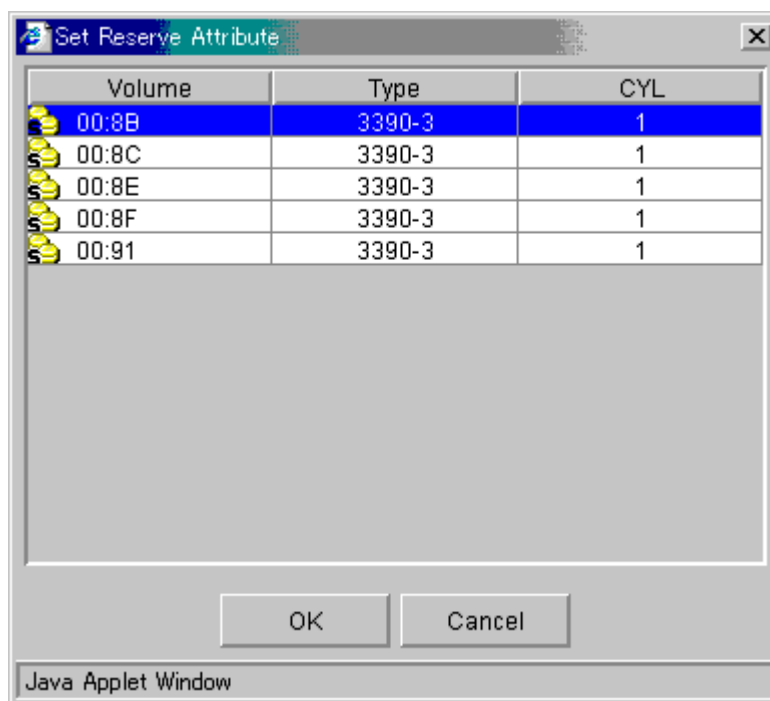
- The **Detail** command displays the Error window, which displays the error code and message for the failed operation (see [ShadowImage Error Window](#) on page 1133).

## Performing ShadowImage Operations

### Setting the Reserve Attribute

Use the Set Reserve Attribute window to set the reserve attribute for the volume(s) selected on the ShadowImage main screen. To open the Set Reserve Attribute window, select one or more unreserved *simplex* volumes in the Volume List box on the ShadowImage main screen, right-click to display the pop-up menu, and then click **Change Reserve**.

**Note:** The reserve attribute is only required for SI390 operations on Command View. The PPRC commands require that the potential T-VOLs are offline to the host, but do not require that the T-VOLs have the reserve attribute setting.



**Figure 383: Set Reserve Attribute window**

The Set Reserve Attribute window displays the unreserved volume(s) that you selected on the ShadowImage main screen. The **OK** button sets the reserve attribute for unreserved volume(s).

---

**Note:** The Preset Volume List box on the ShadowImage main screen displays the setting(s). The **Cancel** button closes the Set Reserve Attribute window without changing the settings. To apply the settings to the XP128/XP1024, click **Apply** on the ShadowImage main screen.

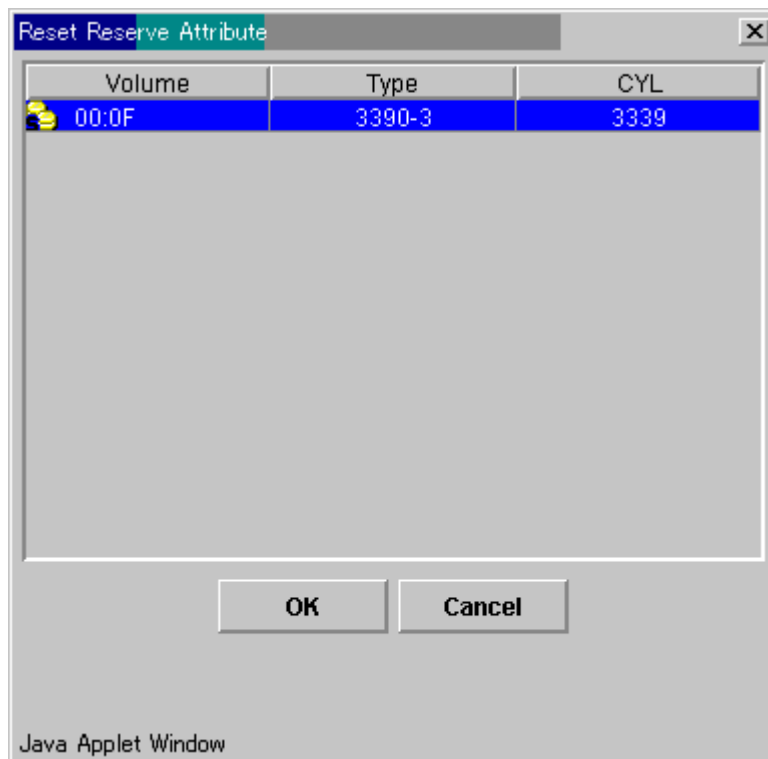
---

**To reserve one or more volumes for use as SI390 S-VOLs (set the reserve attribute):**

1. Vary the volume(s) that you will be reserving offline. The XP128/XP1024 will reject all read/write I/Os to reserved volumes (except when in the *split* state).
2. From the ShadowImage main screen, click the appropriate CU image or LDEV in the Tree View box.
3. Display unreserved *simplex* volumes in the Volume List box (for example, to display unreserved *simplex* volumes, clear the **Reserve** and **Pair** check boxes, and select the **Non-Pair** check box on the Display Filter window).
4. Select the volume(s), right-click to display the pop-up menu, and then click **Change Reserve**. The Set Reserve Attribute window is displayed. If the **Change Reserve** command is not enabled, you selected paired volumes. Select only unreserved and unpaired volumes.
5. From the Set Reserve Attribute window, click the volume(s) you want to reserve and then click **OK**.
6. The setting will be reflected in the Preset Volume List box on the ShadowImage main screen.
7. From the ShadowImage main screen, click **Apply**.
8. Verify that the settings are reflected in the XP128/XP1024. Check the attribute by clicking **Display Filter**.

## Resetting the Reserve Attribute

Use the Reset Reserve Attribute window to reset the reserve attribute for (that is, unreserve) the volume(s) selected on the ShadowImage main screen. To open the Reset Reserve Attribute window, select one or more reserved *simplex* volumes in the Volume List box on the ShadowImage main screen, right-click to display the pop-up menu, and then click **Change Reserve**.



**Figure 384: Reset Reserve Attribute window (unreserve)**

The Reset Reserve Attribute window displays the reserved volume(s) that you selected on the ShadowImage main screen. The **OK** button resets the reserve attribute for reserved volume(s).



**Note:** The Preset Volume List box on the ShadowImage main screen displays the setting(s). The **Cancel** button closes the Reset Reserve Attribute window without changing the settings. To apply the settings to the XP128/XP1024, click **Apply** on the ShadowImage main screen.

---

**To unreserve one or more volumes (reset the reserve attribute):**

1. Verify that the volumes you want to unreserve are no longer assigned to SI390 pairs as T-VOLs. For instructions on deleting SI390 pairs, see [Deleting ShadowImage Pairs](#) on page 1083.
2. From the ShadowImage main screen, click the CU image or LDEV in the Tree View box.
3. Display reserved *simplex* volumes in the Volume List box. For example, to display reserved *simplex* volumes, select the **Reserved** check box in the Display Filter window.
4. Select the volume(s), right-click to display the pop-up menu, and then click **Change Reserve**. The Reset Reserve Attribute window is displayed. If the **Change Reserve** command is not enabled, you selected paired volumes. Select only reserved and unpaired volumes.
5. From the Reset Reserve Attribute window, click the volume(s) you want to unreserve and then click **OK**.  
The setting will be reflected in the Preset Volume List box on the ShadowImage main screen.
6. From the ShadowImage main screen, click **Apply**.
7. Verify that the settings are reflected in the XP128/XP1024. Check the attribute by clicking **Display Filter**.

## Adding ShadowImage Pairs

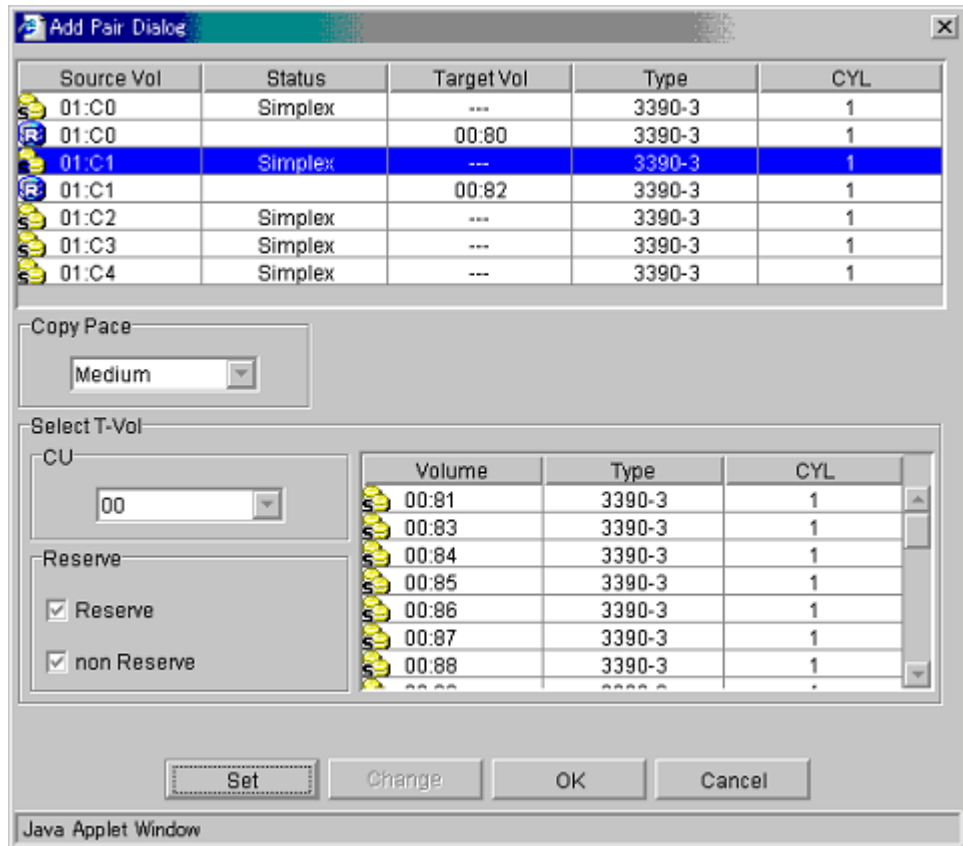


**Caution:** The SI390 add pair operation overwrites all data on the T-VOLs. The user is responsible for backing up the data on the T-VOLs before adding SI390 pairs.

---

In addition to displaying the S-VOL and T-VOL information for the pair(s) being added, you can use the Add Pair Dialog window to select the T-VOL(s) for each S-VOL, set the copy pace for all pairs being added, and start the Add Pair operation(s). To open the Add Pair Dialog window, select one or more pair or volumes in the Volume List box on the ShadowImage main screen, right-click to display the pop-up menu, and then click **Add Pair**.

**Note:** SI390 supports the CESTPAIR/PPRCOPY ESTPAIR commands for adding (starting) SI390 pairs. For more information on using PPRC commands, see [Using PPRC Commands for ShadowImage](#) on page 1094.



**Figure 385: Add Pair Dialog window**

The Add Pair Dialog window displays the S-VOL and T-VOL information for each pair being added: CU image, LDEV ID, volume status, emulation type, capacity (cylinders). Use the **Copy Pace** box to select the copy pace for all pairs being added: **Slower**, **Medium**, and **Faster**.

---

**Note:** When the Preset Volume List box already holds some Add Pair settings and you specify a different copy pace for new pairs in the Add Pair Dialog window, the copy pace for the existing Add Pair settings displayed in the Preset Volume List box will be also changed. The latest copy pace specified in the Add Pair Dialog window is always reflected to the disk array.

---

Use the **Select T-Vol** box to filter the T-VOLs displayed in the T-VOL list. Use the **Reserve** box to display the available T-VOLs by reserve attribute.

The **Set** button adds the selected T-VOL to the selected S-VOL. The **Change** button replaces the T-VOL of the selected pair in the list with the selected T-VOL. To remove any volumes from the S-VOL or T-VOL list, select the volumes, right-click to display the pop-up menu, and then click **Delete**. The **OK** reflects the new pairs in the list to the Preset Volume List box on the ShadowImage main screen.

---

**Note:** To add all pairs in the list, click **Apply** on the ShadowImage main screen. The **Cancel** button closes the Add Pair Dialog window without changing the settings.

If you want to add new SI390 pairs and then split them immediately so that you can access the T-VOLs as soon as possible, use the Split Pair operation instead of the Add Pair operation to establish and split new pairs at the same time (see [Splitting ShadowImage Pairs](#) on page 1073 for instructions).

---

#### **To add one or more new SI390 pairs:**

1. Verify that the appropriate T-VOL(s) is/are offline.
2. From the ShadowImage main screen, click the CU image or LDEV in the Tree View box to filter the volumes displayed in the Volume List box.
3. Select the S-VOL(s) for the new pair(s), right-click to display the pop-up menu, and then click **Add Pair** to open the Add Pair Dialog window.

---

**Note:** Do not select any reserved volumes.

---


4. Set the initial copy pace for all pairs being added: **Slower**, **Medium**, or **Faster**.
5. Verify that the Add Pair Dialog window displays the appropriate S-VOL(s). If you want to remove any volumes from the list, select the volume(s), right-click to display the pop-up menu, and then click **Delete**.
6. Select the T-VOL(s) for each S-VOL as follows:
  - a. Click the S-VOL in the Add Pair Dialog window.
  - b. Click the CU in the **CU** drop-down list, select the **Reserve** check box to display reserved volumes, and then click the T-VOL.
  - c. Click **Set** to create (add) the T-VOL to the selected S-VOL. The T-VOL is now displayed next to the selected S-VOL.

---

**Note:** You can select an unreserved volume as the T-VOL. When you create the pair, the XP128/XP1024 changes the reserve attribute to "reserved" automatically.

---

- d. To add a second and/or third T-VOL to the same S-VOL, repeat [step b](#) - [step c](#) to add each T-VOL to the selected S-VOL. Each pair to be created is displayed separately in the list of pairs in the Add Pair Dialog window.
7. Repeat [step 6](#) until all necessary pairs are displayed. Click **Change** to replace a T-VOL, click **Set** to add a T-VOL, and use the **Delete** command to remove pairs.
8. When the Add Pair Dialog window displays the new pair(s), click **OK** to reflect all pairs (settings) in the list to the Preset Volume List box on the ShadowImage main screen.
9. From the ShadowImage main screen, click **Apply** to create the pair(s).

When the initial copy operation(s) start, the ShadowImage main screen shows the new pairs with *pending* status and the progress (%) of the initial copy operation(s).
10. Click the **Refresh** button (  ) to monitor the progress of the initial copy operation(s).

## Splitting ShadowImage Pairs

In addition to displaying volume and pair information for the volume(s) and/or pair(s) selected on the ShadowImage main screen, you can use the Split Volume Pair window to split existing SI390 pairs. The Split Volume Pair window can also be used to simultaneously add and split new SI390 pairs (see [Adding and Splitting Pairs](#) on page 1076). To open the Split Volume Pair window, select volume(s) or pair(s) in the Volume List box on the ShadowImage main screen, right-click to display the pop-up menu, and then click **Split Pair**.

---

**Note:** SI390 supports the CSUSPEND/PPRCOPY SUSPEND commands for splitting SI390 pairs. For more information on using PPRC commands, see [Using PPRC Commands for ShadowImage](#) on page 1094.

---



**Figure 386: Split Volume Pair window**

The Split Volume Pair window lists the volume(s)/pair(s) selected on the ShadowImage main screen, and shows the pair status and copy pace for each pair. Use the **Copy Pace** box to select the copy pace for all pairs that you are splitting: **Slower**, **Medium**, or **Faster**. Use the **Select Split Type** box to select the split type for all pairs that you are splitting: **Quick Split** or **Steady Split**.

Use the **Select T-Vol** box to filter the T-VOLs displayed in the T-VOL list. The **CU** and **Reserve** boxes display the available S-VOLs by port and by reserve attribute.

The **Set** button adds the selected T-VOL to the selected S-VOL. The **Change** button replaces the T-VOL of the selected pair in the list with the selected T-VOL. To remove any volumes from the list, select the unneeded volumes, right-click to display the pop-up menu, and then click **Delete**. The **OK** button reflects all settings to the Preset Volume List box on the ShadowImage main screen.

---

**Note:** Click **Apply** on the ShadowImage main screen to split all pairs in the Preset Volume List box. The **Cancel** button closes the Pairsplit window without changing the settings.

---

**To split one or more existing SI390 pairs:**

1. If you want the split T-VOLs to be identical to the S-VOLs, stop all write operations to the S-VOLs before splitting the pairs. This ensures that there are no updates to the S-VOLs while the split operations are synchronizing the T-VOLs to the S-VOLs.



**Caution:** The S-VOL and T-VOL are synchronized only when the pair status changes from SP-Pend or V-Split to Split. Due to the SI390 asynchronous update copy operations, this status transition can take several minutes.

---

2. From the ShadowImage main screen, click the CU image or LDEV in the Tree View box to filter the volumes displayed in the Volume List box.
3. Select the pair(s) you want to split, right-click to display the pop-up menu, and then click **Split Pair** to open the Split Volume Pair window. You cannot split a suspended pair.
4. From the Split Volume Pair window, set the copy pace (**Slower**, **Medium**, or **Faster**) for all pairs being split.

---

**Note:** If you change the setting, the last setting will become effective.

---

5. Set the split type (**Quick Split** or **Steady Split**) for all pairs being split.


**Note:** The split type is set for all pairs being split. If you change the setting, the latest setting is applied to all pairs.

---

6. When the Split Volume Pair window displays the pair(s), click **OK** to reflect all pairs to the Preset Volume List box on the ShadowImage main screen.
- 

**Note:** Use the **Delete** command to remove any pairs from the list.

---

7. From the ShadowImage main screen, click **Apply** to split the pair(s).  
When the pairsplit operation(s) start, the ShadowImage main screen shows the new pairs with *SP-Pend* or *V-Split* status and the progress (%) of the update copy operation(s). The *Split* status is displayed right away if there were no pending update copy operations.
8. Click the **Refresh** button (  ) to monitor the progress of the split operation(s).

## Adding and Splitting Pairs

The split operation can also be used to simultaneously add and split new SI390 pairs. In this case, the split operation changes the pair status from *simplex* to *SP-Pend* or *V-split*, copies all data on the S-VOL to the T-VOL, and then changes the pair status to *Split*.

---

**Note:** The combined add and split operation can be performed using PPRC commands. Refer to [Table 152](#) on page 1095 and [Table 153](#) on page 1100.

---

### To add and split one or more new SI390 pairs with a single Command View operation:

1. If you want the split T-VOLs to be identical to the S-VOLs, stop all write operations to the S-VOLs before adding and splitting the pairs. This ensures that there are no updates to the S-VOLs while the split operations are synchronizing the T-VOLs to the S-VOLs.






**Caution:** The S-VOL and T-VOL are synchronized only when the pair status changes from SP-Pend or V-Split to Split. Due to the SI390 asynchronous update copy operations, this status transition can take several minutes.

2. From the ShadowImage main screen, click the CU image or LDEV in the Tree View box to filter the volumes displayed in the Volume List box (for example, to display unreserved simplex volumes).
3. Select the volume(s) that will be the S-VOL(s) of the new pairs to be added and split, right-click to display the pop-up menu, and then click **Split Pair** to open the Split Volume Pair window.
4. Set the copy pace (**Slower**, **Medium**, or **Faster**) and split type (**Quick** or **Steady**) for all pairs being added and split.
5. Specify the T-VOL(s) as follows:
  - a. Click the S-VOL.
  - b. Click the CU image in the **CU** drop-down list, display either reserved or unreserved volumes, and then click the T-VOL.

**Note:** You can select unreserved T-VOL because the disk array will automatically reserve the T-VOL.

- c. Click **Set** to add the T-VOL to the selected S-VOL. The T-VOL is now displayed below the selected S-VOL.
  - d. To add another T-VOL to the same S-VOL, repeat [step b](#) - [step c](#) to add the next T-VOL to the selected S-VOL. Each pair to be added and split is displayed separately in the list of pairs.
6. Repeat [step 5](#) until the pair(s) is/are displayed. Click **Change** to replace T-VOLs, click **Set** to add T-VOLs, and use the **Delete** command to remove pairs.
7. Click **OK** to reflect the settings to the Preset Volume List box on the ShadowImage main screen.
8. From the ShadowImage main screen, click **Apply** to create and split the pair(s).

When the split operation(s) start, the ShadowImage main screen shows the new pairs with *SP-Pend* or *V-Split* status and the progress (%) of the update copy operation(s). The *Split* status is displayed right away if there were no pending update copy operations.

9. Click the **Refresh** button (  ) to monitor the progress of the pairsplit operation(s).

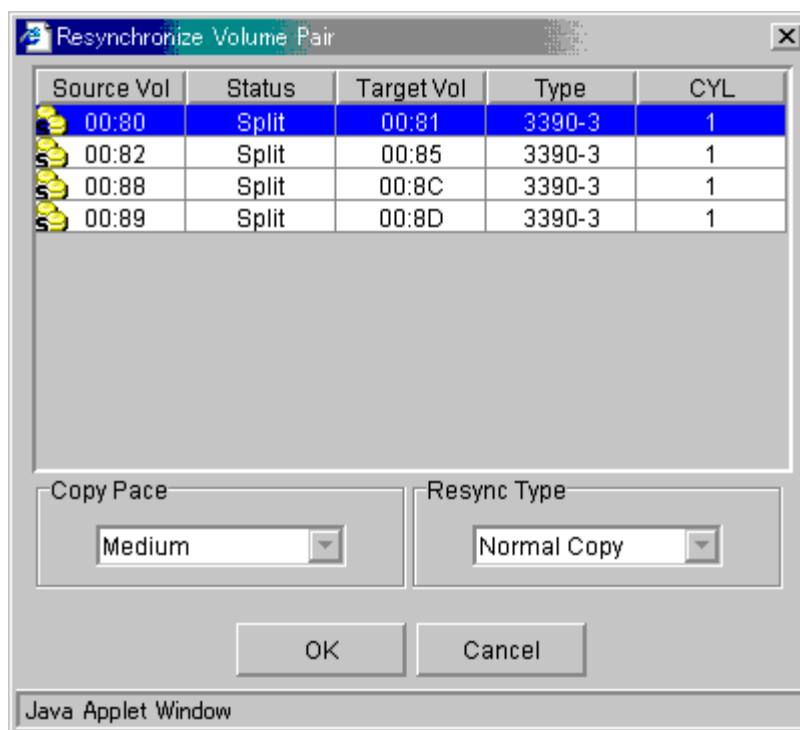
## Resynchronizing ShadowImage Pairs

In addition to displaying pair information for the pair(s) selected on the ShadowImage main screen, you can use the Resynchronize Volume Pair window to resynchronize the pair(s). To open the Resynchronize Volume Pair window, select one or more pairs in the Split, V-Split or Suspended status in the Volume List box on the ShadowImage main screen, right-click to display the pop-up menu, and then click **Resync Pair**.

---

**Note:** SI390 supports the CESTPAIR/PPRCOPY ESTPAIR commands for resynchronizing split or suspended SI390 pairs. For more information on using PPRC commands, see [Using PPRC Commands for ShadowImage](#) on page 1094.

---



**Figure 387: Resynchronize Volume Pair window**

The Resynchronize Volume Pair window lists the pair(s) selected on the ShadowImage main screen and shows the pair status and copy pace for each pair. Use the **Copy Pace** box to select the copy pace for the pairs being resynchronized: **Slower**, **Medium**, or **Faster**. Use the **Resync Type** box to select the pairresync type for the pairs being resynchronized: **Normal Copy**, **Quick Resync**, **Reverse Copy**, or **Quick Restore**.

The **OK** button adds the specified pair(s) to the Preset Volume List box on the ShadowImage main screen.

**Note:** Click **Apply** on the ShadowImage main screen to start the resync operation for the specified pair(s). The **Cancel** button closes the Resynchronize Volume Pair window and returns you to the ShadowImage main screen. To remove any pair(s) from the list, select the unneeded pair(s), right-click to display the pop-up menu, and then click **Delete**.

**To resynchronize one or more SI390 pairs:**

1. Vary the split T-VOLs offline before starting the resync operations. When the resync operation starts, the XP128/XP1024 will stop accepting write I/Os to the T-VOL.
2. From the ShadowImage main screen, click the CU image or LDEV in the Tree View box to filter the volumes displayed in the Volume List box (for example, to display only split and suspended SI390 pairs).
3. From the ShadowImage main screen, select the pair(s) you want to resync, right-click to display the pop-up menu, and then click **Resync Pair** to open the Resynchronize Volume Pair window.
4. From the Resynchronize Volume Pair window, click the pair(s), and set the copy pace (**Slower**, **Medium**, or **Faster**) and resync type (**Normal Copy**, **Quick Resync**, **Reverse Copy**, or **Quick Restore**) for each pair. Reverse and quick restore pairresync cannot be performed on pairs in the *V-Split* or *Suspended* status.



**Caution:** Make sure to select the correct resync direction (normal/quick, or reverse/quick restore).

---

During the quick restore operation, the RAID levels, HDD types, and Cache LUN XP settings are swapped. To avoid performance impact due to quick restore operations:

- a. Verify that the S-VOL and T-VOL have the same RAID level and HDD type before performing the quick restore operation. If you want to restore the original RAID levels after quick restore, stop host I/Os to the pair, split the pair, perform the quick restore operation for that pair again, and then restart the host I/Os to the pair.
- b. Because the Cache LUN XP settings are exchanged during a quick restore operation, you must perform one of the two following operations. If you do not, the change of location of the cache residence areas may cause I/O performance to the Cache LUN XP data to be down.
  - Set the same Cache LUN XP settings (locations) for the S-VOL and T-VOL before performing the quick restore operation.

- Release the Cache LUN XP settings of the S-VOL and T-VOL before the quick restore operation, and then reset the Cache LUN XP settings of the S-VOL and T-VOL after the pair changes to *duplex* status as a result of the quick restore operation.

---

**Note:** If you do not want to resynchronize the S-VOL and T-VOL after the quick restore operation, you must set the Swap&Freeze option before performing the quick restore operation (see [Swap&Freeze Option](#) on page 1040 and [Setting ShadowImage Options](#) on page 1087).


---

5. Click **OK** to reflect the settings to the Preset Volume List box on the ShadowImage main screen.
6. Repeat [step 4](#) - [step 5](#) until the Preset Volume List box on the ShadowImage main screen displays the necessary pairs (settings).

---

**Note:** Make sure to vary the T-VOL(s) offline before starting resync operations.

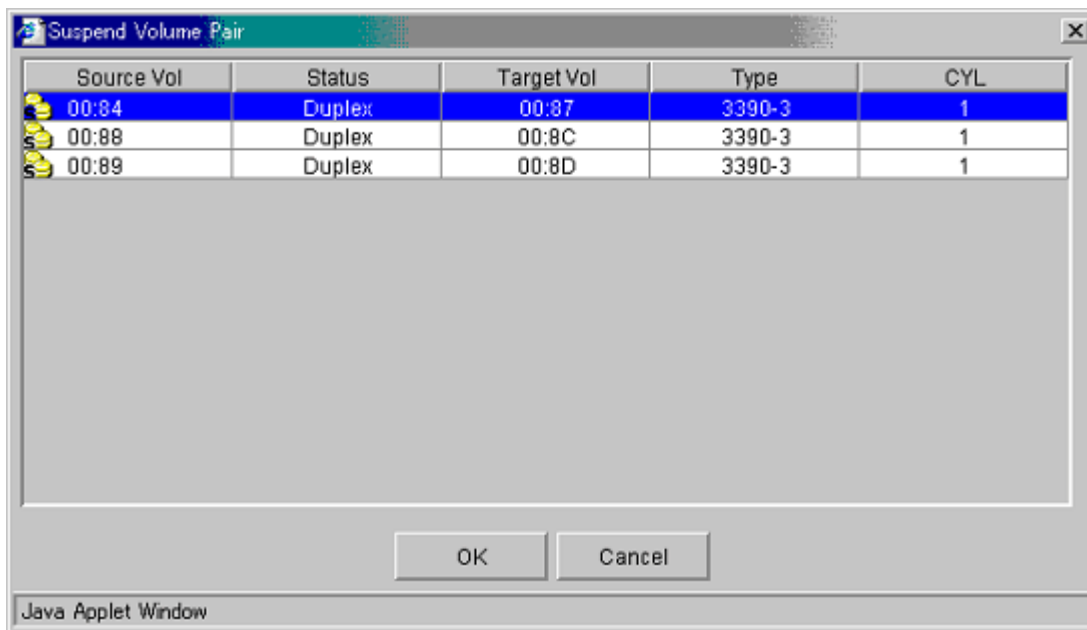
---

7. From the ShadowImage main screen, click **Apply** to resync the specified pair(s).  
The ShadowImage main screen now displays the result(s) of the pairresync operation(s) (pair status changed to *resync*, *resync-R*, or *duplex*).
8. Click the **Refresh** button () to monitor the progress of the resync operation(s).

## Suspending ShadowImage Pairs

In addition to displaying pair information for the pair(s) selected on the ShadowImage main screen, you can use the Suspend Volume Pair window to suspend the pair(s). To open the Suspend Volume Pair window, select one or more pairs in the Volume List box on the ShadowImage main screen, right-click to display the pop-up menu, and then click **Suspend Pair**.

**Note:** The CSUSPEND/PPRCOPY SUSPEND commands execute an SI390 split operation. There is no TSO/ICKDSF command equivalent for manually suspending pairs. For more information on using PPRC commands, see [Using PPRC Commands for ShadowImage](#) on page 1094.



**Figure 388: Suspend Volume Pair window**

The Suspend Volume Pair window lists the pair(s) selected on the ShadowImage main screen and shows the pair status and copy pace for each pair. The **OK** button suspends the selected pair(s). The **Cancel** button closes the Suspend Volume Pair window and returns you to the ShadowImage main screen.

**To suspend one or more SI390 pairs:**

1. From the ShadowImage main screen, click the CU image or LDEV in the Tree View box to filter the volumes displayed in the Volume List box.
2. Select the pair(s) that you want to suspend (or the volume(s) whose pairs you want to suspend), right-click to display the pop-up menu, and then click **Suspend Pair** to open the Suspend Volume Pair window.

3. From the Suspend Volume Pair window, click the pair(s) you want to suspend and then click **OK** to reflect the settings to the Preset Volume List box on the ShadowImage main screen.

---

**Note:** To remove pair(s) from the list, select the unneeded pair(s), right-click to display the pop-up menu, and then click **Delete**.

---

4. Repeat [step 2](#) - [step 3](#) to suspend additional pairs in the list.
5. From the ShadowImage main screen, click **Apply** to suspend the specified pair(s).

The ShadowImage main screen now displays the result(s) of the suspend operation(s) (pair status changed to *Suspend*).

6. Click the **Refresh** button () to display the latest information.

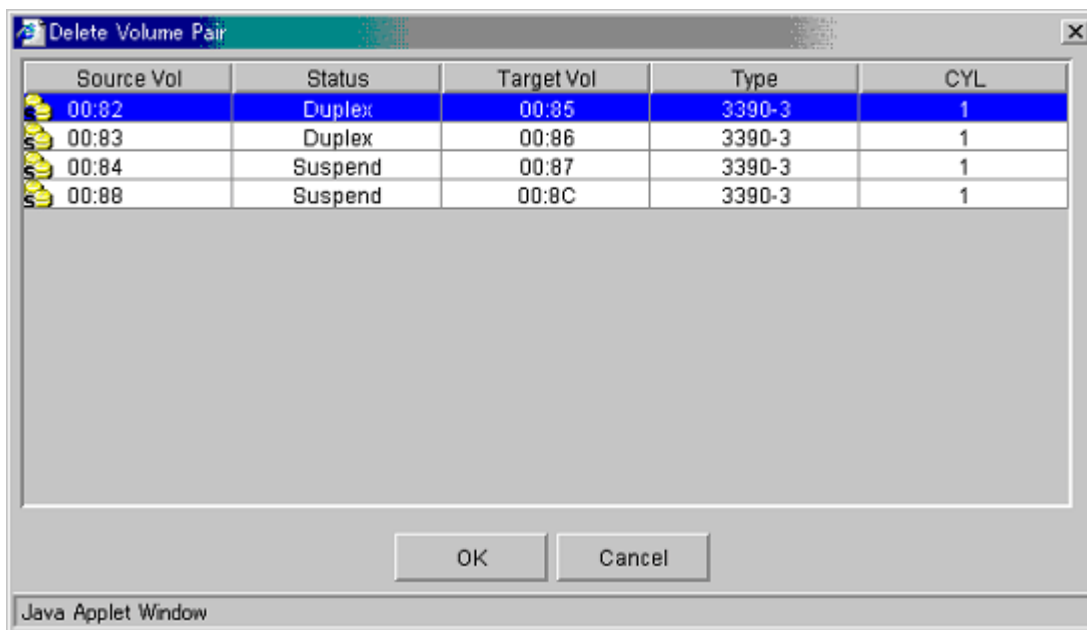
## Deleting ShadowImage Pairs

In addition to displaying pair information for the pair(s) selected on the ShadowImage main screen, you can use the Delete Volume Pair window to delete the pair(s). To open the Delete Volume Pair window, select one or more pairs (except *Simplex* and *V-Split* pairs) in the Volume List box on the ShadowImage main screen, right-click to display the pop-up menu, and then click **Delete Pair**.

---

**Note:** SI390 supports the CDELPAIR/PPRCOPY DELPAIR commands for deleting SI390 pairs. For more information on using PPRC commands, see [Using PPRC Commands for ShadowImage](#) on page 1094.

---



**Figure 389: Delete Volume Pair window**

The Delete Volume Pair window lists the pair(s) selected on the ShadowImage main screen and shows the pair status and copy pace for each pair. The **OK** button deletes the selected pair(s). The **Cancel** button closes the Delete Volume Pair window and returns you to the ShadowImage main screen.

**To delete one or more SI390 pairs:**

1. If you want to synchronize the S-VOL and T-VOL before deleting the pair:
  - a. Wait until all write I/Os to the S-VOL are complete, and then take the S-VOL offline to prevent the S-VOL from being updated during or after the delete operation.
  - b. After the S-VOL is offline, suspend the pair to copy all pending updates to the T-VOL.
  - c. When the pair status changes to *Split*, the S-VOL and T-VOL are synchronized.
2. From the ShadowImage main screen, click the CU image or LDEV in the Tree View box to filter the volumes displayed in the Volume List box.




3. Select the pair(s) that you want to delete (or the volume(s) whose pairs you want to delete), right-click to display the pop-up menu, and then click **Delete Pair** to open the Delete Volume Pair window.

---

**Note:** Pairs with V-Split status cannot be deleted. To remove pair(s) from the list, select the unneeded pair(s), right-click to display the pop-up menu, and then click **Delete**.

---

4. From the Delete Volume Pair window, click the pair(s) you want to delete and then click **OK** to reflect the settings to the Preset Volume List box on the ShadowImage main screen.
5. From the ShadowImage main screen, click **Apply** to delete the specified pair(s) or volume(s).  
The ShadowImage main screen now displays the result(s) of the delete operation(s).
6. Click the **Refresh** button () to display the latest information.

## Viewing ShadowImage Pair Status and History


The History screen displays current SI390 pair status information as well as SI390 pair history information for the selected CU image.

To display the History screen, click the **History** tab.

Time	Source Vol	Target Vol	Code	Message
2002/01/17 13:09:47	01:1D	01:13	4711	PAIR START
2002/01/17 13:09:47	01:1D	01:14	4711	PAIR START

**Figure 390: History screen**

The **ShadowImage History** box displays the following information:

- SI390 pair activity listed by: date and time, S-VOL and T-VOL ID (CU:LDEV), SI390 code and message (see the following table). The **Time** button sorts the list by date and time. The **Source Vol** and **Target Vol** buttons sort the list by S-VOL or T-VOL. The **Code** button sorts by code number. The **Message** button sorts according to message type.
- The **Refresh** button () updates all information on the History screen.

**Table 149: ShadowImage status and history reference codes and messages**

Code	Message	Description
4710 - 471F	DUPLEX START	The SI390 initial copy operation started.
4720 - 472F	DUPLEX END	The SI390 initial copy operation ended and the pair status changed to <i>Duplex</i> .
4730 - 473F	SPLIT START	The SI390 split operation started and the pair status changed to <i>SP-Pend</i> or <i>V-Split</i> .

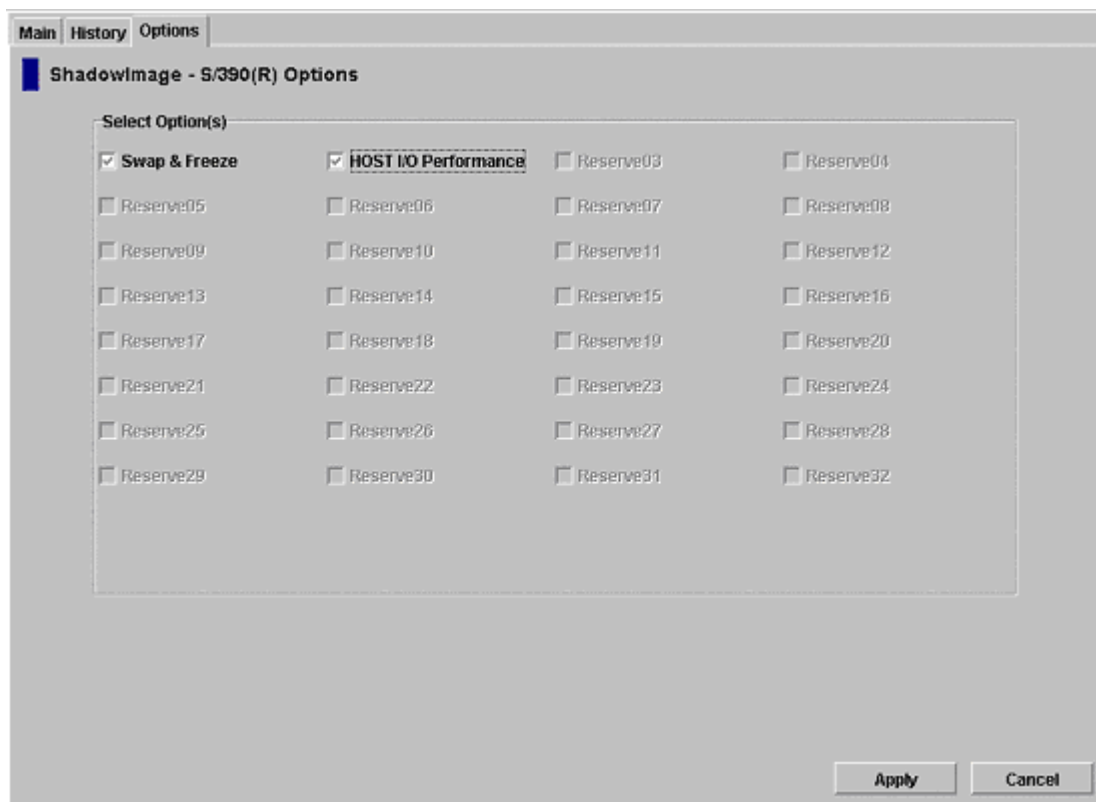
**Table 149: ShadowImage status and history reference codes and messages (Continued)**

Code	Message	Description
4740 - 474F	SPLIT END	The SI390 split operation ended and the pair status changed to <i>Split</i> .
4750 - 475F	RESYNC START RESYNC-R START	The SI390 resync operation started and the pair status changed to <i>Resync</i> or <i>Resync-R</i> .
4760 - 476F	RESYNC END RESYNC-R END	The SI390 resync operation ended and the pair status changed to <i>Duplex</i> .
4774	F-COPY START	The ShadowImage - FlashCopy operation started.
4775	F-COPY END	The ShadowImage - FlashCopy operation ended normally.
4776	F-COPY DELETE	The ShadowImage - FlashCopy delete operation was performed.
47A0 - 47AF	PENDING WARNING END	A copy ended with a warning.
47B0 - 47BF	PENDING ABNORMAL END (SVOL BLOCKADE)	A copy ended abnormally due to S-VOL blockade.
47C0 - 47CF	PENDING ABNORMAL END (TVOL BLOCKADE)	A copy ended abnormally due to T-VOL blockade.
47D0 - 47DF	PENDING ABNORMAL END	A copy ended abnormally (reason other than above).
47E7	COMPULSION PAIR SUSPEND	A pair was suspended compulsorily.
4B00 - 4B0F	F-COPY ABNORMAL END	The ShadowImage - FlashCopy operation ended abnormally.

## Setting ShadowImage Options

You can set options for SI390 on the Options screen.

To display the Options screen, click the **Options** tab. From the Options screen, select and/or clear the check boxes to set options.



**Figure 391: Options screen**

The **Select Option(s)** box displays the check boxes of the SI390 options. For more information about the supported options, refer to [ShadowImage Options](#) on page 1039.

**To set an SI390 option:**

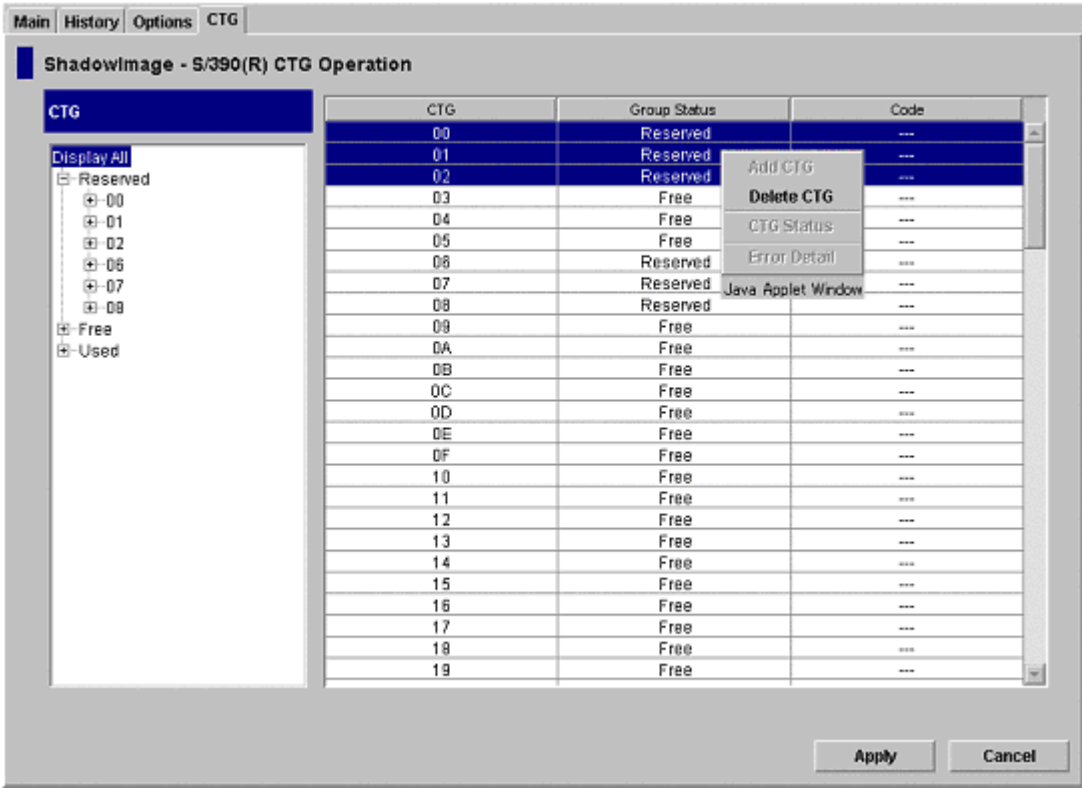
1. From ShadowImage, click the **Options** tab to display the Options screen. When the Options screen is opened, it shows the current status of the option.
2. Select the check box next to each option you want to set. If you do not want to set any of the options, clear all of the check boxes in the **Select Option(s)** box.
3. Select **Apply**. You can now perform an SI390 operation with the specified option.

# CTG Screen

The CTG screen displays the information about the selected consistency groups of the connected XP disk array. A consistency group (CTG or CT Group) is a set of volume pairs defined by the host command.

**Note:** The **CTG** tab and its features are available only if the XP disk array has firmware version 21.07.04 or later installed.

To display the CTG screen, click the **CTG** tab.



**Figure 392: CTG screen**

The CTG screen contains the following items:

- Use the **Tree View** box, on the left of the screen, to select the status (Reserved, Free or Used) or the registered ID of the consistency group that you want to display in the CTG List box. To display all the consistency groups, select **Display All** at the top of the Tree View box.
- The **CTG List** box, on the right side of the screen, displays all the consistency groups selected in the Tree View box. You can sort the consistency groups by CTG, Group Status, and Code.
- The **Apply** button performs the SI390 operations displayed in the CTG List box. If an error occurs during the operation, the consistency group or groups that the system failed to perform the intended operation will remain in the CTG List box and the error code for each failed operation will be displayed under the Code column.
- The **Cancel** button cancels all the ongoing operations specified in the CTG List box.

To perform CTG operations for the consistency group, select a consistency group in the CTG List box, right-click to display the pop-up menu commands (**Add CTG**, **Delete CTG**, **CTG Status**, and **Error Detail**), and then click the appropriate command (see [The CTG List Box](#) on page 1090).

## The CTG List Box

The CTG List box displays CTG-related information based on the options you select in the Tree View box.

CTG	Group Status	Code
00	Reserved	---
01	Reserved	---
02	Reserved	---
03	Free	---
04	Free	---
05	Free	---
06	Reserved	---
07	Reserved	---
08	Reserved	---
09	Free	---
0A	Free	---
0B	Free	---

**Figure 393: CTG List Box**

The CTG List box contains the following items:

- **CTG:** The registered ID of each consistency group.
- **Group Status:** The current status of each consistency group. Each consistency group is set to one of the three types of status:
  - **Free:** The consistency group is available for use.
  - **Reserved:** The consistency group is set, but the volume pairs are not registered yet.
  - **Used:** The consistency group is set and the volume pairs are already registered.
- **Code:** The error code in case the system fails to apply the setting successfully when you click the **Apply** button. For more information about the failed operation, right-click and click the **Error Detail** command from the pop-up menu.

The following table shows the commands in the pop-up menu that you can use to perform CTG operation to one or more consistency groups of your preference in the CTG List box.

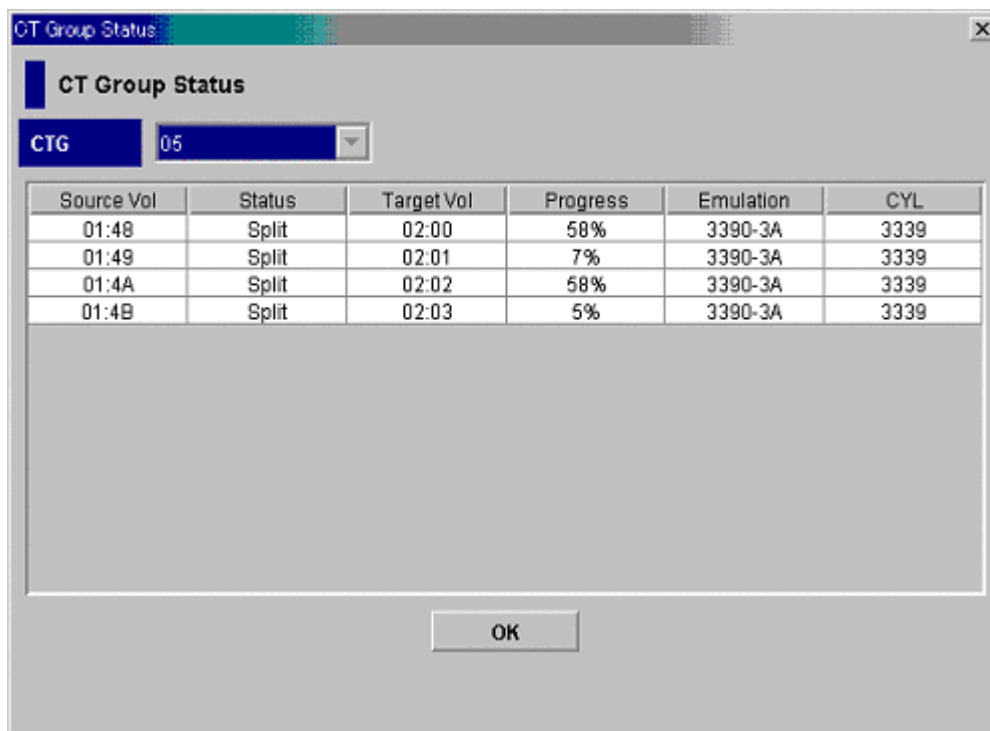
**Table 150: List of pop-up menu commands for CTG operation**

Command	Feature
Add CTG	Sets the reserve attribute for each CTG selected in the CTG List box.
Delete CTG	Resets the reserve attribute for the CTG(s) selected in the CTG List box.
CTG Status	Opens the CT Group Status window that displays the information about the selected consistency group.
Error Detail	Opens the Error window that displays the error code and error message describing the failed operation.

## The CT Group Status Window

The CT Group Status window displays the information about the status of the selected consistency groups.

To open the CT Group Status window, select a consistency group in the CTG List box, right-click, and then select the CTG Status command.



**Figure 394: CT Group Status window**

The CT Group Status window contains the following items:

- Use the **CTG** drop-down list to select a consistency group and display information about it in the Pair list box.
- The **Pair List** box displays the following registered pair-related information of the consistency group selected in the **CTG** drop-down list:
  - **Source Vol:** The source volume (S-VOL). The left of the colon (:) shows the CU image. The right of the colon (:) shows the ID of the logical device (LDEV).
  - **Status:** The status of the pair.
  - **Target Vol:** The target volume (T-VOL). The left of the colon (:) shows the CU image. The right of the colon (:) shows the ID of the logical device (LDEV).
  - **Progress:** The rate of copying in progress.



- **Emulation:** The emulation type.
- **CYL:** The number of volume cylinders.
- The **OK** button closes the CT Group Status window.

## Setting the Reserve Attribute of a Consistency Group

Use the Add CTG command to set the reserve attribute of one or more consistency groups selected in the CTG List box.

### To set the reserve attribute of one or more consistency groups:

1. From the CTG screen, click the CTG Status or CTG in the Tree View box. Confirm that the information of the consistency group that you have just selected is displayed in the CTG List box.
2. Select the consistency group that you want to set the reserve attribute, right-click to display the pop-up menu, and then click **Add CTG**.
3. Repeat the previous steps for each consistency group you want to set.
4. From the CTG screen, click **Apply** to set the reserve attribute.

## Resetting the Reserve Attribute of a Consistency Group

Use the Delete CTG command to reset the reserve attribute of one or more consistency groups selected in the CTG List box.

### To reset the reserve attribute of one or more consistency groups:

1. From the CTG screen, click the consistency group or its status displayed in the Tree View box. Confirm that the information of the consistency group that you have just selected is displayed in the CTG List box.
2. Select the consistency group that you want to reset the reserve attribute, right-click to display the pop-up menu, and then click **Delete CTG**.
3. Repeat the previous steps for each consistency group you want to reset.
4. From the CTG screen, click **Apply** to reset the reserve attribute.

## Using PPRC Commands for ShadowImage

SI390 supports both TSO PPRC commands and ICKDSF PPRCOPY commands to perform SI390 operations from the S/390 host system.

### PPRC Command Support

The following table lists and describes the PPRC commands supported by SI390. [Table 152](#) on page 1095 lists and describes the TSO command parameters supported by SI390. [Table 153](#) on page 1100 lists and describes the ICKDSF command parameters supported by SI390.

**Table 151: PPRC commands**

SI390 Command View Operation	TSO Command	ICKDSF Command	Function	Restrictions
Set Reserve Attribute (reserve)	Not required	Not required	Sets the reserve attribute of the specified volume.	The specified volume must be <i>simplex</i> and offline to host.
Reset Reserve Attribute (unreserve)	Not required	Not required	Resets reserve attribute of the specified volume.	The specified volume must be <i>simplex</i> .
Add Pair (duplex request)	CESTPAIR	PPRCOPY ESTPAIR	Adds a pair, starts initial copy operation.	The specified volume must be <i>simplex</i> .
Add and Split Pair	CESTPAIR	PPRCOPY ESTPAIR	Adds and simultaneously splits a pair.	The specified volume must be <i>simplex</i> .
Quick Split Pair	CSUSPEND	PPRCOPY SUSPEND	Splits a pair, starts quick split operation.	The specified volume must be <i>duplex</i> or <i>pending</i> .
Steady Split Pair	CSUSPEND	PPRCOPY SUSPEND	Splits a pair, starts steady split operation.	The specified volume must be <i>duplex</i> or <i>pending</i> .
Normal Resync Pair	CESTPAIR	PPRCOPY ESTPAIR	Resynchronizes a pair, starts normal resync.	The specified volume must be <i>split</i> , <i>V-split</i> or <i>suspended</i> .
Quick Resync Pair	CESTPAIR	PPRCOPY ESTPAIR	Resynchronizes a pair, starts quick resync.	The specified volume must be <i>split</i> , <i>V-split</i> or <i>suspended</i> .

**Table 151: PPRC commands (Continued)**

SI390 Command View Operation	TSO Command	ICKDSF Command	Function	Restrictions
Reverse Resync Pair	CESTPAIR	PPRCOPY ESTPAIR	Resynchronizes a pair, starts reverse resync.	The specified volume must be <i>split</i> .
Quick Restore Pair	CESTPAIR	PPRCOPY ESTPAIR	Resynchronizes a pair, starts quick restore.	The specified volume must be <i>split</i> .
Delete Pair (simplex request)	CDELPAIR	PPRCOPY DELPAIR	Deletes a pair, changes status to simplex.	The specified volume cannot be <i>simplex</i> .
Suspend Pair	Not available <sup>1</sup>	Not available <sup>1</sup>	Stops update copy operations.	The specified volume cannot be <i>simplex</i> .
Detail (the Detail window), the History screen.	CQUERY	PPRCOPY QUERY	Displays detailed pair status information.	None.

1. The SI390 suspend operations cannot be requested using TSO/ICKDSF commands. The CSUSPEND/PPRCOPY SUSPEND commands execute split operations on SI390 pairs.

**Table 152: TSO command parameters**

Command	Parameter	Description
CESTPAIR	DEVN	Device number.
	PRIM	Primary volume (S-VOL): SSID, serial number, channel connection address, CU number (only for the DKC emulation type 2105). You can set an additional parameter corresponding to each request instead of a serial number.
		(1) For an Add and Split request (refer to <a href="#">Adding and Splitting Pairs</a> on page 1076), the parameter is <b>MSFOO</b> . This request is valid for MODE(COPY) only. The parameter locations and descriptions are as follows: Byte 0-6: Fixed value (xF0*7) Byte 7: Indication of MRCF. 'M' = MRCF ← Distinguishes SI390 from TC390. Byte 8: Subcode-1. 'S' = Split ← Requests simultaneous add and split. Byte 9: Subcode-2. 'F' = Fast Mode ← Requests quick split. Byte 10-11: Not used (xF0*2)

**Table 152: TSO command parameters (Continued)**

Command	Parameter	Description
		<p>(2) For a Quick Resync request, the parameter is <b>MRFOO</b>. This request is valid for MODE(RESYNC) only. The parameter locations and descriptions are as follows:</p> <p>Byte 0-6: Fixed value (xF0*7)</p> <p>Byte 7: Indication of MRCF. 'M' = MRCF ← Distinguishes SI390 from TC390.</p> <p>Byte 8: Subcode-1. 'R' = Resync ← Distinguishes resync from add.</p> <p>Byte 9: Subcode-2. 'F' = Fast Mode ← Requests quick resync.</p> <p>Byte 10-11: Not used (xF0*2)</p>
		<p>(3) For a Quick Restore request, the parameter is <b>MRQOO</b>. This request is valid for MODE(RESYNC) only. The parameter locations and descriptions are as follows:</p> <p>Byte 0-6: Fixed value (xF0*7)</p> <p>Byte 7: Indication of MRCF. 'M' = MRCF ← Distinguishes SI390 from TC390.</p> <p>Byte 8: Subcode-1. 'R' = Resync ← Distinguishes resync from add.</p> <p>Byte 9: Subcode-2. 'Q' = Quick Mode ← Requests quick restore.</p> <p>Byte 10-11: Not used (xF0*2)</p>
		<p>(4) For a Reverse Resync request, the parameter is <b>MRROO</b>. This request is valid for MODE(RESYNC) only. The parameter locations and descriptions are as follows:</p> <p>Byte 0-6: Fixed value (xF0*7)</p> <p>Byte 7: Indication of MRCF. 'M' = MRCF ← Distinguishes SI390 from TC390.</p> <p>Byte 8: Subcode-1. 'R' = Resync ← Distinguishes resync from add.</p> <p>Byte 9: Subcode-2. 'R' = Reverse Resync ← Requests reverse resync.</p> <p>Byte 10-11: Not used (xF0*2)</p> <p>If you set a parameter other than the above parameters, the command will be rejected.</p>

Table 152: TSO command parameters (Continued)

Command	Parameter	Description
		<p>(5) For an At-Time Split Duplex request, the parameter is <b>MAnn0</b>. This request is valid for MODE(COPY) only. The parameter locations and descriptions are as follows:</p> <p>Byte 0-6: fixed value (xF0*7)</p> <p>Byte 7: Indication of MRCF. 'M' = MRCF ← Distinguishes SI390 from TC390.</p> <p>Byte 8: Subcode-1. 'A' = At-Time Split ← Distinguishes at-time split from add.</p> <p>Byte 9-10: Consistency group ID. 'nn' = Consistency group ID specified hexadecimally ← Requests at-time split duplex.</p> <p>Byte 11: Not used (xF0)</p>
		<p>(6) For an At-Time Split Resync request, the parameter is <b>MAnn0</b>. This request is valid for MODE(RESYNC) only. The parameter locations and descriptions are as follows:</p> <p>Byte 0-6: fixed value (xF0*7)</p> <p>Byte 7: Indication of MRCF. 'M' = MRCF ← Distinguishes SI390 from TC390.</p> <p>Byte 8: Subcode-1. 'A' = At-Time Split ← Distinguishes at-time split from add.</p> <p>Byte 9-10: Consistency group ID. 'nn' = Consistency group ID specified hexadecimally ← Requests at-time split resync.</p> <p>Byte 11: Not used (xF0)</p>
	SEC	Secondary volume (T-VOL): SSID, serial number, channel connection address, CU number (only for the DKC emulation type 2105).
	MODE	<p>COPY = Initial full-volume copy.</p> <p>NOCOPY = Same as COPY.</p> <p>RESYNC = Re-establish a split or suspended volume pair.</p>
	PACE	<p>For DKC emulation type 2105: Always medium.</p> <p>For others: 1 (slow), other than 1 (medium).</p>
	CRIT	Not applicable.
	MSGREQ	<p>YES = Applicable.</p> <p>NO = Not applicable.</p>

**Table 152: TSO command parameters (Continued)**

Command	Parameter	Description
	ONLINSEC	<p>YES = Does not check path group.            NO = Checks path group.</p> <p>This parameter is valid only for the DKC emulation type 2105.</p> <p>In case of MODE (COPY), the path group for the target volume (T-VOL) will be checked. In case of Quick Restore or Reverse Resync request is made in MODE (RESYNC), the path group for both the primary volume (S-VOL) and the target volume (T-VOL) will be checked.</p>
CSUSPEND	DEVN	Device number.
	PRIM	<p>Primary volume (S-VOL): SSID, serial number, channel connection address, CU number (only for the DKC emulation type 2105).</p> <p>You can set an additional parameter corresponding to each request instead of a serial number. For a steady split request, the parameter is <b>MPSOO</b>. This request is valid for steady split. The parameter locations and descriptions are as follows:</p> <p>Byte 0-6: Fixed value (xFO*7)</p> <p>Byte 7: Indication of MRCF. 'M' = MRCF ← Distinguishes SI390 from TC390.</p> <p>Byte 8: Subcode-1. 'P' = SPLIT</p> <p>Byte 9: Subcode-2. 'S' = Steady Split ← Requests steady split.</p> <p>Byte 10-11: Not used (xFO*2)</p> <p>If you set a parameter other than the above parameters, the command will be rejected.</p>
	SEC	Secondary volume (T-VOL): SSID, serial number, channel connection address, CU number (only for the DKC emulation type 2105).
	PRIMARY	Not applicable.
	QUIESCE	For information on the QUIESCE parameter, see <a href="#">CSUSPEND QUIESCE Parameter</a> on page 1111.
CDELPAIR	DEVN	Device number.

Table 152: TSO command parameters (Continued)

Command	Parameter	Description
	PRIM	<p>Primary volume (S-VOL): SSID, serial number, channel connection address, CU number (only for the DKC emulation type 2105).</p> <p>Among them, the following shows the additional parameters that can be set according to the requests made in replacement of the serial number.</p> <p>For an At-Time Split Delete request, the parameter is <b>MAnn0</b>. The parameter locations and descriptions are as follows:</p> <p>Byte 0-6: fixed value (xF0*7)</p> <p>Byte 7: Indication of MRCF. 'M' = MRCF ← Distinguishes SI390 from TC390.</p> <p>Byte 8: Subcode-1. 'A' = At-Time Split ← Distinguishes at-time split from add.</p> <p>Byte 9-10: Consistency group ID. 'nn' = Consistency group ID specified hexadecimally ← Requests at-time split delete.</p> <p>Byte 11: Not used (xF0)</p>
	SEC	Secondary volume (T-VOL): SSID, serial number, channel connection address, CU number (only for the DKC emulation type 2105).
CQUERY	DEVN	Device number.
	PATHS	Not applicable.
CRECOVER		CRECOVER is not used for SI390.
CGROUP		CGROUP is not used for SI390.

**Table 153: ICKDSF command parameters**

Command	Parameter	Description
ESTPAIR	DDNAME   SYSNAME   UNITADDRESS	DDNAME = <i>dname</i> = JCL statement identifying the volume. SYSNAME = <i>sysxxx</i> = SYSNAME in the ASSGN system control statement. UNITADDRESS = <i>ccuu</i> = device number.
	PRI	Primary volume (S-VOL): SSID, serial number, channel connection address. You can set an additional parameter corresponding to each request instead of a serial number.
		(1) For an Add and Split request (refer to <a href="#">Adding and Splitting Pairs</a> on page 1076), the parameter is <b>MSFOO</b> . This request is valid for MODE(COPY) only. The parameter locations and descriptions are as follows: Byte 0-6: Fixed value (xF0*7) Byte 7: Indication of MRCF. 'M' = MRCF ← Distinguishes SI390 from TC390. Byte 8: Subcode-1. 'S' = Split ← Requests simultaneous add and split. Byte 9: Subcode-2. 'F' = Fast Mode ← Requests quick split. Byte 10-11: Not used (xF0*2)
		(2) For a Quick Resync request, the parameter is <b>MRFOO</b> . This request is valid for MODE(RESYNC) only. The parameter locations and descriptions are as follows: Byte 0-6: Fixed value (xF0*7) Byte 7: Indication of MRCF. 'M' = MRCF ← Distinguishes SI390 from TC390. Byte 8: Subcode-1. 'R' = Resync ← Distinguishes resync from add. Byte 9: Subcode-2. 'F' = Fast Mode ← Requests quick resync. Byte 10-11: Not used (xF0*2)



Table 153: ICKDSF command parameters (Continued)

Command	Parameter	Description
		<p>(3) For a Quick Restore request, the parameter is <b>MRQ00</b>. This request is valid for MODE(RESYNC) only. The parameter locations and descriptions are as follows:</p> <p>Byte 0-6: Fixed value (xF0*7)</p> <p>Byte 7: Indication of MRCF. 'M' = MRCF ← Distinguishes SI390 from TC390.</p> <p>Byte 8: Subcode-1. 'R' = Resync ← Distinguishes resync from add.</p> <p>Byte 9: Subcode-2. 'Q' = Quick Mode ← Requests quick restore.</p> <p>Byte 10-11: Not used (xF0*2)</p>
		<p>(4) For a Reverse Resync request, the parameter is <b>MRROO</b>. This request is valid for MODE(RESYNC) only. The parameter locations and descriptions are as follows:</p> <p>Byte 0-6: Fixed value (xF0*7)</p> <p>Byte 7: Indication of MRCF. 'M' = MRCF ← Distinguishes SI390 from TC390.</p> <p>Byte 8: Subcode-1. 'R' = Resync ← Distinguishes resync from add.</p> <p>Byte 9: Subcode-2. 'R' = Reverse Resync ← Requests reverse resync.</p> <p>Byte 10-11: Not used (xF0*2)</p> <p>If you set a parameter other than the above parameters, the command will be rejected.</p>
	SEC	Secondary volume (T-VOL): SSID, serial number, channel connection address.
	MODE	<p>COPY = Initial full-volume copy.</p> <p>NOCOPY = Same as COPY.</p> <p>RESYNC = Re-established a split or suspended volume pair.</p>
	PACE	<p>For DKC emulation type 2105: Always medium.</p> <p>For others: 1 (slow), other than 1 (medium).</p>
	CRIT	Not applicable.
ESTPAIR	MSGREQ	<p>YES = Applicable.</p> <p>NO = Not applicable.</p>
	LSS	Primary volume CU number, secondary volume CU number (only for the DKC emulation type 2105).

**Table 153: ICKDSF command parameters (Continued)**

Command	Parameter	Description
SUSPEND	DDNAME   SYSNAME   UNITADDRESS	DDNAME = dname = JCL statement identifying the volume. SYSNAME = sysxxx = SYSNAME in the ASSGN system control statement. UNITADDRESS = ccuu = device number.
	PRI	Primary volume (S-VOL): SSID, serial number, channel connection address. You can set an additional parameter corresponding to each request instead of a serial number. For a steady split request, the parameter is <b>MPS00</b> . This request is valid for steady split. The parameter locations and descriptions are as follows: Byte 0-6: Fixed value (xF0*7) Byte 7: Indication of MRCF. 'M' = MRCF ← Distinguishes SI390 from TC390. Byte 8: Subcode-1. 'P' = SPLIT Byte 9: Subcode-2. 'S' = Steady Split ← Requests steady split. Byte 10-11: Not used (xF0*2) If you set a parameter other than the above parameters, the command will be rejected.
	SEC	Secondary volume (T-VOL): SSID, serial number, channel connection address.
	PRIMA	Not applicable.
	QUIESCE	For information on the QUIESCE parameter, see <a href="#">CSUSPEND QUIESCE Parameter</a> on page 1111.
	LSS	Primary volume CU number, secondary volume CU number (only for the DKC emulation type 2105).
DELPAIR	DDNAME   SYSNAME   UNITADDRESS	DDNAME = dname = JCL statement identifying the volume. SYSNAME = sysxxx = SYSNAME in the ASSGN system control statement. UNITADDRESS = ccuu = device number.
	PRI	Primary volume (S-VOL): SSID, serial number, channel connection address.
	SEC	Secondary volume (T-VOL): SSID, serial number, channel connection address.
	LSS	Primary volume CU number, secondary volume CU number (only for the DKC emulation type 2105).

**Table 153: ICKDSF command parameters (Continued)**

Command	Parameter	Description
QUERY	DDNAME   SYSNAME   UNITADDRESS	DDNAME = dname = JCL statement identifying the volume. SYSNAME = sysxxx = SYSNAME in the ASSGN system control statement. UNITADDRESS = ccuu = device number.
	PATHS	Not applicable.
RECOVER		PPRCOPY RECOVER is not used for SI390.

### PPRC Restrictions

The following table lists and describes the restrictions for using TSO/ICKDSF commands with SI390 volumes. [Table 155](#) on page 1104 lists the conditions for accepting TSO/ICKDSF commands.

**Table 154: Restrictions for PPRC commands**

Command/Parameter	Restriction	Error Report
ESTPAIR Command SUSPEND Command	Do not issue ESTPAIR or SUSPEND command to a PENDING device.	PPRC PENDING STATUS CC = 12
RECOVER Command	Recovery commands are not valid because SI390 pairs are constructed within the same XP128/XP1024.  If a recovery command is used by mistake, the result is the same as a delete pair command, except when VOLID is specified.	PPRC PENDING STATUS CC = 4
PRIMARY Parameter	SI390 does not support use of the primary parameter within the SUSPEND command.	SI390 ignores this parameter.
Set Path	Not needed for SI390.	SI390 ignores this parameter.

**Table 155: Accepting PPRC commands**

TSO PPRC Command	ICKDSF PPRCOPY Command	Issued to S-VOL	Issued to T-VOL
CESTPAIR	ESTPAIR	OK	Not accepted
CESTPAIR with MODE(RESYNC)	ESTPAIR with MODE(RESYNC)	OK	Not accepted
CSUSPEND	SUSPEND	OK	Not accepted
CDELPAIR	DELPAIR	OK	Not accepted
CQUERY	QUERY	OK	OK

### PPRC Commands with ShadowImage and TrueCopy

Both SI390 and TC390 support PPRC commands. The user must ensure that commands are being executed by the correct program against the correct volumes. A PPRC command issued to the XP128/XP1024 will be executed by SI390 against SI390 pairs if all of the following conditions are met. If any of these conditions is not met, the PPRC command will be executed by TC390 against TC390 pairs.

1. The SI390 feature and software must be installed and enabled on the XP128/XP1024.
2. The serial numbers of the S-VOL and the T-VOL must be the same.
  - a. If you enter different serial numbers for an existing S-VOL and T-VOL, the command will fail.
  - b. If you enter different serial numbers and the specified SI390 pair does not exist, the command will be executed by TC390.
3. If the XP128/XP1024 contains TC390 pairs, at least one SI390 pair must exist before the command is issued.
  - a. If the XP128/XP1024 contains both SI390 and TC390 pairs, PPRC and PPRCOPY commands that specify the same serial number for the primary (source) and secondary (target) volumes will be executed by SI390.
  - b. If the XP128/XP1024 does not contain any SI390 or TC390 pairs, PPRC and PPRCOPY commands that specify the same serial number for the primary (source) and secondary (target) volumes will be executed by SI390.

- c. If the XP128/XP1024 contains TC390 pairs but no SI390 pairs, PPRC and PPRCOPY commands that specify the same serial number for the primary (source) and secondary (target) volumes will be executed by TC390.
- d. To start SI390 operations on an XP128/XP1024 that already contains TC390 pairs, you must use the SI390 remote console software to add at least one SI390 pair. After an SI390 pair exists, the condition in 3(a) is met.

## PSF and DEVSERV Commands

The perform subsystem function (PSF) commands key the XP128/XP1024 to accept commands and requests from the user. The following table describes the operability of PSF commands on SI390 volumes. [Table 157](#) describes the PSF Read Subsystem Data and DEVSERV Sense Subsystem Status results for SI390 volumes.

**Table 156: PSF command operability for ShadowImage volumes**

Item	Operability for SI390
Device pair status.	See <a href="#">Table 157</a> .
Percent completion of the copy operation.	Not available for SI390 because the SI390 differential bitmap format is different from the TC390 differential bitmap format.
S-VOL with 2 or more T-VOLs.	Displays information for the pair having the T-VOL with the lowest LDEV ID.
Path status.	Active.
Path number.	If the volume does not also belong to a TC390 pair, 1 is displayed with TC390 info.

**Table 157: PSF and DEVSERV results for ShadowImage volumes**

Pair Status	PSF Read Subsystem Data		DEVSERV Sense Subsystem Status	
	S-VOL	T-VOL	S-VOL	T-VOL
Pending	PPRI-PNDG	PSEC-PNDG	PPRI-PNDG	PSEC-PNDG
Duplex	PPRIMARY	PSECONDRY	PPRIMARY	PSECONDRY
SP-Pend	PPRI-PNDG	PSEC-PNDG	PPRI-PNDG	PSEC-PNDG
V-Split	PPRI-SUSP	PSEC-SUSP	PPRI-SUSP	SIMPLEX

**Table 157: PSF and DEVSERV results for ShadowImage volumes (Continued)**

Pair Status	PSF Read Subsystem Data		DEVSERV Sense Subsystem Status	
	S-VOL	T-VOL	S-VOL	T-VOL
Split	PPRI-SUSP	PSEC-SUSP	PPRI-SUSP	SIMPLEX
Suspend	PPRI-SUSP	PSEC-SUSP	PPRI-SUSP	PSEC-SUSP
Resync	PPRI-PNDG	PSEC-PNDG	PPRI-PNDG	PSEC-PNDG

**Note:** PPRIMARY and PSECONDARY indicate that the volume is in the DUPLEX state.

## Adding Pairs: CESTPAIR and PPRCOPY ESTPAIR

The CESTPAIR and PPRCOPY ESTPAIR commands are equivalent to the SI390 add pair operation (changes pair status to *pending*). The following are examples of the CESTPAIR and PPRCOPY ESTPAIR commands. These commands must be issued to the S-VOL of the pair being created and the T-VOL must be offline to the host before these commands are issued.

*Example:* CESTPAIR Command

```
CESTPAIR  DEVN (X 'DE80' ) PRIM (X '0080' ,30158,X '00' ) SEC (X '0080' ,30158,X '01' )
          MODE (COPY) PACE (15)
```

*Example:* PPRCOPY ESTPAIR Command

```
//EPAIR      JOB
//           EXEC  PGM=ICKDSF
//SYSPRINT   DD  SYSOUT=*
//DD1        DD  UNIT=SYSDA,DISP=SHR,VOL=SER=DKDE80
//SYSIN      DD  *
PPRCOPY     ESTPAIR DDNAME(DD1) PRI (X'0080',30158,X'00') SEC(X'0080',30158,X'01')
           MODE(COPY) PACE(15)
/*
//
```

## Displaying Pair Status: CQUERY, PPRCOPY QUERY, DEVSERV

The CQUERY TSO and PPRCOPY QUERY ICKDSF commands are equivalent to the SI390 pair status display and status and history functions. The following are examples of the CQUERY and PPRCOPY QUERY commands.

The DEVSERV command can also be used to display SI390 pair status. For a description of the DEVSERV command results for SI390 volumes, refer to the example of the DEVSERV command on page 1109 and to [Table 157](#) on page 1105.

SI390 supports multiple T-VOLs for an S-VOL, and SI390 and TC390 can both be defined for the same volume. When multiple pairs exist on one volume, the CQUERY and PPRCOPY QUERY commands can only report the status of one pair. [Table 158](#) on page 1109 lists the status displayed by the host for the SI390 and/or TC390 volume pair configurations.

- If the XP128/XP1024 contains only SI390 pairs, the CQUERY and PPRCOPY QUERY commands will report the SI390 pair status.
- If the XP128/XP1024 contains only TC390 pairs, the CQUERY and PPRCOPY QUERY commands will report the TC390 pair status.
- If the XP128/XP1024 contains both SI390 and TC390 pairs, the CQUERY and PPRCOPY QUERY commands will report the TC390 pair status.

---

**Note:** To obtain the HRMCF pair status, issue the status command to the SI390 T-VOL or use the SI390 remote console software to view the SI390 pair status.

---

- If an S-VOL has multiple T-VOLs, the status command will report pair status for the pair whose T-VOL has the lowest LDEV ID. To obtain the status of an SI390 pair with one of the other T-VOLs, issue the status command to the T-VOL.

*Example: CQUERY Command*

```

CQUERY   DEVN (X `DE80' )
97244 13:04:38.57  TSU00684  ANTP0030I CQUERY VOLUME FORMATTED 695
695 *****
695 *                                  (PRIMARY)  (SECONDARY) *
695 *                                  SSID CCA    SSID CCA    *
695 *DEVICE      LEVEL      STATE      PATH STATUS  SERIAL#      SERIAL#
695 *-----      -
695 * DE80    PRIMARY..  DUPLEX.... ACTIVE..      0080 00      0080 01      *
695 *              CRIT(NO)                000000030158 000000030158 *
695 * PATHS SAID/DEST STATUS: DESCRIPTION
695 * -----
695 * 1      FFFF FFFF  01      PATH ESTABLISHED...
695 *      ---- ----  00      NO PATH
695 *      ---- ----  00      NO PATH
695 *      ---- ----  00      NO PATH
695 *
695 *****
97244 13:04:39.57  TSU00684  ANTP0001I CQUERY COMMAND COMPLETED. COMPLETION CODE: 00

```

**00.S@000.30158**

Indicates the serial number of SECONDARY.

Indicates that the current status is either in the process or completion of the split operation executed by the ATSPFIT command.

Indicates that the pair belongs to a consistency group.



**Example: PPRCOPY QUERY Command**

```
//EQUERY   JOB
//          EXEC   PGM=ICKDSF
//SYSPRINT DD   SYSOUT=*
//DD1      DD   UNIT=SYSDA,DISP=SHR,VOL=SER=DKDE80
//SYSIN    DD   *
PPRCOPY   QUERY DDNAME (DD1)
/*
//
```

```

                QUERY REMOTE COPY - VOLUME

                                (PRIMARY)  (SECONDARY)
                                SSID CCA    SSID CCA
DEVICE   LEVEL      STATE      PATH STATUS  SERIAL#     SERIAL#
-----  -
DE80    PRIMARY    DUPLEX    ACTIVE      0080 00     0080 01
                                30158         30158

PATHS SAID/DEST STATUS: DESCRIPTION
-----
  1    FFFF FFFF   01    PATH ESTABLISHED...
      ---- ----   00    NO PATH
      ---- ----   00    NO PATH
      ---- ----   00    NO PATH

```

**Note:** Status display is the same as the CQUERY TSO command.

**Example: DEVSERV Command**

```
97244 13:04:37.39 DS P,DE80,1
97244 13:04:38.57 IEE459I 13.04.37 DEVSERV PATHS 692
692 UNIT DTYPE M CNT VOLSER CHPID=PATH STATUS
692 RTYPE SSID CFW TC DFW PIN DC-STATE CCA DCA
692 DE80,33903 ,0,000,DKDE80,54=+ 1C=+ D4=+ 9C=+
692 0080 Y YY.YY. N PPRIMARY 00 00
```

**Table 158: Pair status reported by the host for volumes in multiple pairs**

Number of S1390 Pairs	Number of TC390 Pairs	Status Displayed by Host
0	0	SIMPLEX
1	0	S1390 pair status
2 or more	0	S1390 pair whose T-VOL has the lowest LDEV ID

**Table 158: Pair status reported by the host for volumes in multiple pairs (Continued)**

Number of SI390 Pairs	Number of TC390 Pairs	Status Displayed by Host
0	1	TC390 pair status
1	1	TC390 pair status
2 or more	1	TC390 pair status

**Table 159: Path status displayed by the CQUERY TSO and PPRCOPY QUERY DSF commands**

		CQUERY TSO Command		PPRCOPY QUERY DSF Command	
		TC390 path exists.	No TC390 path exists.	TC390 path exists.	No TC390 path exists.
SI390 S-VOL	TC390 M-VOL	Displays TC390 path	-	Displays TC390 path	-
	TC390 R-VOL	-	----	-	----
	No TC390 VOL	-	FFFF FFFF	-	FFFF FFFF
SI390 T-VOL	TC390 M-VOL	Displays TC390 path	-	Displays TC390 path	-
	TC390 R-VOL	-	-	-	-
	No TC390 VOL	-	----	-	FFFF FFFF

**Note:** The symbol “-” indicates that the combination is impossible.

## Splitting Pairs: CSUSPEND and PPRCOPY SUSPEND

The CSUSPEND and PPRCOPY SUSPEND commands are equivalent to the SI390 split pair operation (changes pair status to *SP-pend*). The following are examples of the CSUSPEND command and PPRCOPY SUSPEND commands. These commands must be issued to the S-VOL and the pair status must be *duplex*. For information on the optional QUIESCE parameter for the CSUSPEND TSO command, see [CSUSPEND QUIESCE Parameter](#) on page 1111.

*Example:* CSUSPEND Command

```
CSUSPEND DEVN (X 'DE80' ) PRIM (X '0080' ,30158,X '00' ) SEC (X '0080' ,30158,X '01' )
```

**Example: PPRCOPY SUSPEND Command**

```
//EPAIR      JOB
//           EXEC  PGM=ICKDSF
//SYSPRINT   DD  SYSOUT=*
//DD1       DD  UNIT=SYSDA,DISP=SHR,VOL=SER=DKDE80
//SYSIN     DD  *
PPRCOPY     SUSPEND DDNAME(DD1) PRI(X'0080',30158,X'00') SEC(X'0080',30158,X'01')
/*
//
```

**CSUSPEND QUIESCE Parameter**

**Caution:** The CSUSPEND QUIESCE option has been disabled by APAR OW15247 or APAR OW15248. For detailed information on the QUIESCE option, refer to either of these APARs. Check with your HP account team before using the QUIESCE option with the XP128/XP1024. If the QUIESCE option is issued to certain volumes (for example, active SPOOL, PAGE, or CATALOG datasets, or active SYSRES volume), the attached host(s) may enter a deadlock condition and may require a storage control IML to correct the condition.

The QUIESCE parameter is used to modify the functionality of the CSUSPEND TSO command. For example, if the QUIESCE parameter is specified, the pair will be inactive and subsequent write requests to the S-VOL will be suspended by the host until the QUIESCE condition is released. If the QUIESCE parameter is not specified, subsequent write operations will be rejected and write-reserved write requests will be processed. The following table lists the requirements for using the QUIESCE parameter with SI390 pairs.

**Table 160: QUIESCE parameter requirements for ShadowImage**

Pair Status	QUIESCE Accepted?
Simplex	No
Pending	No
Duplex	Yes
SP-Pend	No
V-Split	No
Split	No
Resync	No
Suspend	No

If an SI390 S-VOL has more than one T-VOL, the QUIESCE parameter is effective if at least one pair is specified. Write requests at the S-VOL will start when all QUIESCE conditions are released. The following conditions cause the XP128/XP1024 to automatically release the QUIESCE condition:

- A CSUSPEND TSO command without the QUIESCE parameter is accepted.
- A CDELPAIR TSO command is accepted.
- A Delete, Suspend, or Split Pair command (from the Remote Console PC) is accepted.
- Disk array power-on-reset is executed.

**Note:** If an SI390 pair is suspended because of an internal disk array error condition, the QUIESCE option is applied. In this case, release the QUIESCE condition by deleting the pair.

SI390 and TC390 are processed independently. The CSUSPEND/QUIESCE command is effective for either the SI390 or TC390 pair specified in the command.

## Resynchronizing Pairs: MODE(RESYNC) Parameter

The MODE(RESYNC) option of the CESTPAIR and PPRCOPY ESTPAIR commands is equivalent to the SI390 normal resync operation (changes pair status to *resync*). The following are examples of the CESTPAIR command with the MODE(RESYNC) parameter and the PPRCOPY ESTPAIR command with the MODE(RESYNC) parameter. These commands must be issued to the S-VOL and the pair status must be *split* or *suspend* when MODE(RESYNC) is specified.

**Example:** CESTPAIR with MODE(RESYNC) Parameter

```
CESTPAIR  DEVN (X 'DE80' )  PRIM (X '0080' ,30158,X '00' ) SEC (X '0080' ,30158,X '01' )
          MODE (RESYNC)  PACE (15)
```

**Example:** PPRCOPY ESTPAIR with MODE(RESYNC) Parameter

```
//EPAIR      JOB
//           EXEC  PGM=ICKDSF
//SYSPRINT   DD  SYSOUT=*
//DD1        DD  UNIT=SYSDA,DISP=SHR,VOL=SER=DKDE80
//SYSIN      DD  *
PPRCOPY     ESTPAIR DDNAME(DD1) PRI (X'0080',30158,X'00') SEC (X'0080',30158,X'01')
            MODE (RESYNC) PACE (15)
/*
//
```

## Deleting Pairs: CDELPAIR and PPRCOPY DELPAIR

The CDELPAIR and PPRCOPY DELPAIR commands are equivalent to the SI390 delete pair operation (changes pair status to *simplex*). The following are examples of the CDELPAIR and PPRCOPY DELPAIR commands. These commands must be issued to the S-VOL.

A DELPAIR command performed when pair status is *split* enables the T-VOL to be accessed by the host. A DELPAIR command performed when pair status is other than *split* allows non-reserved T-VOLs to be accessed by the host. Reserved *simplex* volumes cannot be accessed.



**Caution:** For duplex SI390 pairs, the S-VOL and its associated T-VOL(s) are usually not identical because SI390 update copy operations are asynchronous. Therefore, if a pair is deleted with status other than *split*, the data integrity of the T-VOL cannot be guaranteed.

*Example:* TSO Delete Command

```
CDELPAIR  DEVN (X 'DE80' )  PRIM (X '0080' ,30158,X '00' )  SEC (X '0080' ,30158,X '01' )
```

*Example:* ICKDSF Delete Command

```
//EPAIR      JOB
//          EXEC  PGM=ICKDSF
//SYSPRINT   DD  SYSOUT=*
//DD1        DD  UNIT=SYSDA,DISP=SHR,VOL=SER=DKDE80
//SYSIN      DD  *
PPRCOPY     DELPAIR DDNAME(DD1) PRI(X'0080',30158,X'00') SEC(X'0080',30158,X'01')
/*
//
```

## Setting and Resetting the At-Time Split Time: ATSPLIT

Use the ATSPLIT command to set or reset the time to perform the At-Time Split operation.

**Table 161: Parameters of ATSPPLIT command**

Parameter	Description
DEVN	Use this parameter to specify the four-digit device address. When a four-digit device address is specified, an ATSPPLIT command will be issued to the specified device. The specified device must be an arbitrary S-VOL belonging to the consistency group that you intend to split.
GROUP	Use this parameter to specify the ID of the consistency group with a two-digit hexadecimal number. The ID you specify must match with the ID of the consistency group where the device you specified belongs.
GENID	Use this parameter to specify the two-digit hexadecimal GenerationID. The GenerationID you specify here will be displayed as the ATQUERY command output information.
TIME	Use this parameter to specify the time you want to perform the Split operation. Specify the time in UTC (Universal Time Coordinated=GMT) and in the format of <i>hh:mm:ss</i> .
DATE	Use this parameter to specify the date you want to perform the Split operation. Specify the date in <i>yyyymmdd</i> . If you omit this parameter, the Split operation will be performed on the day the ATSPPLIT command is executed. Be sure to set the time for performing the Split operation that is later than the time and date when the ATSPPLIT command is executed.
NOWPLUS	Use this parameter to specify the time you want the Split operation to be performed, counting from the current time. Specify the time in <i>hh:mm:ss</i> format (using the numerals that are not bigger than 23:59:59).  This parameter is valid when only one subsystem is used. When more than one subsystem is used, the time set to each subsystem may differ. If they differ, you may not gain the proper result as you expected.

**Table 161: Parameters of ATSPPLIT command (Continued)**

Parameter	Description
ATLOCAL	Use this parameter to specify the local time (in <i>hh:mm:ss</i> format) and date (in <i>yyyymmdd</i> format) you want to perform the Split operation. For the guarantee period of the Split operation, you can specify any value that is equal or smaller than 32768 minutes.
ATGMT	Use this parameter to specify the Split time in UTC (Universal Time Coordinated=GMT) using the <i>hh:mm:ss</i> format. For the guarantee period of the Split operation, you can specify any value that is equal or smaller than 32768 minutes.
CANCEL	Use this parameter to reset the Split time that you have specified by using the ATSPPLIT command.  You cannot use this parameter at the same time with the TIME parameter or the NOWPLUS parameter. If you do so, your ATSPPLIT command will be rejected.

*Example:* ATSPPLIT Command

```
ATSPPLIT DEVN(X'7920') DATE(20021001) TIME(22:38:50) GROUP(X'1A') GENID(X'1B')
ATSPPLIT DEVN(X'7100') NOWPLUS(00:01:30) GROUP(X'01') GENID(X'1B')
ATSPPLIT DEVN(X'7100') ATLOCAL(20021031,10:08:30,10) GROUP(X'05') GENID(X'1B')
ATSPPLIT DEVN(X'0010') GROUP(X'10') GENID(X'1B') CANCEL
```

The purpose of the ATSPPLIT command is to reserve the time that you want to perform the Split operation. The Split operation is performed at the time specified by the ATSPPLIT command and not when you execute this command. To check whether the Split operation is performed at the time as specified, confirm it by executing the ATQUERY or CQUERY command.

The Split operation is performed at the time of reception of the read/write request with a time stamp that has passed the time specified as the Split time. The Split operation may be delayed in case no read/write request is issued and the Split operation, as a result, is performed as a result of timeout of the subsystem timer.

In case there is a pair in the consistency group that cannot be split completely during the Split operation, the status of this pair will remain the same as before the Split operation.

## Displaying the Status of the Consistency Group: ATQUERY

The ATQUERY command is used to display the status of the consistency group.

*Example:* ATQUERY Command

```

ATQ091I  DEVN(X'7920')  GROUP(X'7F')  GENID(X'01')
ATQ092I  PAIRS - INGROUP(0100),SUSP(0080),TRANS(0018),PEND(0000),
          DUPL(0002),RESYNC(0000),FAILED(0000)
ATQ093I  PRESET  STATUS: NOT SET
ATQ094I  PRESET  STATUS: SET  yyyyymmdd hhmmss - WAITING
ATQ095I  PRESET  STATUS: SET  yyyyymmdd hhmmss - TIMESTAMP TRIGGERED
ATQ096I  PRESET  STATUS: SET  yyyyymmdd hhmmss - TIMEOUT TRIGGERED

```

The meaning of each ATQUERY command example shown in the previous example is explained in the following table.

**Table 162: Description of the ATQUERY command examples**

Item	Description
ATQ091I	Indicates the following information hexadecimally: Device number (DEVN) ID of the consistency group (GROUP) where the specified device belongs to GenerationID (GENID)
ATQ092I	Indicates the following decimally-displayed information of the device to which the ATQUERY command is issued: Total number of pairs in the consistency group where the specified device belongs to (INGROUP) Number of pairs in the consistency group that are in the Split status (SUSP) Number of pairs in the consistency group that are currently splitting (TRANS) Number of pairs in the consistency group that are in the Pending status (PEND) Number of pairs in the consistency group that are in the Resync status (RESYNC) Number of pairs in the consistency group that changed their status to Suspend due to error (FAILED)
ATQ093I	Indicates that there is no ATSPLIT command set to specify the Split time.



**Table 162: Description of the ATQUERY command examples (Continued)**

Item	Description
ATQ094I	Indicates that there is an ATSPLIT command set to specify the Split time, but it is still not that specified time and no timeout is detected as yet.
ATQ095I	Indicates that the Split operation has started because the time reached the specified Split time.
ATQ096I	Indicates that the Split operation has started as a result of the detection of timeout.

The ATQUERY command must be issued to the T-VOL in the consistency group. If it is issued to any other volumes in the consistency group, it will be rejected.

## Using ShadowImage - FlashCopy

ShadowImage - FlashCopy is functionally compatible with the IBM FlashCopy host software function. PPRC TSO commands and/or DFSMSdss commands may be used to perform ShadowImage - FlashCopy operations on the XP128/XP1024. See [Using ShadowImage - FlashCopy Host Commands](#) on page 1124 for further information on using PPRC TSO commands and DFSMSdss commands.

To enable the ShadowImage - FlashCopy function on the XP128/XP1024, SI390 and ShadowImage - FlashCopy must be installed and enabled on the disk array.

## Overview of ShadowImage - FlashCopy

The ShadowImage - FlashCopy function provides a fast data replication capability. This function creates a copy of an S-VOL to a T-VOL virtually or physically. When the ShadowImage - FlashCopy function is used with PPRC TSO commands or DFSMSdss commands, a relationship is established between the S-VOL and T-VOL where the T-VOL (the virtual or physical copy of the S-VOL) is available for both read and write operations.

When you establish a relationship for an ShadowImage - FlashCopy pair, you can specify a range of data to be copied, which is called the “extent.” When the extent data copy is complete, the relationship ends automatically.

You can establish an ShadowImage - FlashCopy pair not only for SI390 simplex volumes, but also for SI390 S-VOL or T-VOL in the split or duplex status.

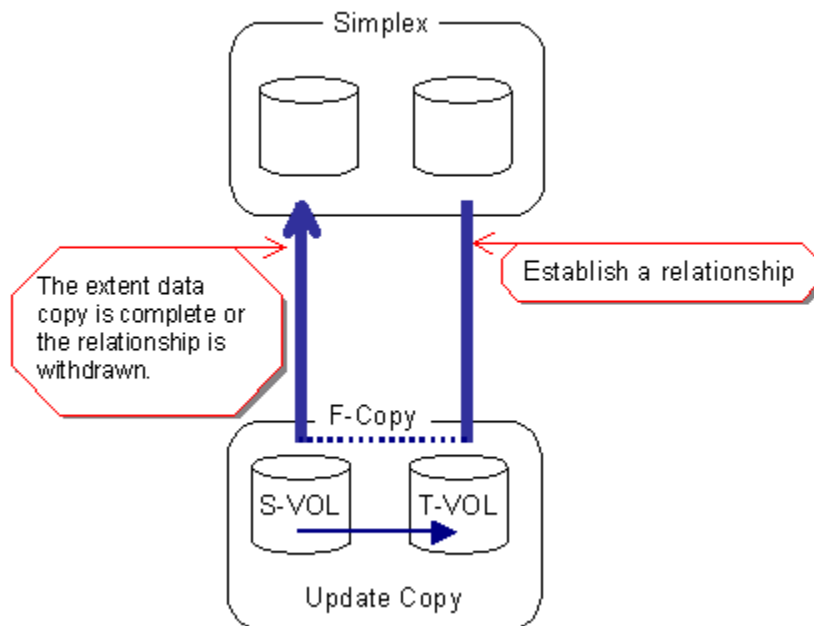
**Table 163: Requirements for ShadowImage - FlashCopy**

Item	Requirement
Controller emulation type	I-2105
SSID boundary setting	256-LDEV (The SSID boundary of IBM ESS is 256-LDEV.)

- When the SSID boundary is 64-LDEV, S-VOL and T-VOL must be established in the same CU image and SSID.
- When a relationship is established and the SSID boundary is changed from 256-LDEV to 64-LDEV, the SSIDs for T-VOL and S-VOL become different. Because of this condition, the relationship cannot be deleted from the host. In this case, you should delete the relationship from SI390 on the Remote Console PC.

## ShadowImage - FlashCopy Pair Status

The following figure illustrates the pair status transition and the relationship between the pair status and the ShadowImage - FlashCopy operations.



**Figure 395: ShadowImage - FlashCopy pair status transition**

**Note:** When the extent data copy fails, the ShadowImage - FlashCopy relationship ends automatically (the status becomes simplex) and the T-VOL is blocked.

The following table describes the ShadowImage - FlashCopy pair status condition.

**Table 164: ShadowImage - FlashCopy pair status condition**

Status	Description	Host Status	S-VOL Access	T-VOL Access
F-Copy	ShadowImage - FlashCopy is requested with host commands. The S-VOL differential data is copied to the T-VOL in the background. When the NOCOPY option is specified, no background copy is performed.	S-VOL = SIMPLEX T-VOL = SIMPLEX	Read/write.	Read/write, can be varied online.

## Establishing ShadowImage - FlashCopy Pairs

You can establish an ShadowImage - FlashCopy pair for an SI390 simplex volume. The following table shows the allowable ShadowImage - FlashCopy operations for each pair status. You can also add an ShadowImage - FlashCopy pair for SI390 S-VOL or T-VOL in the split or duplex status (see [Table 166](#) on page 1122 and [Table 167](#) on page 1122). However, you cannot establish a ShadowImage - FlashCopy pair, if the S-VOL has already three T-VOLs.

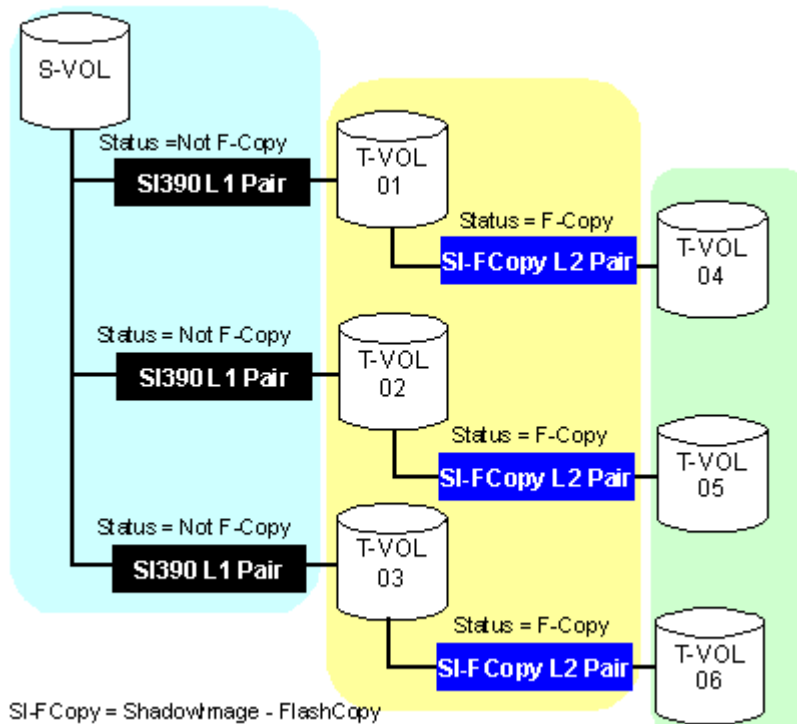
**Table 165: Pair Status versus allowable operations**

Operation	Pair Status									
	SI390									SI - FC
	Simpl.	Pend.	Dupl.	SP-Pend	V-Spl.	Spl.	Resync	Resync-R	Susp.	F-Copy
Split Pair	OK	OK	OK	x	x	x	x	x	x	x
Suspend Pair	x	OK	OK	OK	OK	OK	OK	x	OK	x
Resync Pair	x	x	x	x	OK	OK	x	x	OK	x
Reverse Resync, Quick Restore	x	x	x	x	x	OK	x	x	x	x
Delete Pair	x	OK	OK	OK	x	OK	OK	OK	OK	OK
Establish Relationship	OK	x	x	x	x	x	x	x	x	x
Withdraw Relationship	x	x	x	x	x	x	x	x	x	OK

ShadowImage - FlashCopy adds a second layer of ShadowImage - FlashCopy pairs onto the first layer of original SI390 pairs. These two layers of pairs (L1 and L2) can create up to six copies of one original SI390 source volume (S-VOL).

**Note:** You cannot add an ShadowImage - FlashCopy L2 pair onto an ShadowImage - FlashCopy L1 pair, an SI390 L2 pair onto an SI390 L1 pair, or any third layer of pair (L3 pair) onto an L2 pair.

The following figure shows an example of combining ShadowImage - FlashCopy and SI390 pairs in the L1 and L2 pairs.



**Figure 396: Possible combination of ShadowImage - FlashCopy and SI390 pairs**

The following table shows the relationship between the L1 pair status and the availability of SI390 or ShadowImage - FlashCopy pair operations on the associated L2 pairs. [Table 167](#) on page 1122 shows the relationship between the L2 pair status and the availability of pair operations on the associated L1 pairs.

**Table 166: Relationship between L1 pair status and L2 pair operations**

L1 Pair Status	L2 Pair Operations						
	Add Pair	Split Pair	Resync Pair	Reverse Resync/ Quick Restore	Susp.	Delete	Establish Relationship
Pending	The combination has no relationship with the ShadowImage - FlashCopy pair. You cannot perform the operation.					OK	NO
Duplex						OK	NO
SP-Pend						OK	NO
V-Split						OK	NO
Split						OK	OK
Resync						OK	NO
Reverse Resync, Quick Restore						OK	NO
Suspend						OK	NO

**Table 167: Relationship between L2 pair status and L1 pair operations**

L2 Pair Status	L1 Pair Operations						
	Add Pair	Split Pair	Resync Pair	Reverse Resync/ Quick Restore	Susp.	Delete	Establish Relationship
F-Copy	NO	NO	NO	NO	OK	OK	NO

**Note:** You cannot create a pair that has a T-VOL shared with the S-VOL of an L1 pair.

## Combining ShadowImage - FlashCopy With Other Copy Solutions

You can combine an ShadowImage - FlashCopy pair with a TC390 or XRC pair (see the following table and [Table 169](#) on page 1124).

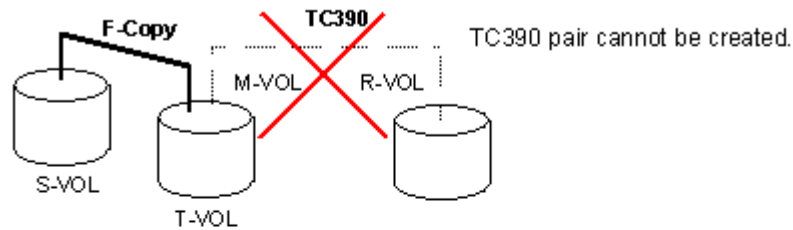
**Table 168: ShadowImage - FlashCopy and TC390 shared volume**

	TC390 M-VOL	TC390 R-VOL
ShadowImage - FlashCopy S-VOL	OK	OK The TC390 pair must be suspended (status = suspend)
ShadowImage - FlashCopy T-VOL	NO	NO

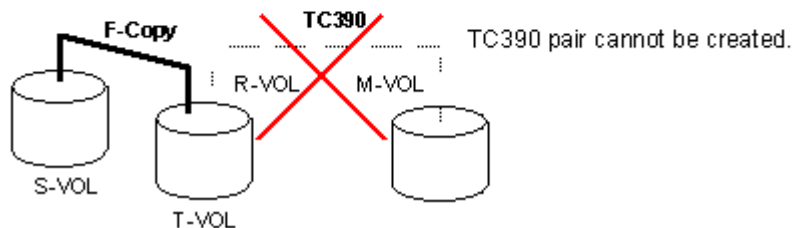
The ShadowImage - FlashCopy and TC390 shared configuration is different from the IBM FlashCopy and PPRC shared configuration. For ShadowImage - FlashCopy and TC390, you cannot create the following TC390 pairs (see the following image):

- A TC390 pair that includes a volume functioning as both an ShadowImage - FlashCopy T-VOL and a TC390 M-VOL.
- A TC390 pair that includes a volume functioning as both an ShadowImage - FlashCopy T-VOL and a TC390 R-VOL.

Case 1:



Case 2:



**Figure 397: ShadowImage - FlashCopy and TC390: shared T-VOL and M-VOL/R-VOL (not allowed)**

**Note:** For IBM FlashCopy and PPRC, you can create a PPRC pair that includes a volume functioning as both a FlashCopy target volume and a PPRC primary volume, and a PPRC pair that includes a volume functioning as both a FlashCopy target volume and a PPRC secondary volume.

**Table 169: ShadowImage - FlashCopy and XRC shared volume**

	XRC Primary Volume	XRC Secondary Volume
ShadowImage - FlashCopy S-VOL	OK	OK
ShadowImage - FlashCopy T-VOL	NO	NO

## Using ShadowImage - FlashCopy Host Commands

ShadowImage - FlashCopy supports both DFSMSdss commands and TSO PPRC commands to perform ShadowImage - FlashCopy operations from the S/390 host system.

Before you use ShadowImage - FlashCopy, you must take the following steps:

1. Install the SI390 feature and software.
2. Install the ShadowImage - FlashCopy feature and software.
3. Change the corresponding devices offline to the host, and then change the devices online to the host again. This ensures that you have the latest device information before performing ShadowImage - FlashCopy operations. This offline/online operation is required just once.

ShadowImage - FlashCopy does not support the REMOVEFCPY parameter of ICKDSF CONTROL command. To delete the relationship of all the ShadowImage - FlashCopy pairs established in the disk array, use the SI390 main screen.

## DFSMSdss Command Support

ShadowImage - FlashCopy can be used by the COPYFULL command (description) through the DFSMSdss commands. When ShadowImage - FlashCopy copy is requested, DFSMSdss automatically determines whether it is an ShadowImage - FlashCopy copy request or an ordinary SI390 copy request through the host. The COPYFULL command completes within a few seconds and the ShadowImage - FlashCopy pair is established at once. ShadowImage -



FlashCopy data is copied in the background and the completion of copy is not reported to the user. The following shows an example of the DFSMSdss commands.

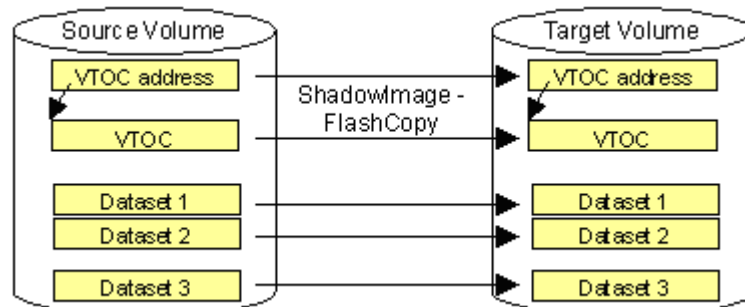
*Example:* DFSMSdss Commands

```
//COPYFULL JOB.....
//*
//INSTIMG EXEC PGM=ADRDSU
//SYSPRINT DD SYSOUT=*
//SYSUDUMP DD SYSOUT=V,OUTLIM=3000
//SYSIN DD *
COPY FULL INDYNAM (SORCEV) OUTDYNAM (TRGVOL) COPYVOLID
/*
```

ShadowImage - FlashCopy can establish a relationship for one volume pair at a time. When ShadowImage - FlashCopy copy is requested for a volume pair in the F-Copy status, DFSMSdss identifies the request as an SI390 copy request through the host and performs SI390 copy operations.

The COPYVOID option is used to copy the volume serial number (VOLSER). If the COPYVOID option is specified, the volume serial number is copied to the target volume and the target volume becomes offline automatically. This COPYVOID option was necessary for SMS-managed volumes until the DUMPCONDITIONING parameter was added to DFSMSdss with APAR OW 45674. If the DUMPCONDITIONING parameter is specified, there is no need to copy the volume serial number for SMS-managed volumes.

When the DFSMSdss command is executed, all datasets on the source volume are copied to the target volume. Volume area that is not allocated as a dataset is not copied.



**Figure 398: Copying All Datasets Using DFSMSdss Command**

---

**Note:** You cannot specify both the COPYVOID option and DUMPCONDITIONING parameter at the same time.

---

The following conditions cause the XP128/1024 to output the ADR935W message and end with CC = 4 (SI390 copy is performed through the host):

- The size of the target volume is larger than the source volume within the same CU image.
- The emulation types of the source and target volumes are different within the same CU image.

---

**Note:** When the SSID boundary is 64-LDEV and you establish a relationship between two volumes that have the same CU image but different SSIDs, you can copy data from S-VOL to T-VOL by the host program.

---

## TSO Command Support

The following table lists and describes the TSO commands supported by ShadowImage - FlashCopy. [Table 171](#) on page 1128 lists and describes the TSO command parameters supported by ShadowImage - FlashCopy.

---

**Note:** To use the following PPRC TSO commands, you must add the command names to the AUTHCMD PARM of IKJTSOxx that is a member of SYS1.PARMLIB, because the system is protected by RACF Facility.

---

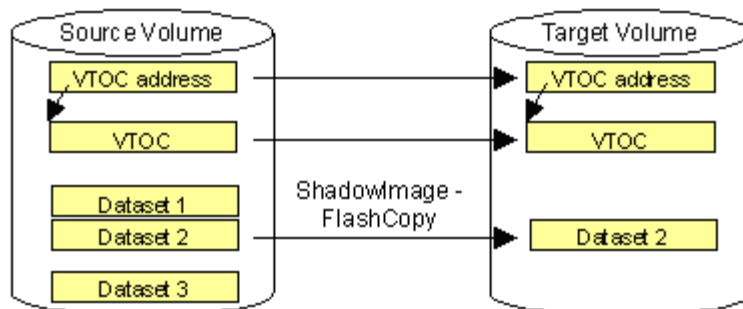
**Table 170: PPRC TSO commands**

ShadowImage - FlashCopy Operation	PPRC TSO Command	Function	Restrictions
Add ShadowImage - FlashCopy Pair	FCESTABL	Establishes a relationship between the source and target volumes.	The specified volume must be simplex. When the SSID boundary is 64-LDEV, S-VOL and T-VOL for ShadowImage - FlashCopy must be established in the same CU image and SSID.
Delete ShadowImage - FlashCopy Pair	FCWITHDR	Withdraws the relationship of an existing ShadowImage - FlashCopy pair.	The specified volume must have an established relationship. When the SSID boundary is 64-LDEV, S-VOL and T-VOL for ShadowImage - FlashCopy must be established in the same CU image and SSID. When S-VOL and T-VOL are in the different SSIDs, delete the relationship from the SI390 window on the Remote Console PC.
Display ShadowImage - FlashCopy Pair Status	FCQUERY	Displays detailed pair status information.	None.

**Table 171: PPRC TSO command parameters**

Command	Parameter	Description
FCESTABL	SDEVN	Source device number.
	TDEVN	Target device number.
	MODE	COPY = Data is copied in the background. Normally, the relationship ends automatically after all of the data has been copied. NOCOPY = Data is not copied in the background. It is necessary to issue FCWITHDR command to delete the relationship specified with NOCOPY option. Before ShadowImage - FlashCopy read/write processing actually starts, all of the data in an accessed track of the S-VOL is copied to the T-VOL when one of the following data access occurs: <ol style="list-style-type: none"> <li>1. Write data access to the extents of the S-VOL.</li> <li>2. Write data access to the extents of the T-VOL.</li> <li>3. Read data access to the extents of T-VOL.</li> </ol> The timing of ShadowImage - FlashCopy data copying is different from IBM FlashCopy. IBM FlashCopy copies data when data in either the source or target volume is updated.
	ONLINTGT	YES = The path group is not checked.NO = The path group is checked.
	EXTENTS	Extents specify the range of copy by CCHH. Up to five extents can be specified.
FCWITHDR	SDEVN	Source device number.
	TDEVN	Target device number.
FCQUERY	DEVN	Device number.

When the TSO command (FCESTABL command) is executed, only the extents specified by the EXTENTS parameter are copied from the source volume to the target volume. For example, the following figure shows an example of copying Dataset 2 only. If the EXTENTS parameter is not specified, the entire source volume is copied to the target volume.



**Figure 399: Copying Specified Dataset Using TSO (FCESTABL) Command with EXTENTS Parameter**

**To copy one or more dataset using the TSO (FCESTABL) command:**

1. Check the VTOC list to confirm VTOC (including INDEX VTOC) and the address (cylinder number and header number) of the dataset(s) that you want to copy.
2. Vary the T-VOL offline.
3. Execute the FCESTABL command. You must specify the following items by the EXTENTS parameter. If you access a dataset that is not specified by the EXTENTS parameter, the operation cannot be guaranteed.

- Dataset(s) to be copied. If you want to copy multiple datasets, you must specify the extents of all of the desired datasets.
- VTOC address (Cylinder 0, header 0).
- VTOC.

If the dataset(s) uses the following items, you must also specify those items by the EXTENTS parameter.

- INDEX VTOC.
- VSAM volume dataset of the VSAM file (SYS1.VVDS.Vxxxxxx,xxxxxx is VOLSER).

4. Change the VOLSER of the T-VOL. You must change the VOLSER of the T-VOL before varying the T-VOL online because the VOLSERS of the S-VOL and T-VOL become identical as a result of copying VTOC.
5. Vary the T-VOL online.

## Adding ShadowImage - FlashCopy Pairs: FCESTABL

The following shows an example of the FCESTABL command.

*Example:* FCESTABL Command

```
FCESTABL SDEVN(X'DE80') TDEVN(X'DE81') MODE(COPY) ONLINTGT(YES)
EXTENTS(X'00010000' X'0100000E')
```

## Deleting ShadowImage - FlashCopy Pairs: FCWITHDR

The FCESTABL command can be issued to an ShadowImage - FlashCopy pair for which a relationship has already been established. The following shows an example of the FCWITHDR command.



**Caution:** If a pair is deleted by the FCWITHDR command, the data integrity of the T-VOL cannot be guaranteed.

*Example:* FCWITHDR Command

```
FCWITHDR SDEVN(X'DE80') TDEVN(X'DE81')
```

## Displaying ShadowImage - FlashCopy Pair Status: FCQUERY

The FCQUERY command can be used to display ShadowImage - FlashCopy pair status. The following shows an example of FCQUERY command.

*Example:* FCQUERY Command

```
ANTF0090IF CQUERY Formatted
DEVN SSID LSS CCA CU SERIAL STATUS
0A4D 2830 03 0D 2105 0000325476 FC . . . . . 88%
_____ 2830 03 07 2105 0000325476 FC . . . . .
```

**Table 172: Status displayed by FCQUERY command**

Pair Status	Description
SIMPLEX	Volume is in the simplex status.
XRC	Used by XRC source volume.
PPRC	PPRC pair.
FC xxx%	ShadowImage - FlashCopy pair. If data is being copied in the background, the copy progress (%) is also displayed.

## **Cautions on Switching Off the Power Supply When Using ShadowImage - FlashCopy**

If you have to switch off the power supply of the disk array during ShadowImage - FlashCopy operations, make sure to complete copying for the ShadowImage - FlashCopy pair, and then switch off the power supply. If the shared memory is volatilized when you switch on the power supply again, the following conditions occur:

- The relationship of the ShadowImage - FlashCopy pair is deleted.
- The target volume of the ShadowImage - FlashCopy pair is blocked.

## Troubleshooting

### General ShadowImage Troubleshooting

If an SI390 error code or message is displayed on the Command View management station, refer to [ShadowImage Error Window](#) on page 1133 for a description of the SI390 error codes and recommended corrective action.

---

**Note:** Make sure to copy the SVP configuration information onto floppy disks) using the **FD Dump Tool** and give the floppy disk(s) to HP service personnel.

---

The following table provides general troubleshooting instructions for SI390 operations.

**Table 173: General ShadowImage troubleshooting**

Error	Corrective Action
SI390 operations do not function properly.	Verify all SI390 requirements and restrictions are met. Verify the XP128/XP1024 is powered on and fully functional (NVS, cache, DFW). Check all input values and parameters to verify that you entered the correct information on the SI390 screens (for example, P-VOL and S-VOL IDs).
The volume pairs are not displaying correctly.	Verify the correct CU image is selected.
An SI390 error message is displayed on the Command View management station.	For a description of the error code, refer to <a href="#">ShadowImage Error Window</a> on page 1133.
There is a problem with the management station.	Save the Java log file on the management station and report to HP technical support. For Windows 2000, the Java log file is in the following place: C:\Documents and Settings\login user ID\ plugin131.trace Exit the Web browser, close all other applications, and then restart the PC. If the problem persists, verify that the PC's operating system and LAN hardware and software are properly configured.



**Table 173: General ShadowImage troubleshooting (Continued)**

Error	Corrective Action
The SI390 pair status is incorrect (or unexpected).	The pair may have been suspended or deleted from the UNIX/PC server host using RAID Manager. If not, the XP128/XP1024 detected an error condition during SI390 operations. Check the SVP error log. If necessary, call HP technical support for assistance.
There is a pinned track on an SI390 volume.	If a pinned track occurs on an SI390 S-VOL or T-VOL, the XP128/XP1024 will suspend the pair. Contact your HP representative for assistance in recovering pinned tracks.
Only the Exit and Refresh buttons are effective when accessing the SVP from the Command View management station.	The SVP might not be ready or perform some write processes from the other system. Wait for a while, and then click <b>Refresh</b> .

## ShadowImage Error Window

The SI390 Java applet program displays error messages on the Command View management station when error conditions occur during SI390 operations. The ShadowImage Error window displays the SI390 error code and message. To display the Error window, select the failed volume in the Preset Volume List box on the ShadowImage main screen, right-click to display the pop-up menu, and then click **Detail**.



# HPAV for the XP128/XP1024 (Mainframe)

24

HPAV (Hitachi Parallel Access Volume) enables a mainframe host system to issue multiple I/O requests in parallel to logical devices (LDEVs) on an XP128/XP1024. When HPAV is not used, the host system can start only one I/O request to a device at a time and must wait for the I/O to complete before starting another I/O request to the same device. HPAV allows the host system to start multiple I/O requests to the same device at the same time through the alias addresses assigned to a device. When HPAV is used, the S/390 host computer has substantially faster access to the data stored in the XP128/XP1024.

The two types of devices used in HPAV operations are base devices and alias devices. The base devices are the installed devices that contain user data. The alias devices are installed but are unused devices whose addresses can be used as aliases for the base devices. The XP128/XP1024 supports up to 256 devices per logical control unit (CU), including base and alias devices, for a maximum of 8,192 device addresses per disk array.

HPAV on the Command View management station configures HPAV devices on the XP128/XP1024, such as assigning aliases to base devices, canceling aliases, and so forth. The Command View management station is attached to and communicates directly with the XP128/XP1024 through the LAN.

The Workload Manager (WLM) host software function enables the S/390 host to use the HPAV functionality of the XP128/XP1024. WLM compatibility mode provides static HPAV functionality and WLM goal mode provides dynamic HPAV functionality. The XP128/XP1024 supports both static and dynamic HPAV. When static HPAV is used, the number of aliases assigned to each base device does not change. For dynamic HPAV, the number of aliases assigned to a base device can change depending on the number of host I/O requests to that device. For more information on static and dynamic HPAV, see [Static and Dynamic HPAV Operations](#) on page 1138.

## Overview of HPAV Operations

### Components

The components that are involved in HPAV operations are:

- Base devices and alias devices on the disk array (see page 1136)
- Controller emulation type for the disk array (see page 1137)
- HPAV software enabled on the disk array through the Command View management station (see [Managing License Keys](#) on page 85 and/or [Command View-based HPAV](#) on page 1137)
- Hardware Configuration Definition (HCD) definitions for the disk array (see page 1137)
- WLM host software definitions for dynamic alias management (see page 1138)

### Base Devices and Alias Devices

The XP1024 supports a maximum of 8,192 logical devices (LDEVs), up to 256 LDEVs per logical control unit (CU) image and up to 32 CU images. The number of LDEVs per parity group depends on the hard disk drive (HDD) type, RAID level, and device emulation type (for example, 3390-3R) of the parity group. Each LDEV is uniquely identified by its LDEV ID, which consists of the logical CU image number (0, 1, 2...F) and device number (00-FF hexadecimal) (for example, x0:0F = device 0F in CU image 0).

LDEVs that are formatted as S/390 devices (for example, 3390 or 3380) are called logical volume images (LVIs) or volumes. LDEVs formatted as open system devices (for example, OPEN-3 or OPEN-9) are called logical units (LUs). HPAV operations can be performed only on 3390 LVIs.

The two device types for HPAV operations are:

- **Base device – 3390B:** A base device is a formatted LVI that contains user data and to which one or more alias devices can be assigned. A base device must be defined to the host as a 3390B device type (for example, 3390B-3 or 3390B-9).
- **Alias device – 3390A:** An alias device is a formatted but unused logical device whose LDEV ID (address) can be used as an alias for a base device. Alias devices cannot be modified online. Each alias must be within the same

logical CU image as the base device to which it is assigned. An alias device must be defined to the host as a 3390A device type (for example, 3390A-3 or 3390A-9).

---

**Note:** The 3390A and 3390B devices are not related to the 3390-3A/B/C multiplatform devices.

---

## Controller Emulation Type

The IBM 2105 controller emulation type is required for HPAV operations. Each logical CU image on the XP128/XP1024 that contains HPAV base and alias devices must be set for 2105 controller emulation.

---

**Note:** To configure copy devices and HPAV devices under the same logical CU image, refer to [Table 175](#) on page 1141 for important information and instructions. Copy devices include TrueCopy (TC390), PPRC, and XRC devices.

---

## Command View-based HPAV

HPAV running under Command View configures the HPAV devices on XP128/XP1024 that have been registered with Command View. HPAV displays the LDEVs in use and the unassigned LDEV IDs that are available for use as aliases. You can use HPAV to assign aliases to base devices and cancel aliases.

---

**Note:** HPAV will not function for an XP128/XP1024 that does not have the HPAV option enabled on it (see [Enabling the HPAV Options](#) on page 1146).

---

## HCD Definitions for the XP128/XP1024 HPAV Devices

The HPAV base and alias devices on the XP128/XP1024 must be defined to the host system using HCD. The XP128/XP1024 base devices must be 3390B devices (for example, 3390B-3) and the XP128/XP1024 alias devices must be 3390A devices (for example, 3390A-3). The required controller emulation for each XP128/XP1024 CU image that contains HPAV devices is 2105 emulation. [Using HCD to Define and View XP128/XP1024 LCUs and HPAV Devices](#) on page 1162 provides sample instructions on using HCD to define an HPAV device.

**Note:** The 3390A and 3390B devices are not related to the 3390-3A/B/C multiplatform devices.

HPAV operations require that one SSID be set for each set of 256 LDEVs.

---

## WLM Host Software Definitions for Dynamic Alias Management

The Workload Manager (WLM) software component of the MVS/ESA or OS/390 operating system enables the host to interface with the HPAV functionality of the XP128/XP1024. WLM compatibility mode provides static HPAV functionality and WLM goal mode provides dynamic HPAV functionality. WLM must be in “GOAL” mode to support “Dynamic Alias Management” HPAV functionality.

Support for Dynamic Alias Management by the Workload Manager (WLM) is dependent on the following three parameter settings:

- WLM Goal Mode setting
- WLM “Dynamic alias management” setting in the Service Coefficients/Service Definitions window (see page 1182)
- WLMPAV setting of each base device as defined in the “Define Device Parameters / Features” HCD definition window (see page 1175)

## Static and Dynamic HPAV Operations

Static or dynamic HPAV operation is determined by the combination of the following parameter settings:

- The ‘WLMPAV=xxx’ parameter setting for each device defined to the OS/390 host through the HCD. The default setting of this parameter is ‘WLMPAV=YES’ for 3390B or 3390A devices defined through the HCD.
- The ‘Dynamic Alias Support’ parameter setting for WLM.
- Static HPAV is implemented when the WLM feature for ‘Dynamic Alias Support’ is set to NO and the appropriate aliases are assigned to the base devices using Command View. The setting of the ‘WLMPAV=xxx’ parameter defined for each 3390B or 3390A device is ignored. In addition, the ‘I/O Priority Management’ setting for WLM is ignored (see [Table 174](#)).
- Dynamic HPAV is implemented when ‘Dynamic Alias Support’ is set to YES and the appropriate aliases are assigned to the base devices using Command View. The setting of the ‘WLMPAV=xxx’ parameter defined for each 3390B or 3390A device must be set to ‘YES’ if WLM is to manage the alias device address assignments. In addition, the ‘I/O Priority Management’ setting for

WLM determines the dynamic alias algorithm to be used for meeting the Performance Index of the workloads under the control of WLM using the HPAV feature (see [Table 174](#)).

---

**Note:** When 'Dynamic Alias Support' is enabled, the alias-to-base assignments are managed by the WLM component of the OS/390 system as needed in response to changes in I/O activity.

---

**Table 174: HCD settings for static and dynamic HPAV**

Dynamic Alias Support	I/O Priority Management	Dynamic Alias Algorithm in Effect
NO	NO	None (static HPAV only)
NO	YES	None (static HPAV only)
YES	NO	Efficiency only
YES	YES	Both efficiency and goal

## Static HPAV

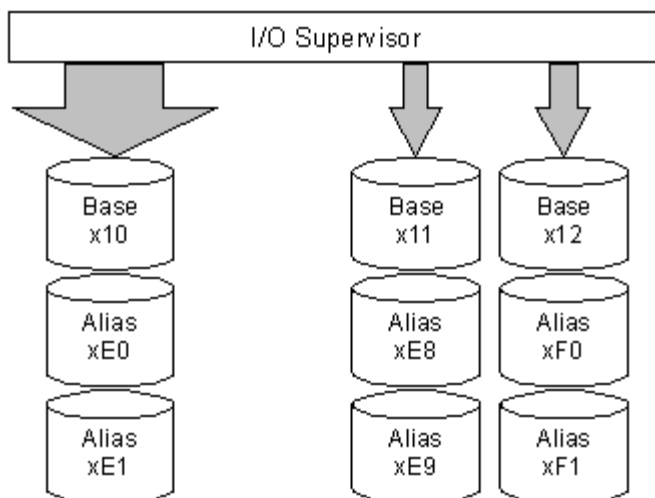
When static HPAV is used, the number of aliases specified for each base device does not change, even when the number of I/O requests to each device changes. When dynamic HPAV is used, the number of aliases for each base device is likely to change as the number of I/O requests changes.

The following figure shows an example of static HPAV operations. Each of the three base devices (x10, x11, and x12) has two aliases assigned. If I/O requests converge on base device x10 (shown by the large arrow), the number of aliases for each base device remains unchanged.

---

**Note:** If you will be using static HPAV, determine on which devices I/O requests are likely to converge, and then assign more aliases to those base devices. If not, HPAV might not be able to provide much improvement in host access to data in the XP128/XP1024.

---



**Figure 400: Static HPAV**

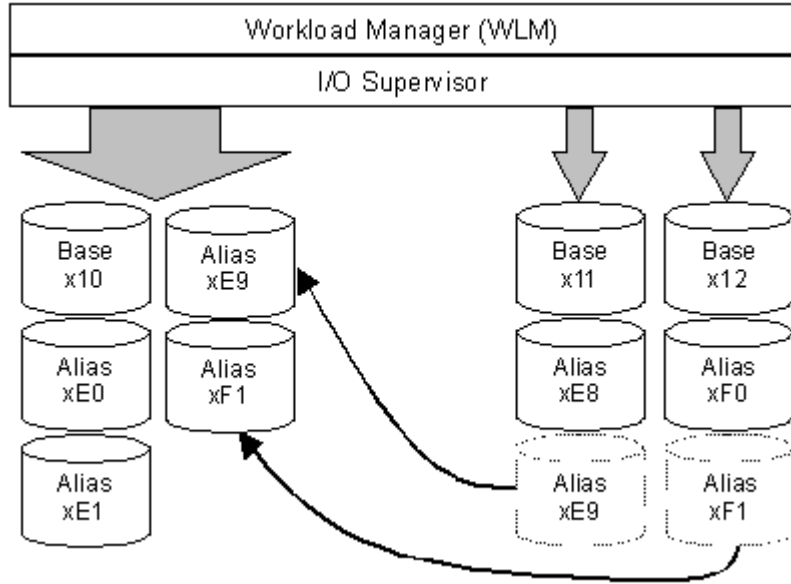
## Dynamic HPAV

When dynamic HPAV is used, the number of aliases for a base device may change as the number of I/O requests to the device changes. If I/O requests converge on several base devices, the number of aliases for these devices may increase, while the number of aliases for other base devices may decrease. Dynamic HPAV operations can balance workloads on base devices and optimize the speed for accessing data in the XP128/XP1024.

The following figure shows an example of dynamic HPAV operations. Each of the three base devices (x10, x11, and x12) was originally assigned two aliases. In this example, as I/O requests converge on base device x10 (shown by the large arrow), the number of aliases for device x10 increases to four, while the number of aliases for base device x11 and x12 decreases to one.

Dynamic HPAV operations require the Workload Manager (WLM) software function provided by the host computer. For more information on WLM operations, see [WLM Host Software Definitions for Dynamic Alias Management](#) on page 1138 and [System Requirements](#) on page 1144.





**Figure 401: Dynamic HPAV**

## Requirements and Restrictions

The following table lists the requirements and restrictions for HPAV operations on the XP128/XP1024.

**Table 175: Requirements and restrictions for HPAV**

Item	Requirement and/or Restriction
Controller emulation type	I-2105
Device emulation type for base device	3390-3, 3390-3R, 3390-9, 3390-L
Storage subsystem ID (SSID) setting	One SSID must be set for each set of 256 LDEVs.
Maximum number of aliases that can be assigned to a base device	15

**Table 175: Requirements and restrictions for HPAV (Continued)**

Item	Requirement and/or Restriction
Alias device	Alias device and its base device must belong to the same logical CU image.
Functions that cannot be used concurrently with HPAV	<ul style="list-style-type: none"> <li>■ Hitachi Multiplatform Backup/Restore (HMBR)</li> <li>■ Virtual LUN</li> <li>■ Cache LUN XP</li> <li>■ Business Copy (BC) XP</li> <li>■ Continuous Access (CA) XP</li> </ul>
Functions that can be used concurrently with HPAV	<ul style="list-style-type: none"> <li>■ Virtual LVI</li> <li>■ Hitachi FlashAccess for S/390</li> <li>■ SANtinel - S/390</li> <li>■ TrueCopy (TC390)</li> <li>■ ShadowImage (SI390)</li> <li>■ PPRC</li> <li>■ Extended Remote Copy (XRC) with restrictions (see <i>Caution</i> below)</li> </ul>



**Caution:** The following restrictions apply if XRC will be used with HPAV:

- Ensure that the emulation type of all LCUs is 2105. Do not intermix 2105 emulation with other emulation types within the same disk array.
- If XRC volumes already exist, complete the following steps to change to 2105 emulation:
  - a. Stop all jobs and delete all XRC pairs.
  - b. Change the DKC emulation type of all CHA packages in the disk array to 2105.
  - c. Restart jobs and re-establish XRC pairs.

## Maximizing Your HPAV Results

To maximize your results from HPAV operations, be aware of the following:

- The best results can be obtained if the number of aliases per CU image is equal to the number of available channel paths minus one. If the number of aliases is specified this way, I/O operations can use all channel paths, thus providing the best results.
- HPAV may not produce good results when many channel paths are used. If all channel paths are used, good HPAV results cannot be expected.
- The unused device addresses in the XP128/XP1024 are used as alias devices. If you use most of the unused device addresses for aliases, you will only have a small amount of free devices available. If you determine that a large number of aliases will be required, consider adding more disks to ensure that storage will be available when needed.
- HPAV may not provide good results for devices that are always shared and used by multiple host systems. For access by multiple hosts, use the Multiple Allegiance (MA) host software function supported by the XP128/XP1024.
- If dynamic HPAV can be used in all systems, expect good results if you assign eight to sixteen (8-16) aliases to each CU image.
- The recommended ratio of base devices to alias devices is 1:3. [Table 176](#) shows examples of calculating the number of base and alias devices for a CU image with 256 devices. If you know the types of jobs and/or the expected host access rates for the base devices, determine the number of aliases for each base device to meet your requirements for each base device.
- Up to 15 alias devices can be assigned to one base device.

**Table 176: Ratio of base devices to alias devices**

Ratio (base devices : alias devices)	Number of Base Devices	Number of Alias Devices	Total Devices
1:3 (recommended)	64	192	256 (64+192)
1:2	85	171 (85+86)	256 (85+171)
1:1	128	128	256 (128+128)

## Preparing for HPAV Operations

### System Requirements

HPAV operations involve the volumes on the XP128/XP1024, the licensed Command View software, and the WLM host software function. The system requirements for HPAV are:

- Host software:
  - **For static HPAV:** OS/390 V1R3 or later, and DFSMS/MVS 1.3 or later VM/ESA 2.4.0 or later.
  - **For dynamic HPAV:** OS/390 V2R7 with APAR OW39854, and DFSMS/MVS 1.5 or later.
  - **APARs and PTFs:** The XP128/XP1024 does not have any specific APAR/PTF requirements beyond what is required by the OS/390 operating system to provide minimum support for the 2105 device type.
- **XP128/XP1024:** The emulation type for a CU image that controls HPAV devices must be 2105 (see [Changing the Controller Emulation Type](#) on page 1145).
- **IOCP definition considerations:** If you maintain separate IOCP definition files and create your SCDS or IOCDS manually by running the IZP IOCP program, the following definition rules apply:
  - Each LCU on an XP128/XP1024 is defined using one CNTLUNIT statement in IOCP. The unit type is 2105. Up to 16 LCUs can be defined on an XP128/XP1024. An LCU is identified by its 'Control Unit Address' ('CUADDR=x' parameter) and is specified as a hexadecimal number in the range of '0' to 'F'. An LCU is the same as an IBM Logical Sub-System or LSS. While it is possible to have an LCU on an XP1024 defined using multiple CNTLUNIT statements in IOCP, the resulting input deck cannot be migrated to HCD due to an IBM restriction to allow only one CNTLUNIT definition.
  - Up to 256 devices may be defined on each LCU. Base device addresses are identified as unit type 3390B. Alias device addresses are identified as 3390A.
- **HCD definition considerations:** If you use HCD exclusively to define I/O definitions to OS/390 and to automatically run the IOCP program to create SCDS or IOCDS, the following definition rules apply:
  - Each LCU on an XP128/XP1024 is defined as a 2105 control unit.

- Base devices are defined as 3390B device types. HCD will only connect base devices to one control unit. Base device optional parameter definitions in HCD include the 'WLMPAV=xxx' parameter. The default setting is 'YES'.
  - Alias devices are defined as 3390A device types. HCD will only connect alias devices to one control unit. Alias devices have only one optional parameter definition in HCD. The 'WLMPAV=xxx' parameter defaults to 'YES'.
- **Command View:** See the *Command View XP Installation Guide*.

---

**Note:** Administrator access to the Command View management station is required to perform HPAV operations. Users without administrator access can only view HPAV information.

---

## Preparing the XP128/XP1024 for HPAV Operations

### Changing the Controller Emulation Type

For HPAV operations, the XP128/XP1024 must have channel adapter (CHA) packages for which the 2105 emulation type is specified. Ask your HP representative to verify that the correct CHA packages are installed. The HP representative can check and change the controller emulation type in any one of the following ways:

- Add CHA packages and set the emulation type of these packages to 2105 (I-2105).
- Use the System Tuning function on the SVP to change the emulation type to 2105, and then power off and power on the XP128/XP1024.



**Caution:** For XRC operations, do not intermix the 2105 emulation type with other emulation types within the same disk array. If the XP128/XP1024 is already performing XRC operations, refer to [Table 175](#) on page 1141 for instructions on implementing HPAV with these functions on the same disk array.

---

## Enabling the HPAV Options

Set the controller emulation to 2105 (see [Changing the Controller Emulation Type](#) on page 1145) before enabling the HPAV options. You need to install the HPAV license key through Command View and the HPAV option on each XP128/XP1024 that will perform HPAV operations (see [Managing License Keys](#) on page 85).

## Preparing the Host System for HPAV Operations

This section provides a brief description of the required preparations at the host system for HPAV operations on the XP128/XP1024. Before performing HPAV operations, you must:

- Set the WLM operation mode on the host system (see page 1146)
- Set the MIH timer value on the host system (see page 1146)

## Setting the WLM Operation Mode

WLM manages workloads on MVS systems and has two operation modes for static and dynamic HPAV:

- **Goal mode:** If you want to use dynamic HPAV, you must set the WLM operation mode to *goal mode*. In goal mode, WLM can assign more or fewer aliases to a base device depending on the host I/O activity to that device, thereby managing the system to meet the performance goal specified before system operations began.
- **Compatibility mode:** If you want to use static HPAV, you must set the WLM operation mode to *compatibility mode*. In compatibility mode, the number of aliases assigned to each base device does not change as a result of changes in host I/O activity. WLM manages the system according to the parameters in the IPS and ICS (IEAIPSxx and IEAICSxx).

## Setting the MIH Timer Value

The recommended MIH timer value for XP128/XP1024 HPAV operations is **30 seconds**. The MIH timer values can be set in MVS/ESA or OS/390 either at IPL or after IPL.


**To set the MIH timer value:**

- **At IPL** – Use the MIH parameter in the IECIOSxx parmlib member to set the MIH timer value at IPL time.

- **After IPL** – Use the “SETIOS” System Command after IPL to change or set the MIH timer value.

## Starting HPAV

### To access HPAV:

1. From the Launch screen, click an XP128 or XP1024.
2. Click the **Mainframe** tab, click the **Mainframe Connection** button (  ), and then click the **HPAV** tab. The HPAV screen is displayed.

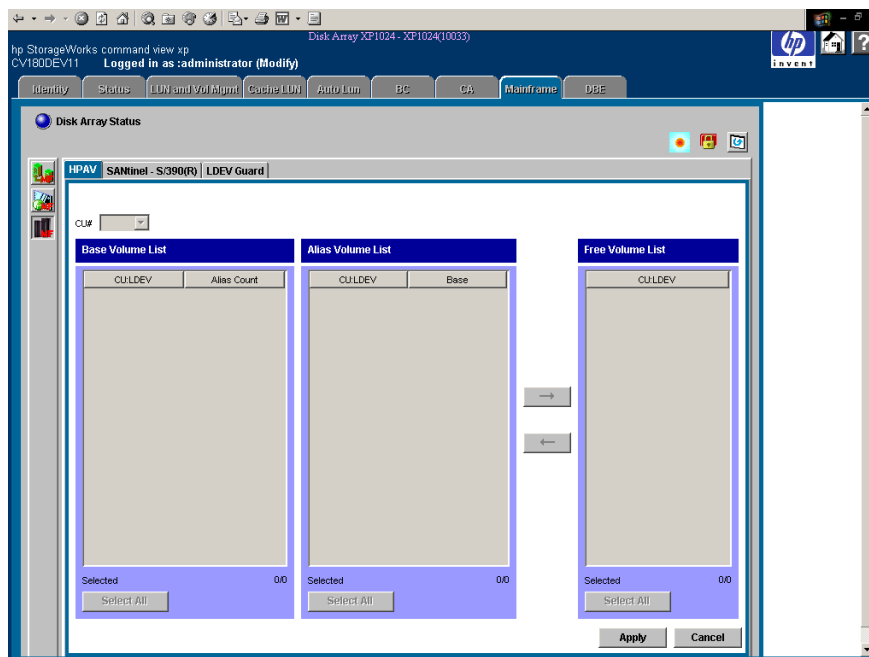


Figure 402: HPAV screen

## HPAV Screen

Use the **CU#** drop-down list to select a logical CU image in the connected XP128/XP1024. The HPAV screen displays the LDEVs (3390 LVIs only) for the selected CU image.

The **Base Volume List** box displays the 3390 LVIs that are currently in use in the selected CU image. Each of these LDEVs can be an HPAV base device. When assigning and canceling aliases for base devices, select the base devices from this list box.



- **Alias Count:** This column indicates the number of aliases for each base volume.
- The **Selected** field displays the number of selected base volumes and the total number of base volumes in the selected CU image. For example, 2/73 indicates that two base volumes are selected out of a total of 73 base volumes in the select CU image.
- Click **Select All** to select all volumes in the Base Volume List box.

The **Alias Volume List** box displays the alias device(s) assigned to the selected base device(s). To view all alias devices for the selected CU image, select all of the base devices. When canceling aliases for base devices, select the alias devices from this list.

- The **Base** column displays the LDEV ID of the base device for each alias device.
- The **Selected** field displays the number of selected alias devices and the total number of alias devices in the selected CU image. For example, 2/4 indicates that two aliases are selected out of a total of four alias devices in the selected CU image.
- Click **Select All** to select all volumes in the Alias Volume List box.

The **Free Volume List** box displays the LDEV IDs of the unused volumes in the selected CU. Each of these free volumes can be used as an HPAV alias device. When assigning aliases to base volumes, select the alias devices from this list.

- The **Selected** field displays the number of selected free devices and the total number of free devices in the selected CU image. For example, 8/47 indicates that eight free devices are selected out of a total of 47 free devices in the selected CU image.
- Click **Select All** to select all volumes in the Free Volume List box.

Clicking the → button cancels aliases for base devices (see [Canceling Aliases](#) on page 1153). After clicking the → button, the Free Volume List box then displays their LDEV IDs. To complete your request to cancel the aliases as specified, click **Apply**.

Clicking the ← button assigns aliases to base devices (see [Assigning Aliases](#) on page 1151). After clicking the ← button, the Alias Volume List box displays the new alias devices. To complete your request to assign the new aliases as specified, click **Apply**.

The **Apply** button applies the settings made on this screen to the XP128/XP1024. Clicking this button displays a message confirming that you want to apply your request to the disk array.

The **Cancel** button discards changes in this screen to restore the initial settings.

## Performing HPAV Operations

After you have prepared for HPAV operations as described in [Preparing for HPAV Operations](#) on page 1144, you are ready to start performing HPAV operations on the XP128/XP1024. HPAV operations include:

- Assigning and canceling aliases (see page 1151)
- Defining the XP128/XP1024 devices to the host system (see page 1155)

## Assigning and Canceling Aliases

### Assigning Aliases

Before you assign HPAV aliases, you should have determined the required number of aliases for each base device to meet your operational requirements (see [Maximizing Your HPAV Results](#) on page 1142). If you assign additional aliases after starting I/O operations to the XP128/XP1024 HPAV devices, you will need to redefine the XP128/XP1024 HPAV devices to the host operating system.

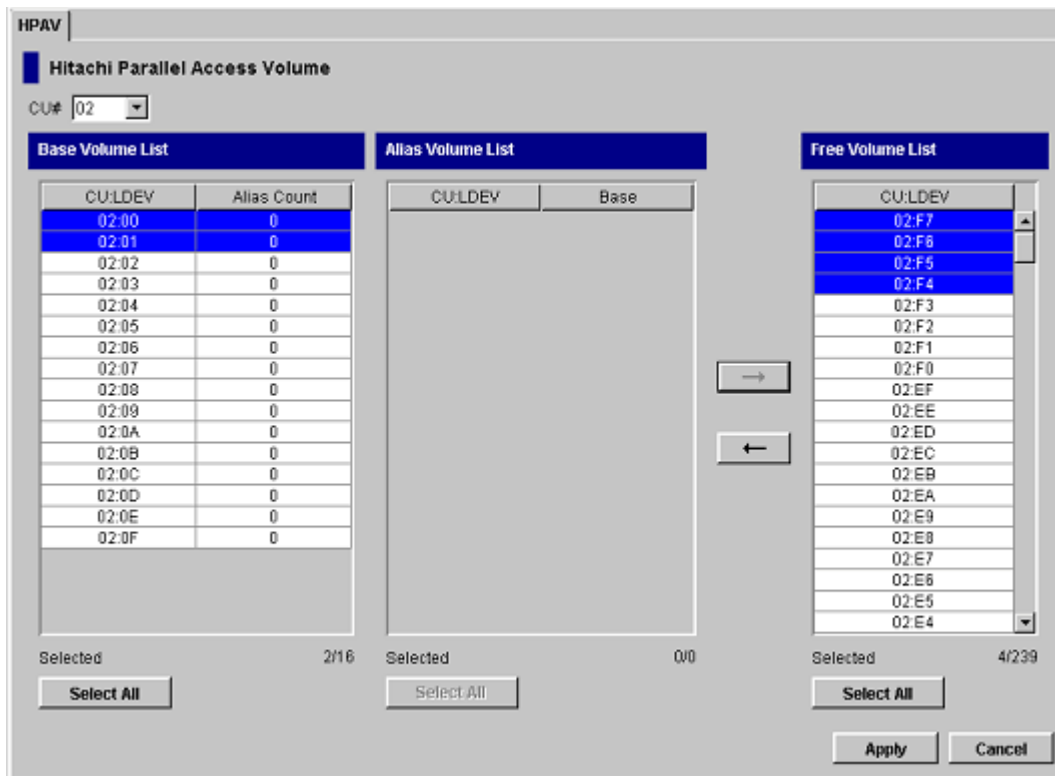
You can assign up to 15 aliases to one base device. The HPAV assign alias function pairs each selected base volume with one or more of the selected free volumes. If the number of selected free volumes is larger than the number of selected base volumes, this function attempts to allocate the free volumes equally to the base volumes. For example, if six free volumes and two base volumes are selected, three free volumes (aliases) are allocated to each base volume.

#### **To assign aliases to volumes in the connected XP128/XP1024:**

1. From the HPAV screen, click the CU image that contains the base volumes. The Free Volume List box displays the total number of available free volumes.
2. To add the new aliases to the Alias Volume List box, click the base volumes in the Base Volume List box, click the free volumes in the Free Volume List box, and then click the ← button.

To assign one alias to each base volume, select the same number of free volumes as base volumes.

To assign three aliases to each base volume, select three times as many free volumes as base volumes (for example, 3 base volumes and 9 free volumes).



**Figure 403: Assigning aliases**

3. Click **Apply** on the HPAV screen. When the Set HPAV confirmation dialog box is displayed, click **Yes** to assign the new aliases as specified. To cancel your request, click **No**.

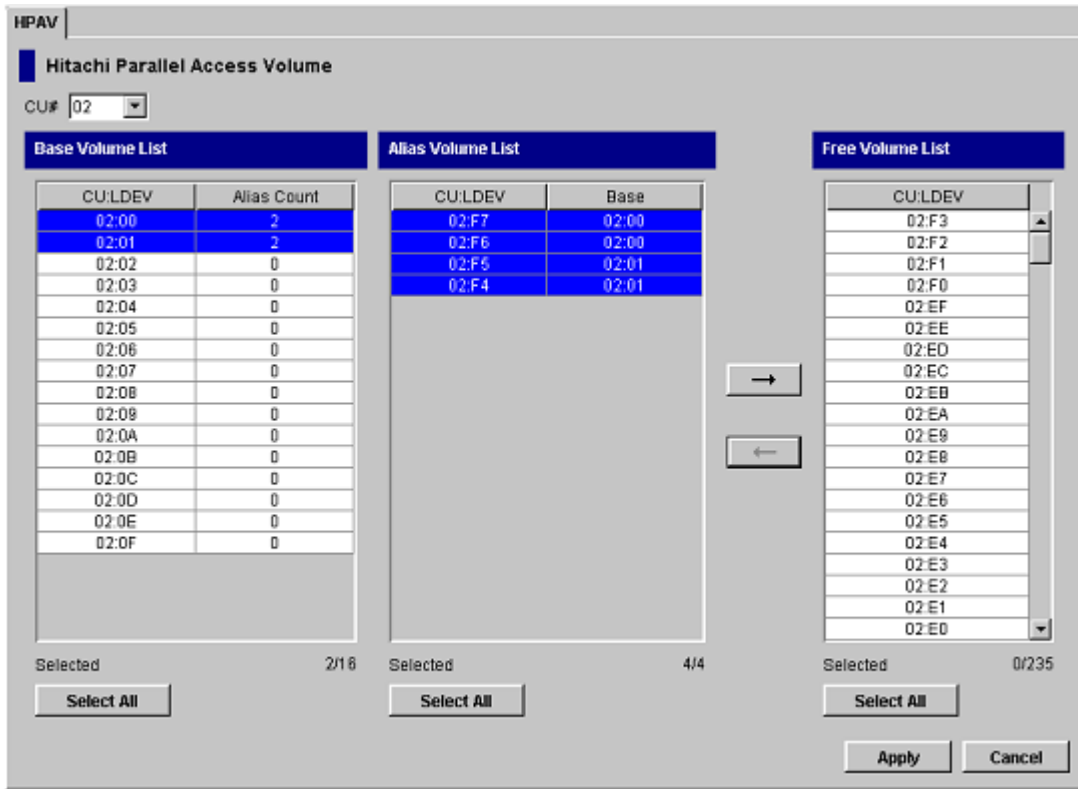


Figure 404: Confirming new aliases

## Canceling Aliases



**Caution:** Do not cancel aliases while I/O operations are being performed on the HPAV devices. This can cause a serious failure.

### To cancel aliases for volumes in the connected XP128/XP1024:

1. From the HPAV screen, click the CU image that contains the aliases that you want to cancel.
2. In the Base Volume List box, click the base device(s) for the aliases that you want to cancel.

3. In the Alias Volume List box, click the alias devices that you want to cancel and then click the → button to remove the aliases from the Alias Volume List box and add their LDEV IDs to the Free Volume List box.
4. Click **Apply** on the HPAV screen. When the Set HPAV confirmation dialog box is displayed, click **Yes** to cancel the aliases as specified. To cancel your request, click **No**.

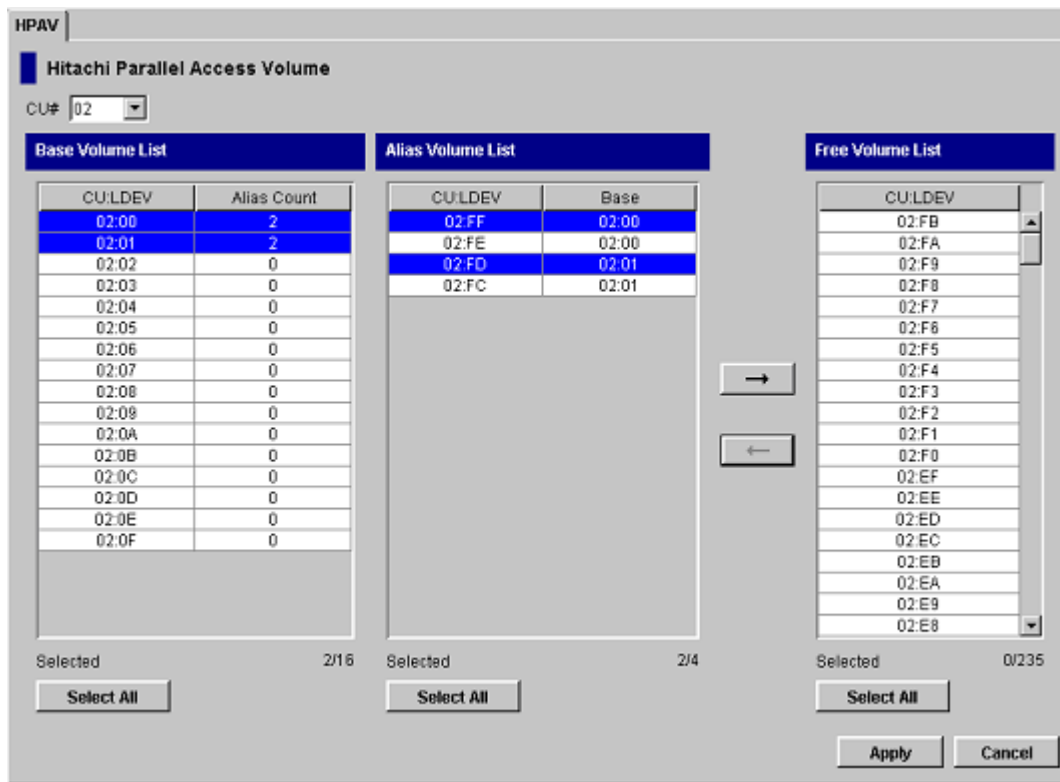


Figure 405: Canceling aliases

## Considerations for Defining the XP128/XP1024 Devices to the Host System

For XRC, do not intermix the 2105 controller emulation type with other emulation types within the XP128/XP1024. If the XP128/XP1024 has existing XRC volumes and you want to implement HPAV, complete the following steps to change to 2105 emulation:

1. Stop all jobs and delete all XRC pairs.
2. Change the DKC emulation type of all CHA packages in the XP128/XP1024 to I-2105.
3. Restart jobs and re-establish XRC pairs.

---

**Note:** HPAV operations require that one SSID be set for each set of 256 LDEVs.

---

### Definition of XP128/XP1024 Base and Alias Devices

The unit address mapping for base and alias devices must be defined to the host operating system and must match the address mapping defined at the Command View management station. If the mappings do not match, serious failures can occur during data processing. The following shows examples of mappings between base devices and alias devices.

(A)	x00-x3F:Base	(B)	x00-x3F:Base	(C)	x00-x7F:Alias	(D)	x00-x3F:Alias
	x40-xFF:Alias		x40-x7F:Alias		x80-xFF:Base		x40-x7F:Base
			x80-xBF:Base				x80-xBF:Alias
			xCO-xFF:Alias				xCO-xFF:Base

---

**Note:** When each base device is assumed to be assigned the same number of aliases, the recommended ratio of base devices to aliases is 1:3.

---

### Verifying Base and Alias Device Definition

After defining the mapping between base devices and alias devices to the host operating system (see [Definition of XP128/XP1024 Base and Alias Devices](#) on page 1155), verify that the host recognizes the XP128/XP1024 devices as specified.

To verify that the host system recognizes the settings for the XP128/XP1024 base and alias devices:

1. At the MVS console display information about the base devices and the corresponding alias addresses using the DEVSERV (DS) command. See the example titled [Verifying the Base Devices and Alias Addresses](#) on page 1156.  
**DS QPAV, XXXX,VOLUME** (XXXX = address of the base device)
2. Verify that the information displayed by the DS command matches your definitions of base devices and alias addresses.

---

**Note:** The information displayed by the DS command should match the HPAV settings that you specified at the Command View management station for base devices and alias addresses. If it does not match, redefinition is required. After dynamic HPAV has been used, the information may not match, but the mismatch will not cause any problems. For dynamic HPAV, the mismatch occurs because the host system can change the number of aliases assigned to each base device.

---

*Example:* Verifying the Base Devices and Alias Addresses

```

DS QPAV, D222,VOLUME
IEE459I 08:20:32 DEVSERV QPATHS 591
Host                               Subsystem
Configuration                       Configuration
-----
UNIT   UNIT   UA                               UNIT
NUM    UA     TYPE           STATUS  SSID   ADDR   TYPE
---    --    ---           ---    ---   ---   ---
D222   22     BASE                               0102  22    BASE
D2FE   FE     ALIAS-D222                          0102  FE    ALIAS-22
D2FF   FF     ALIAS-D222                          0102  FF    ALIAS-22
***3 DEVICE(S) MET THE SELECTION CRITERIA
    
```

## Verifying the Status of the Devices

After verifying the generation definition for the XP128/XP1024 devices, verify the status of the devices for each channel path (CHP).

### To verify the status of the XP128/XP1024 devices by CHP ID:

1. At the MVS console display the status of the XP128/XP1024 devices by issuing the Display Matrix command for each CHPID connected to the XP128/XP1024. See the example titled [Verifying the Status of Devices Defined by CHP ID](#) on page 1157.



**D M=CHP(XX) (XX = CHP ID)**

2. Verify that the displayed information matches the device status that was defined when the generation definition was made:
  - If the information is correct, the XP128/XP1024 is now ready for HPAV activities. For information on monitoring HPAV activities, see [Monitoring HPAV Activities](#) on page 1158.
  - If the information is not correct, redefine the XP128/XP1024 devices to the host as described in [Definition of XP128/XP1024 Base and Alias Devices](#) on page 1155 and [Verifying Base and Alias Device Definition](#) on page 1155.

*Example:* Verifying the Status of Devices Defined by CHP ID

```

D M=CHP(80)
IEE174I 10.05.24 DISPLAY M 779
CHPID 80:TYPE=05, DESC=ESCON SWITCHED POINT TO POINT
DEVICE STATUS FOR CHANNEL PATH 80
      0   1   2   3   4   5   6   7   8   9   A   B   C   D   E   F
680  +   +   +   +   +   +   +   +   +   +   +   +   +   +   +   +
681  +   +   +   +   +   +   +   +   +   +   +   +   +   +   +   +
682  +   +   +   +   +   +   +   +   +   +   +   +   +   +   +   +
683  +   +   +   +   +   +   +   +   +   +   +   +   +   +   +   +
684  AL  AL  AL  AL  AL  AL  AL  AL  AL  AL  AL  AL  AL  AL  AL  AL
685  AL  AL  AL  AL  AL  AL  AL  AL  AL  AL  AL  AL  AL  AL  AL  AL
686  AL  AL  AL  AL  AL  AL  AL  AL  AL  AL  AL  AL  AL  AL  AL  AL
687  AL  AL  AL  AL  AL  AL  AL  AL  AL  AL  AL  AL  AL  AL  AL  AL
688  +   +   +   +   +   +   +   +   +   +   +   +   +   +   +   +
689  +   +   +   +   +   +   +   +   +   +   +   +   +   +   +   +
68A  +   +   +   +   +   +   +   +   +   +   +   +   +   +   +   +
68B  +   +   +   +   +   +   +   +   +   +   +   +   +   +   +   +
68C  UL  UL  UL  UL  UL  UL  UL  UL  UL  UL  UL  UL  UL  UL  UL  UL
68D  UL  UL  UL  UL  UL  UL  AL  AL  AL  AL  AL  AL  AL  AL  AL  AL
68E  UL  UL  UL  UL  UL  UL  UL  UL  UL  UL  UL  UL  UL  UL  UL  UL
68F  UL  UL  UL  UL  UL  UL  UL  UL  UL  UL  UL  UL  UL  UL  UL  UL

*****SYMBOL EXPLANATIONS*****
+ ONLINE @ PATH NOT VALIDATED - OFFLINE .DOES NOT EXIST
* PHYSICALLY ONLINE $ PATH NOT OPERATIONAL
BX DEVICE IS BOXED SN SUBCHANNEL NOT AVAILABLE
DN DEVICE NOT AVAILABLE PE SUBCHANNEL IN PERMANENT ERROR
AL DEVICE IS AN ALIAS UL DEVICE IS AN UNBOUND ALIAS
    
```

## Monitoring HPAV Activities

The following methods can be used to monitor HPAV activities on the XP128/XP1024:

- Additional MVS commands
- GTF I/O tracing

## Additional MVS Commands

In addition to the “DS QPAV” and “D M=CHP” commands (see the examples on page 1156 and page 1157), the following commands will provide additional information:

- **DISPLAY M=DEV.** The example titled [Display Command – HPAV Base Device with 5 Aliases](#) on page 1159 shows an example of the Display M=DEV(XXXX) command for a base device.
- **DEVSERV PATHS.** The example titled [DEVSERV DISPLAY PATHS Command](#) on page 1159 shows an example of a DEVSERV PATHS command.
- **DEVSERV QPAV.** The examples titled [DEVSERV QPAV Command](#) on page 1159, [DSESERV QPAV,SSID=XXXX Command](#) on page 1159, and [DS QP,8300,VOLUME Command](#) on page 1161 show examples of the DEVSERV QPAV commands having the following command formats:
  - DS QP,8300,4: Display status of four base devices starting at device 8300.
  - DS QP,SSID=8300: Display status of entire Subsystem-ID.
  - DS QP,8300,VOLUME: Display status of host/subsystem configuration for volume.

## GTF I/O Tracing

GTF is PAV aware. When a device number is specified for GTF I/O tracing operations, GTF determines if the device is a base PAV device and will automatically include the Alias addresses currently bound to the base device.

*Example:* Display Command – HPAV Base Device with 5 Aliases

```

D M=DEV(8300)
IEE174I 15.33.58 DISPLAY M 739
DEVICE 8300 STATUS=ONLINE
CHP                63 40 64 65
DEST LINK ADDRESS  DD EA E9 E8
DEST LOGICAL ADDRESS 02 02 02 02
PATH ONLINE         N Y Y Y
CHP PHYSICALLY ONLINE Y Y Y Y
PATH OPERATIONAL    N Y Y Y
MANAGED             N N N N
MAXIMUM MANAGED CHPID(S) ALLOWED: 0
ND                  = 002105. .HTC.02.000000012345
DEVICE NED =        2105. .HTC.02.000000012345
PAV BASE AND ALIASES 6
    
```

*Example:* DEVSERV DISPLAY PATHS Command

```

DS P,8300
IEE459I 15.43.32 DEVSERV PATHS 755
UNIT DTYPE M CNT VOLSER CHPID=PATH STATUS
      RTYPE SSID CFW TC DFW PIN DC-STATE CCA DDC ALT CU-TYP
8300,33903 ,0,000,PA8300,63=< 40=+ 64=+ 65=+
      2105 8300 Y YY. YY. N SIMPLEX 00 00 2105
***** SYMBOL DEFINITIONS *****
O = ONLINE + = PATH AVAILABLE
< = PHYSICALLY UNAVAILABLE
    
```

*Example:* DEVSERV QPAV Command

```

DS QP,8300,4
IEE459I 15.50.16 DEVSERV QPAVS 013
      HOST SUBSYSTEM
      CONFIGURATION CONFIGURATION
      -----
UNIT UNIT UA
NUM. UA TYPE STATUS SSID ADDR. TYPE
-----
8300 00 BASE 8300 00 BASE
8301 01 BASE 8300 01 BASE
8302 02 BASE 8300 02 BASE
8303 03 BASE 8300 03 BASE
**** 4 DEVICE(S) MET THE SELECTION CRITERIA
    
```

*Example:* DSESERV QPAV,SSID=xxxx Command

```

DS QP,SSID=8300
IEE459I 15.56.03 DEVSERV QPAVS 026
      HOST                                SUBSYSTEM
      CONFIGURATION                      CONFIGURATION
      -----
UNIT                                UNIT    UA
NUM. UA  TYPE                        STATUS  SSID  ADDR.  TYPE
----- --  ----
8300 00  BASE                        8300  00   BASE
8301 01  BASE                        8300  01   BASE
8302 02  BASE                        8300  02   BASE
8303 03  BASE                        8300  03   BASE
8304 04  BASE                        8300  04   BASE
8306 06  BASE                        8300  06   BASE
8307 07  BASE                        8300  07   BASE
8308 08  BASE                        8300  08   BASE
8309 09  BASE                        8300  09   BASE
830A 0A  BASE                        8300  0A   BASE
830C 0C  BASE                        8300  0C   BASE
830D 0D  BASE                        8300  0D   BASE
830E 0E  BASE                        8300  0E   BASE
830F 0F  BASE                        8300  0F   BASE
8310 10  BASE                        8300  10   BASE
8311 11  BASE                        8300  11   BASE
8312 12  BASE                        8300  12   BASE
8313 13  BASE                        8300  13   BASE
8314 14  BASE                        8300  14   BASE
8315 15  BASE                        8300  15   BASE
8316 16  BASE                        8300  16   BASE
8317 17  BASE                        8300  17   BASE
8318 18  BASE                        8300  18   BASE
8319 19  BASE                        8300  19   BASE
831A 1A  BASE                        8300  1A   BASE
831B 1B  BASE                        8300  1B   BASE
831D 1D  BASE                        8300  1D   BASE
831F 1F  BASE                        8300  1F   BASE
8320 20  BASE                        8300  20   BASE
8321 21  BASE                        8300  21   BASE
8322 22  BASE                        8300  22   BASE
83F6 F6  ALIAS-8301                   8300  F6   ALIAS-01
83F7 F7  ALIAS-8301                   8300  F7   ALIAS-01
83F8 F8  ALIAS-8301                   8300  F8   ALIAS-01
83F9 F9  ALIAS-8301                   8300  F9   ALIAS-01
83FA FA  ALIAS-8301                   8300  FA   ALIAS-01
83FB FB  ALIAS-8300                   8300  FB   ALIAS-00
83FC FC  ALIAS-8300                   8300  FC   ALIAS-00
83FD FD  ALIAS-8300                   8300  FD   ALIAS-00
83FE FE  ALIAS-8300                   8300  FE   ALIAS-00
83FF FF  ALIAS-8300                   8300  FF   ALIAS-00
****                                41 DEVICE(S) MET THE SELECTION CRITERIA
    
```

Example: DS QP,8300,VOLUME Command

```

DS QP,8300,VOLUME
IEE459I 16.00.15 DEVSERV QPAVS 041
      HOST                                SUBSYSTEM
      CONFIGURATION                       CONFIGURATION
      -----
UNIT                                     UNIT   UA
NUM. UA  TYPE          STATUS          SSID  ADDR.  TYPE
----- --  ---
8300 00  BASE
83FB FB  ALIAS-8300
83FC FC  ALIAS-8300
83FD FD  ALIAS-8300
83FE FE  ALIAS-8300
83FF FF  ALIAS-8300
****          6 DEVICE(S) MET THE SELECTION CRITERIA
    
```

## Using HCD to Define and View XP128/XP1024 LCUs and HPAV Devices

The XP128/XP1024 logical control units (LCUs) and PAV base and alias devices are defined to MVS/ESA and OS/390 systems using the configuration dialog windows of the Hardware Configuration Definition (HCD) Program. The HCD Program can also display the WLMPAV device parameter for existing HPAV devices.

This section provides sample instructions for:

- Defining an XP1024 LCU and base and alias HPAV devices (see page 1162)
- Displaying the WLMPAV device parameters (see page 1175)

## Using HCD to Define an XP1024 LCU and the Base and Alias Devices

The following example shows the sequence of HCD windows used in defining an XP1024 LCU and a range of base and alias devices. Before you can define the LCU, the channel paths must already be defined.

To define an XP1024 LCU and the base and alias address range that it will support, use the following example for HCD:

1. From an ISPF/PDF primary options menu, select the HCD option to display the Basic HCD window. On this window, verify the name of the IODF or IODF.WORK I/O definition file to be used.
2. From the Basic HCD window, select option 1 to display the Define, Modify, or View Configuration Data window (see the following example).

*Example:* Basic HCD Window

```
OS/390 Release 9 HCD
Command ==>

-----

                          Hardware Configuration

Select one of the following.

1 1. Define, modify, or view configuration data ← Select option 1.
   2. Activate or process configuration data
   3. Print or compare configuration data
   4. Create or view graphical configuration report
   5. Migrate configuration data
   6. Maintain I/O definition files
   7. Query supported hardware and installed UIMs
   8. Getting started with this dialog
   9. What's new in this release

For options 1 to 5, specify the name of the IODF to be used.

I/O definition file . . . 'SYS1.IODF00'
```

3. From the Define, Modify, or View Configuration Data window, select option 4 to display the Add Control Unit window (see the following example).

*Example:* Define, Modify, Or View Configuration Data

```
----- Define, Modify, or View Configuration Data -----  
  
Select type of objects to define, modify, or view data.  
  
_4 1. Operating system configurations ← Select option 4.  
    consoles  
    system-defined generics  
    EDTs  
    esoterics  
    user-modified generics  
2. Switches  
   ports  
   switch configurations  
   port matrix  
3. Processors  
   partitions  
   channel paths  
4. Control units  
5. I/O devices  
  
F1=Help   F2=Split   F3=Exit   F9=Swap   F12=Cancel
```

4. From the Add Control Unit window, enter the following information: Control unit number, Control unit type – 2105, and Switch connection information (see the following example).



**Example: Add Control Unit window**

```

Goto  Filter  Backup  Query  Help
-----
                          Control Unit List
Command ===> _____ Scroll ===> CSR

Select one or more control units, then press Enter.  To add, use F11.

/ CU  Type +      #PR #MC Serial-# + Description
_ 002 .----- Add Control Unit -----
_ 004 |
_ 006 |
_ 008 | Specify or revise the following values.
_ 03E |
_ 074 | Control unit number . . . . . 2000 +
_ 082 | Control unit type . . . . . 2105_____ +
_ 0E2 |
_ 240 | Serial number . . . . . _____
_ 240 | Description . . . . . _____
_ 300 |
_ 300 | Connected to switches . . .  _ _ _ _ _ +
_ 300 | Ports . . . . . _ _ _ _ _ +
_ 300 |
_ 300 | If connected to a switch:
_ 300 |
_ 300 | Define more than eight ports . . 2   1. Yes
_ 300 |                               2. No
_ 300 | Propose CHPID/link addresses and
_ 300 | unit addresses . . . . . 2   1. Yes
_ 310 |                               2. No
_ 310 | F1=Help   F2=Split   F3=Exit   F4=Prompt   F5=Reset   F9=Swap
_ 310 | F12=Cancel
_ 310 '-----'
_ 310 .-----
_ 310 | New IODF SDIODF.IODF07.WORK defined. | _____
_ 310 '-----'
_ 3108 SCTC      1      _____
_ 3109 SCTC      1      _____
_ 310A SCTC      1      _____
_ 4000 2105     1      _____
_ 4100 2105     1      _____
F1=Help   F2=Split   F3=Exit   F4=Prompt   F5=Reset   F7=Backward
F8=Forward F9=Swap   F10=Actions F11=Add     F12=Cancel   F13=Instruct
F22=Command

```

5. After defining the control unit, select the processor complex that the control unit is to be attached to (see the following example), and then select option 1 (see the example titled [Select, Change Option](#) on page 1167).

*Example:* Selecting the Operating System

```

Goto  Filter  Backup  Query  Help
----- Select Processor / Control Unit -----
|                                     Row 1 of 1 More:      > |
| Command ==> _____ Scroll ==> CSR |
|                                     |
| Select processors to change CU/processor parameters, then press Enter. |
|                                     |
| Control unit number . . : 2000      Control unit type . . . : 2105 |
|                                     |
|                                     Log. Addr. -----Channel Path ID . Link Address + ----- |
| / Proc. ID Att. (CUADD) + 1---- 2---- 3---- 4---- 5---- 6---- 7---- 8---- |
| _ SYSTEMS _____ |
| ***** Bottom of data ***** |
|                                     |
| F1=Help      F2=Split      F3=Exit      F4=Prompt      F5=Reset |
| F6=Previous  F7=Backward  F8=Forward   F9=Swap       F12=Cancel |
| F20=Right    F22=Command |
|-----|
- 3007 SCTC      1      _____
- 3008 SCTC      1      _____
- 3009 SCTC      1      _____
- 300A SCTC      1      _____
- 3101 SCTC      1      _____
- 3102 SCTC      1      _____
- 3103 SCTC      1      _____
- 3104 SCTC      1      _____
- 3105 SCTC      1      _____
- 3106 SCTC      1      _____
- 3107 SCTC      1      _____
- 3108 SCTC      1      _____
- 3109 SCTC      1      _____
- 310A SCTC      1      _____
- 4000 2105      1      _____
- 4100 2105      1      _____
F1=Help      F2=Split      F3=Exit      F4=Prompt      F5=Reset      F7=Backward
F8=Forward    F9=Swap      F10=Actions F11=Add      F12=Cancel   F13=Instruct
F22=Command

```

**Example: Select, Change Option**

```

Goto Filter Backup Query Help
----- Select Processor / Control Unit -----
|
| Command ==> .----- Actions on selected processors -----|
| Select proces |
| Control unit | Select by number or action code and press Enter. |
| / Proc. ID At | 1. Select (connect, change) . . . . . (s) |
| / SYSTEMS | 2. Group connect . . . . . (g) |
| ***** | 3. Disconnect . . . . . (n) |
| | F1=Help F2=Split F3=Exit F9=Swap F12=Cancel |
|-----|
| F1=Help F2=Split F3=Exit F4=Prompt F5=Reset |
| F6=Previous F7=Backward F8=Forward F9=Swap F12=Cancel |
| F20=Right F22=Command |
|-----|
_ 3007 SCTC 1 _____
_ 3008 SCTC 1 _____
_ 3009 SCTC 1 _____
_ 3109 SCTC 1 _____
_ 310A SCTC 1 _____
_ 4000 2105 1 _____
_ 4100 2105 1 _____
F1=Help F2=Split F3=Exit F4=Prompt F5=Reset F7=Backward
F8=Forward F9=Swap F10=Actions F11=Add F12=Cancel F13=Instruct
F22=Command

```

6. Enter chpids that attach to the control unit, the logical control unit address, the device starting address, and the number of devices supported (see the following example).

*Example:* Control Unit Chpid, CUADD, and Device Address Range Addressing

```

Goto Filter Backup Query Help
----- Select Processor / Control Unit -----
| C ----- Add Control Unit -----
| |
| S |
| | Specify or revise the following values.
| C |
| | Control unit number . . : 2000          Type . . . . . : 2105
| | Processor ID . . . . . : SYSTEMS
| / |
| / | Channel path IDs . . . . 31   32   33   34   54   55   56   57 +
| * | Link address . . . . . _ _ _ _ _ _ _ _ _ _ _ _ _ _ _ _ _ _ _ +
| |
| | Unit address . . . . . 00   _ _ _ _ _ _ _ _ _ _ _ _ _ _ _ _ _ _ +
| | Number of units . . . . 256   _ _ _ _ _ _ _ _ _ _ _ _ _ _ _ _ _ _
| |
| | Logical address . . . . 0_ + (same as CUADD)
| |
| | Protocol . . . . . _ _ + (D,S or S4)
| | I/O concurrency level . 2 + (1, 2 or 3)
| |
| F |
|-- | F1=Help      F2=Split      F3=Exit      F4=Prompt      F5=Reset      F9=Swap
_ 3 | F12=Cancel
_ 3 |-----
_ 3009 SCTC          1
_ 4000 2105          1
_ 4100 2105          1
F1=Help      F2=Split      F3=Exit      F4=Prompt      F5=Reset      F7=Backward
F8=Forward   F9=Swap      F10=Actions F11=Add      F12=Cancel   F13=Instruct
F22=Command

```

- Return to the Define, Modify, or View Configuration Data window, and select option 5 to display the I/O Device List window (see the following example).

*Example:* Define, Modify, Or View Configuration Data

```
----- Define, Modify, or View Configuration Data -----  
  
Select type of objects to define, modify, or view data.  
  
_5 1. Operating system configurations ← Select option 5.  
    consoles  
    system-defined generics `   
    EDTs  
    esoterics  
    user-modified generics  
2. Switches  
   ports  
   switch configurations  
   port matrix  
3. Processors  
   partitions  
   channel paths  
4. Control units  
5. I/O devices  
  
F1=Help   F2=Split   F3=Exit   F9=Swap   F12=Cancel
```

8. From the I/O Device List window, press F11 to start the Add Device dialog (see the following example).

Example: I/O Device List

```

Goto Filter Backup Query Help
-----
-
                                I/O Device List      Row 4854 of 9653 More:
>
Command ==> _____ Scroll ==> CSR
Select one or more devices, then press Enter. To add, use F11. ←Press F11.

-----Device----- --#-- -----Control Unit Numbers + -----
/ Number Type +      PR OS 1--- 2--- 3--- 4--- 5--- 6--- 7--- 8--- Base
- 8100  3390B          1  1  8100  _____ _____ _____ _____ _____ _____
- 8102  3390B          1  1  8100  _____ _____ _____ _____ _____ _____
- 8103  3390B          1  1  8100  _____ _____ _____ _____ _____ _____
- 8104  3390B          1  1  8100  _____ _____ _____ _____ _____ _____
- 8105  3390B          1  1  8100  _____ _____ _____ _____ _____ _____
- 8106  3390B          1  1  8100  _____ _____ _____ _____ _____ _____
- 8107  3390B          1  1  8100  _____ _____ _____ _____ _____ _____
- 8108  3390B          1  1  8100  _____ _____ _____ _____ _____ _____
- 8109  3390B          1  1  8100  _____ _____ _____ _____ _____ _____
- 810A  3390B          1  1  8100  _____ _____ _____ _____ _____ _____
- 810B  3390B          1  1  8100  _____ _____ _____ _____ _____ _____
- 810C  3390B          1  1  8100  _____ _____ _____ _____ _____ _____

```

- From the Add Device window, enter the following: Device number, Number of devices, Device type: 3390B for an HPAV base device, or 3390A for an HPAV alias device (see the following example).

*Example:* Add Device

Add Device		
Specify or revise the following values.		
Device number . . . . .	<u>8101</u> (0000 - FFFF)	← <i>Enter device number.</i>
Number of devices . . . . .	<u>1</u>	← <i>Enter # of devices.</i>
Device type . . . . .	<u>3390B</u>	← <i>Enter device type.</i>
Serial number . . . . .	_____	
Description . . . . .	<u>HP XP1024</u>	← <i>Enter description.</i>
Volume serial number . . . . .	_____ (for DASD)	
Connected to CUs . .	<u>8100</u> _____	← <i>Enter CU.</i>
F1=Help    F2=Split    F3=Exit    F4=Prompt    F5=Reset    F9=Swap		
F12=Cancel -		

- After the device is defined using the Add Device window, add this device to a specific Processor/System-ID combination. [Device / Processor Definition Window – Selecting the Processor ID](#) on page 1172, [Define Device / Processor Window](#) on page 1172, [Device / Processor Definition Window](#) on page 1173, and [Define Device to OS Configuration Window – Selecting the OS Configuration](#) on page 1174 show the HCD windows used to select the Processor and System-ID to which this device will be added.

*Example:* Device / Processor Definition Window – Selecting the Processor ID

```

                                Device / Processor Definition
                                Row 1 of 1
Command ==> _____ Scroll ==> CSR

Select processors to change device/processor definitions, then press
Enter.

Device number . . . : 8101          Number of devices . . : 1
Device type . . . . : 3390B

                                Preferred Explicit Device
/ Processor ID  UA + Time-Out STADET CHPID + Candidate List
/ SYSTEM#S    ___ No         Yes    ___ No ← Select processor.
***** Bottom of data *****

F1=Help      F2=Split      F3=Exit      F4=Prompt    F5=Reset
F6=Previous  F7=Backward   F8=Forward   F9=Swap      F12=Cancel
F22=Command
    
```

*Example:* Define Device / Processor Window

```

                                Define Device / Processor

Specify or revise the following values.

Device number . . : 8101          Number of devices . . . . : 1
Device type . . . : 3390B
Processor ID . . . : SYSTEM#S    Lab System - F9 - Skyline

Unit address . . . . . 01 + (Only necessary when different from
                                the last 2 digits of device number)
Time-Out . . . . . No (Yes or No)
STADET . . . . . Yes (Yes or No)

Preferred CHPID . . . . . ___ +
Explicit device candidate list . No (Yes or No)

F1=Help      F2=Split      F3=Exit      F4=Prompt    F5=Reset    F9=Swap
F12=Cancel -
    
```



*Example:* Device / Processor Definition Window

```

                                Device / Processor Definition
                                Row 1 of 1
Command ==> _____ Scroll ==> CSR

Select processors to change device/processor definitions, then press
Enter.

Device number . . . : 8101          Number of devices . : 1
Device type . . . : 3390B

                                Preferred Explicit Device
/ Processor ID  UA + Time-Out  STADET  CHPID + Candidate List
/ SYSTEM#S     01  No         Yes     ___   No ← Select processor.
***** Bottom of data *****

F1=Help      F2=Split      F3=Exit      F4=Prompt    F5=Reset
F6=Previous  F7=Backward   F8=Forward   F9=Swap      F12=Cancel
F22=Command

```

*Example:* Define Device to OS Configuration Window – Selecting the OS Configuration

```

Define Device to Operating System Configuration
Row 1 of 1
Command ==> _____ Scroll ==> CSR

Select OSs to connect or disconnect devices, then press Enter.

Device number . . : 8101          Number of devices : 1
Device type . . . : 3390B

/ Config. ID  Type      Description                               Defined
/ LABSYSTEM  MVS       OS Configuration List (EDT's)  ← Select OS.
***** Bottom of data *****

F1=Help      F2=Split      F3=Exit      F4=Prompt    F5=Reset
F6=Previous  F7=Backward   F8=Forward   F9=Swap      F12=Cancel
F22=Command
    
```

11. After selecting the OS configuration on the Define Device to Operating System Configuration window (see the previous example), select option 1 to select the device or disconnect the device from the selected OS (see the following example).

*Example:* Select / Disconnect Option

```

Actions on selected operating systems

Select by number or action code and press Enter.

_1 1. Select (connect, change) . . . . . (s)  ← Select option 1.
   2. Disconnect from OS . . . . . (n)

F1=Help      F2=Split      F3=Exit      F9=Swap      F12=Cancel -
    
```

12. The Define Device Parameters / Features window displays the default device parameters (see the following example).

---

**Note:** The WLMPAV parameter defaults to Yes.

---

**Example: Define Device Parameters / Features**

```

Define Device Parameters / Features
                                     Row 1 of 6
Command ==> _____ Scroll ==> CSR

Specify or revise the values below.

Configuration ID . . : LABSYSTEM      OS Configuration List (EDT's)
Device number   . . : 8101           Number of devices   : 1
Device type    . . . : 3390B

Parameter/
Feature   Value   P Req.  Description
OFFLINE   No      P       Device considered online or offline at IPL
DYNAMIC   Yes      P       Device supports dynamic configuration
LOCANY    No      P       UCB can reside in 31 bit storage
WLMPAV    Yes      P       Device supports work load manager ← WLMPAV parameter.
SHARED    Yes      P       Device shared with other systems
SHAREDUP  No      P       Shared when system physically partitioned
***** Bottom of data *****

F1=Help      F2=Split    F3=Exit      F4=Prompt    F5=Reset
F7=Backward  F8=Forward  F9=Swap      F12=Cancel   F22=Command -

```

**Displaying HPAV Device Parameters**

You can display the device parameters using HCD to determine if a specific device is eligible for Dynamic HPAV management by WLM. To display the device parameters:

1. Starting from the I/O Device List window, select the device by entering a “/” by the device number. The example shows device 8101 selected (see the following example).

**Example: Device Selection Display**

```

Goto  Filter  Backup  Query  Help
-----
                                I/O Device List      Row 4854 of 9653 More:      >
Command ===> _____ Scroll ===> CSR

Select one or more devices, then press Enter. To add, use F11.

-----Device-----  --#--  -----Control Unit Numbers + -----
/ Number Type +      PR OS 1--- 2--- 3--- 4--- 5--- 6--- 7--- 8--- Base
_ 8100  3390B        1  1 8100 _____ _____ _____ _____ _____
/ 8101  3390B        1  1 8100 _____ _____ _____ _____ _____ ← Select device.
_ 8102  3390B        1  1 8100 _____ _____ _____ _____ _____
_ 8103  3390B        1  1 8100 _____ _____ _____ _____ _____
_ 8104  3390B        1  1 8100 _____ _____ _____ _____ _____
_ 8105  3390B        1  1 8100 _____ _____ _____ _____ _____
_ 8106  3390B        1  1 8100 _____ _____ _____ _____ _____
_ 8107  3390B        1  1 8100 _____ _____ _____ _____ _____
_ 8108  3390B        1  1 8100 _____ _____ _____ _____ _____
_ 8109  3390B        1  1 8100 _____ _____ _____ _____ _____
_ 810A  3390B        1  1 8100 _____ _____ _____ _____ _____
_ 810B  3390B        1  1 8100 _____ _____ _____ _____ _____
_ 810C  3390B        1  1 8100 _____ _____ _____ _____ _____

```

2. After selecting the device, select option 8 to open the View Device Definition window (see the following example).

**Example: Actions on Selected Devices**

```

                                Actions on selected devices

Select by number or action code and press Enter.

  8  1. Add like . . . . . (a) ← Select option 8.
     2. Change . . . . . (c)
     3. CSS group change . . . . . (g)
     4. OS group change . . . . . (o)
     5. Device type group change . . . . . (t)
     6. Prime serial number and VOLSER . . . (i)
     7. Delete . . . . . (d)
     8. View device definition . . . . . (v)
     9. View logical CU information . . . . (l)
    10. View related CTC connections . . . (k)
    11. View graphically . . . . . (h)

F1=Help      F2=Split      F3=Exit      F9=Swap      F12=Cancel

```

- Review the information on the View Device Definition window and press Enter to continue (see the following example).

*Example:* View Device Definition

```

View Device Definition

Device number . . . . . : 8101
Device type . . . . . : 3390B

Serial number . . . . . :
Description . . . . . : HP XP1024 - 8101 (B)

Volume serial number . . . . :          (for DASD)

Connected to CUs : 8100

ENTER to continue.                ← Press Enter to continue.

F1=Help    F2=Split    F3=Exit    F9=Swap    F12=Cancel -

```

- Select the processor definition on the View Device / Processor Definition window (see the following example).

*Example:* Selecting the Processor Definition

```

View Device / Processor Definition
Row 1 of 1
Command ==> _____ Scroll ==> CSR

Select one or more processors to view the device candidate list, or
ENTER to continue without selection.

Device number . : 8101    Device type . : 3390B

/ Processor ID UA   Time-Out STADET  CHPID   Preferred Explicit Device
/ SYSTEM#S      00   No       Yes     Yes     Candidate List
Yes ← Select processor.
***** Bottom of data *****

F1=Help    F2=Split    F3=Exit    F6=Previous    F7=Backward
F8=Forward    F9=Swap    F12=Cancel    F22=Command

```

- Review the candidate list for this device and press Enter to continue (see the following example).

*Example:* View Device Candidate List

```

View Device Candidate List
Row 1 of 5
Command ==> _____ Scroll ==> CSR

The following partitions are allowed to have access to the
device.

Device number . : 8101      Device type . . . : 3390B
Processor ID . . : SYSTEM#S  Lab System - F9 - Skyline

ENTER to continue.                ← Press Enter to continue.

Partition Name  Description                      Reachable
AS04            System A / LPAR 4                            Yes
DASDPERF       DASD Performance & Testing                  Yes
MVSLAB         MVS Lab System - OS/390 2.9                Yes
OS390          OS/390 Testing (ie. SYSPLEX)                Yes
VMLAB          VM Lab System - VM/ESA 1.2.0              Yes
***** Bottom of data *****

F1=Help      F2=Split      F3=Exit      F7=Backward  F8=Forward
F9=Swap      F12=Cancel   F22=Command -

```

- From the View Device / OS Configuration Definitions window, select the OS configuration (see the following example).

*Example:* Selecting the OS Configuration

```

View Device / OS Configuration Definitions
Row 1 of 1
Command ==> _____ Scroll ==> CSR

Select OSs to view more details, then press Enter.

Device number . : 8101      Device type . . . : 3390B

/ Config. ID  Type      Description
/ LABSYSTM   MVS      OS Configuration List (EDT's) ← Select OS.
***** Bottom of data *****

F1=Help      F2=Split      F3=Exit      F6=Previous  F7=Backward
F8=Forward   F9=Swap      F12=Cancel   F22=Command -

```

7. The View Device Parameter / Feature Definition window displays the WLMPAV device parameters (see the following example).

*Example:* View Device Parameters

```

~
                                View Device Parameter / Feature Definition
                                Row 1 of 6
Command ==> _____ Scroll ==> CSR

Configuration ID . : LABSYSTEM      OS Configuration List (EDT's)
Device number . . : 8100           Device type . . . : 3390B
Generic / VM device type . . . . : 3390

ENTER to continue.

Parameter/
Feature      Value   Req.  Description
OFFLINE      No      Req.  Device considered online or offline at IPL
DYNAMIC      Yes     Req.  Device supports dynamic configuration
LOCANY       Yes     Req.  UCB can reside in 31 bit storage
WLMPAV       Yes     Req.  Device supports work load manager ← WLMPAV parameter.
SHARED       Yes     Req.  Device shared with other systems
SHAREDUP     No      Req.  Shared when system physically partitioned
***** Bottom of data *****

F1=Help      F2=Split    F3=Exit     F7=Backward F8=Forward
F9=Swap      F12=Cancel  F22=Command -

```

## Checking the WLM PAV Settings

To view or change the Workload Manager PAV settings:

1. From the WLM Initial window, press Enter to continue (see the following example).

*Example:* WLM Initial Window

```

Command ==>
-----

          W  W  L      M  M
          W  W  L      MM MM
          W W W  L      M M M
          WW WW  L      M  M
          W   W  LLLLL M  M

          Licensed Materials - Property of IBM

          5647-A01 (C) Copyright IBM Corp. 2000.
          All rights reserved.

          ENTER to continue
    
```

2. Use the Service Definition window to define where the service coefficient information can be found. Select option 1 to read the saved definition (see the following example).



*Example:* WLM Choose Service Definition Window

```

File  Help
-----
Command ===> _____

      |-----|
      |          Choose Service Definition          |
      |-----|
      | Select one of the following options.        |
      | 1 1. Read saved definition                 | ← Select option 1.
      |      2. Extract definition from WLM        |
      |      couple data set                       |
      |      3. Create new definition              |
      |-----|
      | F1=Help      F2=Split      F5=KeysHelp     |
      | F9=Swap      F12=Cancel     |
      |-----|
      |
      |-----|
      |          ENTER to continue          |
      |-----|
  
```

3. From the Primary Options window, select option 8 to display the WLM PAV settings (see the following example).

*Example:* WLM Primary Options Window

```

File  Utilities  Notes  Options  Help
-----
Functionality LEVEL008          Definition Menu          WLM Appl LEVEL011
Command ===> _____

Definition data set . . . : none

Definition name . . . . . STANDARD (Required)
Description . . . . . Standard Definition

Select one of the
following options. . . . . 8 1. Policies                 ← Select option 8.
                                2. Workloads
                                3. Resource Groups
                                4. Service Classes
                                5. Classification Groups
                                6. Classification Rules
                                7. Report Classes
                                8. Service Coefficients/Options
                                9. Application Environments
                                10. Scheduling Environments
  
```

4. Use the Service Coefficient/Service Definition Options window to set PAV Dynamic Alias Management (see the following example).

*Example:* WLM Service Coefficient/Service Definition Options Window

```

Coefficients/Options  Notes  Options  Help
-----
--
                Service Coefficient/Service Definition Options
Command ===>
-----

Enter or change the Service Coefficients:

CPU . . . . . 1.0      (0.0-99.9)
IOC . . . . . 0.1      (0.0-99.9)
MSO . . . . . 0.0000   (0.0000-99.9999)
SRB . . . . . 1.0      (0.0-99.9)

Enter or change the service definition options:

I/O priority management . . . . . YES (Yes or No)
Dynamic alias management . . . . . YES (Yes or No)

```

# SANtinel - S/390 for the XP128/XP1024 (Mainframe)



25

SANtinel protects data in your disk array from I/O operations performed at mainframe hosts. You can use SANtinel to apply security to logical volumes so that the specified mainframe hosts will be unable to read from and write to the specified logical volumes. You can also use SANtinel to prevent data on logical volumes from being overwritten by erroneous remote copy operations.

SANtinel can be used in conjunction with an add-in program called SANtinel Port Security Option, which provides port-level security by preventing hosts from accessing logical volumes through specified ports.

Port-level security is a security policy for enabling hosts to access logical volumes only through ports registered in host groups and thus prohibiting hosts to access the volumes through other ports.

---

**Note:** Logical volumes are sometimes referred to as logical devices or LDEVs. Also, this chapter sometimes uses the term LDEV security to refer to the security policy that you can apply to logical volumes.

---

## Overview of SANtinel Operations

### System Requirements

To use SANtinel, you need the following:

- XP128/XP1024 with firmware version 21.06.22 or later installed
- Web client to access the Command View management station
- SANtinel license key installed.

To apply port-level security, also install SANtinel Port Security Option. Before installing this program, SANtinel must already be installed.

### Protecting Logical Volumes from I/O Operations at Mainframe Hosts

Use SANtinel to protect logical volumes from unauthorized accesses by mainframe hosts. To protect logical volumes from unauthorized accesses, you must create *security groups* and then register mainframe hosts and/or logical volumes in security groups. Security groups are classified into *access groups* or *pool groups*. If you want to allow some mainframe hosts to access logical volumes, you must classify the security group as an access group. If you want to prohibit all mainframe hosts from access logical volumes, classify the security group as a pool group.

### Enabling Only the Specified Hosts to Access Logical Volumes

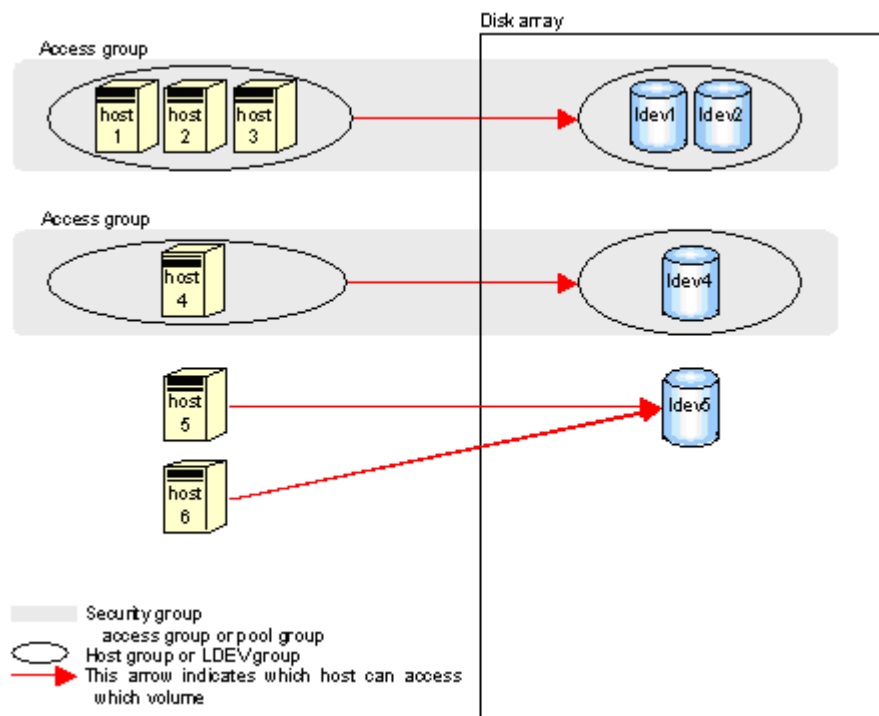
If you want to allow only some mainframe hosts in your network to access logical volumes, register the mainframe hosts and the logical volumes in an access group. For example, if you register two hosts (*host\_A* and *host\_B*) and two logical volumes (*vol\_C* and *vol\_D*) in an access group, only the *host\_A* and *host\_B* will be able to access *vol\_C* and *vol\_D*. No other hosts will be able to access *vol\_C* and *vol\_D*.

If mainframe hosts are registered in an access group, the hosts will be able to access logical volumes in the same access group, but will be unable to access other logical volumes. For example, if you register two hosts (*host\_A* and *host\_B*) and two logical volumes (*vol\_C* and *vol\_D*) in an access group, the *host\_A* and *host\_B* can access *vol\_C* and *vol\_D*, but cannot access other logical volumes.

To register hosts in an access group, create a host group, register the hosts in the host group, and then register the host group in the access group. To register logical volumes in an access group, create an LDEV group, register the logical volumes in the LDEV group, and then register the LDEV group in the access group. An access group can only contain one host group and one LDEV group.

The following figure shows six mainframe hosts attached to a disk array, and two available access groups. The following security settings have been applied:

- The logical volumes *ldev1* and *ldev2* are accessible only from *host1*, *host2*, and *host3* because the two volumes and the three hosts are registered in the same access group.
- The logical volume *ldev4* is accessible only from *host4* because *ldev4* and *host4* are registered in the same access group.
- The logical volume *ldev5* does not belong to any access groups. For this reason, hosts in access groups cannot access *ldev5*. *ldev5* is only accessible from *host5* and *host6*, which are not registered in access groups.



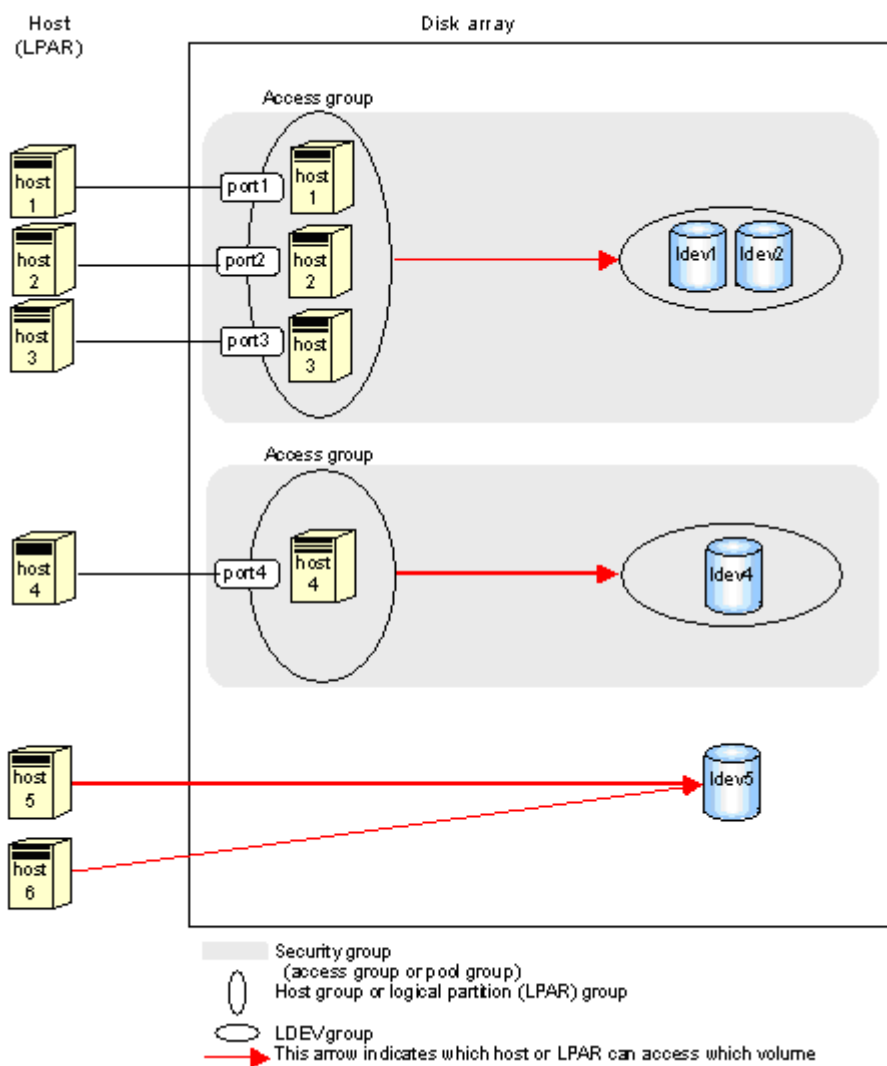
**Figure 406: Security example 1**

Usually, hosts are connected to two or more ports by cables and have access to logical volumes through these ports. In the previous security example, hosts in access groups can access logical volumes through every port to which the hosts are connected.

However, SANtinel Port Security Option prohibits hosts from accessing logical volumes through specified ports. For example, if a host named *host1* is connected to two ports (*port1* and *port2*), you can permit the host to access logical volumes through *port1* and prohibit the host from accessing logical volumes through *port2*. To implement port-level security, first determine which ports hosts can use to access logical volumes, and then you must register the ports in host groups. For example, if you register *host1* and *port1* in the same host group named *hg1* and then register *hg1* in an access group, *host1* can access logical volume through *port1* but cannot access logical volumes through *port2*.

In security example 2, the following security settings have been applied:

- The hosts *host1*, *host2*, and *host3* can access the logical volumes *ldev1* and *ldev2* through *port1*, *port2*, and *port3*. However, the hosts cannot access the logical volumes through other ports.
- The host *host4* can access the logical volume *ldev4* through *port4*. However, the host cannot access the logical volume through other ports.



**Figure 407: Security example 2**

If no ports are registered in a host group, hosts in the host group can access logical volumes through the ports to which the hosts are connected.

Before you apply security, confirm which hosts are performing I/O operations on logical volumes in access groups. If any hosts perform I/O operations on logical volumes in access groups that the hosts do not belong to, stop the I/O operations

before applying security. For example, if you attempt to apply security settings illustrated in the previous figure, an error occurs and the attempt fails if *host4* and *host5* are performing I/O operations on *ldev1*. To apply the security settings, first ensure that *host4* and *host5* are not performing I/O operations on *ldev1*.

### Prohibiting All Hosts from Accessing Logical Volumes

To prevent all the mainframe hosts from accessing logical volumes, register the logical volumes in a *pool group*. You do not need to register hosts in pool groups. For example, if you register two logical volumes (*vol\_A* and *vol\_B*) in a pool group, all the mainframe hosts connected to your disk array will be unable to access *vol\_A* and *vol\_B*. To register logical volumes in a pool group, create an LDEV group, register the logical volumes in the LDEV group, and then register the LDEV group in the pool group. A pool group can only contain one LDEV group.

The following figure shows an example of a pool group. The logical volumes in this pool group are not accessible from all the hosts.

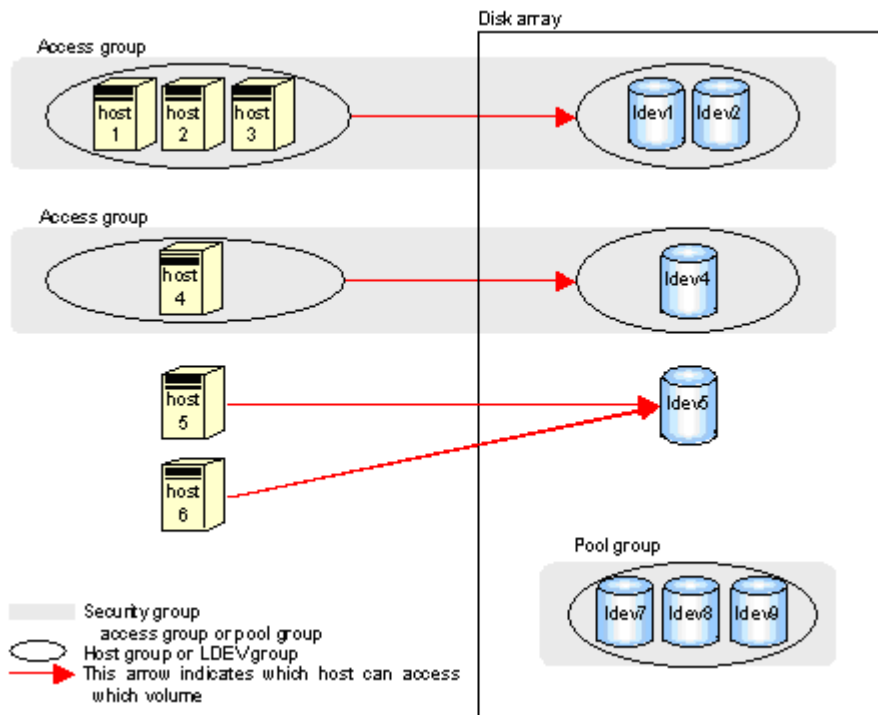


Figure 408: Security example 3



## Protecting Logical Volumes from Erroneous Remote Copy Operations

If you use TrueCopy (TC390) or ShadowImage (SI390) to perform remote copy operations, data will be overwritten onto the secondary volumes. If a volume containing important data is specified as a secondary volume by mistake, TC390 or SI390 remote copy operations can overwrite important data on the volume and you could suffer loss of important data. SANtinel prevents this type of data loss. If a volume contains data that should not be overwritten, you can prevent the volume from being used as a secondary volume.

---

**Note:** Secondary volumes are often referred to as remote volumes or R-VOLs in the TC390 chapter. Also, secondary volumes are referred to as target volumes or T-VOLs in the SI390 chapter.

---

## Restrictions and Cautions

Do not apply security to logical volumes on which any job is running. If you apply security to such a volume, the job will possibly end abnormally.

When applying security, please make sure that your security settings are correct. If incorrect security settings are made, the system will be difficult or impossible to control.

If the CPU of a mainframe host is upgraded after you apply security settings, execute the system command “D M=CPU” at the mainframe host to obtain the latest information about the host. Next, use the latest information to update host information in the Add/Change Host window. If you do not update host information, the system will be impossible to control.

### **Volume emulation types (or device emulation types)**

SANtinel supports the following volume emulation types: 3990-3, 3390-3A, 3390-3B, 3390-3C, 3390-3R, 3390-9, and 3390-L.

### **PCB types**

SANtinel supports the following PCB types:

- ESCON or ACONARC
- FICON or FIBARC

### **Maximum possible number of security groups, host groups, and LDEV groups**

SANtinel can manipulate up to 32 hosts and 8,192 logical volumes for one disk array. SANtinel can create up to 32 security groups, 32 host groups, and 32 LDEV groups for one disk array.

Security groups are classified into access groups and pool groups:

- An access group can contain only one host group and one LDEV group. A host group can contain up to 16 hosts. An LDEV group can contain up to 8,192 logical volumes.
- A pool group can contain only one LDEV group. An LDEV group can contain up to 8,192 logical volumes.

### **TrueCopy (TC390) or ShadowImage (SI390) users**

When you use SANtinel to make security settings, be sure to register the primary volume and the secondary volume (such as, the copy source volume and the copy destination volume) in the same LDEV group. For information on how to register volumes in LDEV groups, refer to [Registering Logical Volumes in an LDEV Group](#) on page 1202.

If you apply security to a primary volume of a TC390 pair or an SI390 pair, some or all mainframe hosts might be unable to read from and write to the primary volume. However, the remote copy operation will perform normally; data will copy from the primary volume to the secondary volume.

If you register a primary volume or secondary volume in a security group and then make a setting to prevent the volume from being used as a secondary volume, this setting will take effect after the pair is split.

Mainframe hosts cannot access logical volumes in pool groups. If a logical volume in a pool group is specified as a primary volume, the pair creation command might fail.

In the TC390 chapter, primary volumes are often referred to as M-VOLs or main volumes. Also, secondary volumes are often referred to as R-VOLs or remote volumes. In the SI390 chapter, primary volumes are often referred to as S-VOLs or source volumes. Also, secondary volumes are often referred to as T-VOLs or target volumes.

### **VSC volumes**

If you apply security to a VSC volume, you will be unable to change the VSC settings on the volume. To change the VSC settings, use SANtinel to disable security on the VSC volume. For details on how to disable security, refer to [Disabling Security](#) on page 1210.

**HPAV users**

If you apply security to an HPAV base volume, the security settings will also apply to the corresponding alias volume.

**Removing secured logical volumes**


If you apply security to a logical volume, you will be unable to remove the volume. To remove the volume, disable security on the volume. For details on how to disable security, refer to [Disabling Security](#) on page 1210.

**Removing PCBs with secured ports**

If port-level security is applied to your disk array, you cannot remove the PCBs (printed circuit boards) that include secured ports. To remove PCBs that include secured ports, use SANtinel Port Security Option to disable security on the ports. For details on how to disable security, refer to [Deleting Ports from Host Groups](#) on page 1218.

## Starting SANtinel

### To access SANtinel:

1. From the Launch screen, click an XP128 or XP1024.
2. Click the **Mainframe** tab, click the **Mainframe Connection** button (  ), and then click the **SANtinel** tab. The SANtinel screen is displayed.

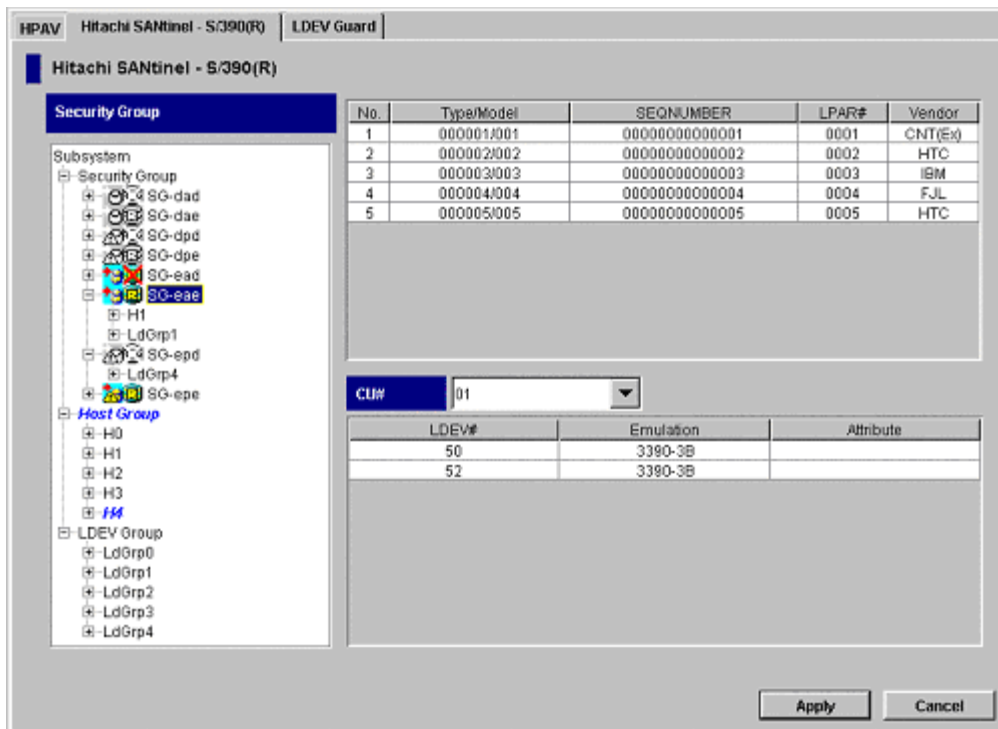


Figure 409: SANtinel screen

## SANtinel Screen

The SANtinel screen is the starting point for all the SANtinel operations.









### Security Group tree

The Security Group tree is located on the left side of the screen and displays a view a list of security groups, host groups, and LDEV groups. The tree contains the following folders:

- **Security Group:** Contains all of the security groups. Double-clicking a security group displays the host group and/or LDEV group registered in the security group.

The security group icons show the security settings applied to the logical volumes.

**Table 177: Security group icons for SANtinel operations**

Icon	Status
	Logical volumes in this access group can be used as secondary volumes for remote copy operations.
	Logical volumes in this access group cannot be used as secondary volumes for remote copy operations.
	Logical volumes in this pool group can be used as secondary volumes for remote copy operations.
	Logical volumes in this pool group cannot be used as secondary volumes for remote copy operations.
	The security settings in this security group are currently disabled. If you enable the security settings, this security group will be classified as an access group. Also, logical volumes in this security group can be used as secondary volumes for remote copy operations.
	The security settings in this security group are currently disabled. If you enable the security settings, this security group will be classified as an access group. Also, logical volumes in this security group will be unavailable for use as secondary volumes for remote copy operations.
	The security settings in this security group are currently disabled. If you enable the security settings, this security group will be classified as a pool group. Also, logical volumes in this security group will be available for use as secondary volumes for remote copy operations.
	The security settings in this security group are currently disabled. If you enable the security settings, this security group will be classified as a pool group. Also, logical volumes in this security group will be unavailable for use as secondary volumes for remote copy operations.

- **Host Group:** Contains all of the host groups.
- **LDEV Group:** Contains all of the LDEV groups.

Changes made to the groups in the Security Group tree are displayed in italics and in blue. The text will be restored to the original typeface and color when changes are applied or canceled.

### Hosts table

The Hosts table is located in the upper-right area of the screen and displays information about the hosts. The table contents depends the item selected in the Security Group tree.

- Click one of the group folders (Security Group, Host Group, or LDEV Group) to display all the hosts.
- Click a security group to display all the hosts that belong to the selected security group.
- Click a host group to display all the hosts that belong to the selected host group.
- Clicking an LDEV group displays nothing.

The table columns provide the following information:

- **Type/Model:** The type and the model number of a host or a channel extender.
- **SEQNUMBER:** The node ID of a host or a channel extender.
- **LPAR#:** A logical partition number of a host.
- **Vendor:** The vendor of the host. For instance, this column can display **FJT** (Fujitsu), **IBM**, **HTC** (Hitachi), and **CNT(Ex)**. If **CNT(Ex)** is displayed, the table row indicates the type, the model number, and the node ID of a channel extender.

Changes made to a host are displayed in italics and in blue. The text will be restored to the original typeface and color when changes are applied or canceled.

### LDEVs table

The LDEVs table is located in the lower-right area of the screen and displays information about the logical volumes.

- **CU#:** Use this drop-down list to select a logical CU, which displays the logical volumes in the selected CU.

The table contents depends on the item selected in the Security Group tree.

- Click one of the group folders (Security Group, Host Group, or LDEV Group) to display all the logical volumes that are accessible from the mainframe hosts.
- Click a security group to display all the logical volumes that belong to the selected security group.
- Click an LDEV group to display all the logical volumes that belong to the selected LDEV group.

- Clicking a host group displays nothing.

The table columns provide the following information:

- **LDEV#:** The logical volume ID. This ID is a hexadecimal number (00 to FF).
- **Emulation:** The emulation type of the logical volume.
- **Attribute:** The status of the logical volume. If an asterisk (\*) is displayed, the logical volume is specified as a secondary volume (copy destination) for TC390 or SI390. If a plus symbol (+) is displayed, one or more LU paths are assigned to the logical volume.

Changes made to a logical volume are displayed in italics and in blue. The text will be restored to the original typeface and color when changes are applied or canceled.

#### **Buttons**

- **Apply button:** Applies the settings made on this screen to the disk array.
- **Cancel button:** Discards changes and restores the initial settings.

## Applying and Disabling Security

This section contains the following topics about applying security settings:

- Enabling specific hosts to access certain logical volumes (see page 1196)
- Prohibiting all hosts from accessing logical volumes (see page 1206)
- Preventing data in logical volumes from being overwritten by remote copy operations (see page 1208)
- Disabling security (see page 1210)

You must operate Command View in Modify mode to perform SANtinel operations. Users in view mode can only view SANtinel information.

## Enabling Only the Specified Hosts to Access Logical Volumes

Take the following steps to allow specific hosts to access certain logical volumes so that the other hosts cannot access the volumes:

- Create a host group (see page 1196)
- Register hosts in the host group (see page 1198)
- Register ports in the host group (see page 1200)
- Create an LDEV group (see page 1201)
- Register logical volumes in an LDEV group (see page 1202)
- Create a security group and classify it as an access group (see page 1204)
- Register a host group and an LDEV group in the security group (see page 1205)

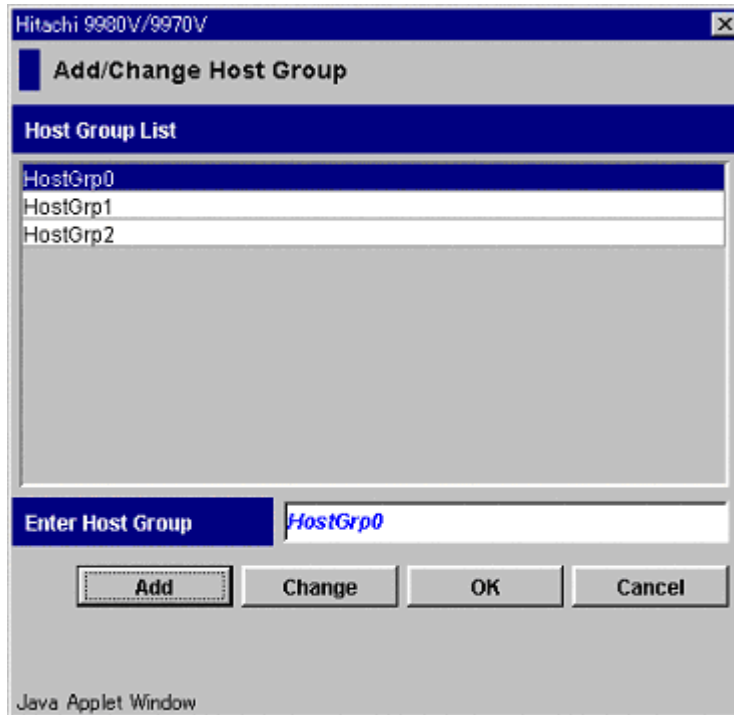
## Creating a Host Group

To specify which hosts can access certain volumes, first create a host group.

### To create a host group:

1. From the SANtinel screen, right-click **Host Group**. A pop-up menu is displayed.
2. Click **Add/Change** from the pop-up menu. The Add/Change Host Group window is displayed.









**Figure 410: Add/Change Host Group window**

3. In the **Enter Host Group** field, enter the name of the host group that you want to create, and then click **Add**.  
 Host group names can be up to eight characters and are case-sensitive. The first character and the last character must not be a space. Also, the following characters are unusable in host group names: \ , / : ; \* ? " < > |
4. Confirm that the new host group is shown in blue in Host Group List, and then click **OK**.
5. From the SANtinel screen, click **Apply**. A confirmation dialog box is displayed.
6. Click **Yes**. The settings are applied to the disk array.

## Registering Hosts in a Host Group

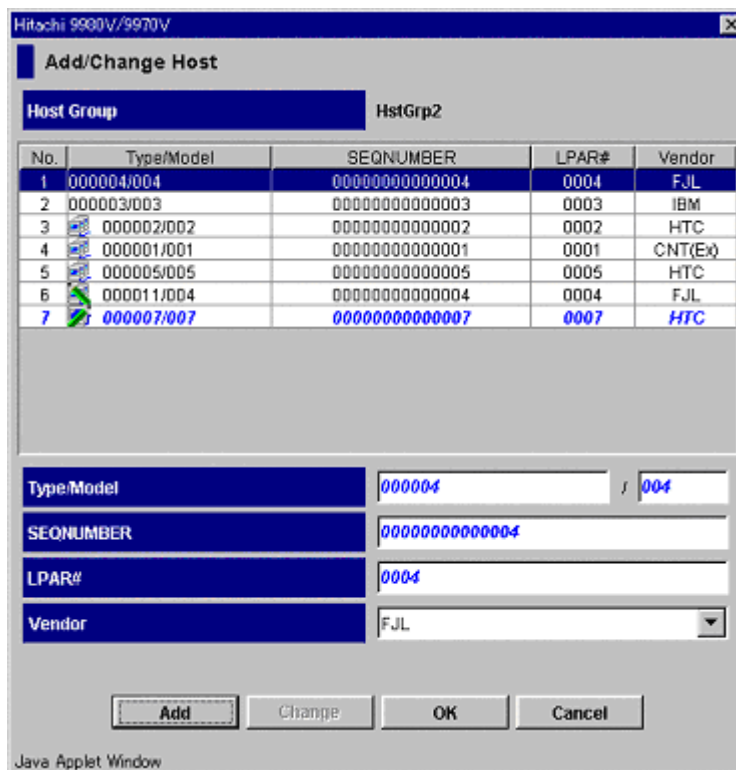
After creating a host group, register hosts in a host group by using the Add/Change Host window. The Add/Change Host window contains a table that lists the hosts. The following icons are used in the table:

**Table 178: Add/Change Host window icons**

Icon	Status
	The host is registered in the current host group and is attached to the disk array by a cable.
	The host is registered in the current host group and is <i>not</i> attached to the disk array.
	The host is registered in another host group (though the host can be registered in the current host group) and is attached to the disk array by a cable.
	The host is registered in another host group (though the host can be registered in the current host group), but it is <i>not</i> attached to the disk array.
<i>No icon</i>	The host is <i>not</i> registered in any host group, but it is attached to the disk array by a cable.



### To register hosts in a host group:

1. From the SANtinel screen, right-click a host group. A pop-up menu is displayed.
2. Click **Specify** and then **Host** from the pop-up menu. The Add/Change Host window displays a list of hosts.





**Figure 411: Add/Change Host window**

3. Select and then right-click one or more hosts that you want to register.

The  or  icon indicates that the host is already registered in the specified host group. You cannot register hosts that belong to any other host group. If no ports are registered in the displayed host group, you can register the following hosts:

- Hosts that do not belong to any host group.
- Hosts belonging to host groups in which no ports are registered. You cannot register hosts belonging to host groups in which ports are registered.

4. Click **Registration** and then **Register Host in Host Group** from the pop-up menu. The specified hosts are shown in blue and are represented with the  or  icon.
5. Click **OK**.

6. From the SANtinel screen, click **Apply**. A confirmation dialog box is displayed.
7. Click **Yes**. The settings are applied to the disk array.

## Registering Ports in a Host Group

After registering hosts in a host group, you can register ports in the host group to implement port-level security. This is an optional step, but to do this, you must have SANtinel Port Security Option installed.

If you do not want to implement port-level security, you do not need to register ports in host groups. If no ports are registered in a host group, hosts in the host group can access logical volumes through every port to which the hosts are connected.

### To register ports in a host group:

1. From the SANtinel screen, right-click a host group. A pop-up menu is displayed.
2. Click **Specify** and then **Port** from the pop-up menu. The Select Port window displays a list of ports.

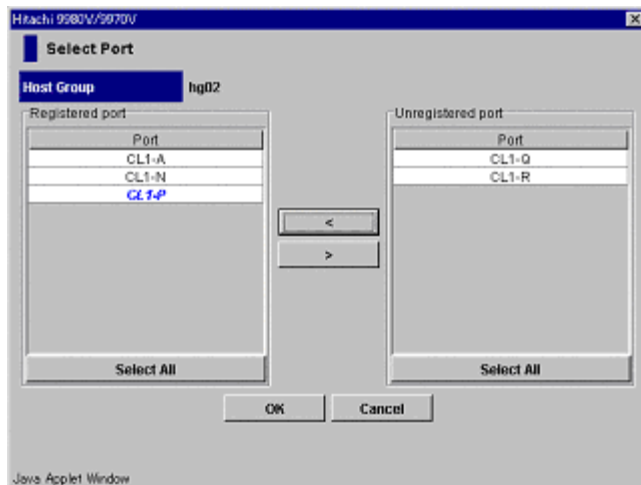


Figure 412: Select Port window

3. From the Unregistered port list, click the ports you want to register and then click the < button to move them to the Registered port list. The specified ports should be shown in blue in the Registered port list. To select all the ports in the Unregistered port list, click **Select All**.

---

**Note:** If hosts registered in the host group are also registered in another host group, you cannot register the ports in Registered port list, and thus you cannot implement port-level security.

---

4. Click **OK**.
5. From the SANtinel screen, click **Apply**. A confirmation dialog box is displayed.
6. Click **Yes**. The settings are applied to the disk array.

## Creating an LDEV Group

To specify logical volumes that should be secured, create an LDEV group and then register the logical volumes in the LDEV group.

### To create an LDEV group:

1. From the SANtinel screen, right-click **LDEV Group**. A pop-up menu is displayed.
2. Click **Add/Change** from the pop-up menu. The Add/Change LDEV Group window is displayed.



**Figure 413: Add/Change LDEV Group window**

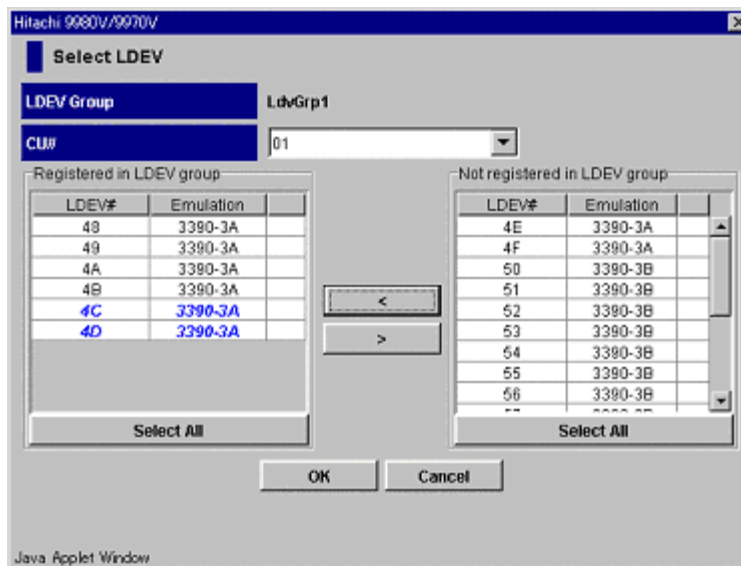
3. In the **Enter LDEV Group** field, enter the name of the LDEV group that you want to create, and then click **Add**.  
LDEV group names can be up to eight characters and are case-sensitive. The first character and the last character must not be a space. Also, the following characters are unusable in host group names: \ , / : ; \* ? " < > |
4. Confirm that the new LDEV group is shown in blue in LDEV Group List, and then click **OK**.
5. From the SANtinel screen, click **Apply**. A confirmation dialog box is displayed.
6. Click **Yes**. The settings are applied to the disk array.

## Registering Logical Volumes in an LDEV Group

After creating an LDEV group, register the logical volumes in an LDEV group.

**To register logical volumes in an LDEV group:**

1. From the SANtinel screen, right-click **LDEV Group**. A pop-up menu is displayed.
2. Click **Specify** and then **LDEV** from the pop-up menu. The Select LDEV window is displayed.

**Figure 414: Select LDEV window**

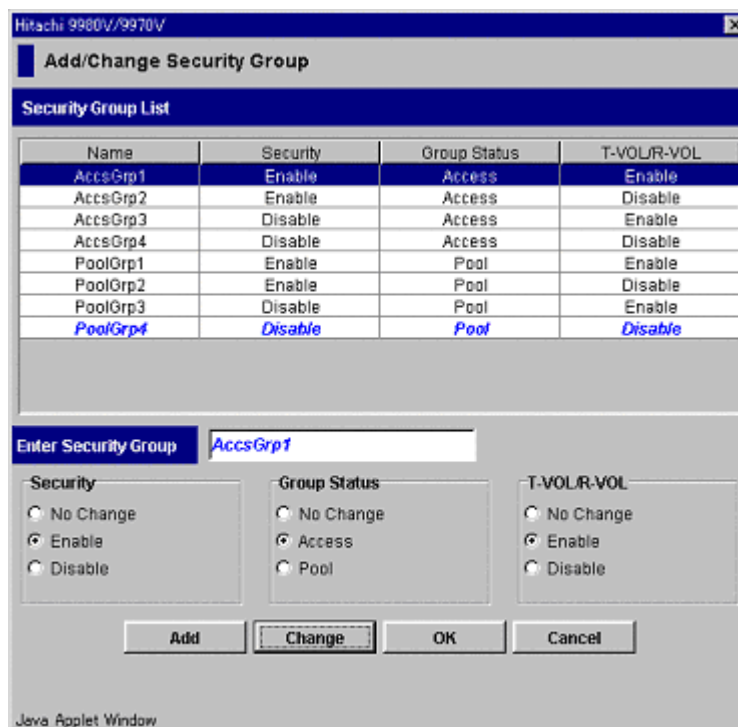
3. In the **CU#** drop-down list, click a CU image. The tables located below the drop-down list display the logical volumes in the CU image you selected. The **Registered in LDEV group** table displays the logical volumes registered in the LDEV group. The **Not registered in LDEV group** table displays logical volumes that are not registered in the LDEV group.
4. In the **Not registered in LDEV group** table, click the logical volumes that you want to register. Then, click the **<** button to move the selected logical volumes move to the **Registered in LDEV group** table.
5. To register logical volumes in other CU images, repeat the previous steps.
6. Click **OK**.
7. From the SANtinel screen, click **Apply**. A confirmation dialog box is displayed.
8. Click **Yes**. The settings are applied to the disk array.

## Creating a Security Group for Use As an Access Group

To make security settings, you must create security groups. You can classify security groups as access groups or pool groups. To allow logical volumes to be accessed only by specified hosts, classify a security group as an *access group*.

**To create a security group and classify the group as an access group:**

1. From the SANtinel screen, right-click **Security Group**. A pop-up menu is displayed.
2. Click **Add/Change** from the pop-up menu. The Add/Change Security Group window is displayed.



**Figure 415: Add/Change Security Group window**

3. In the **Enter Security Group** field, enter the name of the security group that you want to create.



Security group names can be up to eight characters and are case-sensitive. The first character and the last character must not be a space. Also, the following characters are unusable in security group names: \ , / : ; \* ? " < > |

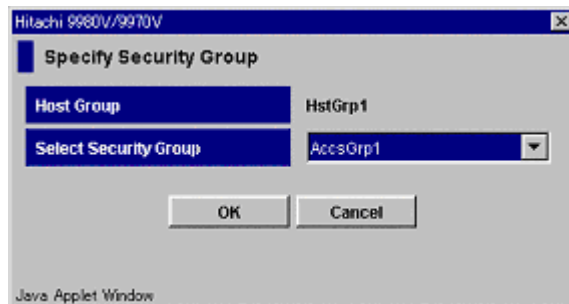
4. Under Security, click **Enable**.
5. Under Group Status, click **Access**.
6. Under T-VOL/R-VOL, click **Enable** or **Disable**. Click **Enable** to allow logical volumes in the security group to be used as secondary volumes for remote copy operations. Click **Disable** to prohibit this.
7. Click **Add**. Information about the new security group is added to the Security Group List and is shown in blue.
8. Click **OK**.
9. From the SANtinel screen, click **Apply**. A confirmation dialog box is displayed.
10. Click **Yes**. The settings are applied to the disk array.

## Registering a Host Group and an LDEV Group in a Security Group

After classifying your security group as an access group, register your host group and LDEV group into the security group. When you complete this, the logical volumes in the LDEV group are secured and can only be accessed by hosts in the host group. Other hosts cannot access the logical volumes.

### To register a host group and an LDEV group into a security group:

1. From the SANtinel screen, right-click a host group. A pop-up menu is displayed.
2. Click **Specify** and then **Security Group** from the pop-up menu. The Specify Security Group window is displayed.



**Figure 416: Specify Security Group window**

3. In the **Select Security Group** drop-down list, click a security group and then click **OK**.
4. From the SANtinel screen, right-click an LDEV group. A pop-up menu is displayed.
5. Click **Specify** and then **Security Group** from the pop-up menu. The Specify Security Group window is displayed.
6. In the **Select Security Group** drop-down list, click the security group and then click **OK**.
7. From the SANtinel screen, click **Apply**. A confirmation dialog box is displayed.
8. Click **Yes**. The settings are applied to the disk array.

## Prohibiting All Hosts from Accessing Logical Volumes

To prohibit all the hosts from accessing the specified logical volumes, complete the following steps:

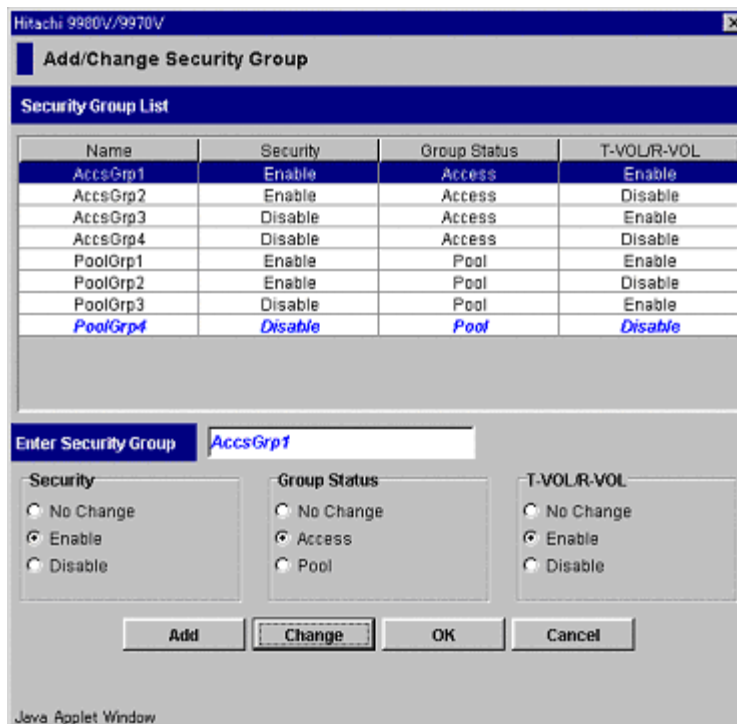
- Create an LDEV group (see page 1201 from the previous section)
- Register logical volumes in the LDEV group (see page 1202 from the previous section)
- Create a security group and classify it as a pool group (see page 1206)
- Register the LDEV group in the security group (see page 1208)

## Creating a Security Group for Use As a Pool Group

To make security settings, you must create security groups. You can classify security groups as access groups or pool groups. To prohibit all hosts from accessing logical volumes, classify a security group as a *pool group*. Complete this step after creating an LDEV group and registering logical volumes in the LDEV group.

**To create a security group and classify the group as a pool group:**

1. From the SANtinel screen, right-click **Security Group**. A pop-up menu is displayed.
2. Click **Add/Change** from the pop-up menu. The Add/Change Security Group window is displayed.



**Figure 417: Add/Change Security Group window**

- In the **Enter Security Group** field, enter the name of the security group that you want to create.  
Security group names can be up to eight characters and are case-sensitive. The first character and the last character must not be a space. Also, the following characters are unusable in security group names: \ , / : ; \* ? " < > |
- Under **Security**, click **Enable**.
- Under **Group Status**, click **Pool**.
- Under **T-VOL/R-VOL**, click **Enable** or **Disable**. Click **Enable** to allow logical volumes in the security group to be used as secondary volumes for remote copy operations. Click **Disable** to prohibit this.
- Click **Add**. Information about the new security group is added to the Security Group List and is shown in blue.
- Click **OK**.

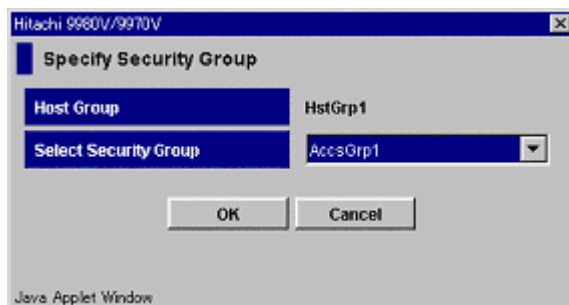
9. From the SANtinel screen, click **Apply**. A confirmation dialog box is displayed.
10. Click **Yes**. The settings are applied to the disk array.

## Registering an LDEV Group in a Security Group

After classifying your security group as a pool group, register your LDEV group into the security group. When you complete this, the logical volumes in the LDEV group are secured and inaccessible from any hosts.

### To register an LDEV group into a security group:

1. From the SANtinel screen, right-click an LDEV group. A pop-up menu is displayed.
2. Click **Specify** and then **Security Group** from the pop-up menu. The Specify Security Group window is displayed.



**Figure 418: Specify Security Group window**

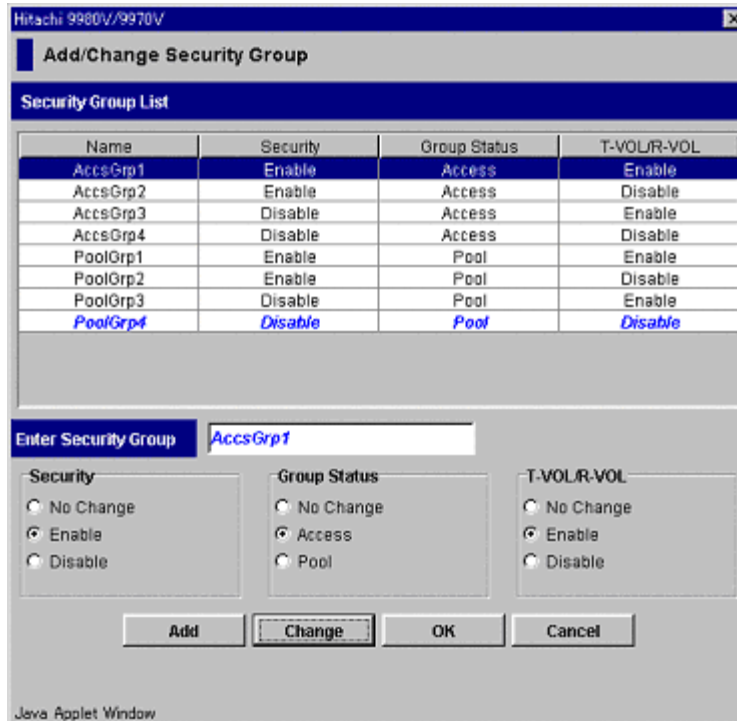
3. In the **Select Security Group** drop-down list, click a security group and then click **OK**.
4. From the SANtinel screen, click **Apply**. A confirmation dialog box is displayed.
5. Click **Yes**. The settings are applied to the disk array.

## Protecting Logical Volumes from Remote Copy Operations

The following procedure makes logical volumes in a security group unusable as secondary volumes for remote copy operations and protects data the logical volumes from being overwritten by remote copy operations.

**To make logical volumes in a security group unusable as secondary volumes:**

1. From the SANtinel screen, right-click **Security Group** or any specific security group. A pop-up menu is displayed.
2. Click **Add/Change** from the pop-up menu. The Add/Change Security Group window is displayed.



**Figure 419: Add/Change Security Group window**

3. In the Security Group List, click the security group you want to change.
4. Under T-VOL/R-VOL, click **Disable**.
5. Click **Change**. The change is reflected in the window.
6. Click **OK**.
7. From the SANtinel screen, click **Apply**. A confirmation dialog box is displayed.
8. Click **Yes**. The settings are applied to the disk array.

**Note:** If you want to make logical volumes in your security group usable as secondary volumes for remote copy operations, click the security group in the Add/Change Security Group window and then click **Enable** under T-VOL/R-VOL. Next, click **Change** and then **OK**. Finally, click **Apply** in the SANtinel screen.

---

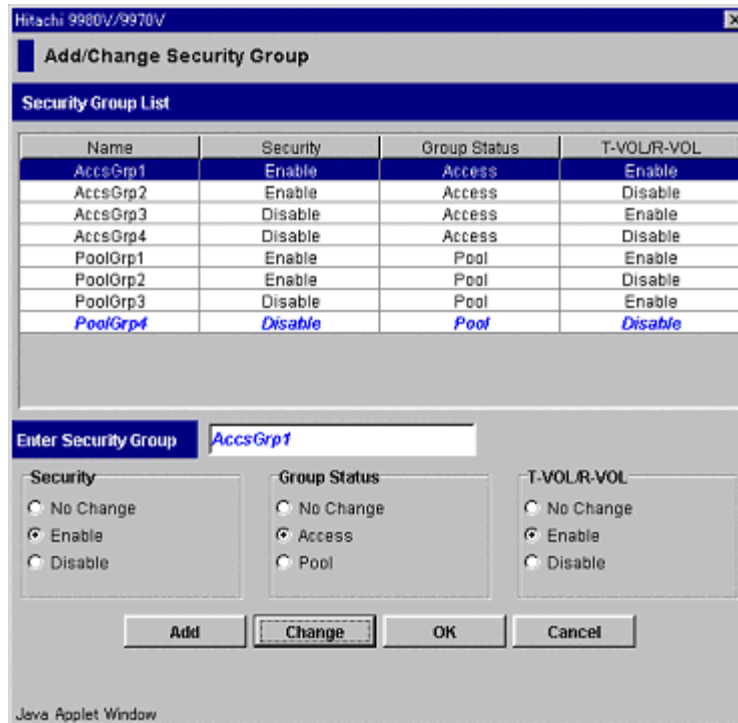
## Disabling Security

Complete the following procedure to disable security on logical volumes in the security group. If security is disabled, logical volumes in the security group are accessible from all hosts and are usable as secondary volumes for remote copy operations, regardless of whether the security group is an access or pool group.

If you are certain that you will not need to restore security, you can delete your security group to disable security. For details on how to delete security groups, refer to [Deleting Security Groups](#) on page 1214.

### To disable security on logical volumes:

1. From the SANtinel screen, right-click the security group in which the logical volumes are registered. A pop-up menu is displayed.
2. Click **Add/Change** from the pop-up menu. The Add/Change Security Group window is displayed.



**Figure 420: Add/Change Security Group window**

- In the Security Group List, click the security group you want to disable.
- Under Security, click **Disable**.
- Click **Change**. The change is reflected in the window.
- Click **OK**.
- From the SANtinel screen, click **Apply**. A confirmation dialog box is displayed.
- Click **Yes**. The settings are applied to the disk array.

**Note:** If you want to restore security, click the security group in the Add/Change Security Group window and then click **Enable** under Security. Next, click **Change** and then **OK**. Finally, click **Apply** in the SANtinel screen.

## Editing Security Settings

### Editing Security Groups

This section contains the following topics about editing security groups:

- Unregistering a host group from a security group (see page 1212)
- Unregistering an LDEV group from a security group (see page 1212)
- Renaming a security group (see page 1213)
- Deleting a security group (see page 1214)

You must operate Command View in Modify mode to perform SANtinel operations. Users in view mode can only view SANtinel information.

### Unregistering a Host Group from a Security Group

**To unregister a host group from a security group:**

1. From the SANtinel screen, double-click a security group containing the host group. The tree view displays the host group in the specified security group.
2. Right-click the host group and click **Delete** from the pop-up menu. A confirmation dialog box is displayed.
3. Click **Yes**.
4. Click **Apply**. A confirmation dialog box is displayed.
5. Click **Yes**. The settings are applied to the disk array.

### Unregistering an LDEV Group from a Security Group

**To unregister the LDEV group from a security group:**

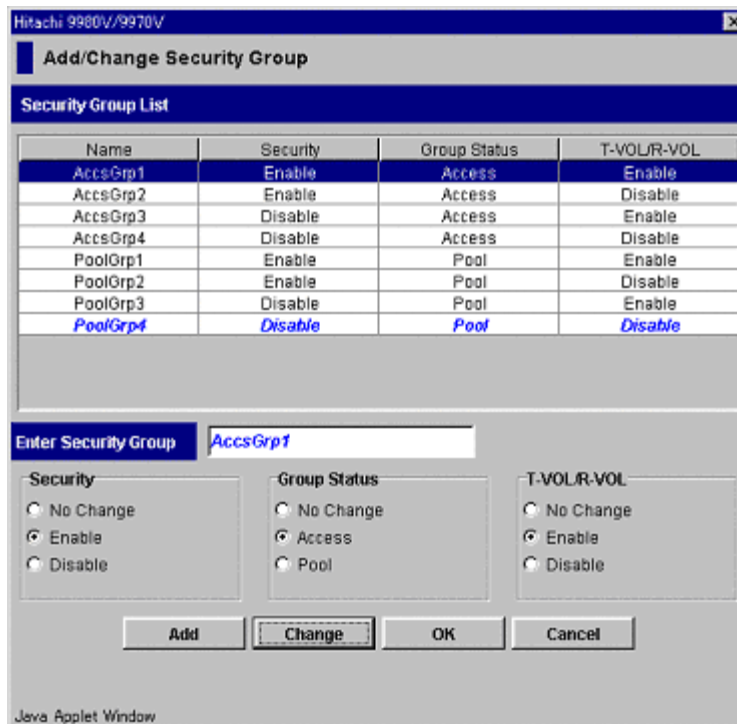
1. From the SANtinel screen, double-click a security group containing the LDEV group. The tree view displays the LDEV group in the specified security group.
2. Right-click the LDEV group and click **Delete** from the pop-up menu. A confirmation dialog box is displayed.
3. Click **Yes**.
4. Click **Apply**. A confirmation dialog box is displayed.
5. Click **Yes**. The settings are applied to the disk array.



## Renaming Security Groups

### To rename a security group:

1. From the SANtinel screen, right-click **Security Group** or a security group. A pop-up menu is displayed.
2. Click **Add/Change** from the pop-up menu. The Add/Change Security Group window is displayed.



**Figure 421: Add/Change Security Group window**

3. In the Security Group List, click the security group you want to rename.
4. In the **Enter Security Group** field, enter the new name for the security group.  
Security group names can be up to eight characters and are case-sensitive. The first character and the last character must not be a space. Also, the following characters are unusable in security group names: \ , / : ; \* ? " < > |
5. Click **Change**. The change is reflected in the window.

6. Click **OK**.
7. From the SANtinel screen, click **Apply**. A confirmation dialog box is displayed.
8. Click **Yes**. The settings are applied to the disk array.

## Deleting Security Groups

### To delete a security group:

1. From the SANtinel screen, right-click the security group you want to delete. A pop-up menu is displayed.
2. Click **Delete** from the pop-up menu. A confirmation dialog box is displayed.
3. Click **Yes**.
4. Click **Apply**. A confirmation dialog box is displayed.
5. Click **Yes**. The settings are applied to the disk array.

## Editing Host Groups

This section contains the following topics about editing host groups:

- Registering hosts (not attached to the disk array) into a host group (see page 1214)
- Deleting hosts from a host group (see page 1216)
- Deleting ports from a host group (see page 1218)
- Renaming a host group (see page 1219)
- Deleting a host group (see page 1220)

You must operate Command View in Modify mode to perform SANtinel operations. Users in view mode can only view SANtinel information.

## Registering Hosts to be Attached to the Disk Array

If your organization is planning to attach new mainframe hosts to the disk array, you will possibly need to revise the security settings on logical volumes. For example, if you do not want to allow the new hosts to access some logical volumes, you might need to register the new hosts in the host group in an existing access group. You can use SANtinel to register new hosts in host groups before the new hosts are attached to the disk array.

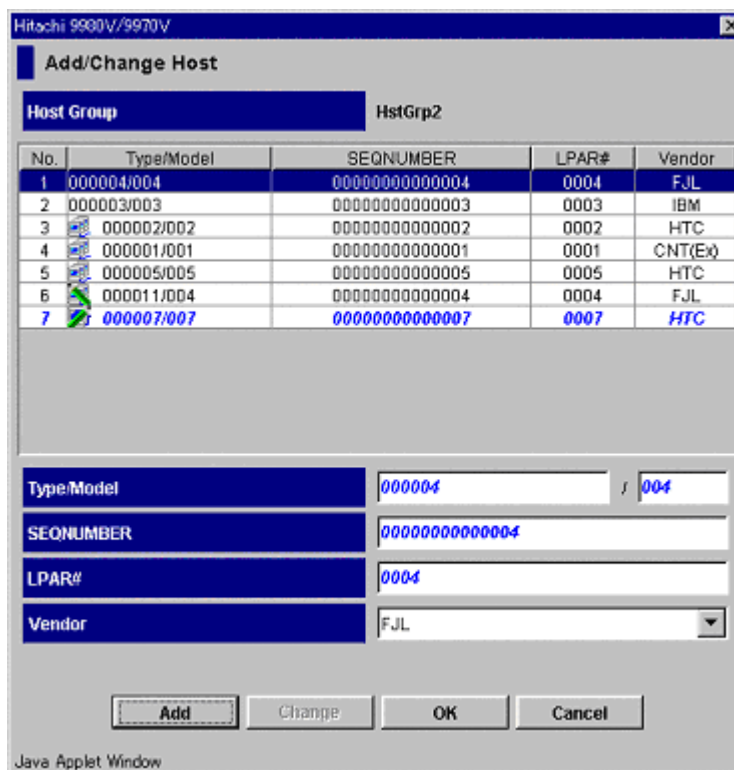
### To register a mainframe host to be attached into a host group:

1. Execute the following system command at the mainframe host:

```
D M=CPU
```


Typing this command displays the type, the model number, the node ID, and the logical partition number of the host. Write down the information to refer to it later.

1. From the SANtinel screen, right-click a host group in **Host Group**. A pop-up menu is displayed.
2. Click **Specify** and then **Host** from the pop-up menu. The Add/Change Host window displays a list of hosts.





**Figure 422: Add/Change Host window**

3. Use the text boxes and the drop-down list to specify the information provided in [step 1](#).

4. Click **Add**. The specified host is added to the table and is represented by the  icon.
5. Click **OK**.
6. From the SANtinel screen, click **Apply**. A confirmation dialog box is displayed.
7. Click **Yes**. The settings are applied to the disk array.

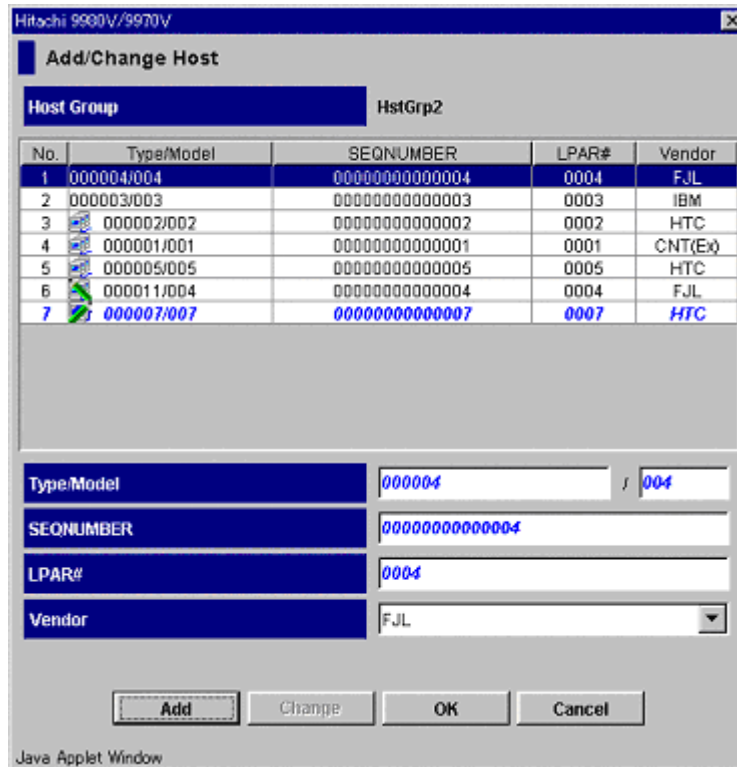
### Tips

- If you registered a host in an incorrect host group, first follow the previous procedure to register the host in the correct host group. Then, follow the procedure in [Deleting Hosts from Host Groups](#) on page 1216 to remove the host from the incorrect host group.
- To modify information about hosts with the  icon, use the Add/Change Host window. Click the host in the table and then use the text boxes and/or drop-down list to change the information. Next, click **Change** and then **OK**. Finally, click **Apply** in the SANtinel screen.
- To delete a host with the  icon from the Add/Change Host window, select and right-click the host, click **Delete** from the pop-up menu, and then click **OK**. Finally, click **Apply** in the SANtinel screen.







## Deleting Hosts from Host Groups

### To delete hosts from a host group:

1. From the SANtinel screen, right-click a host group. A pop-up menu is displayed.
2. Click **Specify** and then **Host** from the pop-up menu. The Add/Change Host window displays a list of hosts.



**Figure 423: Add/Change Host window**

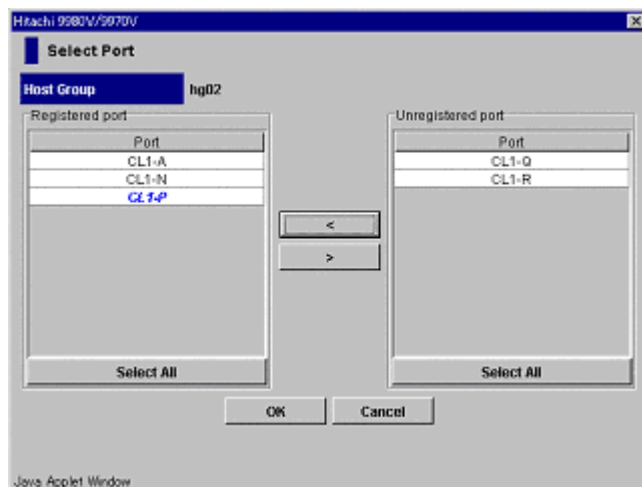
3. Select and then right-click one or more hosts (with the  or  icon) that you want to delete.
4. Click **Registration** and then **Unregister Host in Host Group** from the pop-up menu. The specified hosts are shown in blue. Also, the icons are no longer displayed or will change to the  or  icon. The  and  icons indicate that the host is registered in another host group.
5. Click **OK**.
6. From the SANtinel screen, click **Apply**. A confirmation dialog box is displayed.
7. Click **Yes**. The settings are applied to the disk array.

## Deleting Ports from Host Groups

To delete ports from host groups, you must have SANtinel Port Security Option installed.

### To delete ports from a host group:

1. From the SANtinel screen, right-click a host group. A pop-up menu is displayed.
2. Click **Specify** and then **Port** from the pop-up menu. The Select Port window is displayed.



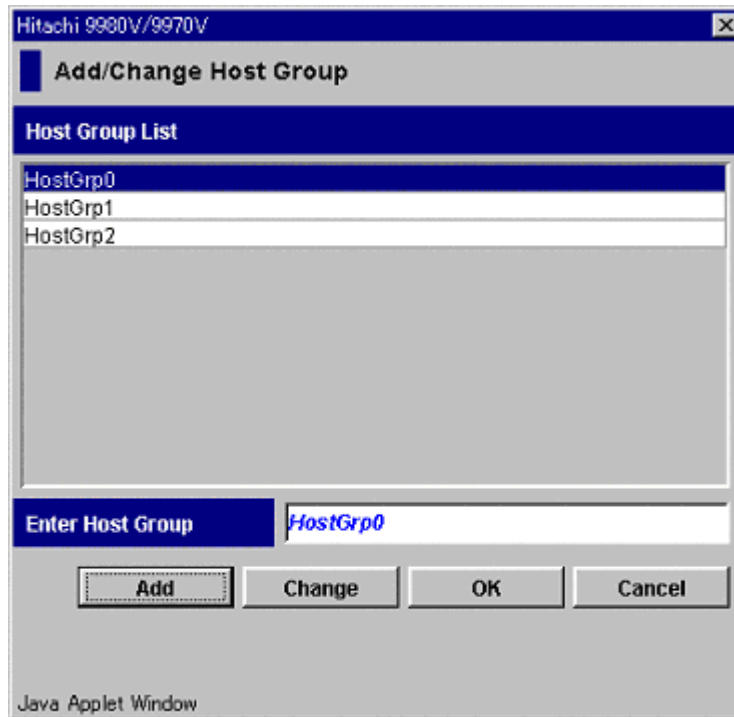
**Figure 424: Select Port window**

3. From the Registered port list, click the ports you want to delete and then click the > button to move them to the Unregistered port list. The specified ports should be shown in blue in the Unregistered port list. To select all the ports in the Registered port list, click **Select All**.
4. Click **OK**.
5. From the SANtinel screen, click **Apply**. A confirmation dialog box is displayed.
6. Click **Yes**. The settings are applied to the disk array.

## Renaming Host Groups

### To rename a host group:

1. From the SANtinel screen, right-click **Host Group** or a host group. A pop-up menu is displayed.
2. Click **Add/Change** from the pop-up menu. The Add/Change Host Group window is displayed.



**Figure 425: Add/Change Host Group window**

3. In the Host Group List, click the host group you want to rename.
4. In the **Enter Host Group** field, enter the new name for the host group.  
Host group names can be up to eight characters and are case-sensitive. The first character and the last character must not be a space. Also, the following characters are unusable in security group names: \ , / : ; \* ? " < > |
5. Click **Change**. The change is reflected in the window.
6. Click **OK**.

7. From the SANtinel screen, click **Apply**. A confirmation dialog box is displayed.
8. Click **Yes**. The settings are applied to the disk array.

## Deleting Host Groups

### To delete a host group:

1. From the SANtinel screen, right-click the host group you want to delete. A pop-up menu is displayed.
2. Click **Delete** from the pop-up menu. A confirmation dialog box is displayed.
3. Click **Yes**.
4. Click **Apply**. A confirmation dialog box is displayed.
5. Click **Yes**. The settings are applied to the disk array.

## Editing LDEV Groups

This section contains the following topics about editing LDEV groups:

- Deleting logical volumes from an LDEV group (see page 1220)
- Renaming an LDEV group (see page 1221)
- Deleting an LDEV group (see page 1223)

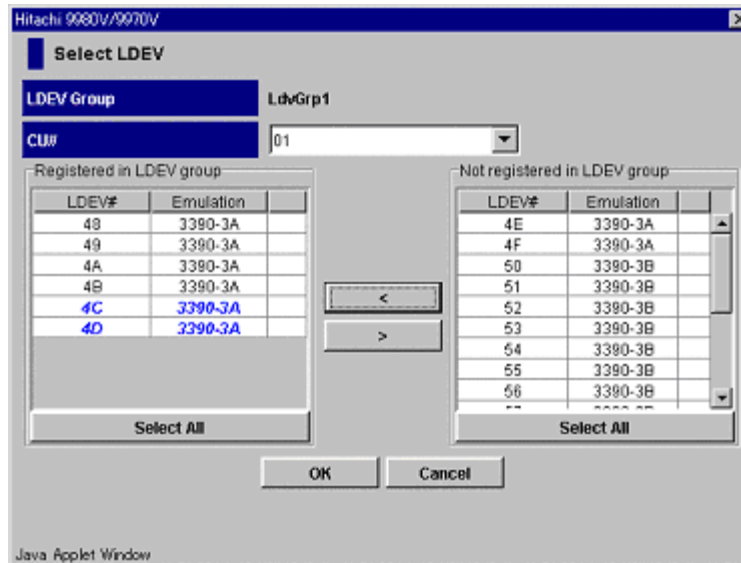
You must operate Command View in Modify mode to perform SANtinel operations. Users in view mode can only view SANtinel information.

## Deleting Logical Volumes from LDEV Groups

### To delete logical volumes from an LDEV group:

1. From the SANtinel screen, right-click an LDEV group. A pop-up menu is displayed.
2. Click **Specify** and then **LDEV** from the pop-up menu. The Select LDEV window is displayed.





**Figure 426: Select LDEV window**

3. In the CU# drop-down list, click a CU image. The tables located below the drop-down list display the logical volumes in the CU image you selected. The Registered in LDEV group table displays the logical volumes registered in the LDEV group. The Not registered in LDEV group table displays logical volumes that are not registered in the LDEV group.
4. In the Registered in LDEV group table, click the logical volumes that you want to delete. Then, click the > button to move the selected logical volumes to the Not registered in LDEV group table.
5. To delete logical volumes in other CU images, repeat the previous steps.
6. Click **OK**.
7. From the SANtinel screen, click **Apply**. A confirmation dialog box is displayed.
8. Click **Yes**. The settings are applied to the disk array.

## Renaming LDEV Groups

### To rename an LDEV group:

1. From the SANtinel screen, right-click **LDEV Group** or an LDEV group. A pop-up menu is displayed.

- Click **Add/Change** from the pop-up menu. The Add/Change LDEV Group window is displayed.



**Figure 427: Add/Change LDEV Group window**

- In the LDEV Group List, click the LDEV group you want to rename.
- In the **Enter LDEV Group** field, enter the new name for the LDEV group.  
LDEV group names can be up to eight characters and are case-sensitive. The first character and the last character must not be a space. Also, the following characters are unusable in security group names: \ , / : ; \* ? " < > |
- Click **Change**. The change is reflected in the window.
- Click **OK**.
- From the SANtinel screen, click **Apply**. A confirmation dialog box is displayed.
- Click **Yes**. The settings are applied to the disk array.

## Deleting LDEV Groups

### To delete an LDEV group:

1. From the SANtinel screen, right-click the LDEV group you want to delete. A pop-up menu is displayed.
2. Click **Delete** from the pop-up menu. A confirmation dialog box is displayed.
3. Click **Yes**.
4. Click **Apply**. A confirmation dialog box is displayed.
5. Click **Yes**. The settings are applied to the disk array.

## Viewing Security Settings

This section explains how to view security settings for the following:

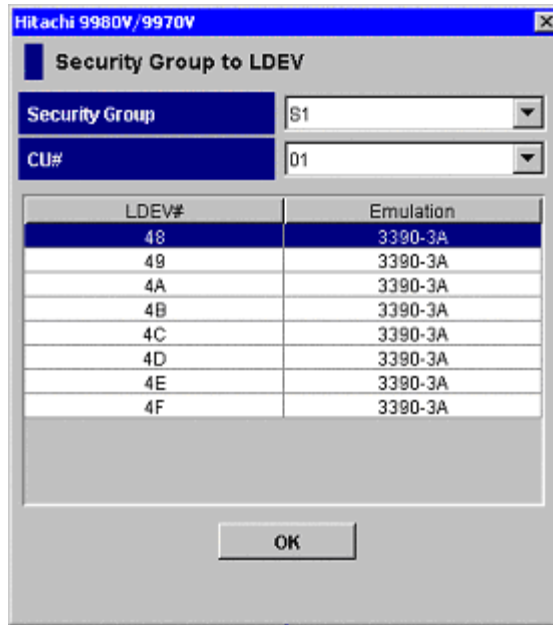
- Logical Volumes in a Specified Security Group (see page 1224)
- Security Groups that Contains a Specified Host (see page 1225)
- Ports through which Hosts Can Access Logical Volumes (see page 1227)
- Logical Volumes in the Security Group that Contains a Specified Host (see page 1228)
- Security Groups that Contain a Specified Logical Volume (see page 1229)
- Hosts in the Security Group that Contains a Specified Logical Volume (see page 1230)
- Security Groups that Contain a Specified Host Group (see page 1231)
- Security Groups that Contain a Specified LDEV Group (see page 1232)

## Finding Logical Volumes in a Specified Security Group

To search a security group for logical volumes, click the security group in the tree view of the SANTinel screen and then display the list of logical volumes in the lower-right table. Another method is described in the following procedure.

### To find logical volumes in a specified security group:

1. In the tree view of the SANTinel screen, right-click an item except for a host group or LDEV group that is displayed immediately below a security group.
2. From the pop-up menu, click **List -> Security Group to LDEV**. The Security Group to LDEV window is displayed.



**Figure 428: Security Group to LDEV window**

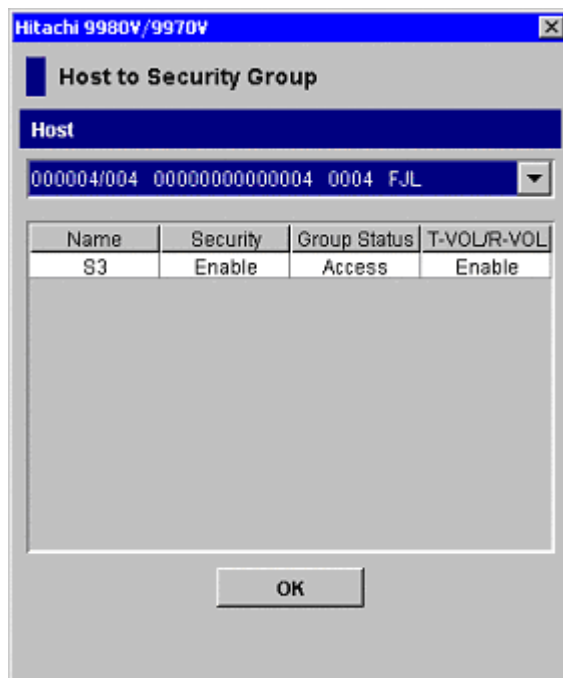
3. In the **Security Group** drop-down list, click a security group.
4. Display the CU image numbers by clicking the down arrow to open the **CU#** drop-down list.
  - If one CU image number is listed, the table in the window displays all the logical volumes in the specified security group.
  - If two or more CU image numbers are listed, the table in the window currently displays some of the logical volumes in the specified security group. Click each CU image number to find logical volumes in the specified CU image.

## Finding Security Groups that Contains a Specified Host

To specify a host and find the security groups in which the host is registered, complete one of the following procedures. Follow the first procedure if the host is displayed in the Hosts table (the upper-right table on the SANtinel screen). Follow the second procedure if the host is not displayed in the Hosts table.

**If the host is displayed in the Hosts table:**

1. Right-click the host in the table.
2. From the pop-up menu, click **List -> Host to Security Group**. The Host to Security Group window is displayed.



**Figure 429: Host to Security Group window**

**If the host is not displayed in the Hosts table:**

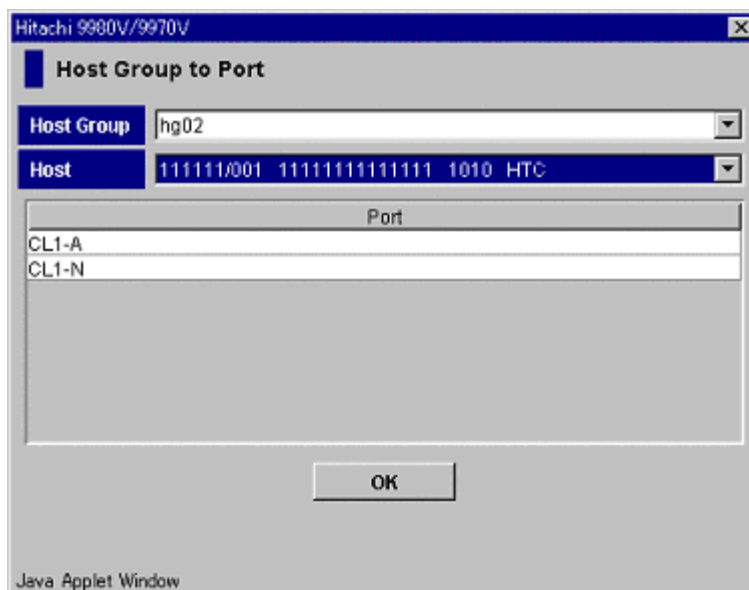
1. In the tree view of the SANtinel screen, right-click an item except for a host group or LDEV group that is displayed immediately below a security group.
2. From the pop-up menu, click **List -> Host to Security Group**. The Host to Security Group window is displayed.
3. In the **Host** drop-down list, click the host. The table lists the security groups that you want.

## Finding Ports Through which Hosts Can Access Logical Volumes

To find the ports through which a host can access logical volumes, you must have SANtinel Port Security Option installed.

**To find the ports through which a host can access logical volumes:**

1. In the tree view of the SANtinel screen, right-click an item and then click **List -> Host Group to Port** from the pop-up menu. The Host Group to Port window is displayed.



**Figure 430: Host Group to Port window**

2. In the **Host Group** drop-down list, click a host group.
3. In the **Host** drop-down list, click a host.
4. The Port list displays the ports through which the specified host can access logical volumes. Click **OK** to close the Host Group to Port window.

## Finding Logical Volumes in the Security Group that Contains a Specified Host

If a security group is classified as an access group, the security group contains both host and logical volumes. The following procedures explain how to specify a host and to find logical volumes in the security group in which the specified host is registered. Follow the first procedure if the host is displayed in the Hosts table (the upper-right table on the SANtinel screen). Follow the second procedure if the host is not displayed in the Hosts table.

### If the host is displayed in the Hosts table:

1. Right-click the host in the table.
2. From the pop-up menu, click **List -> Host to LDEV**. The Host to LDEV window displays a list of logical volumes.

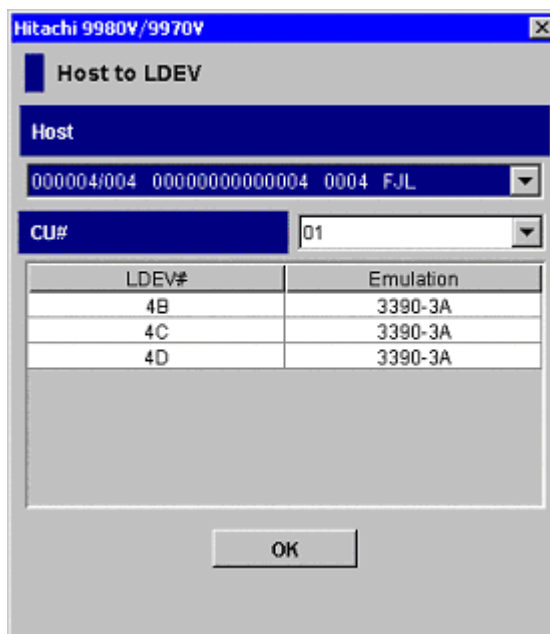


Figure 431: Host to LDEV window

3. Display the CU image numbers by clicking the down arrow to open the **CU#** drop-down list.



- If one CU image number is listed, the table in the window displays all the logical volumes that you want.
- If two or more CU image numbers are listed, the table in the window currently displays some of the logical volumes that you want. Click each CU image number to find logical volumes in the specified CU image.

**If the host is not displayed in the Hosts table:**

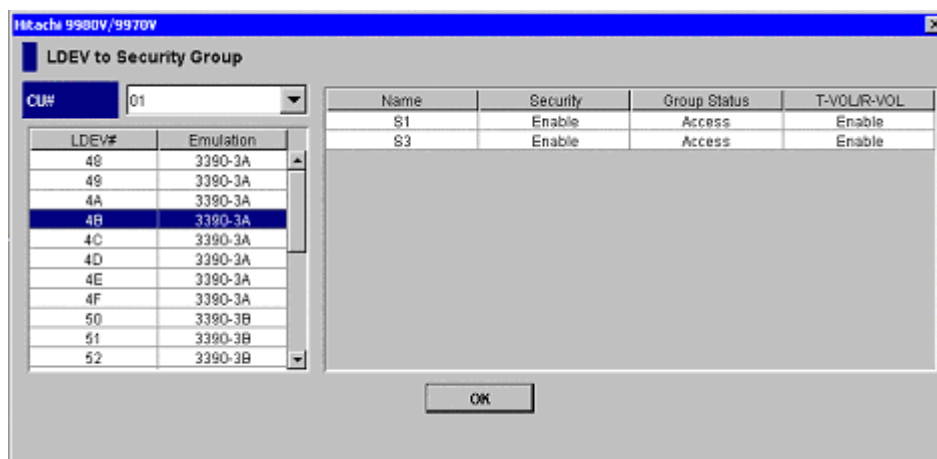
1. In the tree view of the SANtinel screen, right-click an item except for a host group or LDEV group that is displayed immediately below a security group.
2. From the pop-up menu, click **List -> Host to LDEV**. The Host to LDEV window is displayed.
3. In the **Host** drop-down list, click the host. The table lists the security groups that you want.
4. Display the CU image numbers by clicking the down arrow to open the **CU#** drop-down list.
  - If one CU image number is listed, the table in the window displays all the logical volumes that you want.
  - If two or more CU image numbers are listed, the table in the window currently displays some of the logical volumes that you want. Click each CU image number to find logical volumes in the specified CU image.

## Finding Security Groups that Contain a Specified Logical Volume

To specify a logical volume and find the security groups in which the logical volume is registered, complete one of the following procedures. Follow the first procedure if the logical volume is displayed in the LDEVs table (the lower-right table on the SANtinel screen). Follow the second procedure if the logical volume is not displayed in the LDEVs table.

**If the logical volume is displayed in the LDEVs table:**

1. Right-click the logical volume in the table.
2. From the pop-up menu, click **List -> LDEV to Security Group**. The LDEV to Security Group window is displayed. The table on the right displays a list of hosts.



**Figure 432: LDEV to Security Group window**

**If the logical volume is not displayed in the LDEVs table:**

1. In the tree view of the SANTinel screen, right-click an item except for a host group or LDEV group that is displayed immediately below a security group.
2. From the pop-up menu, click **List -> LDEV to Security Group**. The LDEV to Security Group window is displayed.
3. In the **CU#** drop-down list, click a CU image number. Then, click an LDEV number from the lower-left table. The table on the right lists the security groups that you want.

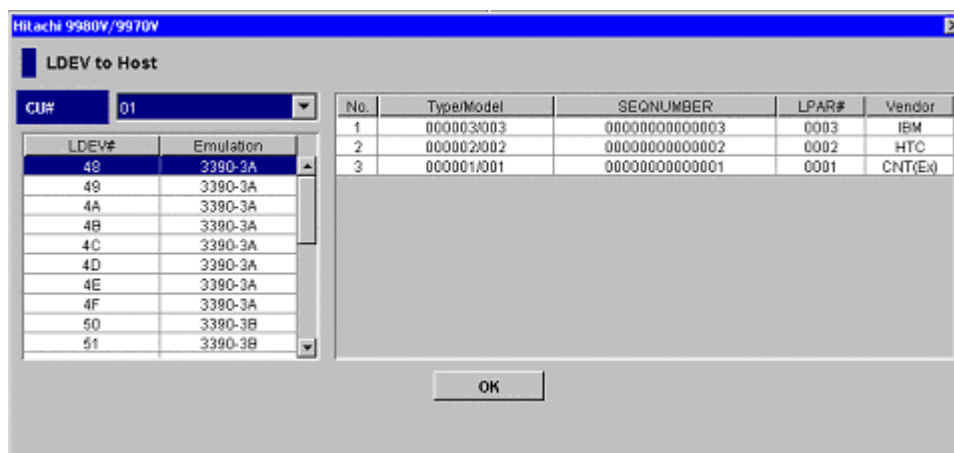
## Finding Hosts in the Security Group that Contains a Specified Logical Volume

If a security group is classified as an access group, the security group contains both host and logical volumes. The following procedures explain how to specify a logical volume and to find hosts in the security group in which the specified logical volume is registered. Follow the first procedure if the logical volume is displayed in the LDEVs table (the lower-right table on the SANTinel screen). Follow the second procedure if the logical volume is not displayed in the LDEVs table.

**If the logical volume is displayed in the LDEVs table:**

1. Right-click the logical volume in the table.

- From the pop-up menu, click **List -> LDEV to Host**. The LDEV to Host window is displayed. The table on the right displays a list of hosts.



**Figure 433: LDEV to Host window**

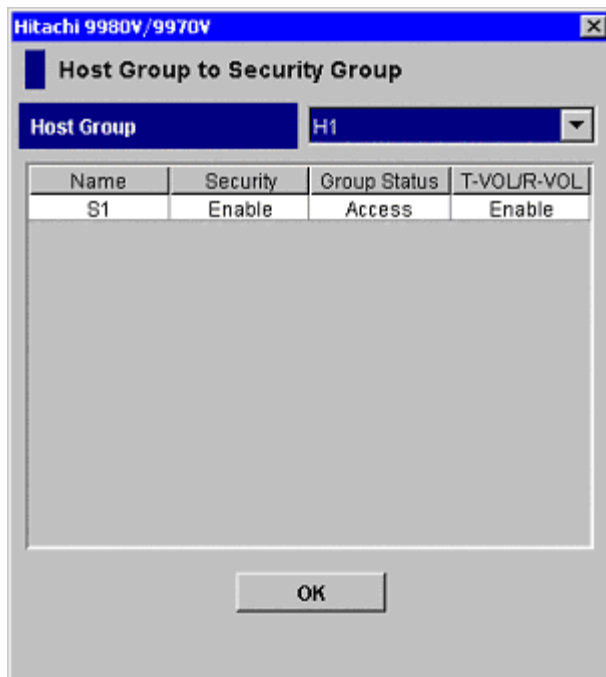
#### If the logical volume is not displayed in the LDEVs table:

- In the tree view of the SANTinel screen, right-click an item except for a host group or LDEV group that is displayed immediately below a security group.
- From the pop-up menu, click **List -> LDEV to Host**. The LDEV to Host window is displayed.
- In the **CU#** drop-down list, click a CU image number. Then, click an LDEV number in the lower-left table. The table on the right lists the security groups that you want.

## Finding Security Groups that Contain a Specified Host Group

#### To find security groups in which the specified host group is registered:

- In the tree view of the SANTinel screen, right-click an item except for a host group or LDEV group that is displayed immediately below a security group.
- From the pop-up menu, click **List -> Host Group to Security Group**. The Host Group to Security Group window is displayed.



**Figure 434: Host Group to Security Group window**

3. In the **Host Group** drop-down list, click the host group. The table lists the security groups that you want.

## Finding Security Groups that Contain a Specified LDEV Group

**To find security groups in which the specified LDEV group is registered:**

1. In the tree view of the SANtinel screen, right-click an item except for a host group or LDEV group that is displayed immediately below a security group.
2. From the pop-up menu, click **List -> LDEV Group to Security Group**. The LDEV Group to Security Group window is displayed.

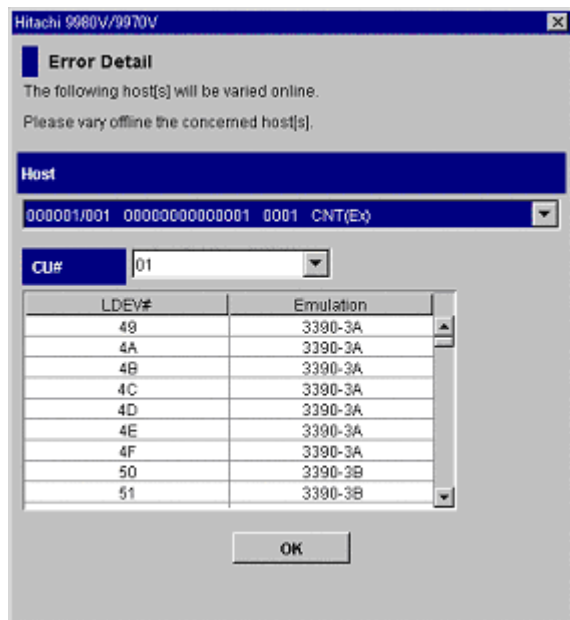


**Figure 435: LDEV Group to Security Group window**

3. In the **LDEV Group** drop-down list, click the LDEV Group. The table lists the security groups that you want.

## General SANtinel Troubleshooting

SANtinel may display the Error Detail window when you attempt to apply security settings and an error occurs.



**Figure 436: Error Detail window**

The probable causes of the error are:

- Some hosts in one security group are accessing logical volumes in another security group.
- Some hosts do not belong to any security group, but the hosts are accessing logical volumes in a security group.

To correct this error, find the hosts and the logical volumes that cause the error.

### To find the cause of the error:

1. In the Error Detail window, click the down arrow to open the **Host** drop-down list.
  - If the drop-down list displays one entry, only one host is causing the error.
  - If the drop-down list displays two or more entries, two or more hosts are causing the error.

2. In the **Host** drop-down list, click a host.
3. Display the CU image numbers by clicking the down arrow to open the **CU#** drop-down list.
  - If the drop-down list displays one entry, the table displays all the logical volumes that are causing the error.
  - If the drop-down list displays two or more entries, the table displays some of the error-causing logical volumes. To view other error-causing volumes, use the **CU#** drop-down list to specify another CU image.
4. If two or more hosts are causing the error, repeat [step 2](#) and [step 3](#).

If error-causing hosts and logical volumes are detected, do one of the following to remove the error:

- Vary the error-causing logical volume offline from the error-causing host. For detailed information about varying the volume offline, refer to the documentation for host commands.
- Find the security group that contains the error-causing hosts and the error-causing logical volumes. Then, disable the security settings of the security group (see [Disabling Security](#) on page 1210).





# LDEV Guard for the XP128/XP1024 (Mainframe)

26

LDEV Guard protects data in your disk array from I/O operations performed on mainframe hosts. You can use LDEV Guard to assign an access attribute to each logical volume. If you use LDEV Guard, you will be able to use a logical volume as a read-only volume as well as protect a logical volume against both read and write operations.

LDEV Guard supports the following volume emulation types:

**Table 179: Supported volume emulation types**

Supported Volume Emulation Types	Description
3390-3, 3390-3R, 3390-9, 3390-L	These logical volumes can be used only by mainframe hosts.
3390-3A, 3390-3B, 3390-3C	These logical volumes can be used by mainframe and open systems hosts. You must ensure that the access attribute of these logical volumes is Read/Write. For detailed information about access attributes, refer to <a href="#">Assigning Access Attributes to Logical Volumes</a> on page 1237. Access attributes only take effect when mainframe hosts access logical volumes. Access attributes does not take effect when open system hosts access logical volumes.

## Assigning Access Attributes to Logical Volumes

By default, all the mainframe volumes are subject to read and write operations by mainframe hosts. For this reason, data on mainframe volumes might be damaged or lost if a mainframe host performs erroneous write operations. Also, confidential data on mainframe volumes might be stolen if a malicious operator performs read operations on mainframe hosts.

However, if you use LDEV Guard, you can use logical volumes as read-only volumes to protect the volumes against write operations. You can also protect logical volumes against both read and write operations. LDEV Guard can restrict read operations and write operations on logical volumes, and prevent data from being damaged, lost, and stolen.

To restrict read and write operations, you must assign an access attribute to each logical volume. Use LDEV Guard to assign one of the following access attributes to each logical volume:

- **Read/Write:** If a logical volume has the Read/Write attribute, mainframe hosts can perform both read and write operations on the logical volume. All mainframe volumes have the Read/Write attribute by default.
- **Read Only:** If a logical volume has the Read Only attribute, mainframe hosts can perform read operations, but cannot perform write operations on the logical volume.
- **Protect:** If a logical volume has the Protect attribute, mainframe hosts cannot access the logical volume. Mainframe hosts cannot perform either read nor write operations on the logical volume.

To assign access attributes to logical volumes, start LDEV Guard and then edit a pattern in the LDEV Guard screen. A pattern is a table that lists access attributes of all logical volumes. The following figure is an example from a pattern. This example shows access attributes of the logical volumes 00, 01, and 02.

In the following figure, the access attribute of the logical volume 03 is displayed as Can't Guard, which indicates that you cannot assign any access attribute to the logical volume. You cannot use LDEV Guard to assign any access attribute to open system volumes and logical volumes (logical devices) that are not mapped to physical devices.

LDEV #	Attribute	Type	Capacity	VTOC (CC:HH)
00	Read/Write	3390-9	10,017 Cyl	-
01	Read Only	3390-9	10,017 Cyl	0:1 - 0:14 (14Trk)
02	Protect	3390-9	10,017 Cyl	-
03	Can't Guard	-	-	-

**Figure 437: Example of a pattern**

Use Command View when assigning access attributes. Also note the following:

- If a host computer attempts to write data to a read-only logical volume, the write operation fails and the host receives a Write Inhibit report that the host cannot write data because of the access attribute.

- If a host computer attempts to read data from or write data to a logical volume that has the Protect attribute, the attempted access is rejected and an intervention request is reported to the host. The intervention request indicates that the host cannot access the logical volume because of the access attribute.

## Using Pattern Files

After you finish editing a pattern in the LDEV Guard screen, you can save the pattern in a file. A pattern is a collection of access attributes of all logical volumes. If you create more than one pattern, you will be able to switch access attributes of logical volumes. You can create and save up to 32 pattern files. If you create two or more pattern files, you will be able to change access attributes of all logical volumes quickly and easily.



**Caution:** If a failure occurs in the SVP and then the SVP is replaced by a new one, your pattern files will be lost. To avoid losing your pattern files, make a backup copy by downloading your pattern files from the SVP to floppy disks, hard disks, or some other storage media. For more information about downloading pattern files, see [Downloading a Pattern File](#) on page 1251.

---

The following figure is an example of a computer system that uses two pattern files (Ptn\_1 and Ptn\_2). In Ptn\_1, the logical volume *ldev 1* has the *Read/Write* attribute, and the logical volume *Ldev2* has the *Protect* attribute. In Ptn\_2, *ldev 1* has the *Read Only* attribute, and *ldev2* has the *Read/Write* attribute. The system administrator applies Ptn\_1 to the disk array during the day, and applies Ptn\_2 at night. During the day, all the hosts can read and write to *ldev1*, but can neither read from nor write to *ldev2*. At night, all hosts can read data from *ldev1*, and can read from and write to *ldev2*.

For detailed instructions on how to create and use pattern files, see [Using LDEV Guard](#) on page 1247.

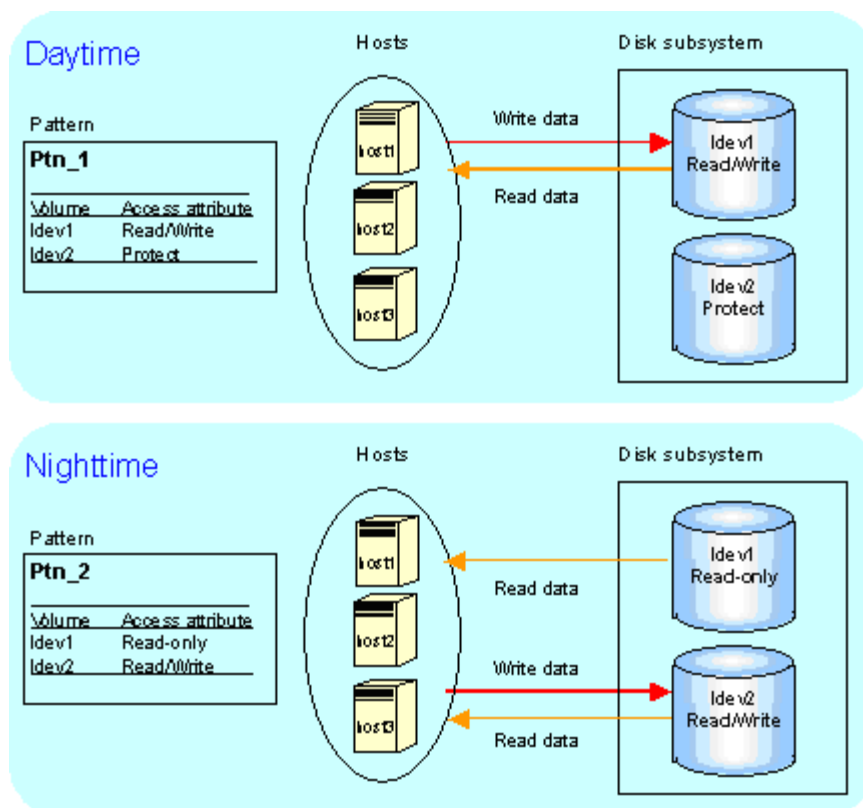


Figure 438: Example of using pattern files

## Using LDEV Guard with Other Products

Do not perform LDEV Guard operations if any other program product is running. Also, do not assign an access attribute to a logical volume if any job is manipulating data on the logical volume. If you assign an access attribute to such a logical volume, the job will possibly end abnormally.

- TrueCopy (Synchronous and Asynchronous):** Do not assign an access attribute to any logical volume that is being used by TrueCopy. If you assign an access attribute, the job will end abnormally.

If you want to create a TrueCopy pair and to use a read-only volume as the main volume (M-VOL), you are recommended to find the remote volume (R-VOL) from a disk array on which LDEV Guard is enabled. If you need to find the R-VOL from a disk array on which LDEV Guard is not enabled, you must do either of the following:

- Change the access attribute of the M-VOL to Read/Write
- Disable LDEV Guard on the main site

If you use TrueCopy to create a pair, the main volume (M-VOL) and the remote volume (R-VOL) will have the same access attribute. If you suspend or delete the pair, access attribute for these volumes will not change.

If a remote copy pair is suspended during a TrueCopy copy operation and you want to enable the R-VOL read option on the RCU (mode 20), you must ensure that the access attribute of the R-VOL is Read/Write before you enable the R-VOL read option.

If the access attribute of the R-VOL is Read-Only, mode 20 will be disabled. Also, operations such as REFORMAT and REFVTOC cannot be performed for overwriting volume serial numbers.

If a logical volume has the Protect attribute, the logical volume can neither be used as an M-VOL nor an R-VOL.

- **ShadowImage:** If a logical volume has the Protect attribute, the logical volume can neither be used as a source volume (S-VOL) nor a target volume (T-VOL).
- **Other products that can automatically start at a specified time:** If any program product that can start automatically is enabled, you must either perform LDEV Guard operations when the program is not running or cancel the setting of the program start time.

## Requirements for LDEV Guard

In addition to meeting the minimum Command View installation requirements, and installing Command View and the LDEV Guard license key, you need to install Java Web Start 1.2 before using LDEV Guard.

### Java Web Start

Configuration File Loader uses Java Web Start 1.2 to transfer (upload and download) a spreadsheet file to the disk array. Java Web Start is a utility that allows Command View XP to execute a program locally from your browser to upload and download configuration files directly to and from the disk array.


If you are using Windows, Java Web Start is automatically installed when you installed JRE 1.4.2. You should not need to install Java Web Start separately.

If you are using HP-UX, Java Web Start is **not** installed when you installed JRE/RTE 1.4.1.03 and must be installed separately. The Java Web Start file is located in the `jre` directory. To install Java Web Start 1.2, refer to the instructions in the release notes or go to [http://www.hp.com/products1/unix/java/java2/webstart/infolibrary/notes\\_webstart\\_1-2.html](http://www.hp.com/products1/unix/java/java2/webstart/infolibrary/notes_webstart_1-2.html).

## Starting LDEV Guard

To assign access attributes, you must use a user account that has the write permission, such the Administrator account, and you must be in Modify mode. If you use a user account that does not have the write permission or you are in View mode, you will be able to view access attributes, but you will be unable to assign access attributes.

### To start LDEV Guard:

1. From the Launch screen, click an XP128 or XP1024.
2. Click the **Mainframe** tab, click the **Mainframe Connection** button () , and then click the **LDEV Guard** tab. The LDEV Guard screen is displayed.

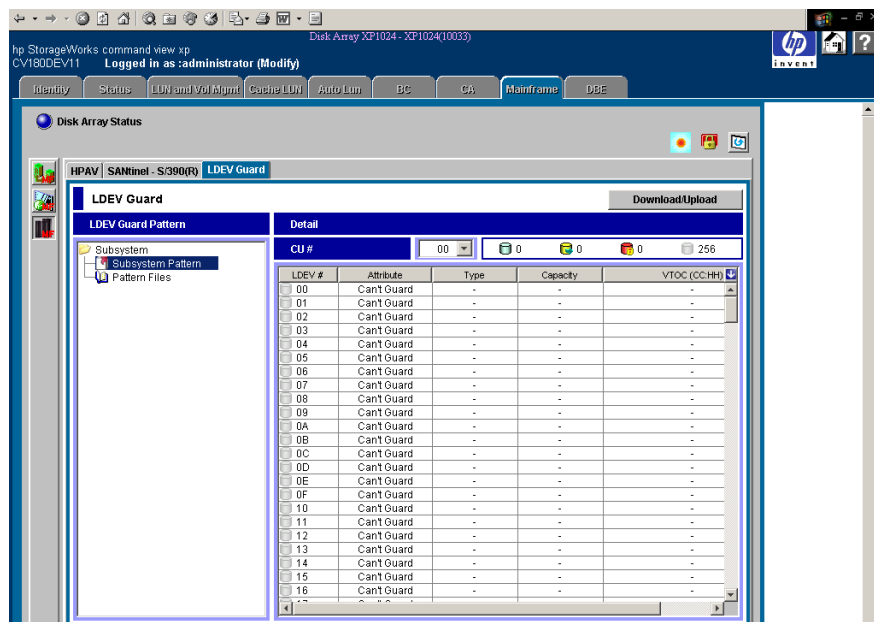


Figure 439: LDEV Guard screen

## LDEV Guard Screen

The LDEV Guard screen is displayed when you start LDEV Guard and is the starting point for all the LDEV Guard operations. The LDEV Guard screen displays the following items:

### LDEV Guard Pattern tree

This tree displays a list of patterns and contains the following folders:

- **Subsystem Pattern:** Contains the pattern that is currently applied to the disk array. Click this folder to display the pattern in the Detail table.
- **Pattern Files:** Contains a list of pattern files. Click a pattern file to display the file contents in the Detail table.

### Download/Upload button





Clicking this button displays the Download/Upload Pattern File window, which you can use to download and upload pattern files. This button is available if you are in Modify mode, except when editing pattern file(s). For instance, this button is not available when any item is displayed in blue and italics in the LDEV Guard Pattern tree or the Detail table.

### Detail table

Displays the contents of the pattern selected in the LDEV Guard Pattern tree.

- **CU# drop-down list:** Used to specify a CU image. If you specify a CU image, the Detail table displays logical volumes in the CU image. To the right of this drop-down list are four icons:

**Table 180: LDEV Guard icons**

Icon	Status
	Logical volumes that have the Read/Write attribute.
	Logical volumes that have the Read Only attribute.
	Logical volumes that have the Protect attribute.
	Open systems volumes and logical volumes (logical devices) that are not mapped to any physical storage devices. You cannot assign any access attribute to these volumes.

The Detail table lists logical volumes and the access attribute of each logical volume. The table contains the following columns:

- **LDEV#:** Displays logical volume numbers. The LDEV Guard icons shown in [Table 180](#) displays additional information about each volume.
- **Attribute:** Indicates the access attribute of each logical volume. If this column displays **Can't Guard**, you cannot assign any access attribute to the logical volume.



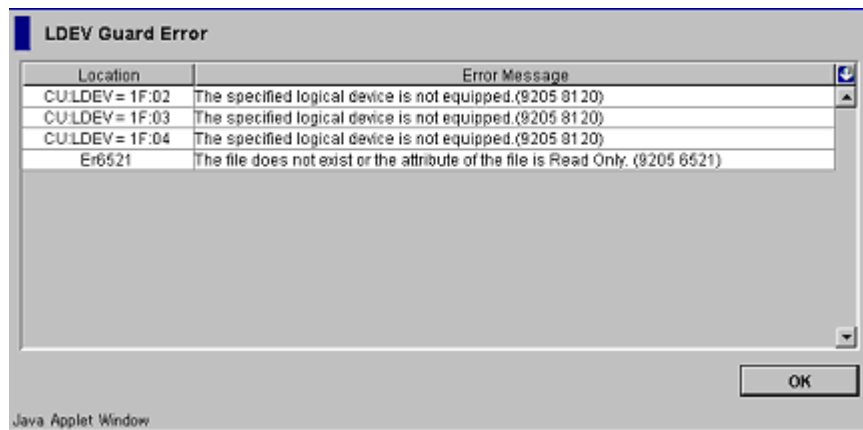
- **Type:** Displays volume emulation types.
- **Capacity:** Displays the capacity of each logical volume. The unit is cylinder (Cyl.).
- **VTOC (CC:HH):** Displays the range of the VTOC area. Also displays the number of tracks in the VTOC area. **CC** indicates the cylinder number. **HH** indicates the head number.

For example, if **0:1-0:14(14Trk)** is displayed, the starting point for the VTOC area is cylinder 0 and head 0. The ending point for the VTOC area is cylinder 0 and head 14. The number of tracks are 14.

- **↓ button:** Located in the upper-right corner of the table and selects all the logical volumes in the table.
- **Apply button:** Applies settings in the LDEV Guard screen to the disk array.
- **Cancel button:** Discards settings in the LDEV Guard screen.

## LDEV Guard Error Window

The LDEV Guard Error window is displayed when an error occurs in LDEV Guard operations, and displays error locations and messages.



**Figure 440: LDEV Guard Error window**

The LDEV Guard Error window displays the following items:

- **Location:** Indicates where the error occurred. If an error occurs with a logical volume, this column displays the CU number and the LDEV number. If an error occurs with a pattern file, this column displays the name of the pattern file.
- **Error Message:** Displays the error message.
- **OK button:** Closes the LDEV Guard Error window.



## Using LDEV Guard

LDEV Guard topics include the following:

- Changing access attributes of logical volumes (see page 1247)
- Creating a pattern file (see page 1248)
- Editing a pattern file (see page 1249)
- Applying a pattern file to the disk array (see page 1249)
- Renaming a pattern file (see page 1250)
- Deleting a pattern file (see page 1250)
- Downloading a pattern file (see page 1251)
- Uploading a pattern file (see page 1252)
- Specifying the VTOC size (see page 1253)

## Changing Access Attributes of Logical Volumes

**To change access attributes of logical volumes:**

1. From the LDEV Guard screen, click **Subsystem Pattern** in the LDEV Guard Pattern tree. The current pattern (the current access attributes of logical volumes) is displayed in the table.
2. Confirm that the  icon is displayed next to the selected pattern. If the icon is not next to the selected pattern, right-click **Subsystem Pattern**. A pop-up menu is displayed.
3. Click **Use as Subsystem Pattern** from the pop-up menu.
4. In the **CU#** drop-down list, click a CU image. The table displays a list of logical volumes in the specified CU image. Access attributes are displayed on the right of logical volume names.
5. Select and right-click a logical volume whose access attribute you want to change. If you want to assign the same access attribute to all logical volumes in the table, click the  button in the upper-right corner of the table and then right-click. A pop-up menu is displayed.
6. From the pop-up menu, click **Attribute** and then click the access attribute you want to assign. The logical volume is displayed in italics and in blue when the access attribute changes. The volume icon also changes when the access attribute changes. If you want to change access attribute of other logical volumes, repeat this step.

7. If you want to change access attributes of logical volumes in other CU images, repeat [step 4 - step 6](#).
8. Click **Apply**. A confirmation dialog box is displayed.
9. Click **OK**. The settings are applied to the disk array.

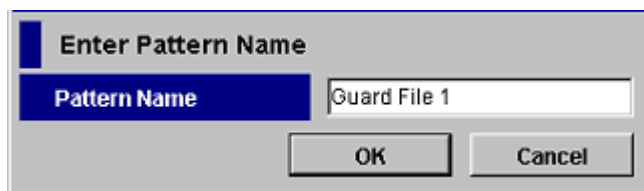
## Creating a Pattern File

When creating a pattern file for the first time, copy the pattern that is currently applied to the disk array, and then save the copy as a new pattern file. If you already have pattern files, you can create a pattern file by copying an existing pattern file or by copying the pattern that is currently applied to the disk array.

When you create pattern files, the pattern files will be saved. You can also download pattern files you have created. For more information about downloading pattern files, see [Downloading a Pattern File](#) on page 1251.



### To create a pattern file:

1. From the LDEV Guard screen, do one of the following:
  - To copy the pattern that is currently applied to the disk array, right-click **Subsystem Pattern** from the LDEV Guard Pattern tree and then click **Copy** from the pop-up menu.
  - To copy an existing pattern file, right-click a pattern file from the Pattern Files folder of the LDEV Guard Pattern tree and then click **Copy** from the pop-up menu.



**Figure 441: Enter Pattern Name window**

2. In the Enter Pattern Name window, enter the name of the new pattern file. The following conventions apply to names of pattern files:
  - Up to 16 characters can be used.
  - The first character and the last character must not be a space.
  - The following characters cannot be used: \ . , / : ; \* ? “ < > |

3. Click **OK**. The name of the new pattern file is displayed in the LDEV Guard Pattern tree. The pattern file name is displayed in blue and preceded by the  icon.
4. Click **Apply**. A confirmation dialog box is displayed.
5. Click **OK**. The new pattern file is saved. The pattern file turns black and the pattern file icon also changes to the  icon.

## Editing a Pattern File


### To edit a pattern file:

1. From the LDEV Guard screen, click a pattern file from the LDEV Guard Pattern tree. The table displays the contents of the pattern file.
2. In the **CU#** drop-down list, click a CU image. The table displays a list of logical volumes in the specified CU image. Access attributes are displayed on the right of logical volume names.
3. Select and right-click a logical volume whose access attribute you want to change. A pop-up menu is displayed.
4. From the pop-up menu, click **Attribute** and then click the access attribute. The logical volume is displayed in blue when the access attribute changes. If you want to change access attribute of other logical volumes, repeat this step.
5. If you want to change access attributes of logical volumes in other CU images, repeat [step 2 - step 4](#).
6. Click **Apply**. A confirmation dialog box is displayed.
7. Click **OK**. The changes are saved in the pattern file.

## Applying a Pattern File to the Disk Array

If you follow the procedure below to apply a pattern file to the disk array, the access attributes of all logical volumes will change as defined in the pattern file.

### To apply a pattern file to change access attributes of all logical volumes:

1. From the LDEV Guard screen, right-click a pattern file from the Pattern Files folder of the LDEV Guard Pattern tree and then click **Use as Subsystem Pattern** from the pop-up menu. The pattern file is displayed in italics and in blue. The pattern file icon also changes to the  icon.
2. Click **Apply**. A confirmation dialog box is displayed.



3. Click **OK**. The pattern file is applied to the disk array. Access attributes of logical volumes change as defined in the pattern file. To confirm that the access attributes have been changed, right-click **Subsystem Pattern** in the LDEV Guard Pattern tree and then view the table.

## Renaming a Pattern File

The following conventions apply to names of pattern files:


- Up to 16 characters can be used.
- The first character and the last character must not be a space.
- The following characters cannot be used: \ . , / : ; \* ? “ < > |

### To rename a pattern file:

1. From the LDEV Guard screen, right-click a pattern file in the LDEV Guard Pattern tree and then click **Rename** from the pop-up menu. The Enter Pattern Name window is displayed.
2. Enter the new name for the pattern file and then click **OK**. The pattern file is renamed in the LDEV Guard Pattern tree and displayed in italics and in blue. The pattern file icon also changes to the  icon.
3. Click **Apply**. A confirmation dialog box is displayed.
4. Click **OK**. The change to the pattern file name is applied. The pattern file turns black and the pattern file icon also changes to the  icon.

## Deleting a Pattern File

### To delete a pattern file:

1. From the LDEV Guard screen, right-click a pattern file in the LDEV Guard Pattern tree and then click **Delete** from the pop-up menu. The pattern file name is displayed in italics and in blue. The pattern file icon also changes to the  icon.
2. Click **Apply**. A confirmation dialog box is displayed.
3. Click **OK**. The pattern file is deleted.

## Downloading a Pattern File

All of the pattern files you have created with LDEV Guard are saved. If a failure occurs in the SVP and then the SVP is replaced by a new one, your pattern files will be lost. To avoid losing your pattern files, make a backup copy by downloading your pattern files to floppy disks, hard disks, or some other storage media. To make a backup copy, download the pattern files you have created.

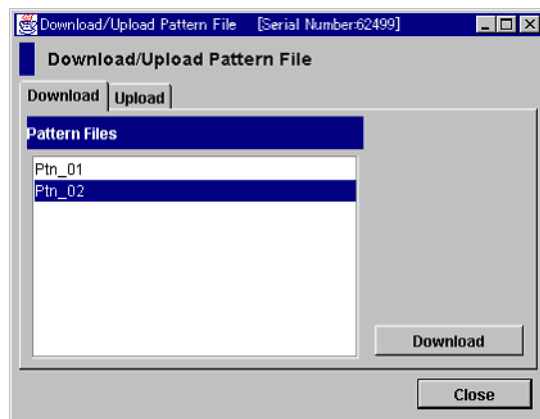
### To download a pattern file:

1. From the LDEV Guard screen, click **Download/Upload**. The Download/Upload Pattern File window is displayed.

---

**Note:** If the **Download/Upload** button is not available and you have installed Java Web Start 1.2, verify that you are not in the process of making changes to the pattern files. If a pattern file name is displayed in italics and in blue, the file is either new or has been changed. You must first click **Apply** to save any changes or **Cancel** to discard any changes before downloading a pattern file.

---



**Figure 442: Download/Upload Pattern File window (Download tab)**

2. Click the pattern file you want to download and then click **Download**. The Choose Pattern File dialog box is displayed.
3. Navigate to the directory in which to save the pattern file, and then enter the file name in the **File name** field.

4. Click **Save** to start downloading the pattern file. When the download has completed, a confirmation dialog box is displayed.
5. Click **OK** and then click **Close** to close the Download/Upload Pattern File window.

## Uploading a Pattern File

If a failure occurs in the SVP and then the SVP is replaced by a new one, you need to upload the backup copy of your pattern files.

Uploading a pattern file does not apply access attributes defined in the pattern file. If you want to apply the uploaded pattern file to change the access attributes of your disk array, see [Applying a Pattern File to the Disk Array](#) on page 1249.

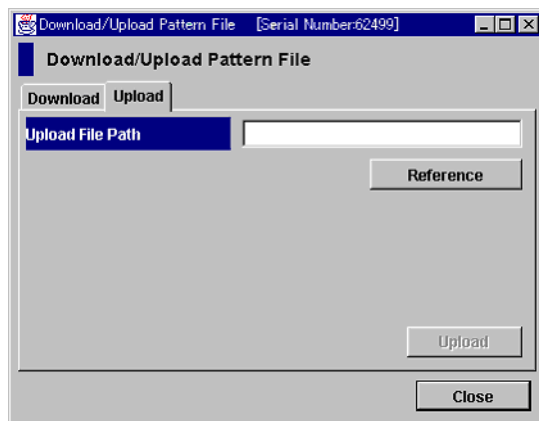
### To upload a pattern file:

1. From the LDEV Guard screen, click **Download/Upload**. The Download/Upload Pattern File window is displayed.

---

**Note:** If the **Download/Upload** button is not available and you have installed Java Web Start 1.2, verify that you are not in the process of making changes to the pattern files. If a pattern file name is displayed in italics and in blue, the file is either new or has been changed. You must first click **Apply** to save any changes or **Cancel** to discard any changes before uploading a pattern file.

---



**Figure 443: Download/Upload Pattern File window (Upload tab)**



2. Click the **Upload** tab and then click **Reference**. The Choose Pattern File dialog box is displayed.
3. Navigate to the directory containing the pattern file, and then click the pattern file.
4. Click **Open**. The specified directory is displayed in the **Upload File Path** field and the **Upload** button becomes available.
5. Click **Upload** to start uploading the pattern file. When the upload has completed, a confirmation dialog box is displayed.
6. Click **OK** and then click **Close** to close the Download/Upload Pattern File dialog box.

## Specifying the VTOC Size

When a host accesses a logical volume, the VTOC (volume table of contents) in the logical volume is updated to include updated access logs. If Read Only attribute is assigned to a logical volume, you can resize the VTOC in the logical volume by following the procedure below:

### To specify the size of the VTOC in a logical volume:

1. From the LDEV Guard screen, click **Subsystem Pattern** from the LDEV Guard Pattern tree.
2. Select one or more read-only logical volumes from the table and right-click. A pop-menu is displayed.

---

**Note:** You cannot resize the VTOC if the selected logical volume is not read-only. Also, to select two or more logical volumes, you must select logical volumes that have the same capacity.

---

3. Click **VTOC** from the pop-up menu. The VTOC Area window is displayed.

VTOC Area

Start (CC:HH) 0 : 1

End (CC:HH) 0 : 14 [ Max 10017 : 14 ]

OK Cancel

Java Applet Window

**Figure 444: VTOC Area window**

4. Use the **End (CC:HH)** fields to specify the ending position of the VTOC. Enter the cylinder number in the first field and the head number in the second field.

---

**Note:** The starting position of the VTOC cannot be changed and is always 0:1, which indicates the cylinder number 0 and the head number 1.

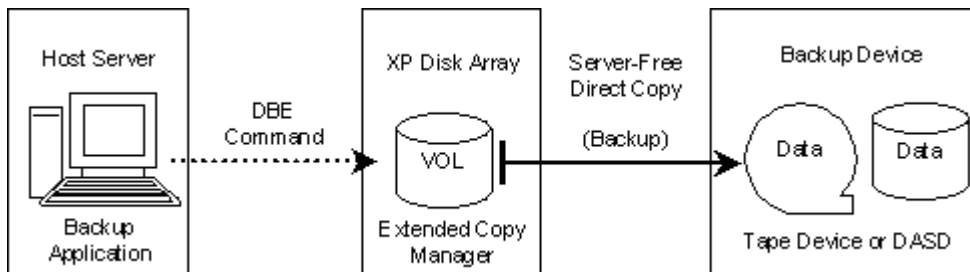
---

5. Click **OK**.
6. Click **Apply**. A confirmation dialog box is displayed.
7. Click **OK**. The change is applied to the disk array.

# Direct Backup Engine (DBE) for the XP128/XP1024

27

Direct Backup Engine (DBE) provides server-free backup between an XP disk array and the backup devices connected to a host server. Server-free backup is non-disruptive backup, with data going directly from disk to tape (or disk to disk) in a storage area network (SAN) environment. DBE is optional software. To use DBE, you need to purchase and install a license key for HP StorageWorks Direct Backup Engine XP. The current version of DBE supports VERITAS NetBackup 4.5, and this application currently supports only tape devices.



**Figure 445: DBE overview**

You can execute DBE commands from a host server that has NetBackup installed. When a *host group* on a *target port* on the disk array receives DBE commands from the host, specified data will be copied to a tape drive or library device connected to an *initiator port* on the disk array.

The host remains online during the movement of data from device to device. The host's CPU and I/O resources are always available to other operations and applications.

## Host Server Requirements

**Operating System:** HP-UX 11.00 (or later), Sun Solaris 8 (or later).

**Backup Application:** VERITAS NetBackup 4.5 (including ServerFree Agent) or later.

## Supported Backup Devices

DBE supports the following backup devices:

- HP Tape Library 2/20 (DLT8000 and LTO Ultrium-1)
- HP Tape Library 4/40 (DLT8000 and LTO Ultrium-1)
- HP Tape Library 6/60 (DLT8000 and LTO Ultrium-1)
- StorageTek L180 Tape Library (LTO Ultrium-1)
- StorageTek L700 Tape Library (LTO Ultrium-1, T9940B)

## Disk Array Requirements

DBE supports all physical disk drive options and RAID level configurations of the disk array. The disk array must contain at least one port group, consisting of a target port for receiving DBE commands from the host server and an initiator port for copying the data to the backup device.

Any of the installed Fibre Channel interface ports (packages) on the disk array can be set as target ports.

Initiator ports are the dedicated Fibre Channel interface ports on the disk array that are connected to the backup devices. Fibre Channel interface ports (packages) supported by Continuous Access can be set as initiator ports.

## Starting DBE

### To access DBE:

1. From the Launch screen, click an XP128 or XP1024.
2. Click the **DBE** tab. The DBE screen is displayed.

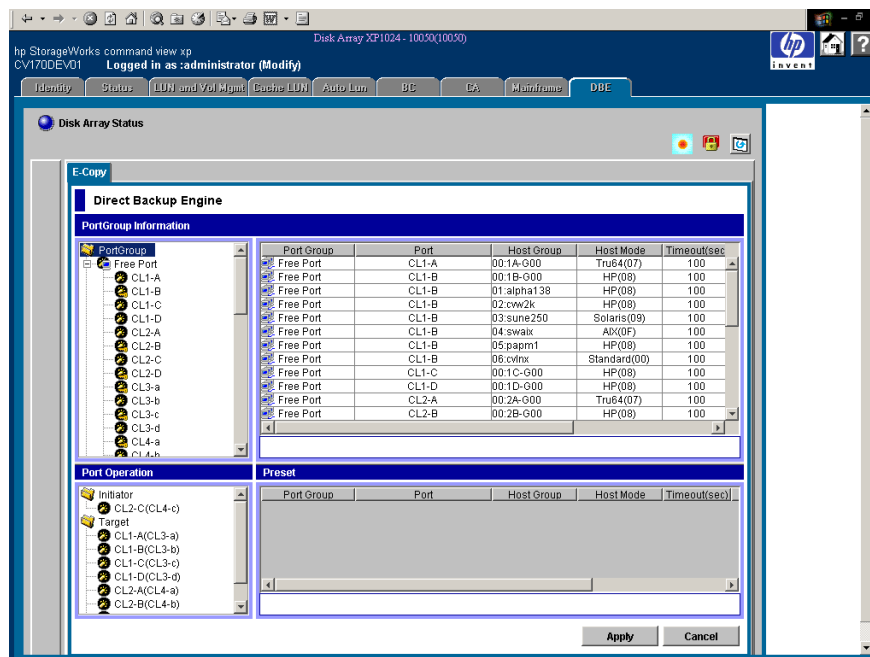


Figure 446: DBE screen

## DBE Screen

### Port Group Information box

The Port Group Information box is located in the upper part of the DBE screen and contains the Port Group tree on the left and the Port Group table on the right.

### Port Group tree









The tree contains the following folders:

- **Free Port:** Lists all free ports that do not belong to any port group.

- **Port Group (1 - 32):** Lists the ports that belong to the selected port group (1 - 32).

The following are the Fibre Channel port icons used in the Port Group tree:

**Table 181: Fibre Channel port icons for DBE operations**

Icon	Status
	A short-wave port in standard mode without LUN security.
	A short-wave port in standard mode with LUN security.
	A long-wave port in standard mode without LUN security.
	A long-wave port in standard mode with LUN security.
	A short-wave port in high-speed or high-speed (2 port) mode without LUN security.
	A short-wave port in high-speed or high-speed (2 port) mode with LUN security.
	A long-wave port in high-speed or high-speed (2 port) mode without LUN security.
	A long-wave port in high-speed or high-speed (2 port) mode with LUN security.

**Note:** High-speed (2 port) mode is available only if the XP disk array has firmware version 21.06.22 or later installed.

You can select only one port group at a time. If you want to display information of all ports, you must select the Port Group folder, which is at the top of the Port Group tree.

#### ***Port Group Information table***

This table displays the ports that belong to the port group selected in the Port Group Information tree. You can select more than one port at a time in the Port Group Information table, which has the following columns and labels:

- **Port Group:** The name of the port group (Free Port or 1 - 32).
- **Port:** The name of the port (CL1-A, CL2-B, etc.) that belongs to the selected port group.

- **Host Group:** The name of the host group that is used to classify host servers connected to the disk array.
- **Host Mode:** The host mode that is set by LUN Manager.
- **Timeout (sec):** The timeout period (35 - 290 seconds) set for the host group. The default timeout period is 100 seconds. For instructions on setting a timeout period, refer to [Setting a Timeout Period](#) on page 1269.
- **Type:** The port type (Initiator, Target, or RCU Target).
- **Port Speed:** The PCB mode (Standard or High Speed).
- **N Row(s) [Initiator X/32 Target, RCU Target Y/64]:** Provides the following information:
  - **N:** the total number of rows in the table
  - **X:** the number of initiator ports assigned in the port group
  - **Y:** the number of host groups on the target ports assigned in the port group

### Port Operation tree

The Port Operation tree is located in the left lower area of the DBE screen and displays the folders (Initiator, Target, RCU Target, and External) that have free ports (ports that do not belong to any port group) in a tree. When a free port is set in a port group, that port is removed from the Port Operation tree at the same time. The tree in the Port Operation tree contains the following folders:

- **Initiator:** Ports set as initiator ports. Initiator ports are the dedicated fibre-channel interface ports on the disk array that are connected to the backup devices.
- **Target:** Ports set as ordinary target ports. Target ports are the dedicated fibre-channel interface ports on the disk array that are connected to the host server(s).
- **RCU Target:** Ports set as RCU target ports. RCU target ports are used by CA, but if you want to use an RCU target port for DBE, change it to either an ordinary target port or initiator port. You cannot change a target port or initiator port to an RCU target port.
- **External:** Ports set as external ports. If you want to use an external port for DBE, change it to either an ordinary target port or initiator port. You cannot change a target port or initiator port to an external port.

### Preset table

The Preset table is located in the right lower area of the DBE screen and displays the specified or changed settings (port information). The changes of settings (port group and timeout period, or port type) are indicated by the before and after statuses separated by a bracket (>). For example, if the Port Group is **Free Port > 3**, then the free port is assigned to the port group 3.

The table does not display changes in blue. The Preset table can hold multiple settings of the same operation (such as operations in the Port Group Information box, or operations in the Port Operation tree) only. For example, when you set a port group or a timeout period, and the setting is displayed in the Preset table, you cannot change port types. To perform a different operation, you must apply the existing setting to disk array by clicking **Apply**.

The Preset table contains the following columns and labels:

- **Port Group:** The name of the port group (Free Port or 1 - 32).
- **Port:** The name of the port (CL1-A, CL2-B, etc.) that belongs to the selected port group.
- **Host Group:** The name of the host group that is set by LUN Manager.
- **Host Mode:** The host mode that is set by LUN Manager.
- **Timeout (sec):** The timeout period set for the host group.
- **Type:** The port type (Initiator, Target, RCU Target, or External).
- **Error Code:** The error code if some error occurs when you apply by clicking **Apply**.
- **N Row(s) [Change Port Group X Change Timeout Y] (Port Group Change):** Provides the following information:
  - **N:** the total number of rows in the table
  - **X:** the number of changed port groups
  - **Y:** the number of changed timeout periods
- **N Row(s) [Change Port] (Port Type Change):** The number of ports that you change the port type (N: the number of rows = the number of ports).



**Buttons**

- **Apply button:** Applies the settings to the disk array. Clicking **Apply** displays the I/O Check Confirmation window, which verifies whether or not to perform an I/O check before changing the selected port(s). If all the settings are applied successfully, the Preset table will be cleared. Any failed settings will remain in the Preset table.
- **Cancel button:** Cancels all the settings in the Preset table.

## Using DBE

You must register one or more port groups, and may have to change port types before you can use DBE.

DBE topics include the following:

- Viewing detailed port information (see page 1262)
- Adding ports to port groups (see page 1264)
- Moving ports from port groups (see page 1267)
- Setting a timeout period (see page 1269)
- Changing target ports, RCU target ports, or external ports to initiator ports (see page 1271)
- Changing initiator ports, RCU target ports, or external ports to target ports (see page 1272)

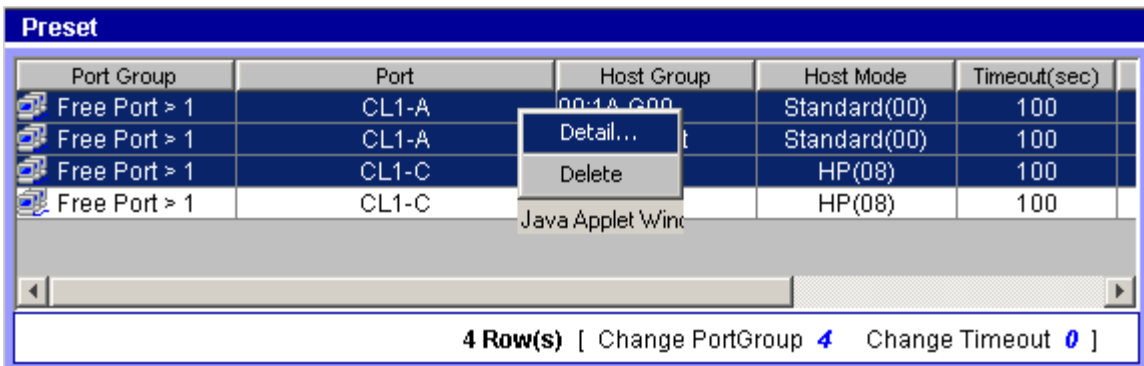
You must operate Command View in Modify mode to perform DBE operations. Users in view mode can only view DBE information.

## Viewing Detailed Port Information

The **Detail** command displays detailed information about the selected port(s). If an error occurs, an error message is also displayed on the Detail window.

**To view detailed port information:**

1. From the DBE screen, select one or more ports from the Preset table and right-click. A pop-up menu is displayed.

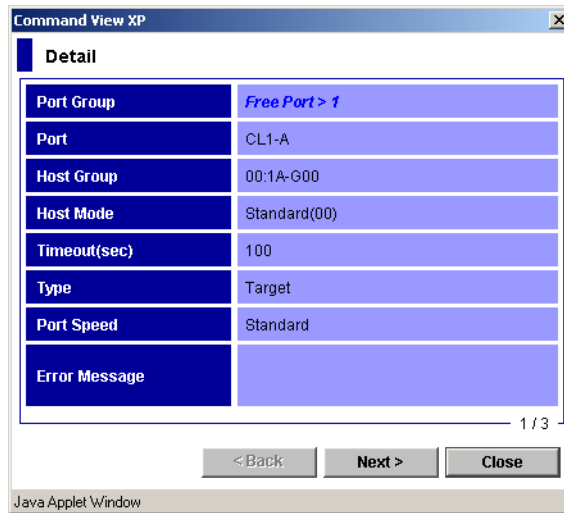


The screenshot shows a table titled "Preset" with the following columns: Port Group, Port, Host Group, Host Mode, and Timeout(sec). The table contains four rows of data. A context menu is open over the second row, showing options "Detail..." and "Delete".

Port Group	Port	Host Group	Host Mode	Timeout(sec)
Free Port > 1	CL1-A	00-1A-600	Standard(00)	100
Free Port > 1	CL1-A		Standard(00)	100
Free Port > 1	CL1-C		HP(08)	100
Free Port > 1	CL1-C		HP(08)	100

4 Row(s) [ Change PortGroup 4 Change Timeout 0 ]

- Click **Detail** from the pop-up menu. The Detail window displays information about the port(s) selected in the Preset table.



**Figure 447: Detail window**

- If two or more ports are selected, click **Next** to view the next port or click **Previous** to view the previous port.
- When you are done viewing the port information, click **Close**.

The Detail window contains the following information:

- **Port Group:** The port group name including *Free Port*. If you have made any change regarding the port group, that change is displayed. For example, *Free Port > 3* means that a free port is assigned to the port group 3.
- **Port:** The port name (CL1-A, CL2-B, etc.).
- **Host Group:** The name of the host group set by LUN Management.
- **Host Mode:** The host mode set by LUN Management.
- **Timeout (sec):** The timeout period. If you have changed the timeout period, that change is displayed. For example, *100 > 120* means that the timeout period is changed from 100 to 120.
- **Type:** The port type (Initiator, Target, RCU Target, or External). If you have changed the port type, that change is displayed. For example, *RCU Target > Initiator* means that an RCU target port has been changed to an initiator port.
- **Port Speed:** The PCB mode (Standard or High Speed).

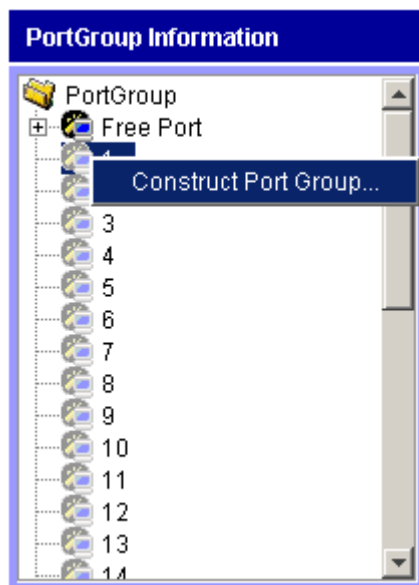
- **Error Message:** An error message displayed in red italic.

## Adding Ports to Port Groups

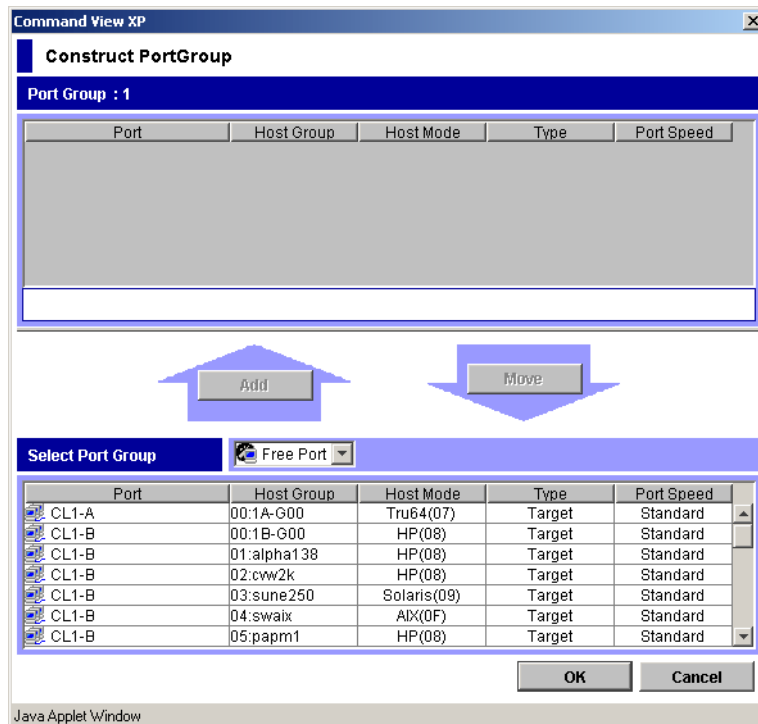
Before adding ports, make sure that no DBE I/Os are being executed from the host server to the affected ports. If you continue adding ports that execute DBE commands without performing an I/O check, then you will not be able to perform operations on those ports for about five minutes.

### To add one or more ports to a port group:

1. From the DBE screen, select a port group (1 - 32) from the Port Group tree and right-click. A pop-up menu is displayed.



2. Click **Construct Port Group** from the pop-up menu. The Construct Port Group window is displayed.



**Figure 448: Construct Port Group window (adding ports)**

The ports already assigned to the port group selected in [step 1](#) are displayed in the Port Group box in the Construct Port Group window.

3. In the **Select Port Group** drop-down list in the Construct Port Group window, click **Free Port** or a port group that has ports you want to add. You cannot click the same port group as the one selected in [step 1](#).
4. In the Port table in the lower part of the Construct Port Group window, click the target ports or RCU target ports and initiator ports. You can select more than one port at a time. A port group must contain at least one initiator port and at least one target port (either an RCU target port or an ordinary target port)
5. Click **Add**. The selected ports are added to the port group, and displayed in the Port Group box.
6. Click **OK**. The Construct Port Group window closes, and the port information of the changed port group is displayed in the Preset table and in the Port Group Information table (in blue).

The screenshot displays two panels from the DBE interface:

- PortGroup Information:** A tree view on the left shows a 'Free Port' group with 14 sub-items. The main table on the right contains one row:
 

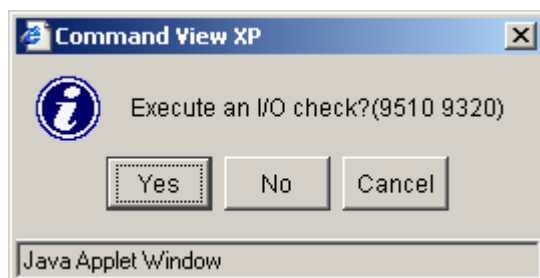
Port Group	Port	Host Group	Host Mode	Timeout(sec)
Free Port > 1	CL1-A	00:1A-G00	Tru64(07)	100

 The status bar at the bottom indicates '1 Row(s) [ Initiator 0 / 32 Target, RCU Target 1 / 64 ]'.
- Port Operation:** A tree view on the left shows 'Initiator' (CL2-C(CL4-c)) and 'Target' (CL1-A(CL3-a), CL1-B(CL3-b), CL1-C(CL3-c), CL1-D(CL3-d), CL2-A(CL4-a), CL2-B(CL4-b)). The main table on the right contains one row:
 

Port Group	Port	Host Group	Host Mode	Timeout(sec)
Free Port > 1	CL1-A	00:1A-G00	Tru64(07)	100

 The status bar at the bottom indicates '1 Row(s) [ Change PortGroup 1 Change Timeout 0 ]'.

7. From the DBE screen, click **Apply**. The I/O Check dialog box is displayed.



8. Click **Yes** to perform an I/O check before the ports are added. Click **No** to forcibly add the ports without performing an I/O check before the ports are added. A confirmation dialog box is displayed.
9. Click **OK** to confirm. When the operation has been completed, a confirmation dialog box is displayed.
10. Click **OK**. When the selected ports are added to the port group, the port information is cleared from the Preset table. Verify that the ports are added correctly and displayed in the DBE screen.

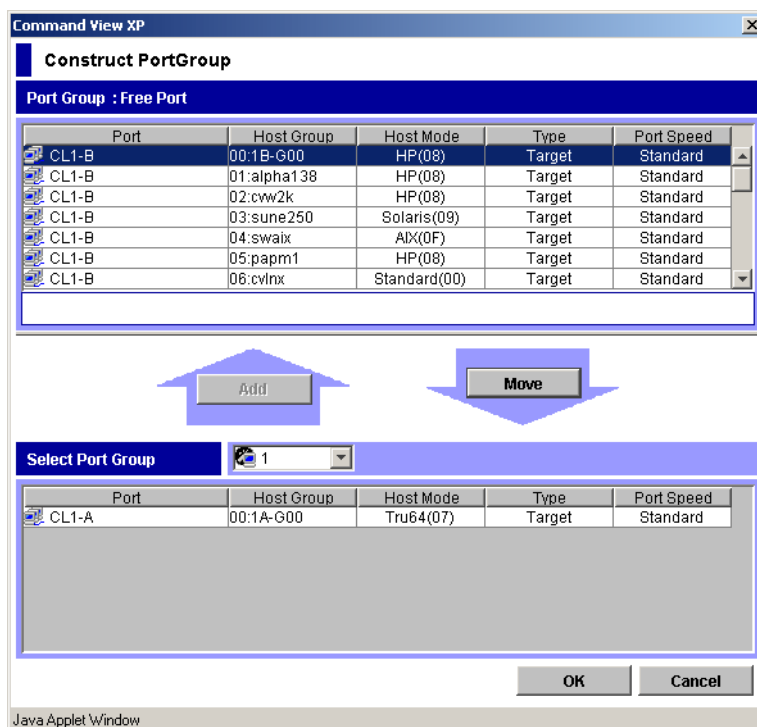
## Moving Ports from Port Groups

Before moving ports, make sure that no DBE I/Os are being executed from the host server to the affected ports. If you continue adding ports that execute DBE commands without performing an I/O check, then you will not be able to perform operations on those ports for about five minutes.

### To move ports from a port group:

1. From the DBE screen, select Free Port or a port group (1 - 32) from the Port Group tree and right-click. A pop-up menu is displayed.
2. Click **Construct Port Group** from the pop-up menu. The Construct Port Group window is displayed.

Available free ports or the ports already assigned to the port group selected in [step 1](#) are displayed in the Port Group box in the Construct Port Group window.
3. In the **Select Port Group** drop-down list on the Construct Port Group window, click **Free Port** or a port group to which you want to move the ports in the Port Group box. You cannot click the same port group as the one selected in [step 1](#).
4. In the Port Group box, click the ports that you want to move to the port group in the Port table. You can select two or more ports at a time.



**Figure 449: Construct Port Group window (moving ports)**

5. Click **Move**. The selected ports move from the Port Group box to the Port table.
6. Click **OK**. The Construct Port Group window closes, and the port information of the changed port group is displayed in the Preset table and in the Port Group Information table (in blue).
7. From the DBE screen, click **Apply**. The I/O Check dialog box is displayed.
8. Click **Yes** to perform an I/O check before the ports are moved. Click **No** to forcibly move the ports without performing an I/O check before the ports are moved. A confirmation dialog box is displayed.
9. Click **OK** to confirm. When the operation has been completed, a confirmation dialog box is displayed.
10. Click **OK**. When the selected ports are moved, the port information is cleared from the Preset table. Verify that the ports are moved correctly and displayed in the DBE screen.



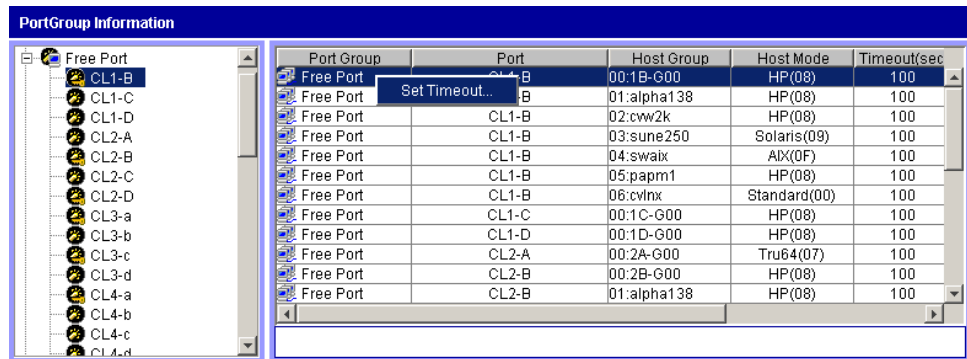
## Setting a Timeout Period

Before setting timeout periods, make sure that no DBE I/Os are being executed from the host server to the affected ports. If you continue adding ports that execute DBE commands without performing an I/O check, then you will not be able to perform operations on those ports for about five minutes.

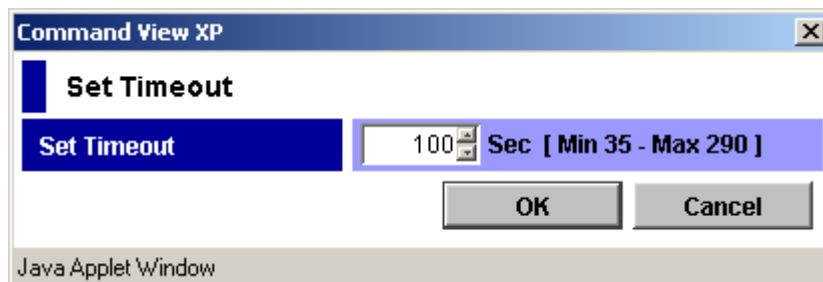
**To set a timeout period for a host group that has ports used by DBE operations:**

1. From the DBE screen, select a port group (1 - 32) from the Port Group tree. The port information of the selected port group is displayed in the Port Group table.
2. Select a port of the host group for which you want to set a timeout period and right-click.

You can select multiple ports at one time, but a timeout period is set by the host group. Therefore, if you select two ports that have different host groups, and set a timeout period, the same timeout period is set for both host groups. A pop-up menu is displayed.



3. Click **Set Timeout** from the pop-up menu. The Set Timeout window is displayed.



**Figure 450: Set Timeout window**

4. In the **Set Timeout** field, enter a timeout period (35 to 290 sec). You can directly enter a value in the field or use the scroll bar to change the value in units of one second. The default timeout period is 100 seconds.
5. Click **OK**. The Set Timeout window closes and the setting is displayed in the Preset table and in the Port Group Information table (in blue).

**PortGroup Information**

Port Group	Port	Host Group	Host Mode	Timeout(sec)
<b>Free Port</b>	<b>CL1-B</b>	<b>00:1B-G00</b>	<b>HP(08)</b>	<b>100 &gt; 90</b>
Free Port	CL1-B	01:alpha138	HP(08)	100
Free Port	CL1-B	02:cw2k	HP(08)	100
Free Port	CL1-B	03:sune250	Solaris(09)	100
Free Port	CL1-B	04:swaix	AIX(0F)	100
Free Port	CL1-B	05:papm1	HP(08)	100
Free Port	CL1-B	06:cvlx	Standard(00)	100
Free Port	CL1-C	00:1C-G00	HP(08)	100
Free Port	CL1-D	00:1D-G00	HP(08)	100
Free Port	CL2-A	00:2A-G00	Tru64(07)	100
Free Port	CL2-B	00:2B-G00	HP(08)	100
Free Port	CL2-B	01:alpha138	HP(08)	100

**Port Operation**

**Initiator**

- CL2-C(CL4-c)

**Target**

- CL1-B(CL3-b)
- CL1-C(CL3-c)
- CL1-D(CL3-d)
- CL2-A(CL4-a)
- CL2-B(CL4-b)
- CL2-D(CL4-d)

**Preset**

Port Group	Port	Host Group	Host Mode	Timeout(sec)
Free Port	CL1-B	00:1B-G00	HP(08)	100 > 90

1 Row(s) [ Change PortGroup 0 Change Timeout 1 ]

6. From the DBE screen, click **Apply**. The I/O Check dialog box is displayed.
7. Click **Yes** to perform an I/O check before the timeout period is set. Click **No** to forcibly set the timeout period without performing an I/O check before the timeout period is set. A confirmation dialog box is displayed.

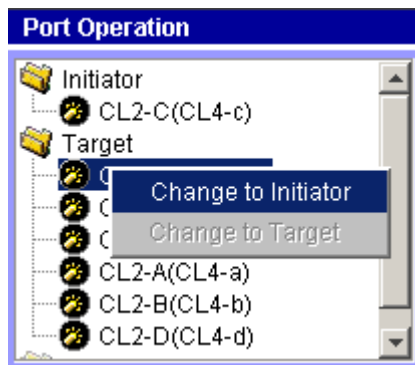
8. Click **OK** to confirm. When the operation has been completed, a confirmation dialog box is displayed.
9. Click **OK**. When the timeout period has been set, the port information is cleared from the Preset table. Verify the timeout period is set correctly and displayed in the DBE screen.

## Changing Target Ports, RCU Target Ports, or External Ports to Initiator Ports

Before changing a port to an initiator port, make sure that no DBE I/Os are being executed from the host server to the affected ports. You can change the port type of free ports only.

**To change one or more ordinary target ports, RCU target ports, or external ports to an initiator port:**

1. From the DBE screen, select the Target, RCU Target, or External folder in the Port Operation tree to display the free ports.
2. Select the free port that you want to change to an initiator port and right-click. A pop-up menu is displayed.



3. Click **Change to Initiator** from the pop-up menu. The selected port moves from Target, RCU Target, or External to Initiator, and is shown in blue. The changed port is also displayed in the Preset table.

The screenshot displays the DBE interface with two main sections: PortGroup Information and Port Operation.

**PortGroup Information:** A tree view on the left shows a 'Free Port' group with 15 sub-items. The main table lists the following data:

Port Group	Port	Host Group	Host Mode	Timeout(sec)
Free Port	CL 1-B	00:1B-G00	HP(08)	90
Free Port	CL 1-B	01:alpha138	HP(08)	100
Free Port	CL 1-B	02:cvw2k	HP(08)	100
Free Port	CL 1-B	03:sune250	Solaris(09)	100
Free Port	CL 1-B	04:swak	AIX(0F)	100
Free Port	CL 1-B	05:papm1	HP(08)	100
Free Port	CL 1-B	06:cvtxc	Standard(00)	100
Free Port	CL1-C	00:1C-G00	HP(08)	100
Free Port	CL1-D	00:1D-G00	HP(08)	100
Free Port	CL2-A	00:2A-G00	Tru64(07)	100
Free Port	CL2-B	00:2B-G00	HP(08)	100
Free Port	CL2-B	01:alpha138	HP(08)	100

**Port Operation:** A tree view on the left shows an 'Initiator' folder containing 'CL 1-B(CL3-b)' and 'CL2-C(CL4-c)', and a 'Target' folder containing 'CL1-C(CL3-c)', 'CL1-D(CL3-d)', 'CL2-A(CL4-a)', 'CL2-B(CL4-b)', and 'CL2-D(CL4-d)'. The main table shows the following data:

Port Group	Port	Host Group	Host Mode	Timeout(sec)
Free Port	CL1-B(CL3-b)	-	-	-

The bottom of the Port Operation section shows '1 Row(s) [ Change Port ]'.

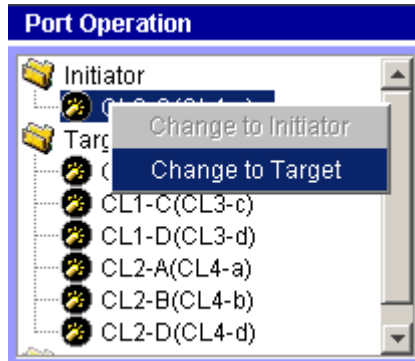
4. From the DBE screen, click **Apply**. When the port type is changed successfully, it is cleared from the Preset table and displayed in the Port Operation tree.
5. Verify that the changed port is correctly displayed in the DBE screen.

## Changing Initiator Ports, RCU Target Ports, or External Ports to Target Ports

Before changing a port to a target port, make sure that no DBE I/Os are being executed from the host server to the affected ports. You can change the port type of free ports only.

### To change an initiator port, RCU target port, or external port to a target port:

1. From the DBE screen, select the Initiator, RCU Target, or External folder in the Port Operation tree to display the free ports.
2. Select the free port (initiator or RCU target) that you want to change to a target port and right-click. A pop-up menu is displayed.



3. Click **Change to Target** from the pop-up menu. The selected port moves from Initiator, RCU Target, or External to Target, and is shown in blue. The changed port is also displayed in the Preset table.

**PortGroup Information**

Port Group	Port	Host Group	Host Mode	Timeout(sec)
Free Port	CL2-B	02:sune250	Solaris(09)	100
Free Port	CL2-B	03:alpha136	HP(08)	100
Free Port	CL2-B	04:cw2k	HP(08)	100
<b>Free Port</b>	<b>CL2-C</b>	-	-	-
Free Port	CL2-D	00:2D-G00	HP(08)	100
Free Port	CL3-a	00:SunClust	Solaris(09)	100
Free Port	CL3-a	01:VCS	Solaris(09)	100
Free Port	CL3-b	00:3b-G00	Standard(00)	100
Free Port	CL3-c	00:3c-G00	Standard(00)	100
Free Port	CL3-c	01:alpha138	HP(08)	100
Free Port	CL3-d	00:3d-G00	HP(08)	100
Free Port	CL4-a	00:SunClust	Solaris(09)	100

**Port Operation**

Initiator	Target
CL1-B(CL3-b)	
CL1-C(CL3-c)	
CL1-D(CL3-d)	
CL2-A(CL4-a)	
CL2-B(CL4-b)	
<b>CL2-C(CL4-c)</b>	
CL2-D(CL4-d)	

**Preset**

Port Group	Port	Host Group	Host Mode	Timeout(sec)
Free Port	CL2-C(CL4-c)	-	-	-

1 Row(s) [ Change Port ]

4. From the DBE screen, click **Apply**. When the port type is changed successfully, it is cleared from the Preset table and displayed in the Port Operation table.
5. Verify that the changed port is correctly displayed in the DBE screen.



# Troubleshooting



This chapter contains Command View troubleshooting information for open systems. For TrueCopy, ShadowImage, and SANtinel on mainframe systems, refer to [General TrueCopy Troubleshooting](#) on page 925, [General ShadowImage Troubleshooting](#) on page 1132, and [General SANtinel Troubleshooting](#) on page 1234, respectively. You will find recommended solutions to the following topics:

- [The Browser Displays “Data Retrieval in Progress” Message for a Long Time](#) (page 1276)
- [The Device Health Screen Displays Red or Yellow Disk Array Components](#) (page 1276)
- [The Session Administration Screen Reports the Incorrect Host Address](#) (page 1276)
- [The Disk Array License Key Installation Fails](#) (page 1277)
- [The Identity and Status Screens Contain Outdated Information](#) (page 1278)
- [Problems Occur When Removing LUSE Volumes from Volume Management](#) (page 1278)
- [The Refresh Fails with an SNMP Timeout Error](#) (page 1278)
- [Command View Reports “Possible Auto LUN initialization problem”](#) (page 1279)
- [An Error Occurs When Entering the IP Address in the Device Administration Screen](#) (page 1279)
- [Configuration File Loader Fails to Start or the Spreadsheet File Cannot be Uploaded](#) (page 1280)
- [Business Copy Fails or Does Not Function Properly](#) (page 1280)
- [Continuous Access Fails or Does Not Function Properly](#) (page 1281)

For troubleshooting information about installing, configuring, and logging on to Command View, or for recommendations for solving host agent installation and configuration problems, refer to the *HP StorageWorks Command View XP Installation Guide*. For troubleshooting information specific to Path Connectivity, refer to the *HP StorageWorks Command View XP Path Connectivity User Guide*.

## The Browser Displays “Data Retrieval in Progress” Message for a Long Time

The SNMP service on the Command View server is most likely disabled, uninstalled, or stopped. For the Command View server to work properly, SNMP and SNMP trap services should be running. Verify that these services are running correctly on your server and try again.

## The Device Health Screen Displays Red or Yellow Disk Array Components

The disk array's physical status is reported according to groups or types of components. To locate the individual part that is the source of the problem (yellow or red state), do the following:

- Determine the potential problem area (disks, processors, environmental monitor, etc.). Examining the picture of the disk array from Command View XP should locate the problem. You may also read the list of status conditions provided to the left of the XP disk array image.
- Examine the list of trap information provided by clicking the **Array Event History** tab. The trap history may provide further information about physical failures in the XP disk array.
- Perform a physical/visual examination of XP disk array status lights to verify the problem indicated in Command View XP application.
- If you continue to have problems, contact your HP Service Representative to resolve the issue.

## The Session Administration Screen Reports the Incorrect Host Address

If the Session Administration screen shows the wrong host address, you most likely have Web proxy server problem. To fix this either disable the proxy server in your browser (Internet Explorer only), or add the Command View XP management station IP address to the list of excluded addresses that are **not** to be directed through a Web proxy service.



**To disable the proxy service in Internet Explorer:**

1. In Internet Explorer, click **Tools > Internet Options > Connections > LAN Settings**.
2. Clear the **Use a proxy server** check box.
3. Click **OK**. Click **OK** again to exit and save changes.

**To add IP addresses in Internet Explorer:**

1. In Internet Explorer, click **Tools > Internet Options > Connections > LAN Settings**.
2. Click **Advanced**.
3. Add the IP address of the disk array to the **Exceptions** box.
4. Click **OK**. Click **OK** again to exit and save changes.

**To add IP addresses in Netscape:**

1. In Netscape, click **Edit > Preferences > Advanced > Proxies**.
2. Click **Manual Proxy Configuration**.
3. Click **View**.
4. Enter the IP address of the disk array to the **Exceptions** list. Use commas to separate entries.
5. Click **OK**. Click **OK** again to exit and save changes.

## The Disk Array License Key Installation Fails

Certain XP disk array license keys must be installed in a specific order. The following license keys have this requirement:

- Install the Continuous Access XP key before the Continuous Access XP Extension key.
- Install the ShadowImage key before the FlashCopy Extension key.
- Install the TrueCopy key before the TrueCopy Asynchronous key.

If this installation order is not followed, the installation will fail with a generic message indicating that another key must be installed first.

## The Identity and Status Screens Contain Outdated Information

If you have applied changes in LUN Management or Volume Management, you may notice the information on the Identity or Status screen is not consistent with these changes. To correct this, you must update the Identity and Status screens to reflect the latest changes. To do this, click **Update** on the Identity screen.

## Problems Occur When Removing LUSE Volumes from Volume Management

Only LUSE volumes that have been allocated can be released. Additionally, when removing a LUSE Volume, verify that the CU folder is highlighted (under the LDEV Information tree), instead of an LDEV underneath the CU folder. After this you can proceed to remove the LUSE volume.

## The Refresh Fails with an SNMP Timeout Error

If you receive SNMP timeout error when attempting to refresh or subsequent refresh attempts display the following message: “No such variable in MIB”, you may be seeing this behavior if a refresh is in progress and one of the following occurs:

- The Service Processor (SVP) of an XP48/XP512/XP128/XP1024 reboots.
- The Remote Console associated with an XP256 reboots.

Do the following to clear the error and begin a new refresh of XP disk array data:

### **XP128/XP1024 only:**

1. From the Identity screen, click the **Update** button.
2. If problem persists try the remaining steps.

### **All XP disk arrays:**

1. Log into Command View XP as the administrator.
2. Navigate to the Main screen.
3. Click the **Administration** tab.
4. Click the **Session Administration** tab.
5. Click the disk array exhibiting the error from the **Disk Array** drop-down list.
6. Click **End Session**.

7. Click the **Main** tab.
8. Click the link to the disk array exhibiting the error and begin a new refresh.

## Command View Reports “Possible Auto LUN initialization problem”

Auto LUN configuration for the XP128/XP1024: If the short range monitor and long range monitor are set to off on the Auto LUN screen, click the **Monitoring Options** tab. Specify the gathering interval and click **Apply**. Auto LUN will now collect its monitoring data.

For the XP128/XP1024 Auto LUN functionality, there may be times when upon loading Auto LUN the user will receive a “No Monitoring Data” message. This means that no input/output traffic has occurred on the disk array. Once I/O does begin, however, this message will no longer be displayed.

If you continue to experience problems, your HP representative may need to perform specific steps on the disk array’s service processor (SVP). Contact your HP representative for further assistance.

## An Error Occurs When Entering the IP Address in the Device Administration Screen

There are several possible causes to why you receive the following error when you enter the IP address in the Device Administration screen: “Could not connect to Agent or Check the format of the IP Address. For more Details, see the Help screen. FAILURE.” Possible causes include:

- The connection to that IP address is down.
- The format of the IP address is incorrect.
- IP security could be enabled on the SVP.
- The SNMP agent is not configured on the SVP (XP48/XP512).
- Microsoft SNMP services are not configured/installed on the Remote Control machine (XP256).
- The Remote Control SNMP Agent is not configured on the Remote Control machine (XP256).

## Configuration File Loader Fails to Start or the Spreadsheet File Cannot be Uploaded

If you cannot upload the spreadsheet file in Configuration File Loader, check the spreadsheet for possible errors. When the error information is displayed in the Error Information list, edit the spreadsheet according to the information listed.

Possible errors include:

- The first row of the spreadsheet, the declaration row, is not correctly written.
- The spreadsheet file is not in the text file format. The file should not be a binary file.
- There is no function tag in the spreadsheet.
- The file name is incorrect. For example, the extension is not *.spd* or the file name exceeds the maximum number of letters.
- The number of letters in a row exceeds 128.
- The number of rows in a spreadsheet exceeds 70,000.
- The program product that is stated in the declaration row is not installed.

## Business Copy Fails or Does Not Function Properly

If there is a problem with the Command View management station when using BC, or BC operations do not function properly, try the following:

- Make sure all BC requirements and restrictions are met. Verify that the PC's operating system and LAN hardware and software are properly configured.
- Make sure the disk array is powered on and fully functional (NVS, cache, DFW).
- Check all input values and parameters to make sure that you entered the correct information on the BC screens (such as P-VOL and S-VOL IDs).
- Exit the Web browser, close all other applications, and then restart the PC.
- If the volume pairs are not displaying correctly, make sure the correct CU image is selected.
- If a BC error message is displayed on the Command View management station, refer to [BC Error Codes](#) on page 560 for a description of the error code.

- If the BC pair status is incorrect or unexpected, the pair may have been suspended or deleted from the UNIX/PC server host using RAID Manager XP. If not, the disk array detected an error condition during BC operations. Check the Command View error log. If necessary, call HP technical support for assistance.
- If a pinned track occurs on a BC P-VOL or S-VOL, the disk array will suspend the pair. Please contact your HP representative for assistance in recovering pinned tracks.
- If only the Exit and Refresh buttons are available when accessing the disk array from the Command View management station, the disk array might not be ready or perform some write processes from the other system. Wait for a while, and then click **Refresh**.
- If the problem persists, save the Java log file on the Command View management station and report to HP technical support. For Windows 2000, the Java log file (*plugin.trace*) location is  
C:\Documents and Settings\login user ID.

## Continuous Access Fails or Does Not Function Properly

If there is a problem with the Command View management station when using CA, or CA operations do not function properly, try the following:

- Make sure that the problem is not being caused by the PC or Ethernet hardware or software, and then restart the PC. Restarting the Command View management station does not affect disk array operations.
- Make sure that all CA requirements and restrictions are met.
- Make sure that the MCU and RCU and remote copy connections are powered on and fully operational (NVS, cache).
- Check all input values and parameters to make sure that you entered the correct information in Command View (for example, RCU S/N and SSID, path parameters, P-VOL and S-VOL IDs).
- Disconnect Performance Advisor from the disk array before connecting to the same disk array.
- If an RCP or initiator channel-enable LED indicator (on the disk array's control window) is off or flashing, call HP technical support for assistance.
- If the volume pairs and/or RCUs are not displaying correctly, make sure that the correct CU image is selected.

- If the RCU path status is not normal, check the path status (RCU Status window), and refer to [Table 182](#) on page 1283 for possible solutions.
- If the pair status is suspended, check the pair status (Pairdisplay window), and see [Table 183](#) on page 1285 for possible solutions.
- If the paircreate or pairresync operation resulted in a timeout error, there could be two possible causes:
  - Hardware failure: If the timeout error was caused by a hardware failure, a SIM will be generated. If this occurs, call service personnel, and retry CA operations after the problem is fixed.
  - Heavy workload: If no SIM was generated, wait for a while (5 or 6 minutes), then check the pair status of the pair(s) being created or resumed. If the pair status changed correctly, the failed operation completed after the timeout message was issued. If the pair status did not change as expected, heavy workload might have prevented the CA operation from being completed. In this case, retry the CA operation again when the disk array has a lighter workload.
- If there is a pinned track on a CA volume, refer to [Table 184](#) on page 1287 for possible solutions.

## Troubleshooting RCU Path Status Problems

The following table provides troubleshooting instructions for RCU paths.

**Table 182: RCU path status troubleshooting**

Path Status	Description	Corrective Action
Initialization Failed	The link initialization procedure to the RCU failed.	<p>Make sure that you entered the correct RCU S/N and SSID and path parameters (port, link address, logical address).</p> <p>For Fibre Channel, make sure that the correct MCU port is configured as an initiator port and the correct RCU port is configured as an RCU target port.</p> <p>For serial, make sure the correct MCU port is configured as an RCP and the correct RCU port is configured as an LCP.</p>
Communication Time Out	Communication between the MCU and RCU timed out.	<p>Make sure that the RCU is powered on and fully functional (NVS and cache ON).</p> <p>Make sure that the remote copy connection hardware (cables, connectors, ESCDs) is properly configured and functional.</p> <p>Delete the failed path. You may need to change the minimum paths setting or delete the RCU in order to delete the path. Then register the path/RCU.</p>
Resource Shortage (MCU/RCU)	The MCU/RCU rejected the establish logical path link control function because all logical path resources in the MCU/RCU are being used for other connections.	<p>Delete the failed path, and also delete all paths and RCUs not currently in use. The MCU can be connected to up to four RCUs with up to eight paths to each RCU.</p> <p>Make sure that all MCU and RCU ports are properly configured:</p> <p>Fibre – ordinary target ports or RCU target ports for hosts, RCU target ports for MCUs, initiator ports for RCUs.</p> <p>Serial – LCPs for hosts and MCUs, RCPs for RCUs.</p> <p>If necessary, connect to the RCU to delete paths/RCUs and reconfigure ports, then reconnect to the MCU.</p> <p>Register the path/RCU again.</p>
Serial Number Mismatch	The RCU's S/N does not match the specified S/N.	<p>Make sure that you entered the correct RCU S/N and SSID and path parameters (port, link address, logical address).</p> <p>Delete the failed path. You may need to change the minimum paths setting or delete the RCU in order to delete the path. Then register the path/RCU.</p>

**Table 182: RCU path status troubleshooting (Continued)**

Path Status	Description	Corrective Action
Invalid Port	The specified port is not configured as an RCP or initiator port, or this path already exists.	<p>For fibre, make sure that the correct MCU port is configured as an initiator ports. Make sure that the correct RCU port is configured as an RCU target port.</p> <p>For serial, make sure the correct MCU port is configured as an RCP and the correct RCU port is configured as an LCP.f</p> <p>Make sure that you entered the correct RCU S/N and SSID and path parameters (port, link address, logical address).</p> <p>Delete the failed path. You may need to change the minimum paths setting or delete the RCU in order to delete the path. Then register the path/RCU.</p>
RCU Port Number Mismatch	The specified port in the RCU is physically disconnected from the MCU, or the port is not configured as an RCU target port.	<p>Make sure that you entered the correct RCU port number. Correct the port number if necessary.</p> <p>Make sure that the port in the RCU is configured as an RCU target port. Configure the port as an RCU target port if necessary.</p> <p>Make sure that the MCU and RCU are physically connected.</p>
<blank>	This path was not established.	Delete the failed path. You may need to change the minimum paths setting or delete the RCU in order to delete the path. Then register the path/RCU.



## Troubleshooting Suspended CA Pairs

The following table provides troubleshooting instructions for suspended CA pairs (Synchronous and Asynchronous).

**Table 183: Suspended CA pairs troubleshooting**

Suspend Type	Applies to	Description	Corrective Action
PSUE, by RCU	P-VOL	The MCU detected an error condition at the RCU that caused the MCU to suspend the volume pair. The S-VOL suspend type is <i>by MCU</i> .	Clear the error condition at the RCU or S-VOL. If you need to access the S-VOL, split the pair (pairsplit-r) from the MCU using the S-VOL write enable option.  Resume the pair (pairresync) from the MCU after the error condition is cleared.
PSUE, S-VOL Failure	P-VOL	The MCU detected an error during communication with the RCU or an I/O error during update copy. In this case, the suspend type for the S-VOL is usually <i>by MCU</i> .	Check the path status on the RCU Status window.  Clear any error conditions at the RCU or S-VOL. If you need to access the S-VOL, split the pair (pairsplit-r) from the MCU using the S-VOL write enable option.  Resume the pair (pairresync) from the MCU after the error condition is cleared.
PSUE, MCU IMPL	P-VOL, S-VOL	The MCU could not find valid control information in its nonvolatile memory during the IMPL procedure. This error occurs only if the MCU is without power for more than 48 hours (power failure and fully discharged batteries).	Resume the pair (pairresync) from the MCU. The MCU will perform an entire initial copy operation in response to the pairresync request.

**Table 183: Suspended CA pairs troubleshooting (Continued)**

Suspend Type	Applies to	Description	Corrective Action
PSUE, Initial Copy Failed	P-VOL, S-VOL	The MCU suspended this pair during the initial copy operation. The data on the S-VOL is not identical to the data on the P-VOL.	Delete the pair from the MCU. Clear all error conditions at the MCU, P-VOL, RCU, and S-VOL. Restart the initial copy operation using the Paircreate window.
PSUE, MCU P/S-OFF	S-VOL (Async)	The MCU suspended all CA Async pairs due to MCU power-off.	None. The MCU will automatically resume these CA Async pairs during power-on.
PSUS, Sidefile Overflow	P-VOL S-VOL	The amount of sidefile exceeds the specified current pending update data rate, and the RCU data is not transferred within the specified offloading timer.	Add cache memory, increase the number of paths between MCU and RCU, or decrease the number of Async pairs or host I/Os.

## Resolving CA Async Suspension Conditions

The following table provides troubleshooting instructions for the CA Async suspension conditions caused by the offloading timer async option, the group timeout options (copy pending and RCU ready), and recordset errors. Hardware failures that affect the cache storage/shared memory of the MCU or RCU may also cause the CA Async volume pairs to be suspended.

**Table 184: CA Async Suspension Conditions**

Classification	Causes of Suspension	SIM	Recovery procedure
MCU/RCU hardware	<p>Hardware redundancy has been lost due to some blockade condition. As a result, MCU-RCU communication, creating or receiving recordset, or the staging or de-staging process could not complete.</p> <p>The pending recordset cannot be retained because one side of cache storage or shared memory has been blocked due to hardware failure.</p> <p>MCU-Creating/sending recordset failed due to unrecoverable hardware failure.</p> <p>RCU-Reading/settling recordset failed due to unrecoverable hardware failure.</p> <p>The drive parity group was in correction-access status while the CA pair was in COPY state.</p>	DB0x DB1x DB2x	<p>According to SIM, remove the hardware blockade or failure.</p> <p>Re-establish failed volume pairs (pairresync).</p>
MCU-RCU communication	<p>During the power-on-reset sequence, the MCU could not communicate with the RCU within the specified RCU ready timeout.</p> <p>The RCU could not settle the pending recordset or could not communicate with the MCU before the copy pending timeout due to MCU not-ready or inoperative facilities on the remote copy connections.</p>	DB0x DB1x	<p>Remove the failed condition at the RCU/MCU or on the remote copy connection.</p> <p>Re-establish failed pairs (pairresync).</p>

**Table 184: CA Async Suspension Conditions (Continued)**

Classification	Causes of Suspension	SIM	Recovery procedure
RIO overload	<p>The unrecoverable RIO (remote I/O) timeout occurred due to overload of the RCU or the communication facilities on the remote copy connections.</p> <p>No recordset could be sent within the specified copy pending timeout.</p> <p>The RCU could not settle the pending recordset before the copy pending timeout due to overload of the RIO or the RCU itself.</p>	DB1x	<p>Delete failed pairs (pairsplit-S).</p> <p>Reconsider the performance resources necessary, and increase resources as needed (cache amount, number of MCU-RCU paths, etc.).</p> <p>Re-establish failed pairs (paircreate).</p>
RIO failure	<p>The RIO (remote I/O) could not complete due to the failure at the RCU.</p>	DB2x	<p>According to SIM generated at the RCU, remove the failure.</p> <p>Re-establish failed pairs (pairresync).</p>
MCU planned outage	<p>The CA Async pairs were temporarily suspended due to a planned outage of the MCU.</p>	DB8x	<p>No recovery procedure is required. The MCU will automatically remove the suspension condition during the next power-on-reset sequence.</p>

16-Port FC/CA CHIP [192](#)

## A

### accessing

- application administration [64](#)
- array event history [92](#)
- device administration [76](#)
- disk array identity information [118](#)
- event notification [93](#)
- LUN Management [144](#)
- LUN Management operations [204](#)
- LUN Security [254](#)
- session administration [114](#)
- status [122](#)
- Support screens [70](#)
- user administration [56](#)

### adding

- applications [66](#)
- consistency group [854](#), [855](#)
- consistency groups [663](#)
- disk arrays [78](#)
- host groups [209](#)
- new pairs using PPRC [1106](#)
- new users [58](#)
- path to RCU [653](#), [845](#)
- RCU path [845](#)
- SCSI/FC paths [148](#)
- SNMP IP Security [83](#)
- SSID to RCU [656](#), [847](#)

### addressing

- Fibre Channel ports [241](#)
- application administration
  - accessing [64](#)

### applications

- adding [66](#)
- deleting [67](#)
- editing [68](#)

### applying

- command device security [236](#)
- LUN security [234](#)
- pattern files [1249](#)

### array event history

- accessing [92](#)

### associating

- host groups to logical volumes [213](#)

### associating host groups to logical volumes [209](#)

### At-Time Split function

- BC [515](#)
- SI390 [1041](#)

### audience [38](#)

### authorized reseller, HP [41](#)

### auto migration [407](#), [421](#)

### auto migration class details [425](#)

## B

### base and alias devices

- defining [1162](#)

### BC

#### At-Time Split function [515](#)

#### cascade function [510](#)

#### combining with other features [523](#)

#### creating and splitting pairs at the same time [547](#)

#### creating pairs (paircreate) [540](#)

#### deleting pairs (pairsplit-S) [554](#)

#### Host I/O Performance option [510](#)

- initial copy operation [500](#)
- normal pairresync operation [503](#)
- pair status conditions [519](#)
- paircreate operation [499](#)
- pairresync operation [503](#)
- pairsplit operation [502](#)
- pairsplit-E (suspend) operation [507](#)
- pairsplit-S (delete) operation [508](#)
- preparing for operations [522](#)
- quick pairresync operation [503](#)
- quick restore pairresync operation [504](#)
- quick split operation [502](#)
- requirements [495](#)
- reset reserve attribute operation [499](#)
- resynchronizing pairs (pairresync) [549](#)
- reverse pairresync operation [503](#)
- set reserve attribute operation [499](#)
- splitting pairs (pairsplit) [545](#)
- starting operations [527](#)
- steady split operation [503](#)
- suspending pairs (pairsplit-E) [552](#)
- Swap&Freeze option [509](#)
- system requirements [522](#)
- update copy operation [501](#)
- BC and CA volumes [524](#)
- BC and Cache LUN volumes [524](#)
- BC and LUN Security operations [524](#)
- BC and LUSE volumes [523](#)
- BC and VSC volumes [524](#)
- BC error codes [560](#)
- block size [678](#)
- Business Copy. See BC
- C**
- CA
  - CA main screen [617](#)
  - changing pair options [705](#)
  - components [569](#)
  - copy modes [578](#)
  - data migration [707](#)
  - deleting pairs (pairsplit-S) [701](#)
  - disaster recovery [712](#)
  - discontinuing CA operations [679](#)
  - error codes [722](#)
  - fibre remote copy connections [603](#)
  - initial copy options [691](#)
  - optimizing operations [677](#)
  - pair status [587](#)
  - preparing for pair operations [680](#)
  - remote copy operations [577](#)
  - requirements and restrictions [599](#)
  - resuming pairs (pairresync) [697](#)
  - serial remote copy connections [606](#)
  - sharing volumes with BC [613](#)
  - splitting pairs (pairsplit-r) [693](#)
  - system requirements [598](#)
  - CA and BC volumes [613](#)
  - CA and Cache LUN volumes [613](#)
  - CA and LUN Security operations [613](#)
  - CA and LUSE volumes [613](#)
  - CA and Prioritized Port Control [613](#)
  - CA and VSC volumes [613](#)
  - CA Async
    - analyzing consistency of S-VOLs [718](#)
    - control operations [660](#)
    - cylinder bitmaps [595](#)
    - pair options [693](#)
    - pairresync options [699](#)
    - pairsplit-r options [695](#)
    - pairsplit-S options [703](#)
    - performance impact [677](#)
    - point-in-time copy [709](#)
    - recordset operations [580](#)
    - sidefile threshold [669](#), [671](#)
    - suspended pairs [596](#)
    - update copy operation [579](#)
    - write operations during [579](#)
  - CA Async suspension conditions
    - troubleshooting [1287](#)
  - CA installation
    - hardware [602](#)
  - CA pair
    - creating (paircreate) [686](#)
    - deleting (pairsplit-S) [704](#)

- options [691](#)
- resyncing [699](#)
- status [587](#)
- CA Sync
  - performance impact [677](#)
  - update copy operation [578](#)
  - write operations during [579](#)
- cache [243](#)
  - inflow control [583](#)
  - requirements for CA [601](#)
  - requirements for TC390 [776](#)
- cache areas
  - managing [373](#)
- Cache LUN
  - modes [375](#), [387](#)
  - overview [383](#)
  - pre-staging [389](#)
- CDELP AIR for TC390A [945](#)
- CESTPAIR for TC390A [941](#)
- CESTPATH SAID parameters [941](#)
- CGROUP (FREEZE/RUN) [950](#)
  - FREEZE option [952](#), [954](#)
  - GDPS environment [955](#)
  - requirements [951](#)
  - RUN option [955](#)
  - SSID requirements [951](#)
  - SVP modes [953](#)
- changing
  - access attributes of logical volumes [332](#), [1247](#)
  - CA pair options [705](#)
  - cache extent's mode [400](#)
  - Cache LUN extent mode [382](#)
  - consistency group options [857](#)
  - disk array parameters [80](#)
  - LU path settings [215](#)
  - RCU options [842](#)
  - timeout value [116](#)
  - volume pair options [905](#)
  - WLM PAV settings [1180](#)
  - WWNs and nicknames of hosts [220](#)
- channel demand [678](#)
- Configuration File Loader
  - Configuration File Loader screen [344](#)
  - downloading a spreadsheet file [362](#)
  - outline [338](#)
  - overview [337](#)
  - spreadsheet software [341](#)
  - uploading a spreadsheet file [365](#)
- configuring
  - async options [668](#), [859](#)
  - e-mail notifications [95](#)
  - event history settings [93](#)
  - Fibre Channel ports [164](#), [238](#)
  - LU paths in an NAS environment [190](#)
  - LUs for use by RAID Manager [198](#)
  - MCU ports [825](#)
  - MCUs and RCUs for CA [609](#)
  - MCUs and RCUs for FC [787](#)
  - MCUs and RCUs for serial interface [785](#)
  - notification schedule [104](#)
  - Partial Cache Residence (PCR) [243](#)
  - script notifications [98](#)
  - SNMP notifications [101](#)
- consistency group [573](#), [585](#)
  - adding [663](#), [854](#), [855](#)
  - changing options [857](#)
  - deleting [667](#), [858](#), [861](#)
  - deleting all pairs in group [704](#), [902](#)
  - operations on groups [586](#)
  - options [586](#), [663](#), [665](#), [854](#), [856](#)
  - requirements [600](#)
  - resuming [897](#)
  - resyncing [699](#)
  - viewing status [852](#)
- consistency status [592](#)
- Continuous Access. See CA
- conventions
  - document [39](#)
  - text symbols [39](#)
- copy mode [578](#)
- CQUERY
  - for CGROUP [958](#)
  - for TC390A [947](#)

- creating
  - BC pairs [547](#)
  - BC pairs (paircreate) [540](#)
  - cache extent [379](#), [394](#)
  - expanded continuous LUNs [155](#)
  - expanded dispersed LUNs [157](#)
  - host groups [209](#)
  - pairs [686](#)
  - pattern files [1248](#)
  - RAID Manager command devices [235](#)
  - volume pairs [880](#), [888](#)
- CRECOVER for TC390A [946](#)
- CSUSPEND for TC390A [943](#)
- CSUSPEND/QUIESCE TSO command [917](#)
- CTG screen [1089](#)
- CU image [572](#)
- currency of R-VOLs [919](#)
- currency of S-VOLs [717](#)
- custom volumes
  - installing [178](#)
- D**
- data migration
  - using CA [707](#)
  - using TC390 [907](#)
- database recovery [716](#), [917](#)
- DBE [1255](#)
  - disk array requirements [1256](#)
  - host server requirements [1256](#)
  - starting [1257](#)
  - supported backup devices [1256](#)
- default passwords [49](#)
- default user names [49](#)
- defining
  - alternate paths [225](#)
  - base and alias devices [1162](#)
  - LU paths [209](#)
  - XP1024 LCU [1162](#)
- deleting
  - applications [67](#)
  - BC pairs (pairsplit-S) [554](#)
  - CA pair by force [702](#)
  - CA pairs (pairsplit-S) [701](#)
  - consistency group [667](#), [858](#), [861](#)
  - disk arrays [79](#)
  - HBA's from host groups [222](#)
  - history events [109](#)
  - LU paths [215](#)
  - pairs [704](#)
  - path to RCU [655](#), [846](#)
  - pattern files [1250](#)
  - RCU [650](#), [843](#)
  - RCU path [846](#)
  - RCUs [650](#), [842](#)
  - SCSI/FC paths [147](#)
  - SSID from RCU [657](#), [847](#), [849](#)
  - unneded WWNs from the WWN table [223](#)
  - users [60](#)
  - volume pairs [902](#), [1083](#)
  - volume pairs using PPRC [1113](#)
  - WWNs [233](#)
- device administration
  - accessing [76](#)
- device blocking
  - HXRC [1015](#)
  - TC390 [943](#)
- DEVSERV commands [1105](#), [1106](#)
- DFW requirements for TC390 [776](#)
- Direct Backup Engine [1255](#)
- disaster recovery
  - clearing SIMs [918](#)
  - consistency of async R-VOLs [920](#)
  - currency of S-VOLs [717](#), [719](#)
  - currency of sync R-VOLs [919](#)
  - file and database recovery procedures [916](#)
  - file/DB recovery [715](#)
  - host failover [715](#)
  - M-VOL fence level [914](#)
  - preparing for [712](#), [913](#)
  - resuming normal operations [923](#)
  - switching to the remote site [918](#)
  - timer type for TC390A in reverse [921](#)
  - transferring back to the main site [921](#)



- transferring sense information through ERC  
915
- discontinuing
  - CA operations 679
  - TC390 operations 871
- disk array identity information
  - accessing 118
- disk arrays
  - adding 78
  - changing parameters 80
  - deleting 79
  - powering off/on CA components 709
  - viewing device history 81
- displaying
  - alternate paths 232
  - consistency group status 852
  - HPAV device parameters 1175
  - pair status using PPRC 1106
  - RCU status 826
  - TC390 pair status information 876
- document
  - conventions 39
  - prerequisites 38
  - related documentation 38
- downgrading permissions 62
- downloading
  - pattern files 1251
- downloading a spreadsheet file 362
- dummy pair mode 942
- dynamic HPAV 1138, 1140

## E

- editing
  - application information 68
  - pattern files 1249
- ending a session 115
- ERC 916
- error codes 932
- error reporting communications 916
- event history settings
  - configuring 93
- event notification

- accessing 93
- configuring e-mail notifications 95
- configuring script notifications 98
- configuring SNMP notifications 101
- deleting history events 109
- managing the notification schedule 104
- specifying an e-mail server 94
- testing 110
- viewing configured notifications 106
- viewing event history 106
- viewing notification history 108

## F

- failover, host 576, 601, 715
- failure conditions 961
- FC-AL topology and point-to-point topology  
198
- features 45
- Fibre Channel
  - setting port addresses 165
- Fibre Channel interface ports 575
- Fibre Channel ports
  - attributes 198
  - configuring 164
  - Fibre Channel topology 198
- ibre remote copy connections 603, 778
- file recovery 716, 917
- fixing parity group attributes 427

## G

- GDPS 951
- getting help 41
- group
  - Delete Pair option 901
  - error level pair option 693
  - pairresync option 699
  - pairsplit-r option 695
  - pairsplit-S option 703
  - Resume Pair option 896
  - TC390A pair option 805, 887
  - TC390A suspend option 891

GTF I/O tracing [1158](#)

## H

hardware installation for CA [602](#)

help, obtaining [41](#)

history log [429](#)

host agents [43](#)

host failover software [576](#), [601](#), [715](#)

Host I/O Performance option

BC [510](#)

SI390 [1041](#)

## HP

authorized reseller [41](#)

storage website [41](#)

technical support [41](#)

## HPAV

assigning aliases [1151](#)

canceling aliases [1153](#)

defining device parameters [1175](#)

maximizing results [1142](#)

overview [1136](#)

performing operations [1151](#)

preparing host system [1146](#)

requirements [1141](#)

restrictions [1141](#)

system requirements [1144](#)

verifying device status [1156](#)

verifying devices [1156](#)

HXRC [733](#), [953](#)

## I

### ICKDSF

media maintenance on TC390 volumes [905](#)

PPRCOPY commands [935](#)

ICKDSF commands. See PPRC commands

IEA491E system console message [960](#), [961](#)

IEA494I system console message [917](#), [960](#)

initial copy

operation [577](#)

options [691](#)

initializing

host group 0 [219](#)

initiator ports [575](#), [636](#)

i-node [243](#), [244](#)

Install CV function [273](#), [277](#), [299](#)

installing

custom volumes [178](#)

license keys [88](#)

TC390 hardware [777](#)

TC390 software [785](#)

TC390 system requirements [771](#)

## J

Java Web Start [341](#), [1242](#)

## L

Launch screen [51](#)

LDEV Guard [1237](#)

LDEV Guard screen [1243](#)

starting [1243](#)

LDEV ID

setting [179](#)

leaf volume [513](#)

license keys [85](#)

installing [88](#)

uninstalling [89](#)

logging on to Command View [48](#)

logical path. See path

logical unit [600](#)

logical volumes

changing access attributes [332](#), [1247](#)

combined into a LUSE volume [335](#)

protecting against CA and BC operations  
[333](#)

specifying VTOC size [1253](#)

LU [600](#)

LU paths configuration [194](#)

LU Size Expansion [270](#)

LUN Management [189](#)

accessing [144](#), [204](#)

LUN security [196](#)

accessing LUN Security [254](#)

- changing LUN group parameters [261](#)
- changing WWN access [260](#)
- changing WWN group members [267](#)
- defining [258](#)
- deleting a WWN [266](#)
- starting [254](#)
- LUN Security Extension [323](#)
  - LUN Security Extension screen [328](#)
  - starting [327](#)
- LUNs
  - creating expanded continuous [155](#)
  - creating expanded dispersed [157](#)
- LUSE operations
  - changing LUSE capacities [292](#)
  - creating a LUSE volume [287](#), [288](#), [289](#)
  - function [270](#)
  - releasing a LUSE volume [291](#)
  - starting [282](#)
  - viewing concatenated parity groups [287](#)
  - viewing LUSE configuration information [286](#)

## M

- Main tab [51](#)
- Make Volume function [273](#), [280](#), [309](#)
- managing
  - license keys [85](#)
- MCU
  - CGROUP requirements [951](#)
  - configuring FC [787](#)
  - configuring ports [825](#)
  - configuring serial interface [785](#)
  - operations [636](#)
  - outage [911](#)
  - powering off/on [709](#)
- migrating
  - data [908](#)
- migration
  - using CA [707](#)
  - using TC390 [907](#)
- MIH timer value [1146](#)
- modes
  - for TC390 (and HXRC) [733](#)

- modifying
  - consistency group options [857](#)
  - parameters [861](#)
  - RCU options [842](#)
  - RCU, Path, or SSID parameters [849](#)
  - user passwords [59](#)
  - volume parameters [875](#)
- M-VOL
  - fence level [883](#), [914](#)
  - performing ICKDSF on [906](#)
  - pinned track [972](#)
- MVS commands [1158](#)

## N

- NAS
  - configuring LU paths [190](#)
  - folder [206](#)
- node volume [513](#)
- NVS
  - CA requirements [601](#)
  - TC390 requirements [776](#)

## O

- omitting
  - RCU, Path, or SSID from the operation [849](#)
  - selected volumes [876](#)
- operations
  - initial copy [500](#)
  - normal pairresync [503](#)
  - paircreate [499](#)
  - pairresync [503](#)
  - pairsplit [502](#)
  - pairsplit-E (suspend) [507](#)
  - pairsplit-S (delete) [508](#)
  - preparing for [522](#)
  - quick pairresync [503](#)
  - quick restore pairresync [504](#)
  - quick split [502](#)
  - reserve [1029](#)
  - reset reserve [499](#), [1030](#)
  - reverse pairresync [503](#)

- set reserve [499](#)
- starting [527](#)
- steady split [503](#)
- update copy [501](#)
- optimizing CA operations [677](#)
- options
  - initial copy [691](#)
  - pairsplit-r [694](#)
  - Suspend Pair [891](#)
- Overview screen [51](#)

## P

- pair options [691](#)
- pair settings operation [873](#)
- pair status [587](#), [1043](#)
  - COPY [589](#)
  - COPY(PD) [519](#)
  - COPY(RS) [520](#)
  - COPY(RS-R) [520](#)
  - COPY(SP) [519](#)
  - deleting [591](#)
  - during CGROUP operations [955](#)
  - PAIR [519](#), [589](#)
  - PDUB [590](#)
  - PSUE [520](#), [590](#)
  - PSUE/PSUS [591](#)
  - PSUS [519](#), [589](#)
  - PSUS(SP) [519](#)
  - SMPL [519](#), [589](#)
  - suspending [591](#)
  - troubleshooting [929](#)
- paircreate [540](#)
- pairresync [549](#), [697](#)
  - split pair [507](#)
  - suspended pair [507](#)
- pairsplit [545](#)
- pairsplit-E [552](#)
- pairsplit-r [693](#)
- pairsplit-S [554](#), [701](#)
- parameters
  - modifying [861](#)
  - modifying volumes [875](#)

- parity group configuration [275](#)
- passwords [49](#)
  - modifying [59](#)
  - rules [57](#)
- path
  - adding [653](#), [845](#)
  - adequate number of [678](#)
  - deleting [655](#), [846](#)
  - status descriptions [830](#)
  - troubleshooting [926](#)
- pattern file
  - applying [1249](#)
  - creating [1248](#)
  - deleting [1250](#)
  - editing [1249](#)
  - renaming [1250](#)
- pattern files
  - downloading [1251](#)
  - uploading [1252](#)
- PCR
  - main panel [244](#)
  - operations [243](#)
  - overview [243](#)
- performing
  - asynchronous operations [850](#)
  - HPAV operations [1151](#)
  - ICKDSF on a M-VOL [906](#)
  - ICKDSF on a R-VOL [906](#)
  - pair settings operation [873](#)
  - planned outage of MCU and RCU [912](#)
  - RCU operations [823](#)
- pinned track [723](#), [972](#), [1133](#)
- PiT
  - producing duplicate consistency group [909](#)
- placing data in cache [379](#), [394](#)
- point-in-time copy [709](#), [909](#)
- power off/on requirements [910](#)
- powering off/on CA components [709](#)
- PPRC [933](#)
  - for TC390A [938](#)
  - ICKDSF PPRCOPY commands [935](#)
  - restrictions for TC390 [767](#)

- PPRC commands
  - ATQUERY 1115
  - ATSPLIT 1113
  - DELPAIR 1113
  - ESTPAIR 1106
  - ESTPAIR MODE(RESYNC) 1112
  - parameters 1095
  - QUERY 1106
  - restrictions 1103
  - SI390 and TC390 operability 1104
  - SUSPEND 1110
- preparing
  - host system for HPAV operations 1146
- prerequisites 38
- pre-staging 389, 400
- producing
  - PiT duplicate consistency group 909
- protecting
  - logical volumes against CA and BC operations 333
- PSF commands 1105
- P-VOL
  - fence level 713
  - pinned track 723
  - read/write operations to 579
- R**
- RCU
  - adding path 653, 845
  - adding SSID 656, 847
  - configuring FC 787
  - configuring serial interface 785
  - deleting 650, 843
  - deleting path 655, 846
  - deleting SSID 657, 849
  - operations 638, 822
  - options 648
  - outage 911
  - path status 642, 830
  - performing operations 823
  - powering off/on 710
  - registering 642, 830
    - status 826
    - target ports 575, 636
    - troubleshooting path status 1282
  - read and write I/O operations 579
  - recordset operations 580
  - registering
    - disk arrays 78
    - hosts in host groups 211
    - RCU 642, 830
    - RCU to connected MCU 832
  - related documentation 38
  - releasing
    - cache extent 381, 398
  - remote copy connections 574
  - Remote Copy monitoring
    - starting 862
    - stopping 863
  - remote copy operations
    - initial copy 577
    - update copy 578
  - remote I/O (RIO) operation 581
  - removing
    - cache extent 381, 398
    - data from cache 381, 398
    - LUN security 234
    - LUs as command devices 236
    - SNMP IP Security 84
  - renaming
    - pattern files 1250
  - reserve attribute 1029
    - resetting 539, 1068
    - setting 538, 1066
  - resetting
    - reserve attribute 539
  - resuming
    - CA pairs (pairresync) 697
    - consistency group 897
    - volume pairs 897
  - resynchronizing
    - BC pairs (pairresync) 549
    - using PPRC 1112
  - resynchronizing pairs 1078

root volume [512](#)

rules for user names [57](#)

## R-VOL

analyzing currency of [919](#)

analyzing TC390A consistency of [920](#)

performing ICKDSF on [906](#)

pinned track [972](#)

## S

SAID parameters [941](#)

### SANtinel [1183](#)

access groups [1184](#)

applying security [1196](#)

classifying security groups [1204](#), [1206](#)

creating host groups [1196](#)

creating LDEV groups [1201](#)

creating security groups for use as a pool group [1206](#)

creating security groups for use as an access group [1204](#)

deleting host groups [1220](#)

deleting hosts from host groups [1216](#)

deleting LDEV groups [1223](#)

deleting logical volumes from LDEV groups [1220](#)

deleting ports from host groups [1218](#)

deleting security groups [1214](#)

disabling security [1196](#), [1210](#)

editing host groups [1214](#)

editing LDEV groups [1220](#)

editing security groups [1212](#)

editing security settings [1212](#)

emulation types [1189](#)

enabling hosts to access logical volumes [1196](#)

enabling specified hosts to access logical volumes [1184](#)

finding hosts in the security group that contains a specified logical volume [1230](#)

finding logical volumes in a security group [1224](#)

finding logical volumes in the security group that contains a specified host [1228](#)

finding ports through which hosts can access logical volumes [1227](#)

finding security groups that contain a specified host group [1231](#)

finding security groups that contain a specified LDEV group [1232](#)

finding security groups that contain a specified logical volume [1229](#)

finding security groups that contains a specified host [1225](#)

LDEV security [1183](#)

LDEVs [1183](#)

logical devices [1183](#)

logical partitions [1194](#)

LPARs [1194](#)

maximum number of groups [1190](#)

PCB types [1189](#)

pool groups [1188](#)

port-level security [1183](#), [1186](#)

prohibiting hosts from accessing logical volumes [1188](#), [1206](#)

protecting logical volumes from erroneous remote copy operations [1189](#)

protecting logical volumes from I/O operations [1184](#)

protecting logical volumes from remote copy operations [1208](#)

registering host and LDEV groups in a security group [1205](#)

registering hosts in a host group [1198](#)

registering hosts to be attached to the disk array [1214](#)

registering LDEV groups in a security group [1208](#)

registering logical volumes in an LDEV group [1202](#)

registering ports in a host group [1200](#)

renaming host groups [1219](#)

renaming LDEV groups [1221](#)

renaming security groups [1213](#)

- restrictions 1189
- secondary volumes 1189
- starting 1192
- system requirements 1184
- troubleshooting 1234
- unregistering host groups from a security group 1212
- unregistering LDEV groups from a security group 1212
- viewing security settings 1224
- scripting 816, 979
  - ChangeHrcPair command 991
  - components 982
  - CreateHrcPair command 984
  - DeleteHrcPair command 987
  - functional macro commands 980
  - GetHrcStatus command 993
  - internal macro commands 981, 995
  - parameter restrictions 983
  - result value 1001
  - ResumeHrcPair command 990
  - SelectHrcDevice command 993
  - StartHrcPair command 992
  - SuspendHrcPair command 989
  - symbols 983
  - syntax description 982
- SCSI/FC paths
  - adding 148
  - deleting 147
  - viewing 146
- security
  - defining LUN parameters 258
- sequential write operations 678
- service information message (SIM) 722
- session
  - changing the timeout value 116
  - ending 115
- session administration
  - accessing 114
- setting
  - asynchronous option parameters 860
  - cache extent 379, 394
  - data transfer speed for Fibre Channel ports 200, 241
  - Fibre Channel addresses 241
  - Fibre Channel port addresses 165
  - Fibre Channel topology 241
  - LDEV IDs 179
  - LUs as command devices 236
  - MIH timer value 1146
  - PCR cache 246
  - reserve attribute 538
  - SNMP IP Security 82
  - standard or high-speed mode 242
  - timeout value 116
  - user attributes 61
  - WLM operation mode 1146
- ShadowImage. See SI390
- shared CA/BC volume 613, 614
- shared SI390/TC390 volumes 1052
- SI390
  - add pair operation 1030
  - adding pairs 1069
  - At-Time Split function 1041
  - combining with other features 1050
  - components 1023
  - delete pair operation 1039
  - deleting pairs 1083
  - Host I/O Performance option 1041
  - initial copy operation 1030
  - operations 1029
  - preparing for operations 1049
  - requirements 1026
  - resync pair operations 1033
  - resynchronizing pairs 1078
  - sharing volumes with TC390 873, 1052
  - split pair operation 1032
  - splitting pairs 1073
  - suspend pair operation 1038
  - suspending pairs 1081
  - Swap&Freeze option 1040
  - system requirements 1049
  - troubleshooting 1132
  - update copy operation 1031

- sidefile threshold [584](#), [669](#), [671](#), [860](#)
  - SIMs [722](#)
    - TC control unit SIMs [974](#)
    - TC device SIMs [975](#)
  - SMPL [519](#)
  - SNMP IP Security
    - adding [83](#)
    - overview [82](#)
    - removing [84](#)
  - SNMP trap [588](#), [722](#)
  - specifying
    - e-mail server for notifications [94](#)
    - Fibre Channel topology [241](#)
    - logical devices as command devices [235](#)
    - SSIDs [180](#)
    - VTOC size [1253](#)
  - splitting
    - BC pairs [547](#)
    - BC pairs (pairsplit) [545](#)
    - CA pairs (pairsplit-r) [693](#)
    - pairs using PPRC [1110](#)
  - SSID
    - adding/deleting for RCU [656](#), [847](#)
    - requirements for CGROUP [952](#)
  - starting
    - CA operations [609](#)
    - Command View [48](#)
    - DBE [1257](#)
    - LDEV Guard [1243](#)
    - LUN Management [144](#)
    - LUN Security Extension [327](#)
    - LUSE operations [282](#)
    - Remote Copy monitoring [862](#)
    - TC390 operations [785](#)
  - static HPAV [1138](#), [1139](#)
  - status
    - accessing [122](#)
  - stopping
    - Remote Copy monitoring [863](#)
  - storage subsystem ID
    - requirements [171](#)
  - subsystem ID
    - specifying [180](#)
  - Support screens [70](#)
  - Suspend Pair options [891](#)
  - suspend type [592](#), [595](#), [929](#), [1285](#)
  - suspended CA pairs
    - troubleshooting [1285](#)
  - suspending
    - BC pairs (pairsplit-E) [552](#)
    - pairs [890](#), [1081](#)
    - volume pairs [893](#)
  - S-VOL
    - analyzing currency of [717](#)
    - pinned track [723](#)
    - write option [580](#)
  - Swap&Freeze option
    - BC [509](#)
    - SI390 [1040](#)
  - switching
    - between standard and high-speed modes [200](#)
  - symbols in text [39](#)
  - SYS1.LOGREC [916](#), [973](#)
- ## T
- Target port [636](#)
  - TC390
    - components [731](#)
    - control unit SIMs [974](#)
    - data migration [907](#)
    - device SIMs [975](#)
    - disaster recovery [913](#)
    - discontinuing TC390 operations [870](#)
    - displaying pair status information [876](#)
    - error codes [932](#)
    - fibre remote copy connections [778](#)
    - hardware installation [777](#)
    - initial copy operation [743](#)
    - MIH value for [777](#)
    - modes [733](#)
    - optimizing operations [868](#)
    - overview [725](#)
    - preparing for pair operations [872](#)



- remote copy connections [781](#)
  - remote copy operations [743](#)
  - requirements and restrictions [773](#)
  - sharing volumes with SI390 [793](#), [873](#), [1052](#)
  - software installation [784](#)
  - special write command [742](#)
  - starting operations [785](#)
  - system requirements [771](#)
  - TrueCopy main screen [797](#)
  - volume pair status [759](#)
  - volume pairs [737](#)
  - TC390 Asynchronous
    - analyzing consistency of R-VOLs [920](#)
    - control operations [850](#)
    - cylinder bitmaps [766](#)
    - Delete Pair options [901](#)
    - pair options [887](#)
    - performance impact [868](#)
    - point-in-time copy [909](#)
    - recordset operations [747](#)
    - Resume Pair options [896](#)
    - sidefile threshold [860](#)
    - suspend options [891](#)
    - suspended pairs [765](#)
    - troubleshooting [931](#)
  - TC390 pair
    - creating (Add Pair) [880](#)
    - deleting (Delete Pair) [902](#)
    - resuming [897](#)
    - resuming (Resume Pair) [894](#)
    - suspending (Suspend Pair) [890](#)
  - TC390 sync
    - performance impact [868](#)
  - technical support, HP [41](#)
  - testing event notifications [110](#)
  - text symbols [39](#)
  - timeout
    - copy pending [664](#), [666](#), [855](#)
    - RCU ready [586](#), [664](#), [666](#), [855](#)
    - session [116](#)
  - troubleshooting [1275](#)
    - Async suspension conditions [1287](#)
    - RCU path status [926](#), [1282](#)
    - SI390 [1132](#)
    - suspended CA pairs [1285](#)
    - suspended pairs [929](#)
    - TC390 [925](#)
    - TC390A suspension conditions [931](#)
  - TSO commands. See PPRC commands
- ## U
- uninstalling
    - license keys [89](#)
  - unregistering disk arrays [79](#)
  - update copy operation [578](#)
  - uploading
    - pattern files [1252](#)
  - uploading a spreadsheet file [365](#)
  - user administration
    - accessing [56](#)
  - user names [49](#)
    - rules [57](#)
  - users
    - adding [58](#)
    - deleting [60](#)
    - setting attributes [61](#)
  - using
    - TC390 Synchronous to migrate data [908](#)
- ## V
- viewing
    - concatenated parity groups [224](#)
    - configured event notifications [106](#)
    - consistency group status [852](#)
    - device history [81](#)
    - event history [106](#)
    - list of logical volumes combined into a LUSE
      - volume [335](#)
    - LU path settings [215](#)
    - notification history [108](#)
    - PCR settings [246](#)
    - RCU status [826](#)
    - SCSI/FC paths [146](#)

- WLM PAV settings [1180](#)
- Virtual LVI/LUN [791](#), [1050](#)
- Volume Initialize function [273](#), [280](#), [317](#)
- Volume Management [269](#)
- volume pairs
  - changing options [905](#)
  - creating [888](#)
  - deleting [902](#)
  - resuming [897](#)
  - suspending [893](#)
- Volume to Space function [273](#), [276](#), [297](#)
- volumes
  - omitting [876](#)
- VSC operations
  - browsing current VSC configuration information [296](#)
  - converting logical volumes to spaces [297](#)
  - converting VSC to normal [183](#)
  - creating custom volumes [299](#)

- creating initial custom volumes for OPEN-V [309](#)
- deleting a custom volume [309](#)
- functional description [273](#)
- initializing custom volumes for other than OPEN-V [317](#)
- VTOC size [1253](#)

## W

- websites
  - HP storage [41](#)
- WLM operation modes [1146](#)
- WLM PAV settings [1180](#)
- write-intensive workloads [678](#)

## X

- XP1024 LCU [1162](#)

---

## Figures

1	Command View integrated with other management platforms and application modules	44
2	Command View initial screen	48
3	Login dialog box	49
4	Overview/Launch screen	51
5	User Administration screen	56
6	Add a New User screen	58
7	Modify User Password screen	59
8	Delete a User screen	60
9	Set Attributes for a User screen	61
10	Downgrading Permission message	62
11	Application Administration screen	64
12	Add New Applications screen	66
13	Deleting applications (Application Administration screen)	67
14	Edit Applications screen	68
15	Download page	70
16	FAQ page	71
17	Reference Documents page	72
18	Integrating Command View with Other Platforms page	73
19	HP Customer Care Web page	74
20	Device Administration screen (XP128/XP1024)	76
21	Device History screen	81
22	IP Security Manager screen	83
23	Accessing License Key Management	86
24	License Key Management main screen	87
25	License Key Management (Install) screen	88
26	License Key Management (Uninstall) screen	89
27	Array Event History screen	92
28	Notification screen	93
29	History Log Configuration screen	94
30	Email Server Configuration screen	95
31	Email Notification screen	96
32	Notification screen for e-mail notifications	97
33	Script Notification screen	99
34	Notification screen for script notifications	100
35	SNMP Notification screen	102
36	Notification screen for SNMP notifications	103
37	Schedule screen for creating a new schedule	104

---

38	Schedule screen for existing schedules	105
39	Event History screen	107
40	Notification History screen	109
41	Clear History screen	110
42	Array Test Event screen	111
43	Path Connectivity Test Event screen	112
44	Session Administration screen	114
45	Identity screen (XP512)	118
46	Identity screen (XP1024)	119
47	Status Overview screen	122
48	Port/LUN Map screen	124
49	Ldev/Port Map screen	126
50	ACP/Ldev Map screen	128
51	Ports screen	130
52	Device Health screen	132
53	LUN Security screen	134
54	Cache LUN screen	136
55	VSC screen	138
56	Parity Group screen	140
57	LUN Management screen	144
58	Delete Path Confirmation screen (LUN Management screen)	147
59	Add Path screen	148
60	Add Path Confirmation screen	150
61	LUN Expansion Main screen	153
62	LUN Expansion Detail screen	155
63	LUN Expansion Continuous screen	156
64	LUN Expansion Disperse screen	158
65	View Host Mode Configuration screen	161
66	Host Mode Configuration screen	162
67	View Fibre Port Configuration screen	164
68	Setting a Fibre Channel port address (Set Fibre Port Configuration screen)	165
69	Setting a Fibre Channel topology (Set Fibre Port Configuration screen)	167
70	VSC functions	170
71	Volume Size Configuration (Main Screen) screen (XP256)	172
72	Volume Size Configuration (Main Screen) screen (XP48/XP512)	173
73	Volume Size Configuration (Normal To VSC) screen (XP256)	175
74	Volume Size Configuration (Volume To Space) screen (XP48/XP512)	176
75	Volume Size Configuration (Install CV) screen (XP48/XP512)	178

---

76	LDEV ID Configuration screen . . . . .	180
77	Sub-System ID Configuration screen. . . . .	181
78	Volume Size Configuration (Deinstall CV) screen . . . . .	182
79	Deinstall CV Confirmation screen. . . . .	183
80	Volume Size Configuration (VSC to Normal) screen (XP256). . . . .	184
81	LU paths configuration in a NAS environment . . . . .	191
82	16-Port CHIP pair labeling. . . . .	192
83	Host group example 1 . . . . .	193
84	Host group example 2 . . . . .	194
85	Host group example 3 (LUN security). . . . .	197
86	Differences between high-speed and high-speed (2 port) modes . . . . .	202
87	LUN Management main screen . . . . .	204
88	NAS folder in LU Path tree . . . . .	206
89	Add New Host Group window. . . . .	210
90	Add New WWN window. . . . .	212
91	Change Host Group window . . . . .	217
92	Change WWN & Nickname window. . . . .	221
93	Alternate Paths window . . . . .	233
94	Port screen (LUN Management screen). . . . .	239
95	PCR Cache Area (Cache Extent) . . . . .	243
96	. . . . .PCR Main Panel	244
97	LUN Security main screen. . . . .	254
98	LUN Security main screen with WWN/WWN Group list box displayed . . . . .	255
99	LUN/LUN Group Security screen . . . . .	258
100	LUN Group screen. . . . .	261
101	LUN Security main screen with Nickname field displayed . . . . .	263
102	New WWN screen. . . . .	264
103	WwnGroup screen . . . . .	265
104	LUN Security main screen with Update WWN/WWN Group fields displayed . . . . .	267
105	WwnGroup screen . . . . .	268
106	LUSE configuration. . . . .	270
107	VSC process (all supported emulation types except for OPEN-V). . . . .	274
108	VSC process (OPEN-V) . . . . .	274
109	Parity group configuration for other than OPEN-V . . . . .	275
110	Virtual VSC volume configuration for other than OPEN-V . . . . .	276
111	Volume Management screen . . . . .	283
112	Customized Volume screen (Volume Management screen) . . . . .	295
113	Install CV window (1) for OPEN-V (when two or more free spaces are available). . .	300

---

114	Install CV window (1) for other than OPEN-V	301
115	Install CV window (1) for OPEN-V after clicking Set	302
116	Install CV window (1) for other than OPEN-V after clicking Set	304
117	Install CV window (2)	305
118	Setting the SSID	307
119	Install CV confirmation window	308
120	Make Volume window (1)	311
121	Make Volume window (1) after clicking Set	312
122	Make Volume window (2)	313
123	Make Volume confirmation window	316
124	Volume Initialize window	318
125	Volume Initialize confirmation window	320
126	Example of access attributes	324
127	LUN Security Extension screen	327
128	Volume Detail window	330
129	Error Detail window	331
130	Volume Detail window	336
131	Outline of the Configuration File Loader tasks	339
132	Text Import Wizard - Step 1 of 3	342
133	Text Import Wizard - Step 2 of 3	342
134	Text Import Wizard - Step 3 of 3	343
135	Configuration File Loader screen	344
136	Example of Spreadsheet	346
137	Format of configuration definition (settings)	350
138	Index and parameter parts of a spreadsheet (example)	353
139	Download window	362
140	Specifying where to download the spreadsheet	362
141	Upload window	365
142	Specifying from where to upload the spreadsheet	365
143	Cache LUN operations	371
144	Cache LUN screen	377
145	LUN/VOL Caching Define screen	379
146	LUN/VOL Caching Define screen after clicking Set	380
147	Cache LUN operations	383
148	Cache LUN screen	390
149	Auto LUN main screen	402
150	Auto Migration function	407
151	Migration of volumes based on the parity group class	409

---

152	Moving volumes to another class based on utilization	410
153	View Configuration screen	411
154	Parity Group Utilization screen	413
155	LDEV Utilization screen	414
156	Manual Migration screen	416
157	View/Stop Migration screen	418
158	Hardware Utilization screen	419
159	Auto Migration screen	421
160	Execution Parameter Settings screen	423
161	Auto Migration Class Detail screen	426
162	Fix Parity Group Attributes screen	427
163	Auto Migration History Display screen	429
164	Moving volumes to another class based on usage	439
165	Auto migration function example 1	440
166	Auto migration function example 2	440
167	Auto LUN main screen	446
168	Port-LUN, LDEV, and Physical tabs	448
169	Auto LUN Monitoring Options screen	451
170	Parity group usage statistics	454
171	Logical volume usage statistics	455
172	CHA usage statistics	456
173	CHP usage statistics	457
174	DKA usage statistics	458
175	DKP usage statistics	459
176	DRR usage statistics	460
177	Write pending rates	460
178	Usage statistics about paths between adapters and the cache switch	461
179	Usage statistics about paths between adapters and the shared memory	462
180	Usage statistics about paths between cache switches and the cache memory	462
181	Workload statistics for parity groups	464
182	Workload statistics for logical volumes in a parity group	464
183	Traffic statistics about ports in the disk array	466
184	Traffic statistics about host ports to which a disk array port is connected	466
185	Traffic statistics about host ports in a host group	466
186	Traffic statistics about LU paths	466
187	Manual Migration screen	468
188	Auto Migration screen	473
189	Attribute screen	477

---

190 Class table fields . . . . .	478
191 Parity group table fields. . . . .	479
192 Change Threshold window . . . . .	482
193 History screen . . . . .	483
194 BC overview . . . . .	493
195 Adding a pair in BC. . . . .	500
196 Update Copy operation . . . . .	501
197 Normal and quick pairresync operations . . . . .	503
198 Reverse and quick restore pair operations . . . . .	504
199 Quick Restore operation with or without Swap&Freeze option . . . . .	510
200 Cascade pairs . . . . .	512
201 Overview of At-Time Split function . . . . .	516
202 BC pair status transitions. . . . .	518
203 BC and CA: shared P-VOL/P-VOL . . . . .	525
204 BC and CA: shared P-VOL/S-VOL . . . . .	525
205 BC and CA: shared P-VOL/P-VOL and P-VOL/S-VOL . . . . .	526
206 BC and CA: shared S-VOL/P-VOL . . . . .	526
207 BC main screen . . . . .	527
208 Volume List box . . . . .	530
209 Detail window . . . . .	533
210 S-Vol Path window . . . . .	534
211 Display Filter window . . . . .	535
212 Preset Volume List box . . . . .	536
213 Set Reserve Attribute window. . . . .	538
214 Reset Reserve Attribute window . . . . .	539
215 Paircreate window . . . . .	541
216 Pairsplit window . . . . .	545
217 Pairresync window. . . . .	550
218 Pairsplit-E window . . . . .	553
219 Pairsplit-S window. . . . .	555
220 History screen . . . . .	557
221 Option screen. . . . .	559
222 CA components for Fibre Channel connection . . . . .	570
223 CA components for Serial (ESCON) connection . . . . .	571
224 Remote copy operations . . . . .	577
225 Selecting and settling CA Async recordsets at the RCU. . . . .	583
226 Fibre Channel remote copy connections . . . . .	604
227 Direct connection. . . . .	605



---

228	Switch connection	605
229	Extender connection	606
230	Serial remote copy connections	607
231	N pairs of remote copy connections	607
232	N-to-1 and 1-to-n remote copy connections (n£4)	608
233	Remote copy connections shared with channel-to-RCU connections	609
234	Add RCU and RCU Option windows	611
235	Async Option and Add CT Group windows	612
236	Shared CA P-VOL and shared BC P-VOL	615
237	Shared CA S-VOL and shared BC P-VOL	615
238	Shared CA/BC P-VOL and shared CA S-VOL/BC P-VOL	615
239	Shared BC S-VOL/CA P-VOL	616
240	CA main screen	617
241	CA main screen (Pair Operation screen)	620
242	Volume list (partial view)	621
243	Display Filter window	624
244	RCU Operation screen	625
245	RCU Operation screen with the MCU&RCU option button selected	627
246	RCU Operation screen with the Port option button selected	628
247	Asynchronous Operation screen	629
248	Usage Monitor screen	631
249	History Operations screen	632
250	Configuring the MCU ports	637
251	Displaying RCU status information	640
252	RCU Status window	641
253	Add RCU window	643
254	RCU Option window	644
255	Registering an RCU to the connected MCU	646
256	RCU Settings Parameter list	648
257	RCU Option window	649
258	RCU Settings Parameter list (RCU Option)	650
259	Fibre Channel interface connections going through switches	652
260	Add RCU window used for configuration in <a href="#">Figure 259</a>	652
261	Add Path window	653
262	Adding a new logical path from the connected MCU to an existing RCU	654
263	Add SSID window	656
264	Adding/Deleting an SSID for an existing RCU	657
265	Changing the port type	658

---

266 Performing asynchronous operations . . . . .	661
267 CT Group Status window . . . . .	662
268 Add CT Group window . . . . .	663
269 CT Group Option window . . . . .	665
270 Consistency Group Settings Parameter list . . . . .	667
271 Async Option window . . . . .	669
272 Asynchronous Option Settings Parameter list . . . . .	671
273 Display Item window . . . . .	674
274 Performing the pair settings operation . . . . .	682
275 Pairedisplay window . . . . .	684
276 Paircreate window . . . . .	687
277 Pair Settings Parameter list (Paircreate) . . . . .	690
278 Pairsplit-r window . . . . .	694
279 Pair Settings Parameter list (Pairsplit-r) . . . . .	697
280 Pairresync window . . . . .	698
281 Pair Settings Parameter list (Pairresync) . . . . .	701
282 Pairsplit-S window . . . . .	702
283 Pair Settings Parameter list (Pairsplit-S) . . . . .	705
284 Change Pair Option window . . . . .	705
285 Pair Settings Parameter list (Pair Option) . . . . .	707
286 Relationship between log file and data file in PAIR status . . . . .	715
287 TrueCopy components for serial (ESCON) connection . . . . .	731
288 TrueCopy components for Fibre Channel connection . . . . .	732
289 TrueCopy remote copy operations . . . . .	743
290 Selecting and settling TrueCopy Async recordsets at the RCU . . . . .	751
291 Graduated delay process for sidefile management . . . . .	754
292 Dummy pair mode . . . . .	755
293 Fibre Channel remote copy connection configurations . . . . .	779
294 Fibre Channel interface direct connection (NL port) . . . . .	780
295 Fibre Channel interface switch connection (FL port or F port) . . . . .	780
296 Fibre Channel interface extender connection . . . . .	781
297 Serial remote copy connection configurations . . . . .	782
298 N pairs of remote copy connections . . . . .	782
299 N-to-1 and 1-to-n remote copy connections (n£4) . . . . .	783
300 Remote copy connections shared with channel-to-RCU connections . . . . .	784
301 Setting the Async options . . . . .	786
302 Adding the consistency groups . . . . .	787
303 Add the RCUs (for Fibre) . . . . .	788

---

304	Configuring the RCU options . . . . .	789
305	Setting the Async options . . . . .	790
306	Adding the consistency groups . . . . .	791
307	TrueCopy and ShadowImage: shared M-VOL/S-VOL . . . . .	795
308	TrueCopy and ShadowImage: shared R-VOL/S-VOL . . . . .	795
309	TrueCopy and ShadowImage: shared M-VOL/S-VOL and R-VOL/S-VOL . . . . .	796
310	TrueCopy and ShadowImage: shared M-VOL/T-VOL . . . . .	796
311	TrueCopy main screen . . . . .	797
312	TrueCopy main screen (Pair Operations screen) . . . . .	802
313	Volume list . . . . .	803
314	Display Filter window . . . . .	806
315	Example of snapshot file . . . . .	808
316	RCU Operations screen . . . . .	809
317	RCU Operations screen with the MCU&RCU option button selected . . . . .	810
318	RCU Operations screen with the Port option button selected . . . . .	811
319	Standard speed, two ports per row . . . . .	812
320	High-speed (2 port), two ports per row . . . . .	812
321	High-speed, four ports per row . . . . .	812
322	Asynchronous Operations screen . . . . .	813
323	Usage Monitor screen . . . . .	815
324	Script Operations screen . . . . .	817
325	Script Operations screen during execution of a script file . . . . .	819
326	History Operations screen . . . . .	820
327	Other Operations screen . . . . .	822
328	MCU/RCU list with the RCU Status command . . . . .	827
329	RCU Status window . . . . .	828
330	Add RCU windows (Fibre and Serial) . . . . .	831
331	MCU/RCU list with the RCU Operation command . . . . .	833
332	Typical TC390 remote copy configuration with two paths . . . . .	835
333	Add RCU window – serial interface . . . . .	836
334	Fibre Channel interface connections going through switches . . . . .	837
335	Add RCU window – FC interface . . . . .	838
336	RCU Option window (Change RCU Option) . . . . .	839
337	Add Path window (for Fibre) . . . . .	844
338	Opening the Add Path window . . . . .	845
339	Add SSID window . . . . .	847
340	Opening the Add SSID window . . . . .	848
341	Consistency Group list . . . . .	851

---

342 CT Group Status window . . . . .	852
343 Add CT Group window . . . . .	854
344 CT Group Option window . . . . .	857
345 Async Option window . . . . .	859
346 Display Item window. . . . .	864
347 TrueCopy main screen (Pair Operations screen). . . . .	874
348 Pair Status window . . . . .	877
349 Add Pair (Synchronous) window. . . . .	881
350 Add Pair (Asynchronous) window . . . . .	882
351 Suspend Pair window (Asynchronous) . . . . .	890
352 Resume Pair window (Asynchronous) . . . . .	895
353 Delete Pair window (Asynchronous). . . . .	900
354 Change Pair Option window (Asynchronous). . . . .	904
355 Example of the TC390 error message . . . . .	932
356 Overview of GDPS operations . . . . .	956
357 Failure conditions (described in <a href="#">Table 116</a> ) . . . . .	962
358 Typical XP128/XP1024 SIM showing reference code and SIM type. . . . .	974
359 Result statement format. . . . .	1001
360 Scripting error code format . . . . .	1008
361 Current load balancing control . . . . .	1017
362 Combination 1: MODE 85,86 = ON,OFF; Threshold 1/2/3 = 30/40/50% . . . . .	1019
363 Combination 2 (Default): MODE 85,86 = OFF,OFF; Threshold 1/2/3 = 40/50/60%. . . . .	1020
364 Combination 3: MODE 85,86 = OFF,ON – Threshold 1/2/3 = 50/60/70% . . . . .	1021
365 Combination 4: MODE 85,86 = ON,ON – Threshold 1/2/3 = 60/70/80% . . . . .	1022
366 Typical SI390 configuration . . . . .	1024
367 Adding a pair . . . . .	1031
368 Update Copy operation . . . . .	1032
369 Normal and quick pair operations . . . . .	1034
370 Reverse and quick restore pair operations. . . . .	1035
371 Quick Restore operation with or without Swap&Freeze option . . . . .	1040
372 Outline of the At-Time Split function . . . . .	1042
373 ShadowImage pair status transitions . . . . .	1044
374 SI390 and TC390: shared S-VOL/M-VOL . . . . .	1053
375 SI390 and TC390: shared S-VOL/R-VOL . . . . .	1054
376 SI390 and TC390: shared S-VOL/M-VOL and S-VOL/R-VOL . . . . .	1054
377 SI390 and TC390: shared T-VOL/M-VOL . . . . .	1055
378 ShadowImage main screen . . . . .	1056
379 Volume List box . . . . .	1059

---

380 Detail window . . . . .	1062
381 Detail Filter window . . . . .	1063
382 Preset Volume List box displaying settings (operations) . . . . .	1064
383 Set Reserve Attribute window . . . . .	1066
384 Reset Reserve Attribute window (unreserve) . . . . .	1068
385 Add Pair Dialog window . . . . .	1070
386 Split Volume Pair window . . . . .	1074
387 Resynchronize Volume Pair window . . . . .	1079
388 Suspend Volume Pair window . . . . .	1082
389 Delete Volume Pair window . . . . .	1084
390 History screen . . . . .	1086
391 Options screen . . . . .	1088
392 CTG screen . . . . .	1089
393 CTG List Box . . . . .	1090
394 CT Group Status window . . . . .	1092
395 ShadowImage - FlashCopy pair status transition . . . . .	1119
396 Possible combination of ShadowImage - FlashCopy and SI390 pairs . . . . .	1121
397 ShadowImage - FlashCopy and TC390: shared T-VOL and M-VOL/R-VOL (not allowed) 1123	
398 Copying All Datasets Using DFSMSdss Command . . . . .	1125
399 Copying Specified Dataset Using TSO (FCESTABL) Command with EXTENTS Parameter . . . . .	1129
400 Static HPAV . . . . .	1140
401 Dynamic HPAV . . . . .	1141
402 HPAV screen . . . . .	1148
403 Assigning aliases . . . . .	1152
404 Confirming new aliases . . . . .	1153
405 Canceling aliases . . . . .	1154
406 Security example 1 . . . . .	1185
407 Security example 2 . . . . .	1187
408 Security example 3 . . . . .	1188
409 SANtinel screen . . . . .	1192
410 Add/Change Host Group window . . . . .	1197
411 Add/Change Host window . . . . .	1199
412 Select Port window . . . . .	1200
413 Add/Change LDEV Group window . . . . .	1202
414 Select LDEV window . . . . .	1203
415 Add/Change Security Group window . . . . .	1204

---

416 Specify Security Group window . . . . .	1205
417 Add/Change Security Group window . . . . .	1207
418 Specify Security Group window . . . . .	1208
419 Add/Change Security Group window . . . . .	1209
420 Add/Change Security Group window . . . . .	1211
421 Add/Change Security Group window . . . . .	1213
422 Add/Change Host window . . . . .	1215
423 Add/Change Host window . . . . .	1217
424 Select Port window . . . . .	1218
425 Add/Change Host Group window . . . . .	1219
426 Select LDEV window . . . . .	1221
427 Add/Change LDEV Group window . . . . .	1222
428 Security Group to LDEV window . . . . .	1225
429 Host to Security Group window . . . . .	1226
430 Host Group to Port window . . . . .	1227
431 Host to LDEV window . . . . .	1228
432 LDEV to Security Group window . . . . .	1230
433 LDEV to Host window . . . . .	1231
434 Host Group to Security Group window . . . . .	1232
435 LDEV Group to Security Group window . . . . .	1233
436 Error Detail window . . . . .	1234
437 Example of a pattern . . . . .	1238
438 Example of using pattern files . . . . .	1240
439 LDEV Guard screen . . . . .	1243
440 LDEV Guard Error window . . . . .	1245
441 Enter Pattern Name window . . . . .	1248
442 Download/Upload Pattern File window (Download tab) . . . . .	1251
443 Download/Upload Pattern File window (Upload tab) . . . . .	1252
444 VTOC Area window . . . . .	1254
445 DBE overview . . . . .	1255
446 DBE screen . . . . .	1257
447 Detail window . . . . .	1263
448 Construct Port Group window (adding ports) . . . . .	1265
449 Construct Port Group window (moving ports) . . . . .	1268
450 Set Timeout window . . . . .	1270

---

## Tables

1	Document Conventions . . . . .	39
2	Information for configuring SNMP notifications ( <i>NetCitizen2.mib</i> ). . . . .	101
3	LUN size limitations for OPEN-3, OPEN-8, and OPEN-9 (XP48/XP256/XP512) . . .	152
4	LUN size limitations for OPEN-3 VSC, OPEN-8 VSC, and OPEN-9 VSC (XP48/XP256/XP512) . . . . .	152
5	Host modes (fast-wide and Fibre Channel support for the XP48/XP256/XP512). . . . .	160
6	Host modes (ultra SCSI support for the XP256 only) . . . . .	160
7	VSC specifications (XP48/XP256/XP512) . . . . .	171
8	Volume types, logical blocks, and capacities (XP48/XP256/XP512). . . . .	171
9	LUN Management operation restrictions (XP48/XP256/XP512) . . . . .	186
10	VSC and LUSE operation restrictions (XP48/XP256/XP512) . . . . .	187
11	Port operation restrictions (XP48/XP256/XP512). . . . .	187
12	Host modes for host operating systems (XP128/XP1024). . . . .	195
13	AL-PA and Loop IDs (XP128/XP1024) . . . . .	199
14	Fibre Channel port icons for LUN Management operations . . . . .	205
15	NAS port icons for LUN Management operations . . . . .	206
16	LUN icons for LUN Management operations . . . . .	207
17	LDEV icons for LUN Management operations . . . . .	208
18	Channel adapter package icons for Port operations. . . . .	240
19	LUN Management operation restrictions (XP128/XP1024) . . . . .	250
20	Port operation restrictions (XP128/XP1024) . . . . .	252
21	Creating VSC Volumes by Install CV (for OPEN-V) . . . . .	277
22	VSC supported emulations. . . . .	278
23	Install Custom Volume operation parameters for mainframe and open system volumes . . 278	
24	Capacities of open system custom volume sizes . . . . .	279
25	Settings for the Make Volume operation (OPEN-V only). . . . .	280
26	LDEV status icons for LUSE operations . . . . .	284
27	LDEV status icons for VSC operations . . . . .	296
28	VSC and LUSE operation restrictions (XP128/XP1024) . . . . .	322
29	LUN Security Extension icons. . . . .	328
30	Requirements and rules for the spreadsheet file . . . . .	347
31	Components of the spreadsheet declaration line . . . . .	348
32	Format of LUN Manager spreadsheet . . . . .	354
33	Available values of configuration definitions for the [Port] tag . . . . .	355
34	Status of security switch and restriction on setting operation . . . . .	356
35	Available values of configuration definitions for the [Cha] tag . . . . .	357

---

36	Available values of configuration definitions for the [HostGroup] tag . . . . .	358
37	Available values of configuration definitions for the [WWN] tag . . . . .	359
38	Available values of configuration definitions for the [LUN] tag. . . . .	359
39	Available values of configuration definitions for the [LDEV] tag . . . . .	360
40	Cache LUN supported emulation types and parameters (XP48/XP256/XP512). . . . .	373
41	Cache LUN icons (XP128/XP1024) . . . . .	391
42	Default migration parameters and values (XP48/XP512) . . . . .	424
43	Non-cascaded volumes that can be used as source volumes (XP128/XP1024). . . . .	442
44	Cascaded volumes that can be used as source volumes (XP128/XP1024) . . . . .	443
45	Auto LUN - Port-LUN tab icons (XP128/XP1024). . . . .	449
46	Auto LUN - Physical tab icons (XP128/XP1024). . . . .	450
47	Migration log messages (XP128/XP1024). . . . .	488
48	BC operational requirements . . . . .	495
49	Number of Pairs That Can Be Created With Volumes of Each Emulation Type and Capacity . . . . .	498
50	BC pairresync parameter requirements . . . . .	506
51	BC options types and requirements . . . . .	509
52	Relationship between L1 pair status and L2 pair operations . . . . .	513
53	Relationship between L2 pair status and L1 pair operations . . . . .	514
54	Read/write operation (host to the node volume) and L1/L2 pair status. . . . .	514
55	Read/write operation (host to the leaf volume) and L2 pair status . . . . .	515
56	BC pair status conditions . . . . .	519
57	Identifying the volumes for BC operations . . . . .	523
58	Status icons for BC. . . . .	528
59	BC operations pop-up menu commands . . . . .	532
60	BC pair activity codes, messages, and descriptions. . . . .	557
61	BC error codes . . . . .	560
62	CA supported RAID level configurations . . . . .	573
63	Sidefile threshold values for CA Asynchronous operations and write pending operations. . . . .	585
64	CA Asynchronous pair status descriptions . . . . .	589
65	CA split types (PSUS) . . . . .	592
66	Consistency status descriptions for split/suspended CA Async S-VOLs . . . . .	593
67	CA suspend types. . . . .	595
68	CA Asynchronous suspension conditions . . . . .	596
69	Host pair status reporting for CA, BC, and CA/BC shared volumes. . . . .	614
70	Data Currency of a shared CA/BC volume . . . . .	614
71	CA functions . . . . .	618



---

72	Volume icons for CA operations . . . . .	622
73	Status icons for CA operations. . . . .	622
74	Logical path status . . . . .	642
75	Remote copy I/O statistics . . . . .	675
76	Disk array performance conditions and recommendations . . . . .	678
77	Fence level settings on a CA Sync P-VOL . . . . .	713
78	Determining CA Synchronous S-VOL currency based on its pair status and P-VOL fence level setting . . . . .	718
79	Determining CA Async S-VOL consistency based on its pair status and consistency status . . . . .	719
80	HXRC path configuration with FICON . . . . .	728
81	XP128/XP1024 modes for TrueCopy (and HXRC). . . . .	733
82	TC390 configuration with FICON. . . . .	739
83	Operation of the unit of data stored in bitmap . . . . .	747
84	Maximum number of pairs possible for the basic LU type . . . . .	747
85	Sidefile thresholds . . . . .	752
86	Differences between TC390A dummy pair mode and HPAV. . . . .	755
87	TrueCopy volume pair status . . . . .	761
88	Suspend types. . . . .	764
89	Consistency status for suspended TrueCopy Async R-VOLs . . . . .	765
90	TrueCopy Asynchronous suspension conditions . . . . .	766
91	Requirements and restrictions for combining TrueCopy and HXRC . . . . .	793
92	Host pair status reporting for TrueCopy/ShadowImage shared volumes . . . . .	794
93	Data currency of a shared TrueCopy/ShadowImage volume . . . . .	794
94	TC390 functions. . . . .	799
95	Logical path status . . . . .	830
96	I/O statistics . . . . .	865
97	Optimizing TrueCopy operations and XP128/XP1024 performance . . . . .	869
98	Fence level setting on a TrueCopy M-VOL. . . . .	914
99	Analyzing the currency of TrueCopy Synchronous R-VOLs . . . . .	919
100	Analyzing the consistency of TrueCopy Asynchronous R-VOLs. . . . .	921
101	Selecting the correct timer type for TrueCopy Async disaster recovery. . . . .	923
102	General TrueCopy troubleshooting . . . . .	925
103	Troubleshooting RCU path status problems . . . . .	926
104	Troubleshooting suspended TrueCopy pairs . . . . .	929
105	Resolving TrueCopy Asynchronous suspension conditions . . . . .	931
106	TrueCopy operations versus PPRC TSO and ICKDSF commands. . . . .	935
107	Typographic conventions for PPRC TSO commands . . . . .	938

---

108	CESTPATH LINK parameter for serial and Fibre Channel . . . . .	940
109	SAID values for the CESTPATH LINK parameter . . . . .	941
110	Using CESTPAIR to establish and resume TrueCopy Async pairs . . . . .	942
111	Using CSUSPEND to suspend TrueCopy Async pairs . . . . .	944
112	Using CDELPAIR to delete TrueCopy Async pairs/groups at the MCU . . . . .	945
113	Using CRECOVER to delete TrueCopy Async pairs/groups at the RCU. . . . .	947
114	CQUERY output for serial and Fibre Channel . . . . .	950
115	TrueCopy pair status during CGROUP (FREEZE/RUN) operations . . . . .	955
116	XP128/XP1024 response characteristics to failure conditions . . . . .	963
117	GDPS-TC390-HXRC matrix. . . . .	967
118	TrueCopy control unit SIMs . . . . .	974
119	TrueCopy device SIMs . . . . .	975
120	Functional macro commands for TrueCopy scripting. . . . .	980
121	Internal macro commands for TrueCopy scripting . . . . .	981
122	Syntax description . . . . .	982
123	Script components . . . . .	982
124	Script file requirements . . . . .	983
125	Script symbols . . . . .	983
126	Example of CreateHrcPair parameters . . . . .	986
127	Select device parameters . . . . .	994
128	Internal macro commands . . . . .	995
129	ASCII character codes. . . . .	997
130	If/EndIf comparison symbols . . . . .	997
131	MakeString expression definitions . . . . .	998
132	Work variables. . . . .	1000
133	Reserved result variables . . . . .	1001
134	Reserved status variables. . . . .	1002
135	Syntax requirements for optional parameters . . . . .	1004
136	Error messages. . . . .	1008
137	TrueCopy scripting error codes . . . . .	1009
138	ShadowImage requirements. . . . .	1026
139	Number of Pairs That Can Be Created With Volumes of Each Emulation Type and Capacity . . . . .	1028
140	Reverse and quick restore Pairesync requirements . . . . .	1036
141	Types of ShadowImage options. . . . .	1039
142	Pair status versus allowable operations . . . . .	1045
143	ShadowImage pair status . . . . .	1045
144	Sample table for ShadowImage configuration information. . . . .	1050

---

145	Host pair status reporting for SI390/TC390 shared volumes	1052
146	Currency of a shared SI390 and TC390 volume	1053
147	Displayed information in progress.	1060
148	List of ShadowImage pop-up menu commands	1061
149	ShadowImage status and history reference codes and messages.	1086
150	List of pop-up menu commands for CTG operation	1091
151	PPRC commands	1094
152	TSO command parameters	1095
153	ICKDSF command parameters	1100
154	Restrictions for PPRC commands	1103
155	Accepting PPRC commands	1104
156	PSF command operability for ShadowImage volumes	1105
157	PSF and DEVSERV results for ShadowImage volumes.	1105
158	Pair status reported by the host for volumes in multiple pairs	1109
159	Path status displayed by the CQUERY TSO and PPRCOPY QUERY DSF commands	1110
160	QUIESCE parameter requirements for ShadowImage	1111
161	Parameters of ATSPPLIT command	1114
162	Description of the ATQUERY command examples	1116
163	Requirements for ShadowImage - FlashCopy.	1118
164	ShadowImage - FlashCopy pair status condition	1120
165	Pair Status versus allowable operations.	1120
166	Relationship between L1 pair status and L2 pair operations.	1122
167	Relationship between L2 pair status and L1 pair operations.	1122
168	ShadowImage - FlashCopy and TC390 shared volume	1123
169	ShadowImage - FlashCopy and XRC shared volume	1124
170	PPRC TSO commands.	1127
171	PPRC TSO command parameters	1128
172	Status displayed by FCQUERY command	1130
173	General ShadowImage troubleshooting	1132
174	HCD settings for static and dynamic HPAV	1139
175	Requirements and restrictions for HPAV	1141
176	Ratio of base devices to alias devices	1143
177	Security group icons for SANTinel operations.	1193
178	Add/Change Host window icons	1198
179	Supported volume emulation types	1237
180	LDEV Guard icons	1244
181	Fibre Channel port icons for DBE operations	1258

---

182 RCU path status troubleshooting.....	1283
183 Suspended CA pairs troubleshooting.....	1285
184 CA Async Suspension Conditions.....	1287