

VERITAS NetBackup™ 5.1

Troubleshooting Guide

for UNIX and Windows

Disclaimer

The information contained in this publication is subject to change without notice. VERITAS Software Corporation makes no warranty of any kind with regard to this manual, including, but not limited to, the implied warranties of merchantability and fitness for a particular purpose. VERITAS Software Corporation shall not be liable for errors contained herein or for incidental or consequential damages in connection with the furnishing, performance, or use of this manual.

VERITAS Legal Notice

Copyright © 1998 - 2004 VERITAS Software Corporation. All rights reserved. VERITAS, VERITAS Software, the VERITAS logo, and all other VERITAS product names and slogans are trademarks or registered trademarks of VERITAS Software Corporation. VERITAS, the VERITAS logo, VERITAS NetBackup, NetBackup Troubleshooting Reg. U.S. Pat. & Tm. Off. Other product names and/or slogans mentioned herein may be trademarks or registered trademarks of their respective companies.

Portions of this software are derived from the RSA Data Security, Inc. MD5 Message-Digest Algorithm. Copyright 1991-92, RSA Data Security, Inc. Created 1991. All rights reserved.

VERITAS Software Corporation
350 Ellis Street
Mountain View, CA 94043
USA
Phone 650-527-8000 Fax 650-527-2901
www.veritas.com

Third-Party Copyrights

ACE 5.2A: ACE(TM) is copyrighted by Douglas C.Schmidt and his research group at Washington University and University of California, Irvine, Copyright (c) 1993-2002, all rights reserved.

IBM XML for C++ (XML4C) 3.5.1: Copyright (c) 1999,2000,2001 Compaq Computer Corporation; Copyright (c) 1999,2000,2001 Hewlett-Packard Company; Copyright (c) 1999,2000,2001 IBM Corporation; Copyright (c) 1999,2000,2001 Hummingbird Communications Ltd.; Copyright (c) 1999,2000,2001 Silicon Graphics, Inc.; Copyright (c) 1999,2000,2001 Sun Microsystems, Inc.; Copyright (c) 1999,2000,2001 The Open Group; All rights reserved.

Permission is hereby granted, free of charge, to any person obtaining a copy of this software and associated documentation files (the "Software"), to deal in the Software without restriction, including without limitation the rights to use, copy, modify, merge, publish, distribute, and/or sell copies of the Software, and to permit persons to whom the Software is furnished to do so, provided that the above copyright notice(s) and this permission notice appear in all copies of the Software and that both the above copyright notice(s) and this permission notice appear in supporting documentation.

This product includes software developed by the Apache Software Foundation (<http://www.apache.org/>).

JacORB 1.4.1: The licensed software is covered by the GNU Library General Public License, Version 2, June 1991.

Open SSL 0.9.6: This product includes software developed by the OpenSSL Project * for use in the OpenSSL Toolkit. (<http://www.openssl.org/>)

TAO (ACE ORB) 1.2a: TAO(TM) is copyrighted by Douglas C. Schmidt and his research group at Washington University and University of California, Irvine, Copyright (c) 1993-2002, all rights reserved.



Contents

Preface	ix
Getting Help	x
Related Documentation	xi
Glossary	xii
Accessibility Features	xii
Conventions	xii
Chapter 1. Introduction	1
Define the Problem	1
What was the Error Indication?	1
What Were You Trying to Do When the Problem Occurred?	2
Record All Information	2
Troubleshooting the Problem	4
Problem Report Information	5
General Information	5
Gathering Information for NetBackup - Java	7
Chapter 2. Troubleshooting Procedures	9
Preliminary Troubleshooting	10
Troubleshooting Installation and Configuration Problems	13
To Resolve Installation Problems	13
To Resolve Common Configuration Problems	14
General Test and Troubleshooting Procedures	20
Testing the Master Server and Clients	21



Testing Media Server and Clients	24
Resolving Network Communication Problems	26
Verifying Host Names and Services Entries	34
Using bpcntcmd	37
Using the Host Properties Window	54
Resolving Problems Related to Unavailable Storage Units	55
Changes to the NetBackup Scheduler	55
Changes to bptm	55
Troubleshooting NBU in a SAN Environment	57
NetBackup Enterprise Lifecycle: SPC and Best Practices	57
Using SPC to Troubleshoot NetBackup Issues	58
Common NetBackup Troubleshooting Use Cases	59
Chapter 3. Using Logs and Reports	63
Reports	65
Status for User Operations	66
UNIX System Logs	66
Windows Event Viewer Application Logs	66
Debug Logs	66
Debug Logs on Servers	66
Debug Logs on UNIX Clients	71
Debug Logs on PC Clients	73
Media Manager Logs	77
On UNIX	77
On Windows	78
Windows Event Viewer Logging Option	79
Enabling the Logging Tool	79
eventlog File Entries	80
Example	81
Troubleshooting the Administration Console for UNIX	81



Disk Space Needed for Logging and Temporary Files	82
Enabling Detailed Debug Logging	83
Chapter 4. Using NetBackup Utilities	85
Analysis Utilities for NetBackup Debug Logs	85
Installation Requirements	86
Output Format	86
Limitations	87
How to Run the Log Analysis Utilities	87
NetBackup Configuration Validation Utility (NCVU)	90
When to use NCVU or NCVU_WIN	90
Chapter 5. NetBackup Status Codes and Messages	91
Status Codes	92
Messages	273
Chapter 6. Media Manager Status Codes and Messages	311
Status Codes	311
Media Manager Status Codes	311
Device Configuration Status Codes	401
Format Optical Status Codes	421
Device Management Status Codes	428
Robotic Status Codes	452
Robotic Error Codes	473
Device Diagnostics Status Codes	479
Messages	480
Chapter 7. Disaster Recovery	517
Recommended Backup Practices	518
Master Server Disk Recovery for UNIX	519
Recovering Master Server When Root is Intact	519



Recovering Master Server When Root is Lost	520
Media Server Disk Recovery for UNIX	522
Client System Disk Recovery for UNIX	523
Client System Disk Recovery for Windows Clients	523
Recovering the NetBackup Catalogs for UNIX	524
Identifying the Most Recent Catalog Backup	525
Procedures for Recovering NetBackup Catalogs	527
Master Server Disk Recovery for Windows	535
Recovery When Windows is Intact	535
Total Recovery	538
Media Server Disk Recovery for Windows	541
Client System Disk Recovery for Windows	542
Assumptions	542
Before Starting	542
Recovering a Windows Client Disk	543
Recovering the NetBackup Catalogs for Windows	544
Identifying the Most Recent Catalog Backup	545
Procedures for Recovering NetBackup Catalogs	547
Appendix A. Functional Overview	555
Backup and Restore Functional Description	555
Startup Process	556
Backup and Archive Processes	558
Restore Processes	570
NetBackup Directories and Files	576
NetBackup Programs and Daemons	578
NetBackup Databases	587
Media Manager Functional Description	588
Startup Process	588
Media and Device Management Process	590



Shared Storage Option Management Process	592
Barcode Operations	594
Media Manager Components	596
Appendix B. Networks and Hostnames	607
Appendix C. Robotic Test Utilities	611
Robotic Tests on UNIX	611
Robotic Tests on Windows	613
Index	615





Preface

This guide explains how to isolate and resolve problems encountered when installing, configuring, or using VERITAS NetBackup™. This publication refers to VERITAS NetBackup as NetBackup. This includes coverage for Media Manager, a component of NetBackup used for media and device management.

What Is In This Manual?

This guide is intended primarily for the system administrator who is responsible for installing, configuring, and managing NetBackup. The system administrator is assumed to have a good working knowledge of both NetBackup and the operating system. Some sections will also be useful to less-technical users who encounter problems when backing up, archiving, or restoring files.

- ◆ Chapter 1, [Introduction](#), explains how to define a problem and describes the information you should gather during troubleshooting. Both administrators and client users should read this chapter first.
- ◆ Chapter 2, [Troubleshooting Procedures](#), includes procedures for isolating the problem to a specific area.
- ◆ Chapter 3, [Using Logs and Reports](#), discusses the NetBackup logs and how to interpret them.
- ◆ Chapter 4, [Using NetBackup Utilities](#), describes the Analysis Utilities for the NetBackup debug logs, and the NetBackup Configuration Validation utility.
- ◆ Chapter 5, [NetBackup Status Codes and Messages](#), explains each NetBackup status code and provides corrective actions for error conditions.
- ◆ Chapter 6, [Media Manager Status Codes and Messages](#), explains each Media Manager status code and provides corrective actions for error conditions.
- ◆ Chapter 7, [Disaster Recovery](#), provides information about installing NetBackup and recovering NetBackup catalogs after a system disk failure.
- ◆ Appendix A, [Functional Overview](#), provides a functional overview of NetBackup and its Media Manager component, for both Windows and UNIX.



- ◆ Appendix B, [Networks and Hostnames](#), provides information useful when configuring NetBackup on a host with multiple network connections and when hosts have multiple names.
- ◆ Appendix C, [Robotic Test Utilities](#), explains how to start the tests that are included with the robotic software.

Getting Help

VERITAS offers you a variety of support options.

Accessing the VERITAS Technical Support Web Site

The VERITAS Support Web site allows you to:

- ◆ obtain updated information about NetBackup, including system requirements, supported platforms, and supported peripherals
- ◆ contact the VERITAS Technical Support staff and post questions to them
- ◆ get the latest patches, upgrades, and utilities
- ◆ view the NetBackup Frequently Asked Questions (FAQ) page
- ◆ search the knowledge base for answers to technical support questions
- ◆ receive automatic notice of product updates
- ◆ find out about NetBackup training
- ◆ read current white papers related to NetBackup

The address for the VERITAS Technical Support Web site follows:

- ◆ <http://support.veritas.com>

Subscribing to VERITAS Email Notification Service

Subscribe to the VERITAS Email notification service to be informed of software alerts, newly published documentation, Beta programs, and other services.

Go to <http://support.veritas.com>. Select a product and click “E-mail Notifications” on the right side of the page. Your customer profile ensures you receive the latest VERITAS technical information pertaining to your specific interests.

Accessing VERITAS Telephone Support

Telephone support for NetBackup is only available with a valid support contract. To contact VERITAS for technical support, dial the appropriate phone number listed on the Technical Support Guide included in the product box and have your product license information ready for quick navigation to the proper support group.

▼ To locate the telephone support directory on the VERITAS web site

1. Open <http://support.veritas.com> in your web browser.
2. Click the **Phone Support** icon. A page that contains VERITAS support numbers from around the world appears.

Accessing VERITAS E-mail Support

▼ To contact support using E-mail on the VERITAS web site

1. Open <http://support.veritas.com> in your web browser.
2. Click the **E-mail Support** icon. A brief electronic form will appear and prompt you to:
 - ◆ Select a language of your preference
 - ◆ Select a product and a platform
 - ◆ Associate your message to an existing technical support case
 - ◆ Provide additional contact and product information, and your message
3. Click **Send Message**.

Contacting VERITAS Licensing

For license information call 1-800-634-4747 option 3, fax 1-650-527-0952, or e-mail amercustomer@veritas.com.

Related Documentation

Refer to the *NetBackup Release Notes* for a complete list of NetBackup manuals.



Glossary

If you encounter unfamiliar terminology, consult the NetBackup online glossary. The glossary contains terms and definitions for NetBackup and all additional NetBackup options and agents.

The NetBackup online glossary is included in the NetBackup help file.

▼ To access the NetBackup online glossary

1. In the NetBackup Administration Console, click **Help > Help Topics**.
2. Click the **Contents** tab.
3. Click **Glossary of NetBackup Terms**.

Use the scroll function to navigate through the glossary.

Accessibility Features

NetBackup contains features that make the user interface easier to use by people who are visually impaired and by people who have limited dexterity. Accessibility features include:

- ◆ Support for assistive technologies such as screen readers and voice input (Windows servers only)
- ◆ Support for keyboard (mouseless) navigation using accelerator keys and mnemonic keys

For more information, see the *NetBackup System Administrator's Guide for Windows, Volume I* or the *NetBackup System Administrator's Guide for UNIX, Volume I*.

Conventions

The following conventions apply throughout the documentation set.

Product-Specific Conventions

The following term is used in the NetBackup 5.1 documentation to increase readability while maintaining technical accuracy.

- ◆ Microsoft Windows, Windows

Terms used to describe a specific product or operating system developed by Microsoft, Inc. Some examples you may encounter in NetBackup documentation are, Windows servers, Windows 2000, Windows Server 2003, Windows clients, Windows platforms, or Windows GUI.

When Windows or Windows servers is used in the documentation, it refers to all of the currently supported Windows operating systems. When a specific Windows product is identified in the documentation, only that particular product is valid in that instance.

For a complete list of Windows operating systems and platforms that NetBackup supports, refer to the *NetBackup Release Notes for UNIX and Windows* or go to the VERITAS support web site at <http://www.support.veritas.com>.

Typographical Conventions

Here are the typographical conventions used throughout the manuals:

Conventions

Convention	Description
GUI Font	Used to depict graphical user interface (GUI) objects, such as fields, listboxes, menu commands, and so on. For example: Enter your password in the Password field.
<i>Italics</i>	Used for placeholder text, book titles, new terms, or emphasis. Replace placeholder text with your specific text. For example: Replace <i>filename</i> with the name of your file. Do <i>not</i> use file names that contain spaces. This font is also used to highlight NetBackup server-specific or operating system-specific differences. For example: <i>This step is only applicable for NetBackup Enterprise Server.</i>
Code	Used to show what commands you need to type, to identify pathnames where files are located, and to distinguish system or application text that is displayed to you or that is part of a code example.
Key+Key	Used to show that you must hold down the first key while pressing the second key. For example: Ctrl+S means hold down the Ctrl key while you press S.

You should use the appropriate conventions for your platform. For example, when specifying a path, use backslashes on Microsoft Windows and slashes on UNIX. Significant differences between the platforms are noted in the text.

Tips, notes, and cautions are used to emphasize information. The following samples describe when each is used.



Tip Used for nice-to-know information, like a shortcut.

Note Used for important information that you should know, but that shouldn't cause any damage to your data or your system if you choose to ignore it.

Caution Used for information that will prevent a problem. Ignore a caution at your own risk.

Command Usage

The following conventions are frequently used in the synopsis of command usage.

brackets []

The enclosed command line component is optional.

Vertical bar or pipe (|)

Separates optional arguments from which the user can choose. For example, when a command has the following format:

```
command arg1|arg2
```

In this example, the user can use either the *arg1* or *arg2* variable.

Navigating Multiple Menu Levels

When navigating multiple menu levels, a greater-than sign (>) is used to indicate a continued action.

The following example shows how the > is used to condense a series of menu selections into one step:

❖ Select **Start > Programs > VERITAS NetBackup > NetBackup Administration Console**.

The corresponding actions could be described in more steps as follows:

1. Click **Start** in the task bar.
2. Move your cursor to **Programs**.
3. Move your cursor to the right and highlight **VERITAS NetBackup**.
4. Move your cursor to the right. First highlight and then click **NetBackup Administration Console**.

This chapter explains the basic steps to take if you encounter a problem while using NetBackup. Other chapters provide more specific information.

Note The term *media server*, as distinct from *master server* or *server*, may or may not apply to the NetBackup Server product and depends on the context. When troubleshooting a Server installation, be aware that there is only one host. - the master and media server are one and the same. References to a media server on a different host can be ignored.

Define the Problem

The first step in troubleshooting is to define the problem.

What was the Error Indication?

In defining the problem, you must know what went wrong and sometimes resolving the problem also requires that you also know what went right.

Error messages are usually the vehicle for telling you something went wrong. So the first thing to do is look for an error message. If you don't see an error message in an interface, but still suspect a problem, check the reports and logs. NetBackup provides extensive reporting and logging facilities and these can provide an error message that points you directly to a solution.

The logs also show you what went right and what NetBackup was doing when the problem occurred. For example, a restore can be waiting for media to be mounted and the required media is currently in use for another backup.

The [“Using Logs and Reports”](#) chapter describes the log information that NetBackup provides. The [“NetBackup Status Codes and Messages”](#) and [“Media Manager Status Codes and Messages”](#) chapters provide interpretations of NetBackup (and Media Manager) status codes and messages.



What Were You Trying to Do When the Problem Occurred?

Another important part of defining the problem is to clearly define what you were trying to do in the first place.

Some questions to ask here are:

- ◆ What operation was being attempted?
- ◆ What method were you using? For example, there is more than one way to install software on a client. There is also more than one possible interface to use for many operations and some operations can even be performed with a script.
- ◆ What type of server platform and operating system was involved?
- ◆ If your site uses both master and media servers, was it a master or a media server?
- ◆ If a client was involved, what type of client was it?
- ◆ Have you ever performed the operation successfully in the past? If so, what is different now?
- ◆ What is the service pack level?
- ◆ Are you using operating system software with the latest fixes supplied, especially those required for use with NetBackup?
- ◆ Is your device firmware at a level, or higher than the level, at which it has been tested according to the posted device compatibility lists?

Record All Information

As you define and troubleshoot a problem, always try to capture potentially valuable information, such as:

- ◆ NetBackup progress logs
- ◆ NetBackup Reports
- ◆ NetBackup Utility Reports
- ◆ NetBackup debug logs
- ◆ Media Manager debug logs
- ◆ On UNIX NetBackup servers, check for error or status messages in the system log or standard output
- ◆ Error or status messages in dialogs
- ◆ On Windows NetBackup servers, check for error or status information in the Event Viewer Application log

- ◆ Check for error or status information in the Event Viewer Application log

Record this information for each attempt. A benefit of this approach is that you can compare the results of multiple attempts. It is also useful for others at your site and for customer support in the event that you cannot solve the problem yourself.

The “[Using Logs and Reports](#)” chapter explains the various logs.

On UNIX systems, the `/usr/opensv/netbackup/bin/goodies/support` script creates a file containing data necessary for customer support to debug any problems you encounter. For more details, consult the usage information of the script by using `support -h`.

If your troubleshooting attempt is unsuccessful, customer support can provide further assistance. Before calling, have the following information ready.

- ◆ Product, platform, and device information:
 - ◆ Product and its release level.
 - ◆ Server hardware type and operating system level.
 - ◆ Client hardware type and operating system level, if a client is involved.
 - ◆ Storage units being used, if it is possible that storage units are involved.
 - ◆ If it looks like a device problem, be ready to supply device information, such as the types of robots and drives, and their version levels along with Media Manager and system configuration information.
 - ◆ Software patches to the products that were installed.
 - ◆ Service packs and hotfixes that were installed.
- ◆ What is the definition of the problem as described earlier in this chapter? Copies of logs or core dumps (if any) can also be required.
- ◆ Have you had this problem before? If so, was there a successful resolution and what did you try that time?
- ◆ Has the configuration been changed recently and, if so, what was changed?
- ◆ If necessary, can you communicate with technical support through `ftp`, email, or fax? This can be useful for sending things such as copies of logs.

“[Problem Report Information](#)” on page 5 lists the information you need and also provides methods for gathering information.



Troubleshooting the Problem

After defining the problem, use the information in the other chapters of this manual to try and correct it.

- ◆ When you have a status code or message, proceed directly to “[NetBackup Status Codes and Messages](#)” or “[Media Manager Status Codes and Messages](#)” and try the corrective actions recommended there.
- ◆ When you do not see a status code or message, or the actions in “[NetBackup Status Codes and Messages](#)” or “[Media Manager Status Codes and Messages](#)” do not solve the problem, try the troubleshooting procedures in the “[Troubleshooting Procedures](#)” chapter. Those procedures describe an effective approach for isolating common problems.

If you don't find the solution, obtain assistance by contacting customer support.



Problem Report Information

General Information

Date: _____

Servers (master and media):

Table 1

Platform Types and Host Names	OS Levels	Product Version and Patch Levels

Clients:

Table 2

Platform Types and Host Names	OS Levels	Product Version and Patch Levels



Devices:

Table 3

Robotic Library and Drive Models	Firmware Levels	Firmware Level Listed as “Tested” in the VERITAS Device Compatibility Lists at www.support.veritas.com
---	------------------------	--

What were you attempting when the problem occurred? (for example, a backup on a Windows client)

What were the error indications? (for example, status code, error dialog box)

Did this occur during or shortly after any of the following:

- Initial Installation
- Configuration change (explain)
- System change or problem (explain)
- Have you seen the problem before: (if so, what did you do that time)

Logs or other failure data you have saved:

- All log entries report



- Media Manager debug logs
- NetBackup debug logs
- System logs (UNIX)
- NetBackup Configuration Validation Utility Output (UNIX)
- Event Viewer Application logs (Windows)

Can you communicate with us through any of the following:

- ftp
- telnet
- email
- fax

Gathering Information for NetBackup - Java

If you encounter problems with the NetBackup-Java applications, use the following methods to gather data for VERITAS support.

The following scripts are available for gathering information:

- ◆ The NetBackup-Java administration application startup script, `jnbSA`, logs data to a log file in `/usr/opensv/java/logs`. At startup, the script tells you which file in this directory it is logging to. Normally, this file does not become very large (usually less than 2 KB). Consult the file `/usr/opensv/java/Debug.properties` for options that can affect the contents of this log file.
- ◆ The `/usr/opensv/java/get_trace` script provides a Java virtual machine stack trace for support to analyze. This stack trace is written to the log file associated with the instance of execution (see previous bullet).
- ◆ The `/usr/opensv/netbackup/bin/goodies/support` script creates a file containing data necessary for customer support to debug any problems you encounter. For more details, consult the usage information of the script by using `support -h`.



Follow these steps to get debug data for VERITAS support to analyze:

1. If the application does not respond for a long time, it may be hung. However, some operations can take quite a while to complete. This is especially true in the Activity Monitor and Reports applications. So, wait for several minutes before assuming the operation is hung.

If there is no response within several minutes, execute

`/usr/opensv/java/get_trace` under the account where you started the Java application. This causes a stack trace to be written to the log file.

For example, if you started `jnbSA` from the root account, start

`/usr/opensv/java/get_trace` as root. Otherwise, the command executes without error, but fails to add the stack trace to the debug log. This occurs because root is the only account that has permission to execute the command that dumps the stack trace.

2. Execute `/usr/opensv/netbackup/bin/goodies/support` to get data about your configuration. Execute this script after completing NetBackup installation and each time after you change the NetBackup configuration.
3. Provide the support-script output and log file to VERITAS support.

This chapter has procedures for finding the cause of NetBackup errors. These procedures are general in nature and do not attempt to cover every problem that could occur. They do, however, recommend methods that usually result in successful problem resolution.

When performing these procedures, try each step in sequence. If you have already performed the action or it does not apply, skip to the next step. If it branches you to another chapter, use the solutions suggested there. If you still have a problem, go to the next step in the procedure. Also, alter your approach based on your specific configuration and what you have already tried.

The information in this chapter is divided into three sections:

- ◆ [Preliminary Troubleshooting](#)
- ◆ [Troubleshooting Installation and Configuration Problems](#)
- ◆ [General Test and Troubleshooting Procedures](#)
- ◆ [Troubleshooting NBU in a SAN Environment](#)

Start with “[Preliminary Troubleshooting](#).” This explains what to check first and then branches off to other procedures as appropriate. “[Troubleshooting Installation and Configuration Problems](#)” applies specifically to installation and configuration problems. “[General Test and Troubleshooting Procedures](#)” defines general methods for finding server and client problems and should be used last.

Note The term *media server*, as distinct from *master server* or *server*, does not apply to the NetBackup Server product. When troubleshooting a NetBackup Server installation, please ignore any references to media server.



Preliminary Troubleshooting

▼ **If you are having problems with NetBackup, perform this procedure first.**

1. Ensure that your servers and clients are running supported operating system versions and the peripherals you are using (if any) are supported. See the NetBackup release notes and the NetBackup device compatibility lists on www.veritas.com for this information.
2. Check for status codes or messages.

- a. Use the All Log Entries report and check for NetBackup errors for the appropriate time period. This report can show the context in which the error occurred and can often provide specific information that is useful when the status code can result from a variety of problems.

If the problem involved a backup or archive, check the Backup Status report. This report gives you the status code.

If you find a status code or message in either of the above reports, go to the chapter titled [“NetBackup Status Codes and Messages”](#) or [“Media Manager Status Codes and Messages”](#) and perform the recommended corrective actions.

- b. If the problem pertains to media or device management and either NetBackup does not provide a status code or you cannot correct the problem by following the instructions in [“NetBackup Status Codes and Messages”](#) or [“Media Manager Status Codes and Messages”](#), check the system log on UNIX servers, or the Event Viewer Application log on Windows servers. This log can show the context in which the error occurred and the error messages are usually descriptive enough to point you to a problem area.
- c. Check applicable debug logs that are enabled and correct problems you detect.
If these logs are not enabled, enable them before retrying the failed operation (see the [“Using Logs and Reports”](#) chapter).
- d. If you performed corrective actions, retry the operation. If you did not perform corrective actions or the problem persists, go to [step 3](#) below.

3. If you encountered the problem:
 - ◆ During a new installation
 - ◆ During an upgrade installation
 - ◆ After making changes to an existing configuration

Then, go to [“Troubleshooting Installation and Configuration Problems”](#) on page 13.



4. Ensure that the server and client are operational.

If the server or client disk crashed, refer to the “[Disaster Recovery](#)” chapter for procedures on recovering files that are critical to NetBackup operation.

Verify there is enough space available in the disk partitions that NetBackup uses. If one or more of these partitions is full, NetBackup processes that access the full partition will fail. The resulting error message depends on the process but you could see messages such as “unable to access” or “unable to create or open a file.”

On UNIX systems, use the `df` command to view disk partition information. On Windows systems, use Disk Manager or Explorer.

Check the following disk partitions:

- ◆ The partition where NetBackup software is installed.
 - ◆ On the NetBackup master or media server, the partition where the NetBackup (or Media Manager) databases reside.
 - ◆ The partition where the NetBackup processes write temporary files.
 - ◆ The partition where NetBackup logs are stored.
 - ◆ The partition where the operating system is installed.
- 5.** Enable verbose logging either for everything or just for areas you think are related to the problem. See the “[Using Logs and Reports](#)” chapter for information on verbose logging.
- 6.** Determine which daemons or processes are running. Follow the procedures below for UNIX or Windows NetBackup servers.

On UNIX NetBackup servers

- ◆ Execute:

```
/usr/openv/netbackup/bin/bpps -a
```
- a.** If either the NetBackup request daemon (`bprd`) or database manager daemon (`bpdbm`) are not running, execute this command to start them:

```
/usr/openv/netbackup/bin/initbprd
```
- b.** If any of the following media and device management processes are not running:
 - ◆ `ltid` (device; `ltid` only needs to be running if drives are configured on the server)
 - ◆ `vmd` (volume)
 - ◆ `avrd` (automatic volume recognition)



- ◆ processes for all configured robots

Stop the device daemon, `ltid`, by executing:

```
/usr/opensv/volmgr/bin/stoptlid
```

Verify that the `ltid`, `avrd`, and robotic control daemons have been stopped by executing:

```
/usr/opensv/volmgr/bin/vmps
```

Note If you are using ACS robotic control, the `acsssi` and `acsse1` processes will remain running when `ltid` is stopped. For more information about stopping these daemons, refer to the Automated Cartridge System (ACS) Appendix in the *NetBackup Media Manager System Administrator's Guide*.

Stop any robot control daemons that remain running when `ltid` is terminated. Then, start all daemons by executing:

```
/usr/opensv/volmgr/bin/ltid
```

For debugging, it is best to start `ltid` with the `-v` (verbose) option.

On Windows NetBackup servers

- a. Use the NetBackup Activity Monitor, or the Services application in the Windows Control Panel, to start the following services if they are not running:

Note To start all of them, execute `install_path\NetBackup\bin\bpup.exe`.

On NetBackup master servers:

- ◆ NetBackup Request Manager service
- ◆ NetBackup Database Manager service
- ◆ NetBackup Device Manager service (if the system has devices configured)
- ◆ NetBackup Volume Manager service
- ◆ NetBackup Client service

On NetBackup media servers:

- ◆ NetBackup Device Manager service (if the system has devices configured)
- ◆ NetBackup Volume Manager service
- ◆ NetBackup Client service

On NetBackup clients (including NetBackup Remote Administration Consoles)

- ◆ NetBackup Client service

- b. Use the NetBackup Activity Monitor to see if the following Media Manager processes are running:

- ◆ avrd (automatic media recognition)
- ◆ Processes for all configured robots (see the *Media Manager System Administrator's Guide for Windows*)

If the above processes are not running, stop and then restart the NetBackup Device Manager service by using the NetBackup Activity Monitor or the Services application in the Windows Control Panel.

- 7. If you had to start any of the processes or services in the previous steps, retry the operation. If they are running or the problem persists, go to [“General Test and Troubleshooting Procedures”](#) on page 20.

If you cannot start any of these processes or services, check the appropriate debug logs (see the [“Using Logs and Reports”](#) chapter) for NetBackup problems.

When started, these processes and services continue to run unless you stop them manually or there is a problem with the system. On Windows systems, we recommend you add commands for starting them to your startup scripts, so they are restarted in case you have to reboot.

Troubleshooting Installation and Configuration Problems

This section outlines steps to resolve installation and common configuration issues.

To Resolve Installation Problems

Note Before you install or use NetBackup on a Linux client, verify that the `inetd` (or `xinetd`) service is started on that machine. This will ensure proper communication between the NetBackup master and the Linux client.

▼ To resolve installation and configuration issues, ask these questions

- 1. Could you install the software on the master and media servers by using the release media?

Some reasons for failure could be:

- ◆ Not logged in as an Administrator on a Windows system (you must have permission to install services on the system)



- ◆ Permission denied (ensure you have permission to use the device and to write the directories and files being installed)
- ◆ Bad media (contact customer support)
- ◆ Defective drive (replace the drive or refer to vendor's hardware documentation)
- ◆ Improperly configured drive (refer to system and vendor documentation)

2. Could you install NetBackup client software on the clients?

Note You cannot install PC client software from a UNIX NetBackup server.

- ◆ For an install to a trusting UNIX client, verify that you have the correct client name in your policy configuration and the correct server name in the client `.rhosts` file.

If the install hangs, check for problems with the shell or environment variables for the root user on the client. The files to check depend on the platform, operating system, and shell you are using. An example for a Sun system would be if your `.login` executes an `stty` (such as `stty ^erase`) before defining your terminal type. If this caused the install process to hang, you could modify the `.login` file to define the terminal before executing the `stty` or you could move the client `.login` to another file until the install is complete.

- ◆ For an install to a secure UNIX client, check your `ftp` configuration. For example, you must be using a user name and password that the client considers valid.

3. For general network communications problems, go to [“Resolving Network Communication Problems”](#) on page 26.

To Resolve Common Configuration Problems

If this is an initial installation or if you have changed the configuration, check for these problems before proceeding:

Note On platforms that support the NetBackup Configuration Validation Utility (NCVU), run this utility against the NetBackup nodes in question and note any warnings that are generated.

▼ To resolve configuration issues, check for these problems

1. Check for the following device configuration problems:
 - ◆ Configuration for robotic drive does not specify the robot.
 - ◆ Drive is configured as wrong type or density.

- ◆ Incorrect Robotic Drive Number.
- ◆ SCSI ID for the robotic control is specified instead of the logical Robot Number assigned to the robot.
- ◆ The same robot number is used for different robots.
- ◆ SCSI ID for the drive is specified instead of a unique Drive Index number.
- ◆ A platform does not support a device or was not configured to recognize it.
- ◆ Robotic device is not configured to use LUN 1, which is required by some robot hardware.
- ◆ On UNIX, drive no-rewind device path is specified as a rewind path.
- ◆ On UNIX, tape devices are not configured with “Berkeley style close.”
This is configurable on some platforms and is required by NetBackup (see the *Media Manager Device Configuration Guide* for more information).
- ◆ On UNIX, tape devices (other than QIC) are not configured as “variable mode.”
This is configurable on some platforms and is required by NetBackup.
When this condition exists, you can frequently perform backups but not restores. “NetBackup Status Code: 174” in the “NetBackup Status Codes and Messages” chapter provides further explanation. Also see the *Media Manager Device Configuration Guide*.
- ◆ On UNIX, pass-through paths to the tape drives have not been established. Also see the *Media Manager Device Configuration Guide*.

2. Check for the following problems with the daemons or services:

- ◆ Daemons or services do not start during reboot (configure system so this occurs).
- ◆ Wrong daemons or services are started (problems with media server start up scripts).
- ◆ Configuration was changed while daemons or services were running.
- ◆ On Windows, the %SystemRoot%\System32\drivers\etc\services file does not have an entry for vmd, bprd, bpdbrm and bpcd. Also, ensure there are entries for the processes for configured robots (see the *Media Manager System Administrator’s Guide for Windows* for a list of these processes).
- ◆ On UNIX, the /etc/services file (or NIS or DNS) does not have an entry for vmd, bprd, bpdbrm, or robotic daemons.

3. If you found and corrected any configuration problems, retry the operation and check for NetBackup status codes or messages.



- a. Check the All Log Entries report for NetBackup errors for the appropriate time period. This report can show the context in which the error occurred and can often have specific information that is useful when the error can result from a variety of problems.

If the problem involved a backup or archive, check the Backup Status report. This report gives you the status code.

If you find a status code or message in either the Backup Status or All Log Entries report, go to the “[NetBackup Status Codes and Messages](#)” chapter or “[Media Manager Status Codes and Messages](#)” chapter and perform the recommended corrective actions.

- b. If the problem pertains to device or media management and either NetBackup does not provide a status code or you cannot correct the problem by following the instructions in status codes chapters, check the system log on UNIX systems, or the Event Viewer Application log on Windows systems for NetBackup entries.
- c. Check appropriate debug logs that are enabled and correct problems you detect. If these logs are not enabled, enable them before your next attempt. For more information, see the “[Using Logs and Reports](#)” chapter.
- d. If you performed corrective actions as a result of [step a](#) through [step c](#), retry the operation. If you did not perform corrective actions or the problem persists, go to the next section, “[General Test and Troubleshooting Procedures](#).”

To Resolve Device Configuration Problems

Certain auto-configuration warning messages are displayed in the second panel of the Device Configuration wizard if the selected device meets any of the following conditions:

- ◆ Not licensed for NetBackup Server
- ◆ Exceeds a license restriction
- ◆ Has inherent qualities that make it difficult to auto-configure

These are the messages relating to device configuration, along with explanations and recommended actions:

Message: Drive does not support serialization

Explanation: The drive does not return its serial number. Note that some manufacturers do not support serial numbers. Although automatic device configuration will not function optimally, the drive can be manually configured and operated without its serial number.

Recommended Action: Ask the manufacturer for a newer firmware version that returns serial numbers (if available), or manually configure and operate the drive without a serial number.

Message: Robot does not support serialization

Explanation: The robot does not return its serial number or the serial numbers of the drives contained within it. Note that some manufacturers do not support serial numbers. Although automatic device configuration will not function optimally, the robot and/or drives can be manually configured and operated without serial numbers.

Recommended Action: Ask the manufacturer for a newer firmware version that returns serial numbers (if available), or manually configure and operate the robot and/or drives without serial numbers.

Message: Too many drives in robot

Explanation: The robotic library has more than two installed drives—the maximum allowed with a NetBackup Server license.

Recommended Action: Remove all but two drives.

Message: Too many slots in robot

Explanation: The robotic library has more than 30 installed slots—the maximum allowed with a NetBackup Server license.

Recommended Action: If possible, configure the robotic library to have 30 or fewer slots. Only use robotic libraries that are supported with NetBackup Server.

Message: No license for this robot type

Explanation: The robotic type defined for this robot is not supported by NetBackup Server.

Recommended Action: Define a different robot. Only use robotic libraries that are supported with NetBackup Server.

Message: No license for this drive type

Explanation: The drive type defined for this drive is not supported by NetBackup Server.

Recommended Action: Define a different drive. Only use drives that are supported by NetBackup.



Message: Unable to determine robot type

Explanation: The robotic library is not recognized by NetBackup. The robotic library cannot be auto-configured.

Recommended Action:

1. Download a new device_mapping file from the VERITAS support web site, and try again.
2. Configure the robotic library manually.
3. Use only robotic libraries that are supported by NetBackup.

Message: Drive is standalone or in unknown robot

Explanation: Either the drive is standalone, or the drive or robot is not returning a serial number. Note that some manufacturers do not support serial numbers. Although automatic device configuration will not function optimally, the drive or robot can be manually configured and operated without a serial number.

Recommended Action: Ask the manufacturer for a newer firmware version that returns serial numbers (if available), or manually configure and operate the drive/robot without serial numbers.

Message: Robot drive number is unknown

Explanation: Either the drive or robot is not returning a serial number. Note that some manufacturers do not support serial numbers. Although automatic device configuration will not function optimally, the drive or robot can be manually configured and operated without a serial number.

Recommended Action: Ask the manufacturer for a newer firmware version that returns serial numbers (if available), or manually configure and operate the drive/robot without serial numbers.

Message: Drive exceeds drive limit

Explanation: The NetBackup Server license allows a maximum of two drives and two drives have already been configured.

Recommended Action: To use this drive, a previously configured drive must be disabled (deleted from the device configuration).

Message: Robot exceeds robot limit

Explanation: A robotic library has already been configured.

Recommended Action: To use this robot, a previously configured robot must be disabled (deleted from the device configuration).

Message: Drive is in an unlicensed robot

Explanation: The drive is in a robotic library that cannot be licensed for NetBackup Server. Since the robot cannot be licensed for NetBackup Server, any drives configured in that robot are unusable.

Recommended Action: Configure a drive that does not reside in the unlicensed robot.

Message: Drive's scsi adapter does not support pass-thru (or pass-thru path does not exist)

Explanation: A drive was found that does not have a SCSI pass-through path configured. There are two possible causes for this message:

- ◆ The drive is connected to an adapter that does not support SCSI pass-through.
- ◆ The pass-through path for this drive has not been defined.

Recommended Action: Change the drive's adapter, or define a pass-through path for the drive. See the *Media Manager Device Configuration Guide* for scsi adapter pass-through information.

Message: No configuration device file exists

Explanation: A device has been detected without the corresponding device file necessary to configure that device.

Recommended Action: Refer to the chapter for your system type in the *Media Manager Device Configuration Guide* for information on creating device files.

Message: Unable to determine drive type

Explanation: The drive is not recognized by NetBackup Server. The drive cannot be auto-configured.



Recommended Action:

1. Download a new device_mapping file from the VERITAS support web site, and try again.
2. Configure the drive manually.
3. Use only drives that are supported by NetBackup.

Message: Unable to determine compression device file

Explanation: A drive has been detected without the expected compression device file used to configure that device. Automatic device configuration attempts to use a device file that supports hardware data compression. When multiple compression device files exist for a drive, automatic device configuration cannot determine which compression device file is best. It uses a non-compression device file instead.

Recommended Action: If you do not need hardware data compression, no action is necessary. The drive can be operated without hardware data compression. If you need hardware data compression, refer to the chapter for your system type in the *Media Manager Device Configuration Guide* for information on configuring tape drives.

General Test and Troubleshooting Procedures

If the “[Preliminary Troubleshooting](#)” or “[Troubleshooting Installation and Configuration Problems](#)” procedures did not reveal the problem, perform the following procedures, skipping those steps that you have already performed.

The procedures assume that the software was successfully installed, but not necessarily configured correctly. If NetBackup or Media Manager has never worked properly, there are probably configuration problems. Repeat the checks mentioned in the “[Troubleshooting Installation and Configuration Problems](#)” procedure when you encounter errors. In particular, look for device configuration problems.

You may also want to perform each backup and restore twice. On UNIX, perform them first as a root user and then as a nonroot user. On Windows, perform them first as a user that is a member of the Administrators group and then as a user that is not a member of the Administrator group. In all cases, ensure that you have read and write permissions on the test files.

The explanations in these procedures assume that you are familiar with the information in the “[Functional Overview](#)” appendix. If you have not read that appendix, do so before proceeding.



Testing the Master Server and Clients

▼ To test the master server and clients

1. Enable appropriate debug logs on the master server (see the “[Using Logs and Reports](#)” chapter). If you do not know which logs apply, enable them all until you solve the problem. Delete the debug log directories when you have resolved the problem.
2. Configure a test policy (set backup window to be open while you are testing). Name the master server as the client and a storage unit that is on the master server (preferably a nonrobotic drive). Also, configure a volume in the NetBackup volume pool and insert the volume in the drive. If you don’t label the volume by using the `bplabel` command, NetBackup automatically assigns a previously unused media ID.
3. Verify that the NetBackup daemons or services are running on the master server:
 - ◆ To check the daemons on a UNIX system, execute:

```
/usr/openv/netbackup/bin/bpps -a
```
 - ◆ To check the services on a Windows system, use the NetBackup Activity Monitor or the Services application in the Windows Control Panel.
4. Start a manual backup of a policy by using the manual backup option in the NetBackup administration interface. Then, restore the backup.

This verifies:

- ◆ NetBackup server software is functional, including all daemons or services, programs, and databases.
- ◆ Media Manager can mount the media and use the drive you configured.

If a failure occurs, first check the NetBackup All Log Entries report. For failures relating to drives or media, verify that the drive is in an UP state and the hardware is functioning.

To further isolate the problem, use the debug logs. The “[Functional Overview](#)” appendix explains the basic sequence of events (log messages are more detailed than the information in that appendix).

If the debug logs do not reveal the problem, check the following:

- ◆ Systems Logs or Event Viewer System logs
- ◆ Event Viewer Application logs on Windows systems
- ◆ `vmd` debug logs on the volume database host for the device
- ◆ `bptm` debug logs



See the vendor manuals for information on hardware failures.

If you are using a robot and this is an initial configuration, verify that the robotic drive is configured correctly. In particular, verify that:

- ◆ The same robot number is used both in the Media Manager and storage unit configurations.
- ◆ Each robot has a unique robot number.

On a UNIX NetBackup server, you can verify only the Media Manager part of the configuration, by using the `tpreq` command to request a media mount. Verify that the mount completes and check which drive the media was mounted on. Repeat the process until the media has been mounted and unmounted on each drive from the host where the problem was occurring. If this works, the problem is probably with the policy or storage unit configuration. When you are done, `tpunmount` the media.

5. If you previously configured a nonrobotic drive and your system includes a robot, change your test policy now to specify a robot. Add a volume to the robot. The volume must be in the NetBackup volume pool on the volume database host for the robot.

Repeat this procedure starting with [step 3](#), but this time for the robot. This verifies that Media Manager can find the volume, mount it, and use the robotic drive.

If you have difficulties with the robot, try the test utilities described in the “[Robotic Test Utilities](#)” appendix.

Note Do not use the Robotic Test Utilities when backups or restores are active. These utilities prevent the corresponding robotic processes from performing robotic actions, such as loading and unloading media. This can cause media mount timeouts and prevent other robotic operations like robotic inventory and inject/eject from working.

6. Add a user schedule to your test policy (the backup window must be open while you are testing). Use a storage unit and media that has been verified in previous steps.
7. Start a user backup and restore of a file by using the client-user interface on the master server. Monitor the status/progress log for the operation. If successful, this operation verifies that client software is functional on the master server.

If a failure occurs, check the NetBackup All Log Entries report. To further isolate the problem, check the appropriate debug logs from those listed below. The “[Using Logs and Reports](#)” chapter explains which logs apply to specific client software.

Note These logs exist only if you enabled debug logging in [step 1](#). On a UNIX system, the debug logs are in the `/usr/opensv/netbackup/logs/` directory. On a Windows system, the debug logs are in the `install_path\NetBackup\logs\` directory.

- ◆ `bparchive` (UNIX only)
 - ◆ `bpbackup` (UNIX only)
 - ◆ `bpbkar`
 - ◆ `bpcd`
 - ◆ `bplist`
 - ◆ `bprd`
 - ◆ `bprestore`
 - ◆ `nbwin` (Windows only)
 - ◆ `bpinetd` (Windows NT/2000, XP and 2003 only)
8. Reconfigure your test policy to name a client that is located elsewhere in the network. Use a storage unit and media that has been verified in previous steps. If necessary, install the NetBackup client software.
9. Create debug log directories for the processes listed below. The “[Using Logs and Reports](#)” chapter explains which logs apply to specific client types.
- ◆ `bprd` on the server
 - ◆ `bpcd` on the client
 - ◆ `bpbkar` on the client
 - ◆ `nbwin` on the client (Windows only)
 - ◆ `bpbackup` on the client (except Windows clients)
 - ◆ `bpinetd` (Windows NT/2000, XP and 2003 only)
10. Perform a user backup and then a restore from the client specified in [step 8](#). This verifies:
- ◆ Communications between the client and master server
 - ◆ NetBackup software on the client
- If an error occurs, check the following:
- ◆ All Log Entries report
 - ◆ Debug logs created in the previous step



A likely cause for errors is a communications problem between the server and the client.

11. When the test policy operates satisfactorily, repeat specific steps as necessary to verify other clients and storage units.
12. When all clients and storage units are functional, test the remaining policies and schedules that use storage units on the master server. If a scheduled backup fails, check the All Log Entries report for errors, then follow the actions suggested in the status codes chapters.

Testing Media Server and Clients

If you are using media servers, verify their operation as explained in the following steps. Before proceeding, eliminate all problems on the master server by completing [“Testing the Master Server and Clients”](#) on page 21.

▼ To test the media server and clients

1. Enable appropriate debug logs on the servers (see the [“Using Logs and Reports”](#) chapter). If you are uncertain which logs apply, enable them all until you solve the problem. Delete the debug log directories when you have resolved the problem.
2. Configure a test policy with a user schedule (set the backup window to be open while you are testing).
 - ◆ Name the media server as the client and a storage unit that is on the media server (preferably a nonrobotic drive).
 - ◆ Add a volume on the volume database host for the devices in the storage unit (master server is recommended for the volume database host). Ensure the volume is in the NetBackup volume pool.
 - ◆ Insert the volume in the drive. If you do not prelabel the volume by using the `bp1abel` command, NetBackup automatically assigns a previously unused media ID.
3. Verify that all NetBackup daemons or services are running on the master server and Media Manager daemons or services are running on the media server.
 - ◆ To perform this check on a UNIX system, execute:
`/usr/opensv/netbackup/bin/bpps -a`
 - ◆ To perform this check on a Windows system, use the Services application in the Windows Control Panel.

4. Perform a user backup and then a restore of a file. Perform these operations from a client that has been verified to work with the master server.

This test verifies:

- ◆ NetBackup media server software
- ◆ Media Manager on the media server can mount the media and use the drive that you configured
- ◆ Communications between the master server process `bpsched` and media server processes `bpcd` and `bpbrm`
- ◆ Communications between media server process `bpbrm` and client processes `bpcd` and `bpbkarr`

For failures relating to drives or media, ensure that the drive is in an UP state and the hardware is functioning.

If you suspect a communications problem between the master and media servers, check the debug logs for the involved processes. If the debug logs don't help you, check the following:

- ◆ On a UNIX server, the System log
- ◆ On a Windows server, the Event Viewer Application log
- ◆ `vmc` debug logs

See the vendor manuals for information on hardware failures.

If you are using a robot and this is an initial configuration, verify that the robotic drive is configured correctly. In particular, verify that:

- ◆ The same robot number is used both in the Media Manager and storage unit configurations.
- ◆ Each robot has a unique robot number.

On a UNIX server, you can verify only the Media Manager part of the configuration, by using the `tpreq` command to request a media mount. Verify that the mount completes and check which drive the media was mounted on. Repeat the process until the media has been mounted and unmounted on each drive from the host where the problem was occurring. Perform these steps from the media server. If this works, then the problem is probably with the policy or storage unit configuration on the media server or communications between the master and media server. When you are done, `tpunmount` the media.

5. If you previously configured a nonrobotic drive and a robot attached to your media server, change the test policy to name the robot. Also, add a volume for the robot to the volume database host for the robot. Verify that the volume is in the NetBackup volume pool and in the robot.



Then, repeat this procedure starting with [step 3](#), this time for a robot. This verifies that Media Manager can find the volume, mount it, and use the robotic drive.

If a failure occurs, check the NetBackup All Log Entries report. Look for errors relating to devices or media. If the All Log Entries report doesn't help, check:

- ◆ On a UNIX server, the system logs on the media server
- ◆ vmd debug logs on the volume database host for the robot
- ◆ On a Windows system, the Event Viewer Application log

In an initial configuration, verify that the robotic drive is configured correctly. Do not use a robot number that is already configured on another server.

Try the test utilities described in the “[Robotic Test Utilities](#)” appendix.

Note Do not use the Robotic Test Utilities when backups or restores are active. These utilities prevent the corresponding robotic processes from performing robotic actions, such as loading and unloading media. This can cause media mount timeouts and prevent other robotic operations like robotic inventory and inject/eject from working.

6. When the test policy operates satisfactorily, repeat specific steps as necessary to verify other clients and storage units.
7. When all clients and storage units are working, test the remaining policies and schedules that use storage units on the media server. If a scheduled backup fails, check the All Log Entries report for errors, then follow the actions suggested in the status codes chapters.

Resolving Network Communication Problems

The following procedure is for resolving NetBackup communications problems, such as those associated with NetBackup status codes 54, 57, and 58. There are two variations of this procedure: one for UNIX clients and another for PC clients.

Note In all cases, ensure that your network configuration is working correctly outside of NetBackup before trying to resolve NetBackup problems.

UNIX Clients

For UNIX clients, perform the following steps. Before starting this procedure, add the `VERBOSE` option to the `/usr/opensv/netbackup/bp.conf` file. Also, create a `bpcd` debug log directory on your server and clients and a `bprd` log directory on the server. During subsequent retries, the debug logs will provide detailed debug information that will be useful in analyzing the problem.

▼ To resolve network communication problems with UNIX clients

1. If this is a new or modified configuration:
 - a. Check any recent modifications to ensure that they did not introduce the problem.
 - b. Ensure that the client software was installed.
 - c. Ensure that the client operating system is one of those supported by the client software.
 - d. Check the client names, server names, and service entries in your NetBackup configuration as explained in [“Verifying Host Names and Services Entries”](#) on page 34.

Two other checks that you can make on host names are:

- ◆ Use the `hostname` command on the client to determine the host name that the client sends with requests to the server.
 - ◆ Check the `bprd` debug log (verbose) on the server to determine what occurred when the server received the request.
- e. Pay special attention to NIS or DNS updates that are required. Failing to properly update these services is a common source of network problems with NetBackup.
2. Verify basic network connectivity between client and server by trying to ping the client from the server.

ping *clientname*

Where *clientname* is the name of the client as configured in the NetBackup policy configuration, `/etc/hosts`, and also in NIS and DNS (if applicable).

For example, to ping a client named `ant`:

```
ping ant
ant.nul.nul.com: 64 byte packets
64 bytes from 199.199.199.24: icmp_seq=0. time=1. ms
----ant.nul.nul.com PING Statistics----
```



```
2 packets transmitted, 2 packets received, 0% packet loss
round-trip (ms)  min/avg/max = 1/1/1
```

Also, try ping from the client to the server.

If ping succeeds in both instances, it verifies basic connectivity between the server and client. If ping fails, you have a network problem outside of NetBackup that must be resolved before proceeding.

Note that some forms of the ping command let you ping the bpcd port on the client as in:

```
ping ant 13782
```

or

```
ping ant bpcd
```

3. Check that the client is listening on the correct port for connections to bpcd by running one of the following commands (depending on platform and operating system).

```
netstat -a | grep bpcd
netstat -a | grep 13782 (or the value specified during the install)
rpcinfo -p | grep 13782 (or the value specified during the install)
```

For example, assume the client is a Solaris system and you execute:

```
netstat -a | grep 13782
```

If there is no problem with the port, the results are be similar to:

```
tcp 0 0 *.13782 *.* LISTEN
```

The LISTEN indicates that the client is listening for connections on this port.

If there is a problem, this line does not appear and one of the following three conditions exists:

- ◆ /etc/services (or applicable NIS file) does not have the correct bpcd entry. The correct /etc services entry is:

```
bpcd 13782/tcp bpcd
```

- ◆ /etc/inetd.conf (or applicable NIS or DNS file) does not have the correct bpcd entry. The correct /etc/inetd.conf entry is:

```
bpcd stream tcp nowait root /usr/opensv/netbackup/bin/bpcd bpcd
```

- ◆ /etc/inetd.conf was changed but was not reread. Correct this condition by executing one of the following (whichever works):

```
/bin/ps -ef | grep inetd
kill -HUP the_inetd_pid
```

or

```
/bin/ps -aux | grep inetd
kill -HUP the_inetd_pid
```

Note On a Hewlett-Packard platform, use `inetd -c` to send a SIGHUP to `inetd`.

If the problem is with an AIX client, use SMIT to verify that the InetServ object policy has been updated with information about the `bpcd` process (`/etc/inetd.conf` and `/etc/services` information).

If you modify the InetServ object policy, using SMIT, the `inetexp` command is automatically invoked. If you edit the InetServ object policy, using an ODM editor, run the `inetexp` command to export the InetServ object policy to the `/etc/inetd.conf` and `/etc/services` files. This keeps these files in sync with the InetServ object policy.

If you change the `/etc/inetd.conf` or `/etc/services` file, using SMIT, the `inetimp` command automatically updates the InetServ object policy. If you change either file, run the `refresh -s inetd` or `kill -1 InetdPID` command to inform the `inetd` daemon of the changes to its configuration file.

4. `telnet` to `bpcd` on the client. If it succeeds, keep the connection until after performing [step 5](#), then terminate it with Ctrl-c.

```
telnet clientname 13782
```

Where *clientname* is the name of the client as configured in the NetBackup policy configuration, `/etc/hosts`, and also in NIS and DNS (if applicable).

For example,

```
telnet ant bpcd
Trying 199.999.999.24 ...
Connected to ant.nul.nul.com.
Escape character is '^]'.

```

In this example, `telnet` can establish a connection to the client `ant`.

- ◆ If the `telnet` succeeds, then `inetd` on the client is configured correctly and is able to pass its connection to `bpcd` and NetBackup should also be able to establish a connection.
- ◆ If `telnet` doesn't work, ensure that the `inetd.conf` file and `/etc/services` files on both the server and client have correct and matching entries. By default, these are:

In `/etc/services`:

```
bpcd 13782/tcp bpcd
```



In `/etc/inetd.conf`:

```
bpcd stream tcp nowait root /usr/opencv/netbackup/bin/bpcd bpcd
```

Then, execute `kill -HUP` to reread the `/etc/inetd.conf` file as explained in [step 3](#).

Also, update the applicable NIS or DNS files.

If all these files are correct and you still cannot successfully connect to the client, suspect network routing problems or a problem with the port assignment (see next step).

5. Check that the client is listening on the correct port for the `telnet` connection to `bpcd` by running one of the following commands (depending on platform and operating system).

```
netstat -a | grep bpcd
netstat -a | grep 13782 (or the value specified during the install)
rpcinfo -p | grep 13782 (or the value specified during the install)
```

For example, assume the client in [step 4](#) is a SunOS system named `ant` and the `telnet` is from a NetBackup server named `whale`:

```
netstat -a | grep 13782
```

- ◆ If there is no problem with the port, you see:

```
tcp 0 0 ant.nul.nul.com.13782 whale.nul.nul.com.1516 ESTABLISHED
tcp 0 0 *.13782 *.* LISTEN
```

In the first line of the result, `ESTABLISHED` indicates that the `telnet` connection was established to `bpcd` through port 13782 on the client.

The `LISTEN` in the second line indicates that the client is listening for further connections on this port.

Note We suggest that you not change the port number for `bpcd` or other NetBackup services. Do so only if there is no alternative; and then, remember that all NetBackup servers and clients in the configuration must use this new port assignment.

- ◆ If there is a process other than `bpcd` using the port, try rebooting the client to clear the problem. If the problem is still not fixed, it might be necessary to change one of the service numbers (preferably for the other service). You do this by modifying the `/etc/services` files then sending `SIGHUP` signals to the `inetd` processes on your clients.

```
/bin/ps -ef | grep inetd
kill -HUP the_inetd_pid
```

or

```
/bin/ps -aux | grep inetd
kill -HUP the_inetd_pid
```

Note On a Hewlett-Packard platform, use `inetd -c` to send a SIGHUP to `inetd`.

Also make applicable NIS or DNS updates.

If the problem is with an AIX client, and you make changes to `/etc/inetd.conf` and `/etc/services` information, use SMIT to verify that the InetServ object policy has been updated as explained in [step 4](#).

6. To verify basic client to master server communications, use the `bpclntcmd` utility. When run on a NetBackup client, the `-pn` and `-sv` options initiate inquiries to the NetBackup master server (as configured in the `bp.conf` file on the client). The master server then returns information to the requesting client. For more information, see [“Using bpclntcmd”](#) on page 37.

PC Clients

▼ To resolve network communication problems with PC clients

1. Before retrying the failed operation:
 - ◆ Increase the logging level on the client (see the user’s guide for the client).
 - ◆ On the NetBackup server, create a `bprd` debug log directory and on the clients create a `bpcd` debug log.
 - ◆ On the NetBackup server, set the **Verbose** level to 1 on the **TroubleShooting** tab in the NetBackup Client Properties dialog. To display this dialog, start the Backup, Archive, and Restore interface and click **NetBackup Client Properties** on the **File** menu (also see [“Using the Host Properties Window”](#) on page 54).
2. If this is a new client, verify the client and server names in your NetBackup configuration as explained in [“Verifying Host Names and Services Entries”](#) on page 34.
3. Verify basic network connectivity between client and server by pinging from the server to the client and from the client to the server. Use the following command:

```
ping hostname
```

Where *hostname* is the name of the host as configured in:

- ◆ NetBackup policy configuration



- ◆ WINS
- ◆ DNS (if applicable).
- ◆ hosts file in the system directory:
 - %SystemRoot%\system32\drivers\etc\hosts (Windows NT/2000, XP, 2003)
 - C:\Windows\hosts (default on Windows 98 and 95)

If ping succeeds in all instances, it verifies basic connectivity between the server and client.

If ping fails, you have a network problem outside of NetBackup that must be resolved before proceeding. As a first step, verify the workstation is turned on, as this is a common source of connection problems with PC workstations.

4. On Microsoft Windows or NetWare clients, check the NetBackup Client service:
 - a. Ensure that the service is active, either by checking the logs (see [step b](#)) or as follows:
 - ◆ On Windows NT/2000, XP or Windows Server 2003 clients, use the Services application in the Control Panel to verify that the NetBackup Client service is running and start it if necessary.
 - ◆ On Windows 98 or 95 clients, check the system tray on the taskbar for the NetBackup client icon. If the icon is not there, run the NetBackup Client Job Tracker program from the NetBackup Program folder or the **Start** menu. When the icon is present, right-click on the icon to start the NetBackup client daemon.
 - ◆ On NetWare clients, enter `load bpcd` from the NetWare server console to start the NetBackup client daemon.
 - b. Check the `bpcd` debug logs for problems or errors. See “[Using Logs and Reports](#)” chapter for instructions on enabling and using these logs.
 - c. Verify that the same NetBackup client Service (`bpcd`) port number is specified on both the NetBackup client and server (by default, 13782).
 - ◆ On Microsoft Windows, check the **NetBackup Client Service Port** number on the **Network** tab in the NetBackup Client Properties dialog. To display this dialog, start the Backup, Archive, and Restore interface on the client and click **NetBackup Client Properties** on the **File** menu.

Verify that the setting on the Network tab matches the one in the services file. The `services` file is located in:

`%SystemRoot%\system32\drivers\etc\services` (Windows NT/2000, XP or 2003)

`C:\Windows\services` (Windows 98 and 95)

The values on the Network tab are written to the `services` file when the NetBackup Client service starts.

- ◆ On NetWare clients, see the BPCD setting in the `openv\netback\bp.ini` file.
- ◆ Or, instead of the first bullet under [step c](#), above: On UNIX NetBackup servers, the `bpcd` port number is in the `/etc/services` file. On Windows NetBackup servers, see the Client Properties dialog box in the Host Properties window (see [“Using the Host Properties Window”](#) on page 54).

Correct the port number if necessary. Then, on Windows clients and servers, stop and restart the NetBackup Client service. On Microsoft Windows 98 or 95 and NetWare clients, stop and restart the NetBackup client daemon (`bpcd`).

Note Do not change NetBackup port assignments unless it is absolutely necessary in order to resolve conflicts with other applications. If you do change them, do so on all NetBackup clients and servers. These numbers must be the same throughout your NetBackup configuration.

5. Verify that the NetBackup Request Service (`bprd`) Port number on Microsoft Windows and NetWare clients is the same as on the server (by default, 13720).
 - ◆ On Microsoft Windows clients (use the same method as in [step c](#) under [step 4](#)).
 - ◆ On NetWare clients, see the BPRD setting in the `openv\netback\bp.ini` file.
 - ◆ Or, instead of the first bullet: On UNIX NetBackup servers, the `bprd` port number is in the `/etc/services` file. On Windows NetBackup servers, set these numbers in the Client Properties dialog box in the Host Properties window (see [“Using the Host Properties Window”](#) on page 54).
6. Verify that the `hosts` file or its equivalent contains the NetBackup server name. The `hosts` files are:
 - ◆ `%SystemRoot%\system32\drivers\etc\hosts` (Windows NT/2000, XP or 2003)
 - ◆ `C:\Windows\hosts` (Windows 98 or 95)
 - ◆ `SYS:etc\hosts` (NetWare)
 - ◆ `/etc/hosts` (UNIX)



7. Verify client-to-server connectability by using `ping` or its equivalent from the client ([step 3](#) verified the server-to-client connection).
8. If the client's TCP/IP transport allows `telnet` and `ftp` from the server, try these as additional connectivity checks.
9. For a NetWare client, ensure that the server is not trying to connect when a backup or restore is already in progress on the client. Attempting more than one job at a time on these clients, results in a "can't connect" or similar error.
10. Use the `bpcIntcmd` utility to verify basic client to master server communications. When run on a NetBackup client, the `-pn` and `-sv` options initiate inquiries to the NetBackup master server (as configured in the server list on the client). The master server then returns information to the requesting client. For more information, see ["Using bpcIntcmd"](#) on page 37.
11. Verify that the client operating system is one of those supported by the client software.

Verifying Host Names and Services Entries

This procedure is useful if you encounter problems with host names or network connections and want to verify that the NetBackup configuration is correct. Several examples follow the procedure.

Note For more information on host names, refer to the ["Networks and Hostnames"](#) appendix in this manual and to the ["Rules for Using Host Names in NetBackup"](#) appendix in the *NetBackup System Administrator's Guide*.

▼ To verify the client and server host names in NetBackup

1. Verify that the correct client and server host names are configured in NetBackup.
 - a. On Windows servers, Windows clients and NetWare nontarget clients, check the **General** tab in the NetBackup Client Properties dialog and the **Servers** tab in the Specify NetBackup Machines and Policy Type dialog box. To display these dialog boxes, start the Backup, Archive, and Restore interface on the client. For the **General** tab, click **NetBackup Client Properties** on the **File** menu; for the **Servers** tab, click **Specify NetBackup Machines and Policy Type** on the **File** menu.
 - ◆ On the **Servers** tab, ensure that there is a server entry for the master server and each media server.

On Windows systems, the correct server must be designated as the current master server in the list. If you add or modify server entries on the master server, stop and restart the NetBackup Request service and NetBackup Database Manager services.

On UNIX systems, if you add or modify `SERVER` entries on the master server, stop and restart `bprd` and `bpdbm`.

- ◆ On the **General** tab, verify that the client name setting is correct and matches what is in the policy client list on the master server.
- ◆ On a master or media server, ensure there is a server entry for each Windows administrative client that can be used to administer that server.
- ◆ If a host name is misspelled in the `bp.conf` file (UNIX) or via the servers list (Windows) on the master server, or if a host name cannot be resolved via `gethostbyname`, the following error messages will be logged in the NetBackup error log:

```
Gethostbyname failed for <host_name>:<h_errno_string>
(<h_errno>)
```

```
One or more servers was excluded from the server list
because gethostby name() failed.
```

You can also make the above changes on the appropriate tabs in the properties dialog boxes on a Windows NetBackup server (see [“Using the Host Properties Window”](#) on page 54).

- b. On UNIX NetBackup servers and clients, and Macintosh clients, check the server and client name entries in the `bp.conf` file:
 - ◆ Ensure there is a `SERVER` entry for the master server and each media server in the configuration. The master server *must* be the first name in the list.

Remember, if you add or modify `SERVER` entries on the master server, you must stop and restart `bprd` and `bpdbm` before the changes take effect.
 - ◆ Ensure that the `CLIENT_NAME` option (if included) is correct and matches what is in the policy client list on the master server.

The `bp.conf` file is in the `/usr/opensv/netbackup` directory on UNIX clients and it is in the `Preferences:NetBackup` folder on Macintosh clients.

Users on UNIX clients can also have a personal `bp.conf` file in their home directory. A `CLIENT_NAME` option in `$HOME/bp.conf` overrides the one in `/usr/opensv/netbackup/bp.conf`.

- c. On NetWare clients, check the `opensv\netback\bp.ini` file to ensure that:



- ◆ There is a `SERVER` entry for the master server and each media server in the configuration. The master server must be the first name in the list.
 - ◆ The `ClientName` entry and the entries in the `[clients]` section are correct and match what is in the policy client list on the master server.
- d. On the master server, verify that you have created any required
- `/usr/opencv/netbackup/db/altnames` files (UNIX)
 - `install_path\NetBackup\db\altnames` files (Windows)
- Pay particular attention to requirements for `host.xlate` file entries.
2. Verify that each server and client has the required entries for NetBackup reserved port numbers.

Note The examples following this procedure show the default port numbers. Do not change NetBackup port assignments unless it is absolutely necessary in order to resolve conflicts with other applications. If you do change them, do so on all NetBackup clients and servers. These numbers must be the same throughout your NetBackup configuration.

- a. On NetBackup servers, check the `services` files to ensure that they have entries for:
- ◆ `bpcd` and `bprd`
 - ◆ `vmd`
 - ◆ `bpdbm`
 - ◆ Processes for configured robots (for example, `t18cd`). See the *Media Manager System Administrator's Guide* for a list of these processes.
- On UNIX, the `services` file is `/etc/services`. On Windows, the `services` file is `%SystemRoot%\system32\drivers\etc\services`.
- b. On UNIX, Windows, and NetWare clients, verify the NetBackup client daemon or service number, and the request daemon or service port number.
- ◆ On UNIX clients, check the `bprd` and `bpcd` entries in the `/etc/services` file.
 - ◆ On Microsoft Windows clients, verify that the **NetBackup Client Service Port** number and **NetBackup Request Service Port** number on the **Network** tab in the NetBackup Client Properties dialog match the settings in the `services` file. To display this dialog, start the Backup, Archive, and Restore interface on the client and click **NetBackup Client Properties** on the **File** menu.

The values on the Network tab are written to the `services` file when the NetBackup Client service starts.

The `services` file is located in:

`%SystemRoot%\system32\drivers\etc\services` (Windows NT/2000, XP or 2003)

`C:\Windows\services` (Windows 98 and 95)

- ◆ On NetWare clients, check the `BPCD` and `BPRD` entries in the `openv\netback\bp.ini` file.
3. On UNIX servers and clients, check the `/etc/inetd.conf` file to ensure that it has the following entry:

```
bpcd stream tcp nowait root /usr/openv/netbackup/bin/bpcd bpcd
```
 4. On Windows servers and clients, verify that the NetBackup Client service is running.
 5. If you are using NIS in your network, update those services to include the NetBackup information that is added to the `/etc/services` file.
 6. NIS, WINS, or DNS host name information must correspond to what is in the policy configuration and the name entries in the following:
 - ◆ On Windows NetBackup servers, Microsoft Windows clients, and NetWare nontarget clients, check the **General** tab in the NetBackup Client Properties dialog and the **Servers** tab in the Specify NetBackup Machines and Policy Type dialog. To display these dialogs, start the Backup, Archive, and Restore interface on the client. For the **General** tab, click **NetBackup Client Properties** on the **File** menu; for **Servers** tab, click **Specify NetBackup Machines and Policy Type** on the **File** menu.
 - ◆ The `bp.conf` file on UNIX servers and clients and Macintosh clients.
 - ◆ The `openv\netback\bp.ini` file on NetWare clients.

Also, verify that reverse DNS addressing is configured.

7. To confirm the setup of the IP addresses and hostnames in DNS, NIS, and (or) local hosts files on each NetBackup node, use the NetBackup `bpcIntcmd` utility.

Using `bpcIntcmd`

The `bpcIntcmd` utility resolves IP addresses into host names and host names into IP addresses by using the same system calls as the NetBackup application software. The command that starts the utility is located in the following directory:



install_path\NetBackup\bin (Windows)

/usr/opensv/netbackup/bin (UNIX)

On Windows, run this command in an MS-DOS command window so you can see the results.

`bpc1ntcmd` options that are useful for testing the functionality of the host name and IP address resolution are `-ip`, `-hn`, `-sv` and `-pn`. The following topics explain each of these options:

`bpc1ntcmd -ip IP_Address`

The `-ip` option allows you to specify an IP address. `bpc1ntcmd` uses `gethostbyaddr()` on the NetBackup node and `gethostbyaddr()` returns the host name with the IP address as defined in the node's DNS, WINS, NIS, or local hosts file entries. No connection is established with the NetBackup server.

`bpc1ntcmd -hn Hostname`

The `-hn` option allows you to specify a host name. `bpc1ntcmd` uses `gethostbyname()` on the NetBackup node to obtain the IP address associated with the host name defined in the node's DNS, WINS, NIS, or local hosts file entries. No connection is established with the NetBackup server.

You can use the `-ip` and `-hn` options to verify the ability of a NetBackup node to resolve the IP addresses and host names of other NetBackup nodes. For example, you can verify that a NetBackup server can connect to a client. In this case, the steps are:

1. On the NetBackup server, use `bpc1ntcmd -hn` to verify that the operating system can resolve the host name of the NetBackup client (as configured in the client list for the policy) to an IP address. The IP address is then used in the node's routing tables to route a network message from the NetBackup server.
2. On the NetBackup client, use `bpc1ntcmd -ip` to verify that the operating system can resolve the IP address of the NetBackup server (the IP address is in the message that arrives at the client's network interface).

`bpc1ntcmd -pn`

When run on a NetBackup client, the `-pn` option initiates an inquiry to the NetBackup master server, and the server then returns information to the requesting client. First, `bpc1ntcmd` identifies the server to which it is making the request (on Windows systems, this is the Current Server in the server list), then it displays the information that the server returns.

For example:



```
bpclntcmd -pn  
expecting response from server rabbit.friendlyanimals.com  
dove.friendlyanimals.com dove 123.145.167.3 57141
```

Where:

- ◆ expecting response from server `rabbit.friendlyanimals.com` is the master server entry from the server list on the client.
- ◆ `dove.friendlyanimals.com` is the connection name (peername) returned by the master server. The master server obtained this name through `gethostbyaddress()`.
- ◆ `dove` is the client name configured in the NetBackup policy client list.
- ◆ `123.145.167.3` is the IP address of the client connection at the master server.
- ◆ `57141` is the port number of the connection on the client.

bpclntcmd -sv

The `-sv` option displays the NetBackup version number on the master server.



Host Name and Service Entry Examples - UNIX

The following figure shows a UNIX master server with one UNIX client.

Example 1: UNIX Master Server and Client

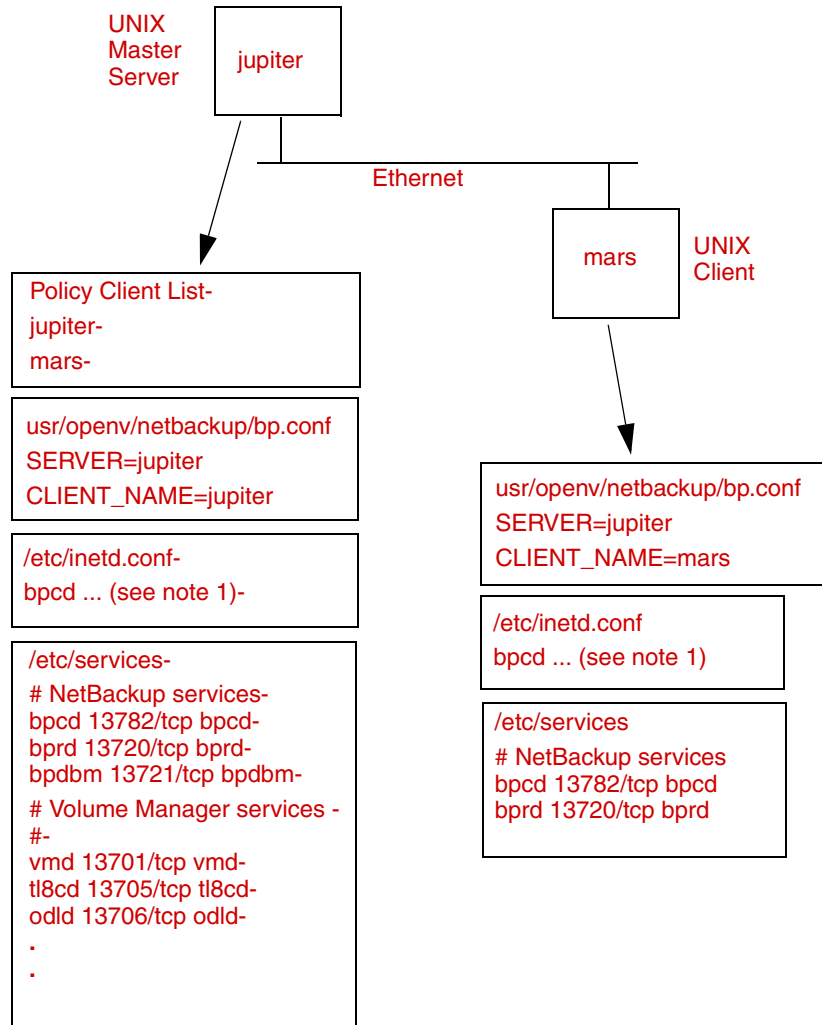

- Notes: 1. The complete inetd.conf entry is:
bpcd stream tcp nowait root /usr/openv/netbackup/bin/bpcd bpcd
2. All other applicable network configuration must also be updated to reflect the NetBackup information. For example, this could include the /etc/hosts file and NIS, and DNS (if used).



The following example includes a UNIX NetBackup media server named saturn. Note is the addition of a `SERVER` entry for saturn in the `bp.conf` files on all the systems. This entry is second, beneath the one for the master server jupiter.

Example 2: UNIX Master and Media Servers

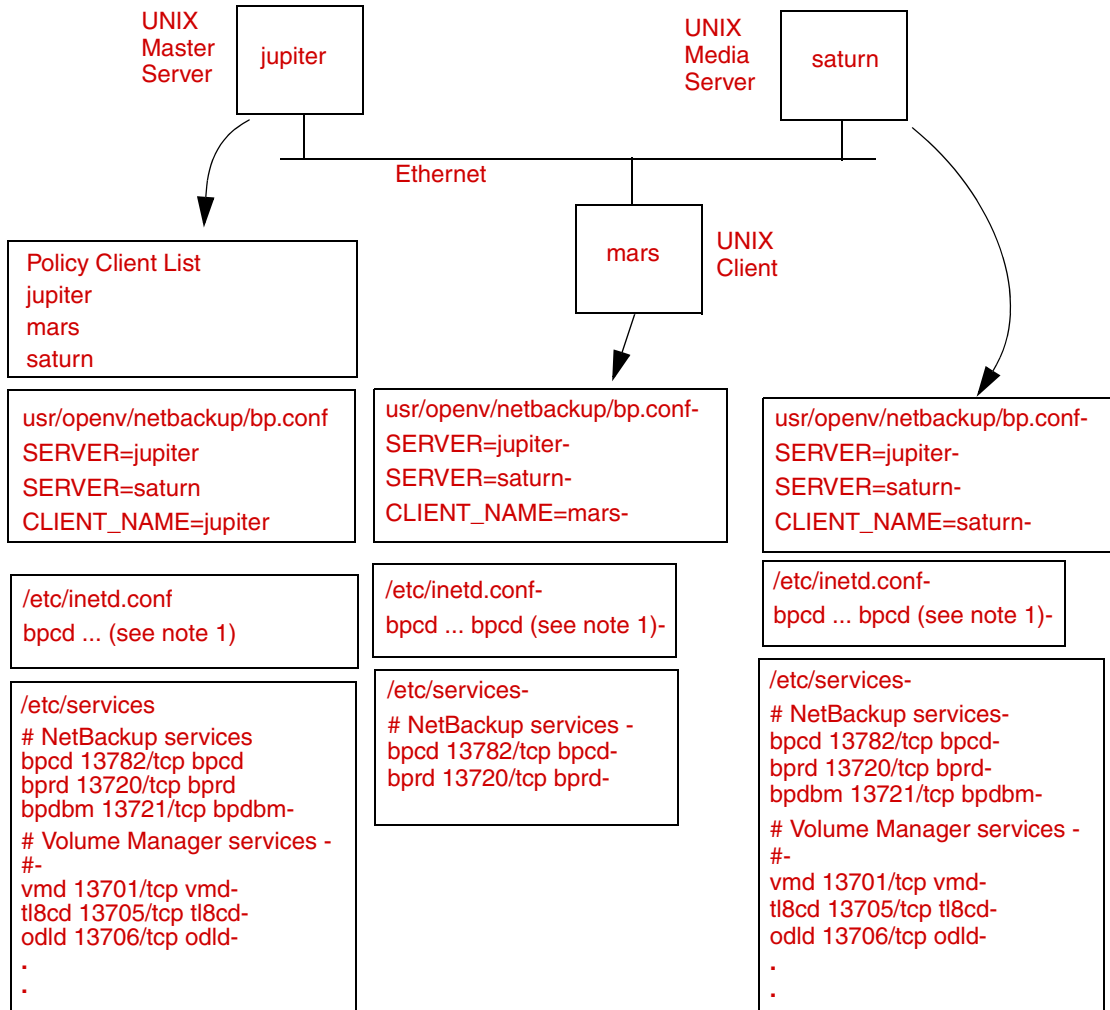

- Notes: 1. The complete inetd.conf entry is:-
 bpcd stream tcp nowait root /usr/opensv/netbackup/bin/bpcd bpcd-
2. All other applicable network configuration must also be updated to reflect the NetBackup information. For example, this could include the /etc/hosts file and NIS, and DNS (if used).



The following example shows a NetBackup master server with PC clients, defined here as Windows, NetWare, or Macintosh clients. Server configuration is the same as it is for UNIX clients. These clients do not have `inetd.conf` entries.

Example 3: PC Clients

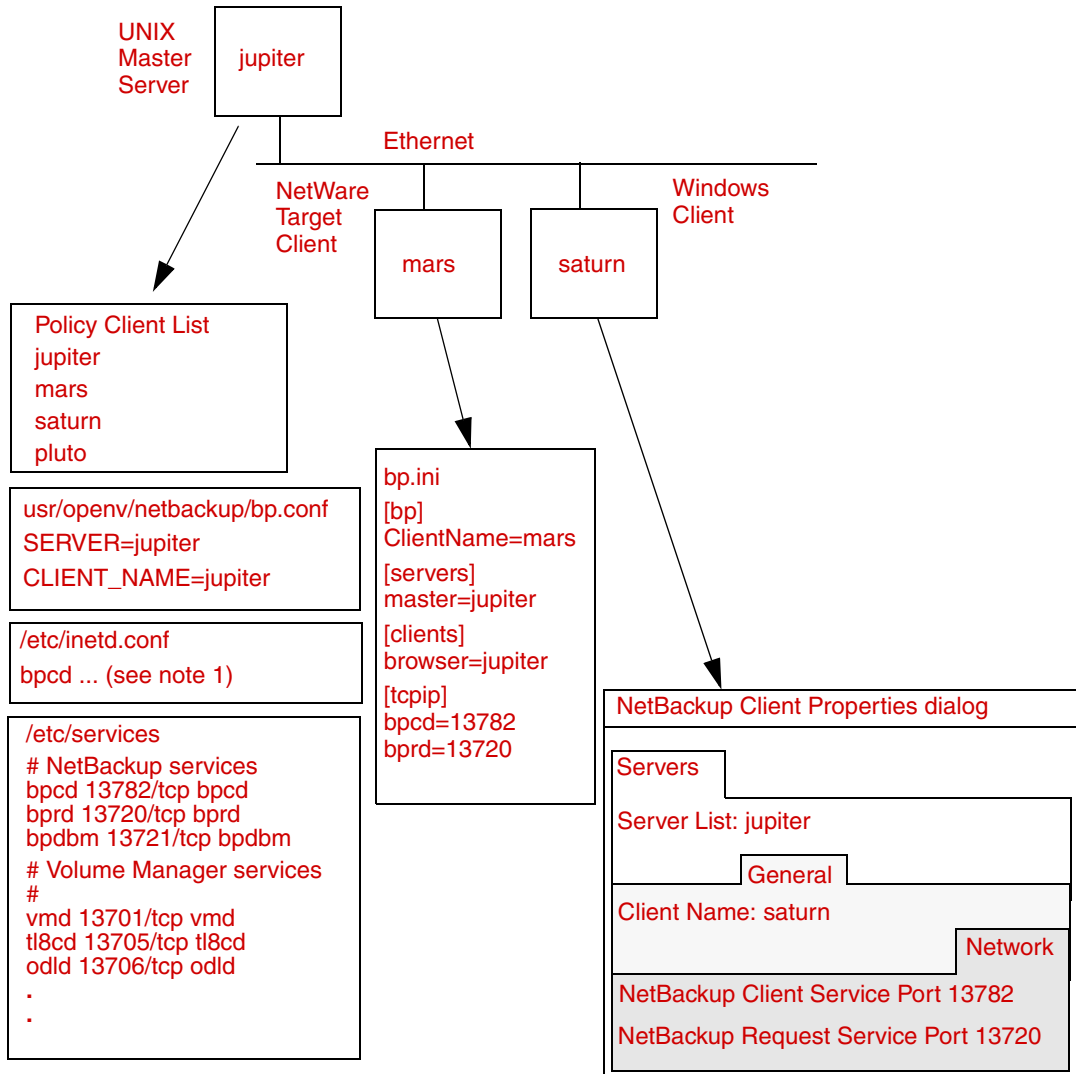

- Notes: 1. The complete `inetd.conf` entry is:-
`bpcd stream tcp nowait root /usr/openv/netbackup/bin/bpcd bpcd-`
2. All other applicable network configuration must also be updated to reflect the NetBackup information. For example, this could include the `/etc/hosts` file and NIS, and DNS (if used).

This network in this example shows a client (mars/meteor) that is a router to clients in another network. The client's host name on the master server side is mars and the host name presented to the client pluto is meteor.

Example 4: Clients in Multiple Networks

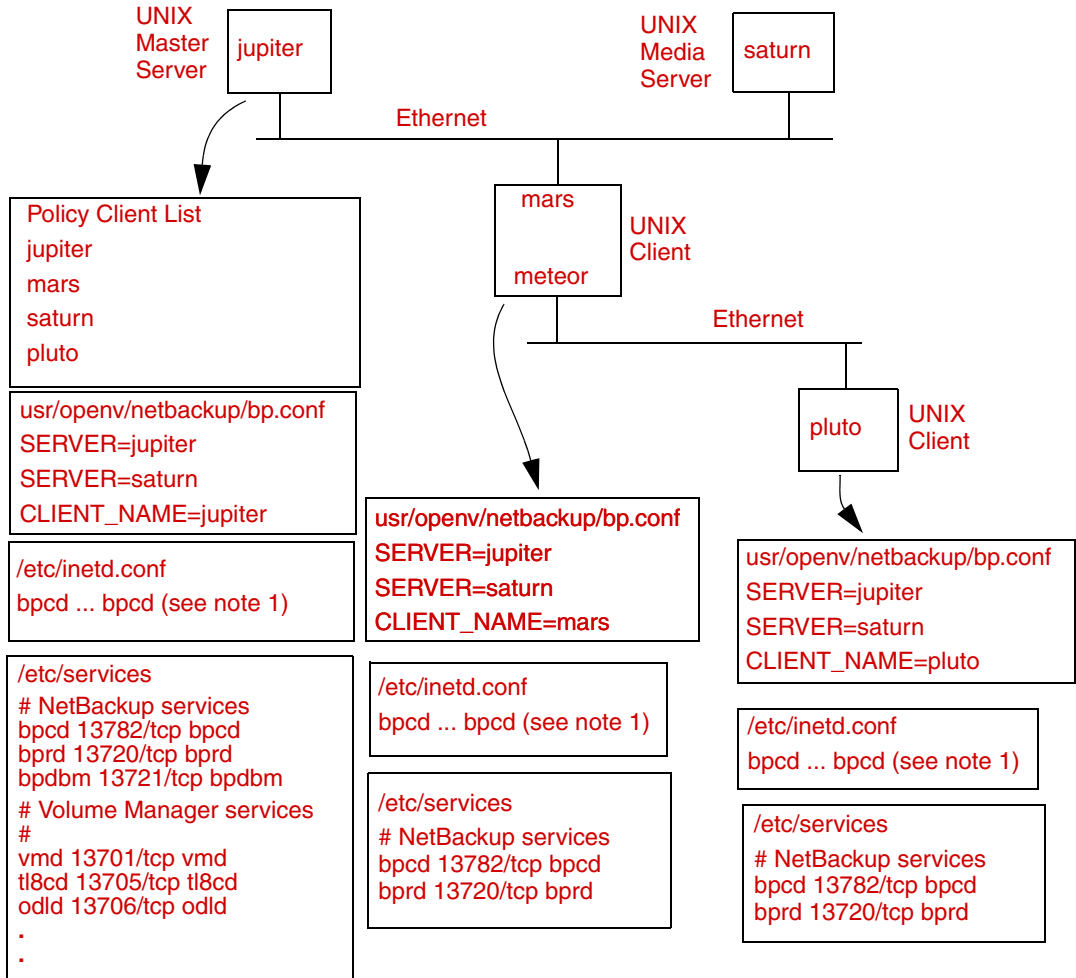

- Notes: 1. The complete inetd.conf entry is:
 bpcd stream tcp nowait root /usr/openv/netbackup/bin/bpcd bpcd
2. All other applicable network configuration must also be updated to reflect the NetBackup information. For example, this could include the /etc/hosts file and NIS, and DNS (if used).



Discussion for Example 4: Clients in Multiple Networks

First, we examine the configuration of the router system. The NetBackup policy client list shows this system as mars because that is the name of the interface to the master server. There is no special configuration to note other than the client name setting. This name must be set to mars, because this is the name that the master server recognizes.

The second client, pluto, is also configured no differently than if it were in the same network as the master server. Assuming that all the standard networking files (for example, hosts, NIS, DNS, WINS, and routing tables) are set up correctly, all the required network connections can be made.

There would be a problem, however, with restoring files from pluto if the mars/meteor system was a type of router that hides the name of the originating host when it routes requests between the two networks. For example, a router between an Ethernet and a token ring network exhibits this behavior.

To illustrate what occurs, assume that pluto is on FDDI (token ring) and the server is on Ethernet. If a user on pluto starts a restore, the router could use the name of its network interface to pluto (meteor) as the peername when it forwards the request to the server. The server interprets the request as coming from a host named meteor and does not allow the restore because meteor is not in the client list.

To resolve this problem, the administrator creates `altnames` directory on the master server and adds a file for meteor to that directory.

On a Windows NetBackup server, the file path is:

```
install_path\netbackup\db\altnames\meteor
```

On a UNIX NetBackup server, the file path is:

```
/usr/opensv/netbackup/db/altnames/meteor
```

Then, the administrator adds the following line to this file:

```
pluto
```

The master server now recognizes, as legitimate, any restore requests that show a peername of meteor and client name of pluto. Refer to the *NetBackup System Administrator's Guide for UNIX* for more information on `altnames` configuration.

Regardless of the type of router, the configuration for the media server, saturn, is the same as in example 2. If a media server is involved in a backup or restore for pluto, the master server provides the correct peername and client name for the media server to use in establishing connections.

The following example shows a NetBackup server that has two Ethernet connections and clients in both networks. The server's host name is mars on one and meteor on the other.

Example 5: Server Connects to Multiple Networks

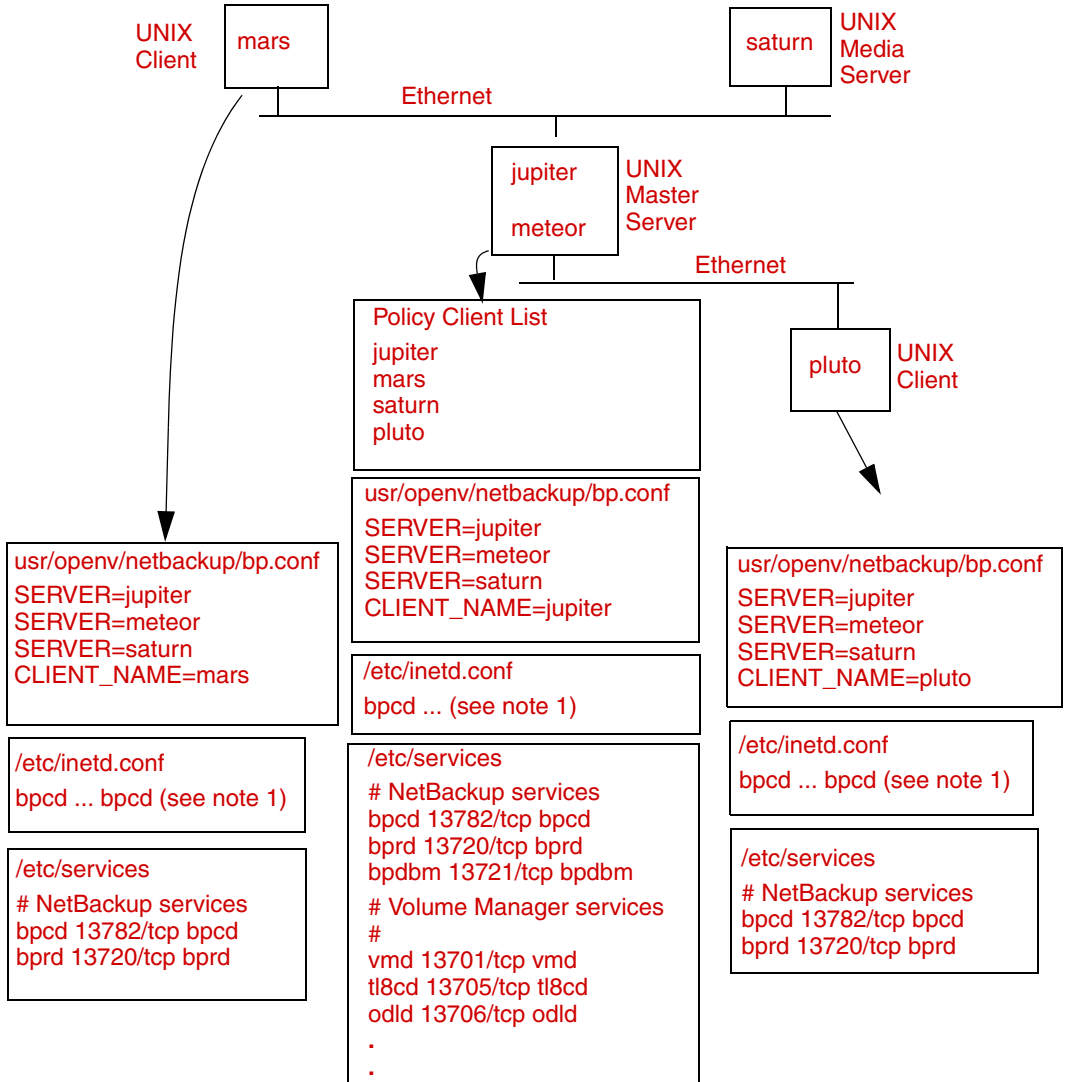

- Notes: 1. The complete inetd.conf entry is:
bpcd stream tcp nowait root /usr/openv/netbackup/bin/bpcd bpcd
2. All other applicable network configuration must also be updated to reflect the NetBackup information. For example, this could include the `/etc/hosts` file and NIS, and DNS (if used).



Discussion for Example 5: Server Connects to Multiple Networks

The first thing to note about this configuration is that the NetBackup policy client list specifies jupiter as the client name for the master server. The list could show either jupiter or meteor *but not both*.

Another important item to note is the configuration of the NetBackup server list.

The NetBackup server list on the master server has entries for both jupiter and meteor. The reason for both names is that when the server does a backup, it uses the name associated with the client it is backing up. For example, it uses the meteor interface when backing up pluto and the jupiter interface when backing up mars. The first server entry (master server name) is jupiter because that is the name used to back up the client on the master server.

The NetBackup server list for the other systems also have entries for both the jupiter and meteor interfaces. This is recommended in order to keep the server entries the same on all clients and servers in the configuration. It would be adequate to list only the master-server name for the local network interface to the client system or media server (for example, meteor for pluto).

For the network shown, the differences mentioned for the policy client list and the server list is the only unique configuration required. Assuming that all the standard networking files (for example, the hosts file, WINS, NIS, DNS, and routing tables) are set up correctly, all required network connections can be made.

If the master server system is a type of router that hides the name of the originating host when routing requests between networks, you see the same type of restore problem discussed in example 4. For example, if pluto were on FDDI (token ring), the master server would use meteor as the peername when it forwarded the request to NetBackup. NetBackup would then interpret the request as coming from a host named meteor, which was not in the client list, and the restore would fail.

The solution, in this case, is also identical to that discussed in [“Example 4: Clients in Multiple Networks”](#) on page 43.

Host Name and Service Entry Examples- Windows NT/2000,

The following figure shows a Windows NT/2000 master server with an NT/2000 client.

Example 1: Windows NT/2000 Master Server and Client

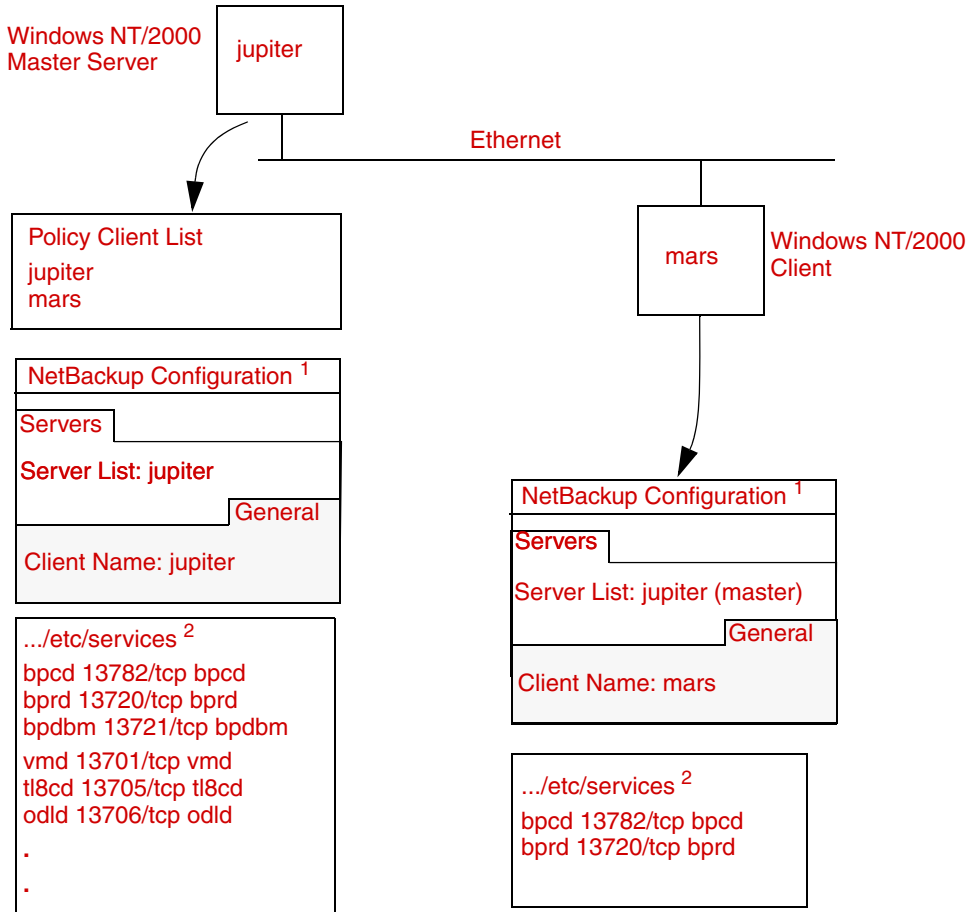

Notes: 1. The NetBackup Client Properties dialog also has a Network tab with “NetBackup client service port (BPCD)” and “NetBackup request service port (BPRD)” settings that must be the same as the bpcd and bprd settings in the services file.

2. The complete path to the Windows NT/2000 \etc\services file is:
 %SystemRoot%\system32\drivers\etc\services

3. All other applicable network configuration must also be updated to reflect the NetBackup information. For example, this could include the %SystemRoot%\system32\drivers\etc\hosts file and also WINS and DNS (if used).



The following example includes a NetBackup media server named saturn. Note the addition of a server list for saturn on all the systems. Jupiter is designated as the master.

Example 2: Windows NT/2000 Master and Media Servers

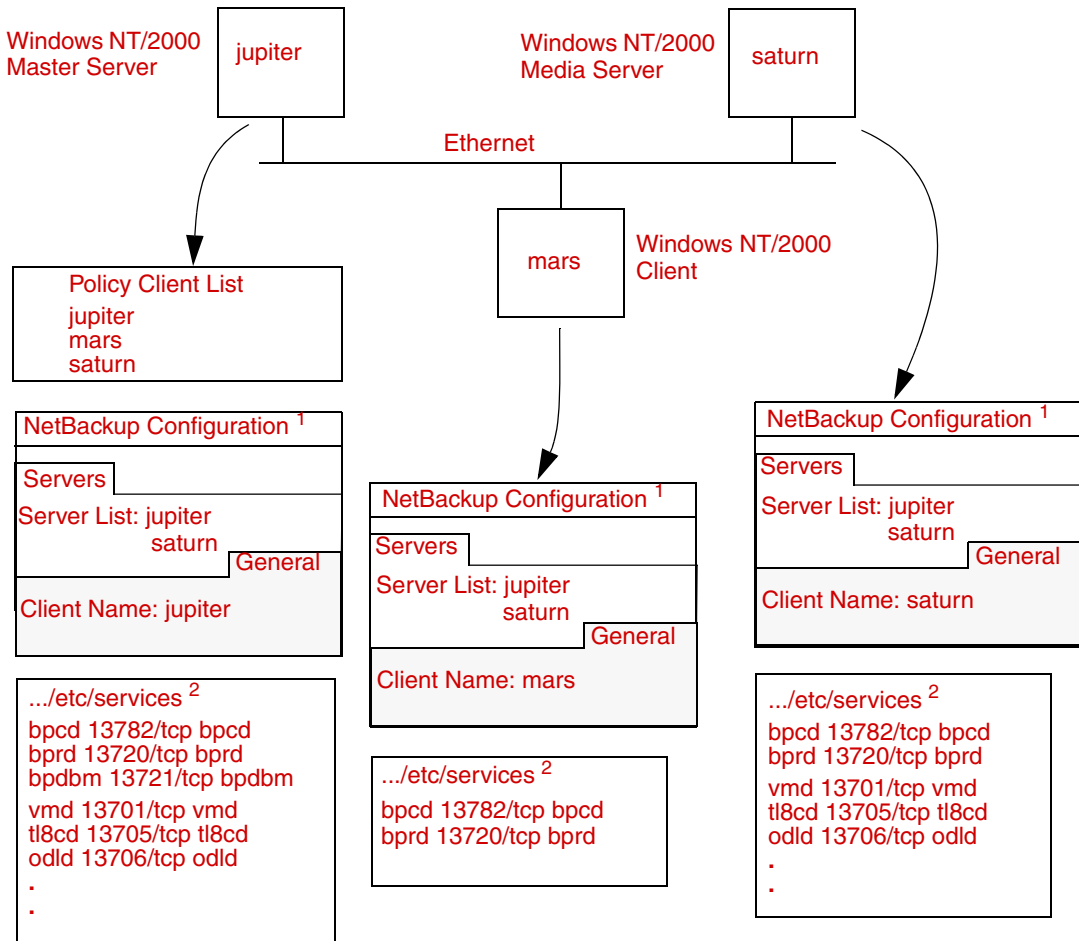

Notes: 1. The NetBackup Client Properties dialog also has a Network tab with "NetBackup client service port (BPCD)" and "NetBackup request service port (BPRD)" settings that must be the same as the bpcd and bprd settings in the services file.

2. The complete path to the Windows NT/2000 \etc\services file is:
 %SystemRoot%\system32\drivers\etc\services

3. All other applicable network configuration must also be updated to reflect the NetBackup information. For example, this could include the %SystemRoot%\system32\drivers\etc\hosts file and also WINS and DNS (if used).

The following figure shows a master server with a NetWare client. Entries for NetWare are in the `openv\netback\bp.ini` file.

Example 3: PC Clients

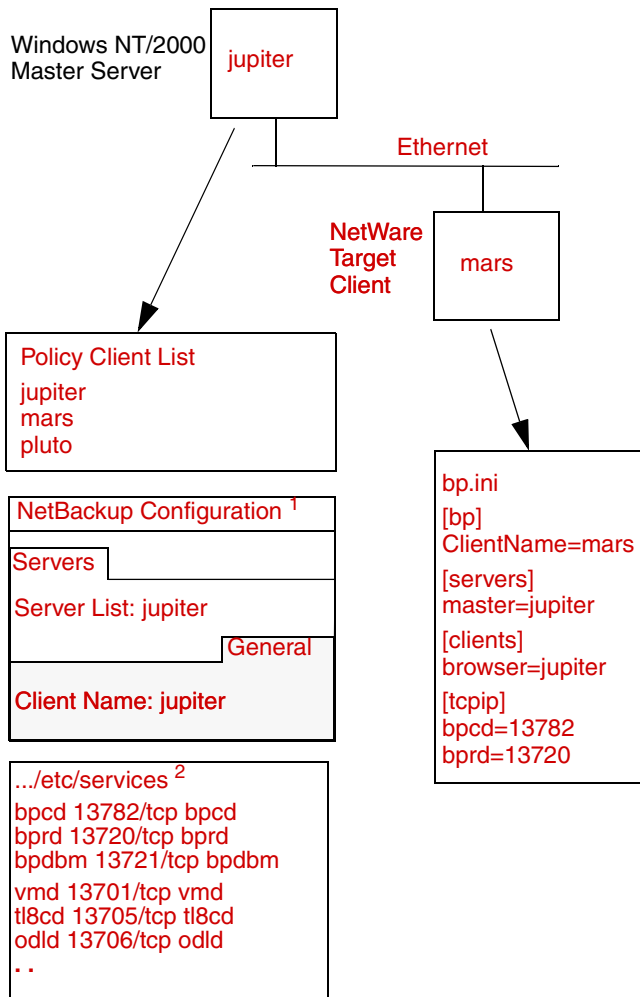

Notes: 1. The NetBackup Client Properties dialog also has a Network tab with “NetBackup client service port (BPCD)” and “NetBackup request service port (BPRD)” settings that must be the same as the bpcd and bprd settings in the services file.

2. The complete path to the Windows NT/2000 `\etc\services` file is:
`%SystemRoot%\system32\drivers\etc\services`

3. All other applicable network configuration must also be updated to reflect the NetBackup information. For example, this could include the `%SystemRoot%\system32\drivers\etc\hosts` file and also WINS and DNS (if used).



The following example shows a client (mars/meteor) that is a router to clients in another network. The client's host name on the master server side is mars and the host name presented to the client pluto is meteor.

Example 4: Clients in Multiple Networks

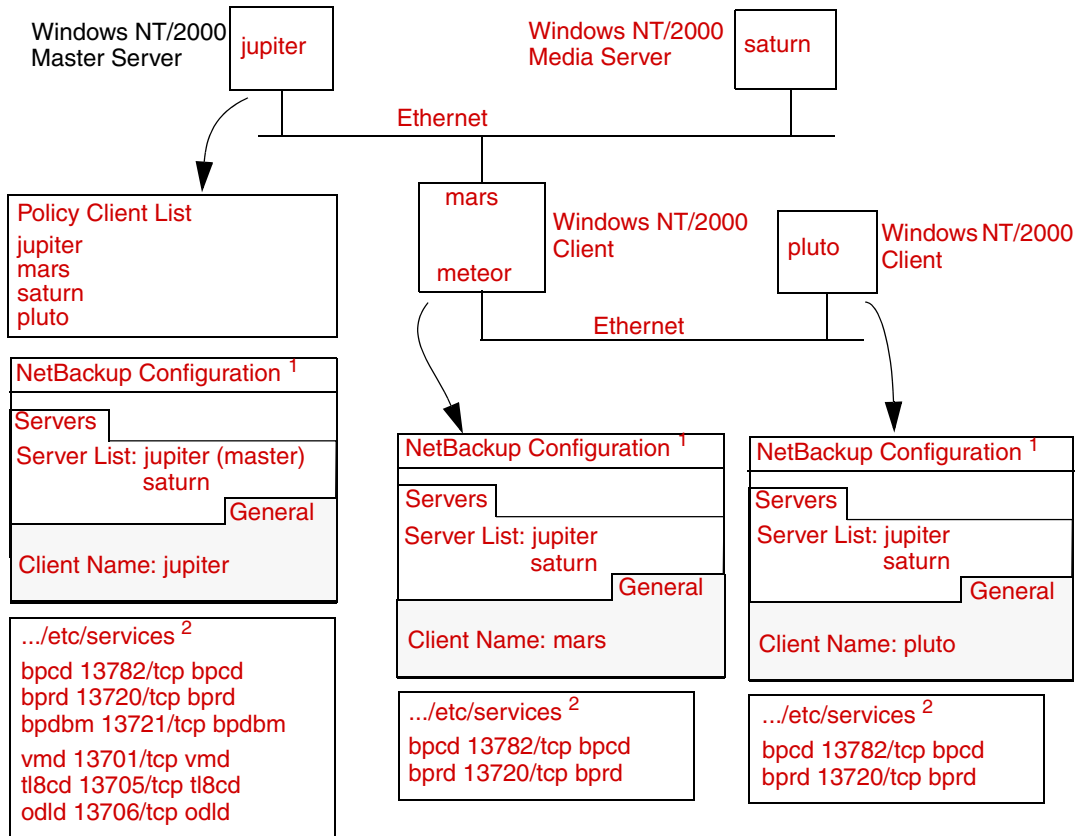

Notes: 1. The NetBackup Client Properties dialog also has a Network tab with “NetBackup client service port (BPCD)” and “NetBackup request service port (BPRD)” settings that must be the same as the bpcd and bprd settings in the services file.

2. The complete path to the Windows NT/2000 \etc\services file is:
 %SystemRoot%\system32\drivers\etc\services

3. All other applicable network configuration must also be updated to reflect the NetBackup information. For example, this could include the
 %SystemRoot%\system32\drivers\etc\hosts file and also WINS and DNS (if used).

Discussion for Example 4: Clients in Multiple Networks

First, we examine the configuration of the router system. The NetBackup policy client list shows this system as mars because that is the name of the interface to the master server. There is no special configuration to note other than the client name setting. This name must be set to mars, because this is the name that the master server recognizes.

The second client, pluto, is also configured no differently than if it were in the same network as the master server. Assuming that all the standard networking files (for example, hosts, DNS, WINS, and routing tables) are set up correctly, all the required network connections can be made.

There would be a problem, however, with restoring files from pluto if the mars/meteor system were a type of router that hides the name of the originating host when it routes requests between the two networks. A router between an Ethernet and a token ring network exhibits this behavior.

To illustrate what occurs, assume that pluto is on FDDI (token ring) and the server is on Ethernet. If a user on pluto starts a restore, the router could use the name of its network interface to pluto (meteor) as the peername when it forwards the request to the server. The server interprets the request as coming from a host named meteor and does not allow the restore because meteor is not in the client list.

To resolve this problem, the administrator creates an `altnames` directory on the master server and adds a file for meteor to that directory.

On a Windows NT/2000 NetBackup server, the file is:

```
install_path\NetBackup\db\altnames\meteor
```

Then, the administrator adds the following line to this file:

```
pluto
```

The master server now recognizes, as legitimate, restore requests that show a peername of meteor and client name of pluto. Refer to the *NetBackup System Administrator's Guide for Windows* for more information on `altnames` configuration.

Regardless of the type of router, the configuration for the media server, saturn, is still the same as in example 2. If a media server is involved in a backup or restore for pluto, the master server provides the correct peername and client name for the media server to use in establishing connections.



The following example shows a NetBackup server with two Ethernet connections and clients in both networks. The server's host name is mars on one and meteor on the other.

Example 5: Server Connects to Multiple Networks

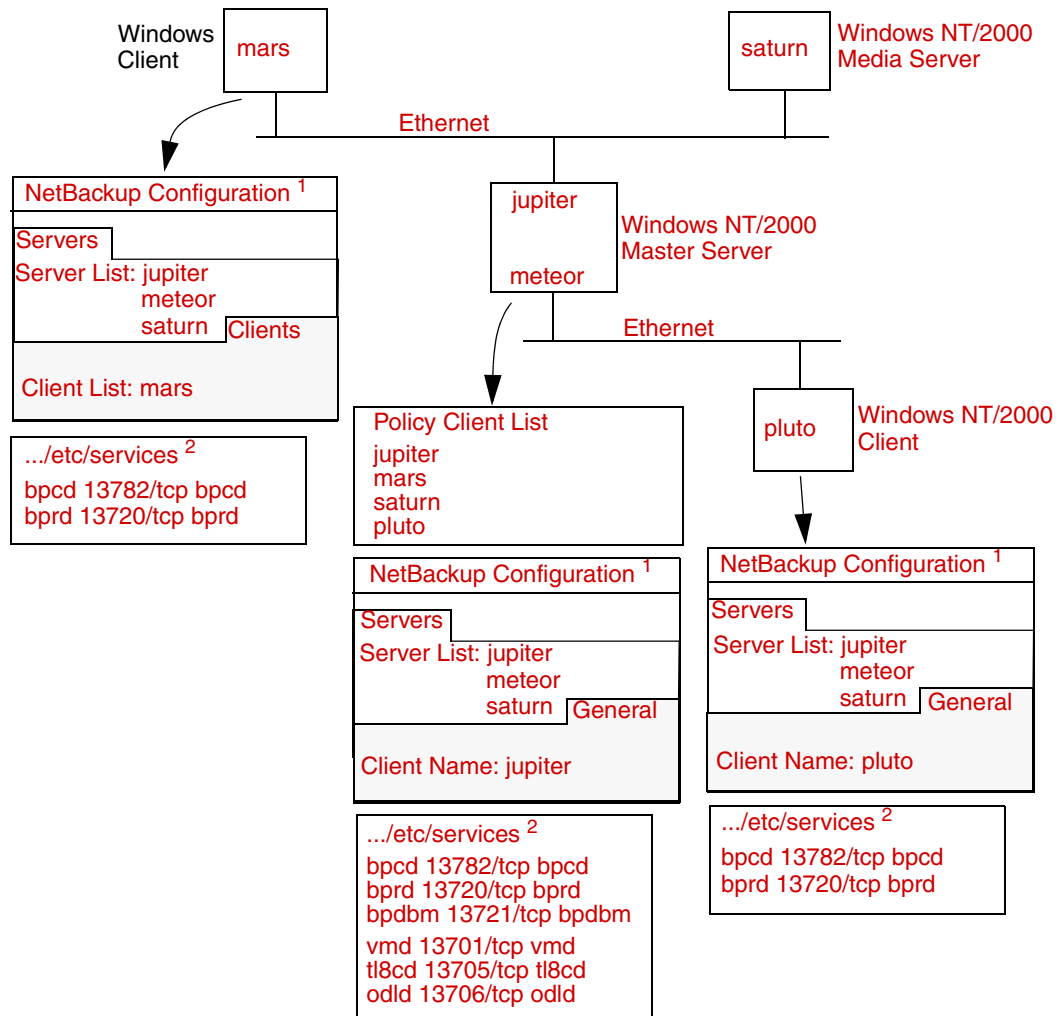

Notes: 1. The NetBackup Client Properties dialog also has a Network tab with "NetBackup client service port (BPCD)" and "NetBackup request service port (BPRD)" settings that must be the same as the bpcd and bprd settings in the services file.

2. The complete path to the Windows NT/2000 \etc\services file is:
 %SystemRoot%\system32\drivers\etc\services

3. All other applicable network configuration must also be updated to reflect the NetBackup information. For example, this could include the
 %SystemRoot%\system32\drivers\etc\hosts file and also WINS and DNS (if used).



Discussion for Example 5: Server Connects to Multiple Networks

The first thing to note about this configuration is that the NetBackup policy client list specifies jupiter as the client name for the master server. The list could show either jupiter or meteor but not both.

Another important item to note is the configuration of the NetBackup server list.

The NetBackup server list on the master server has entries for both jupiter and meteor. The reason for both names is that when the server does a backup, it uses the name associated with the client it is backing up. For example, it uses the meteor interface when backing up pluto and the jupiter interface when backing up mars. The current server entry (master server name) is jupiter because that is the name used to back up the client on the master server.

The NetBackup server list for the other systems also have entries for both the jupiter and meteor interfaces. This is recommended in order to keep the server entries the same on all clients and servers in the configuration. It would be adequate to list only the master-server name for the local network interface to the client system or media server (for example, meteor for pluto).

For the network shown, the differences mentioned for the policy client list and the server list is the only unique configuration required. Assuming that all the standard networking files (for example, the hosts file, WINS, DNS, and routing tables) are set up correctly, all required network connections can be made.

If the master server system is a type of router that hides the name of the originating host when routing requests between networks, you see the same type of restore problem discussed in example 4. For example, if pluto were on FDDI (token ring), the master server would use meteor as the peername when it forwarded the request to NetBackup. NetBackup would then interpret the request as coming from a host named meteor, which was not in the client list, and the restore would fail.

The solution, in this case, is also identical to that discussed in [“Discussion for Example 4: Clients in Multiple Networks”](#) on page 51.



Using the Host Properties Window

Note Available only in the NetBackup Administration Console for Windows.

The Host Properties window in the NetBackup Administration console on Windows provides access to many configuration settings for NetBackup clients and servers. For example, you can modify the server list, e-mail notification settings, and various timeout values for servers and clients. The following are general instructions for using this window. For more information, see the online help or the *NetBackup System Administrator's Guide for Windows*.

▼ To access configuration settings through the Host Properties Window

1. Start the NetBackup Administration interface on a Windows server or on a NetBackup Remote Administration Console.
2. Click **Host Properties**.
3. Select the servers or clients where you want to make the change.
4. Select **Properties** from the **Actions** menu.
5. In the properties dialog box that appears, select the appropriate tab and make your change.

Many procedures in this guide also refer to the NetBackup Client Properties dialog in the Backup, Archive, and Restore interface on Microsoft Windows clients. This dialog lets you change NetBackup configuration settings only for the local system where you are running the interface. Most settings in the NetBackup Client Properties dialog are also available in the Host Properties window.

Resolving Problems Related to Unavailable Storage Units

NetBackup jobs sometimes fail because storage units are unavailable, due to downed drives or errors in configuration, such as referencing an incorrect robot number. NetBackup processes log messages to the NetBackup error log that will help you pinpoint and resolve these types of issues.

Changes to the NetBackup Scheduler

The NetBackup scheduler (`bpsched`) now logs messages to the NetBackup error log when all drives associated with a storage unit are down, and when any drives become available.

The messages that appear in the NetBackup error log are:

```
no drives up on storage unit <stu_name>
<num> drive(s) now up on storage unit <stu_name>
```

The second message only appears if one or more drives become available while `bpsched` is executing. If the main `bpsched` process terminates and restarts later, it will not log the second message even if drives are available in the storage unit upon restart.

Changes to bptm

When a backup job fails with error code 219, the problem is usually caused by a misconfigured storage unit, or a storage unit in which all drives are down. In order to make it easier to distinguish between these states, `bptm` logs the following messages to the NetBackup error log:

```
all standalone drives of the specified density=<drive_density> are
down
```

This message is logged when all drives of the specified density are down. If the storage unit used in the backup job is configured with standalone drives of this density, then the cause of the failure resulting in error code 219 is the downed drives.

```
all drives are down for the specified robot number=<robot_num>,
robot type=<robot_type>, and density=<drive_density>
```

This message is logged when all the drives in the specified robot are down. If the storage unit used in the backup job uses this robot, then the cause of the failure resulting in error code 219 is the downed drives in the robot.



```
no standalone drives of the specified density=<drive_density> were found
```

This message is logged when no standalone drive of the specified density is found. If the storage unit used in the backup job uses a standalone drive of this density, then the cause of the failure resulting in error code 219 is the lack of a standalone drive of the specified density.

```
no drives were found with the specified robot number=<robot_num>, and robot type=<robot_type>, bad robot number/type
```

This message is logged when no drives are found with the specified robot number or type. If you see this message in the error log and your backup job fails with error code 219, check the robot number and or the robot type in the storage unit configuration. Ensure that the entries in the storage unit configuration match the robot number and robot type of an existing robot.

```
no drives were found with the specified density=<drive_density>
```

This message is logged when no drives are found that match the specified density. If your backup job fails with error code 219, check the density defined in the storage unit. It must match the density of the drives configured for the robot defined in the storage unit.

```
no NDMP drives connected to host=<host_name> were found in robot number=<robot_num>, robot type=<robot_type>, density=<drive_density>
```

This message is logged when no NDMP drives connected to <host_name> are found matching the specified robot number, robot type, and density. This error message flags a condition where the specified robot number and type exists, and there are drives matching the specified density, but the combination of that robot number/type with that drive density does not exist, that is, the robot is configured with drives of a density other than the specified density. Ensure that the storage unit is configured to use the correct robot number and type, and with the density matching the drives configured for the robot.

```
no drives matching the requested criteria were found (robot number=<robot_num>, and robot type=<robot_type>, and density=<drive_density>)
```

This message is logged when the specified robot contains drives that are not of the specified density. This error message flags a condition where the specified robot number and type exists, and there are drives matching the specified density, but the combination of that robot number/type with that drive density does not exist, that is, the robot is

configured with drives of a density other than the specified density. Ensure that the storage unit is configured with the correct robot number and type, and with the density that matches the drives configured for the robot.

Troubleshooting NBU in a SAN Environment

Three common problems NetBackup administrators may encounter in a SAN (Storage Area Network) environment are:

- ◆ Intermittent backup failures
- ◆ Connectivity issues (downed drives)
- ◆ SAN configuration changes

If the SAN administrator rezones the network, or masks an array in use by NetBackup, certain machines or devices needed by NetBackup may no longer be available to NetBackup. Either of these actions will cause backups to fail and drives to be downed, with no more information available to the NetBackup administrator than an error 83 (media open error) or error 84 (media write error) status code.

A NetBackup administrator can use SPC (VERITAS San Point Control) to check elements of the SAN configuration, such as whether or not a particular device is connected, and the zoning and masking on the SAN.

Sometimes a switch or an NT box hiccups, and sends out a reset command. Since NetBackup doesn't automatically maintain persistent bindings, the reset command can cause drives to be mapped differently. SPC can help find the problem by showing the changes in the drive mappings, although it can't automatically fix the problem. (For information on how to implement persistent bindings refer to the NetBackup documentation.)

NetBackup allows you to launch SPC in-context, that is, SPC's web GUI will display precisely the area of the SAN configuration you are troubleshooting.

NetBackup Enterprise Lifecycle: SPC and Best Practices

SAN-related problems generally involve the use of Shared Storage Option (SSO). There are generally two types of NetBackup users: operators, who have limited access to hosts and to the fabric of the SAN, and system administrators who have administrator privileges, but no access to the fabric. The SAN administrator generally operates outside the NetBackup domain entirely. It is difficult to troubleshoot NetBackup issues that involve the SAN because administrative responsibility tends to be spread out, and no one person may have a clear picture of the overall backup structure.



SANPoint Control provides a consistent view of the entire SAN against which to measure performance. It gives NetBackup administrators the data they need to request changes of and collaborate with the SAN administrators. It provides guidance to NetBackup administrators when designing, configuring, implementing solutions or modifying solutions in response to changes in the backup environment (hardware, applications, demand).

SANPoint Control can help those responsible for managing a backup system in a SAN environment by integrating SAN management and backup operation information. SPC can provide support during the following backup lifecycle stages:

- ◆ **DESIGN:** SPC can be used during the design phase to determine where on the SAN a backup system should be deployed, or if SAN redesign is required to meet backup windows at minimum hardware cost and application impact. For example, a backup design that takes into account performance trending reports kept by SPC to determine the pattern of fabric utilization may not require the purchase of additional switches. Or perhaps simple re-zoning of the fabric through SPC may provide sufficient bandwidth for meeting backup window requirements. In addition, SPC can provide visibility into recovery designs and fabric performance in the event of large restores required during critical business operations.
- ◆ **CONFIGURATION, TESTING:** Generally, backup systems are tested prior to implantation to obtain benchmarks and adjust (tune) the system for maximum efficiency. SPC can provide the performance metrics for end-to-end I/O capabilities for all elements in the backup path. Additionally, SPC can provide valuable environmental information for qualifying the backup environment and a future troubleshooting/configuration management baseline.
- ◆ **IMPLEMENTATION, RECONFIGURATION, PRODUCTION:** SPC can help to determine whether a host can see through the entire I/O path to the target backup device by pinpointing connectivity issues.

Using SPC to Troubleshoot NetBackup Issues

You can use SPC in the following ways to troubleshoot NetBackup in a SAN environment:

In-context Launch

Having the ability to launch SPC and access a quick overview of the SAN from NetBackup in context is valuable for determining root cause problems quickly. In addition, because NetBackup administrators and SAN administrators are often in different groups, the fragmented operations that lead to resolution delays may be overcome more quickly if the NetBackup administrator can gain a view of the overall health of the SAN as part of the initial troubleshooting process.

Connectivity/Device Check

Any failure in the topology can be detected by the view of the SAN environment presented by SPC. In addition, having an environment inventory to provide to support for troubleshooting is valuable to speed up support processes.

General Troubleshooting Tools

Here are some ways to investigate a backup failure.

- ◆ Launch SPC in-context from NetBackup to check fabric health.
- ◆ Check reports for fabric events occurring around the time the NetBackup error log was generated.

Common NetBackup Troubleshooting Use Cases

The following use cases demonstrate the ways SPC can be integrated into a NetBackup troubleshooting procedure. to investigate the SAN context of a backup system. Most common NetBackup problems on SANs revolve around connectivity issues.

Use Case 1: NetBackup cannot access drives or robots.

Typically found as an error 213 (no storage units available for use) in NetBackup, this problem represents a loss of connectivity. This issue is a real problem because NetBackup freezes tapes with two write failures, even when the failures are caused by SAN problems.

Symptom: Backup jobs fail

Troubleshooting Steps:

1. Check the NetBackup device monitor to see whether a device is down.
2. If it is, try to bring the drive back up.
3. If the drive is still down, check syslog, device logs, and NetBackup logs to look for errors 219 (the required storage unit is unavailable) and 213, no storage units available for use) on the media server host. Also look for errors 83, 84, 85, and 86 in the NetBackup logs (83-86 relate to write, read, open, position failures to access the drive).
4. Try a `robtest` to determine connectivity.
5. If there is no connectivity, it is likely there is a hardware problem. From the master server, select the robot or device the storage unit is associated with, and launch SPC. This will give you a view of the media server and devices. Once SPC is launched, check fabric connectivity (whether any I/O path devices are down).



Use Case 2: NetBackup device discovery cannot see a robot or drive.

The NetBackup administrator installs a new device and runs device discovery to configure it. Device discovery does not see the newly installed device.

Or, a device is not discovered by the device discovery wizard. The NetBackup administrator can use SPC's topology to visually check the connectivity between the hosts and the devices, to see if a network cable was dislodged or just went bad.

This use case is becoming more prevalent with more common implementation of snap backups. Snap backups require the media server to be capable of seeing all devices with which it is orchestrating the backup: disk array, disk cache, data mover, library and drive. Connectivity must be correct. In addition, the `bptpc` command in NetBackup (the command for 3rd party copy) generates a config file for running the backup. Often the WWN (world wide name) for many devices is incorrect. The administrator could use SPC to validate that the config file contents correlate to the actual fabric configuration.

Symtom: After running device discovery, the new device is not shown in the discovered devices list.

Troubleshooting Steps:

1. Run device discovery again.
2. If the new device is still not seen, there is likely a hardware problem. Launch SPC.
3. If the new device does not appear in the SPC topology, check SAN hardware connections to determine whether or not the device is connected.

If the new device shows up as disconnected or offline, contact the SAN administrator and check switch configuration.

Compare this troubleshooting procedure to a similar problem without the benefit of SPC, such as [Robotic Status Code: 214](#), robot number does not exist.

4. Rerun the device discovery wizard.

Use Case 3: Intermittent Drive Failure

A drive is failing and causing a backup to fail, yet when the administrator looks at the drive everything looks fine.

Sometimes failures are caused by a problem with a switch or bridge either before or during the backup job, which will cause the job to fail and the drive to be downed. This is one of the most difficult problems to diagnose, because by the time the NetBackup administrator looks at the SAN everything may be fine again. One way a NetBackup administrator can use SPC to troubleshoot this issue is to check for alerts around the time that the job failed, and see if a SAN problem occurred that would have caused the job to fail.

Another possibility is that another application reserved the device. The only way this issue could be resolved is with a SCSI device monitoring utility, which neither SPC nor NetBackup currently supplies.

Symptom: The backup job fails intermittently and the drive is downed intermittently. No errors appear in the error log other than that the job failed.

Troubleshooting Steps:

1. Select a drive inside the NetBackup device monitor and launch SPC in the drive context to see whether or not the drive is connected to the SAN.
2. Check the SPC alert reports to see whether a SAN problem existed that would have affected the drive during time the backup job failed.





Using Logs and Reports

3

NetBackup produces the following categories of information that you can use for troubleshooting problems.

- ◆ [Reports](#)
- ◆ [Status for User Operations](#)
- ◆ [UNIX System Logs](#)
- ◆ [Windows Event Viewer Application Logs](#)
- ◆ [Debug Logs](#)
- ◆ [Media Manager Logs](#)
- ◆ [Windows Event Viewer Logging Option](#)
- ◆ [Troubleshooting the Administration Console for UNIX](#)

Note The format of the entries in the NetBackup logs is subject to change without notice.

The following figure shows whether this information is available on the client or server and the processes involved in making the information available. The remaining topics in this chapter describe the reports and logs shown on the figure.

Note The term *media server*, as distinct from *master server* or *server*, does not apply to the NetBackup Server product. When troubleshooting a Server installation, please ignore any references to media server in this guide.



See [Appendix A](#) for more information on the programs and daemons mentioned in this figure and elsewhere in this chapter.

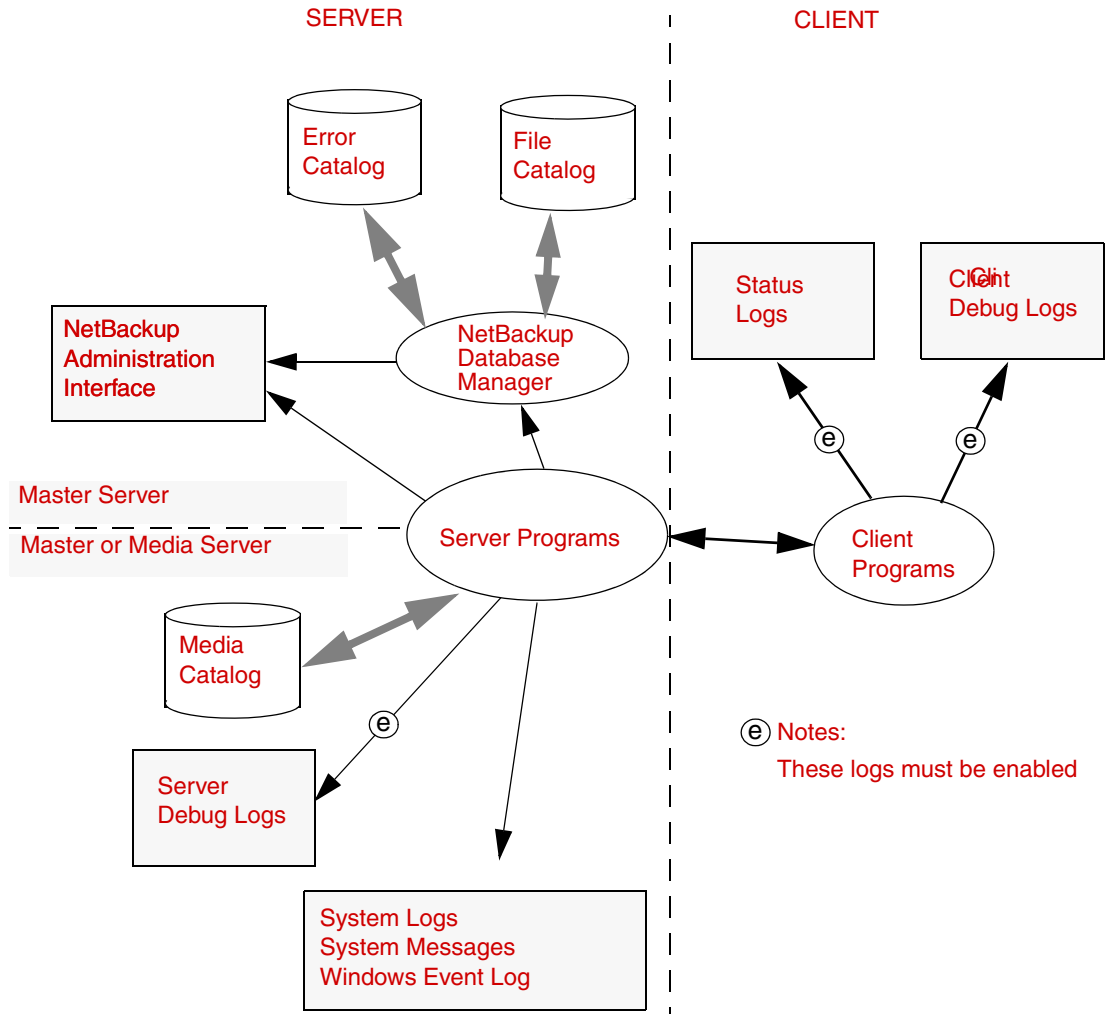

Reports

NetBackup provides a set of standard reports that gives you most of the status and error information you need. To run these reports, use the NetBackup administration interface (see the *NetBackup System Administrator's Guide* for instructions). The following table provides a brief description of the reports.

NetBackup Reports

Report	Description
Backup Status/Status of Backups	Status and error information on backups and archives completed within the specified time period. On UNIX systems, environment variables allow modification of character lengths of some fields.
Media Reports	Provides the following reports about the media: <ul style="list-style-type: none"> ◆ Media Lists - Shows information about volumes that NetBackup has used for backups or archives. This report does not show information for disk storage units. ◆ Media Contents - Lists the backup IDs that are on a single volume. The information is read directly from the media. This report does not show information for disk storage units. ◆ Images on Media - Shows the contents of media as recorded in the NetBackup file database. This report shows information for any type of storage unit, including disk. ◆ Media Logs- Lists the media errors that have been recorded. This information is a subset of the All Log Entries report. ◆ Media Summary - Summarizes active and nonactive volumes and groups them according to expiration date. The report shows the expiration date and the number of volumes that are at each retention level. ◆ Media Written - Identifies volumes that have been used for backups or archives within the specified time period. This report does not show media used for image duplication if the original image was created prior to the specified time period.
Client Backups	Detailed information on backups and archives completed within the specified time period.
Problems/Problems with Backups	Problems that the server has logged during the specified time period. This information is a subset of the information in the All Log Entries report.
All Log Entries	All log entries for the specified time period.



Status for User Operations

NetBackup allows you to view status on the progress of user operations. See the NetBackup user guides for instructions

UNIX System Logs

The NetBackup server daemons and programs occasionally log information through `syslogd`, which then shows a message or writes the information in an appropriate system log or the console log. See the `syslogd` man page for the locations of system log messages on your system.

Windows Event Viewer Application Logs

The NetBackup services and programs log information to the Event Viewer Application log. Look for messages pertaining to NetBackup in these logs.

Debug Logs

If a problem requires more information than is available through the normal logs and reports, you can enable debug logs that show detailed information about specific processes. To enable debug logging for a process, create a directory for its logs as explained in the following topics. Each process creates logs in its own logging directory. The logs that are available depend on whether the system is a server or a client.

Debug Logs on Servers

Note Refer to the Media Manager Logs section for enabling Media Manager debug log entries.

To enable debug logging on NetBackup servers, create the appropriate directories under:

UNIX: `/usr/opensv/netbackup/logs`

Windows: `install_path\NetBackup\logs`

The table below lists the debug log directories that apply to servers. When these directories exist, NetBackup creates log files in the directory for the associated process.

See the “[Functional Overview](#)” for more information on the programs and daemons that write the logs.

On UNIX systems, also refer to the README file in the `/usr/opensv/netbackup/logs` directory).

On a Windows server, you can create all of the NetBackup debug log directories at once on a master or media server by running the following batch file:

```
install_path\NetBackup\Logs\mklogdir.bat
```

Note Media servers have only the `bpbrm`, `bpcd`, `bpdm`, and `bptm` debug logs.

NetBackup Server Debug Logs

Debug Log Directory	Associated Process
<code>admin</code>	Administrative commands.
<code>bpbrm</code>	Net backup and restore manager.
<code>bpcd</code>	NetBackup client daemon/manager. This process is started by the NetBackup Client service.
<code>bpcoord</code>	NetBackup process started by <code>bpsynth</code> to start and monitor the <code>bptm</code> / <code>bpdm</code> processes on the media servers to read the component images to be synthesized. <code>bpcoord</code> runs on the master server.
<code>bpdbjobs</code>	NetBackup jobs database manager program.
<code>bpdm</code>	NetBackup disk manager.
<code>bpdbm</code>	NetBackup database manager. This process runs only on master servers. On Windows systems, it is the NetBackup Database Manager service.
<code>bpjava-msvc</code>	NetBackup-Java application server authentication service started by <code>inetd</code> on UNIX servers and by the Client Services service on Windows servers during startup of the NetBackup Java interface applications. This program authenticates the user that started the application.
<code>bpjava-susvc</code>	NetBackup program started by <code>bpjava-msvc</code> upon successful login through the Login dialog box that is presented when a NetBackup-Java interface is started. This program services all requests from the Java user interfaces on the NetBackup master or media server host where <code>bpjava-msvc</code> is running.(On all Windows platforms except 95/98)
<code>bprd</code>	NetBackup request daemon/manager. On Windows systems, this process is called the NetBackup Request Manager service.



NetBackup Server Debug Logs (continued)

Debug Log Directory	Associated Process
bpsched	NetBackup backup scheduler. This process runs only on master servers.
bpsynth	NetBackup process started by bpsched for synthetic backup. This process runs on the master server.
bptm	NetBackup tape or optical media management process.
symlogs	System log.
user_ops	The user_ops directory is created during the install of NetBackup on all servers and clients. The NetBackup Java interface programs use it for temporary files and for job and progress log files generated by the user backup, archive, and restore program (jbpSA). This directory must exist for successful operation of any of the Java programs and must have public read, write and execute permissions. user_ops will contain a directory for every user that is using the Java programs.
vnetd	The VERITAS network daemon, used to create “firewall friendly” socket connections. Started by the inetd(1M) process.

The following is a list of facts to be familiar with before using debug logs:

- ◆ On UNIX systems, NetBackup retains debug logs for the number of days you specify with the **Keep Logs for** global attribute (28 days by default) and then deletes them. For instructions on changing **Keep Logs for**, see the *NetBackup System Administrator's Guide for UNIX*.

On Windows systems, NetBackup retains debug logs for the number of days you specify with the **Duration to Retain Logs** global attribute (28 days by default) and then deletes them. For instructions on changing **Duration to Retain Logs**, see the *NetBackup System Administrator's Guide for Windows*.

- ◆ Debug logs can grow very large. Enable them only if unexplained problems exist and delete both the logs and the associated directory when they are no longer needed.

- ◆ Each debug log is kept in a separate subdirectory under:

UNIX: /usr/opensv/netbackup/logs

Windows: *install_path*\NetBackup\Logs

Debug logging takes place only if you create the subdirectory where the process can store its logs.

- ◆ A process creates one debug log file per day.

On UNIX, the file names created are of the form:

```
log.mmddyy
```

For example:

```
log.140898
```

On Windows, the file names created are of the form:

```
mmddyy.log
```

For example:

```
040198.log
```

- ◆ A debug log file is created when the process begins. Therefore, you must create the directory for a debug log before the process starts.
- ◆ To increase the amount of information that processes write in the logs:
 - ◆ On Windows systems, set the **Global Logging Level** to a higher level, in the Logging dialog/tab under Master Server properties.
 - ◆ On UNIX systems, define the string `VERBOSE` in the `/usr/opencv/netbackup/bp.conf` file. `VERBOSE` by itself sets the verbose value to 1. To get more logging detail, enter `VERBOSE = 2` or a higher value.

Caution High verbose values can cause debug logs to become extremely large.

- ◆ Also note: You can use the Logging dialog/tab under Master Server Properties to set the logging level for individual processes, as described in the *NetBackup System Administrator's Guide*. Or, specify the verbose flag (if available) when starting the program or daemon.

Logs To Accompany Problem Reports for Synthetic Backup

In order to debug problems with synthetic backups, the problem report must be accompanied by a complete set of logs. If the debug logs have not been turned on, you may need to rerun the test by selecting a debug level of 5 for NetBackup and after creating the following debug directories on the master server.

Debug Directories

```
<install_path>/netbackup/logs/bpsynth
```

```
<install_path>/netbackup/logs/bpcoord
```

```
<install_path>/netbackup/logs/bpdbm
```

```
<install_path>/netbackup/logs/bpsched
```



`<install_path>/netbackup/logs/vnetd`

and the following directories on the media server:

`<install_path>/netbackup/logs/bpcd`

`<install_path>/netbackup/logs/bptm`

`<install_path>/netbackup/logs/bpdm`

Debug Logs

A problem report must be accompanied with the following logs:

```
-debug log from <install_path>/netbackup/logs/bpsynth/log.mmddyy  
(or mmddyy.log)  
-debug log from <install_path>/netbackup/logs/bpcoord/log.mmddyy  
(or mmddyy.log)  
-debug log from <install_path>/netbackup/logs/bpdbm/log.mmddyy (or  
mmddyy.log)  
-debug log from <install_path>/netbackup/logs/bpsched/log.mmddyy  
(or mmddyy.log)  
-debug log from <install_path>/netbackup/logs/vnetd/log.mmddyy (or  
mmddyy.log)
```

The following logs on the media server where the images are read and written from/to are required:

```
-<install_path>/netbackup/logs/bpcd/log.mmddyy (or mmddyy.log)  
-<install_path>/netbackup/logs/bptm/log.mmddyy (or mmddyy.log)  
-<install_path>/netbackup/logs/bpdm/log.mmddyy (or mmddyy.log)
```

Note the `bptm` logs are required only if the images are being read from or written to a tape device. The `bpdm` logs are needed only if the images are being read from or written to disk.

If the images are being read from multiple media servers, the debug logs for `bptm/bpdm` must be collected from each media server.

Try File

Include the try file for the job id from the following directory:

`<install_path>/netbackup/db/jobs/trylogs/<jobid>.t`

For instance, if the job id of the synthetic backup job was 110, then the try file will be named 110.t.

Policy Attributes

Capture the output from the following command and send it to Support with the rest of the information:

```
<install_path>/netbackup/bin/admincmd/bppllist<policy_name> -L
```

where *<policy_name>* is the name of the policy for which the synthetic backup job was run.

List of Storage Units

Capture the output from the following command and send it to Support with the rest of the information:

```
<install_path>/netbackup/bin/admincmd/bpstulist -L
```

Debug Logs on UNIX Clients

To enable debug logging on UNIX clients, create the appropriate directories under:

```
/usr/opensv/netbackup/logs
```

The following table lists the debug log directories that apply to UNIX clients. Also, see the list of facts to be familiar with under “[Debug Logs on Servers](#)” on page 66, because information also applies to UNIX clients.

Note Create the directories with access modes of 777 or user processes cannot write to the log files.

UNIX Client Debug Logs

Debug Log Directory	Associated Process
bp	Menu driven client-user interface program.
bparchive	Archive program. These debug logs are also useful for debugging xbp and bp processes.
bpbackup	Backup program. These debug logs are also useful for debugging xbp and bp processes.
bpbkar	Program used to generate backup images.



UNIX Client Debug Logs (continued)

Debug Log Directory	Associated Process
<code>bpcd</code>	NetBackup client daemon/manager.
<code>bphdb</code>	Program that starts a script to back up a database on a NetBackup database agent client. See the system administrator's guide for the appropriate NetBackup database agent for more information.
<code>bpjava-msvc</code>	NetBackup-Java application server authentication service started by <code>inetd</code> during startup of the NetBackup Java interface applications. This program authenticates the user that started the application.
<code>bpjava-usvc</code>	NetBackup program started by <code>bpjava-msvc</code> upon successful login through the Login dialog box that is presented when a NetBackup-Java interface is started. This program services all requests from the Java administration and user interfaces on the host where <code>bpjava-msvc</code> is running.
<code>bplist</code>	Program that lists backed up and archived files. This debug log is also useful for debugging <code>xbp</code> and <code>bp</code> processes.
<code>bpmount</code>	Program that determines local mount points and wildcard expansion for Multiple Data Streams.
<code>bporaexp</code>	Command-line program on clients to export Oracle data in XML format. Communicates with <code>bprd</code> on server.
<code>bporaexp64</code>	64-bit command-line program on clients to export Oracle data in XML format. Communicates with <code>bprd</code> on server.
<code>bporaimp</code>	Command-line program on clients to import Oracle data in XML format. Communicates with <code>bprd</code> on server.
<code>bporaimp64</code>	64-bit command-line program on clients to import Oracle data in XML format. Communicates with <code>bprd</code> on server.
<code>bprestore</code>	Restore program. These debug logs are also useful for debugging <code>xbp</code> and <code>bp</code> processes.
<code>db_log</code>	For more information on these logs, see the NetBackup guide for the database-extension product that you are using.
<code>mtfrd</code>	These logs have information about the <code>mtfrd</code> process, which is used for phase 2 imports and restores of Backup Exec media.

UNIX Client Debug Logs (continued)

Debug Log Directory	Associated Process
tar	tar process during restores.
user_ops	The user_ops directory is created during the install of NetBackup on all servers and clients. The NetBackup Java interface programs use it for temporary files and for job and progress log files generated by the user backup, archive, and restore program (jbpSA). This directory must exist for successful operation of any of the Java programs and must have public read, write and execute permissions. user_ops will contain a directory for every user that is using the Java programs.

Debug Logs on PC Clients

Debug Logs on Windows and Netware Clients

To enable detailed debug logging on Microsoft Windows or NetWare target clients, create the appropriate directories in the following locations:

Note These are the default locations in which to place these directories. You can specify another location during client installation (see the user guide for the respective client).

- ◆ Windows clients - C:\Program Files\VERITAS\NetBackup\Logs\
- ◆ NetWare clients - SYS:\OPENV\NETBACK\LOGS\

The following table lists the debug log directories that apply to the above clients:

PC Client Debug Logs

Debug Log Directory	NetBackup Client	Associated Process
bp	NetWare target	Client-user interface program for NetWare.
bpinetd	Windows NT/2000/2003	Client service logs. These logs have information on the bpinetd32 process.



PC Client Debug Logs (continued)

Debug Log Directory	NetBackup Client	Associated Process
bparchive	Windows NT/2000/2003, 98, 95	Archive program that is run from the command line.
bpbackup	Windows NT/2000/2003, 98, 95	Backup program that is run from the command line.
bpbkar	Windows NT/2000/2003	Backup and archive manager. These logs have information on the bpbkar32 process.
bpcd	All Windows and NetWare clients	NetBackup client daemon/manager. These logs have information on communications between the server and client. On NetWare and Windows 98 and 95 clients, these logs also contain the log information for the backup and restore processes.
bpjava-msvc	NetBackup-Java application server authentication service started by the Client Services service during startup of the NetBackup Java interface applications. This program authenticates the user that started the application. (On all Windows platforms except 95/98)	bpjava-msvc



PC Client Debug Logs (continued)

Debug Log Directory	NetBackup Client	Associated Process
bpjava-usvc	NetBackup program started by bpjava-msvc upon successful login through the Login dialog box that is presented when a NetBackup-Java interface is started. This program services all requests from the Java administration and user interfaces on the NetBackup host where bpjava-msvc is running.(On all Windows platforms except 95/98)	bpjava-usvc
bplist	Windows NT/2000/2003, 98, 95	List program that is run from the command line.
bpmount	Windows NT/2000/2003, 98, 95	Program used to collect drive names on the client for multistreaming clients.
bprestore	Windows NT/2000/2003, 98, 95	Restore program that is run from the command line.
bpsrv	NetWare nontarget	NetBackup service utility. This program allows the system with the user interface to communicate with the NetBackup for NetWare client.
nbwin	Windows 98, 95	Client-user interface program for Windows 98/95.
nbwin	Windows NT/2000/2003	Client-user interface program for Windows NT/2000.
tar	Windows NT/2000/2003	tar process. These logs have information about the tar32 process.



PC Client Debug Logs (continued)

Debug Log Directory	NetBackup Client	Associated Process
user_ops	Windows NT/2000/2003, 98, 95	The user_ops directory is created during the install of NetBackup on all servers and clients. The NetBackup Java interface programs use it for temporary files and for job and progress log files generated by the user backup, archive, and restore program (jbpSA). This directory must exist for successful operation of any of the Java programs and must have public read, write and execute permissions. user_ops will contain a directory for every user that is using the Java programs.

Before using the debug logs, note the following:

- ◆ For Windows clients, logs are kept for the number of days specified in the Backup, Archive, and Restore interface, under the **File>NetBackup Client Properties>General** tab: “**Keep status of user-directed backups, archives, and restores for.**” For NetWare clients, logs are kept the number of days specified in file `openv\netback\bp.ini` (under `Keep_Log_Days`).

The currently active logs have names of the form:

mmdyy.log

For example, `120198.log`.

- ◆ You can increase the amount of information that processes write in the logs.
 - ◆ On Windows clients, set the debug level on the **TroubleShooting** tab of the NetBackup Client Properties dialog. To open this dialog, start the Backup, Archive, and Restore interface and click **NetBackup Client Properties** on the **File** menu. For instructions, see the NetBackup user guide for the client.
 - ◆ On NetWare clients, change the value of the `level` and `tcp` parameters in the debug section of the `bp.ini` file. For instructions, see the NetBackup user guide for the client.

Note Increasing the log level can cause the logs to grow very large, so take this action only if unexplained problems exist.

Media Manager Logs

Media Manager logging is different on UNIX than on Windows.

On UNIX

Media Manager on a UNIX system automatically records robotic and network errors in the system logs by using `syslogd`. System log entries are also made when robotically controlled drives change between UP and DOWN states.

Note You must enable system logging to troubleshoot `ltid` or robotic software. See the `syslogd(8)` man page for information on setting up system logs.

If a problem requires more information, enable debug logging to the system logs by including the verbose option (`-v`) on the command that you use to start a daemon. This command can be:

- ◆ The `ltid` command that started the device management processes. If the `-v` option is included on the `ltid` command, all daemons started as a result also have the `-v` option in effect.

or

- ◆ A command to start a specific daemon (for example, `acsd -v`). Alternatively, put a `VERBOSE` entry in the Media Manager configuration file, `/usr/opensv/volmgr/vm.conf`, and restart `ltid` (create the `vm.conf` file if necessary).

See the `syslogd` man page for the locations of system log messages. Errors are logged with `LOG_ERR`, warnings with `LOG_WARNING`, and debug information with `LOG_NOTICE`. The facility type is `daemon`.

To enable debug logging for the Media Manager Volume daemon (`vmd`), create the following directories before starting `vmd` (or stop and restart `vmd` after creating them):

```
/usr/opensv/volmgr/debug/daemon
```

(Debug information on the daemon)

```
/usr/opensv/volmgr/debug/reqlib
```

(Debug information on the process requesting the daemon)

```
/usr/opensv/volmgr/debug/tpcommand
```

(Debug information on the `tpconfig` and `tpautoconf` commands)

```
/usr/opensv/volmgr/debug/ltid
```

(Debug information on `ltid`)



```
/usr/opensv/volmgr/debug/acssi
```

(Debug information on transactions between NBU and the Storage Tek ACSLS server)

Media Manager creates one log per day in each of the debug directories with file names of the form:

```
log.mmdyy
```

For example:

```
log.110894
```

To disable `vm` debug logging, either delete the `/usr/opensv/volmgr/debug/daemon` directory or rename it. This directory continues to accumulate information until you either rename or delete it.

Media Manager retains debug logs for the number of days you specify with the `DAYS_TO_KEEP_LOGS =` entry in the `vm.conf` file. (The default is infinite retention.) For instructions on using this entry, see the *NetBackup Media Manager System Administrator's Guide*.

Note On HP-UX, the `sysdiag` tool may provide additional information on hardware errors. On Compaq Tru64 the `uerf` command may provide additional information on hardware errors.

On Windows

On Windows, Media Manager records robotic and drive errors in the Event Viewer Application log. Log entries are also made when drives change between the UP and DOWN states.

If a problem requires more information, increase the level of logging to the Event Viewer Application log by adding a `VERBOSE` entry to the following file:

```
install_path\Volmgr\vm.conf
```

In addition, you can enable debug logging for the NetBackup Volume Manager service by creating the following directories:

```
install_path\Volmgr\debug\daemon
```

(Debug information on the service)

```
install_path\Volmgr\debug\reqlib
```

(Debug information on the process requesting the service)

```
install_path\Volmgr\debug\tpcommand
```

(Debug information on the `tpconfig` and `tpautoconf` commands)

```
install_path\Volmgr\debug\ltid
```

(Debug information on `ltid`)

NetBackup creates one log per day in each of the above debug directories with file names of the form:

```
mmddyy.log
```

For example:

```
110894.log
```

To disable debug logging for the NetBackup Volume Manager service, either delete or rename the directories.

Media Manager retains debug logs for the number of days you specify with the `DAYS_TO_KEEP_LOGS` = entry in the `vm.conf` file. (The default is infinite retention.) For instructions on using this entry, see the *NetBackup Media Manager System Administrator's Guide*.

Windows Event Viewer Logging Option

NetBackup Windows master servers can be configured so messages from NetBackup reports are written to the Windows Event Viewer Application Log. This allows you to see these messages in the Application Log and also to use third party tools to monitor the Application Log for these messages.

Enabling the Logging Tool

▼ To enable the logging tool

1. Create the following file on the NetBackup master server:

```
install_path\NetBackup\db\config\eventlog
```

2. Add an entry (optional) to the `eventlog` file that specifies the severity and type of NetBackup messages that are written. The following is an example:

```
56 255
```

The next topic explains the format of the entry. If you do not add an entry, a default value is used, which is also explained in the next topic.



eventlog File Entries

The `eventlog` entry has two parameters:

- ◆ The first parameter controls which messages NetBackup writes to the Application Log, based on severity level.
- ◆ The second parameter controls which type of messages NetBackup writes to the Application Log.

Both parameters are specified as decimal numbers and equate to a bitmap that expresses the values below:

Severity:

1 = Unknown

2 = Debug

4 = Info

8 = Warning

16 = Error

32 = Critical

Type:

1 = Unknown

2 = General

4 = Backup

8 = Archive

16 = Retrieve

32 = Security

64 = Backup Status

128 = Media Device

- ◆ If the file is empty, the default severity is Error (16) and the default type is Backup Status (64).
- ◆ If the file has only one parameter, it is used for the severity level and the default value of Backup Status (64) is used for the type.

Example

Assume you want to include all types of messages that have severity levels of warning, error, and critical. In this instance, the entry is:

```
56 255
```

Where:

56 = severity= the sum of warning, error, and critical (8 + 16 + 32)

255 = type = the sum of all types (1 + 2 + 4 + 8 + 16 + 32 + 64 + 128)

The following is an example of a message written in the Windows Event Viewer Application Log:

```
16 4 10797 cacao bush bpsched backup of client bush exited with status
71
```

The meaning of each field is as follows (left to right):

severity - 16 (Error)

type - 4 (Backup)

jobid - 10797

server - cacao

client - bush

process - bpsched

text - backup of client bush exited with status 71

Troubleshooting the Administration Console for UNIX

Most errors that occur in the NetBackup Administration Console for UNIX appear in an attention dialog. Those that appear elsewhere are Java exception errors (which are not documented in this guide); they may appear in the status line (bottom) of the NetBackup Administration window, or in the log file that contains `stdout` or `stderr` messages written by Java APIs or by the NetBackup Administration Console.

The following are the four kinds of error messages seen in the NetBackup Administration Console.

- ◆ NetBackup status codes and messages as documented in [Chapter 5](#).

Operations performed in the Administration Console can result in errors recognized in other parts of NetBackup. These errors usually appear exactly as documented in [Chapter 4](#).



Note The error message is not always accompanied by a status code. You can find the status code by looking up the message in the alphabetical listing at the end of Chapter 4. Then use the status code to find the full description of the message in the first half of Chapter 4.

- ◆ NetBackup Administration Console: application server status codes and messages as documented in [Chapter 5](#).

These messages have status codes in the 500 range. Messages with status codes 500, 501, 502, 503 and 504 begin with "Unable to login, status:". Messages with status codes 511 and 512 may or may not begin with "Unable to login, status:".

The message is not always accompanied by a status code (see the above note).

- ◆ Java exceptions

These are generated by either the Java APIs or by NetBackup Administration APIs. These messages begin with the name of the exception. For example:

```
java.lang.ClassCastException
```

or

```
vrts.nbu.NBUCommandExecutionException
```

Java exceptions usually appear in one of three places:

- ◆ In the status line (bottom) of the NetBackup Administration window
 - ◆ In the log file generated by the `jnbSA` or `jbpSA` commands
 - ◆ When set up, in the output file of the Windows Display Console `.bat` file (see ["Enabling Detailed Debug Logging"](#) below, for more detail)
 - ◆ Operating system errors
- Messages that do not match those documented in this manual are probably operating system errors.

Disk Space Needed for Logging and Temporary Files

The Administration Console requires disk space in the following locations for successful operation:

- ◆ On the host specified in the login dialog
- ◆ In `/usr/opensv/netbackup/logs/user_ops`
- ◆ On the host where the Console was started
- ◆ In `/usr/opensv/java/logs`

If space is not available in the respective file systems, you may experience long waits for application response, incomplete data, reduced functionality, and/or unexpected error messages may be returned. Below are some of the results you may receive:

- ◆ No response during login
- ◆ Cannot connect socket errors during login to the NBJava application server
- ◆ Reduced functionality in the GUI, for example, only the Backup, Archive, and REstore and Files System Analyzer nodes appear in the tree
- ◆ An error dialog with the “Unable to login, status: 35 cannot make required directory” message.
- ◆ An error dialog with “/bin/sh: null: not found (1) ”message.
- ◆ Empty warning dialogs
- ◆ An error dialog with the message “An exception occurred: vrts.nbu.admin.bpmgmt.CommandOutputException: Invalid or unexpected class configuration data: <the rest of the message will vary>”

Enabling Detailed Debug Logging

The NetBackup Administration Console is a distributed application that allows administration of remote NetBackup servers. All administration is accomplished via the *application server* of the NetBackup Administration Console. This application server is made up of an authentication service and a user service.

The login request from the login dialog is sent to the authentication service for validation. The user name and password have to be valid in the Windows/UNIX authentication files/process.

After validation, the authentication service starts a user service under the user’s account. Thereafter, all NetBackup administrative tasks are performed through an instance of the user service. Additional user service processes will get initiated to process requests from the Console.

On both UNIX and Windows, the authentication service is the `bpjava-msvc` application and the user service is the `bpjava-susvc` or `bpjava-usvc` application.



▼ **To enable detailed debug logging**

1. On the NetBackup client or server specified in the login dialog, create the `bpjava-msvc`, `bpjava-susvc` (if a NetBackup server), and `bpjava-usvc` (if a NetBackup client) debug log directories in the `/usr/opensv/netbackup/logs` directory (UNIX) or in `install_path\NetBackup\logs` (Windows). Refer to “[Debug Logs](#)” earlier in this chapter for more information.

2. On the UNIX machine where you execute the `jnbSA` or `jbpSA` commands, add the following line to the `Debug.properties` file in the `/usr/opensv/java` directory.

```
debugLevel=2
```

The log file name is displayed in the xterm window where you executed the `jnbSA` or `jbpSA` commands.

3. If you are using the NetBackup Windows Display Console, add the following line to the `host_name.properties` file in the NetBackup Java installed folder (for example, `C:\VERITAS\java`):

```
debugLevel=2
```

4. If you are using the Windows Display Console, you should also add the following to the end of the last command in the `associate.bat` file in the NetBackup Java installed folder:

```
jnbdebug
```

This redirects output to a file.

Using NetBackup Utilities

4

Several utilities are available to NetBackup users to help with diagnosing NetBackup problems. The Analysis Utilities for NetBackup Debug Logs, and the NetBackup Configuration Validation Utility, described below, are especially germane to troubleshooting.

The NetBackup Configuration Validation Utility (NCVU), is available as a download from the VERITAS support website, www.support.veritas.com. Go to **Services --> Support, or Downloads --> Support Downloads** and enter the appropriate information.

Analysis Utilities for NetBackup Debug Logs

The debug log analysis utilities enhance NetBackup's existing debug capabilities by providing a consolidated view of a job debug log. The first release (post version 4.5) of these utilities supported backup and restore jobs. Support has been extended to all job types, including Vault, Alternate Backup Method (ABM), and database extensions, as well as command line utilities such as `bpduplicate`, `bpbackupdb`, `bpimport`, and `bpverify`.

NetBackup jobs span multiple processes distributed across servers. The debug logs produced by each process reside in an isolated directory on the host on which the process is executed. To trace a NetBackup job requires viewing and correlating messages in multiple log files on multiple hosts. The log analysis utilities provide a consolidated view of the job debug log(s) by scanning the logs for all processes traversed/executed for the job. The utilities can consolidate job information by client, job ID, start time for the job, and policy associated with the job.

The available utilities are:

- ◆ `backuptrace` will copy to standard output the debug log lines relevant to the specified backup job[s]
- ◆ `restoretrace` will copy to standard output the debug log lines relevant to the specified restore job[s]
- ◆ `bpgetdebuglog` is a helper program for `backuptrace` and `restoretrace`



- ◆ `backupdbtrace` consolidates the debug log messages for specified NetBackup database backup jobs and writes them to standard output.
- ◆ `duplicatetrace` consolidates the debug logs for the specified NetBackup duplicate jobs and writes them to standard output.
- ◆ `importtrace` consolidates the debug log messages for the specified NetBackup import jobs and writes them to standard output.
- ◆ `verifytrace` consolidates the debug log messages for the specified verify job[s] and writes them to standard output.

Installation Requirements

To install the log analysis utility, first download the tar file from the VERITAS NetBackup support web site (www.support.veritas.com).

Currently the log analysis utilities are available for HP/UX 11 (`hp_ux`), AIX 5 (`rs6000`), Solaris (`solaris`), and Windows NT/2000 (`nt/x86`). Because of shared library dependencies, the utilities will only run on machines that have NetBackup 4.5 or greater server software installed.

Note Even though the utilities have to be initiated on a supported platform, they can still analyze debug log files from most NetBackup 4.5 UNIX and Windows NT/2000 client and server platforms.

Output Format

The format of an output line is:

daystamp.millisecs.program.sequence machine log_line

daystamp	The day of the log in <code>yyyymmdd</code> format.
millisecs	The number of milliseconds since midnight on the local machine.
program	The name of program (<code>BPCD</code> , <code>BPRD</code> , etc.) being logged.
sequence	Line number within the debug log file.
machine	The name of the NetBackup server or client.
log_line	The line that actually appears in the debug log file.

Limitations

While the log analysis utilities cover a variety of logs, the following exceptions occur.

- ◆ Media Manager logs are not analyzed.
- ◆ Windows 95/98 and Mac OS 8/9 client logs may not be analyzed. The server logs for a Windows 95/98 or Mac OS 8/9 backup or restore jobs will be analyzed.
- ◆ The debug log files must be in standard locations on the servers and clients.
`/usr/opencv/netbackup/logs/<PROGRAM_NAME>/log.mmddyy` on UNIX and
`<install_path>/NetBackup/Logs/<PROGRAM_NAME>/mmddyy.log` on Windows. We may add an option later that allows the analyzed log files to reside on alternate paths.
- ◆ `bpgetdebuglog` has shared library dependencies that require that it be run on a machine with NetBackup 4.5 server software installed.
- ◆ The consolidated debug log may contain messages from unrelated processes. You can ignore messages from `bprd`, `bpsched`, `bpdbm`, `bpbrm`, `bptm`, `bpdm`, and `bpcd` with timestamps that are outside the duration of the job.

How to Run the Log Analysis Utilities

This section describes a bit about each utility and the conditions for using each utility. For each command's parameters, limitations, and examples of use, please see the *NetBackup Manpages Commands* manual, or use command in `-help` option.

backuptrace

The `backuptrace` utility can be used for regular file system, database extension, and alternate backup method backup jobs. It consolidates the debug logs for specified NetBackup jobs. The debug log messages relevant to the specified jobs will be written to standard output and the messages will be sorted by time. `backuptrace` will attempt compensate for time zone changes and clock drift between remote servers and clients. The output is formatted so that it should be relatively easy to sort or `grep` by time stamp, program name, and/or server/client name.

To use `backuptrace`, at a minimum you must enable debug logging for `bpsched` on the master server. You should enable debug logging for `bpbrm` and `bptm/bpdm` on the media server and `bpbkar` on the client. For best results, set the verbose logging level to 5. Enable debug logging for `bpdbm` and `bprd` on the master server and for `bpcd` on all servers and clients in addition to the processes already identified.

This command requires administrative privileges.



restoretrace

`restoretrace` consolidates the debug logs for specified NetBackup restore jobs. The debug log messages relevant to the specified jobs will be written to standard output and the messages sorted by time. `restoretrace` will attempt to compensate for time zone changes and clock drift between remote servers and clients. The output is formatted so that it should be relatively easy to sort or `grep` by time stamp, program name, and/or server/client name.

At a minimum, you must enable debug logging for `bprd` on the master server. Enable debug logging for `bpbrm` and `bptm/bpdm` on the media server and `tar` on the client. For best results, set the verbose logging level to 5. Enable debug logging for `bpdbm` on the master server and for `bpcd` on all servers and clients.

This command requires administrative privileges.

bpgetdebuglog

`bpgetdebuglog` is a helper program for `backuptrace` and `restoretrace`. It can also be useful as a standalone program. It is available for all NetBackup server platforms. `bpgetdebuglog` will print to standard output the contents of a specified debug log file, or, if only the remote machine parameter is specified, `bpgetdebuglog` will print to standard output the number of seconds of clock drift between the local machine and the remote machine.

This command requires administrative privileges.

backupdbtrace

`backupdbtrace` consolidates the debug log messages for specified NetBackup database backup jobs and writes them to standard output. The messages will be sorted by time. `backupdbtrace` will attempt to compensate for time zone changes and clock drift between remote servers and clients.

At a minimum, you must enable debug logging for `admin` on the master server, and for `bptm` and `bpbkar` on the media server. For best results, set the verbose logging level to 5 and enable debug logging for `bpdbm` on the master server and `bpcd` on all servers in addition to the processes already identified.

This command requires administrative privileges.

duplicatetrace

`duplicatetrace` consolidates the debug logs for the specified NetBackup duplicate jobs and writes them to standard output. The messages will be sorted by time.

`duplicatetrace` will attempt to compensate for time zone changes and clock drift between remote servers and clients.

At a minimum, you must enable debug logging for `admin` on the master server and for `bptm/bpdm` on the media server. For best results, set the verbose logging level to 5 and enable debug logging for `bpdbm` on the master server and `bpcd` on all servers and clients in addition to the processes already identified.

This command requires administrative privileges.

importtrace

`importtrace` consolidates the debug log messages for the specified NetBackup import jobs and writes them to standard output. The messages will be sorted by time.

`importtrace` will attempt to compensate for time zone changes and clock drift between remote servers and clients.

At a minimum, you must enable debug logging for `admin` on the master server, and for `bpbrm`, `bptm` and `tar` on the media server. For best results, set the verbose logging level to 5 and enable debug logging for `bpdbm` on the master server and `bpcd` on all servers and clients in addition to the processes already identified.

This command requires administrative privileges.

verifytrace

`verifytrace` consolidates the debug log messages for the specified verify job[s] and writes them to standard output. The messages will be sorted by time. `verifytrace` will attempt to compensate for time zone changes and clock drift between remote servers and clients.

At a minimum, you must enable debug logging for `admin` on the master server, and for `bpbrm`, `bptm/bpdm` and `tar` on the media server. For best results, set the verbose logging level to 5 and enable debug logging for `bpdbm` on the master server and `bpcd` on all servers and clients in addition to the processes already identified.

This command requires administrative privileges.



NetBackup Configuration Validation Utility (NCVU)

NCVU and NCVU_WIN are VERITAS support utilities used to validate NetBackup and associated operating system configurations and functionality. They are available as downloads from the Support Downloads section of the VERITAS support website, www.support.veritas.com.

Refer to the NCVU.README and the NCVU_WIN.README files for a list of supported operating systems and installation instructions. NCVU and NCVU_WIN are self-documenting. To obtain information about the utilities, run NCVU or NCVU_WIN with the `-help` command line switch.

When to use NCVU or NCVU_WIN

Use NCVU or NCVU_WIN to create a baseline of information associated with a known good NetBackup configuration. You can then use this baseline information for comparison if you run into trouble with your NetBackup configuration.

We recommend you run NCVU or NCVU_WIN periodically to document changes in the NetBackup or related operating system environment.

You can also run NCVU or NCVU_WIN as a step in many troubleshooting procedures to help isolate a NetBackup or operating system issue. A reference to NCVU is included in the status code descriptions where running it may provide additional diagnostic information.

NetBackup Status Codes and Messages

5

This chapter lists all the status codes and messages provided by NetBackup. (For Media Manager codes, see “[Media Manager Status Codes](#)” on page 311). There are two parts to the chapter:

- ◆ The first section, “[Status Codes](#)”, lists the NetBackup status codes in numerical order and includes an explanation of what occurred along with recommended actions.
- ◆ The second section, “[Messages](#)”, lists the same status codes but sorts them alphabetically according to the message. Only the messages and status codes are included in the second section.

If you see a status code without its associated message text, you can determine the message, its explanation and recommended action by using the `bpperror` command:

On UNIX systems:

```
/usr/opensv/netbackup/bin/admincmd/bpperror -statuscode statuscode [-recommendation]
```

On Windows systems:

```
install_path\NetBackup\bin\admincmd\bpperror -statuscode statuscode [-recommendation]
```

where *statuscode* is the number of the message.

Example:

On UNIX: `/usr/opensv/netbackup/bin/admincmd/bpperror -statuscode 150`

On Windows: `install_path\NetBackup\bin\admincmd\bpperror -statuscode 150`

```
termination requested by administrator
```

```
The process is terminating (or has terminated) as a direct result of a request from an authorized user or process.
```



Status Codes

Note The term *media server*, as distinct from *master server* or *server*, does not apply to the NetBackup Server product. When troubleshooting a Server installation, please ignore any references to media server.

NetBackup Status Code: 0

Message: the requested operation was successfully completed

Explanation: There were no problems detected with the requested operation.

Recommended Action: None, unless this was a database backup performed through a database extension product (for example, NetBackup for Oracle or NetBackup for SQL Server). In those instances, code 0 means the backup script that started the backup ran without error. However, you must check other status as explained in the related NetBackup manual to see if the database was successfully backed up.

NetBackup Status Code: 1

Message: the requested operation was partially successful

Explanation: A problem that may require corrective action was detected during the requested operation.

Recommended Action: Check the All Log Entries report and also the progress log (if there is one).

Some of the problems that can show up under status code 1 are:

- ◆ A file or directory path that is more than 1023 characters long.

For NetBackup Advanced Client: the maximum path name length is 1000 characters for snapshot backups, not 1023. When the snapshot is created, a new mount point is added to the beginning of the file path. If this new mount point plus the original file path exceeds 1023 characters, the backup fails with status code 1. The progress log includes the entry "ERR - Skipping long dir path."

- ◆ Could not open a file.

The file may have been locked for some reason.

- ◆ On a UNIX system, NetBackup could not get the link name of a file.
- ◆ On a UNIX system, NetBackup could not process a sparse file.
- ◆ Read error encountered in a file.
- ◆ File is of an unknown type, or may be hidden.

- ◆ On a UNIX system, the `lstat` system call fails on a file that is eligible to be backed up. This may be a permission problem.
- ◆ On a UNIX system, a file could not be locked that has mandatory locking enabled.
- ◆ A Vault job may terminate with status code 1 if non-fatal errors are encountered during one or more of the following operations:
 - ◆ duplication
 - ◆ suspension of unvaulted media
 - ◆ expiration of disk images
 - ◆ execution of `vlt_ejectlist_notify` script
 - ◆ catalog backup
 - ◆ eject and/or report

In the event of a non-fatal error, Vault will attempt to complete all the steps configured in the vault profile.

Identify which of the above operations encountered an error by reviewing the `summary.log` file in each of the `sidxxx` directories that had problems:

On UNIX: `/usr/opensv/netbackup/vault/sessions/vault_name/sidxxx`

On Windows:

`install_path\NetBackup\vault\sessions\vault_name\sidxxx`

(where `xxx` is the session id)

Or review the vault debug log file in the following directory:

On UNIX: `/usr/opensv/netbackup/logs/vault`

On Windows: `install_path\NetBackup\logs\vault`

Correct the problem and rerun the vault job.

- ◆ A synthetic backup job may terminate with a status code 1 under the following conditions:
 - ◆ No images were found to synthesize (status code = 607)
 - ◆ TIR info has been pruned from component images (status code = 136)
 - ◆ Image format is unsupported (status code = 79)

The synthetic backup job will log the actual status code in the NetBackup error log. Please refer to the documentation for the corresponding NetBackup error code for the corrective action to take.



- ◆ If a scheduled backup of a UNIX database extension client started via a policy that contains multiple backup scripts fails with a status code 1, it means that some of the backup scripts returned a failure status.
- ◆ On NetBackup 5.0 or later clients using Windows Open File Backups (WOFB) to back up open or active files, volume snapshots may not have been enabled successfully for the backup. The following logging messages should appear in the bpbkar32 logs if volume snapshots could not be successfully enabled.

If multi-streamed backup jobs are enabled, log messages similar to the one below would appear, indicating volume snapshots were not enabled for the multi-streamed backup job:

```
11:05:44.601 AM: [1536.724] <4> tar_backup::V_AddToFI_XBSAObj: INF
- Volume snapshots not enabled for: D:\Directory1
```

If multi-streamed backups were not enabled, log messages similar to the one below would appear, indicating volume snapshots were not enabled for the non-streamed backup job:

```
1:59:41.229 PM: [2076.2088] <4>
V_Snapshot::V_Snapshot_CreateSnapshot: INF -
=====
1:59:41.229 PM: [2076.2088] <4>
V_Snapshot::V_Snapshot_CreateSnapshot: INF - Attempting to create
snapshots for D:\Directory1
1:59:41.229 PM: [2076.2088] <4>
V_Snapshot::V_Snapshot_CreateSnapshot: INF - CREATE request:
C:\Program Files\VERITAS\NetBackup\bin\bpfis create -fim VSP "D:\
Directory1"
1:59:41.799 PM: [2076.2088] <4>
V_Snapshot::V_Snapshot_ParseBpfisOutput: INF - Snapshot creation,
FIS_ID: 1058813981
1:59:41.799 PM: [2076.2088] <4>
V_Snapshot::V_Snapshot_ParseBpfisOutput: INF - Snapshot creation
EXIT STATUS 11: system call failed
1:59:41.799 PM: [2076.2088] <4>
V_Snapshot::V_Snapshot_CreateSnapshot: INF - Snapshot creation was
not successful
1:59:41.799 PM: [2076.2088] <4>
V_Snapshot::V_Snapshot_CreateSnapshot: INF -
=====
```

If this is the case, examine the `online_util` logs for error log messages regarding snapshot creation failures (Please see the *NetBackup Advanced Client System Administrator's Guide* for more details on the `online_util` logs).

In the `online_util` logs, the following logs messages may appear when snapshot creation fails for Windows Open File Backup:

1)

```
04:01:14.168 [376.2364] <32> onlfi_fi_split: VfMS error 11; see
following messages:
04:01:14.168 [376.2364] <32> onlfi_fi_split: Fatal method error was
reported
04:01:14.168 [376.2364] <32> onlfi_fi_split: vfm_freeze_commit:
method: VSP, type: FIM, function: VSP_make
04:01:14.168 [376.2364] <32> onlfi_fi_split: VfMS method error 3;
see following message:
04:01:14.168 [376.2364] <32> onlfi_fi_split: VERITAS Frozen Image
Services: snapshot creation failed: invalid argument(s).
```

Cause: VSP could not be enabled because the VSP snapshot for the backup could not meet the minimum time specified in the Busy File Wait setting for VSP.

Recommended action: Either increase the Busy File Timeout VSP setting (recommended setting: 300 seconds or more) or resubmit the backup job when there is less activity on the volume.

2)

```
04:17:55.571 [1636.3224] <2> onlfi_vfms_logf: VERITAS Frozen Image
Services: (null): There was an unexpected error while preparing the
VSP snapshot transaction. Dumping the parameter array to provide
more information: Error 112 from VSP_Prepare
```

Cause: VSP could not be enabled for the backup because there is not enough free disk space on the client for the VSP Snapshot Cache files.

Recommended action: Free up some disk space on the volumes being backed up.

3)

If Microsoft Volume Shadow Copy Service (VSS) is used as the Windows Open File Backup snapshot provider and snapshot creation fails, please refer to your Event Viewer's Application and System Logs for error information.

- ◆ With NetBackup 5.0 or later installed and clients that use the Windows Open File Backup option to back up open or active files, a snapshot error may have occurred. If this is the case, a log message in the bpbkar32 debug log will appear indicating a snapshot error has occurred. For example:

```
8:51:14.569 AM: [1924.2304] <2> tar_base::V_vTarMsgW: ERR
-Snapshot Error while reading test.file
```

See the recommended actions under status code 156.



NetBackup Status Code: 2

Message: none of the requested files were backed up

Explanation: A backup or archive could not back up any of the files in the file list.

Recommended Action: Verify that the files exist and you have read access to them.

- ◆ Check to see if there is a trailing space on one or more of the filenames in the client's file list. Remove any inadvertent trailing characters (such as spaces or tabs).
- ◆ On UNIX clients, check to see if the files or directories would be excluded because of an entry in `/usr/opensv/netbackup/exclude_list`.
- ◆ On PC clients, check the exclude list per the instructions in the user's guide for the client.
- ◆ On Windows clients, verify that the account used to start the NetBackup Client service has read access to the files.

If you are backing up a network drive or a UNC (universal naming convention) path, use the Services application in the Windows Control Panel to verify that the NetBackup Client service does not start under the SYSTEM account. The SYSTEM account cannot access network drives.

To back up network drives or UNC paths, change the NetBackup Client service startup to log in as a user that has permission to access network drives.

NetBackup Status Code: 3

Message: valid archive image produced, but no files deleted due to non-fatal problems

Explanation: The backup portion of the archive command reported problems so the files were not deleted.

Recommended Action: Examine the progress log or status of the archive on the client to determine if you need to retry the archive after correcting the problem. If the problem is not serious and the files were backed up, you can manually delete the files. To verify which files were backed up, use the NetBackup client-user interface in restore mode and browse the files in the archive.

A possible cause for files not being deleted is that you do not have the necessary permissions. NetBackup cannot delete files unless you are either the user that owns the files, a superuser on UNIX, or an administrator on Windows.

NetBackup Status Code: 4

Message: archive file removal failed

Explanation: The backup portion of the archive completed was successful but the delete failed.



Recommended Action: Verify that you have permission to delete the files and that the read-only flag is not set for the files. On UNIX clients, verify that you have write permission to the directories that contain the files. Since the backup was successful, you can delete the files that were backed up (or have the system administrator delete the files if you do not have the necessary permissions).

NetBackup Status Code: 5

Message: the restore failed to recover the requested files

Explanation: There were errors that caused the restore to fail.

Recommended Action:

1. Ensure that the client's server list contains entries for the master server and for any media servers that could be used during a backup or restore.
2. Examine the status or progress log on the client for messages on why the restore failed. Also, check the All Log Entries report on the server.
3. Check ownership and permission on directories where files will be restored.
4. Correct problems that you find and retry the restore.
5. For OpenVMS clients, make sure the NetBackup client software is version 3.4 or higher.
6. If you receive status code 5 when attempting to restore files from a FlashBackup backup after a NetBackup patch was installed, the patch may not have been installed properly. Follow the installation instructions in the patch README file and make sure the `libsfr.so` file is copied as instructed.

NetBackup Status Code: 6

Message: the backup failed to back up the requested files

Explanation: Errors caused the user backup to fail.

Recommended Action:

1. Verify that you have read access to the files. Check the status or progress log on the client for messages on why the backup failed. Correct problems and retry the backup.
2. On Windows clients, verify that the account used to start the NetBackup Client service has read access to the files.



3. On Macintosh clients, this code can be due to multiple backups being attempted simultaneously on the same client. Some possible solutions are:
 - ◆ Adjust the backup schedules.
 - ◆ If the client is only in one policy, set the policy attribute, **Limit jobs per policy**, to 1.
 - ◆ Set the NetBackup global attribute, **Maximum jobs per client**, to 1 (note that this limits all clients in all policies).
4. For a UNIX database extension client (for example, NetBackup for Oracle), this can mean a problem with the script that is controlling the backup.

Check the progress report on the client for a message such as `Script exited with status code = number` (the number will vary). The progress log also usually names the script.

Check the script for problems. Also, check the troubleshooting logs created by the database extension. See the NetBackup guide that came with the database extension for information on the scripts and troubleshooting logs.

NetBackup Status Code: 7

Message: the archive failed to back up the requested files

Explanation: Errors caused the user archive to fail.

Recommended Action: Verify that you have read access to the files. Check the progress log or the status on the client for messages on why the archive failed. Correct problems and retry the archive.

On Windows clients, verify that the account used to start the NetBackup services has read access to the files.

NetBackup Status Code: 8

Message: unable to determine the status of `rbak`

Explanation: On DomainOS clients, `rbak` is used to do restores. If `rbak` does not exit with a status message, NetBackup cannot determine whether the restore worked or not.

Recommended Action: Check for a new core file to see if `rbak` aborted. Check the `ps` output to see if `rbak` is hung. If so, kill it and try again. Check the progress log for any unusual messages from `rbak`.

NetBackup Status Code: 9

Message: an extension package is needed, but was not installed

Explanation: A NetBackup extension product is required in order to perform the requested operation.

Recommended Action: Install the required extension product.

NetBackup Status Code: 10

Message: allocation failed

Explanation: Allocation of system memory failed because there is insufficient system memory available. This could be caused by the system being overloaded with too many processes and not enough physical or virtual memory.

Recommended Action: Free up memory by terminating unneeded processes that consume memory. Add more swap space or physical memory.

NetBackup Status Code: 11

Message: system call failed

Explanation: A system call failed. This status code is used for a generic system call failure that does not have its own status code.

Recommended Action:

1. Check the All Log Entries and Problems reports to determine which system call failed and other information about the error.
2. For NetBackup Advanced Client:
 - ◆ The file system specified as a snapshot source is not mounted. In this case, you may see the following in the `/usr/opensv/netbackup/logs/bpfis` log:

```
17:12:51 bpfis: FTL - snapshot processing failed, status 11
17:12:51 bpfis: ERR - bpfis FATAL exit status = 11: system call failed
17:12:51 bpfis: INF - EXIT STATUS 11: system call failed
```

and the following in the `/usr/opensv/netbackup/logs/online_util` log:

```
17:12:51 onlfi_vfms_logf: INF - cannot snap_on, err: 5
17:12:51 delete_mount_point: INF - Deleted mount point
/tmp/___jody_test:20958
17:12:51 onlfi_freeze: FTL - VfMS error 11; see following messages:
17:12:51 onlfi_freeze: FTL - Fatal method error
17:12:51 onlfi_freeze: FTL - vfm_freeze: method: nbu_snap, type: FIM,
function: nbu_snap_freeze
17:12:51 onlfi_freeze: FTL - VfMS method error 5; see following message:
17:12:51 onlfi_freeze: FTL - nbu_snap_freeze: Cannot turn on snapshot;
snapshot source=/opt, cache=/dev/rdisk/clt3d1s0, snap error=5
17:12:51 onlfi_thaw: WRN - / is not frozen
```

Make sure that the file system specified for the snapshot source has been mounted.



- ◆ The file system specified as the snapshot source does not correspond to the file system that contains the actual files (as opposed to symbolic links to the files). The mounted file system for the snapshot source must contain the actual files, not symbolic links. If items in the file list, such as `/oracle/datafile` and `/oracle`, are actually symbolic links to `/export/home/oracle`, the snapshot source must specify `/export`, or `/export/home`, not `/oracle`.
- ◆ **vxvm** is selected as the snapshot method but the snapshot source is not configured over a VERITAS Volume Manager VxVM volume. In this case, you may see the following in the `/usr/opensv/netbackup/logs/bpfis` log:

```
17:12:51 bpfis main: FTL - snapshot processing failed, status 11
17:12:51 bpfis Exit: ERR - bpfis FATAL exit status = 11: system call failed
17:12:51 bpfis Exit: INF - EXIT STATUS 11: system call failed
```

and something like the following in the `/usr/opensv/netbackup/logs/online_util` log:

```
17:12:51 onlfi_vfms_logf: INF - vxvm_freeze: Snapshot source /cockpit1
on device /dev/dsk/clt0d0s6 is not on a VxVM volume
17:12:51 delete_mount_point: INF - Deleted mount point
/tmp/_cockpit1_coc_group1:3518
17:12:51 onlfi_freeze: FTL - VfMS error 11; see following messages:
17:12:51 onlfi_freeze: FTL - Fatal method error
17:12:51 onlfi_freeze: FTL - vfm_freeze: method: vxvm, type: FIM, function:
vxvm_freeze
17:12:51 onlfi_freeze: FTL - VfMS method error 9; see following message:
17:12:51 onlfi_freeze: FTL - vxvm_freeze: Snapshot source /cockpit1 on
device /dev/dsk/clt0d0s6 is not on a VxVM volume
17:12:51 onlfi_thaw: INF - fim=vxvm
17:12:51 onlfi_thaw: WRN - /cockpit1 is not frozen
```

Make sure that the snapshot source is configured over a VERITAS Volume Manager VxVM volume.

- ◆ **vxvm** was selected as the snapshot method, but a VERITAS Volume Manager snapshot mirror of the snapshot source volume had not been created prior to running the backup, or another backup is currently running that is using the snapshot mirror. In either case, you may see the following in the `/usr/opensv/netbackup/logs/online_util` log:

```
17:12:51 onlfi_freeze: FTL - VfMS error 11; see following messages:
17:12:51 onlfi_freeze: FTL - Fatal method error
17:12:51 onlfi_freeze: FTL - vfm_freeze: method: vxvm, type: FIM, function:
vxvm_freeze
17:12:51 onlfi_freeze: FTL - VfMS method error 3; see following message:
17:12:51 onlfi_freeze: FTL - find_ready_snapshot: Cannot find available
snapshot mirror
```

Refer to the *NetBackup Advanced Client System Administrator's Guide* for information on how to create a snapshot mirror on the client before running the backup.

- ◆ **vxvm** was selected as the snapshot method, and a VERITAS Volume Manager snapshot mirror of the snapshot source volume has been created. However, two different backup jobs (A and B) attempt to back up the same volume (for example, vol101), but job A starts just before job B. Because there is a brief pause between finding an available snapshot mirror and actually forming the snapshot of it, job B (running slightly behind job A) might attempt to create a snapshot of the snapshot mirror just before job A (running slightly ahead) actually creates the snapshot and gets the lock on it.

In this case, you may see the following in the

`/usr/opencv/netbackup/logs/online_util log`:

```
17:12:51 onlfi_freeze: FTL - VfMS error 11; see following messages:
17:12:51 onlfi_freeze: FTL - Fatal method error
17:12:51 onlfi_freeze: FTL - vfm_freeze: method: vxvm, type: FIM, function:
vxvm_freeze
17:12:51 onlfi_freeze: FTL - VfMS method error 3; see following message:
17:12:51 onlfi_freeze: FTL - vxvm_freeze: Command failed with status=11:
/usr/sbin/vxassist -g rootdg snapshot vol101 VfMSCAAu7a4Uw </dev/null
>/var/tmp/VfMSAAAs7a4Uw 2>/var/tmp/VfMSBAAt7a4Uw
```

The job that was unable to get a lock (job B in the above example) fails, and must be run again.

- ◆ When using `nbu_snap` as a snapshot method, you may have stale snapshots if status code 11 occurs with the following messages in the `/usr/opencv/netbackup/logs/online_util log`. (Stale snapshots are those that were not automatically deleted by `nbu_snap`.)

```
17:12:51 onlfi_freeze: FTL - VfMS error 11; see following messages:
17:12:51 onlfi_freeze: FTL - Fatal method error
17:12:51 onlfi_freeze: FTL - vfm_freeze: method: nbu_snap, type: FIM,
function: nbu_snap_freeze
17:12:51 onlfi_freeze: FTL - VfMS method error 5; see following message:
17:12:51 onlfi_freeze: FTL - nbu_snap_freeze: Cannot turn on snapshot;
snapshot source=/oracle/ufs_r, cache=/dev/rdsk/c4t1d11s4, snap error=11
```

a. Look for stale snapshots by running the

`/usr/opencv/netbackup/bin/driver/snaplist` command when there are no active backups running. If the `snaplist` command shows cache entries, there are stale snapshots. Nothing is displayed if there are no stale snapshots.

Example `snaplist` output:

```
id ident      size      cached  minblk    err time
43  6515      8390970    0        0         0  11/16/00 13:31:36
device = /dev/rdsk/c1t6d0s0
cache  = /dev/rdsk/c1t6d0s7
```

b. Use the `snapoff` command to remove the stale snapshot, as follows:



`/usr/opensv/netbackup/bin/driver/snapoff id`

where *id* is the id from the `snaplist` output (such as 43 in the above example).

- ◆ If a backup using the **VxFS_Checkpoint** snapshot method failed, the NetBackup `bpbkar` process should automatically remove the clone. Sometimes, however, `bpbkar` is unable to remove the clone. In this case, you may see messages such as the following in the `/usr/opensv/netbackup/logs/online_util` log:

```
15:21:45.716 [4236] <4> create_mount_point: INF - Created mount point
/tmp/_vtrax_test_fastrax_dlt:4236
15:21:45.869 [4236] <2> onlfi_vfms_logf: INF - vxfs clone handle : 9600344
15:21:45.870 [4236] <2> onlfi_vfms_logf: INF - VxFS_Checkpoint_freeze: Cannot create
checkpoint; status=17
15:21:45.872 [4236] <4> delete_mount_point: INF - Deleted mount point
/tmp/_vtrax_test_fastrax_dlt:4236
15:21:45.873 [4236] <32> onlfi_freeze: FTL - VfMS error 11; see following
messages:
15:21:45.873 [4236] <32> onlfi_freeze: FTL - Fatal method error was reported
15:21:45.873 [4236] <32> onlfi_freeze: FTL - vfm_freeze: method: VxFS_Checkpoint,
type: FIM, function: VxFS_Checkpoint_freeze
15:21:45.873 [4236] <32> onlfi_freeze: FTL - VfMS method error 17; see
following message:
15:21:45.874 [4236] <32> onlfi_freeze: FTL - VxFS_Checkpoint_freeze: Cannot create
checkpoint; status=17
```

Remove the clone as follows.

Note If the checkpoint is not removed, you will not be able to use **VxFS_Checkpoint** to back up any data in the file system where the checkpoint is mounted.

- List the name of the checkpoint by entering the following VxFS command:

```
/usr/lib/fs/vxfs/fsckptadm list /file_system
```

where *file_system* is the name of the file system where the checkpoint is mounted. Following is sample output. In this example, `/vtrax_test` is the file system and `fi_ckpt` is the name of the checkpoint.

```
/vtrax_test
fi_ckpt:
  ctime = Mon Nov 12 10:08:13 2001
  mtime = Mon Nov 12 10:08:13 2001
  flags = largefiles
```

- Remove the checkpoint by entering the following:

```
/usr/lib/fs/vxfs/fsckptadm remove checkpoint /file_system
```

- If the checkpoint cannot be removed, unmount the checkpoint and retry [step b](#).



- ◆ If a snapshot backup failed using TimeFinder, ShadowImage, or BusinessCopy method, there may be a VxVM clone left over from a previous backup. You may see messages similar to the following in the `/usr/opensv/netbackup/logs/online_util` log:

```
19:13:07.686 [14981] <2> onlfi_vfms_logf: INF - do_cmd: Command failed with status=20:
/usr/opensv/netbackup/bin/bpdgclone -g wil_test -n vol01 -f /var/tmp/HDSTFCAAs7a0qD
</dev/null >/var/tmp/VfMSAAq7a0qD 2>/var/tmp/VfMSBAAr7a0qD
19:13:07.687 [14981] <2> onlfi_vfms_logf: INF - --- Dumping file /var/tmp/VfMSAAq7a0qD
(stdout):
19:13:07.687 [14981] <2> onlfi_vfms_logf: INF - --- End of file /var/tmp/VfMSAAq7a0qD
19:13:07.687 [14981] <2> onlfi_vfms_logf: INF - --- Dumping file /var/tmp/VfMSBAAr7a0qD
(stderr):
19:13:07.687 [14981] <2> onlfi_vfms_logf: INF - clone group and volume already exists
19:13:07.688 [14981] <2> onlfi_vfms_logf: INF - --- End of file /var/tmp/VfMSBAAr7a0qD
```

NetBackup automatically creates VxVM clones for TimeFinder, ShadowImage, or BusinessCopy backups of data configured over volumes. After the backup has completed, NetBackup removes the VxVM clone. In this case, a system crash or reboot may have prevented the removal. Remove the clone as follows.

(Do the following on the client or alternate client, depending on the type of backup.)

- When no backups are running, use the following VxVM command to list any clones: `vxdg list`

The clone name will be of the form `clone_disk_group_clone`.

- To remove the clone, enter the following:

```
/usr/opensv/netbackup/bin/bpdgclone -g disk_group -n volume -c
```

For example:

```
/usr/opensv/netbackup/bin/bpdgclone -g wil_test -n vol01 -c
```

where `wil_test` is the name of the disk group and `vol01` is the name of the VxVM volume.

For more information on removing a VxVM clone, refer to the *NetBackup Advanced Client System Administrator's Guide*. For `vxdg`, refer to the *VERITAS Volume Manager Administrator's Guide*.

- Before running the backup again, resynchronize the primary disk with the secondary disk. For assistance, refer to the *NetBackup Advanced Client System Administrator's Guide*.

- ◆ If a snapshot backup failed using the FlashSnap or VVR snapshot method, there may be a VxVM snapshot left over from a previous backup. You may see messages similar to the following in the `/usr/opensv/netbackup/logs/online_util` log:

```
14:41:15.345 [22493] <32> onlfi_freeze: FTL - VfMS error 11; see following messages:
```



```
14:41:15.345 [22493] <32> onlfi_freeze: FTL - Fatal method error was reported
14:41:15.345 [22493] <32> onlfi_freeze: FTL - vfm_freeze_commit: method: FlashSnap, type: FIM,
function: FlashSnap_freeze_commit
14:41:15.345 [22493] <32> onlfi_freeze: FTL - VfMS method error 8; see following message:
14:41:15.345 [22493] <32> onlfi_freeze: FTL - vxvm_find_ready_snapshot: Cannot find available
snapshot mirror
```

NetBackup automatically creates VxVM snapshots for backups of data configured over volumes. After the backup completes, NetBackup removes the VxVM snapshot. In this case, a system crash or reboot may have prevented the removal. Remove the snapshot as follows.

For FlashSnap:

(Do the following on the client or alternate client, depending on the type of backup.)

- a. Find the VxVM disk group:

```
vxpdg list
```

The format of the disk group name is as follows:

```
primaryhost_diskgroup_split
```

If `vxpdg list` does not show the disk group, the group might have been deported. You can discover all the disk groups, including deported ones, by entering:

```
vxdisk -o alldgs list
```

The disk groups listed in parentheses are not imported on the local system.

- b. Deport the VxVM disk group:

```
vxpdg deport primaryhost_diskgroup_split
```

Enter the following on the primary (original) client:

- c. Import and join the VxVM disk group:

```
vxpdg import primaryhost_diskgroup_split
vxrecover -g primaryhost_diskgroup_split -m
vxpdg join primaryhost_diskgroup_split diskgroup
```

- d. Start the volume and snap back the snapshot volume:

```
vxvol -g primaryhost_diskgroup_split start SNAP_diskgroup_volume
vxassist snapback SNAP_diskgroup_volume
```

For VVR, on the alternate client:

- a. Enter the following to display unsynchronized mirror disks:

```
vxprint -g diskgroup
```

b. Enter the following to resynchronize the mirror disks:

```
vxassist -g diskgroup -v volume snapback
```

- ◆ When using a snapshot method such as VxFS_Checkpoint to back up a VxFS file system, the backup will fail if the VERITAS File System (VxFS) license has expired. Messages such as the following appear in the `/usr/opensv/netbackup/logs/online_util` log:

```
11:37:42.279 [24194] <2> onlfi_vfms_logf: INF -
VxFS_Checkpoint_freeze: Cannot open checkpoint; status=100
11:37:42.283 [24194] <4> delete_mount_point: INF - Deleted mount point
/tmp/_vrts_frzn_img_test1_24194
11:37:42.283 [24194] <32> onlfi_freeze_fim_fs: FTL - VfMS error 11;
see following messages:
11:37:42.283 [24194] <32> onlfi_freeze_fim_fs: FTL - Fatal method
error was reported
11:37:42.284 [24194] <32> onlfi_freeze_fim_fs: FTL - vfm_freeze:
method: VxFS_Checkpoint, type: FIM, function: VxFS_Checkpoint_freeze
11:37:42.284 [24194] <32> onlfi_freeze_fim_fs: FTL - VfMS method error
100; see following message:
11:37:42.284 [24194] <32> onlfi_freeze_fim_fs: FTL -
VxFS_Checkpoint_freeze: Cannot open checkpoint; status=100
```

Obtain a new VxFS license and retry the backup.

3. For NetBackup Advanced Client with instant recovery:

- ◆ If the backup is enabled for instant recovery with either the vxvm or VVR snapshot method, your VxVM mirrors may not be properly configured. In this case, you may see the following in the `/usr/opensv/netbackup/logs/bppfi` log on the client (when verbose mode is set high).

```
13:43:39.095 [16375] <2> onlfi_vfms_logf: INF - Executing command:
13:43:39.095 [16375] <2> onlfi_vfms_logf: INF - /usr/sbin/vxprint -g
rootdg -q -t -e 'assoc="pfi_concat"' </dev/null >/var/tmp/VfMSAA
Arja4.F 2>/var/tmp/VfMSBAAsja4.F
13:43:39.215 [16375] <2> onlfi_vfms_logf: INF - pfi_find_snapdone: 0
SNAPDONE plexes found

13:43:39.215 [16375] <2> onlfi_vfms_logf: INF - Executing command:
13:43:39.215 [16375] <2> onlfi_vfms_logf: INF - /usr/sbin/vxassist -g
rootdg snapprint pfi_concat </dev/null >/var/tmp/VfMSAAArja4.F
2>/var/tmp/VfMSBAAsja4.F
13:43:39.512 [16375] <2> onlfi_vfms_logf: INF - 0 active plexes for
/rootdg/pfi_concat: 0 are PFI 0 non-PFI
13:43:39.512 [16375] <2> onlfi_vfms_logf: INF - pfi_find_active.3309:
exiting with VXVM_E_SYS = 3
```



```
13:43:39.512 [16375] <2> onlfi_vfms_logf: INF - pfi_snapshot.3866: No  
PFI snapshot. err= 3
```

Configure the VxVM mirrors as described in the Instant Recovery chapter of the *NetBackup Advanced Client System Administrator's Guide*.

4. A frequent cause is that the server's file system is full. For example, you may see a message similar to the following in the Problems report or `bpdbm` debug log:

```
06/27/95 01:04:00 romb romb db_FLISTsend failed: system call failed (11)  
06/27/95 01:04:01 romb romb media manager terminated by parent process  
06/27/95 01:05:15 romb romb backup of client romb exited with status 11  
(system call failed)
```

On UNIX systems, run a `df` command on the `/usr/opensv/netbackup/db` directory.

If the `df` command does not reveal the problem, check the `bpdbm` debug logs or do a `grep` for the message

```
system call failed
```

in relevant files under the directory `/usr/opensv/netbackup/db/error/`

On Windows systems, verify that there is enough room in the disk partition where NetBackup is installed.

5. Verify that the system is not running out of virtual memory. If virtual memory is the problem, shut down unused applications or increase the amount of virtual memory. To increase virtual memory on Windows:

- a. Display the Control Panel.
- b. Double-click **System**.
- c. On the **Performance** tab, set **Virtual Memory** to a higher value.

6. On UNIX systems, check for a semaphore problem. This error can be caused by the system not having enough semaphores allocated. This is most commonly seen on Solaris 2 servers when an RDBMS is also running.

The symptoms of the problem vary. In some cases, error messages in the NetBackup log indicate a backup failure due to an error in semaphore operation; another symptom is the inability of the NetBackup Device Manager service Media Manager device daemon, `ltid`, to acquire a needed semaphore (this is the Media Manager Device Manager device daemon on UNIX).

System requirements vary; thus, no absolute recommendations can be made. One customer running both NetBackup and ORACLE on their Solaris server made the following changes to their `/etc/system` file and then rebooted the system (`boot -r`); the changes were found to be adequate:

```
set semsys:seminfo_semmni=300
set semsys:seminfo_semmns=300
set semsys:seminfo_semmsl=300
set semsys:seminfo_semmnu=600
```

Set these attributes to a value great enough to provide resources to all applications on your system.

Run the NetBackup Configuration Validation Utility (NCVU) and note the semaphore settings in the kernel checks in section one.

7. Examine other debug logs or the progress log or status on the client.

NetBackup Status Code: 12

Message: file open failed

Explanation: An open of a file failed.

Recommended Action:

- ◆ For NetBackup Advanced Client only:

Status code 12 may appear in the `/usr/opensv/netbackup/logs/bptm` or `bpdm` log, accompanied by the following:

```
tpc_read_config failed: cannot open file
/usr/opensv/volmgr/database/3pc.conf
```

This may indicate that the policy is configured with either **NetBackup Media Server** or **Third-Party Copy Device** as the offhost backup method, but that the `3pc.conf` file does not exist or is in the wrong location. For instructions on creating the `3pc.conf` file, refer to the latest version of the *NetBackup Advanced Client System Administrator's Guide*.

- ◆ For a FlashBackup policy, if the CACHE= entry follows the source data entry (the entry for the data to back up), the backup will fail with status code 12. Messages such as the following will appear in the `/usr/opensv/netbackup/logs/bpbkar` logs on the client

```
09:55:33.941 [6092] <16> bpfsmmap: ERR - open_snapdisk: NBU snapshot
enable failed error 3
09:55:33.942 [6092] <32> bpfsmmap: FTL - bpfsmmap: can't open
snapshot disk /dev/rdisk/c4t1d0s3 errno 0
09:55:33.950 [6092] <16> bpbkar Exit: ERR - bpbkar FATAL exit
status = 12: file open failed
```



```
09:55:33.956 [6092] <4> bpbkar Exit: INF - EXIT STATUS 12: file
open failed
09:55:33.957 [6092] <2> bpbkar Exit: INF - Close of stdout complete
```

Change the order of the Backup Selections list so that the CACHE entry precedes the source data entry. (The source data entry specifies the raw partition containing the file system to be backed up.)

- ◆ Check the NetBackup Problems report. Try to determine the file and why the error occurred. A possible cause is a permission problem with the file. For detailed troubleshooting information, create a debug log directory for the process that returned this status code. Then, retry the operation, and check the resulting debug log.

NetBackup Status Code: 13

Message: file read failed

Explanation: A read of a file or socket failed. Possible causes include:

- ◆ I/O error reading from the file system.
- ◆ Read of an incomplete or corrupt file.
- ◆ Socket read failing. A socket read failure can be caused by a network problem or a problem with the process that is writing to the socket.
- ◆ A problem specific to NetBackup Advanced Client (see recommended actions).

Recommended Action:

1. Check the NetBackup Problems report for clues on where and why the problem occurred.
2. For a FlashBackup client, check the `/var/adm/messages` log for errors like the following:

```
Mar 24 01:35:58 bison unix: WARNING: sn_alloccache: cache
/dev/rdisk/c0t2d0s3 full - all snaps using this cache are now unusable
```

This indicates that the cache partition is not large enough. If possible, increase the size of the cache partition. Or, if multiple backups are using the same cache, either reduce the number of concurrent backups by rescheduling some of them or reschedule the entire backup to a time when the file system is less active.

3. For detailed troubleshooting information, create a debug log directory for the process that returned this status code, retry the operation, and check the resulting debug log.
4. For NetBackup Advanced Client only:

Status code 13 may appear in the `/usr/opensv/netbackup/logs/bpbkar` log, and can indicate the following:

- ◆ The files to back up reside on an IDE drive as opposed to SCSI, and the offhost backup method was set to either NetBackup Media Server or Third-Party Copy Device. If you are using offhost backup, the disk containing the client files must be a SCSI or Fibre Channel device.

If the disk is an IDE drive, you may see the following in the `/usr/opensv/netbackup/logs/online_util` log:

```
get_disk_info: FTL - /var/tmp/caa026fEU disk_inquiry failed.
Errno = 25: Inappropriate ioctl for device
```

and the following may appear in the `/usr/opensv/netbackup/logs/bpbkar` log:

```
bpbkar: INF - Processing /var
bpbkar: ERR - get_disk_info() failed, status 13
bpbkar: ERR - tpc_get_disk_info() failed: err 13
bpbkar: ERR - bpbkar FATAL exit status = 13: file read failed
bpbkar: INF - EXIT STATUS 13: file read failed
```

- ◆ The files to back up exist on a file system that is not mounted. The file system specified as the snapshot source must be mounted. If the snapshot source is not mounted but the mount point is present, NetBackup may try to take a snapshot of the directory above the directory that was specified as the snapshot source.

NetBackup Status Code: 14

Message: file write failed

Explanation: A write to a file or socket failed. Possible causes include:

- ◆ I/O error writing to the file system.
- ◆ Write to a socket failed. This can be caused by a network problem or a problem with the process reading from the socket.
- ◆ Writing to a full disk partition.

Recommended Action:

- ◆ Check the NetBackup Problems report for clues on where and why the problem occurred.
- ◆ For detailed troubleshooting information, create a debug log directory for the process that returned this status code, retry the operation, and check the resulting debug log.
- ◆ Make sure that routers, bridges, and other network devices are all at “full” duplex.



- ◆ Use a “sniffer” program to determine the number of packets being rejected and/or re-requested.
- ◆ On Windows systems, the client bpbkar log may contain a 10054 “Connection Reset Error” error (usually indicates a hardware error). Somewhere between the NetBackup client and server, the connection was reset. When NetBackup receives this error, it is unable to continue the backup. This error has been attributed to the following:
 - ◆ A hiccup in the network.
 - ◆ A bad network interface card on a NetBackup client.
 - ◆ A bad network interface card on the NetBackup server.
 - ◆ Faulty routers.
 - ◆ Other applications interfering with NetBackup connections.
- ◆ On Novell systems, status code 14 has also been attributed to network issues. Try a “sniffer” program, as suggested above.

NetBackup Status Code: 15

Message: file close failed

Explanation: A close of a file or socket failed.

Recommended Action: Check the NetBackup Problems report for clues on where and why the problem occurred. For detailed troubleshooting information, create a debug log directory for the process that returned this status code, retry the operation, and check the resulting debug log.

NetBackup Status Code: 16

Message: unimplemented feature

Explanation: The specified operation is unimplemented. This error should not occur through normal use of NetBackup.

Recommended Action: Save all error information and call customer support.

NetBackup Status Code: 17

Message: pipe open failed

Explanation: Occurs in NetBackup client menu and vault areas.

Recommended Action: None

NetBackup Status Code: 18

Message: pipe close failed

Explanation: Close of a pipe failed, when one process tries to start a child process.

Recommended Action: Check the NetBackup Problems report for clues on why the failure occurred. For detailed troubleshooting information, create a debug log directory for the process that returned this status code, retry the operation, and check the resulting debug log.

NetBackup Status Code: 19

Message: getservbyname failed

Explanation: A call to `getservbyname()` failed. The `getservbyname()` function uses the name of the service to find a service entry in the `services` file (or NIS services map on UNIX if it is configured).

Recommended Action:

1. Check the NetBackup Problems report for clues on why the failure occurred.
2. On a UNIX system, check that `/etc/services` and NIS services map (if applicable) have entries for the NetBackup services: `bpcd`, `bpdbm`, and `bprd`.
3. Run the NetBackup Configuration Validation Utility (NCVU) and note the services configuration checks in section one.
4. On a Windows system, verify that the `%SystemRoot%\system32\drivers\etc\services` file shows the correct entries for the NetBackup internet processes: `bpcd`, `bpdbm`, and `bprd`.

Ensure that the **NetBackup Client Service Port** number and **NetBackup Request Service Port** number on the **Network** tab in the NetBackup Client Properties dialog match the settings in the `services` file. To display this dialog, start the Backup, Archive, and Restore interface and click **NetBackup Client Properties** on the **File** menu. The values on the **Network** tab are written to the `services` file when the NetBackup Client service starts.

Also, see [“Verifying Host Names and Services Entries”](#) on page 34.

5. Check the level of network activity. An overloaded network can cause this error.
6. If the above actions do not reveal the problem, create a debug log directory for the process that returned this status code, retry the operation, and check the resulting debug log.



NetBackup Status Code: 20**Message:** invalid command parameter**Explanation:** One or more command parameters were not valid. This error can occur when a master and its media servers or a master server and a client have different levels of NetBackup installed. For example, if a NetBackup master server has NetBackup 4.5 and the media server has NetBackup 3.4.

This error can also occur if the wrong parameters are used when executing a command line.

Recommended Action:

1. Check the NetBackup Problems report for clues.
2. If the error occurs when executing a command on the command line, verify that the parameters are valid.
3. For NetBackup Advanced Client:

- ◆ If the following appears in the `/usr/opensv/netbackup/logs/bptm` log,

```
bptm: cannot perform Third-Party-Copy for multiplexed backups
send_brm_msg: ERROR 20
bptm: EXITING with status 20
```

multiplexing was enabled on a third-party copy backup. The **Third-Party Copy Device** offhost backup method is incompatible with multiplexing (the writing of two or more concurrent backup jobs to the same storage device). You must disable multiplexing for any third-party copy backups. If multiplexing is enabled, the backup will fail.

- ◆ The media server may not have the correct `3pc.conf` file entry for the client disk needed for the backup. The following appears in the `/usr/opensv/netbackup/logs/bpbkar` log:

```
14:45:00.983 [15773] <4> bmap_mm_get_devid: GET_DEVICE_INDEX 1
EMC:SYMMETRIX:601092014000
14:45:00.986 [15773] <4> bpbkar child_send_keepalives: keepalive
child started, pid = 15822
14:47:02.029 [15773] <4> bmap_mm_get_devid: keepalive child:
15822 killed
14:47:02.030 [15773] <4> bmap_mm_get_devid: DEVICE_INDEX -1
14:47:02.031 [15773] <16> bmap_send_extend: ERR - can't obtain
device id string EMC:SYMMETRIX:601092014000
14:47:33.167 [15773] <16> bpbkar Exit: ERR - bpbkar FATAL exit
status = 227: no entity was found
14:47:33.167 [15773] <4> bpbkar Exit: INF - EXIT STATUS 227: no
entity was found
```

```
14:47:33.168 [15773] <2> bpbkar Exit: INF - Close of stdout
complete
```

This shows that a particular device cannot be found in the `3pc.conf` file on the media server (14:47:02.031 [15773] <16> `bpmmap_send_extend: ERR - can't obtain device id string EMC:SYMMETRIX:601092014000`). The problem is one of the following:

- ◆ The `3pc.conf` file on the media server is outdated. Recreate the `3pc.conf` file.
- ◆ The media server is not on the same fibre channel network as the third-party copy device and client disk. As a result, the `3pc.conf` file does not have a correct entry for the client disk. Run the `bptpcinfo` command with the `-x client_name` option; this adds the client disk to the `3pc.conf` file. For each disk added to the file by means of `bptpcinfo -x client_name`, you may need to add the device's world-wide name (`wwn=`), as explained in the SAN Configuration chapter of the *NetBackup Advanced Client System Administrator's Guide*.
- ◆ For a FlashBackup policy configured in the earlier (pre-5.0) manner, if the Backup Selections list contains the actual file name of the raw device (such as `/devices/pci@1f,0/pci@1/scsi@3/sd@1,0:d,raw`) rather than the symbolic link form (such as `/dev/rdisk/c0t0d0s1`), the backup will fail. Messages such as the following will appear in the `/usr/opensv/netbackup/logs/bpbkar` logs on the client:

```
09:41:30.785 [5998] <32> bpfsmmap: FTL - bpfsmmap: couldn't get block
name for /devices/pci@1f,0/pci@1/scsi@3/sd@1,0:d,raw
09:41:30.792 [5998] <16> bpbkar Exit: ERR - bpbkar FATAL exit status =
20: invalid command parameter
09:41:30.797 [5998] <4> bpbkar Exit: INF - EXIT STATUS 20: invalid
command parameter
09:41:30.799 [5998] <2> bpbkar Exit: INF - Close of stdout complete
```

Use the symbolic link form of the device name (such as `/dev/rdisk/c0t0d0s1`) and retry the backup.

CAUTION: For a FlashBackup policy configured with NetBackup Advanced Client, with the Perform snapshot backups option selected, the backup may complete but the data cannot be restored if the Backup Selections list contains the actual file name of a raw device.

- ◆ The HP VxFS snapshot mechanism requires a dedicated cache partition for each snapshot. A check is made in the mount table to make sure the cache partition is not already in use. If the cache partition is already in use, status code 20 will occur.

Check the `/usr/opensv/netbackup/logs/bpbkar` log for a message similar to the following:



```
bpfsmap: FTL - bpfsmap: snapshot cache already in use, /dev/arrayvg/vol4c
bpbkar Exit: ERR - bpbkar FATAL exit status = 20: invalid command parameter
bpbkar Exit: INF - EXIT STATUS 20: invalid command parameter
```

If the snapshot cache partition is already in use, you will have to set up your policy schedules to run at different times, or use different cache partitions for each backup.

If the Allow multiple data streams option is enabled, each stream must have its own dedicated cache partition.

4. Compare the NetBackup version level on the server to that on the clients:
 - ◆ On UNIX NetBackup servers and clients, check the `/usr/opensv/netbackup/bin/version` file.
 - ◆ On Windows NetBackup servers, check the `install_path\netbackup\version.txt` file or the **About NetBackup** item on the **Help** menu.
 - ◆ On Microsoft Windows clients, check the **About NetBackup** item on the **Help** menu.
 - ◆ On NetWare target clients, check the Version entry in the `bp.ini` file.

If the client software is earlier than 3.0, verify that the client is in a Standard type policy.
 - ◆ On Macintosh clients, check the version file in the bin folder in the NetBackup folder in the Preferences folder.
 - ◆ If the error is being displayed from a Java interface, tell them how to enable the debug print manager in the Java startup file. Retry and compare the parameters logged in the Java log with the parameters listed in the commands usage statement.
5. If the above actions do not reveal the problem, create a debug log directory for the process that returned this status code, retry the operation, and check the resulting debug log.

NetBackup Status Code: 21

Message: socket open failed

Explanation: A socket could not be opened.

Recommended Action:

1. Check the NetBackup Problems report for clues on where and why the failure occurred. If you cannot determine the cause from the Problems report, create debug log directories for the processes that returned this status code. Then, retry the operation and check the resulting debug logs.
2. On Sun Solaris, verify that all operating system patches are installed (see the Operating Notes section of the *NetBackup Release Notes*).
3. On Windows, verify that the recommended service packs are installed.

NetBackup Status Code: 22

Message: socket close failed

Explanation: A socket could not be closed.

Recommended Action:

1. Check the NetBackup Problems report for clues on where and why the failure occurred. If you cannot determine the cause from the Problems report, create debug log directories for the processes that could have returned this status code. Then, retry the operation and check the resulting debug logs.
2. On Sun Solaris, verify that all operating system patches are installed (see the Operating Notes section of the *NetBackup Release Notes*).
3. On Windows, verify that the recommended service packs are installed.

NetBackup Status Code: 23

Message: socket read failed

Explanation: A read operation from a socket failed.

Recommended Action:

1. Check the NetBackup Problems report for clues on where and why the failure occurred. If you cannot determine the cause from the Problems report, create debug log directories for the processes that could have returned this status code. Then, retry the operation and check the resulting debug logs.
2. Corrupt binaries are one possible cause for this error. For example, in one instance, the following was seen in the `bpsched` debug log.

```
get_num_avail_drives: readline failed: socket read failed (23)
get_stunits: get_num_avail_drives failed with stat 23
```

Loading a fresh `bptm` from the install media resolved the problem.



3. On Sun Solaris, verify that all operating system patches are installed (see the Operating Notes section of the *NetBackup Release Notes*).
4. On Windows, verify that the recommended service packs are installed.
5. This error may occur during a restore to a Novell client. Note the following possible actions:
 - ◆ By default, the value for Novell “Maximum Concurrent Disk Cache Writes” may be too low (for example, 50); Novell recommends setting it to 100. A value of 100 increases the speed and efficiency of disk cache writes by increasing the number of write requests that can be executed at one time.
 - ◆ Change to or add the following settings in the Novell `sys:system\autoexec.ncf` file:

```
SET Maximum Packet Receive Buffers = 4000
SET Maximum Directory Cache Buffers = 4000
SET Maximum Concurrent Disk Cache Writes = 2000
SET Maximum Concurrent Directory Cache Writes = 2000
SET Maximum Physical Receive Packet Size = 1514
```
 - ◆ On NT/2000 master servers, check the `LIST_FILES_TIMEOUT` value and ensure that this value is at least 1800.
6. Run the NetBackup Configuration Validation Utility (NCVU) on the master server and clients. Note the name resolution checks in section seven and NCVU summary.

NetBackup Status Code: 24

Message: socket write failed

Explanation: A write operation to a socket failed.

Recommended Action:

1. Check the NetBackup Problems report for clues on where and why the failure occurred. If you cannot determine the cause from the Problems report, create debug log directories for the processes that could have returned this status code. Then retry the operation and check the resulting debug logs.
2. A possible cause could be a high network load. For example, this has been seen in conjunction with `Cannot write to STDOUT` when a Windows system that is monitoring network load has detected a high load and sent an ICMP packet to other systems that says the route being used by those systems was disconnected. The log messages were similar to the following:



```
01/31/96 14:05:23 rubble crabtree.null.com from client
crabtree.null.com: ERR - Cannot write to STDOUT. Err no= 242: No route
to host
01/31/96 14:05:48 rubble crabtree.null.com successfully wrote backup id
crabtree.null.com_0823125016, copy 1, fragment 1, 440864 Kbytes at
628.538 Kbytes/sec
01/31/96 14:05:51 netbackup crabtree.null.com CLIENT crabtree.null.com
POLICY Remote3SysFullW SCHED Sirius EXIT STATUS 24 (socket write
failed)
```

3. On Sun Solaris, verify that all operating system patches are installed (see the Operating Notes section of the *NetBackup Release Notes*).
4. On Windows, verify that the recommended service packs are installed.
5. This error may occur during a restore to a Novell client. Note the following possible actions:
 - ◆ By default, the value for Novell “Maximum Packet Receive Buffers” may be too low (such as 100). The restore performance may be improved by changing this value to 2000. To change it, issue “SET Maximum Packet Receive Buffers=<value>” at the console, or enter the value in either of the following Novell files: `sys:system\startup.ncf` or `sys:system\autoexec.ncf`.
 - ◆ Change to or add the following settings in the Novell `sys:system\autoexec.ncf` file:

```
SET Maximum Packet Receive Buffers = 4000
SET Maximum Directory Cache Buffers = 4000
SET Maximum Concurrent Disk Cache Writes = 2000
SET Maximum Concurrent Directory Cache Writes = 2000
SET Maximum Physical Receive Packet Size = 1514
```
6. Run the NetBackup Configuration Validation Utility (NCVU) on the master server and clients. Note the name resolution checks in section seven and NCVU summary.

NetBackup Status Code: 25

Message: cannot connect on socket

Explanation: A process timed out while connecting to another process for a particular operation. This problem can occur when a process tries to connect to the NetBackup request daemon (`bprd`) or database manager daemon (`bpdbm`) and the daemon is not running. (On Windows, these daemons are the NetBackup Request Manager and NetBackup Database Manager services.) It can also occur if the network or server is



heavily loaded and has slow response time, or if an evaluation license key for NetBackup has expired. However, the most common cause of this error is hostname resolution problems.

Recommended Action:

1. On a UNIX NetBackup master server, verify that the `bprd` and `bpdbm` processes are running. If these processes are not running, start them. On a Windows master server, verify that the NetBackup Request Manager and NetBackup Database Manager services are running. If these services are not running, start them.

If the above processes or services are running, examine the All Log Entries report for the time of the failure to determine where the failure occurred.

- ◆ If you cannot view the report, or you get a `cannot connect on socket` error when trying to view it, verify again that the NetBackup Database Manager service or daemon is running. Then, create a debug log directory for `bpdbm`, retry the operation, and check the resulting debug log.
 - ◆ If you can view the report and have not found an entry related to this problem, create debug log directories for the related processes that were running when the error first appeared (this process will frequently be `bpbrm`). Then, retry the operation and check the resulting debug logs.
2. Verify that the server list specifies the correct master server.
 - ◆ On Windows systems, the master server is designated as **CURRENT** on the **Servers** tab in the Specify NetBackup Machines and Policy Type dialog. To display this dialog box, start the Backup, Archive, and Restore interface and click **Specify NetBackup Machines and Policy Type** on the **File** menu.
 - ◆ On UNIX, and Macintosh systems, the master server is the first **SERVER** entry in the `bp.conf` file.
 - ◆ On NetWare target and OS/2 clients, the master server name is the first **SERVER** entry in the `bp.ini` file.
 - ◆ Make sure all recommended NetBackup patches have been installed. Check the VERITAS support web site for current patch information. (Go to www.support.veritas.com, then select "NetBackup" followed by "files and updates".)
 - ◆ If failure occurs when executing a user-directed backup from a client, make sure a user-directed backup schedule exists at the master server.
 - ◆ When working with NetBackup database extensions, make sure that the applicable database product has the correct permissions allowing NetBackup to write to the progress log on the client.

- ◆ On UNIX systems, if `bpdbm` is dying when the shutdown script is executed on a media server, carefully read the `K77netbackup` script (in `/usr/opensv/netbackup/bin/goodies`) for details on how to prevent this problem.

If you change the server list on a master server, stop and restart the NetBackup database manager and request daemons (UNIX) or the NetBackup Database Manager and NetBackup Request Manager services (Windows).

3. Check the `services` file.

On UNIX, verify that the `/etc/services` file (and NIS services if NIS is used) has entries for the NetBackup services: `bpcd`, `bpdbm`, and `bprd`.

Run the NetBackup Configuration Validation Utility (NCVU) and note the services port checks in section one. Note the NetBackup daemon running and listening check and the `bpps` check in section three.

On Windows, verify that the `%SystemRoot%\system32\drivers\etc\services` file has the correct entries for `bpcd`, `bpdbm`, and `bprd`.

Also, verify that the **NetBackup Client Service Port** number and **NetBackup Request Service Port** number on the **Network** tab in the NetBackup Client Properties dialog match the settings in the `services` file. To display this dialog, start the Backup, Archive, and Restore interface and click **NetBackup Client Properties** on the **File** menu. The values on the **Network** tab are written to the `services` file when the NetBackup Client service starts.

Also, see “[Verifying Host Names and Services Entries](#)” on page 34.

4. On Sun Solaris, verify that all operating system patches are installed (see the Operating Notes section of the *NetBackup Release Notes*).
5. On Windows, verify that the recommended service packs are installed.
6. When the base NetBackup license key expires, daemons (such as `bprd` and `bpdbm`) will terminate on the NetBackup server. If these daemons are not running, you are likely to encounter status code 25 errors in the Administration console. Install a valid base NetBackup license key, restart the daemons, and restart the console.
7. For NetBackup Advanced Client:

When many devices are configured on a media server, it may take a long time for the `bptpcinfo` command to generate the `3pc.conf` file. When the backup is run for the first time, the backup may fail with status 25. Make sure that the



`/usr/opensv/volmgr/database/3pc.conf` file exists. If it does, rerun the backup. If the backup fails again, run the `bptpcinfo` manually to generate the `3pc.conf` file, then try the backup again.

8. Run the NetBackup Configuration Validation Utility (NCVU) on the master server and clients. Note the name resolution checks in section seven and NCVU summary.

NetBackup Status Code: 26

Message: client/server handshaking failed

Explanation: A process on the server encountered an error when communicating with the client. This error indicates that the client and server were able to initiate communications, but encountered difficulties in completing them. This problem can occur during a backup or a restore.

Recommended Action: Determine which activity encountered the handshake failure by examining the All Log Entries report for the appropriate time period. Determine the client and server that had the handshake failure.

For detailed troubleshooting information, create a debug log directory for the process that returned this status code, retry the operation, and check the resulting debug log.

NetBackup Status Code: 27

Message: child process killed by signal

Explanation: A child of the process reporting this error was killed. This can occur because the backup job was terminated or the child process was terminated by another error. This problem can also occur if a NetBackup process was terminated through Task Manager or another utility.

Recommended Action: Check the NetBackup All Log Entries report for clues on where and why the failure occurred. For detailed troubleshooting information, create a debug log directory for the process that you suspect of returning this status code. Then, retry the operation and check the resulting debug log.

NetBackup Status Code: 28

Message: failed trying to fork a process

Explanation: A fork of a child process failed (on UNIX) or a `CreateProcess` failed (on Windows). This may be due to:

- ◆ An overloaded system
- ◆ Insufficient swap space or physical memory
- ◆ Too many processes running on the system

Recommended Action: Check the NetBackup All Log Entries report for clues on where and why the failure occurred. For detailed troubleshooting information, create debug log directories for the processes that you suspect of returning this status code. Then, retry the operation and check the resulting debug logs.

NetBackup Status Code: 29

Message: failed trying to exec a command

Explanation: A command could not be executed. This can occur because the permissions of the command do not allow it to be executed, or there is lack of system resources such as memory and swap space.

Recommended Action:

1. Check the NetBackup All Log Entries report for clues on where and why the failure occurred.
2. Check the permissions on the command to be executed.
3. For detailed troubleshooting information, create a debug log directory for the process that returned this status code, retry the operation, and check the resulting debug log.

NetBackup Status Code: 30

Message: could not get passwd information

Explanation: Could not get the `passwd` entry for a user.

Recommended Action: Check the NetBackup All Log Entries report for clues on where and why the failure occurred. For detailed troubleshooting information, create a debug log for the process that you suspect of returning this status code. Then, retry the operation and check the resulting debug log.

NetBackup Status Code: 31

Message: could not set user id for process

Explanation: Could not set the user ID of a process to that of the requesting user. NetBackup executes client processes as the requesting user.

Recommended Action: Check the NetBackup All Log Entries report for clues on where and why the failure occurred. For detailed troubleshooting information, create a debug log directory for the process that you suspect of returning this status code. Then, retry the operation and check the resulting debug log.



NetBackup Status Code: 32

Message: could not set group id for process

Explanation: Could not set the group ID of a process to the requesting user group. NetBackup executes client processes with the group ID of the requesting user.

Recommended Action: Check the NetBackup All Log Entries report for clues on where and why the failure occurred. For detailed troubleshooting information, create a debug log directory for the process that you suspect of returning this status code. Then, retry the operation and check the resulting debug log.

NetBackup Status Code: 33

Message: failed while trying to send mail

Explanation: An E-mail notification of backup, archive, or restore results has failed. The E-mail could not be sent to the administrator's address as specified by the E-mail global attribute, or, in the case of a UNIX client, an E-mail address specified with USEMAIL in the client's `bp.conf` file.

Recommended Action: Check the NetBackup All Log Entries report for clues on where and why the failure occurred. For detailed troubleshooting information, create a debug log directory for the process that you suspect of returning this status code. Then, retry the operation and check the resulting debug log.

NetBackup Status Code: 34

Message: failed waiting for child process

Explanation: The `bpsched` process encountered a failure while waiting for a child process to complete.

Recommended Action: Check the NetBackup All Log Entries report for clues on where and why the failure occurred. For detailed troubleshooting information, create a debug log for the process that you suspect of returning this status code. Then, retry the operation and check the resulting debug log.

NetBackup Status Code: 35

Message: cannot make required directory

Explanation: Could not create a required directory. Possible causes are:

- ◆ A process does not have permission to create the directory
- ◆ The path to the directory is not valid
- ◆ An IO error occurs
- ◆ There was no space available on the device containing the directory

Recommended Action:

1. Check the NetBackup All Log Entries report to determine which directory could not be created and why it could not be created. In particular, check for a full disk partition.
2. Check the permissions on the parent directory and verify that NetBackup services are started with a “Logon as” account that has permission to create the directory.
3. For detailed troubleshooting information, create a debug log directory for the process that returned this status code, retry the operation, and check the resulting debug log.

NetBackup Status Code: 36

Message: failed trying to allocate memory

Explanation: Allocation of system memory failed. This error occurs when there is insufficient system memory available. This could be caused by the system being overloaded with too many processes and there is not enough physical and virtual memory.

Recommended Action: Free up memory by terminating unneeded processes that consume a lot of memory. Add more swap space or physical memory.

NetBackup Status Code: 37

Message: operation requested by an invalid server

Explanation: A request was made to the NetBackup request daemon (`bpird`) or NetBackup database manager daemon (`bpdbm`) by an invalid media server or Windows NetBackup Remote Administration Console. On Windows, these daemons are the NetBackup Request Manager and NetBackup Database Manager services.

Recommended Action: Examine the NetBackup All Log Entries report for the time of this error to determine which system was trying to connect to the master server.

If the server is a valid media server, verify that the storage unit for the media server is defined. Also, verify that the server or Windows NetBackup Remote Administration Console has a server list entry on the master server.

If necessary, update the server list.

On a UNIX master server, add a `SERVER = media_server_name` to the `bp.conf` file. *media_server_name* is the host name of the media server. On a Windows master server, add the media server to the list on the **Servers** tab in the Master Server Properties dialog (see “Using the Host Properties Window” on page 54).

If a server or Windows NetBackup Remote Administration Console has more than one host name (for example, if it has multiple network interfaces), verify that the master server has a server list entry for each of them.



If you change the server list on a UNIX master server, you must stop and then restart the NetBackup Request daemon (`bprd`) and NetBackup database manager daemon (`bpdbm`) for the changes to take effect. If you change the server list on a Windows master server, stop and then restart the NetBackup Request Manager and NetBackup Database Manager services.

Run the NetBackup Configuration Validation Utility (NCVU) media server checks. Note the media server and storage unit checks in sections four and five.

NetBackup Status Code: 38

Message: could not get group information

Explanation: Could not get the group entry describing a UNIX user group.

Recommended Action: Check the NetBackup Problems report for clues on why the error occurred. For detailed troubleshooting information, create a debug log directory for the process that returned this status code, retry the operation, and check the resulting debug log.

NetBackup Status Code: 39

Message: client name mismatch

Explanation: The name that the client used in a request to the NetBackup server did not match the client name configured in the policy on the server.

Recommended Action: Change either the NetBackup client name setting on the client (see the applicable NetBackup users guide) or the one in the policy configuration on the server so the two match.

Run the NetBackup Configuration Validation Utility (NCVU) `-conf <media server option>` and `-conf <client option>` checks for the associated NetBackup nodes. On the media server check, note the client configuration in the policy checks in section five.

NetBackup Status Code: 40

Message: network connection broken

Explanation: The connection between the client and the server was broken. This status code can also appear if the connection is broken between the master and media server during a backup.

Recommended Action:

1. Try pinging the client from the server. If this is not possible, check for loose connections or other network problems.
2. Verify that the server list settings are correct on both the client and the server. If the backup involves a media server, verify that these entries are correct on both the master and media server. For example, if a media server does not have a server list entry for the master, it does not accept connections from the master.
 - ◆ On Windows, the master server is designated on the **Servers** tab in the Master Server Properties dialog. To display this dialog, see [“Using the Host Properties Window”](#) on page 54.
 - ◆ On UNIX, and Macintosh systems, the master server is the first SERVER entry in the `bp.conf` file.
 - ◆ On NetWare target and OS/2 clients the master server name is the first SERVER entry in the `bp.ini` file.

If you change the server list on a UNIX master server, you must stop and then restart the NetBackup Request daemon (`bprd`) and NetBackup database manager daemon (`bpdbm`) for the changes to take effect. On Windows, stop and restart the NetBackup Request Manager and NetBackup Database Manager services.

3. Status code 40 can also be due to the operator denying a mount request.
4. Run the NetBackup Configuration Validation Utility (NCVU) `-conf <media server option>` and `-conf <client option>` checks for the associated NetBackup nodes. Note the ping checks in section seven.

NetBackup Status Code: 41

Message: network connection timed out

Explanation: The server did not receive any information from the client for too long a period of time.

Recommended Action:

1. On UNIX or Windows clients, check for the following problems with the `bpbkar` client process.

On Windows clients: The `bpbkar` client process is not hung, but due to the files and directories it is scanning, it has not replied to the server within the **Client read timeout** or **Client connect timeout** period. This has been seen to occur during incremental backups when directories have thousands of unmodified files.



For this case, use Host Properties on the NetBackup server to change **Client connect timeout** or **Client read timeout**. These settings are on the **Timeouts** and **Universal Settings** tabs, respectively, in the Master Server Properties dialog (see “[Using the Host Properties Window](#)” on page 54). The default for these timeouts is 300 seconds.

You can also monitor CPU utilization to determine if this condition exists.

On UNIX clients:

- ◆ The `bpbkar` client process is hung on a file that has mandatory locking set. For this case, add the following to the client’s `bp.conf` file:

```
VERBOSE
```

and as root on the client execute:

```
touch /usr/opensv/netbackup/bpbkar_path_tr
mkdir /usr/opensv/netbackup/logs/bpbkar
```

Then retry the operation. The names of the files are logged in the debug log file in the `/usr/opensv/netbackup/logs/bpbkar` directory before `bpbkar` processes them. The last file in the log will be the file that is causing problems.

Note Also, use the above procedure for other, “unknown” `bpbkar` hangs.

If the problem is due to mandatory file locking, you can have NetBackup skip the locked files by setting `LOCKED_FILE_ACTION` to `SKIP` in the `/usr/opensv/netbackup/bp.conf` file on the client.

- ◆ The `bpbkar` client process is not hung, but due to the files and directories it is scanning, it has not replied to the server within `CLIENT_READ_TIMEOUT` or `CLIENT_CONNECT_TIMEOUT`. This has been seen to occur during backups when directories have thousands of unmodified files, or during restores of sparse files that have thousands of holes; it has also been seen when backing up file systems or directories that reside on optical disk, which is considerably slower than magnetic disk.

For this case, try adding or modifying the `CLIENT_READ_TIMEOUT` and `CLIENT_CONNECT_TIMEOUT` values in the server’s `/usr/opensv/netbackup/bp.conf` file. The default for the `CLIENT_READ_TIMEOUT` and `CLIENT_CONNECT_TIMEOUT` is 300 seconds if unspecified.

Use your system’s `ps` command and monitor CPU utilization to help decide which of the above conditions exist.

When you are through investigating the problem, delete the `/usr/opensv/netbackup/logs/bpbkar` directory, since the log files can become quite large and are not deleted automatically. Also delete

`/usr/opensv/netbackup/bpbkar_path_tr` so you do not generate larger log files than needed the next time you create directory
`/usr/opensv/netbackup/logs/bpbkar.`

2. On Windows systems, try the following:

- ◆ Disable the following file:

`install_path\VERITAS\NetBackup\bin\tracker.exe`

- ◆ Repair hard drive fragmentation. You could try an application called Diskeeper Lite, which is part of the Windows NT Resource Kit.
- ◆ Make sure there is enough space available in `\temp`.

3. If the server cannot connect to the client, create `bpcd` or `bpbkar` (UNIX and Windows only) debug log directories on the client, retry the operation, and check the resulting logs. If these logs do not provide a clue, create a `bpbrm` debug log on the server, retry the operation again, and check the resulting debug log.

If the `bpbrm` log has entries similar to the following:

```
bpbrm hookup_timeout: timed out waiting during the client hookup
bpbrm Exit: client backup EXIT STATUS 41: network connection timed out
```

then the problem is in the routing configuration on the server.

Verify that the client IP address is correct in the name service that is being used. On UNIX, if both NIS and DNS files are used, verify that they match.

Also, see “[Resolving Network Communication Problems](#)” on page 26.

- 4.** If you are using an AIX token ring adapter and the `routed` daemon is running, the timeout can occur because the token ring adapter creates dynamic routes, causing the `routed` daemon to crash.
- 5.** For a FlashBackup client, this can happen if the file system being backed up is very large and has a very large number of files. It can also occur if a large number of concurrent data streams are active at the same time. The corrective action is to add `CLIENT_READ_TIMEOUT` to the `/usr/opensv/netbackup/bp.conf` file and set it to increase the timeout interval.
- 6.** Make sure all recommended NetBackup patches have been installed. Check the VERITAS support web site for current patch information. (Go to www.support.veritas.com, then select “NetBackup” followed by “files and updates”.) Run the NetBackup Configuration Validation Utility (NCVU) for the associated NetBackup nodes. Note the pack checks in section two.



7. Add the `CLIENT_READ_TIMEOUT` values to the master server, media server and client when a NetBackup database extension product is installed. The values should all be the same for each server. The value set is dependent on the size of the database being backed up. See the *NetBackup System Administrator's Guide* for more information on `CLIENT_READ_TIMEOUT`.

8. Make sure enhanced authentication is configured correctly. See the chapter on enhanced authentication in the *NetBackup System Administrator's Guide*.

For example, the following could result in status code 41: host A is configured to use enhanced authentication with host B, but host B is not configured to use enhanced authentication with host A. In this case, connections from host B to host A are likely to fail with status code 41. Connections from host A to B are likely to fail with authentication errors (status code 160).

NetBackup Status Code: 42

Message: network read failed

Explanation: An attempt to read data from a socket failed.

Recommended Action:

1. Verify that both the client and the server are operational.
2. Perform "[Resolving Network Communication Problems](#)" on page 26.
3. Check the Problems report for clues.

NetBackup Status Code: 43

Message: unexpected message received

Explanation: The client and server handshaking was not correct.

Recommended Action:

1. Verify that the correct version of software is running on the client and the server.
2. Enable detailed debug logging:
 - ◆ On the server, create a `bpbrm` debug log directory.
 - ◆ On clients, create a `bpcl` debug log directory (created automatically on Macintosh clients).
 - ◆ Increase the amount of debug information included in the logs as explained in the debug log topics in Chapter 3.

3. Retry the operation and examine the logs.

Note If you are using `bpstart_notify` scripts on UNIX or Windows clients, verify that messages are not being written to `stdout` or `stderr`.

NetBackup Status Code: 44

Message: network write failed

Explanation: An attempt to write data to a socket failed.

Recommended Action:

1. Check the Problems report for information about the error.
2. Verify that the client and servers are operational and connected to the network.
3. Create a debug log directory for the process that reported the problem and the operation. Examine the resulting debug log file for detailed troubleshooting information.
4. Perform “[Resolving Network Communication Problems](#)” on page 26.

NetBackup Status Code: 45

Message: request attempted on a non reserved port

Explanation: An attempt was made to access a client from a nonreserved port.

Recommended Action: Verify that the latest software is installed on the client and server.

- ◆ On UNIX NetBackup servers and clients, check the `/usr/opensv/netbackup/bin/version` file.
- ◆ Run the NetBackup Configuration Validation Utility (NCVU) for the associated NetBackup clients. Note the client software checks in section two.
- ◆ On Windows NetBackup servers, check the `install_path\netbackup\version.txt` file or the **About NetBackup** item on the **Help** menu.
- ◆ On Microsoft Windows clients, check the **About NetBackup** item on the **Help** menu.
- ◆ On NetWare target clients, check the Version entry in the `bp.ini` file.
- ◆ If this is a NetBackup for NetWare client and has a version of NetBackup earlier than 3.0, verify that the client is in a Standard type policy.
- ◆ On Macintosh clients, check the version file in the bin folder in the NetBackup folder in the Preferences folder.



NetBackup Status Code: 46**Message:** server not allowed access**Explanation:** The server is trying to access a client but access is blocked. Possible causes are:

- ◆ The server is not listed on the client as a valid server.
- ◆ The client has been configured to require encrypted backups, but the encryption attribute for the backup policy on the server has not been selected.
- ◆ The evaluation license for the NetBackup Encryption product has expired on the server, but the NetBackup client has been configured to require encrypted backups. As a result, the server attempted to make a non-encrypted backup of the client; since the client is configured to require encryption, the backup failed.

Recommended Action:

- ◆ If the server is a valid server but is not listed on the client, add its name to the client's server list:
 - ◆ On Windows clients, add the server on the **Servers** tab in the Specify NetBackup Machines and Policy Type dialog box. To display this dialog box, start the Backup, Archive, and Restore interface on the client and click **Specify NetBackup Machines and Policy Type** on the **File** menu.
 - ◆ On UNIX and Macintosh clients, add a `SERVER` entry in the `bp.conf` file.
 - ◆ On NetWare target and OS/2 clients, add a `SERVER` entry in the `bp.ini` file.
- ◆ If you continue to have problems, review [“Resolving Network Communication Problems”](#) on page 26 and [“Verifying Host Names and Services Entries”](#) on page 34.
- ◆ To make non-encrypted backups of the client, set `CRYPT_OPTION` on the client to *allowed* or *denied*. For more information, refer to the *NetBackup Encryption System Administrator's Guide*.
- ◆ If the NetBackup encryption evaluation license has expired on the server and you want to continue encrypting backups of the client, you must purchase a permanent encryption license key and add it to the server. After you add the permanent encryption license key, check the attributes of the backup policy to make sure that encryption is selected.

To check the validity of an evaluation license key, do the following:

On Windows: go to the **Help** menu on the NetBackup Administration window on the NetBackup server and select **License Keys**. If the evaluation key is not listed in the NetBackup License Keys window, the key has expired. Use this window to add the new permanent encryption key.

On UNIX: use the `/usr/opensv/netbackup/bin/admincmd/get_license_key` command on the server. Select option **f** to list the active license keys and features. If the evaluation key is not listed, the key has expired. Use this command to add the new permanent encryption key.

NetBackup Status Code: 47

Message: host is unreachable

Explanation: An attempt to connect to another machine failed.

Recommended Action:

1. Verify that the name service (or services) being used by the client is configured to correctly resolve the host names of the NetBackup server.
2. Verify that the name service (or services) being used by the server is configured to correctly resolve the host name of the NetBackup client.
3. Try to ping the client from the server and the server from the client.
4. If you continue to have problems, perform “[Resolving Network Communication Problems](#)” on page 26.
5. Run the NetBackup Configuration Validation Utility (NCVU) for the associated NetBackup nodes. Note the hostname checks in sections four and seven.

NetBackup Status Code: 48

Message: client hostname could not be found

Explanation: The system function `gethostbyname()` failed to find the client’s host name.

Recommended Action:

1. Verify that the client name is correct in:
 - ◆ The NetBackup policy configuration on the master server.
 - ◆ The **General** tab in the NetBackup Client Properties dialog box and the **Clients** tab in the Specify NetBackup Machines and Policy Type dialog box (on Microsoft Windows and NetWare nontarget clients). To display these dialog boxes, start the Backup, Archive, and Restore interface on the client. For the **General** tab, click NetBackup Client Properties on the **File** menu; for **Clients** tab, click **Specify NetBackup Machines and Policy Type** on the **File** menu.
 - ◆ The `bp.conf` file on UNIX and Macintosh clients.



- ◆ The `bp.ini` file on OS/2 and NetWare target clients.
- 2. On clients and servers, verify that the name service is set up to correctly resolve the NetBackup client names.
On UNIX clients, verify that the client's host name is in the `/etc/hosts` file or the YP hosts file or NIS maps.
- 3. For the NetBackup policy configuration, run the NetBackup Configuration Validation Utility (NCVU) `-conf <media server option>` and note the policy checks in section five. For the client hostname, note the hostname checks in sections four and seven.

NetBackup Status Code: 49

Message: client did not start

Explanation: The client failed to start up correctly.

Recommended Action:

1. Verify that software is installed on the client and it is the correct version. If necessary, reinstall the client software.
2. Check for full file systems on the client.
3. Enable detailed debug logging on the client:
 - ◆ Create `bpcd` and `bpbkar` (UNIX or Windows only) debug log directories.
 - ◆ On a UNIX client, add the `VERBOSE` option to the `/usr/opensv/netbackup/bp.conf` file.
 - ◆ On PC clients, increase the debug or log level as explained in the debug log topics in Chapter 3.
4. Retry the operation and examine the resulting logs.
5. On UNIX systems, use the UNIX `sum` command to check for corrupt binaries.

NetBackup Status Code: 50

Message: client process aborted

Explanation: The client backup aborted. One instance when this code appears is if a NetBackup master or media server is shut down or rebooted when a backup or restore is in process.

Recommended Action:



1. Enable detailed debug logging:
 - ◆ Create a `bpbkar` debug log directory (UNIX or Windows only).
 - ◆ Create a `bpcd` debug log directory (this log is created automatically on Macintosh clients.)
 - ◆ On UNIX clients, add the `VERBOSE` option to the `/usr/opensv/netbackup/bp.conf` file.
 - ◆ On PC clients, increase the debug or log level as explained in the debug log topics in Chapter 3.
2. Retry the operation and examine the resulting logs.
3. On UNIX clients, check for core files in the `/` directory.
4. On UNIX clients, check the system log (`/usr/adm/messages` on Solaris) for system problems.
5. This problem can sometimes be due to a corrupt binary.

On UNIX clients, use the UNIX `sum` command to check the `bpcd`, `bpbkar`, and `tar` binaries, located in `/usr/opensv/netbackup/bin` on the client. Reinstall them if they are not the same as in the client directory under `/usr/opensv/netbackup/client` on the server.

Run the NetBackup Configuration Validation Utility (NCVU) for the associated NetBackup clients. Note the client software checks in section two.

On a Windows client, check the `bpinetd.exe`, `bpcd.exe`, `bpbkar32.exe`, and `tar32.exe` executables located in the `install_path\NetBackup\bin` folder on the client. Reinstall the client if these executables are not the same size as on other Windows clients or are not at the same release level or do not have the same NetBackup patches applied as other Windows clients.

NetBackup Status Code: 51

Message: timed out waiting for database information

Explanation: The catalog process did not respond within five minutes.

Recommended Action:

1. Verify that the NetBackup Database Manager service or daemon is running.
2. Verify that there is space in the file system that contains the NetBackup catalogs.
3. Create `bpbbrm` and `bpdbm` debug log directories on the server and retry the operation.



4. Look in the debug log files to find more information on the problem.

NetBackup Status Code: 52

Message: timed out waiting for media manager to mount volume

Explanation: The requested volume was not mounted before the timeout expired. This error can also occur if the volume happens to be a cleaning tape but was not specified as a cleaning tape.

Another possible cause: if the last available drive has a mount request for a non-backup (such as a restore), then a backup requiring the same drive is initiated before the mount completes. This is due to the drive not being reported as busy until the mount completes.

Recommended Action:

1. Verify that the requested volume is available and an appropriate drive is ready and in the UP state.
2. If this occurs during a read operation (restore, duplicate, verify), the drives could be busy. Try increasing the media mount timeout specified by the NetBackup global attribute in order to allow more time for mounting and positioning the media.
3. Verify that the tape is not a cleaning tape that is configured as a regular volume.
4. When the robot is controlled by an Automated Cartridge System, verify that the ACSLS system is up.
5. If this is an initial installation, refer to [“To Resolve Common Configuration Problems”](#) on page 14.
6. On Windows, check the Event Viewer Application log for error messages that indicate why the tape mount did not complete. On UNIX, check the system log.

NetBackup Status Code: 53

Message: backup restore manager failed to read the file list

Explanation: The backup and restore manager (bpbarm) could not read the list of files to back up or restore.

Recommended Action: Verify that the server software has been installed correctly on all NetBackup servers. If that is not the problem:

1. Create `bpbrm` and `bpsched` debug log directories on the server.
2. On a UNIX NetBackup server, add the `VERBOSE` option to the `bp.conf` file. On a Windows NetBackup server, set the **Verbose logging level** option on the **Logging** tab in the Master Server Properties dialog. To display this dialog, see [“Using the Host Properties Window”](#) on page 54.
3. Retry the operation and check the resulting debug logs for detailed troubleshooting information.

NetBackup Status Code: 54

Message: timed out connecting to client

Explanation: The server could not complete the connection to the client. The accept system or winsock call timed out after 60 seconds.

Recommended Action:

1. For a Macintosh or NetWare target client, verify that the server is not trying to connect when a backup or restore is already in progress on the client. These clients can handle only one NetBackup job at a time.

On a Macintosh, you can check for activity by examining the `NetBackupListen` file in the following folder on the startup disk of the Macintosh client:

```
:System Folder:Preferences:NetBackup:logs:inetd:log.mmddy
```

2. On a Sequent platform, verify that the system has the correct level of TCP/IP.
3. Perform [“Resolving Network Communication Problems”](#) on page 26.
4. On UNIX clients, verify that the `/usr/opensv/netbackup/bin/bpcd` binary exists and that it is the correct size.
5. Check the `/etc/inetd.conf` file to make sure the `bpcd` path is correct in the following entry:

```
bpcd stream tcp nowait root /usr/opensv/netbackup/bin/bpcd bpcd
```
6. On systems that include NetBackup master, media, and clients (with NetBackup database extension products installed on one or more clients), make sure the client name is in the master's `/etc/hosts` file.
7. Run the NetBackup Configuration Validation Utility (NCVU) for the associated NetBackup nodes. Note the `bpcd` checks in sections one and three.



NetBackup Status Code: 55

Message: permission denied by client during rcmd

Explanation: The UNIX client does not have the server's name in its `.rhosts` file.

Recommended Action: Add the server name to the `.rhosts` file on the UNIX client.

NetBackup Status Code: 56

Message: client's network is unreachable

Explanation: An error was returned that the host was unreachable by the client (WSAENETUNREACH on Windows systems, or ENETUNREACH on UNIX systems) when performing a system call.

Recommended Action: Try to ping the client from the server. Check the IP address for the client. If you still have problems, talk to your network administrator.

Run the NetBackup Configuration Validation Utility (NCVU) `-conf <media_server option>` and `-conf <client option>` checks for the associated NetBackup nodes. Note the ping checks in section seven.

NetBackup Status Code: 57

Message: client connection refused

Explanation: The client refused a connection on the port number for `bpcd`. This can occur because there is no process listening on the `bpcd` port or there are more connections to the `bpcd` port than the network subsystem can handle with the `listen()` call.

Recommended Action:

1. For Windows NetBackup servers:
 - a. Make sure the NetBackup client software is installed.
 - b. Verify that the `bpcd` and `bprd` port numbers in the `%SystemRoot%\system32\drivers\etc\services` file on the server matches the setting on the client.
 - c. Verify that the **NetBackup Client Service Port** number and **NetBackup Request Service Port** number on the **Network** tab in the NetBackup Client Properties dialog match the `bpcd` and `bprd` settings in the `services` file. To display this dialog, start the Backup, Archive, and Restore interface on the server and click **NetBackup Client Properties** on the **File** menu.

The values on the Network tab are written to the `services` file when the NetBackup Client service starts.

- d. Verify that the NetBackup client service is running.
 - e. Use the following command to see if the master server returns correct information for the client:

```
install_path\VERITAS\NetBackup\bin\bpcIntcmd -pn
```
2. For UNIX servers:
 - a. Make sure the NetBackup client software is installed.
 - b. Verify that the `bpcd` port number on the server (either NIS services map or in `/etc/services`) matches the number in the client's services file.
 - c. Run the NetBackup Configuration Validation Utility (NCVU) for the associated NetBackup nodes. Note the NetBackup services port number checks in section one.
 3. For a Macintosh or NetWare target client, verify that the server is not trying to connect when a backup or restore is already in progress on the client. These clients can handle only one NetBackup job at a time.
 4. Perform "[Resolving Network Communication Problems](#)" on page 26.

NetBackup Status Code: 58

Message: can't connect to client

Explanation: The server was unable to connect to the client.

Recommended Action: Perform "[Resolving Network Communication Problems](#)" on page 26.

Run the NetBackup Configuration Validation Utility (NCVU) for the associated NetBackup nodes. Note the NetBackup services port number, `bpcd`, and services checks in section one, and the `bpcd` checks in section three.

NetBackup Status Code: 59

Message: access to the client was not allowed

Explanation: The master or media server is trying to access the client, but the server is not recognized by the client as a valid server.

Recommended Action:



1. If the server is a valid server, verify that it is in the server list on the client. If necessary add it as follows:
 - ◆ On Windows clients, add the server on the **Servers** tab in the Specify NetBackup Machines and Policy Type dialog box. To display this dialog, start the Backup, Archive, and Restore interface on the client and click **Specify NetBackup Machines and Policy Type** on the **File** menu.
 - ◆ On UNIX, and Macintosh clients, add a `SERVER` entry in the `bp.conf` file.
 - ◆ On NetWare target and OS/2 clients add a `SERVER` entry in the `bp.ini` file.

If you change the server list on a UNIX master server, you must stop and then restart the NetBackup Request daemon (`bprd`) and NetBackup database manager daemon (`bpdbm`) for the changes to take effect. On Windows, stop and restart the NetBackup Request Manager and NetBackup Database Manager services.

2. On Windows clients, enable `bpinetd` debug logging as follows:
 - a. Create a `bpinetd` debug log directory on the client.
 - b. Increase the debug or log level as explained in the debug log topics in Chapter 3.
 - c. Retry the backup and examine the resulting logs to determine the cause of the failure.
3. On all clients, enable `bpcd` debug logging as follows:
 - a. Create a `bpcd` debug log directory on the client.
 - b. On a UNIX client, add the `VERBOSE` option to the `/usr/opensv/netbackup/bp.conf` file.
 - c. On PC clients, increase the debug or log level as explained in the debug log topics in Chapter 3.
 - d. Retry the backup and examine the resulting logs to determine the cause of the failure.
4. Check the `bpcd` debug log to determine the server's peername and what comparisons are being made.

The `bpcd` process compares NetBackup server list entries to the peername of the server attempting the connection and rejects the connection if the names are different. If necessary, change the server list entry on the client to match the peername.

5. On Windows clients, check the following:

- ◆ Verify that NetBackup for Windows software was installed under a Windows administrator account.

If NetBackup is under another type of account, reinstall it under an administrator account. The installation will complete successfully under a non-administrator account but the NetBackup Client service is not added to Windows and the NetBackup server cannot access the client.

- ◆ Verify that the Windows TCP/IP service specifies the domain server that resolves names for the subnet that contains the NetBackup servers.

UNIX and Windows clients are frequently not on the same subnet and use different domain servers. When this condition exists the NetBackup servers and Windows clients may be able to ping one another, but the server is still unable to access the Windows client.

6. If the preceding steps do not resolve this problem, see [“Resolving Network Communication Problems”](#) on page 26.
7. If NetBackup is using multiple network interfaces with media servers, make sure the interface names appear in the client’s `/usr/opensv/netbackup/bp.conf` file.
8. Run the NetBackup Configuration Validation Utility (NCVU) for the associated NetBackup clients. Note the media server checks in sections four and seven.

NetBackup Status Code: 60

Message: client cannot read the mount table

Explanation: The backup process on the client could not read the list of mounted file systems.

Recommended Action:

1. Execute a `df` to see if the system can read the mount table.
2. On an SCO system, code 60 can occur because the mount-point path name exceeds 31 characters, which is the maximum allowed on an SCO system. The `bpbkar` debug log on the client will show a message similar to the following:

```
bpbkar build_nfs_list: FTL - cannot statfs net Errno: 42406
```

To eliminate these errors for future backups, create a mount point with a shorter name and symbolically link the long name to the short name.

3. For detailed troubleshooting information, create a `bpbkar` debug log directory, retry the operation, and examine the resulting log.



NetBackup Status Code: 63

Message: process was killed by a signal

Explanation: A kill signal was sent to the client process.

Recommended Action: This is usually caused by someone intentionally terminating a backup.

NetBackup Status Code: 64

Message: timed out waiting for the client backup to start

Explanation: The client did not send a ready message to the server within the allotted time.

Recommended Action:

1. On all clients, enable `bpcd` debug logging as follows:
 - a. Create a `bpcd` debug log directory on the client.
 - b. On a UNIX client, add the `VERBOSE` option to the `/usr/opensv/netbackup/bp.conf` file.
 - c. On PC clients, increase the debug or log level as explained in the debug log topics in Chapter 3.
2. On a UNIX or Windows client, create the `bpbkar` debug log directory on the client.
3. On Windows clients, verify that the NetBackup Client service is running.
4. On a UNIX client, use the `ps` command to check for a client process that is using too much CPU time.
5. Retry the backup and examine the debug logs for clues on the cause of the failure.

NetBackup Status Code: 65

Message: client timed out waiting for the continue message from the media manager

Explanation: The tape manager, `bptm` reported that the media did not load and position within the allotted time.

Recommended Action: Verify that the requested volume is available and the required device is in an UP state.

For detailed debug information:

1. Create a `bptm` debug log directory on the server.
2. On a UNIX NetBackup server, add the `VERBOSE` option to the `bp.conf` file. On a Windows NetBackup server, set the **Verbose logging level** option on the **Logging** tab in the Master Server Properties dialog (see [“Using the Host Properties Window”](#) on page 54).
3. Retry the operation and check the `bptm` debug log file for information on the drive, robot, and tape that is causing the timeout.
4. On a Windows NetBackup server (master or media), check the Event Viewer Application log for error messages that indicate why the tape mount did not complete.

NetBackup Status Code: 66

Message: client backup failed to receive the CONTINUE BACKUP message

Explanation: The client `bpbkar` process did not receive the message from the server that indicates that the server is ready to continue.

Recommended Action: Verify that the server did not crash. If that is not the problem and you need more information:

1. On UNIX and Windows clients, enable `bpbkar` debug logging.
 - a. Create a `bpbkar` debug log directory.
 - b. On a UNIX client, add the `VERBOSE` option to the `bp.conf` file. On a Windows client, set **Verbose** on the **TroubleShooting** tab in the NetBackup Client Properties dialog box. To display this dialog box, start the Backup, Archive, and Restore interface on the client and select **NetBackup Client Properties** from the **File** menu.
2. On other PC clients except Macintosh, create a debug log directory for `bpcd` (the `bpcd` log is created automatically on Macintosh).

To increase the amount of information that appears in the logs, see the logging topics in Chapter 3.
3. On the master server create `bpsched` and `bpbrm` debug log directories. If there are media servers involved, create a `bpbrm` debug log directory on them.
4. Retry the operation and check the resulting debug logs.



NetBackup Status Code: 67

Message: client backup failed to read the file list

Explanation: The client could not read the list of files to back up.

Recommended Action: First, verify that the server did not crash. If that is not the problem and you need more information:

1. Set up debug logging:
 - a. On the server, create a `bpbrm` debug log directory.
 - b. On UNIX and Windows clients, create a `bpbkar` debug log directory.
 - c. On other PC clients except Macintosh, create a debug log directory for `bpcd` (the `bpcd` log is created automatically on Macintosh).

To increase the amount of information that appears in the logs, see the logging topics in Chapter 3.
2. Retry the operation and check the resulting debug logs.

NetBackup Status Code: 68

Message: client timed out waiting for the file list

Explanation: The client did not receive the list of files to back up within the allotted time. This list comes from the server.

Recommended Action: First, verify that the server did not crash. If that is not the problem and you need more information:

1. Set up debug logging:
 - a. On the server, create a debug log directory for `bpbrm`.
 - b. On UNIX and Windows clients, create a `bpbkar` debug log directory.
 - c. On other PC clients except Macintosh, create a debug log directory for `bpcd` (the `bpcd` log is created automatically on Macintosh).

To increase the amount of information that appears in the logs, see the logging topics in Chapter 3.
2. Retry the operation and check the resulting debug logs.

NetBackup Status Code: 69

Message: invalid filelist specification

Explanation: The file list received from the server had invalid entries.

Recommended Action:

1. Check the policy file list. If wildcards are used, verify there are matching bracket characters ([and]). If the file list contains UNC (Universal Naming Convention) names, ensure they are properly formatted.
2. For NetBackup Advanced Client only:

If this was an offhost backup (**NetBackup Media Server** or **Third-Party Copy Device**), code 69 may indicate that the file list contains the ALL_LOCAL_DRIVES entry. NetBackup does not support the ALL_LOCAL_DRIVES entry for offhost backup. Remove the ALL_LOCAL_DRIVES entry from the file list.

NetBackup Status Code: 70

Message: an entry in the filelist expanded to too many characters

Explanation: The wildcards used in one of the file list entries caused too many files to be specified.

Recommended Action: Change the wildcards in the file list to specify fewer files.

NetBackup Status Code: 71

Message: none of the files in the file list exist

Explanation: The files in the file list did not match any of the files on the client. This error can occur when there is only one file in the file list and the file cannot be backed up due to an I/O error.

Recommended Action:

1. Verify that the correct file list is specified for this client.
2. On Windows clients, verify that the account used to start the NetBackup Client service has read access to the files.

If you are backing up a network drive or a UNC (universal naming convention) path, use the Services application in the Windows Control Panel to verify that the NetBackup Client service does not start under the SYSTEM account. The SYSTEM account cannot access network drives.

To back up network drives or UNC paths, change the NetBackup Client service startup to log in as a user that has permission to access network drives.



3. Check the All Log Entries report for clues.
4. Set up debug logging:
 - ◆ On UNIX and Windows clients, create a debug log directory for `bpbkar`.
 - ◆ On other PC clients except Macintosh, create a debug log directory for `bpcd` (the `bpcd` log is created automatically on Macintosh).

To increase the amount of information that appears in the logs, see the logging topics in Chapter 3.

5. Retry the operation and check the resulting debug logs.
6. On Novell systems, check the following:
 - ◆ For the nontarget version of NetBackup for NetWare, the backup policy type must be “NetWare”, and the files list should include a forward slash (/) only. There should be nothing else in the files list.

To check the policy type and files list, start Backup Policy Management and right-click the name of a policy. Click the **Attributes** tab to check the policy type; click the **Files** tab to check the contents of the files list.

- ◆ For the target version, the backup policy type must be “Standard”, and the policy files list must be formatted as follows:

/target_name

where a forward slash precedes the variable *target_name*.

To check the policy type and files list, start Backup Policy Management and right-click the name of a policy. Click the **Attributes** tab to check the policy type; click the **Files** tab to check the contents of the files list.

Note For the target version, the following NetWare message may be another indicator of incorrect policy type (this message would appear in the Novell client’s `bpcd` log):

```
unable to connect to service, scheduled access not specified
```

Make sure the policy type is set to “Standard”.

-
- ◆ For either the target or nontarget version of NetBackup for NetWare, make sure that the NetWare loadable modules (NLMs) `SMDR` and `TSAxxx` (such as `TSA500`, `TSA600`, and `TSANDS`) are all at the same version. If they are not at the same version, status 71 may occur.

NetBackup Status Code: 72

Message: the client type is incorrect in the configuration database

Explanation: The policy type attribute in the policy configuration indicates that the client is one type, but the installed software is for another type.

Recommended Action: Verify that the policy type attribute for the policy is correct.

Run the NetBackup Configuration Validation Utility (NCVU) for the associated NetBackup clients. Note the client software checks in section two.

NetBackup Status Code: 73

Message: bpstart_notify failed

Explanation: The bpstart_notify script returned a nonzero exit code.

Recommended Action: Check the bpstart_notify script on the client to see if it performs as desired.

NetBackup Status Code: 74

Message: client timed out waiting for bpstart_notify to complete

Explanation: The bpstart_notify script on the client took too long.

Recommended Action: Try to speed up the bpstart_notify script or set the BPSTART_TIMEOUT on the server to a value that is larger than the default. Set BPSTART_TIMEOUT in the bp.conf file on a UNIX NetBackup server. On a Windows NetBackup server, use Host Properties to set **Backup Start Notify Timeout** (see [“Using the Host Properties Window”](#) on page 54).

NetBackup Status Code: 75

Message: client timed out waiting for bpend_notify to complete

Explanation: The bpend_notify script on the client took too long.

Recommended Action: Try to speed up the bpend_notify script or set BPEND_TIMEOUT on the server to a value that is larger than the default. Set BPEND_TIMEOUT in the bp.conf file on a UNIX NetBackup server. On a Windows NetBackup server, use Host Properties to set **Backup End Notify Timeout**.

NetBackup Status Code: 76

Message: client timed out reading file

Explanation: A fifo was specified in the file list and no data was produced on the fifo within the allotted time.



Recommended Action: Make sure that the process that is to produce the data on the named fifo is started correctly. Add an entry to the `/usr/opensv/netbackup/bp.conf` file on the server to set `CLIENT_READ_TIMEOUT` to a larger value than the default.

NetBackup Status Code: 77

Message: execution of the specified system command returned a nonzero status

Explanation: An immediate command returned a nonzero status.

Recommended Action:

1. Verify that the command is specified correctly.

2. For NetBackup Advanced Client only:

The policy file list may contain files that do not reside *within a file system* that was designated as the snapshot source. For a snapshot method to be applied to the backup of individual files, the snapshot source must be a *file system* (not a raw partition or Volume Manager volume) and the files in the policy file list must reside within that file system.

3. Execute the command manually to see if the desired result is produced.

4. For detailed troubleshooting information, set up debug logging:

a. On UNIX and Windows clients, create a debug log directory for `bpbkar`.

b. On other PC clients except Macintosh, create a debug log directory for `bpcd` (the `bpcd` log is created automatically on Macintosh).

To increase the amount of information that appears in the logs, see the logging topics in Chapter 3.

c. Retry the operation and check the resulting debug log.

NetBackup Status Code: 78

Message: `afs/dfs` command failed

Explanation: Indicates an AFS `vos` command failure.

Recommended Action:



1. Check the NetBackup Problems Report for additional information on why the command failed.
2. The `bpbkar` debug log shows the command that was executed. Create a debug log directory for `bpbkar` . Retry the operation and retry the resulting debug log.
3. Try executing the `vos` command manually to duplicate the problem.

NetBackup Status Code: 79

Message: unsupported image format for the requested database query

Explanation: Possible causes are: the images to be synthesized have been generated using an ascii catalog, were generated for a pre-5.0 client, were generated on a pre-5.0 master server, or one or more of the images to be synthesized has been encrypted. These images cannot be synthesized.

Recommended Action:

- ◆ Ensure that NetBackup is configured to use a binary catalog.
- ◆ Ensure that none of the images has been encrypted.
- ◆ Upgrade the client to NetBackup 5.0 or later. Regenerate the full and incremental images on the 5.0 or later master server using the binary catalog. Rerun the synthetic backup job.

NetBackup Status Code: 80

Message: Media Manager device daemon (`ltid`) is not active

Explanation: If the server is UNIX, the Media Manager device daemon, `ltid`, is not running. If the server is Windows, the NetBackup Device Manager service is not running.

Recommended Action:

1. On Windows, use the Activity Monitor or the Services application in the Windows Control Panel to see if the NetBackup Device Manager service is running. If it is not running, start it. To enable verbose logging, place `VERBOSE` on a line by itself in the `install_path\Volmgr\vm.conf` file before starting the service.
2. On UNIX, use `vmops` to see if `ltid` is running and if necessary start it in verbose mode with the following command:

```
/usr/opensv/volmgr/bin/ltid -v
```

Or, add a `VERBOSE` entry to the Media Manager configuration file, `/usr/opensv/volmgr/vm.conf`. Create the `vm.conf` file if necessary.



3. On UNIX, check the system logs to verify that `ltid` starts.

Note On UNIX systems, `ltid`, and on Windows systems, the NetBackup Device Manager service, is used only if devices are attached to the system.

NetBackup Status Code: 81

Message: Media Manager volume daemon (`vmd`) is not active

Explanation: The tape manager (`bptm`) could not communicate with the NetBackup Volume Manager service (Windows) or the Media Manager volume daemon (UNIX). This communication is required for most operations.

Recommended Action: On UNIX, verify that the Media Manager device daemon (`ltid`) and the volume daemon (`vmd`) are running. Start them if necessary.

On Windows, verify that both the NetBackup Device Manager service and the NetBackup Volume Manager service are running. Start them if necessary.

Note `ltid` or the NetBackup Device Manager service is used only if devices are attached to the system.

NetBackup Status Code: 82

Message: media manager killed by signal

Explanation: The tape manager (`bptm`) or disk manager (`bpdm`) was terminated by another process or a user.

Recommended Action: This should not occur in normal operation. If you want to terminate an active backup, use the NetBackup Activity Monitor.

- ◆ When backing up a DomainOS client this error has occurred after the server has not received anything on the socket for at least 300 seconds, thus causing a client read timeout and breaking the connection. The `bbpkar` debug log had an entry similar to the following:

```
13:22:49 [1347] <16> bpbkar: ERR - Extra output - - ECONNRESET  
Connection reset by peer (UNIX/errno status)
```

Increasing the `CLIENT_READ_TIMEOUT` value (in this instance to 900) has resolved this problem.

NetBackup Status Code: 83

Message: media open error

Explanation: The tape manager (`bptm`) or disk manager (`bpdm`) could not open the device or file that the backup or restore must use.

Recommended Action:

1. For additional information, check the following:
 - ◆ NetBackup Problems report
 - ◆ System log (UNIX)
 - ◆ Event Viewer Application log (Windows)
2. Typically, this status code indicates a drive configuration problem that allows more than one process at a time to open the device.

On UNIX, the problem could be due to:

- ◆ Two (or more) devices were configured that are really the same physical device (for different densities perhaps). Verify that none of the `/dev` files used for these devices have the same major or minor numbers.
- ◆ Links exist in the file system that are allowing users access to the drives.
- ◆ The configuration for the drives was modified (in the administrator interface or `vm.conf`) and the Media Manager device daemon, `ltid`, was not restarted. Verify the configuration and start `ltid`.

On Windows, the problem could be that the Media Manager device configuration was modified but the NetBackup Device Manager service was not restarted. Verify the configuration and restart the NetBackup Device Manager service.

3. Make sure the tapes are not write protected.
4. For detailed troubleshooting information:
 - a. Create a debug log directory for `bpdm` (if the device is disk) or `bptm` (if the device is tape).
 - b. On UNIX, restart `ltid` in the verbose mode by executing:

```
/usr/opensv/volmgr/bin/ltid -v
```

Or, add a `VERBOSE` entry to the Media Manager configuration file, `/usr/opensv/volmgr/vm.conf`. Create the `vm.conf` file if necessary.
 - c. On Windows, enable verbose logging by adding `VERBOSE` on a line by itself in the `install_path\Volmgr\vm.conf` file. Then, stop and restart the NetBackup Device Manager service.



- d. Retry the operation and check the resulting debug log files.
- e. On Windows systems, look at the `install_path\VERITAS\NetBackup\db\media\errors` log for a drive that is frequently producing errors.

On UNIX systems, look at the `/usr/opensv/netbackup/db/media/errors` log (which is also included in the `/usr/opensv/netbackup/bin/goodies/support/support` script output) for a drive that is frequently producing errors.

NetBackup Status Code: 84

Message: media write error

Explanation: The system's device driver returned an I/O error while NetBackup was writing to removable media or a disk file.

Recommended Action:

1. For NetBackup Advanced Client only:

If the following message appears in the `/usr/opensv/netbackup/bptm` log, and the values for `key`, `asc`, and `ascq` are all zero (0x0) as shown in this example message:

```
tape error occurred on extended copy command, key = 0x0, asc = 0x0, ascq = 0x0
```

your host-bus adapter and its driver are probably not supported by NetBackup Advanced Client. The host-bus adapters supported in the release are listed in the *NetBackup Release Notes*.

2. For additional information, check the following:
 - ◆ NetBackup Problems report to determine the device or media that caused the error
 - ◆ System and error logs for the system (UNIX)
 - ◆ Event Viewer Application and System logs (Windows)
3. If NetBackup was writing backups to a disk file, verify that the disk has enough space for the backup.

For a catalog backup to a disk path on a UNIX system, you may be trying to write a image greater than two gigabytes. File sizes greater than two gigabytes is a limitation on many UNIX file systems. Tape files do not have this limit.

4. If the media is tape or optical disk, check for:

- ◆ A defective or dirty drive, in which case, clean it or have it repaired (refer to the `tpclean` command for robotic drives).
- ◆ The wrong media type. Verify that the media matches the drive type you are using. On an optical drive, the platters may not be formatted correctly.
- ◆ Defective media. If this is the case, use the `bpmmedia` command to set the volume to the FROZEN state so it is not used for future backups.
- ◆ Incorrect drive configuration. Verify the Media Manager and system configuration for the drive.

For example, on UNIX the drive could be configured for fixed mode when it must be variable mode. See the *Media Manager Device Configuration Guide* for more information.

This often results in the media being frozen with a message, “too many data blocks written, check tape/drive block size configuration.”

NetBackup Status Code: 85

Message: media read error

Explanation: The system device driver returned an I/O error while NetBackup was reading from tape, optical disk, or a disk file.

Recommended Action:

1. For additional information, check the following:
 - ◆ NetBackup Problems report to determine the device or media that caused the error
 - ◆ System and error logs for the system (UNIX)
 - ◆ Event Viewer Application and System logs (Windows)
2. Check for the following:
 - ◆ A defective or dirty drive. Clean it or have it repaired (see the `tpclean` command for cleaning).
 - ◆ Incorrect drive configuration. Verify the Media Manager and system configuration for the drive.

For example, on UNIX the drive could be configured for fixed mode when it must be variable mode. See the *Media Manager Device Configuration Guide* for more information.
 - ◆ Defective media. In this case, you may not be able to recover all the data on the media. Use the `bpmmedia` command to set the volume to the FROZEN state so it is not used for future backups.



- ◆ The wrong media type. Verify that the media matches the drive type you are using.

NetBackup Status Code: 86

Message: media position error

Explanation: The system's device driver returned an I/O error while NetBackup was positioning media (tape or optical disk).

Recommended Action:

1. For additional information, check the following:
 - ◆ NetBackup Problems report to determine the device or media that caused the error
 - ◆ System and error logs for the system (UNIX)
 - ◆ Event Viewer Application and System logs (Windows)
2. Check for the following:
 - ◆ A defective or dirty drive. Clean it or have it repaired (see the `tpclean` command for cleaning).
 - ◆ Incorrect drive configuration. Verify the Media Manager and system configuration for the drive.

For example, on UNIX the drive could be configured for fixed mode when it must be variable mode. See the *Media Manager Device Configuration Guide* for more information.
 - ◆ Defective media. In this case, some data may be lost. Use the `bpmedia` command to set the volume to the FROZEN state so it is not used for future backups.
 - ◆ The wrong media type. Verify that the media matches the drive type you are using.

NetBackup Status Code: 87

Message: media close error

Explanation: The system's device driver returned an I/O error while NetBackup was closing a tape or optical disk.

Recommended Action:



1. For additional information, check the following:
 - ◆ NetBackup Problems report to determine the device or media that caused the error
 - ◆ System and error logs for the system (UNIX)
 - ◆ Event Viewer Application and System logs (Windows)
2. Check for the following:
 - ◆ A defective or dirty drive. Clean it or have it repaired (see the `tpclean` command for cleaning).
 - ◆ Defective media. In this case, some data may be lost. Use the `bpmedia` command to set the volume to the FROZEN state so it is not used for future backups.

NetBackup Status Code: 89

Message: problems encountered during setup of shared memory

Explanation: The NetBackup processes use shared memory for some operations. This error is returned when an error is encountered in the initialization of the shared memory via the operating system's APIs.

Recommended Action: Check for a shared memory problem. This error can occur if the system cannot allocate enough shared memory. This usually occurs when you use multiplexing, which increases the shared memory requirements. A symptom is an entry similar to the following in a NetBackup log (or report).

```
could not allocate enough shared memory
```

If you see this type of message, refer to the vendor documentation for your platform for instructions on increasing the amount of shared memory on your system.

Because system requirements vary, no absolute recommendations can be made, other than to use values great enough to provide resources to all applications. In at least one instance, however, the following was found to be adequate on a Sun platform:

```
set shmsys:shminfo_shmmax=8388608
set shmsys:shminfo_shmmin=1
set shmsys:shminfo_shmmni=100
set shmsys:shminfo_shmseg=10
set semsys:seminfo_semmnu=600
set semsys:seminfo_semmns=300
```

After making the changes to the `/etc/system` file on the Sun platform and rebooting with `boot -r`, the problem was resolved. Note that in the above, `shminfo_shmmin` must be less than or equal to 100 for NetBackup processes to run.



NetBackup Status Code: 90

Message: media manager received no data for backup image

Explanation: The tape manager (bptm) or disk manager (bpdm) received no data when performing a backup, archive, or duplication. This can occur for incremental backups where no data was backed up because no files have changed.

Recommended Action:

1. Check the All Log Entries report.
2. For detailed debug information, create bpdm or bptm debug log directories on the server. If the client is Windows, also create a bpbkar debug log directory on the client. Retry the operation and check the resulting debug logs.
3. For additional information, check the following:
 - ◆ NetBackup Problems report to determine the device or media that caused the error
 - ◆ System and error logs for the system (UNIX)
 - ◆ Event Viewer Application log (Windows)
4. Verify the Media Manager and system configuration for the drive.

For example, on UNIX the drive may not be set for variable mode in a case where that mode is required by NetBackup. Check the *Media Manager Device Configuration Guide* for drive configuration information.
5. Verify that the Media Manager configuration for the backup device matches what is specified for the storage unit in the NetBackup policy.
6. Verify that you are using the correct media in the drive.
7. For detailed debug information, create a bpdm or bptm debug log directory (whichever applies) on the server. If the client is Windows, also create a bpbkar debug log directory on the client. Retry the operation and check the resulting debug logs. Retry the operation. Check the resulting debug log file.
8. If the error was encountered by duplication or by a Vault session which is using an Alternate Read Server to do duplication, verify that the Alternate Read Server has access to the source media.

NetBackup Status Code: 91

Message: fatal NB media database error



Explanation: The tape manager (`bptm`) received an error while reading or updating its media catalog.

Recommended Action:

1. Check the All Log Entries report for more information.
2. Check the NetBackup Media Lists report to see if the catalog is intact. If the catalog is not intact, consider reloading it from the latest NetBackup catalog backup volume.
3. Verify that the disk partition on which the catalog resides has enough space.
4. If the above actions do not explain the problem, check the NetBackup Problems report.
5. For detailed troubleshooting information, create a `bptm` debug log directory on the server and retry the operation. Check the resulting debug log file.
6. Contact customer support and send appropriate problem and debug log sections.

NetBackup Status Code: 92

Message: media manager detected image that was not in tar format

Explanation: When performing a restore, the tape manager (`bptm`) or disk manager (`bpdm`) could not find a `tar` header at the offset it expected.

Recommended Action:

1. Perform a `bpverify` of the affected image to determine if it is written correctly.
2. Check the NetBackup Problems report for additional information about the error.
3. Verify the Media Manager and system configuration for the drive.

For example, on some UNIX systems, for example, if you do not configure the drive for variable-mode block size writes, backup images written to the media produce this error when an attempt is made to restore the image. For example, you see the following sequence of events:

- ◆ Backup succeeds
- ◆ Verify succeeds
- ◆ Restore fails

The `bptm` debug log shows an error similar to

```
00:58:54 [2304] <16> write_data: write of 32768 bytes indicated
```



only 29696 bytes were written, errno = 0

In this case, configure the drive for variable-mode block sizes and suspend media written on that device. See the *NetBackup Device Configuration Guide*.

The images written to those media may be restorable (this is platform dependent), but single file restores are almost guaranteed to fail. You can choose to expire these media and regenerate the backups, or you can attempt to duplicate the images on these media to another device and then expire the original copy.

4. Error code 92 has been encountered on some relabeled and value-added 8-mm tape drives where the drive's microcode incorrectly processes a "forward space record" SCSI command.
5. If the problem is not one of the above, create a debug log directory for either `bpdm` or `bptm` and retry the operation. Check the resulting debug log file.

NetBackup Status Code: 93

Message: media manager found wrong tape in drive

Explanation: When loading a volume for a backup or restore, the tape manager (`bptm`) found a volume loaded that did not have the expected tape header. This can indicate that volumes in a robot are not in the slots indicated in the Media Manager volume configuration.

Recommended Action:

- ◆ If the volume is in a robot and the robot supports barcodes, perform a Compare Contents with Volume Configuration (on Windows) or Compare robot contents with volume configuration (on UNIX). The resulting report shows which media ID was found and validates its slot number with what is in the Media Manager volume configuration. Then, either change the physical location in the robot or change the volume configuration to show the correct slot.
- ◆ If the volume was mounted on a nonrobotic drive, verify that the correct volume was mounted and assigned.

NetBackup Status Code: 94

Message: cannot position to correct image

Explanation: When searching for a backup image to restore, the tape manager (`bptm`) did not find the correct backup ID at the expected position on the volume. This can indicate a drive hardware problem.

Recommended Action:

1. Try the restore on another drive if possible.
2. For additional information, check the following:
 - ◆ NetBackup Problems report to determine the device or volume that caused the error
 - ◆ System and error logs for the system (UNIX)
 - ◆ Event Viewer Application and System logs (Windows)
3. For detailed troubleshooting information, create a debug log directory for `bptm` and retry the operation. Check the resulting debug log files.

NetBackup Status Code: 95

Message: requested media id was not found in NB media database and/or MM volume database

Explanation: An operation was requested on a media ID for which NetBackup does not have a record. An example of this is using `bpmmedia` to suspend or freeze a media ID that does not exist.

Recommended Action: Run a NetBackup Media List report to determine the valid media IDs. Then, retry the command with a valid media ID.

NetBackup Status Code: 96

Message: unable to allocate new media for backup, storage unit has none available

Explanation: The tape manager (`bptm`) could not allocate a new volume for backups. This indicates that the storage unit has no more volumes available in the volume pool for this backup. Note that NetBackup will not change storage units during the backup.

Recommended Action: Check the NetBackup Problems report to determine the storage unit that is out of media.

1. If the storage unit is a robot and there are empty slots, add more volumes (remember to specify the correct volume pool).
 - ◆ If there are no empty slots, move some media to nonrobotic and then add new volumes.
 - ◆ If you are having difficulty keeping track of your available volumes, try the `available_media` script:
On UNIX, this script is in:

```
/usr/opensv/netbackup/bin/goodies/available_media
```

On Windows, the script is in:



`install_path\NetBackup\bin\goodies\available_media.cmd`

This script lists all volumes in the Media Manager volume configuration, and augments that list with information on the volumes currently assigned to NetBackup.

2. Set up a scratch volume pool as a reserve of unassigned tapes. If NetBackup needs a new tape and no more tapes are available in the current volume pool, NetBackup moves a tape from the scratch pool into the volume pool that the backup is using.
3. If the storage unit and volume pool appear to have media, verify the following:
 - ◆ Volume is not FROZEN or SUSPENDED.
Check for this condition by using the NetBackup Media List report. If the volume is frozen or suspended, use the `bpmmedia` command to unfreeze or unsuspend it (if that is desired).
 - ◆ Volume has not expired or exceeded its maximum number of mounts.
 - ◆ Volume Database Host name for the device is correct.
If you change the Volume Database Host name, stop and restart the Media Manager device daemon, `ltid`, (if the server is UNIX) or the NetBackup Device Manager service (if the server is a Windows system).
 - ◆ The correct host is specified for the storage unit in the NetBackup configuration.
The host connection should be the server (master or media) that has drives connected to it.
 - ◆ The Media Manager volume configuration has media in the correct volume pool and unassigned or active media is available at the required retention level.
Use the NetBackup Media List report to show the retention levels, volume pools, and status (active and so on) for all volumes. Use the NetBackup Media Summary report to check for active volumes at the correct retention levels.
4. In some configurations, the NetBackup `bptm` process is rejected when requesting media from the `vmd` process (UNIX) or the NetBackup Volume Manager service (Windows) because that process or service cannot determine the name of the host that is making the request.

This can be due to incorrect network configuration involving:

- ◆ Multiple network interfaces
 - ◆ `/etc/resolv.conf` on those UNIX systems that use it
 - ◆ Running DNS and not having reverse addressing configured
5. Create `bptm` and `vmd` debug log directories and retry the operation.

6. Examine the `bptm` debug log to verify that `bptm` is connecting to the correct system. If an error is logged, examine the `vmd` log.

On UNIX, the `vmd` log is:

```
/usr/opensv/volmgr/debug/daemon/log.xxxxxx
```

On Windows, the `vmd` log is:

```
install_path\Volmgr\debug\daemon\xxxxxx.log
```

7. If this is a new storage unit, and this is the first attempt to use it, stop and restart NetBackup on the master server.

Note The `bptm` debug logs (in verbose mode) usually show the NetBackup media selection process.

NetBackup Status Code: 97

Message: requested media id is in use, cannot process request

Explanation: An operation was requested on a media ID that is in use. An example of this is attempting to suspend or freeze a volume while it is being used for a backup or restore.

Recommended Action: Retry the command when the volume is not in use. Use the Device Monitor to determine if the volume is in use.

NetBackup Status Code: 98

Message: error requesting media (tpreq)

Explanation: The tape manager and optical manager (`bptm`) received an error when requesting a media mount from the NetBackup Device Manager service (on Windows) or the Media Manager device daemon (`ltid`) (on UNIX).

Recommended Action:

- ◆ Check the NetBackup Problems report to determine the reason for the failure. The most common cause is that the NetBackup Device Manager service (on Windows) or the Media Manager device daemon (`ltid`) (on UNIX) is not running. Start it if necessary.
- ◆ If duplicating backups or using Vault to duplicate backups, this error could be an indication that the Alternate Read Server does not have access to the tape on which the original backup resides.

NetBackup Status Code: 99

Message: NDMP backup failure



Explanation: None of the paths in your NDMP policy file list was backed up successfully.

Recommended Action: Check the NetBackup All Log Entries report for more information. A possible cause for this error is that none of the backup paths exist on the NDMP host.

NetBackup Status Code: 100

Message: system error occurred while processing user command

Explanation: A system call failed in `bparchive`, `bpbackup`, `bpulist`, or `bprestore`.

Recommended Action:

1. Enable debug logging for `bparchive`, `bpbackup`, `bpulist`, or `bprestore` (as appropriate) by creating debug log directories for them.

On UNIX, if a nonroot user is having problems, verify that the directory created has mode 666. Look for and correct any reported errors.

2. Retry the operation and check the resulting logs.

If the logs do not reveal the problem, use the command line version of the command and correct any problems that are reported on `stderr`.

NetBackup Status Code: 101

Message: failed opening mail pipe

Explanation: The process that attempts to send mail could not open the pipe to the server.

Recommended Action: Verify that mail is configured on the client. For detailed troubleshooting information, create a `bpacd` debug log directory and retry the operation. Check the resulting `bpacd` debug log.

NetBackup Status Code: 102

Message: failed closing mail pipe

Explanation: The process that sends mail could not close the pipe to the server.

Recommended Action: Verify that mail is configured on the client. For detailed troubleshooting information, create a `bpacd` debug log directory and retry the operation. Check the resulting `bpacd` debug log.

NetBackup Status Code: 103

Message: error occurred during initialization, check configuration file

Explanation: None

Recommended Action: None

NetBackup Status Code: 104

Message: invalid file pathname

Explanation: None

Recommended Action: None

NetBackup Status Code: 105

Message: file pathname exceeds the maximum length allowed

Explanation: The path name built by using the current working directory exceeds the maximum path length allowed by the system.

Recommended Action: Shorten the current working directory path length.

NetBackup Status Code: 106

Message: invalid file pathname found, cannot process request

Explanation: One of the file paths to be backed up or archived is not valid.

Recommended Action: Verify that full path names are used (they start with / on UNIX), and they are less than the maximum path length for the system. Also, verify that the files exist and the permissions allow NetBackup to access them.

NetBackup Status Code: 109

Message: invalid date specified

Explanation: This error can occur when executing a command on the command line that contains a date option. The format of a date option can vary depending on the locale of the master server.

Recommended Action:

1. If the error occurred on a command line, examine the standard error output from the command for an explanatory message.
2. Refer to the format for the date options in the usage statement for the command. Look up the locale of the master server. Compare the date format of that locale with the date format on the usage statement for the command.
3. Check the NetBackup Problems report for clues.



4. If the error is being displayed from a Java interface, enable the debug print manager in the Java startup file. Retry and compare the parameters logged in the Java log with the parameters listed in the command's usage statement.
5. If the above actions do not reveal the problem, create a debug log directory for the process that returned this status code, retry the operation, and check the resulting debug log.

NetBackup Status Code: 110

Message: Cannot find the NetBackup configuration information

Explanation: On Windows, NetBackup could not read the registry entries that were created during installation. On UNIX, the `/usr/opensv/netbackup/bp.conf` file does not exist.

Recommended Action: On Windows, reinstall NetBackup software on the client. On UNIX, create a `/usr/opensv/netbackup/bp.conf` file with at least the following lines:

```
SERVER = server_name
CLIENT_NAME = client_name
```

NetBackup Status Code: 111

Message: No entry was found in the server list

Explanation: On UNIX, the `SERVER = server_name` line is missing in the `bp.conf` file. On Windows, the server list contains no entries.

Recommended Action:

- ◆ On a UNIX client, add the following line to the top of the `/usr/opensv/netbackup/bp.conf` file:

```
SERVER = server_name
```
- ◆ On a Microsoft Windows or nontarget NetWare client, add the server name on the **Servers** tab in the Specify NetBackup Machines and Policy Type dialog box. To display this dialog, start the Backup, Archive, and Restore interface on the client and click **Specify NetBackup Machines and Policy Type** on the **File** menu.
- ◆ Run the NetBackup Configuration Validation Utility (NCVU) for the associated NetBackup clients. Note the `bp.conf` or `bpgetconfig` checks in section four.
- ◆ On an OS/2 or NetWare target client, add the server name to the `bp.ini` file.
- ◆ On a Macintosh client, add the `SERVER = server_name` line to the `bp.conf` file in the NetBackup folder in the Preferences folder.

NetBackup Status Code: 112

Message: no files specified in the file list

Explanation: A restore was requested with no files in the file list.

Recommended Action: Specify at least one file to be restored.

NetBackup Status Code: 116

Message: VxSS authentication failed

Explanation: The parties on either end of a socket connection were unable to mutually authenticate each other.

Recommended Action:

1. Ensure that the VERITAS Security Services is installed and configured. For complete installation instructions please see the *VERITAS Security Services Installation Guide*.
2. Check that both parties have a valid certificate. This can be done by examining the expiry date listed from a `bpnbat -WhoAmI`. For example:

```
bpnbat -WhoAmI
Name: JDOG
Domain: MYCOMPANY
Issued by: /CN=broker/OU=root@machine1.mycompany.com/O=vx
Expiry Date: Sep 19 12:51:55 2003 GMT
Authentication method: Microsoft Windows
Operation completed successfully.
```

Shows an expiry date of September 19th, 2003. After 12:51:55 GMT this credential is no longer valid and a new credential is required.

3. If running from the NetBackup Administration console, close and reopen the console. The console automatically obtains a credential for the currently logged in identity, if possible. By default these certificates are valid for 24 hours. To set a longer default time please consult the *VERITAS Security Services Administrator's Guide*.
4. Ensure that the certificates for both sides either use the same broker, are children of the same root broker, or have trusts established between them. See the *VERITAS Security Services Administrator's Guide* for more information on broker hierarchies and establishing trust relationships between brokers.
5. Ensure that connectivity is possible between the physical systems in question. If general sockets cannot connect between the machines (such as ping and telnet), there may be issues within the network unrelated to NetBackup that are causing this problem.



6. Ensure that the system has sufficient swap space and the following directories are not full:
 - ◆ `/home/username`
 - ◆ `/user/openv/netbackup/logs`
 - ◆ `/tmp`

NetBackup Status Code: 117**Message:** VxSS access denied**Explanation:** The user identity used to attempt an operation does not have the permissions needed to perform the action.**Recommended Action:**

1. If using the default groups, make certain that the user is attempting to perform an operation appropriate for that group. For example, a member of NBU_Operators is unable to modify policy information; this is a permission reserved for administrator roles.
2. Ensure that the system has sufficient swap space and the following directories are not full:
 - ◆ `/home/username`
 - ◆ `/user/openv/netbackup/logs`
 - ◆ `/tmp`
3. If using your own defined groups and permissions, first determine the object with which the operation is associated, and then add the permissions relative to the action. For example, if a user is required to up and down drives but does not currently have permission to do so, verify that the user belongs to the correct authorization group.

If needed, verify that the group has Up and Down permissions on the Drive object within the Group Permission tab. If necessary, you can increase the verbosity level of NetBackup to locate what object and what permissions are required for the failing request. The pertinent lines in the debug logs will look similar to the following:

```
17:19:27.653 [904.872] <2> GetAzinfo: Peer Cred Info.  
Name: JMIZZLE  
Domain: MYCOMPANY  
Expiry: Sep 24 21:45:32 2003 GMT  
Issued by: /CN=broker/OU=root@machine1.mycompany.com/O=vx  
AuthType: 1  
17:19:37.077 [904.872] <2> VssAzAuthorize: vss_az.cpp.5082:  
Function: VssAzAuthorize. Object
```

```
NBU_RES_Drives
17:19:37.077 [904.872] <2> VssAzAuthorize: vss_az.cpp.5083:
Function: VssAzAuthorize. Permissions Up
17:19:40.171 [904.872] <2> VssAzAuthorize: vss_az.cpp.5166:
Function: VssAzAuthorize. 20 Permission denied.
```

In the instance illustrated above, the user JMIZZLE is attempting to perform an operation that requires the Up permission on the Drives object. To diagnose the problem, examine the group(s) to which the user belongs to ensure that the appropriate group includes the Up permission (Up is a member of the Operate permission set for Drives).

NetBackup Status Code: 118

Message: VxSS authorization failed

Explanation: NetBackup was unable to complete the authorization check against the Authorization service.

Recommended Action:

1. Ensure the Authorization Service/Daemon is running. Please refer to the *VERITAS Security Services Administrator's Guide* for more information on Authentication and Authorization Daemons.
2. Ensure you are talking to the correct master server. Within the bp.conf files on the local server verify that the entry AUTHORIZATION_SERVICES specifies the proper host name, fully qualified, of the Authorization service. For example,

```
AUTHORIZATION_SERVICE = machine2.mycompany.com 0
```

specifies that the server will contact machine2 in order to perform Authorization checks. Also ensure that this entry matches that of the master server.
3. Please ensure that the system has sufficient swap space and the following directories are not full:
 - ◆ /home/<userName>
 - ◆ /user/opencv/netbackup/logs
 - ◆ /tmp
4. Ensure the server contacting the master has a valid certificate. The machine certificate can be examined as follows:

For UNIX:



```
# bpnbat -WhoAmI -cf
/usr/opensv/var/vxss/credentials/machine3.mycompany.com
```

For Windows:

```
Bpnbat WhoAmI -cf "c:\Program
Files\VERITAS\NetBackup\var\vxss\credentials\machine3.mycompany
.com"
```

Both of which would return:

```
Name: machine3.mycompany.com
Domain: NBU_Machines@machine2.mycompany.com
Issued by: /CN=broker/OU=root@machine2.mycompany.com/O=vx
Expiry Date: Sep  2 19:25:29 2004 GMT
Authentication method: VERITAS Private Security
```

Operation completed successfully.

If the expiry date has been exceeded it is necessary to use `bpnbat -LoginMachine` to obtain a new credential for the machine. Please see the *Netbackup Commands* manual for more information on `bpnbat`.

The server attempting the check is not authorized to examine the Authorization database. Ensure that `bpnbaz -ShowAuthorizers` returned the machines identity. Ensure the machine has a machine credential under the directory (Program Files\VERITAS\var\vxss\credentials for Windows, /usr/opensv/var/vxss/credentials for UNIX).

This credential should have the full name of the machine, for example, machine1.company.com.

5. Check that the maximum number of open sockets to the Authorization database has not been exhausted. This can be done by using `netstat` to determine the number of sockets opened to port 4032 on the Authorization server, and referring to the following configuration entries on Windows and UNIX:

Windows:

```
HKLM\SOFTWARE\VERITAS\Security\Authorization\Communication\Clie
ntMaxConnections
```

UNIX:

```
/etc/vx/vss/VRTSaz.conf entry "ClientMaxConnections"
```

If the maximum number of open connections has been reached it may be necessary to increase the number of maximum open connections. Increasing the number of open connections will increase the memory footprint of the Authorization service/daemon. Extreme increases in the maximum number of connections can result in performance degradation.

NetBackup Status Code: 120

Message: cannot find configuration database record for requested NB database backup

Explanation: The program that backs up the NetBackup internal catalogs could not find the attributes that indicate which media IDs to use or paths to back up. This error should not occur under normal circumstances.

Recommended Action:

1. Check the NetBackup Problems report for additional information about the error.
2. For detailed troubleshooting information, create `admin` and `bpdbm` debug log directories and retry the operation. Check the resulting debug logs.
3. Contact customer support and send appropriate problem and debug log sections detailing the error.

NetBackup Status Code: 121

Message: no media is defined for the requested NB database backup

Explanation: NetBackup attempted to back up its internal catalogs and there were no media IDs defined in the catalog backup configuration.

Recommended Action: Add the media IDs to the catalog backup configuration. Verify that the media IDs are in the NetBackup volume pool.

Run the NetBackup Configuration Validation Utility (NCVU) on the master server. Note the NetBackup database configuration checks in section six.

NetBackup Status Code: 122

Message: specified device path does not exist

Explanation: The NetBackup internal catalogs were backed up by using the `bpbackupdb` command line and specifying a device path (on Windows) or a raw device file (on UNIX) that does not exist.

Recommended Action: Retry the command using a valid device file name.

Run the NetBackup Configuration Validation Utility (NCVU) on the master server. Note the NetBackup database configuration checks in section six.



NetBackup Status Code: 123

Message: specified disk path is not a directory

Explanation: NetBackup attempted to back up its internal catalogs and the backup attributes were set to dump to a disk. However, the disk file path already exists and is not a directory.

Recommended Action: Specify a different disk path for the catalog backup or delete the file that already exists.

NetBackup Status Code: 124

Message: NB database backup failed, a path was not found or is inaccessible

Explanation: One or more of the paths specified in the catalog backup configuration could not be backed up.

Recommended Action:

1. Check the NetBackup Problems report for additional information about the error. Some possible causes are:
 - ◆ The path does not exist.
 - ◆ On a UNIX system, there is a symbolic link in one of the paths.
2. After determining which path could not be accessed, correct the path names in the catalog backup configuration.

NetBackup Status Code: 125

Message: another NB database backup is already in progress

Explanation: Only one NetBackup catalog backup may be active at any given time.

Recommended Action: None.

NetBackup Status Code: 126

Message: NB database backup header is too large, too many paths specified

Explanation: Too many paths were specified in the NetBackup catalog backup configuration to fit in a fixed-size media header. This error should not occur under normal circumstances.

Recommended Action: Delete some of the paths from the catalog backup configuration.

NetBackup Status Code: 127

Message: specified media or path does not contain a valid NB database backup header

Explanation: The `bprecover` command was issued and the media ID specified does not have valid catalog backup data.

Recommended Action: Validate that the correct media ID is being used.

NetBackup Status Code: 128

Message: NB database recovery failed, a process has encountered an exceptional condition

Explanation: One or more catalogs specified for recovery could not be restored. For more detail, refer to the error message issued just above this status code in the output from the `bprecover` command.

Recommended Action:

1. After fixing the problem reported in the error message in the `bprecover` output, refer to [“Recovering the NetBackup Catalogs for Windows”](#) on page 544 or [“Recovering the NetBackup Catalogs for UNIX”](#) on page 524 to identify which NetBackup services (Windows) or daemons (UNIX) should be shut down prior to attempting the NetBackup database recovery. The NetBackup services should be shut down except for the NetBackup Client Service, which must be running for the database recovery to succeed.
2. Check the NetBackup Problems report for additional information about the error. Some possible causes are:
 - ◆ A disk may be full.
 - ◆ The NetBackup catalog tape may be corrupt.

NetBackup Status Code: 130

Message: system error occurred

Explanation: An error occurred that prevents the product from operating in a consistent fashion. This error is usually related to a system call.

Recommended Action:

1. Check the NetBackup Problems report for additional information about the error.
2. Check the system log for reported problems.



3. For detailed troubleshooting information, create `bpdbm`, `bpsched`, `bptm`, and `bprd` debug log directories on the master server and retry the operation. Check the resulting debug logs.

NetBackup Status Code: 131

Message: client is not validated to use the server

Explanation: The client name, as determined from the connection to the server, did not match any client name in the NetBackup configuration and there was no `altnames` configuration for this client on the master server. A client and server that have multiple network connections can encounter this problem if the name by which the client is configured is not the one by which its routing tables direct connections to the server.

Recommended Action:

1. Examine the NetBackup Problems report.
2. Create a debug log directory for `bprd` and retry the operation. Check the resulting debug log to determine the connection and client names.

Depending on the request type (restore, backup, and so on.), you may need or want to:

- ◆ Change the client's configured name.
- ◆ Modify the routing tables on the client.
- ◆ On the master server, set up an `altnames` directory and file for this client (see the *NetBackup System Administrator's Guide*).

or

- ◆ On a UNIX master server, create a soft link in the NetBackup image catalog.
3. Review "[Verifying Host Names and Services Entries](#)" on page 34.
 4. Run the NetBackup Configuration Validation Utility (NCVU) `-conf <client option>` on the master server for the associated NetBackup clients. Note the client hostname checks in section seven.

NetBackup Status Code: 132

Message: user is not validated to use the server from this client

Explanation: None

Recommended Action: None

NetBackup Status Code: 133**Message:** invalid request**Explanation:** One of two explanations exist.

- ◆ A request was made that is unrecognized. This usually results from different versions of NetBackup software being used together.
- ◆ If a client receives this error in response to a list or restore request, it means that the `DISALLOW_CLIENT_LIST_RESTORE` or `DISALLOW_CLIENT_RESTORE` option exists in the `bp.conf` file on a UNIX NetBackup server or in the registry on a Windows NetBackup server. These options deny list and restore requests from all NetBackup clients.

Recommended Action:

1. If you suspect that the software versions are the problem, verify that all NetBackup software is at the same version level.
 - ◆ On UNIX NetBackup servers and clients, check the `/usr/opensv/netbackup/bin/version` file.
 - ◆ On Windows NetBackup servers, check the `install_path\netbackup\version.txt` file or the **About NetBackup** item on the **Help** menu.
 - ◆ On Microsoft Windows clients, check the **About NetBackup** item on the **Help** menu.
 - ◆ On NetWare target clients, check the Version entry in the `bp.ini` file.
If the client software is earlier than 3.0, verify that the client is in a Standard type policy.
 - ◆ On Macintosh clients, check the version file in the bin folder in the NetBackup folder in the Preferences folder.
2. If the server is denying list and restore requests, remove the `DISALLOW_CLIENT_LIST_RESTORE` and `DISALLOW_CLIENT_RESTORE` options from the `bp.conf` file on a UNIX NetBackup server or from the registry on a Windows NetBackup server. Then, stop and restart the NetBackup request daemon (UNIX) or NetBackup Request Manager service (Windows).
3. For detailed troubleshooting information, create `bpdbm`, `bprd`, and `admin` debug log directories. Then, retry the operation and check the resulting debug logs.

NetBackup Status Code: 134**Message:** unable to process request because the server resources are busy

Explanation: Status code 134 is an informational message indicating that all drives in the storage unit are currently in use. If this occurs, NetBackup automatically tries another storage unit; if one is not available, NetBackup requeues the job with a status of 134 and retries it later.

Recommended Action: None.

The 134 code is an informational message only and is not considered an error. It can occur for a number of reasons in normal operation. The 134 status code can occur more frequently in an SSO environment. No action is necessary.

A 134 status is not logged in the error logs (as of versions 3.4 MP4 and 4.5 MP2). A 134 status will cause a new try to show up in the Activity Monitor, but will not increment the retry count associated with the number of retries allowed.

NetBackup Status Code: 135

Message: client is not validated to perform the requested operation

Explanation: This is usually caused by a request to restore files to a client other than the one that made the request and the request did not come from the root user (on UNIX) or the administrator (on Windows) on a NetBackup server.

Recommended Action: Retry the operation as a root user (on UNIX) or as an administrator (on Windows) on the master server. Also see status code 131.

NetBackup Status Code: 136

Message: tir info was pruned from the image file

Explanation: The TIR information has been pruned from one or more of the component (differential or cumulative) backup images that are being synthesized. This situation arises when the most recent backup image for the client is a synthetic full or cumulative backup and the TIR information from one or more of the component images prior to the synthetic full (or cumulative) backup has been pruned. Now if you expire the synthetic backup (full or cumulative) image and try to rerun the synthetic backup job for the client, the TIR information will be automatically restored to the image catalog. However, if the TIR restore fails due to bad or missing or vaulted media, or a bad drive, the synthetic backup job will fail with this error.

Recommended Action: You need to reimport the TIR information into the catalog of each component image (from which the TIR information has been pruned) and rerun the synthetic backup job. The TIR information can be imported into the image catalog by initiating a true image restore of any file from that component image. The restore process will also restore the TIR information in the image catalog.

NetBackup Status Code: 140

Message: user id was not superuser

Explanation: The process was started by a user or process that did not have root privileges (on UNIX) or administrator privileges (on Windows).

Recommended Action: If desired, give the user or process administrator privileges (on Windows) or root privileges (on UNIX) and retry the operation.

NetBackup Status Code: 141

Message: file path specified is not absolute

Explanation: The file specification must be an absolute path.

Recommended Action: Correct the file specification and retry the command.

NetBackup Status Code: 142

Message: file does not exist

Explanation: To use Advanced Client to back up a VxFS file system, the VxFS file system on the client has to be patched with the correct dynamic linked libraries. If the correct VxFS libraries are not installed, the backup fails with status 142. For most snapshot backups, the following message appears in the /usr/opensv/netbackup/logs/online_util log on the client:

```
09:36:48.299 [527] <32> fs_dev_rt_check: FTL - snapshot method:
nbu_snap abort - required VxFS dynamic linked libraries for NetBackup
are not installed. Please visit the VERITAS support web site, and
refer to Technote number 262225 for further information.
```

For backups run from a FlashBackup policy, the following appears in the /usr/opensv/netbackup/logs/bpbkar log on the client:

```
10:09:56.566 [1146] <32> bpfsmmap: FTL - bpfsmmap: FlashBackup abort -
required VxFS dynamic linked libraries for NetBackup are not
installed. Please visit the VERITAS support web site, and refer to
Technote number 262225 for further information.
10:09:56.571 [1146] <16> bpbkar Exit: ERR - bpbkar FATAL exit status =
142: file does not exist
10:09:56.573 [1146] <4> bpbkar Exit: INF - EXIT STATUS 142: file does
not exist
```

Recommended Action: Install the VxFS dynamic libraries on the NetBackup client as described in the above technote and try the backup again.



NetBackup Status Code: 143

Message: invalid command protocol

Explanation: An ill-formed request was made to the NetBackup request daemon (UNIX) or to the Request Manager service (Windows). This can be due to mismatched versions of the product, corrupted network communication, or to a non-NetBackup process sending data across the port for the daemon or service.

Recommended Action: Examine the NetBackup error logs to determine the system that was the source of the data and on that system determine the process that initiated the request. If it was a NetBackup process, verify that the process or command is compatible with the version of software on the server.

NetBackup Status Code: 144

Message: invalid command usage

Explanation: This status code is due to a NetBackup process being started with improper options or an incompatibility in the product.

Recommended Action: Either correct the command or verify that all NetBackup binaries are at the same version level.

NetBackup Status Code: 145

Message: daemon is already running

Explanation: There is another copy of the process executing.

Recommended Action: Terminate the current copy of the process and then restart the process.

NetBackup Status Code: 146

Message: cannot get a bound socket

Explanation: The service or daemon could not bind to its socket. A system call failed when the daemon (UNIX) or service (Windows) attempted to bind to its configured port number. This is usually caused by another process having acquired the port before the daemon or service started.

Recommended Action:

1. Examine the NetBackup Problems and All Log Entries reports.
2. Create `bprd` and `bpdbm` debug log directories and retry the operation. Check the resulting logs to see the system error message resulting from the attempt.

If another process has the port, use other system commands to determine the process. Based on this research, either change the port number in your `services` file or map or terminate the process that has acquired the port.

On UNIX, another possible cause for this error is terminating `bprcd` or `bpdbm` with the `kill` command. If you have to stop `bprcd`, the recommended method is to use the **Terminate Request Daemon** option on the **Special Actions** menu in `bpadm` (or the equivalent option in `xbpdm`). To stop `bpdbm`, use the `/usr/opensv/netbackup/bin/bpdbm -terminate` command. Using the `kill` command to stop these processes can leave them unable to bind to their assigned ports the next time they are started.

To identify a `bprcd` or `bpdbm` problem, look for lines similar to the following in the debug log for the respective process:

```
<16> getsockbound: bind() failed, Address already in use (114)
<32> listen_loop: cannot get bound socket. errno = 114
<4> terminate: termination begun...error code = 146
```

Similar entries can appear in the reports.

3. If the problem persists longer than ten minutes, it is possible that it will be necessary to reboot the server.

NetBackup Status Code: 147

Message: required or specified copy was not found

Explanation: The requested copy number of a backup or archive image cannot be found.

Recommended Action: Correct the request to specify a copy number that does exist.

NetBackup Status Code: 148

Message: daemon fork failed

Explanation: A NetBackup service could not create a child process due to an error received from the system. This is probably an intermittent error based on the availability of resources on the system.

Recommended Action:

1. Restart the service at a later time and investigate system problems that limit the number of processes.
2. On Windows systems, check the Event Viewer Application and System logs.



NetBackup Status Code: 149

Message: master server request failed

Explanation: None

Recommended Action: None

NetBackup Status Code: 150

Message: termination requested by administrator

Explanation: The process is terminating (or has terminated) as a direct result of a request from an authorized user or process.

Recommended Action: None.

NetBackup Status Code: 151

Message: Backup Exec operation failed

Explanation: The Global Data Manager console has reported that a Backup Exec job (backup, archive, or restore) did not complete normally.

Recommended Action: Consult the Backup Exec job history on the Backup Exec server for details.

NetBackup Status Code: 152

Message: required value not set

Explanation: An incomplete request was made to the `bpdbm` process (on UNIX), or the NetBackup Database Manager service (on Windows). This usually occurs because different versions of software are being used together.

Recommended Action:

1. Verify that all software is at the same version level.
2. For detailed troubleshooting information, create `bpdbm` and `admin` debug log directories and retry the operation. Check the resulting debug logs.

NetBackup Status Code: 153

Message: server is not the master server

Explanation: This status code is reserved for future use.

Recommended Action: None.

NetBackup Status Code: 154**Message:** storage unit characteristics mismatched to request**Explanation:** A backup was attempted and the storage unit selected for use had characteristics that were not compatible with the backup type.**Recommended Action:** Verify that the characteristics of the storage unit involved are appropriate for the backup attempted:

- ◆ For NetBackup Advanced Client only:

The policy storage unit was set to **Any_available** and the offhost backup method was set to **Third-Party Copy Device** or **NetBackup Media Server**. Do not choose **Any_available**. A particular storage unit (such as `nut-4mm-robot-t14-0`) must be specified when **Third-Party Copy Device** or **NetBackup Media Server** is specified as the offhost backup method.
- ◆ For an NDMP policy type, verify that a storage unit of type NDMP is defined and the NDMP host value matches the host name of the client. For example, if the NDMP policy specifies `toaster` as the client, the configuration for the storage unit must specify `toaster` as the NDMP host.
- ◆ For a policy type other than NDMP, verify that the policy specifies a Media Manager or Disk type storage unit.

NetBackup Status Code: 155**Message:** disk is full**Explanation:** The write to the catalog file failed because the disk containing the catalog database is full.**Recommended Action:**

Free up space on the disks where NetBackup catalogs reside and retry the operation.

NetBackup Status Code: 156**Message:** snapshot error encountered**Explanation:** If a backup on a Windows NetBackup 5.0 or later client fails with status code 156 and the client is using Windows Open File Backups to back up open or active files, it is possible that the error was caused by the VSP/VSS cache file being full as files are being backed up using VSP/VSS. This is caused by the cache files being too small for the number of files being backed up.

```
8:51:14.569 AM: [1924.2304] <2> tar_base::V_vTarMsgW: ERR - failure
reading file: D:\ test.file (WIN32 5: Access is denied. )
8:51:14.569 AM: [1924.2304] <4> tar_base::V_vTarMsgW: INF - tar
message received from dos_backup::tfs_readdata
```



```
8:51:14.569 AM: [1924.2304] <2> tar_base::V_vTarMsgW: ERR - Snapshot Error while reading test.file
8:51:14.569 AM: [1924.2304] <4> tar_base::V_vTarMsgW: INF - tar message received from tar_backup::nextfile_state_switch
8:51:14.569 AM: [1924.2304] <2> tar_base::V_vTarMsgW: FTL - Backup operation aborted!
8:51:14.569 AM: [1924.2304] <2> tar_base::V_vTarMsgW: INF - Client completed sending data for backup
8:51:14.569 AM: [1924.2304] <2> tar_base::V_vTarMsgW: INF - EXIT STATUS 156: snapshot error encountered
```

If this is the case, and `bbpkar` debug logs are turned on, a message similar to the one above should appear in the `bbpkar` debug log for the backup.

Recommended Action:

Increase the sizes of the VSP/VSS cache files used by the backup. This recommended action depend on whether VSP (VERITAS Volume Snapshot Provider) or VSS (Microsoft Volume Shadow Copy Service) was used as the Windows Open File Backup Snapshot Provider. If VSP is being used as the snapshot provider, try one of the following:

1. (preferred) Change the VSP Cache File Size configuration for the affected client in the VSP tab for the client's Host Properties in the NetBackup Administration Console. Ensure that the "Customize the cache sizes" check box is unchecked to let NetBackup automatically determine the best VSP cache file sizes. In most cases, NetBackup will be able to create a large enough VSP cache file for backups if the "Customize the cache sizes" check box is unchecked.
2. Increase either the initial VSP cache size and the maximum VSP cache size on your own, depending on the requirements of your installation and your usage of VSP. To specify your own Initial and Maximum Cache File sizes, select the **Customize the cache sizes** checkbox and specify your own Initial and Maximum Cache File Sizes either in MBs or percentage of disk space. Use caution when manually specifying sizes for the Initial and Maximum Cache Size since it is used regardless of the sizes of the volumes being backed up. If enough space is not allocated, the backup job could fail with a snapshot error.

Please see the *NetBackup System Administrator's Guide* for more information on changing the configuration of VSP cache file sizes.

If backups still abort with error status 156 after making changes to the VSP cache file size configuration, there may not be enough free disk space on the affected client. Free up as much disk space on the drives of the affected client as possible.

If VSS is being used as the Window Open File Backup Snapshot Provider, increase the cache size being used by VSS by using the Shadow Copy configuration in Windows 2003. Use the following steps to increase the cache size.

1. Open the Windows 2003 Computer Management application. To open Computer Management, click **Start**, point to **Settings**, click **Control Panel**, double-click **Administrative Tools**, and then double-click **Computer Management**.
2. In the console tree, right-click **Shared Folders**, select **All Tasks**, and select **Configure Shadow Copies**.
3. Select the volume where you want to make changes, and then select **Settings**.
4. In the Settings dialog box, change the **Maximum Size** setting to either No Limit or a size large enough to suit the requirements of your installation and your usage of VSS.

NetBackup Status Code: 157

Message: suspend requested by administrator

Explanation: Status code 157 is an informational message indicating that the administrator suspended the job from the Activity Monitor. The job will be in the suspended state in the Activity Monitor, and may be resumed from the last checkpoint by the administrator.

Recommended Action: The administrator may resume the job from the last checkpoint. This is done from the Activity Monitor.

NetBackup Status Code: 158

Message: failed accessing daemon lock file

Explanation: The process could not lock its lock file because an error was received from a system call. This lock file synchronizes process activities (for example, preventing more than one daemon from executing at a time).

Recommended Action:

1. Examine the NetBackup error log to determine why the system call failed and correct the problem. It could be a permission problem.
2. If the error log does not show the error, create a debug log directory for `bprd`, `bpdbm`, or `bpsched` (depending on which process encountered the error) and retry the operation. Examine the resulting debug log.

NetBackup Status Code: 159

Message: licensed use has been exceeded

Explanation: A configuration limit has been exceeded.

For example, a job fails with this error code if a policy is set up that:



- ◆ specifies a storage unit that is on a SAN media server, and
- ◆ specifies a client that is not the SAN media server itself.

SAN media servers can only back up themselves.

This status code is used when the creation of a storage unit on a SAN media server fails because “On demand only” is not selected. “On demand only” is required for storage units on a SAN media server.

Recommended Action: To determine the cause of the error, examine the NetBackup All Log Entries report for the command that was being executed. See also the Activity Monitor details for informative messages.

If the job fails on a SAN media server storage unit, ensure that only the local client is specified in the policy. If remote clients are specified in the policy, either they need to be removed and placed in a policy that specifies a different storage unit or the storage unit needs to be changed for that policy.

If you would like to back up remote clients using the SAN media server, you may purchase a regular NetBackup media server license.

NetBackup Status Code: 160

Message: authentication failed

Explanation: A problem was encountered when two systems were attempting to authenticate one another.

Recommended Action: See the *NetBackup System Administrator’s Guide* for more information on the files and commands mentioned here.

1. Ensure that the authentication libraries exist:

Windows:

```
install_path\NetBackup\lib\libvopie.dll  
install_path\NetBackup\lib\libvnoauth.dll
```

UNIX (except HP-UX):

```
/usr/obj/lib/libvopie.so  
/usr/obj/lib/libvnoauth.so
```

UNIX (HP-UX only):

```
/usr/obj/lib/libvopie.sl  
/usr/obj/lib/libvnoauth.sl
```

Macintosh:

```
:System Folder:Extensions:libvopie.dll  
:System Folder:Extensions:libvnoauth.dll
```

2. Check the `methods_allow.txt` files on the systems that are having problems to ensure that authentication is enabled. The files are in the following locations:

Windows:

```
install_path\NetBackup\var\auth
```

UNIX:

```
/usr/opensv/var/auth
```

Macintosh:

```
:System Folder:Preferences:NetBackup:var:auth
```

If one system reports authentication failed (status code 160) and the other system reports network connection timed out (status code 41), you may have enabled authentication in the first system's `methods_allow.txt` file but not in the second system's `methods_allow.txt` file.

3. On the systems that are having the authentication problem, remove the remote host that is not being authenticated from the `methods_allow.txt` file.

For example, if host A and host B are having the problem, remove host A from the file on host B and vice versa.

Retry the operation.

- ◆ If the problem still exists, it indicates connection problems not related to authentication.
- ◆ If connections are now successful, proceed to the next step.

4. Execute `bpauthsync -vopie` on the master server to resynchronize the key files on the systems.

On Windows:

```
install_path\NetBackup\bin\admincmd\bpauthsync -vopie -servers  
-clients
```

On UNIX:

```
/usr/opensv/netbackup/bin/admincmd/bpauthsync -vopie -servers  
-clients
```

5. Add back the names removed in step 3 and retry the operation.
6. Create debug log directories for the processes involved in authentication between NetBackup systems. These include:
 - ◆ On the server, create debug log directories for `bprd`, `bpdbm`, `bpcd`.



- ◆ On the client, create debug log directories for `bpbackup`, `bprestore`, `bpbkar` (Windows only).

Retry the operation and check the logs.

NetBackup Status Code: 161

Message: Evaluation software has expired. See www.veritas.com for ordering information

Explanation: The time allowed for the NetBackup evaluation software has ended.

Recommended Action: Obtain a licensed copy of NetBackup.

NetBackup Status Code: 162

Message: incorrect server platform for license

Explanation: The platform identifier in the license key does not match the platform type on which the key was installed.

Recommended Action: Ensure that you are using a license key that was intended for the platform on which you are installing.

NetBackup Status Code: 163

Message: media block size changed prior to resume

Explanation: Status code 163 is an informational message indicating that the media block size changed prior to resuming a backup job from the last checkpoint. Since the media block size must be consistent, the job was restarted from the beginning.

Recommended Action: Check the Activity Monitor job details for the job ID of the restarted job.

NetBackup Status Code: 164

Message: unable to mount media because it is in a DOWN drive, misplaced, or otherwise not available

Explanation: A restore was attempted and the volume required for the restore was in a DOWN drive in a robot. Or, the slot that should contain the volume is empty.

Recommended Action:

- ◆ If volume is in a DOWN drive, remove it and place it in its designated slot. Then, retry the restore.
- ◆ If the volume is in the wrong slot, use a robot inventory option to reconcile the contents of the robot with the Media Manager volume configuration.

NetBackup Status Code: 165

Message: NB image database contains no image fragments for requested backup id/copy number

Explanation: A restore was attempted and NetBackup has no record of fragments associated with the backup ID that has the files.

Recommended Action: Check the NetBackup Problems report for additional information about the error. For detailed troubleshooting information, create a debug log directory for either `bpdm` or `bptm` (whichever applies) and retry the operation. Check the resulting debug log.

NetBackup Status Code: 166

Message: backups are not allowed to span media

Explanation: An end of media (EOM) was encountered while the backup image was being written. The backup was terminated because the NetBackup `DISALLOW_BACKUPS_SPANNING_MEDIA` option was present in `bp.conf` (on UNIX) or in the registry (on Windows). The backup will be retried automatically with a different volume if this is allowed by the backup tries attribute in the NetBackup global attribute configuration.

Recommended Action: None.

NetBackup Status Code: 167

Message: cannot find requested volume pool in Media Manager volume database

Explanation: A backup to a nonrobotic drive was attempted and the tape manager (`bptm`) could not find or add the specified volume pool.

Recommended Action: Verify the Media Manager volume configuration. Check the NetBackup Problems report for more information about the error. For detailed troubleshooting information, create a `bptm` debug log directory and retry the operation. Check the resulting debug log.

NetBackup Status Code: 168

Message: cannot overwrite media, data on it is protected

Explanation: A catalog backup was attempted to a volume that could not be overwritten because it contains data that NetBackup, by default, does not overwrite (tar, cpio, ANSI, and so on).

Recommended Action: Replace the volume with a new one or set the NetBackup `ALLOW_MEDIA_OVERWRITE` option to the appropriate value.



NetBackup Status Code: 169

Message: media id is either expired or will exceed maximum mounts

Explanation: A backup or catalog backup was attempted and the volume selected for use has reached its maximum number of mounts as specified in the Media Manager volume configuration. For a regular backup, the volume is automatically set to the SUSPENDED state and not used for further backups. For a NetBackup catalog backup, the operation terminates abnormally.

Recommended Action: If the volume was suspended, wait until it expires and then replace it. For NetBackup catalog backups, replace the media.

NetBackup Status Code: 170

Message: third party copy backup failure

Explanation: Usually indicates a problem with the `3pc.conf` file or the `mover.conf` file. (For detailed causes, see recommended actions.) For more information on these files, refer to the SAN Configuration chapter of the *NetBackup Advanced Client System Administrator's Guide*.

Recommended Action:

- ◆ If a *non* third-party copy device is listed in `3pc.conf` file, correct or remove the non third-party copy device entry.
- ◆ If an incorrect `lun` is specified in the `3pc.conf` file, or the device does not exist, correct the `3pc.conf` file as appropriate.
- ◆ If an appropriate `mover.conf` file (with or without file-name extension) could not be found, the `/usr/opensv/netbackup/logs/bptm` log may show the following:

```
09:51:04 [22281] <2> setup_mover_tpc: no mover.conf.vertex_std_tpc
or mover.conf file exists, cannot perform TPC backup
09:51:04 [22281] <16> bptm: unable to find or communicate with
Third-Party-Copy mover for policy vertex_std_tpc
```

Make sure that an appropriate `mover.conf` file exists in `/usr/opensv/netbackup` on the media server. This file can be any of the following:

- ◆ `mover.conf` .*policy_name* file, where *policy_name* exactly matches the name of the policy.
- ◆ `mover.conf` .*storage_unit_name*, where *storage_unit_name* exactly matches the name of the storage unit selected in the Backup Policy Management Policy attributes dialog (such as `nut-4mm-robot-t14-0`).
- ◆ `mover.conf` file (no extension) for configurations that have only one third-party copy device.

Note that NetBackup looks for an appropriate `mover.conf` file in the above order.

- ◆ If the SCSI pass-through path of the third-party copy device, as entered in the `mover.conf` file (with or without file-name extension), does not exist, the `/usr/opensv/netbackup/logs/bptm` log may show the following:

```
09:50:12 [22159] <16> setup_mover_tpc: open of passthru path
/dev/sg/cXtXlX failed, No such file or directory
09:50:12 [22159] <16> bptm: unable to find or communicate with
Third-Party-Copy mover for policy vertex_std_tpc
```

Correct the SCSI pass-through path of the third-party copy device that is entered in the `mover.conf` file.

- ◆ If the third-party copy device returned an error, you may see either of the following messages in `/usr/opensv/netbackup/logs/bptm` log:

```
cannot process extended copy error due to truncated
sense data, may be HBA problem
```

```
disk error occurred on extended copy command, key = 0x0,
asc = 0x0, ascq = 0x0      (where key, asc and ascq are all zero)
```

your host-bus adapter (HBA) and its driver may need to be updated, or may not be supported by NetBackup Advanced Client. The host-bus adapters supported in the release are listed in the *NetBackup Release Notes*.

NetBackup Status Code: 171

Message: media id must be 6 or less characters

Explanation: An operation, such as using `bpmedia` to suspend or freeze a media ID, was attempted and the media ID specified was longer than six alpha-numeric characters.

Recommended Action: Retry the command with a valid media ID.

NetBackup Status Code: 172

Message: cannot read media header, may not be NetBackup media or is corrupted

Explanation: When loading a volume for a backup or restore, the tape manager (`bptm`), did not find the expected tape header. This can mean that a volume in a robotic device is not in the slot number shown in the Media Manager volume configuration or that a read error (I/O error) occurred.

Recommended Action:



1. If the volume is in a robot that supports barcodes, verify the robot contents by using a Media Manager robot inventory option.
2. If the volume was mounted on a nonrobotic drive, verify that the correct volume was mounted and assigned.
3. Check the NetBackup Problems report. If a fatal read error occurred, attempt the operation again using another drive, if possible.
4. If your configuration has multiple servers / HBAs with access to your tape services (most likely, an SSO configuration), make sure the SCSI Reserve / Release is configured correctly. For more information, refer to the *NetBackup SAN Shared Storage Option System Administrators Guide for UNIX and Windows*.

NetBackup Status Code: 173

Message: cannot read backup header, media may be corrupted

Explanation: When searching for a backup image to restore, the tape manager (bptm) could not find the correct backup ID at the position on the media where NetBackup expected it to be. This can indicate a drive hardware problem.

Recommended Action:

1. Check the NetBackup Problems report for clues as to what caused the error.
2. Try the restore on another drive if possible.
3. For detailed troubleshooting information, create a debug log directory for bptm and retry the operation. Check the resulting debug log.

NetBackup Status Code: 174

Message: media manager - system error occurred

Explanation: An abnormal condition occurred causing a tape manager (bptm) or disk manager (bpdm) failure. This should not occur under normal circumstances.

Note If this occurs on a Sequent platform and you are attempting to back up more than four gigabytes of data, save all your logs and call VERITAS technical support. For other platforms perform the recommended actions described below.

Recommended Action:

1. Check the NetBackup Problems report to see if it shows the cause of the problem. If you see a Problems report message similar to

```
"attempted to write 32767 bytes, not a multiple of 512"
```

save all logs and call VERITAS customer support.

2. On UNIX, if this occurs during a restore, it may be that the tape drive is incorrectly configured to write in fixed length mode when it should write in variable length mode.

Verify your drive's configuration, comparing it to what is recommended in the *Media Manager Device Configuration Guide* (also see [step 7](#) of this procedure).

If your configuration incorrectly specifies fixed length mode, change the configuration to specify variable length mode and suspend media that were written on that device. The images written to those media may be restorable (this is platform dependent), but single file restores are almost guaranteed to fail.

3. If you see the problem with only one client, verify that the client binaries are correct, especially those for `bpcd`.

4. Can you read or write any other images on this media?

If so, check the following reports for clues:

- ◆ Images on Media report
- ◆ Media Contents report

5. Verify the following:

- ◆ The media by using the NetBackup image verify option.
- ◆ That you are using the correct media type for the device.

6. Check the system or console log for errors (on UNIX) or the Event Viewer Application log (on Windows).

7. For detailed debug information, create a debug log directory for either `bptm` or `bpdm` (whichever applies) and retry the operation. Check the resulting debug log.

On UNIX systems, if the `bptm` debug log shows an error similar to

```
00:58:54 [2304] <16> write_data: write of 32768 bytes  
indicated only 29696 bytes were written, errno = 0
```

it may be that the tape drive is configured to write in fixed length mode rather than variable length mode, and the image being written encountered the end-of-media.

Take the corrective action suggested in [step 2](#).



NetBackup Status Code: 175

Message: not all requested files were restored

Explanation: When restoring files from an image, the `bptm` or `bpdm` process detected a fatal error condition and terminated the restore before it completed. This should not occur under normal circumstances.

Recommended Action:

1. Check the NetBackup Problems report and the status or progress log on the client for additional information about the error
2. For detailed troubleshooting information, create a debug log directory for either `bptm` or `bpdm` (whichever applies) and retry the operation. Check the resulting debug log.

NetBackup Status Code: 176

Message: cannot perform specified media import operation

Explanation: The tape manager (`bptm`) detected an error condition when attempting to import a specific backup image. Possible reasons for this are:

- ◆ Media ID is already active in the NetBackup media catalog on this server
- ◆ Media ID is not in the Media Manager volume configuration
- ◆ Fatal tape manager (`bptm`) error occurred
- ◆ Total image was not obtained from Phase 1 of import

Recommended Action:

1. Check the NetBackup Problems report to find the exact cause of the failure.
2. Try the following:
 - ◆ If the media ID is already active, duplicate all images on the original media ID to another volume. Then, manually expire the original media and redo the import.
 - ◆ If the media ID is not present in the Media Manager volume configuration, add it.
 - ◆ If a fatal `bptm` error occurred, verify that the Media Manager volume daemon (`vmc`) is active on UNIX or that the NetBackup Volume Manager service is active on Windows.
 - ◆ If the entire image is not present, perform import phase 1 on the media IDs that have the remainder of the image.

NetBackup Status Code: 177

Message: could not deassign media due to Media Manager error

Explanation: The tape manager (`bptm`) could not successfully deassign a media ID.

Recommended Action:

1. Check the NetBackup Problems report for the cause of the problem.
2. Verify that the Media Manager volume daemon (`vmᄁ`) is active on UNIX or the NetBackup Volume Manager service is active on Windows.
3. For detailed troubleshooting information, create a debug log directory for `bptm` and retry the operation. Check the resulting debug log.

NetBackup Status Code: 178

Message: media id is not in NetBackup volume pool

Explanation: NetBackup attempted a backup of its catalogs and the media ID specified for the catalog backup was not in the NetBackup volume pool. Volumes for catalog backups must be in the NetBackup volume pool.

Recommended Action: Check the Media Manager volume configuration to verify that the media IDs are present and in the NetBackup volume pool.

NetBackup Status Code: 179

Message: density is incorrect for the media id

Explanation: An operation such as “list contents” was attempted on an invalid media ID, such as a cleaning tape. Another possibility is that a media ID in the NetBackup catalog backup configuration does not match the media type entered in the Media Manager volume configuration.

Recommended Action: Check the volume configuration and the NetBackup catalog backup configuration and correct any problems found.

NetBackup Status Code: 180

Message: tar was successful

Explanation: `tar` returned a successful exit status.

Recommended Action: None.



NetBackup Status Code: 181

Message: tar received an invalid argument

Explanation: One of the parameters passed to tar was not valid.

Recommended Action:

- ◆ On a UNIX client:
 - ◆ Ensure that the tar command in /usr/opensv/netbackup/bin is the one provided by NetBackup. If you are in doubt, reinstall it.
 - ◆ Check /usr/opensv/netbackup/bin/version on the client to verify that the client is running the correct level software. If the software is not at the correct level, update the software per the directions in the NetBackup release notes.
- ◆ On a Windows client, create a tar debug log directory, retry the operation, and check the log.
- ◆ On a Macintosh client, check the version file that is in the bin folder in the NetBackup folder in the Preferences folder. If the software is not at the correct level, install the correct software as explained in the *NetBackup Installation Guide for UNIX*.

NetBackup Status Code: 182

Message: tar received an invalid file name

Explanation: tar cannot write to the file that is specified with the -f parameter.

Recommended Action:

1. Create a bpcd debug log directory on the client (on a Macintosh NetBackup creates the log automatically).
2. On a Windows client, create a tar debug log directory.
3. Increase the logging level on the client:
 - ◆ On a UNIX client, add the VERBOSE option to the /usr/opensv/netbackup/bp.conf file.
 - ◆ On PC clients, increase the debug or log level as explained in the debug log topics in Chapter 3.
4. Rerun the operation, check the resulting debug logs for the parameters passed to tar and call customer support.

NetBackup Status Code: 183

Message: tar received an invalid archive



Explanation: The data passed to `tar` was corrupt.

Recommended Action:

- ◆ If the problem is with a UNIX client, create a `/usr/opensv/netbackup/logs/tar` debug log directory on the client and rerun the operation.
 - a. Check the `tar` debug log file for error messages that explain the problem.
 - b. Reboot the client to see if this clears the problem.
 - c. When you are through investigating the problem, delete the `/usr/opensv/netbackup/logs/tar` directory on the client.
- ◆ If the problem is with a Microsoft Windows, NetWare, or Macintosh client:
 - a. Create a `bpcd` debug log directory on the client (on a Macintosh NetBackup creates the log automatically).
 - b. On a Windows client, create a `tar` debug log directory.
 - c. Increase the debug or log level as explained in the debug log topics in Chapter 3.
 - d. Rerun the operation and check the resulting debug logs.
 - e. Reboot the client to see if it clears the problem.

NetBackup Status Code: 184

Message: `tar` had an unexpected error

Explanation: A system error occurred in `tar`.

Recommended Action:

- ◆ If the problem is with a UNIX client, create a `/usr/opensv/netbackup/logs/tar` debug log directory on the client and rerun the operation.
 - a. Check the `tar` debug log file for error messages that explain the problem.
 - b. Reboot the client to see if this clears the problem.
 - c. When you are through investigating the problem, delete the `/usr/opensv/netbackup/logs/tar` directory on the client.
- ◆ If the problem is with a Microsoft Windows, NetWare, or Macintosh client:



- a. Create a `bpcd` debug log directory on the client (on a Macintosh NetBackup creates the log automatically).
- b. Increase the debug or log level as explained in the debug log topics in Chapter 3.
- c. On a Windows client, create a `tar` debug log directory.
- d. Retry the operation and check the resulting debug logs.
- e. Reboot the client to see if it clears the problem.

NetBackup Status Code: 185

Message: tar did not find all the files to be restored

Explanation: There were files in the `tar` file list that were not in the image.

Recommended Action:

- ◆ If the problem is with a UNIX client:
 - a. Enable `bpcd` debug logging by creating the `/usr/opensv/netbackup/logs/bpcd` directory on the client.
 - b. Rerun the operation, check the resulting `bpcd` log file for the parameters passed to `tar`, and call customer support.
- ◆ If the problem is with a Microsoft Windows, NetWare, or Macintosh client:
 - a. Create a `bpcd` debug log directory on the client (on a Macintosh NetBackup creates the log automatically).
 - b. Increase the debug or log level as explained in the debug log topics in Chapter 3.
 - c. On a Windows client, create a `tar` debug log directory.
 - d. Retry the operation.
 - e. Check the resulting debug logs for the parameters passed to `tar` and call customer support.

NetBackup Status Code: 186

Message: tar received no data

Explanation: The media manager did not send data to `tar`.

Recommended Action:



1. Retry the operation and check the status or progress log on the client for error messages that reveal the problem.
2. Verify that the tape is available and readable.
3. Verify that the drive is in an UP state. Use the Device Monitor.
4. For detailed troubleshooting information:
 - a. Create a `bptm` debug log on the server.
 - b. On a Windows client, create a `tar` debug log.
 - c. Retry the operation and check the resulting debug logs.

NetBackup Status Code: 189

Message: the server is not allowed to write to the client's filesystems

Explanation: The client is not allowing writes from the server.

Recommended Action: Perform the following to perform restores or install software from the server.

- ◆ On a UNIX client, delete `DISALLOW_SERVER_FILE_WRITES` from the `/usr/opensv/netbackup/bp.conf` file.
- ◆ On a Microsoft Windows or NetWare nontarget client, select **Allow server-directed restores** on the **General** tab in the NetBackup Client Properties dialog box. To display this dialog box, start the Backup, Archive, and Restore interface on the client and select **NetBackup Client Properties** from the **File** menu.
- ◆ On a Macintosh client, delete `DISALLOW_SERVER_FILE_WRITES` from the `bp.conf` file in the NetBackup folder in the Preferences folder.
- ◆ On a NetWare target client, set `ALLOW_SERVER_WRITE` to `yes` in the `bp.ini` file.

NetBackup Status Code: 190

Message: found no images or media matching the selection criteria

Explanation: A verify, duplicate, or import was attempted and no images matching the search criteria were found in the NetBackup catalog.

Recommended Action: Change the search criteria and retry.

NetBackup Status Code: 191

Message: no images were successfully processed



Explanation: A verify, duplicate, or import was attempted and failed for all selected images.

Recommended Action:

- ◆ Check the NetBackup Problems report for the cause of the error. To obtain detailed troubleshooting information, create an `admin` debug log directory and retry the operation. Check the resulting debug log.
- ◆ If the error was encountered during duplication of backups, check the duplication progress log to help determine the root cause of the problem.
- ◆ If the error was encountered by a Vault job which is doing duplication, check the `duplicate.log` files in your `sidxxx` directories to help determine the root cause of the problem:

UNIX: `/usr/opensv/netbackup/vault/sessions/vault_name/sidxxx`

Windows: `install_path\NetBackup\vault\sessions\vault_name\sidxxx`

(where `xxx` is the session id)

NetBackup Status Code: 192

Message: VxSS authentication is required but not available

Explanation: The system on one side of a NetBackup network connection requires VxSS authentication. The system on the other side of the connection is not configured to use VxSS. VxSS authentication is used with the NetBackup Access Control feature (NBAC). The connection has been terminated because VxSS authentication cannot be completed.

Recommended Action: Make sure both systems are configured to use NetBackup Access Control VxSS authentication with each other, or make sure both systems are not configured to use VxSS with each other. The first thing to check is the Use VxSS Host properties value on each system. If one is configured for REQUIRED, the other must be configured for REQUIRED or AUTOMATIC. If one is configured for PROHIBITED, the other must be configured for PROHIBITED or AUTOMATIC. Please see chapter 1 of the *VERITAS NetBackup System Administrator's Guide, Volume 2*, for information about setting the Access Control related host properties, and for information about configuring a system to use Access Control.

NetBackup Status Code: 193

Message: VxSS authentication is requested but not allowed

Explanation: The system on one side of a NetBackup network connection requires VxSS authentication. The system on the other side of the connection is not configured to use VxSS. VxSS authentication is used with the NetBackup Access Control feature (NBAC). The connection has been terminated because VxSS authentication cannot be completed.

Recommended Action: Make sure both systems are configured to use NetBackup Access Control VxSS authentication with each other, or make sure both systems are not configured to use VxSS with each other. The first thing to check is the Use VxSS Host properties value on each system. If one is configured for REQUIRED, the other must be configured for REQUIRED or AUTOMATIC. If one is configured for PROHIBITED, the other must be configured for PROHIBITED or AUTOMATIC. Please see chapter 1 of the *VERITAS NetBackup System Administrator's Guide, Volume 2*, for information about setting the Access Control related host properties, and for information about configuring a system to use Access Control.

NetBackup Status Code: 194

Message: the maximum number of jobs per client is set to 0

Explanation: The NetBackup **Maximum jobs per client** global attribute is currently set to 0. Setting the value to 0 disables backups and archives.

Recommended Action: To enable backups and archives, change the **Maximum jobs per client** value to the desired nonzero setting. This attribute is on the **Global NetBackup Attributes** tab in the Master Server Properties dialog box. See [“Using the Host Properties Window”](#) on page 54.

NetBackup Status Code: 195

Message: client backup was not attempted

Explanation: A backup job was in the NetBackup scheduler's worklist but was not attempted.

Recommended Action:

1. Retry the backup either immediately with a manual backup or allow the normal scheduler retries.
2. For additional information, check the All Log Entries report. For detailed troubleshooting information, create a `bpsched` debug log directory on the master server. After the next backup attempt, check the debug log.

Some actions to perform are:

- ◆ Verify that the `vmd` and `ltd` daemons (UNIX) or the NetBackup Volume Manager and NetBackup Device Manager services (Windows) are running.
- ◆ Look for a problem in an earlier backup that made the media or storage unit unavailable.



NetBackup Status Code: 196

Message: client backup was not attempted because backup window closed

Explanation: A backup or archive operation that was queued by the backup scheduler was not attempted because the backup window was no longer open.

Recommended Action:

- ◆ If possible, change the schedule to extend the backup window for this policy and schedule combination so it does not occur again.
- ◆ If the backup must be run, use the **Manual Backup** command on the **Policy** menu in the Backup Policy Management window to perform the backup. Manual backups ignore the backup window.

NetBackup Status Code: 197

Message: the specified schedule does not exist in the specified policy

Explanation: A user backup or archive request has specified the exact policy and schedule to use when performing a backup. The policy exists but does not contain the schedule.

- ◆ On Microsoft Windows and NetWare nontarget clients, you can specify a policy or schedule on the **Backups** tab in the NetBackup Client Properties dialog box. To display this dialog box, start the Backup, Archive, and Restore interface on the client and select **NetBackup Client Properties** from the **File** menu.
- ◆ On UNIX and Macintosh clients, you can specify a policy or schedule by using the `bp.conf` options, `BPBACKUP_POLICY` or `BPBACKUP_SCHED`.
- ◆ On NetWare target clients, you can specify a policy or schedule in the `bp.ini` file.

Recommended Action:

1. Check the client progress log (if available) to determine the policy and schedule that were specified.
2. Check the configuration on the master server to determine if the schedule is valid for the policy. If the schedule is not valid, either add the schedule to the policy configuration or specify a valid schedule on the client.

NetBackup Status Code: 198

Message: no active policies contain schedules of the requested type for this client

Explanation: A user backup or archive has been requested, and this client is not in a policy that has a user backup or archive schedule.

Recommended Action: Determine if the client is in any policy that has a schedule of the appropriate type (either user backup or archive).

- ◆ If the client is in such a policy, check the general policy attributes to verify that the policy is set to active.
- ◆ If the client is not in such a policy, either add a schedule of the appropriate type to an existing policy that has this client or create a new policy that has this client and a schedule of the appropriate type.
- ◆ Run the NetBackup Configuration Validation Utility (NCVU) `-conf <media server option>` on the master server. Note the policy checks in section five.

NetBackup Status Code: 199

Message: operation not allowed during this time period

Explanation: A user backup or archive has been requested and this client is not in a policy that has a user backup or archive schedule with an open backup window. This error implies that there is an appropriate policy and schedule combination for this client.

Recommended Action: Determine the policies to which this client belongs that also have a schedule of the appropriate type (either user backup or archive).

- ◆ If possible, retry the operation when the backup window is open.
- ◆ If the backup window is not open during appropriate time periods, adjust a backup window for a schedule in one of the policies.

NetBackup Status Code: 200

Message: scheduler found no backups due to run

Explanation: When checking the policy and schedule configuration, the NetBackup scheduler process (`bpsched`) did not find any clients to back up. This could be due to:

- ◆ No backup time windows are open (applies only to full and incremental schedules).
- ◆ Policies are set to inactive.
- ◆ The clients were recently backed up and are not due for another backup (based on Frequency setting for the schedules).
- ◆ Policies do not have any clients.

Recommended Action: Usually, this message can be considered informational and does not indicate a problem. However, if you suspect a problem:

1. Examine the NetBackup All Log Entries report to see if there are any messages in addition to one indicating that the scheduler found nothing to do.
2. Examine the policy configuration for all policies or the specific policy in question and determine if any of the reasons mentioned in the Explanation section above apply.



3. To obtain detailed troubleshooting information, create a `bpsched` debug log directory on the master server and retry the operation. Check the resulting debug log.

NetBackup Status Code: 201

Message: handshaking failed with server backup restore manager

Explanation: A process on the master server encountered an error when communicating with the media host (can be either the master or a media server). This error means that the master and media server processes were able to initiate communication, but encountered difficulties in completing them. This problem can occur during a backup, restore, or media list in a single or multiple server configuration.

Recommended Action:

1. Determine the activity that encountered the handshake failure by examining the NetBackup All Log Entries report for the appropriate time period. If there are media servers, determine if:
 - ◆ The handshake failure was encountered between the master and a media server.
or
 - ◆ Only the master server was involved.
2. If necessary, create the following debug log directories for the following:
 - ◆ `bpcd` on the NetBackup media host (can be either the master or a media server).
 - ◆ If the error was encountered during a backup operation, `bpsched` on the master server.
 - ◆ If the error was encountered during a restore operation, `bprd` on the master server.
 - ◆ If the error was encountered during a media list operation, `admin` in the NetBackup `logs/admin` directory on the master server.
3. Retry the operation and examine the resulting debug logs for information on why the error occurred.

NetBackup Status Code: 202

Message: timed out connecting to server backup restore manager

Explanation: A process on the master server timed out while trying to initiate communications with the media host (can be either the master or a media server). This problem can occur during a backup or restore in either a single or multiple server configuration.

Recommended Action: Determine which activity encountered the connection timeout failure by examining the All Log Entries report for the appropriate time period. If there are media servers, determine if the timeout occurred between the master and a media server or if only the master was involved.

1. Verify that the schedule specifies the correct storage unit.
2. Execute the `ping` command from one host to another by using the following combinations:
 - ◆ From the master server, ping the master and all media servers by using the host names found in the storage unit configuration.
 - ◆ From each of the media servers, ping the master server by using the host name specified in the NetBackup server list. On a UNIX server, this is the first `SERVER` entry in the `bp.conf` file. On a Windows server, the master is designated on the **Servers** tab in the Master Server Properties dialog. To access this dialog, see [“Using the Host Properties Window”](#) on page 54.

3. Verify that the master server can communicate with `bpcd` on the host that has the storage unit.

After each backup, the scheduler checks the storage unit to see how many drives are available (in case the backup caused a drive to be automatically downed). If `bpsched` cannot communicate with `bpcd`, it sets the number of available drives in that storage unit to 0 and further backups to that storage unit fail.

The available drives remain at 0 until the scheduler is initialized again. Therefore, even if `bpcd` seems to be operating correctly now, check the `bpsched` and `bpcd` debug logs (see below) for records of an earlier failure.

4. See [“Testing Media Server and Clients”](#) on page 24 and [“Resolving Network Communication Problems”](#) on page 26.
5. If necessary, create debug log directories for the following processes and retry the operation. Then, check the resulting debug logs on the master server:
 - ◆ If the error occurred during a backup operation, check the `bpsched` debug logs. Also, check the `bpcd` debug logs.
 - ◆ If the error occurred during a restore operation, check the `bprd` debug logs.

NetBackup Status Code: 203

Message: server backup restore manager’s network is unreachable



Explanation: A process on the master server could not connect to a particular host on the network when trying to initiate communication with the media host for a particular operation. This problem can occur during a backup or restore in either a single or multiple server configuration.

Recommended Action: Determine which activity encountered the network unreachable failure by examining the All Log Entries report for the appropriate time frame. If there is more than one NetBackup server (that is, one or more media servers) determine if the network unreachable failure was encountered between the master and a media server or if only the master server was involved. Execute the `ping` command from one host to another by using the following combinations:

1. From the master server, ping the master and all media servers by using the host names in the storage unit configuration.
2. From each of the media servers, ping the master server host by using the host name specified in the NetBackup server list. On a UNIX server, this is the first `SERVER` entry in the `bp.conf` file. On a Windows server, the master is designated on the **Servers** tab in the Master Server Properties dialog. To access this dialog, see [“Using the Host Properties Window”](#) on page 54.
3. See [“Testing Media Server and Clients”](#) on page 24 and [“Resolving Network Communication Problems”](#) on page 26.
4. If necessary, create debug log directories for the following processes and retry the operation. Then, check the resulting debug logs on the master server:
 - ◆ If the error occurred during a backup, check the `bpsched` debug logs.
 - ◆ If the error occurred during a restore, check the `bprd` debug logs.
5. Run the NetBackup Configuration Validation Utility (NCVU) `-conf <media server option>` on the master server for the associated NetBackup media servers. Note the media server host name checks in sections four and seven.

NetBackup Status Code: 204

Message: connection refused by server backup restore manager

Explanation: The media host refused a connection on the port number for `bpcd`. This error can be encountered during a backup or restore.

Recommended Action: Execute the `ping` command from one host to another by using the following combinations:

Note Also, see [“Resolving Network Communication Problems”](#) on page 26.

1. From the master server, ping the master and all media servers by using the host names in the storage unit configuration.
2. From each of the media servers, ping the master server by using the name specified in the NetBackup server list. On a UNIX server, this is the first `SERVER` entry in the `bp.conf` file. On a Windows server, the master is designated on the **Servers** tab in the Master Server Properties dialog. To access this dialog, see [“Using the Host Properties Window”](#) on page 54.
3. On UNIX servers, verify that the `bpcd` entries in `/etc/services` or NIS on all the servers are identical. Verify that the media host is listening on the correct port for connections to `bpcd` by running one of the following commands (depending on platform and operating system):

```
netstat -a | grep bpcd
```

```
netstat -a | grep 13782 (or the value specified during the install)
```

```
rpcinfo -p | grep 13782 (or the value specified during the install)
```

On UNIX servers, you may have to change the service number for `bpcd` in `/etc/services` and the NIS services map and send `SIGHUP` signals to the `inetd` processes on the clients.

```
/bin/ps -ef | grep inetd
```

```
kill -HUP the_inetd_pid
```

or

```
/bin/ps -aux | grep inetd
```

```
kill -HUP the_inetd_pid
```

Note On a Hewlett-Packard UNIX platform, use `inetd -c` to send a `SIGHUP` to `inetd`.

4. On Windows servers:
 - a. Verify that the `bpcd` entries are correct in:

```
%SystemRoot%\system32\drivers\etc\services
```
 - b. Verify that the **NetBackup Client Service Port** number and **NetBackup Request Service Port** number on the **Network** tab in the NetBackup Client Properties dialog match the settings in the `services` file. To display this dialog, start the Backup, Archive, and Restore interface and select **NetBackup Client Properties** from the **File** menu.

The values on the Network tab are written to the `services` file when the NetBackup Client service starts.



- c. Stop and restart the NetBackup services.
5. See [“Testing Media Server and Clients”](#) on page 24 and [“Resolving Network Communication Problems”](#) on page 26.
6. If necessary, create debug log directories for the following processes and retry the operation. Then, check the resulting debug logs on the master server:
 - ◆ If the error occurred during a backup operation, check the `bpsched` debug logs.
 - ◆ If the error occurred during a restore operation, check the `bprd` debug logs.
7. Run the NetBackup Configuration Validation Utility (NCVU) `-conf <media server option>` on the master server for the associated NetBackup media servers. Note the NetBackup services, ports, and `bpcd` checks in section one, the media server hostname and ping checks in sections four and seven.

NetBackup Status Code: 205

Message: cannot connect to server backup restore manager

Explanation: A process on the master server could not connect to a process on a host on the network while trying to initiate communication with the server that has the storage unit for a particular operation. This problem can occur during a backup or restore in either a single or multiple server configuration. This can also occur when the scheduler process (`bpsched`) is building its list of available storage units to use during backups.

Recommended Action: Execute the `ping` command from one host to another by using the following combinations:

Note Also, see [“Resolving Network Communication Problems”](#) on page 26.

1. From the master server, ping the master and all media servers by using the host names in the storage unit configuration.
2. From each of the media servers, ping the master server by using the name specified in the NetBackup server list. On a UNIX server, this is the first `SERVER` entry in the `bp.conf` file. On a Windows server, the master is designated on the **Servers** tab in the Master Server Properties dialog. To access this dialog, see [“Using the Host Properties Window”](#) on page 54.
3. On a UNIX server, verify that the `bpcd` entry in `/etc/services` or NIS on all the servers are identical. Verify that the media host is listening on the correct port for connections to `bpcd` by running one of the following commands (depending on platform and operating system):

```
netstat -a | grep bpcd
```



```
netstat -a | grep 13782 (or the value specified during the install)
rpcinfo -p | grep 13782 (or the value specified during the install)
```

4. On Windows servers:
 - a. Verify that the `bpcd` entries are correct in the services file:

```
%SystemRoot%\system32\drivers\etc\services
```
 - b. Verify that the **NetBackup Client Service Port** number and **NetBackup Request Service Port** number on the **Network** tab in the NetBackup Client Properties dialog match the settings in the `services` file. To display this dialog, start the Backup, Archive, and Restore interface and select **NetBackup Client Properties** from the **File** menu.

The values on the Network tab are written to the `services` file when the NetBackup Client service starts.
 - c. Stop and restart the NetBackup services.
5. See [“Testing Media Server and Clients”](#) on page 24 and [“Resolving Network Communication Problems”](#) on page 26.
6. Create a `bpcd` debug log directory on the server that has the storage unit and retry the operation. Then, check for additional information in the resulting debug log.
7. Run the NetBackup Configuration Validation Utility (NCVU) `-conf <media server option>` on the master server for the associated NetBackup media servers. Note the NetBackup services, ports, and `bpcd` checks in section one, the media server hostname and ping checks in sections four and seven.

NetBackup Status Code: 206

Message: access to server backup restore manager denied

Explanation: The master server is trying to start a process on another server (or itself) and the master server does not appear in the NetBackup server list on that server. On a UNIX server, the master is the first `SERVER` entry in the `bp.conf` file. On a Windows server, the master is designated on the **Servers** tab in the Master Server Properties dialog. To access this dialog, see [“Using the Host Properties Window”](#) on page 54.

Recommended Action:



1. Verify that the master server appears as a server in its own server list as well as being listed on all media servers.

If you change the server list on a master server, stop and restart the NetBackup database manager and request daemons (UNIX) or the NetBackup Database Manager and NetBackup Request Manager services (Windows).

2. If necessary, create debug log directories for the following processes and retry the operation. Then, check the resulting debug logs on the master server:
 - ◆ If the error occurred during a backup operation, check the `bpsched` debug logs.
 - ◆ If the error occurred during a restore operation, check the `bprd` debug logs.

NetBackup Status Code: 207

Message: error obtaining date of last backup for client

Explanation: An error occurred when the backup scheduler (`bpsched`) tried to obtain the date of the last backup for a particular client, policy, and schedule combination.

Recommended Action:

1. Verify that the NetBackup database manager (`bpdbm`) process (on UNIX) or the NetBackup Database Manager service (on Windows) is running.
2. Examine the All Log Entries report for the appropriate time frame to gather more information about the failure.
3. For detailed troubleshooting information, create debug log directories for `bpsched` and `bpdbm` on the master server and retry the operation. Then, check the resulting debug logs.

NetBackup Status Code: 208

Message: failed reading user directed filelist

Explanation: An error occurred when the backup scheduler (`bpsched`) attempted to read the list of files requested for a user backup or archive. This error indicates either a client-server communication problem, or a system problem on the master server where the NetBackup scheduler process (`bpsched`) is running.

Recommended Action: For detailed troubleshooting information, create debug log directories for `bpsched` and `bprd` on the master server and retry the operation. Then, check the resulting debug logs.

NetBackup Status Code: 209

Message: error creating or getting message queue

Explanation: An error occurred when the backup scheduler (`bpsched`) attempted to create an internal message queue construct for interprocess communication. This error indicates a problem on the master server. On UNIX systems, this may be due to a lack of system resources for System V interprocess communication.

Recommended Action: Create a `bpsched` debug log directory on the master server and retry the operation. Then, determine the type of system failure by examining the error message in the `bpsched` debug log.

On UNIX servers, also gather the output of the `ipcs -a` command to see what system resources are currently in use.

NetBackup Status Code: 210

Message: error receiving information on message queue

Explanation: An error occurred when one of the backup scheduler (`bpsched`) processes attempted to receive a message from another `bpsched` process on an internal message queue construct. This error indicates a problem on the master server. On UNIX systems, this may be due to a lack of system resources for System V interprocess communication.

Recommended Action: Create a `bpsched` debug log directory on the master server and retry the operation. Then, determine the type of system failure by examining the error message in the `bpsched` debug log on the master server.

On UNIX servers, also gather the output of the `ipcs -a` command to see what system resources are currently in use.

NetBackup Status Code: 211

Message: scheduler child killed by signal

Explanation: A backup scheduler (`bpsched`) child process, which interacts with the backup restore manager (`bpbrm`) on the media host, was terminated. This can occur because of system administrator action.

Recommended Action: Create a debug log directory for `bpsched` on the master server and retry the operation. Then, to determine the cause of the child termination, examine the messages in the `bpsched` debug log.

NetBackup Status Code: 212

Message: error sending information on message queue



Explanation: The backup scheduler (`bpsched`) encountered an error when attempting to attach to an already existing internal message queue construct for interprocess communication. This error indicates a problem on the master server. On UNIX systems, this may be due to a lack of system resources for System V interprocess communication.

Recommended Action: Create a `bpsched` debug log directory on the master server and retry the operation. Then, determine the type of system failure by examining the error message in the `bpsched` debug log.

On a UNIX server, also, gather the output of the `ipcs -a` command to see what system resources are currently in use.

NetBackup Status Code: 213

Message: no storage units available for use

Explanation: The NetBackup scheduler process (`bpsched`) did not find any of its storage units available for use. Either all storage units are unavailable or all storage units are configured for **On demand only** and the policy and schedule does not require a specific storage unit.

Recommended Action:

1. Examine the Backup Status and All Log Entries report for the appropriate time period to determine the policy or schedule that received the error.
2. Verify that the storage unit's drives are not down or waiting for media from a previous operation that did not complete.
3. Verify that all the storage units do not have their **Maximum concurrent jobs** attribute set to 0 (for disk storage units) and **Maximum concurrent drives used for backup** attribute set to 0 (for Media Manager storage units).
4. Verify that the robot number and host name in the storage unit configuration matches the Media Manager device configuration.
5. Determine if all storage units are set to **On demand only** for a policy and schedule combination that does not require a specific storage unit. If this is the case, either specify a storage unit for the policy and schedule combination or turn off **On demand only** for a storage unit.
6. If the storage unit is on a UNIX NetBackup media server, it could indicate a problem with `bpcd`. Check `/etc/inetd.conf` on the media server to verify that the `bpcd` entry is ok.

If the storage unit is on a Windows NetBackup media server, verify that the NetBackup Client service has been started on the Windows NetBackup media server.

7. For detailed troubleshooting information, create a `bpsched` debug log directory on the master server and retry the operation. Then, check the resulting debug log.
8. Run the NetBackup Configuration Validation Utility (NCVU) `-conf <media server option>` on the master server for the associated NetBackup media servers. Note the storage unit and `tpconfig` checks in section five.

NetBackup Status Code: 214

Message: regular `bpsched` is already running

Explanation: The NetBackup scheduler (`bpsched`) performs periodic checking of the policy and schedule configuration to determine if there are new backups due. Error 214 indicates that when a new instance of NetBackup starts, it finds that a scheduler process is already checking the policy and schedule configuration.

Recommended Action: Usually, no action is required for this condition. However, *NEVER* kill `bpsched` before doing some checking. For example, `bpsched` could be calling `bpdbm` (NetBackup Database Manager service on Windows) to clean up and compress the catalogs.

- ◆ To determine what the running `bpsched` is currently doing, examine the `bpsched` debug log on the master server. If necessary, enable `bpsched` debug logging by creating a `bpsched` debug log directory on the master server and retrying the operation.
- ◆ To check for backups do the following:
 - On a UNIX master server:
 1. Check for active or queued backups by using the job monitor.
 2. Check for active `bp` processes with `bpsps`. This reveals if there are `bpbrm` or `bptm` processes running and a backup is active.
 3. If there is no reason for `bpsched` to be running, then use `kill -HUP` to terminate it.
 - On a Windows NetBackup master server:
 1. Check for active or queued backups by using the Activity monitor.
 2. Check for active NetBackup processes by using the Activity monitor. This reveals if there are `bpbrm` or `bptm` processes running and if a backup is active.
 3. If there is no reason for `bpsched` to be running, then kill it from the Activity monitor.



NetBackup Status Code: 215

Message: failed reading global config database information

Explanation: During the periodic checking of the NetBackup configuration, the NetBackup scheduler process (`bpsched`) was unable to read the global configuration parameters.

Recommended Action:

1. On a UNIX master server, verify that the NetBackup database manager (`bpdbm`) process is running. On a Windows master server, verify that the NetBackup Database Manager service is running.
2. Attempt to view the global configuration settings by using the NetBackup administration interface (on UNIX systems), or by using Host Properties (on Windows systems).
3. For detailed troubleshooting information, create debug log directories for `bpsched` and `bpdbm` on the master server and retry the operation. Then, check the resulting debug logs.

NetBackup Status Code: 216

Message: failed reading retention database information

Explanation: During its periodic checking of the NetBackup configuration, the NetBackup scheduler process (`bpsched`) could not read the list of retention levels and values.

Recommended Action:

1. On a UNIX master server, verify that the NetBackup database manager (`bpdbm`) process is running. On a Windows master server, verify that the NetBackup Database Manager service is running.
2. For detailed troubleshooting information, create debug log directories for `bpsched` and `bpdbm` on the master server and retry the operation. Then, check the resulting debug logs.

NetBackup Status Code: 217

Message: failed reading storage unit database information

Explanation: During its periodic checking of the NetBackup configuration, the NetBackup scheduler process (`bpsched`) could not read the storage unit configuration.

Recommended Action:



1. On a UNIX server, verify that the NetBackup database manager (`bpdbm`) process is running. On a Windows server, verify that the NetBackup Database Manager service is running.
2. Attempt to view the storage unit configuration by using the NetBackup administration interface.
3. For detailed troubleshooting information, create debug logs for `bpsched` and `bpdbm` on the master server and retry the operation. Then, check the resulting debug logs.
Ensure that the correct master server is being specified for the connection.
4. Run the NetBackup Configuration Validation Utility (NCVU) `-conf <media server option>` on the master server for the associated NetBackup media servers. Note the storage unit checks in section five.

NetBackup Status Code: 218

Message: failed reading policy database information

Explanation: During the periodic checking of the NetBackup configuration, the NetBackup scheduler process (`bpsched`) could not read the policy (backup policy) configuration.

Recommended Action:

1. On a UNIX server, verify that the NetBackup Database Manager (`bpdbm`) process is running. On a Windows server, verify that the NetBackup Database Manager service is running.
2. Attempt to view the policy configuration by using the NetBackup administration interface.
3. For detailed troubleshooting information, create debug log directories for `bpsched` and `bpdbm` on the master server and retry the operation. Then, check the resulting debug logs.
Ensure that the correct master server is being specified for the connection.

NetBackup Status Code: 219

Message: the required storage unit is unavailable

Explanation: The policy or schedule for the backup requires a specific storage unit, which is currently unavailable. This error also occurs for other attempts to use the storage unit within the current backup session.



Recommended Action: Look in the Job Details window for the failed job.

1. Verify that the schedule specifies the correct storage unit and the storage unit exists.
2. Verify that the Media Manager device daemon (`ltid`) is running (if the server is UNIX) or the NetBackup Device Manager service is running (if the server is a Windows system). Use `bps` on UNIX and the Activity Monitor on Windows or the Services application in the Windows Control Panel.
3. Verify that the **Maximum concurrent jobs** attribute is not set to 0 (for a disk storage unit) and the **Maximum concurrent drives** attribute is not set to 0 (for a Media Manager storage unit).
4. If the storage unit is a tape or optical disk, verify that at least one of the drives is in the UP state. Use the Device Monitor.
5. Verify that the robot number and host in the storage unit configuration matches what is specified in the Media Manager device configuration.
6. Verify that the master server can communicate with the `bpcd` process on the server that has the storage unit.

- a. Verify that `bpcd` is listening on the port for connections.

On a UNIX server, executing

```
netstat -a | grep bpcd
```

should return something similar to the following:

```
*.bpcd  *.*          0          0          0          0 LISTEN
```

Do this on the server where the storage unit is connected.

On a Windows NetBackup server, executing

```
netstat -a
```

prints out several lines of output. If `bpcd` is listening, one of those lines is similar to the following:

```
TCP    myhost:bpcd          0.0.0.0:0          LISTENING
```

Do this on the server where the storage unit is connected.

- b. If `bpcd` seems to be operating correctly, create `bpsched` and `bpcd` debug log directories and retry the operation. Check the resulting debug logs for records of an earlier failure.

After each backup, the scheduler checks the storage unit to see how many drives are available (in case the backup caused a drive to be automatically downed). If `bpsched` cannot communicate with `bpcd`, it sets the number of available drives in that storage unit to 0 and further backups to that storage unit during this backup session will fail.

The number of available drives remains at 0 until the scheduler is initialized again.

- c. If the cause of the problem is not obvious, perform some of the steps in [“Resolving Network Communication Problems”](#) on page 26.
7. Run the NetBackup Configuration Validation Utility (NCVU) `-conf <media server option>` on the master server for the associated NetBackup media servers. Note the policy, storage unit, and `tpconfig` checks in section five, and the `bpcd` checks in section one.

NetBackup Status Code: 220

Message: database system error

Explanation: The `bpdbm` process (on UNIX), or the NetBackup Database Manager service (on Windows) could not create a directory path for its configuration catalogs due to the failure of a system call. This is usually due to a permission problem or an “out of space” condition.

Recommended Action: Create a debug log directory for `bpdbm` and retry the operation. Check the resulting debug log for information.

NetBackup Status Code: 221

Message: continue

Explanation: This status code is used in coordinating communication between various NetBackup processes and normally does not occur. If the logs show that it is associated with a subsequent error, it usually indicates a communication problem. In this case, concentrate your troubleshooting efforts on the subsequent error.

Recommended Action: Determine the cause of the status code that follows this one.

NetBackup Status Code: 222

Message: done

Explanation: This status code is used in coordinating communication between various NetBackup processes and is normally not seen. If the error logs show that it is associated with a subsequent error, it usually indicates a communication problem. In this case, concentrate your troubleshooting efforts on the subsequent error.



Recommended Action: Determine the cause of the status code that follows this one.

NetBackup Status Code: 223

Message: an invalid entry was encountered

Explanation: A request to the `bpdbm` process (on UNIX) or the NetBackup Database Manager service (on Windows) had invalid or conflicting information. This is usually a result of using software from different versions together, but can also be caused by incorrect parameters on a command.

Recommended Action: Verify that all NetBackup software is at the same version level and the command parameters are specified correctly. If neither of these is the problem, obtain detailed troubleshooting information by creating a `bpdbm` debug log directory and retrying the operation. Check the resulting debug log.

NetBackup Status Code: 224

Message: there was a conflicting specification

Explanation: A request to the `bpdbm` process (on UNIX) or the NetBackup Database Manager service (on Windows) had conflicting information. This is usually a result of using software from different version levels together.

Recommended Action: Verify that all NetBackup software is at the same version level. If that is not the problem, obtain detailed troubleshooting information by creating `bpdbm` and `admin` debug log directories and retrying the operation. Check the resulting debug logs.

NetBackup Status Code: 225

Message: text exceeded allowed length

Explanation: A request containing text that exceeds a buffer size was made to the `bpdbm` process (on UNIX), or the NetBackup Database Manager service (on Windows). This is usually a result of using software from different version levels together.

Recommended Action: Verify that all NetBackup software is at the same version level. If that is not the problem, create debug log directories for `bpdbm` and `admin`. Then, retry the operation and examine the resulting debug logs.

NetBackup Status Code: 226

Message: the entity already exists

Explanation: The configuration already has an entity with the same name or definition. For example, you see this status if you try to add a new policy when an existing policy has the same name or definition (attributes, clients, and so on).

Recommended Action: Correct your request and re-execute the command.

NetBackup Status Code: 227

Message: no entity was found

Explanation: The item requested was not in the catalog. For example, the entity could be a file or policy information.

Recommended Action: A common cause for this problem is a query that has no matching images. Specify different parameters or options for the operation and try it again.

NetBackup Status Code: 228

Message: unable to process request

Explanation: An inconsistency exists in the catalog or a request was made that would be improper to satisfy.

Recommended Action:

1. If this involves a media server, verify that its server list specifies the correct master server. On a UNIX server, the master server is the first `SERVER` entry in the `bp.conf` file. On a Windows server, the master is designated on the **Servers** tab in the Master Server Properties dialog. To access this dialog, see [“Using the Host Properties Window”](#) on page 54.
2. For detailed troubleshooting information, create a `bpdbm` debug log directory and retry the operation. Then, check the resulting debug log.

NetBackup Status Code: 229

Message: events out of sequence - image inconsistency

Explanation: A request was made which, if satisfied, would cause the image catalog to become inconsistent.

Recommended Action: Obtain detailed troubleshooting information by creating a debug log directory for `bpdbm`. Then, retry the operation, save the resulting debug log, and call customer support.

NetBackup Status Code: 230

Message: the specified policy does not exist in the configuration database

Explanation: The specified policy name does not exist.

Recommended Action: Correct your parameters or options and retry the operation.



Run the NetBackup Configuration Validation Utility (NCVU) `-conf <media server option>` on the master server for the associated NetBackup media servers. Note the policy checks in section five.

NetBackup Status Code: 231

Message: schedule windows overlap

Explanation: The start and duration times specified for one day of the schedule overlap with another day of the schedule.

Recommended Action: Correct the schedule to eliminate the overlapping backup windows.

NetBackup Status Code: 232

Message: a protocol error has occurred

Explanation: This is an intermediate status code that usually precedes another status code. It indicates that either the `bpdbm` process (on UNIX) or the NetBackup Database Manager service (on Windows) or the process communicating with it has received unexpected information.

Recommended Action: Create a debug log directory for `bpdbm`. Then, retry the operation, save the debug log, and call customer support.

NetBackup Status Code: 233

Message: premature eof encountered

Explanation: This is an intermediate status code that usually precedes another status code and is associated with a problem in network communication.

Recommended Action: During a restore, this means that `tar` (on the client) received a stream of data that was not what it expected. If this is a new configuration, verify that the tape drive is configured for variable mode (see the *Media Manager Device Configuration Guide*).

If the communication failure is not due to an interrupt on a client system, save all error information and call customer support.

NetBackup Status Code: 234

Message: communication interrupted

Explanation: This is an intermediate status code that usually precedes another status code and is associated with a problem in network communication. A process, either server or client, received an interrupt signal.

Recommended Action: Save all error information and call customer support.

NetBackup Status Code: 235

Message: inadequate buffer space

Explanation: This code usually indicates a mismatch between server and client software versions.

Recommended Action:

1. Verify that all NetBackup software is at the same version level. Update earlier versions of NetBackup software.
 - ◆ On UNIX NetBackup servers and clients, check the `/usr/opensv/netbackup/bin/version` file.
 - ◆ On Windows NetBackup servers, check the `install_path\NetBackup\version.txt` file or the **About NetBackup** item on the **Help** menu.
 - ◆ On Microsoft Windows clients, check the **About NetBackup** item on the **Help** menu.
 - ◆ On NetWare target clients, check the Version entry in the `bp.ini` file.
If the client software is earlier than 3.0, verify that the client is in a Standard type policy.
 - ◆ On Macintosh clients, check the version file in the `bin` folder in the NetBackup folder in the `Preferences` folder.
2. If the problem persists, save all error information and call customer support.

NetBackup Status Code: 236

Message: the specified client does not exist in an active policy within the configuration database

Explanation: A client name was not specified or the specified client does not exist.

Recommended Action: Activate the required policy, correct the client name, or add the client to a policy that meets your needs. After making the correction, retry the operation.

Run the NetBackup Configuration Validation Utility (NCVU) `-conf <media server option>` on the master server for the associated NetBackup media servers. Note the policy checks in section five.



NetBackup Status Code: 237

Message: the specified schedule does not exist in an active policy in the configuration database

Explanation: The specified schedule does not exist in the NetBackup configuration.

Recommended Action: Activate the required policy, correct the schedule name, or create a schedule in a policy that meets your needs. After making the correction, retry the operation.

Run the NetBackup Configuration Validation Utility (NCVU) `-conf <media server option>` on the master server for the associated NetBackup media servers. Note the policy checks in section five.

NetBackup Status Code: 238

Message: the database contains conflicting or erroneous entries

Explanation: The catalog has an inconsistent or corrupted entry.

Recommended Action: Obtain detailed troubleshooting information for `bpdbm` (on UNIX) or the NetBackup Database Manager service (on Windows) by creating a debug log directory for it. Then, retry the operation, save resulting debug log, and call customer support.

NetBackup Status Code: 239

Message: the specified client does not exist in the specified policy

Explanation: The specified client is not a member of the specified policy.

Recommended Action: Correct the client name specification, specify a different policy, or add the required client name to the policy. After making the correction, retry the operation.

Run the NetBackup Configuration Validation Utility (NCVU) `-conf <media server option>` on the master server for the associated NetBackup media servers. Note the policy checks in section five.

NetBackup Status Code: 240

Message: no schedules of the correct type exist in this policy

Explanation: The appropriate schedule was not found in the specified policy. For example, a user backup specified a policy name but no user backup schedule exists in that policy.

Recommended Action: Specify a different policy or create a schedule of the needed type in the policy. After making the correction, retry the operation.

NetBackup Status Code: 241

Message: the specified schedule is the wrong type for this request

Explanation: The schedule that was specified for an immediate manual backup is not for a full nor an incremental backup. It must be one of these.

Recommended Action: Specify only full or incremental schedules for manual backups. If one does not exist in the policy, create one.

NetBackup Status Code: 242

Message: operation would cause an illegal duplication

Explanation: Processing the request would cause a duplicate catalog entry. This is usually due to a mistake in specifying media IDs for NetBackup catalog backups.

Recommended Action: Check the error reports to determine the specific duplication that would occur. Correct the settings for the operation and retry it.

NetBackup Status Code: 243

Message: the client is not in the configuration

Explanation: The specified client name was not in the catalog.

Recommended Action: Either correct the client name or add the client to the desired policy.

Run the NetBackup Configuration Validation Utility (NCVU) `-conf <client option>` on the master server for the associated clients. Note the policy checks in section four.

NetBackup Status Code: 244

Message: main bpsched is already running

Explanation: A `bpsched` process tried to become the main backup scheduler but another process is currently in this mode.

Recommended Action: None.

NetBackup Status Code: 245

Message: the specified policy is not of the correct client type

Explanation: A user backup specified a policy that is not the type required for the client.

Recommended Action: Retry the operation by specifying a policy that is the correct type for the client. If such a policy does not exist, create one.



NetBackup Status Code: 246

Message: no active policies in the configuration database are of the correct client type

Explanation: A user backup request was not satisfied because no active policies were the type required for the client.

Recommended Action: Create or activate an appropriate policy so the user backup request can be satisfied.

NetBackup Status Code: 247

Message: the specified policy is not active

Explanation: Backups for the specified policy are disabled because the policy is inactive.

Recommended Action: Activate the policy and retry the operation.

NetBackup Status Code: 248

Message: there are no active policies in the configuration database

Explanation: No active policy was found that would satisfy the request.

Recommended Action: Activate the appropriate policy and retry the operation.

NetBackup Status Code: 249

Message: the file list is incomplete

Explanation: The server timed out while waiting for the client to finish sending the file list, or a sequencing problem occurred.

Recommended Action: Obtain additional information by first creating debug logs and then attempting to recreate the error. The debug logs to create are as follows:

- ◆ On the server, `bptm`, `bpbxm`, and `bpdbm`.
- ◆ On UNIX and Windows clients, `bpbkar`.
- ◆ On other clients, `bpcd`.

Note To increase the amount of information included in the logs, see [“Debug Logs on PC Clients”](#) on page 73.

NetBackup Status Code: 250

Message: the image was not created with TIR information

Explanation: This is an internal error and should not be seen by customers.

Recommended Action: Obtain detailed troubleshooting information by creating debug logs for `bptm` and `bpdbm` on the server. Then, retry the operation and check the resulting debug logs.

NetBackup Status Code: 251

Message: the `tir` information is zero length

Explanation: For a true-image backup, the client sent no file information to the master server. NetBackup discovered this condition when it attempted to write the TIR information to media.

Recommended Action:

1. Check the file list for the policy and the exclude and include lists on the client to verify that the client has files that are eligible for backup. For example, this status code can appear if the exclude list on the client excludes all files.
2. To obtain detailed troubleshooting information, create debug logs for `bptm` and `bpdbm` on the server. Then, retry the operation and check the resulting debug logs.

NetBackup Status Code: 252

Message: the error status has been written to `stderr`

Explanation: If a Vault or Synthetic Backup job fails with a status code greater than 255, it exits with status 252; the actual Vault or Synthetic Backup job status code is written to `stderr`. Status codes greater than 255 are not preserved via the exit system call by all operating systems. The Vault or Synthetic Backup job then reports the actual status code found in `stderr` (for example, 256) as the job completion status, as seen in the Activity Monitor.

Recommended Action: For more information on a Vault or Synthetic Backup status code, refer to this resource or to the Activity Monitor's troubleshooter.

NetBackup Status Code: 253

Message: the catalog image `.f` file has been archived

Explanation: The catalog image `.f` file has been archived.

Recommended Action: Refer to catalog archiving help information to restore archived catalog image `.f` files.

NetBackup Status Code: 254

Message: server name not found in the NetBackup configuration



Explanation: This error should not occur through normal use of NetBackup.

Recommended Action: Save all error information and call customer support.

Run the NetBackup Configuration Validation Utility (NCVU) `-conf <media server option>` on the master server for the associated NetBackup media servers. Note the `bp.conf` checks in section four.

NetBackup Status Code: 256

Message: logic error encountered

Explanation: An internal vault error occurred.

Recommended Action: Contact customer support and send appropriate logs.

NetBackup Status Code: 257

Message: cannot create log file

Explanation: `vltrun` cannot create one or more log files

Recommended Action: When a Vault session is started, `vltrun` needs to create log files in the following directories:

```
UNIX: /usr/opensv/netbackup/vault/sessions/vault_name
Windows: install_path\Netbackup\vault\sessions\vault_name
UNIX: /usr/opensv/netbackup/vault/sessions/vault_name/sidxxx
Windows: install_path \NetBackup\vault\sessions\vault_name\sidxxx
(where xxx is the session id)
```

Ensure that the following directory exists, is writable by root, and that the disk is not full:

```
UNIX: /usr/opensv/netbackup/vault/sessions/vault_name
Windows: install_path\NetBackup\vault\sessions\vault_name
```

NetBackup Status Code: 258

Message: a child process failed for an unknown reason

Explanation: A child process of the vault job died with an invalid exit status.

Recommended Action: Contact customer support and send appropriate logs.

NetBackup Status Code: 259

Message: vault configuration file not found

Explanation: This error should not occur.

Recommended Action: Contact customer support and send appropriate logs.

NetBackup Status Code: 260

Message: vault internal error 260

Explanation: This error code should not occur.

Recommended Action: Contact customer support and send appropriate logs.

NetBackup Status Code: 261

Message: vault internal error 261

Explanation: This error code should not occur.

Recommended Action: Contact customer support and send appropriate logs.

NetBackup Status Code: 262

Message: vault internal error 262

Explanation: This error code should not occur.

Recommended Action: Contact customer support and send appropriate logs.

NetBackup Status Code: 263

Message: session id assignment failed

Explanation: The unique identifier to be assigned to the vault session is bad.

Recommended Action: Verify that the session id stored in the `session.last` file is valid.

UNIX:

```
/usr/opensv/netbackup/vault/sessions/vault_name/session.last
```

Windows:

```
install_path\Netbackup\vault\sessions\vault_name\session.last
```

Make sure that the file system is not full and that no one has inadvertently edited the `session.last` file. You can correct the problem by storing in the `session.last` file the highest session id that has been assigned to a session for this vault. If the problem persists, contact customer support and send the appropriate logs.

NetBackup Status Code: 265

Message: session id file is empty or corrupt

Explanation: The session id stored in the following file is bad.



UNIX:

`/usr/openv/netbackup/vault/sessions/vault_name/session.last`

Windows:

`install_path\NetBackup\vault\sessions\vault_name\session.last`

Recommended Action: Ensure that the session id stored in the `session.last` file is not corrupt. Make sure that the file system is not full and that no one has inadvertently edited the file. You can correct the problem by storing in the `session.last` file the highest session id that has been assigned to a session for this vault. If the problem persists, contact customer support and send the appropriate logs.

NetBackup Status Code: 266

Message: cannot find robot, vault, or profile in the vault configuration

Explanation: The *profile name* or triplet *robot_name/vault_name/profile_name* specified on the vault command (`vltrun`, `vlteject`, `vltoffsitemedia`), or by means of `vltopmenu`, was not found in the vault configuration.

Recommended Action: Please rerun the command with the correct *profile_name* or triplet *robot_name/vault_name/profile_name*.

NetBackup Status Code: 267

Message: cannot find the local host name

Explanation: A vault job obtains the local host name via an OS call. This error occurs when the vault job is unable to get the local host name.

Recommended Action: Issue a `hostname` command at the OS command prompt. See the `hostname` (or `gethostbyname`) man page for an explanation of the conditions that would cause it to fail. Refer to the *OS System Administrator Guide* for more information

NetBackup Status Code: 268

Message: the vault session directory is either missing or inaccessible

Explanation: This error occurs when a vault job cannot access the following:

UNIX: `/usr/openv/netbackup/vault/sessions`

Windows: `install_path\NetBackup\vault\sessions`

This directory is created when vault is installed.

Recommended Action: Make sure you are running on the master server where vault is installed and configured. Also ensure that no one has accidentally removed the sessions directory or changed permission on the directory path so it is inaccessible to the vault job.

NetBackup Status Code: 269

Message: no vault session id was found

Explanation: This error is encountered when `vltopmenu` cannot find a `sidxxx session id` directory for the specified profile. It means that either no vault jobs were run for this profile or that the corresponding `sidxxx session id` directory (or directories) were removed from the following directory:

```
UNIX: /usr/opensv/netbackup/vault/sessions/vault_name
Windows: install_path\NetBackup\vault\sessions\vault_name
```

Recommended Action: You can either specify a different profile for which vault jobs have been run or exit `vltopmenu`, run a vault job for the specific profile and rerun `vltopmenu` and select the profile.

NetBackup Status Code: 270

Message: unable to obtain process id, getpid failed

Explanation: This error occurs when a vault process is unable to obtain its process id by means of the `getpid()` OS system call.

Recommended Action: Look at the system log for any unusual system problems. Wait for a while and try running the process again when system resources have been freed up.

NetBackup Status Code: 271

Message: the initialization of the vault configuration file failed

Explanation: This error occurs when configuration initialization code fails.

Recommended Action: Ensure that the following is accessible:

```
UNIX: /usr/opensv/netbackup/lib/libxerces-c1_4nmt.so
Windows: install_path\NetBackup\lib\libxerces-c1_4nmt.so
```

NetBackup Status Code: 272

Message: execution of a vault notify script failed

Explanation: This error occurs when the vault process is unable to execute a vault notify script due to permissions problems or coding problems in the script or if an error is returned by the script.

Recommended Action: Ensure that the notify script is executable and runs without errors. You must debug the script by running it manually to eliminate coding errors.



NetBackup Status Code: 273

Message: invalid job id

Explanation: This error should not occur.

Recommended Action: Contact customer support and send appropriate logs.

NetBackup Status Code: 274

Message: no profile was specified

Explanation: This error should not occur.

Recommended Action: Contact customer support and send the appropriate logs.

NetBackup Status Code: 275

Message: a session is already running for this vault

Explanation: This error occurs when you start a session for a vault and another session is already running for this vault. Only one session is allowed for a vault at any given time.

Recommended Action: Start the vault session after the previous session has completed.

NetBackup Status Code: 276

Message: invalid session id

Explanation: This error should not occur.

Recommended Action: Contact customer support and send the appropriate logs.

NetBackup Status Code: 277

Message: unable to print reports

Explanation: This error should not occur.

Recommended Action: Contact customer support and send the appropriate logs.

NetBackup Status Code: 278

Message: unimplemented error code

Explanation: This error should not occur.

Recommended Action: Contact customer support and send the appropriate logs.

NetBackup Status Code: 279

Message: unimplemented error code

Explanation: This error should not occur.

Recommended Action: Contact customer support and send the appropriate logs.

NetBackup Status Code: 280

Message: unimplemented error code

Explanation: This error should not occur.

Recommended Action: Contact customer support and send the appropriate logs.

NetBackup Status Code: 281

Message: vault core error

Explanation: An internal vault error occurred.

Recommended Action: Contact customer support and send the appropriate logs.

NetBackup Status Code: 282

Message: vault core system error

Explanation: An internal system exception was encountered by the vault job.

Recommended Action: Contact customer support and send appropriate logs.

NetBackup Status Code: 283

Message: vault core unhandled error

Explanation: The vault job encountered a system exception.

Recommended Action: Contact customer support and send appropriate logs.

NetBackup Status Code: 284

Message: error caused by invalid data in vault configuration file

Explanation: This error is returned by a vault job or a command when it cannot interpret the information extracted from the vault configuration file. For example, if the vault configuration file is corrupt or refers to non-existent or misconfigured objects.

Recommended Action: Ensure that your vault configuration is correct (that it refers to functional robots, media servers, volume pools, and so forth). Also ensure that the vault profile is defined in the configuration and has not been accidentally removed after the vault



job was started. This can happen when more than one vault interface is changing the configuration at the same time. Examine the vault logs for detailed information about configuration problems. To correct the problem, you may need to restore the following file from a backup copy:

```
UNIX: /usr/opensv/netbackup/db/vault/vault.xml
Windows: install_path\NetBackup\db\vault\vault.xml
```

NetBackup Status Code: 285

Message: unable to locate vault directory

Explanation: This error is returned by a vault job or command when it cannot locate the following directory:

```
UNIX: /usr/opensv/netbackup/vault
Windows: install_path\NetBackup\vault
```

Recommended Action: The `vault` directory is created when the vault package is installed on the master server. Ensure that the vault job or command is started as root on the master server and that the `vault` directory has not been inadvertently removed or made inaccessible to root user.

NetBackup Status Code: 286

Message: vault internal error

Explanation: This error should never occur.

Recommended Action: Contact customer support and send the appropriate logs.

NetBackup Status Code: 287

Message: failed attempting to copy (consolidated) report file

Explanation: This error occurs when a vault job is unable to copy the consolidated reports to the destination directory specified in the vault profile.

Recommended Action: Ensure that the destination directory specified in the profile exists and is writable by root. Also the vault job or command must be started with root privileges. Correct the path and/or permissions of the destination directory and rerun the vault job or command.

NetBackup Status Code: 288

Message: attempt to open a log file failed

Explanation: This error occurs when a vault job cannot create the `summary.log` file in the following directory:

UNIX: `/usr/opensv/netbackup/vault/sessions/vault_name/sidxxx`
 Windows: `install_path\Netbackup\vault\sessions\vault_name\sidxxx`

(where *xxx* is the session id.)

Recommended Action: Ensure that the above directory exists and has not been inadvertently removed after the vault job was started. Ensure that this directory is writable by root and that the disk is not full. Rerun the vault job after correcting the problem.

NetBackup Status Code: 289

Message: an error occurred when calling vault core

Explanation: The error can occur during a normal vault job or when `vlt eject` is executed for a specific session or when `vltopmenu` is used to generate individual reports, if any of the following conditions exists:

- ◆ `vltcore` binary is removed
- ◆ `vltopmenu` binary is not executable
- ◆ the following directory is removed or made inaccessible to root (where *xxx* is the session id):

UNIX: `/usr/opensv/netbackup/vault/sessions/vault_name/sidxxx`
 Windows: `install_path\Netbackup\vault\sessions\vault_name\sidxxx`

- ◆ the disk (on which NetBackup is installed) is full

Recommended Action: To identify which of the above conditions led to the failure, review the vault debug log in the following directory:

UNIX: `/usr/opensv/netbackup/logs/vault`
 Windows: `install_path\NetBackup\logs\vault`

Also review the `summary.log` file in each of the `sidxxx` directories that had problems:

UNIX: `/usr/opensv/netbackup/vault/sessions/vault_name/sidxxx`
 Windows: `install_path\NetBackup\vault\sessions\vault_name\sidxxx`

Correct the problem and rerun the vault job. If the problem persists, please contact customer support and send the appropriate logs.

NetBackup Status Code: 290

Message: one or more errors detected during eject processing

Explanation: This error occurs when more than one error is encountered during an eject procedure via `vltopmenu`. Any "eject" errors in the range 291 to 300 could have occurred in any of the sessions being ejected.



Recommended Action: For detailed information, review the vault debug log in the following directory:

UNIX: `/usr/opensv/netbackup/logs/vault`
Windows: `install_path\NetBackup\logs\vault`

Also review the `summary.log` in each of the `sidxxx` directories that had problems:

UNIX: `/usr/opensv/netbackup/vault/sessions/vault_name/sidxxx`
Windows: `install_path\NetBackup\vault\sessions\vault_name\sidxxx`

(where `xxx` is the session id)

The media that was not ejected may need to be ejected manually by means of `vlteject` or `vltopmenu`, after the problem has been identified and corrected.

This error often indicates that the media were left in the offsite vault volume group but still physically reside in the robot or in the robotic MAP. To solve this problem, do one of the following:

- ◆ Manually remove any media that are in the offsite vault volume group but are still in the robotic library.
- ◆ Inventory the robotic library. This puts any media that were in the offsite vault volume group back into the robotic volume group. Then, rerun the vault sessions that failed.

NetBackup Status Code: 291

Message: number of media has exceeded capacity of MAP; must perform manual eject using `vltopmenu` or `vlteject`

Explanation: This error occurs when a vault job is run for a profile that has selected automatic eject mode and the number of media to be ejected exceeds the capacity of the MAP.

Recommended Action: Use `vltopmenu` to manually eject the media for the selected profile and session id. The `vltopmenu` option will let you eject the selected media, a MAP-full (or less) at a time.

NetBackup Status Code: 292

Message: eject process failed to start

Explanation: This error occurs when the eject processing cannot be started by the vault job or `vlteject` command or via `vltopmenu`.

Recommended Action: For detailed information about the problem, review the vault debug log in the following directory:

UNIX: `/usr/opensv/netbackup/logs/vault`

Windows: `install_path\NetBackup\logs\vault`

Also review the `summary.log` in each of the `sidxxx` directories that had problems:

UNIX: `/usr/opensv/netbackup/vault/sessions/vault_name/sidxxx`

Windows: `install_path\NetBackup\vault\sessions\vault_name\sidxxx`

(where `xxx` is the session id)

Use the `robtest` utility to ensure that you can communicate with the vault robotic library. Once the problem is resolved, rerun the vault session, `vlteject` command, or `vltopmenu` command.

NetBackup Status Code: 293

Message: eject process has been aborted

Explanation: This error occurs when the eject processing has been aborted. This error could be encountered during a vault job or when using `vlteject` or the `vltopmenu` eject command.

This error can occur because of one of the following conditions:

- ◆ Could not open a pipe to `vmchange -verify_eject` call.
- ◆ Unexpected output from `vmchange -verify_eject` call.
- ◆ There are no MAP elements to eject media into.
- ◆ The robotic library had problems putting media into the MAP.
- ◆ The user hit Return in interactive mode without first removing the media from the MAP. In this case, the media that were in the MAP will be put back into their original slots in the robotic library.

Recommended Action: For detailed information about why the process was aborted, review the vault debug log in the following directory:

UNIX: `/usr/opensv/netbackup/logs/vault`

Windows: `install_path\NetBackup\logs\vault`

Also review the `summary.log` in each of the `sidxxx` directories that had problems:

UNIX: `/usr/opensv/netbackup/vault/sessions/vault_name/sidxxx`

Windows: `install_path\NetBackup\vault\sessions\vault_name\sidxxx`

(where `xxx` is the session id)

This error often indicates that the media were left in the offsite vault volume group but still physically reside in the robot or in the robotic MAP. To solve this problem, do one of the following:

- ◆ Manually remove any media that are in the offsite vault volume group but are still in the robotic library.



- ◆ Inventory the robotic library. This puts any media that were in the offsite vault volume group back into the robotic volume group. Then, rerun the vault sessions that failed.

NetBackup Status Code: 294

Message: database backup failed

Explanation: The catalog backup step failed during a vault job.

Recommended Action: For detailed information about why the process failed, review the vault debug log in the following directory:

```
UNIX: /usr/opensv/netbackup/logs/vault
Windows: install_path\NetBackup\logs\vault
```

Also review the `summary.log` in each of the `sidxxx` directories that had problems, to find the actual problem that caused the catalog backup (bpbackupdb) to fail:

```
UNIX: /usr/opensv/netbackup/vault/sessions/vault_name/sidxxx
Windows: install_path\NetBackup\vault\sessions\vault_name\sidxxx
```

(where `xxx` is the session id)

Correct the problem and rerun the vault job.

NetBackup Status Code: 295

Message: eject process could not obtain information about the robot

Explanation: This error occurs when the eject process cannot collect information about the robotic library and its associated MAPs and volumes.

Recommended Action: For detailed information about why the process failed, review the vault debug log in the following directory:

```
UNIX: /usr/opensv/netbackup/logs/vault
Windows: install_path\NetBackup\logs\vault
```

Also review the `summary.log` in each of the `sidxxx` directories that had problems:

```
UNIX: /usr/opensv/netbackup/vault/sessions/vault_name/sidxxx
Windows: install_path\NetBackup\vault\sessions\vault_name\sidxxx
```

(where `xxx` is the session id)

Correct the error and rerun the vault session, `vlteject` command, or `vltopmenu eject` command.

NetBackup Status Code: 296

Message: process called but nothing to do

Explanation: This error occurs in the following situations:

`vlt eject` is called with `-eject` and there are no tapes to eject

`vlt eject` is called with `-eject` and the eject is already done

`vlt eject` is called with `-report` and the reports are already done

`vlt eject` is called with `-eject` and `-report`, and both the eject and the reports are done

Recommended Action: This is an informative error and does not require any action.

NetBackup Status Code: 297

Message: all volumes are not available to eject

Explanation: This error occurs when an attempt is made to eject a non-existent or bad media id during the eject phase of a vault session, `vlt eject` command, or `vltopmenu` command.

Possible reasons for this occurring are:

- ◆ The bad media id was added by means of the `vlt_ejectlist_notify` script.
- ◆ The bad media id is already in the MAP or not in the robotic library.
- ◆ The bad media id is in a robotic drive.
- ◆ The bad media id is in transit in the robotic library.

Recommended Action: Remove or correct the bad media id from the `vlt_ejectlist_notify` script and rerun the vault session. If the bad media id is in the MAP or a drive or in transit, something is misconfigured.

NetBackup Status Code: 298

Message: the library is not ready to eject volumes

Explanation: This error occurs if the robotic library is not in a state to support ejecting media.

Possible reasons for this include:

- ◆ The library is currently ejecting media
- ◆ The library is pending ejecting media
- ◆ The library is currently injecting media
- ◆ The library is pending injecting media

Recommended Action: Wait until the robotic library can support the eject action and rerun the vault session, `vlt eject` command, or `vltopmenu` command.



NetBackup Status Code: 299

Message: there is no available MAP for ejecting

Explanation: The robotic library you are vaulting from does not have a MAP available for use and so media cannot be ejected.

Recommended Action: Wait until the robotic library's MAP is available for use and rerun the vault session, `vlteject` command, or `vltopmenu` command.

NetBackup Status Code: 300

Message: vmchange eject verify not responding

Explanation: During the eject process, the `vmchange` command is called with a `"-verify_eject"` call until all of the volumes for the request are in the MAP. This command call failed or did not return the proper information to the vault eject process.

Recommended Action: For detailed information about why the process failed, review the vault debug log in the following directory:

```
UNIX: /usr/opensv/netbackup/logs/vault
Windows: install_path\NetBackup\logs\vault
```

Also review the `summary.log` in each of the `sidxxx` directories that had problems:

```
UNIX: /usr/opensv/netbackup/vault/sessions/vault_name/sidxxx
Windows: install_path\NetBackup\vault\sessions\vault_name\sidxxx
```

(where `xxx` is the session id)

This error often indicates that the media were left in the offsite vault volume group but still physically reside in the robot or in the robotic MAP. To solve this problem, do one of the following:

- ◆ Manually remove any media that are in the offsite vault volume group but are still in the robot.
- ◆ Inventory the robot. This puts any media that were in the offsite vault volume group back into the robotic volume group. Then, rerun the vault sessions that failed.

NetBackup Status Code: 301

Message: vmchange api_eject command failed

Explanation: During the eject process, the `vmchange` command is called with an `"-api_eject"` call to begin the process of ejecting media. This command call failed.

Recommended Action: For detailed information about why the process failed, review the vault debug log in the following directory:

```
UNIX: /usr/opensv/netbackup/logs/vault
```

Windows: `install_path\NetBackup\logs\vault`

Also review the `summary.log` in each of the `sidxxx` directories that had problems:

UNIX: `/usr/opensv/netbackup/vault/sessions/vault_name/sidxxx`

Windows: `install_path\NetBackup\vault\sessions\vault_name\sidxxx`

(where `xxx` is the session id)

Once the problem is resolved, rerun the vault session, `vlteject` command, or `vltopmenu` command.

NetBackup Status Code: 302

Message: error encountered attempting backup of catalog (multiple tape catalog backup)

Explanation: This error occurs when the NetBackup command used for stage one of the two-stage catalog backup fails.

Recommended Action: For the actual error that caused the failure, review the vault debug log in the following directory:

UNIX: `/usr/opensv/netbackup/logs/vault`

Windows: `install_path\NetBackup\logs\vault`

Review the `summary.log` in each of the `sidxxx` directories that had problems:

UNIX: `/usr/opensv/netbackup/vault/sessions/vault_name/sidxxx`

Windows: `install_path\NetBackup\vault\sessions\vault_name\sidxxx`

(where `xxx` is the session id)

In addition, review the admin debug log in the following directory:

UNIX: `/usr/opensv/netbackup/logs/admin`

Windows: `install_path\NetBackup\logs\admin`

Correct the error and rerun the vault session.

NetBackup Status Code: 303

Message: error encountered executing Media Manager command

Explanation: This error occurs when a Media Manager command fails during a vault job.

Recommended Action: For the actual error that caused the Media Manager command to fail, review the vault debug log in the following directory:

UNIX: `/usr/opensv/netbackup/logs/vault`

Windows: `install_path\NetBackup\logs\vault`

Also review the `summary.log` in each of the `sidxxx` directories that had problems:

UNIX: `/usr/opensv/netbackup/vault/sessions/vault_name/sidxxx`



Windows: `install_path\NetBackup\vault\sessions\vault_name\sidxxx`
(where xxx is the session id)

Try running the Media Manager command (with the same arguments as in the log file) to see the actual error. Ensure that the Media Manager daemons are running. Also ensure that the robot is functional and you can communicate with it (for example, inventory the robot via the GUI).

NetBackup Status Code: 304

Message: specified profile not found

Explanation: This error occurs when the profile name specified on the vault command is not defined in the vault configuration.

Recommended Action: Please rerun the vault command with a profile name that is defined in the vault configuration.

NetBackup Status Code: 305

Message: duplicate profile specified, use full robot/vault/profile

Explanation: This error occurs when duplicate profile names have been defined in two or more vault configurations and only the profile name is specified on the vault command.

Recommended Action: You must rerun the vault command with the triplet `robot_name/vault_name/profile_name`. The triplet will uniquely identify the profile in your vault configuration.

NetBackup Status Code: 306

Message: errors encountered, partial success

Explanation: This error occurs when a vault job is partially successful, in other words, when not all images have been successfully duplicated and/or the catalog backup failed.

Recommended Action: For more information, review the vault debug log in the following directory:

UNIX: `/usr/opensv/netbackup/logs/vault`
Windows: `install_path\NetBackup\logs\vault`

Also review the `summary.log` in each of the `sidxxx` directories that had problems:

UNIX: `/usr/opensv/netbackup/vault/sessions/vault_name/sidxxx`
Windows: `install_path\NetBackup\vault\sessions\vault_name\sidxxx`

(where xxx is the session id)

A common cause of failure is the lack of resources, such as no more media available in the specified pools for duplication and catalog backup. Correct the problem and rerun the vault job. Note that the NetBackup scheduler will retry a vault job that has terminated with this error.

NetBackup Status Code: 307

Message: eject process has already been run for the requested vault session

Explanation: This error occurs when `vlteject` is run to eject media for a session id for which media has already been ejected.

Recommended Action: Rerun `vlteject` for another session id for which media has not been ejected.

NetBackup Status Code: 308

Message: no images duplicated

Explanation: This error occurs when vault failed to duplicate any images.

Recommended Action: For more information, review the vault debug log in the following directory:

```
UNIX: /usr/opensv/netbackup/logs/vault
Windows: install_path\NetBackup\logs\vault
```

Also review the `summary.log` in each of the `sidxxx` directories that had problems:

```
UNIX: /usr/opensv/netbackup/vault/sessions/<vault_name>/sidxxx
Windows: install_path\NetBackup\vault\sessions\<vault_name>\sidxxx
```

(where `<vault_name>` is the name of the vault, and `xxx` is the session id)

Look for the log entry that gives the total number of images processed. A common cause of failure is a lack of resources, such as no more media available in the specified pools for duplication. Correct the problem and rerun the vault job. Note that the NetBackup scheduler will retry a vault job that has terminated with this error. Review the admin debug log for `bpduplicate` entries and the `bptm` debug log.

NetBackup Status Code: 309

Message: report requested without eject being run

Explanation: This error occurs when a report is run that requires media to have been ejected first.

Recommended Action: Perform one of these actions:

- ◆ Rerun `vlteject` or `vltopmenu` to eject the media for the session before generating the reports.



- ◆ Reconfigure the profile to allow the eject step to be performed when the next vault session for this profile runs.
- ◆ Disable the report generation in the profile for reports that require media to be ejected.

NetBackup Status Code: 310

Message: invalid configuration for duplication to disk

Explanation: This error occurs when an invalid disk storage unit is configured in the vault profile used to duplicate images to disk, or when the profile is configured to create more than one copy and one of the copies is targeted for a disk storage unit. The latter configuration will be prevented by the vault interface and should not occur unless the vault configuration file has been manually altered.

Recommended Action: Ensure that a valid disk storage unit is configured in the profile by means of the duplication tab. Also ensure that the vault configuration file has not been manually altered.

NetBackup Status Code: 311

Message: Iron Mountain Report is already created for this session

Explanation: This error occurs when an Iron Mountain report has already been generated for the session.

Recommended Action: None; this report cannot be generated again.

NetBackup Status Code: 312

Message: invalid container database entry

Explanation: NetBackup Vault has found an invalid entry while reading the container database. Each container entry in the container database must follow the expected format. The container database exists in file `cntrDB`, which is located at `<install_path>/netbackup/vault/sessions/cntrDB`.

Recommended Action: To get the line number of an invalid record in the container database, read the log file under the directory `netbackup/logs/vault`. Be aware that a Vault log may not exist unless the directory `netbackup/logs/vault` existed before the error occurred. Open the container database file `cntrDB` and correct that invalid entry. Please note that this error will occur every time Vault reads this entry in `cntrDB` until either this invalid entry is deleted or it is corrected.

NetBackup Status Code: 313

Message: container does not exist in container database

Explanation: The specified container does not have an entry in the container database. The container database exists in file `cntrDB`, which is located at `<install_path>/netbackup/vault/sessions/cntrDB`.

Recommended Action: Verify that you have put some media into this container using the `vltcontainers` command. Verify that you have not deleted it using the `vltcontainers -delete` command.

NetBackup Status Code: 314

Message: container database truncate operation failed

Explanation: An error occurred while truncating the container database. This error may occur while modifying or deleting an entry from the container database. The container database exists in file `cntrDB`, which is located at `<install_path>/netbackup/vault/sessions/cntrDB`.

Recommended Action: Please see the log file under the directory `netbackup/logs/vault` for more details. Be aware that a log file will not be created unless the `netbackup/logs/vault` directory has already been created.

NetBackup Status Code: 315

Message: failed appending to container database

Explanation: This error occurred while appending a container record to the container database. This error may occur while adding, modifying or deleting an entry from the container database. The container database exists in file `cntrDB`, which is located at `<install_path>/netbackup/vault/sessions/cntrDB`.

Recommended Action: Please read the relevant log file under the directory `<install_path>/netbackup/logs/vault` for more details. Be aware that if this directory does not already exist, a log file will not be created.

NetBackup Status Code: 316

Message: `container_id` is not unique in container database

Explanation: NetBackup Vault has found a previously-existing entry for this container ID in the container database while adding it to the container database. Each container record in the container database must have a unique container ID. Please note that the container database exists in file `cntrDB`, which is located at `<install_path>/netbackup/vault/sessions/cntrDB`.

Recommended Action: Please verify that you have specified the correct container ID.



NetBackup Status Code: 317

Message: container database close operation failed

Explanation: This error occurred while closing the container database. This error may occur while reading, adding, modifying, or deleting an entry from the container database. Please note that the container database exists in file `cntrDB`, which is located at `<install_path>/netbackup/vault/sessions/cntrDB`.

Recommended Action: Please read the relevant log file under the directory `netbackup/logs/vault` for more details. Be aware that if this directory does not already exist, a log file will not be created.

NetBackup Status Code: 318

Message: container database lock operation failed

Explanation: This error occurred while locking the container database. This error may occur while adding, modifying, or deleting an entry from the container database. Please note that the container database exists in file `cntrDB`, which is located at `<install_path>/netbackup/vault/sessions/cntrDB`.

Recommended Action: Please read the relevant log file under the directory `netbackup/logs/vault` for more details. Be aware that if this directory does not already exist, a log file will not be created.

If some other vault operation is using the container database and has locked it, wait until that operation is complete and the container database is unlocked.

NetBackup Status Code: 319

Message: container database open operation failed

Explanation: This error occurred while opening the container database. This error may occur while reading, adding, modifying, or deleting an entry from the container database. Please note that the container database exists in file `cntrDB`, which is located at `<install_path>/netbackup/vault/sessions/cntrDB`.

Recommended Action: Please read the relevant log file under the directory `netbackup/logs/vault` for more details. Be aware that if this directory does not already exist, a log file will not be created.

NetBackup Status Code: 320

Message: the specified container is not empty

Explanation: This error occurs if you are trying to delete a container from the container database, but the container still holds media. You can only delete empty containers.

Recommended Action: Verify that you have specified the correct container ID. If you still want to delete this container from the container database, first empty it either by injecting all the media it contains into a robot, or by clearing the vault container ID fields for these media from the volume database by using `vmchange -vltcid` with a value of `-`. Attempt to delete the container again.

NetBackup Status Code: 321

Message: container cannot hold any media from the specified robot

Explanation: This error occurred while trying to place media from an unexpected volume database host into a container. All the media that are placed in a container should belong to the same volume database host. You are trying to put media from a robot that belongs to one volume database host into a container that already holds media from robots that belong to a different volume database host..

Recommended Action: Verify that you have specified the correct container ID and/or media IDs. Please read the relevant log file under the directory `<install_path>/netbackup/logs/vault` for more details. Be aware that if this directory does not already exist, a log file will not be created.

NetBackup Status Code: 322

Message: cannot find vault in vault configuration file

Explanation: NetBackup Vault could not find an entry for the specified vault name into the vault configuration file. Please note that the vault configuration file is located at `<install_path>/netbackup/db/vault/vault.xml`.

Recommended Action: Verify that you have specified the correct vault name. Please read the relevant log file under the directory `netbackup/logs/vault` for more details. Be aware that if this directory does not already exist, a log file will not be created.

NetBackup Status Code: 323

Message: cannot find robot in vault configuration file

Explanation: NetBackup Vault could not find an entry for the specified robot number in the vault configuration file. Please note that the vault configuration file is located at `<install_path>/netbackup/db/vault/vault.xml`.

Recommended Action: Verify that you have specified the correct robot number. Please read the relevant log file under the directory `netbackup/logs/vault` for more details. Be aware that if this directory does not already exist, a log file will not be created.

NetBackup Status Code: 324

Message: invalid data found in retention map file for duplication



Explanation: This error occurs when the retention mapping file (either generic or for a specific vault) contains invalid data. When there is too much or too little data in the file, or if the user has defined invalid retention levels in the file, this error will occur.

The retention mapping file is used in a vault session when duplication for a vault profile has been configured with the Use mappings retention level configured for one of the copies for duplication. The product will install a mapping file template named `retention_mappings` in `<install_path>/netbackup/db/vault`.

You can specify a mappings file for any single vault by copying the `retention_mappings` template to another file and appending the name of the vault. For example, `netbackup/db/vault/retention_mappings.V1`

Recommended Action: Check the entries in the `retention_mappings` file.

NetBackup Status Code: 325

Message: unable to find policy/schedule for image using retention mapping

Explanation: This error occurs when the backup policy or the schedule of an image that is going to be duplicated by Vault no longer exists and the Use mappings option on the Duplication tab of the Profile dialog is selected.

Recommended Action: Verify whether or not the backup policy or the schedule that created the image still exists. If either one or both do not exist, the image will not be duplicated through the vault profile.

NetBackup Status Code: 326

Message: specified file contains no valid entry

Explanation: The specified file contains no valid entries for media IDs or the alphanumeric equivalent of barcodes. As per the expected format, each line should contain only one string representing either a media ID or the numeric equivalent of a barcode.

Recommended Action: Verify that each entry in the specified file does not exceed the string size limit of six characters for media IDs and 16 characters for the numeric equivalent of barcodes. Correct the invalid entries in the specified file and try the same operation again. Please read the relevant log file under the directory `<install_path>netbackup/logs/vault` for more details. Be aware that if this directory does not already exist, a log file will not be created.

NetBackup Status Code: 327

Message: no media ejected for the specified vault session

Explanation: This error occurred while moving media ejected by the specified vault session to a container. Either the specified vault session has not ejected any media, or you have specified an incorrect vault name and/or session ID.

Recommended Action: Verify that you have specified the correct combination of vault name and session ID. Verify that the specified vault session has ejected at least one piece of media. Please read the relevant log file under the directory `netbackup/logs/vault` for more details. Be aware that if this directory does not already exist, a log file will not be created.

NetBackup Status Code: 328

Message: invalid container id

Explanation: This error occurred while adding a container record to the container database. The container ID was found invalid. Please note that the container database exists in file `cntrDB`, which is located at `<install_path>/netbackup/vault/sessions/cntrDB`.

Recommended Action: Verify that the container ID does not contain any space characters, and that the string size is a maximum of 29 characters long.

NetBackup Status Code: 329

Message: invalid recall status

Explanation: This error occurred while adding a container record to the container database. The container recall status was found invalid. Please note that the container database exists in file `cntrDB`, which is located at `<install_path>/netbackup/vault/sessions/cntrDB`.

Recommended Action: Verify that the recall status is either 1 or 0.

NetBackup Status Code: 330

Message: invalid volume database host

Explanation: This error occurred while adding a container record to the container database. The volume database host name was found invalid. Please note that the container database exists in file `cntrDB`, which is located at `<install_path>/netbackup/vault/sessions/cntrDB`.

Recommended Action: Verify that the volume database host name does not contain any space characters, and that the string size is a maximum of 256 characters long.

NetBackup Status Code: 331

Message: invalid container description



Explanation: This error occurred while adding a container record to the container database. The container description was found invalid. Please note that the container database exists in file `cntrDB`, which is located at `<install_path>/netbackup/vault/sessions/cntrDB`.

Recommended Action: Verify that the string size of the container description is a maximum of 25 characters long.

NetBackup Status Code: 332

Message: error getting information from volume database

Explanation: This error can occur while the backup process is communicating with the volume database to fetch some information.

Recommended Action:

- ◆ On UNIX, verify that the Media Manager volume daemon (`vmd`) is running. On Windows, verify that the NetBackup Volume Manager service is running.
- ◆ See the process-specific error log directory for more details.

UNIX: `/usr/opensv/netbackup/logs/process_name`

Windows: `install_path\NetBackup\logs\process_name`

For example, if you are getting this error while running a vault command (such as `vltcontainers` or `vltopmenu`), look at the logs under `/usr/opensv/netbackup/logs/vault` to find the reason for this error.

Note The log file will not be created unless the appropriate log directory, such as `/usr/opensv/netbackup/logs/vault`, has already been created.

NetBackup Status Code: 500

Message: NB-Java application server not accessible - maximum number of connections exceeded.

Explanation: Indicates that an attempted login failed because the maximum number of NetBackup-Java user services has been achieved. Although the number of allowed user services is very large (greater than 100), it is possible to reach the maximum.

Recommended Action: Ask other users to log off (this limit is not configurable).

NetBackup Status Code: 501

Message: You are not authorized to use this application.

Explanation: The user is not authorized to use one of the NetBackup Java Administration utilities on the host specified in the login dialog.

Recommended Action: Check the `auth.conf` file on the host specified in the NetBackup-Java login dialog for the proper authorization. If the `auth.conf` file does not exist, it must be created with the proper entry for this user name. Refer to the *NetBackup System Administrator's Guide* for more details on the `auth.conf` file.

NetBackup Status Code: 502

Message: No authorization entry exists in the `auth.conf` file for user name *username*. None of the NB-Java applications are available to you.

Explanation: The user name is not authorized to use any NetBackup-Java applications on the host specified in the login dialog.

Recommended Action: Check the `auth.conf` file on the machine (host name) specified in the NetBackup-Java login dialog for the proper authorization. If the file does not exist, it must be created with the proper entry for this user name. Refer to the *NetBackup System Administrator's Guide for UNIX* for more details on the `auth.conf` file.

NetBackup Status Code: 503

Message: Invalid username.

Explanation: For login to a UNIX host, the user name is not recognized by the NetBackup Java application server on the host where the login is requested.

For login to a Windows host, the NetBackup-Java authentication service on the host where the login is requested does not have sufficient privileges for granting the login request.

Recommended Action:

- ◆ For UNIX hosts: the user name must be a valid user name in the `passwd` file on the host specified in the login dialog.
- ◆ For Windows hosts: refer to the `LogonUser` function in the section titled Client/Server Access Control Functions of the *Windows NT Platform Software Developer's Kit* to determine the required privileges.

NetBackup Status Code: 504

Message: Incorrect password.

Explanation: For login to a UNIX host, the user name is recognized on the host where the login is requested, but the password supplied is incorrect.

For login to a Windows host, the attempt to log in the user has failed. The failure could be due to an unrecognized user in the specified domain.

Recommended Action:

- ◆ Enter the correct password.



- ◆ On Windows hosts: The exact error can be found in the `bpjava-msvc` log file. For more details, refer to the `LogonUser` function in the section *Client/Server Access Control Functions of the Windows NT Platform Software Developer's Kit*.

NetBackup Status Code: 505

Message: Can not connect to the NB-Java authentication service on (*host*) on the configured port - (*port_number*).

Explanation: The initial connection from the NetBackup-Java interface to its authentication service on (*host*) was on the `configured_port_number` mentioned in the error message. The port is either being used by another application, or the NetBackup-Java interface and its application server are not configured with the same port. The default port is 13722.

Recommended Action:

1. On UNIX: compare the `bpjava-msvc` entry in the `/etc/services` file with the `BPJAVA_PORT` entry in the `/usr/opencv/java/nbj.conf` file

On Windows: compare the `bpjava-msvc` entry in the `%systemroot%\system32\drivers\etc\services` file with the `install_path\java\hostname.vrtnsbuj` file (Windows). The entries must match.
2. Ensure that no other application is using the port configured for the NetBackup-Java interface.

NetBackup Status Code: 506

Message: Can not connect to the NB-Java user service on (*host*) on port (*port_number*). If successfully logged in prior to this, please retry your last operation.

Explanation: Once the user name on the login dialog is validated for access by the NetBackup-Java authentication service, a NetBackup-Java user service is used for all other service requests from the NetBackup-Java interface. Communication was attempted between the NetBackup-Java interface and the user service on host (*host*) on the port number specified in the error message. Refer to the various port configuration options described in the *NetBackup System Administrator's Guide* (UNIX or Windows).

- ◆ On UNIX: the port configuration options are specified in the `/usr/opencv/netbackup/bp.conf` file or through Administration Console Host Properties.
- ◆ On Windows: from the NetBackup Administration Console, select **Host Properties**. Select **Properties** from the **Actions** menu. The **Port Ranges** tab contains the port options. For more information, refer to the *NetBackup System Administrator's Guide for Windows*.

Recommended Action:

1. Restart the NetBackup-Java interface and log in again.
2. If the problem persists, enable detailed debug logging.
3. Restart the NetBackup-Java interface and examine the logs.

NetBackup Status Code: 507

Message: Socket connection to the NB-Java user service has been broken. Please retry your last operation.

Explanation: The connection was broken to the NetBackup Java application server that is running on the NetBackup host you are logged in to.

Recommended Action:

1. Retry the last operation.
2. If the problem persists, restart the NetBackup-Java interface and try again.
3. If the problem still persists, enable detailed debug logging as explained under [“Enabling Detailed Debug Logging”](#) on page 83.
4. Restart the NetBackup-Java interface and examine the logs.

Note You may be having network or system problems unrelated to NetBackup.

NetBackup Status Code: 508

Message: Can not write file.

Explanation: This error is caused by one of the following:

- ◆ The NetBackup-Java user service has attempted to write to a file that does not have write permissions. The solution is to enable write privileges.
- ◆ The NetBackup-Java user service has attempted to write to a temporary file whose unique name cannot be constructed. This condition is unlikely, but could result from an exhaustion of system resources (from the filling of the name space).

Recommended Action: The specific details may be retrieved from the user service log files. Enable detailed debug logging as explained under [“Enabling Detailed Debug Logging”](#) on page 83.



NetBackup Status Code: 509

Message: Can not execute program.

Explanation: The NetBackup-Java authentication or user service has reported an error relating to the creation (or demise) of a child job process. The NetBackup-Java service programs create separate jobs to accomplish specific tasks, as follows. The NetBackup-Java authentication service creates the NetBackup-Java user service. Upon successful creation of and connection to the NetBackup-Java user service, all other child processes are created by the NetBackup-Java user service on behalf of requests made by the NetBackup-Java interface.

Note The cause of status code 509 can be found in the appropriate log file, either for `bpjava-msvc`, `bpjava-susvc`, or `bpjava-usvc`. The cause can be categorized as one of the following:

- ◆ A job (started by either the NetBackup-Java authentication service or user service) no longer exists, and did not report its result status.
- ◆ A job (started by either the NetBackup-Java authentication service or user service) cannot be monitored by the NetBackup-Java service. This is probably due to a lack of system resources (insufficient memory).
- ◆ The maximum number of non-transient activity monitor jobs (>100) have already been started.

Recommended Action:

1. If the problem persists, restart the NetBackup-Java interface and try again.
2. If the problem still persists, enable detailed debug logging as explained under [“Enabling Detailed Debug Logging”](#) on page 83.
3. Restart the NetBackup-Java interface and examine the logs.

Note The error is probably the result of a system resource issue. When detailed debug logging has been enabled, the details may be retrieved from the `bpjava-msvc`, `bpjava-susvc`, or `bpjava-usvc` log files.

NetBackup Status Code: 510

Message: File already exists: *file_name*

Explanation: The NetBackup-Java user service has attempted to create a file that already exists.

Recommended Action: Remove the file, which can be identified in the user service log files. Refer to [“Troubleshooting the Administration Console for UNIX”](#) on page 81.

NetBackup Status Code: 511

Message: NB-Java application server interface error: Java exception

Explanation: This is a generic error for all non-socket IO/connection-broken related errors (status code 507) that could occur when processing the data from the NetBackup-Java authentication or user services. The Java exception will provide some additional detail about the error.

This error usually results from system or network problems.

Recommended Action:

1. If the problem persists, restart the NetBackup-Java interface and try again.
2. If the problem still persists, enable detailed debug logging as explained under [“Enabling Detailed Debug Logging”](#) on page 83.
3. Restart the NetBackup-Java interface and examine the logs.

Note The error is probably the result of a system resource issue. When detailed debug logging has been enabled, the details may be retrieved from the `bpjava-msvc`, `bpjava-susvc`, or `bpjava-usvc` log files.

NetBackup Status Code: 512

Message: Internal error - a bad status packet was returned by NB-Java application server that did not contain an exit status code.

Explanation: The NetBackup-Java authentication or user service returned a data packet indicating an error, but no status code or error message was contained within it.

Recommended Action:

1. If the problem persists, restart the NetBackup-Java interface and try again.
2. If the problem still persists, enable detailed debug logging as explained under [“Enabling Detailed Debug Logging”](#) on page 83.
3. Restart the NetBackup-Java interface and examine the logs.

Note The error is probably the result of a system resource issue. When detailed debug logging has been enabled, the details may be retrieved from the `bpjava-msvc`, `bpjava-susvc`, or `bpjava-usvc` log files.



NetBackup Status Code: 513

Message: bpjava-msvc: the client is not compatible with this server version (*server_version*).

Explanation: The NetBackup-Java application server (on the remote host you are logging in to) is not the same version as the NetBackup-Java interface on your local host. The two are therefore incompatible.

Recommended Action:

- ◆ Log in to a different NetBackup remote host.
- ◆ Upgrade the NetBackup software on either the machine specified in the login dialog or on the local host where you started the NetBackup Java interface.

NetBackup Status Code: 514

Message: NB-Java: bpjava-msvc is not compatible with this application version (*application_version*). You may try login to a different NetBackup host or exit the application. The remote NetBackup host will have to be configured with the same version of NetBackup as the host you started the application on.

Explanation: The NetBackup-Java application server (on the remote host you are logging in to) is not the same version as the NetBackup-Java interface on your local host. The two are therefore incompatible.

Recommended Action:

- ◆ Log in to a different NetBackup remote host.
- ◆ Upgrade the NetBackup software on either the machine specified in the login dialog or on the local host where you started the NetBackup Java interface.

NetBackup Status Code: 516

Message: Could not recognize or initialize the requested locale - (*locale_NB-Java_was_started_in*).

Explanation: This status concerns the UNIX locale configuration (or Windows regional settings) defined on the host that was specified in the NB-Java login dialog. At login, the locale configuration is passed to the NB-Java authentication service. Status 516 is generated if the locale is not recognized or if the locale of the user service could not be initialized.

Recognition of a valid locale is determined by the rules in the `/usr/opencv/msg/.conf` file on UNIX and in the `install_path\msg\lc.conf` file on Windows. When the locale is validated, initialization of the locale in the user service's environment is attempted (by means of `setlocale`).

Recommended Action: On the host that was specified in the NB-Java login dialog, check the NetBackup configuration file mentioned above to ensure there is a mapping available for the indicated locale. (For information on locale configuration and mapping, refer to the *NetBackup System Administrator's Guide*.) If there is a mapping, try to set the mapped locale on the host that was specified in the NB-Java login dialog. This system may not be configured properly.

NetBackup Status Code: 517

Message: Can not connect to the NB-Java user service via VNETD on (*host*) on port (*configured_port_number*). If successfully logged in prior to this, please retry your last operation.

Explanation: Once the username on the login dialog is validated for access by the NB-Java authentication service, an NB-Java user service is used for all other service requests from the Administration console. Communication between the Administration console and the user service was attempted to host {host} on the port number specified in the error message through use of VNETD (that is, the NB-Java configuration option NBJAVA_CONNECT_OPTION was set to 1). This message may be followed by one or more of the following messages:

```
Connection to user service via VNETD is unsuccessful - status Null
Socket instance.
```

```
Connection to user service via VNETD is unsuccessful - status
Incompatible VNET version:{0} (where {0} is some value)
```

Recommended Action:

1. On UNIX: Compare the VNETD entry in the `/etc/services` file with the VNETD_PORT entry in `/usr/opensv/java/nbj.conf`

On Windows: Compare the VNETD entry with the VNETD_PORT entry in the `<installation_path>\java\<hostname>.vrtsnbuf` file.

These entries must match.
2. Ensure that no other application is using the port configured for VNETD.

NetBackup Status Code: 518

Message: No ports available in range (*port_number*) through (*port_number*) per the NBJAVA_CLIENT_PORT_WINDOW configuration option.

Explanation: All the ports in the specified range are in use. This may be caused by too many concurrent users of the NetBackup-Java interface, or by too few configured ports.

Recommended Action:



1. Restart the NetBackup-Java interface and try again.
2. If the problem persists, increase the range of ports by changing the `NBJAVA_CLIENT_PORT_WINDOW` option in the `/usr/opensv/java/nbj.conf` file (UNIX) or the `install_path\java\hostname.vrtsnbuf` file (Windows).

NetBackup Status Code: 519

Message: Invalid NBJAVA_CLIENT_PORT_WINDOW configuration option value: (*option_value*).

Explanation: The value for the NB-Java configuration option `NBJAVA_CLIENT_PORT_WINDOW` is invalid.

Recommended Action: Correct the value in file `/usr/opensv/java/nbj.conf` (UNIX) or `install_path\java\hostname.vrtsnbuf` file (Windows).

NetBackup Status Code: 520

Message: Invalid value for NB-Java configuration option (*option_name*): (*option_value*).

Explanation: The specified NetBackup-Java configuration option has an invalid value.

Recommended Action: Correct the value in file `/usr/opensv/java/nbj.conf` (UNIX) or `install_path\java\hostname.vrtsnbuf` file (Windows).

NetBackup Status Code: 521

Message: NB-Java Configuration file (*file_name*) does not exist.

Explanation: This error code is not currently in use.

NetBackup Status Code: 522

Message: NB-Java Configuration file (*file_name*) is not readable due to the following error: (*message*).

Explanation: The specified NetBackup-Java configuration file exists but is not readable.

Recommended Action: Correct the file as specified in the message.

NetBackup Status Code: 600

Message: an exception condition occurred

Explanation: The synthetic backup job encountered an exception condition.

Recommended Action: Contact customer support and send appropriate debug logs. Please refer to the section on [“Logs To Accompany Problem Reports for Synthetic Backup”](#) in the chapter on [“Using Logs and Reports”](#) for a complete list of logs and configuration information to provide.

NetBackup Status Code: 601

Message: unable to open listen socket

Explanation: The `bpsynth` process was unable to open a socket to listen for incoming connections from the `bptm/bpdm` processes started for reading backup images or for writing the synthetic image on the media servers.

Recommended Action: Check the OS error reported in the error message logged by `bpsynth` in the NetBackup error log. This error will help in diagnosing the problem. Ensure that the `bpsynth` binary matches the installed NetBackup version. Retry the synthetic backup job. If the problem persists, please contact customer support and provide the appropriate logs. Please refer to the section on [“Logs To Accompany Problem Reports for Synthetic Backup”](#) in the chapter on [“Using Logs and Reports”](#) for a complete list of logs and configuration information to provide.

NetBackup Status Code: 602

Message: cannot set non blocking mode on the listen socket

Explanation: The `bpsynth` process is unable to set the non-blocking socket option on the listen socket.

Recommended Action: Check the OS error reported in the error message logged in the NetBackup error log. The error will help in diagnosing the problem. Ensure that the `bpsynth` binary matches the installed NetBackup version. If the condition persists, contact customer support and send appropriate logs. Please refer to the section on [“Logs To Accompany Problem Reports for Synthetic Backup”](#) in the chapter on [“Using Logs and Reports”](#) for a complete list of logs and configuration information to provide.

NetBackup Status Code: 603

Message: cannot register handler for accepting new connections

Explanation: The `bpsynth` process cannot register the listen socket with the ACE reactor.

Recommended Action: Ensure that the `bpsynth` binary matches the installed NetBackup version. Retry the synthetic backup job. If the problem persists, please contact customer support and send appropriate logs. Please refer to the section on [“Logs To Accompany Problem Reports for Synthetic Backup”](#) in the chapter on [“Using Logs and Reports”](#) for a complete list of logs and configuration information to provide.



NetBackup Status Code: 604

Message: no target storage unit specified for the new job

Explanation: The request containing the attributes of the synthetic backup job received by `bpcoord` did not include the target storage unit.

Recommended Action: Please ensure that the `bpsynth` and `bpcoord` binaries match the installed NetBackup version. Retry the synthetic backup job. If the problem persists, please contact customer support and provide appropriate logs. Please refer to the section on [“Logs To Accompany Problem Reports for Synthetic Backup”](#) in the chapter on [“Using Logs and Reports”](#) for a complete list of logs and configuration information to provide.

NetBackup Status Code: 605

Message: received error notification for the job

Explanation: The `bpcoord` process received an error indication for the synthetic backup job.

Recommended Action: Please review the NetBackup error log for errors logged by `bpsynth`, `bpcoord` and the `bptm/bpdm` reader/writer processes. For more information refer to the debug logs for these processes. Correct the errors that lead to the failure and retry the job. If the problem persists, contact customer support and provide appropriate logs. Please refer to the section on [“Logs To Accompany Problem Reports for Synthetic Backup”](#) in the chapter on [“Using Logs and Reports”](#) for a complete list of logs and configuration information to provide.

NetBackup Status Code: 606

Message: no robot on which the media can be read

Explanation: This error is returned by `bpcoord` when it cannot find a robot on which to read a particular media id containing a backup image(s) to be synthesized. The message logged by `bpcoord` includes the media id. This error should not occur.

Recommended Action: Contact customer support and provide appropriate logs. Please refer to the section on [“Logs To Accompany Problem Reports for Synthetic Backup”](#) in the chapter on [“Using Logs and Reports”](#) for a complete list of logs and configuration information to provide.

NetBackup Status Code: 607

Message: no images were found to synthesize

Explanation: The database query to obtain the images to synthesize for the given policy returned 0 images.

Recommended Action: Ensure that for a synthetic full backup there is one full image (real or synthetic) and one or more subsequent incremental images (differential or cumulative) to synthesize. For a cumulative synthetic backup, there must be 2 or more incremental (differential or cumulative) images to synthesize. Adjust your schedules so the appropriate backup jobs complete successfully before the synthetic job is run. The scheduler will not retry a synthetic backup job that fails with this error code.

NetBackup Status Code: 608

Message: storage unit query failed

Explanation: The database query to obtain all storage units failed.

Recommended Action: Please verify the `bpdbm` process is running and no errors have been logged to the NetBackup error log. Restart the `bpdbm` process (on UNIX), or the NetBackup Database Manager Service (on NT) and retry the synthetic backup job. If the problem persists, please contact customer support and send the appropriate logs. Please refer to the section on [“Logs To Accompany Problem Reports for Synthetic Backup”](#) in the chapter on [“Using Logs and Reports”](#) for a complete list of logs and configuration information to provide.

NetBackup Status Code: 609

Message: reader failed

Explanation: The `bptm/bpdm` reader process terminated with an error.

Recommended Action: Please refer to the NetBackup error log for errors logged by `bpcoord` and `bptm/bpdm` reader. The error message should contain the actual error reported by the `bptm/bpdm` reader. Please refer to the NetBackup troubleshooting guide for information on the error reported by the `bptm/bpdm` reader. It is possible that the media is missing or is bad or the drive used for reading the media is bad. If the problem persists, please contact customer support and send appropriate logs. Please refer to the section on [“Logs To Accompany Problem Reports for Synthetic Backup”](#) in the chapter on [“Using Logs and Reports”](#) for a complete list of logs and configuration information to provide.

NetBackup Status Code: 610

Message: end point terminated with an error

Explanation: An error indication was received on the connection to the `bptm/bpdm` process.

Recommended Action: Please review the errors logged by `bpcoord` and `bptm/bpdm` process in the NetBackup error log. Refer to the debug logs for these processes for more information. The connection could have been broken due to an error condition detected by the `bptm/bpdm` process or due to network problems between the master and the



media server. Check the network connectivity between the master and media server. Retry the job and if the problem persists, please contact customer support and send the appropriate logs. Please refer to the section on [“Logs To Accompany Problem Reports for Synthetic Backup”](#) in the chapter on [“Using Logs and Reports”](#) for a complete list of logs and configuration information to provide.

NetBackup Status Code: 611

Message: no connection to reader

Explanation: A connection to the `bptm/bpdm` reader process does not exist to communicate with the reader.

Recommended Action: This error should not occur. Please submit a problem report along with the appropriate logs. Please refer to the section on [“Logs To Accompany Problem Reports for Synthetic Backup”](#) in the chapter on [“Using Logs and Reports”](#) for a complete list of logs and configuration information to provide.

NetBackup Status Code: 612

Message: cannot send extents to `bpsynth`

Explanation: The `bpcoord` process cannot send extents message to `bpsynth`. The `bpsynth` process may have terminated or the two processes are unable to communicate due to system problems.

Recommended Action: Examine the NetBackup error log for errors logged by `bpsynth` and `bpcoord`. Refer to the debug logs for these processes for more information. If the problem persists, please contact customer support and send appropriate logs. Please refer to the section on [“Logs To Accompany Problem Reports for Synthetic Backup”](#) in the chapter on [“Using Logs and Reports”](#) for a complete list of logs and configuration information to provide.

NetBackup Status Code: 613

Message: cannot connect to read media server

Explanation: The `bpcoord` process was unable to connect to the media server to read a backup image.

Recommended Action: Ensure that network connectivity exists between the master server and the specified media server. Examine the NetBackup error log for error messages logged by `bpsynth` and `bpcoord`. For more information, please refer to the debug logs for `bpsynth`, `bpcoord` on the master server and `bpcd` and `bptm/bpdm` on the media server. Please refer to the section on [“Logs To Accompany Problem Reports for Synthetic Backup”](#) in the chapter on [“Using Logs and Reports”](#) for a complete list of logs and configuration information to provide.

NetBackup Status Code: 614

Message: cannot start reader on the media server

Explanation: The `bpcoord` process was unable to start the `bptm/bpdm` process to read a backup image to be synthesized.

Recommended Action:

- ◆ Examine the NetBackup error log for errors logged by `bpcoord` and `bpsynth`. For more information, please refer to the debug logs for `bpsynth`, `bpcoord` on the master server and for `bpcd` and `bptm/bpdm` on the media server. Ensure that the `bptm/bpdm` binaries on the media server are executable and are not corrupt. Try executing `bptm/bpdm` commands locally on the media server to ensure that the binary is executable and not corrupt. For instance you can execute the following command

```
/bp/bin/bptm -count -rn 0 -rt 8
```

where robot number is 0 and the robot type is 8. The robot type corresponding to the robot number can be taken from the command line logged in the debug log for `bptm`. The above command will display the counts for the up, shared and assigned drives in the robot. Please refer to the section on [“Logs To Accompany Problem Reports for Synthetic Backup”](#) in the chapter on [“Using Logs and Reports”](#) for a complete list of logs and configuration information to provide.

NetBackup Status Code: 615

Message: internal error 615

Explanation: This error should not occur.

Recommended Action: Please submit a problem report along with appropriate logs. Please refer to the section on [“Logs To Accompany Problem Reports for Synthetic Backup”](#) in the chapter on [“Using Logs and Reports”](#) for a complete list of logs and configuration information to provide.

NetBackup Status Code: 616

Message: internal error 616

Explanation: This error should not occur.

Recommended Action: Please submit a problem report along with appropriate logs. Please refer to the section on [“Logs To Accompany Problem Reports for Synthetic Backup”](#) in the chapter on [“Using Logs and Reports”](#) for a complete list of logs and configuration information to provide.



NetBackup Status Code: 617

Message: no drives available to start the reader process

Explanation: There are no drives available to start the bptm process to read a backup image to be synthesized.

Recommended Action: Ensure that sufficient drives are available before re-starting the job.

NetBackup Status Code: 618

Message: internal error 618

Explanation: This error should not occur.

Recommended Action: Contact customer support and send the appropriate logs. Please refer to the section on [“Logs To Accompany Problem Reports for Synthetic Backup”](#) in the chapter on [“Using Logs and Reports”](#) for a complete list of logs and configuration information to provide.

NetBackup Status Code: 619

Message: internal error 619

Explanation: This error should not occur.

Recommended Action: Contact customer support and send the appropriate logs. Please refer to the section on [“Logs To Accompany Problem Reports for Synthetic Backup”](#) in the chapter on [“Using Logs and Reports”](#) for a complete list of logs and configuration information to provide.

NetBackup Status Code: 620

Message: internal error 620

Explanation: This error should not occur.

Recommended Action: Contact customer support and send the appropriate logs. Please refer to the section on [“Logs To Accompany Problem Reports for Synthetic Backup”](#) in the chapter on [“Using Logs and Reports”](#) for a complete list of logs and configuration information to provide.

NetBackup Status Code: 621

Message: unable to connect to bpcoord

Explanation: The bpsynth process was unable to connect to bpcoord.

Recommended Action:

- ◆ Please refer to the NetBackup error log for errors logged by `vnetd`, `bpsynth` and `bpcoord`. For more information, refer to the debug logs for `vnetd`, `bpsynth` and `bpcoord`. Ensure that `vnetd` and `bpcoord` are running. Verify connectivity to `vnetd` by issuing the following command on the master server:

```
telnet <hostname> vnetd
```

You should get the normal telnet response. For instance, if `vnetd` is running on master server wine:

```
telnet wine vnetd
Trying 11.83.56.70...
Connected to wine.storagewiz.com.
Escape character is '^]'
^]
```

```
telnet> quit
Connection closed.
```

If you do not get the above response to the telnet command, restart NetBackup on Windows and on UNIX kill `vnetd` and rerun the synthetic backup job. If the problem persists, contact customer support and provide appropriate logs. Please refer to the section on [“Logs To Accompany Problem Reports for Synthetic Backup”](#) in the chapter on [“Using Logs and Reports”](#) for a complete list of logs and configuration information to provide.

NetBackup Status Code: 622

Message: connection to the peer process does not exist

Explanation: The underlying connection to the peer `bpdm/bpdm` process does not exist. This error should not occur.

Recommended Action: Contact customer support and send appropriate logs. Please refer to the section on [“Logs To Accompany Problem Reports for Synthetic Backup”](#) in the chapter on [“Using Logs and Reports”](#) for a complete list of logs and configuration information to provide.

NetBackup Status Code: 623

Message: execution of a command in a forked process failed

Explanation: The failure normally occurs during the execution of a command on a media server via `bpcd`. Examine the NetBackup error log for additional error messages. Also refer to the debug logs for `bpsynth` (on the master server) and `bpcd` (on the media server) to get an explanation of the failure. A common cause of the failure is insufficient memory, file system full or insufficient swap space.



Recommended Action: Retry the job and if the problem persists, contact customer support and send appropriate logs. Please refer to the section on [“Logs To Accompany Problem Reports for Synthetic Backup”](#) in the chapter on [“Using Logs and Reports”](#) for a complete list of logs and configuration information to provide.

NetBackup Status Code: 624

Message: unable to send a start command to a reader/writer process on media server

Explanation: The `bpsynth` or `bpcoord` process is unable to send a command to the `bptm/bpdm` process on the media server.

Recommended Action: Ensure that the network connectivity exists between the master and the media server. Look for additional error messages in the NetBackup error log. More detailed information is present in the debug logs for `bpsynth`, `bpcoord` (on master server) and `bptm/bpdm` on the media server. If the problem persists, please contact customer support and send appropriate logs. Please refer to the section on [“Logs To Accompany Problem Reports for Synthetic Backup”](#) in the chapter on [“Using Logs and Reports”](#) for a complete list of logs and configuration information to provide.

NetBackup Status Code: 625

Message: data marshalling error

Explanation: Problems were encountered while sending data over the connection. This error should not occur.

Recommended Action: Please contact customer support and send appropriate logs. Please refer to the section on [“Logs To Accompany Problem Reports for Synthetic Backup”](#) in the chapter on [“Using Logs and Reports”](#) for a complete list of logs and configuration information to provide.

NetBackup Status Code: 626

Message: data un-marshalling error

Explanation: Problems were encountered in parsing messages received by `bpsynth` or `bpcoord`. This error should not occur.

Recommended Action: Contact customer support and send the appropriate logs. Please refer to the section on [“Logs To Accompany Problem Reports for Synthetic Backup”](#) in the chapter on [“Using Logs and Reports”](#) for a complete list of logs and configuration information to provide.

NetBackup Status Code: 627

Message: unexpected message received from `bpsynth`

Explanation: This error can occur if the `bpsynth` and `bpcoord` binaries are mis-matched or the messages are being corrupted during transfer over the connection between the two processes.

Recommended Action: Ensure that `bpsynth` and `bpcoord` binaries are for the same release. If matching binaries are used and the problem persists, please contact customer support and send appropriate logs. Please refer to the section on [“Logs To Accompany Problem Reports for Synthetic Backup”](#) in the chapter on [“Using Logs and Reports”](#) for a complete list of logs and configuration information to provide.

NetBackup Status Code: 628

Message: insufficient data received

Explanation: This error occurs when partial data is read from the input socket and cannot be parsed until the remaining data that comprises the message is read. This error is encountered by the lower layers and should not cause a process to be terminated.

Recommended Action: If this error causes the `bpsynth` or `bpcoord` binary to hang or malfunction, please contact customer support and send appropriate logs. Please refer to the section on [“Logs To Accompany Problem Reports for Synthetic Backup”](#) in the chapter on [“Using Logs and Reports”](#) for a complete list of logs and configuration information to provide.

NetBackup Status Code: 629

Message: no message was received from `bptm`

Explanation: This error is returned when no message is received from `bptm` process in response to the command or query executed via `bptm`.

Recommended Action: Look for additional error messages in the NetBackup error log and in the debug logs for `bpsynth`, `bpcoord` on the master server and `bptm` on the media server. There might be a system condition (like insufficient memory, file system full, insufficient swap space) on the media server preventing `bptm` process from sending the response. Verify the network connectivity between the master and the media server. If no explanation is found for the failure and the problem persists, please contact customer support and send appropriate logs. Please refer to the section on [“Logs To Accompany Problem Reports for Synthetic Backup”](#) in the chapter on [“Using Logs and Reports”](#) for a complete list of logs and configuration information to provide.

NetBackup Status Code: 630

Message: unexpected message was received from `bptm`

Explanation: This error should not occur.



Recommended Action: Please contact customer support and send appropriate logs. Please refer to the section on [“Logs To Accompany Problem Reports for Synthetic Backup”](#) in the chapter on [“Using Logs and Reports”](#) for a complete list of logs and configuration information to provide.

NetBackup Status Code: 631

Message: received an error from bptm request to suspend media

Explanation: The `bpcoord` process was unable to suspend a media containing one or more images to be synthesized. The error message in the NetBackup error log flags the media that was not suspended by giving it's ordinal in the list of media ids to be suspended.

Recommended Action: Examine the `bptm` debug log for more information on the reason for the suspend failure. The `bpcoord` process will ignore this error and continue processing. It has the potential of failing later if the media with the images to be read gets assigned to another backup or restore job. If the synthetic backup job failed, fix the condition that lead to the suspend failure and retry the job.

NetBackup Status Code: 632

Message: received an error from bptm request to un-suspend media

Explanation: The `bpsynth` process was unable to un-suspend a media that had been suspended by `bpcoord` at the start of the synthetic backup job. The error message in the NetBackup error log flags the media that was not un-suspended by giving it's ordinal in the list of media ids to be un-suspended.

Recommended Action: Look at the debug log for `bptm` process on the media server for an explanation of the un-suspend failure and the media id. Try un-suspending the tape by hand via the `bpmedia` command.

NetBackup Status Code: 633

Message: unable to listen and register service via vnetd

Explanation: The `bpcoord` process was unable to start listening for incoming connections.

Recommended Action:

- ◆ Look at the NetBackup error log for messages logged by `vnetd` and `bpcoord`. More detailed information is available in the debug logs for `vnetd` and `bpcoord` that will help isolate and resolve the problem. Ensure `vnetd` is running. Verify connectivity to `vnetd` by issuing the following command on the master server:

```
telnet <hostname> vnetd
```

You should get the normal telnet response. For instance, if `vnetd` is running on master server wine:

```
telnet wine vnetd

Trying 11.83.56.70...
Connected to wine.storagewiz.com.
Escape character is '^]'
^]

telnet> quit
Connection closed.
```

If you do not get the above response to the telnet command, restart NetBackup on the Windows master server and on the UNIX master server kill `vnetd` and rerun the synthetic backup job. If the problem persists, contact customer support and provide appropriate logs. Please refer to the section on [“Logs To Accompany Problem Reports for Synthetic Backup”](#) in the chapter on [“Using Logs and Reports”](#) for a complete list of logs and configuration information to provide.

NetBackup Status Code: 634

Message: no drives available to start the writer process

Explanation: The `bpcoord` process could not start the synthetic backup job as there were no drives available in the target storage unit for the writer. There may be a restore or another synthetic backup job using the storage unit.

Recommended Action: Ensure that the target storage unit configured for the synthetic backup schedule has at least one drive available to write the synthetic backup image.

NetBackup Status Code: 635

Message: unable to register handle with the reactor

Explanation: Unable to register a handle with the ACE reactor to monitor events on the handle. This error can occur in `bpsynth` and `bpcoord`.

Recommended Action: Examine NetBackup error log for any errors logged for the job. Refer to the debug logs for `bpsynth` and `bpcoord` for more information. Retry the synthetic backup job. If the problem persists, contact customer support and send the appropriate logs. Please refer to the section on [“Logs To Accompany Problem Reports for Synthetic Backup”](#) in the chapter on [“Using Logs and Reports”](#) for a complete list of logs and configuration information to provide.

NetBackup Status Code: 636

Message: read from input socket failed



Explanation: The read from an input socket failed. The underlying connection has been broken.

Recommended Action: The `bpsynth` or `bpcoord` process encountered an error while reading from an input socket. The socket may be between `bpsynth` and `bpcoord` or between `bpsynth` and `bptm/bpdm` or between `bpcoord` and `bptm/bpdm` process. The `errno` logged to the NetBackup error log will indicate the reason for the failure. Refer to the debug log for `bpsynth`, `bpcoord` (on the master server) and the `bptm/bpdm` reader/writer processes (on the media server) for more information. Check the network connectivity between the master and media server. Rerun the synthetic backup job. If the problem persists, contact customer support and send appropriate logs. Please refer to the section on [“Logs To Accompany Problem Reports for Synthetic Backup”](#) in the chapter on [“Using Logs and Reports”](#) for a complete list of logs and configuration information to provide.

NetBackup Status Code: 637

Message: write on output socket failed

Explanation: The write to an output socket failed. The underlying connection has been broken.

Recommended Action: The `bpsynth` or `bpcoord` process encountered an error while writing to an output socket. The socket may be between `bpsynth` and `bpcoord` or between `bpsynth` and `bptm/bpdm` process or between `bpcoord` and `bptm/bpdm` process. The `errno` logged to the NetBackup error log will indicate the reason for the failure. Refer to the debug log for `bpsynth`, `bpcoord` (on the master server) and the `bptm/bpdm` reader/writer processes (on the media server) for more information. Check the connectivity between the master and media server. Retry the synthetic backup job. If the problem persists, contact customer support and send appropriate logs. Please refer to the section on [“Logs To Accompany Problem Reports for Synthetic Backup”](#) in the chapter on [“Using Logs and Reports”](#) for a complete list of logs and configuration information to provide.

NetBackup Status Code: 638

Message: invalid arguments specified

Explanation: The `bpsynth` command fails with this error code if incorrect arguments have been specified.

Recommended Action: Please refer to the `bpsynth` command line arguments (via `-help`) for the correct argument specification. If the synthetic backup job has been started manually via the command line, please correct the arguments to `bpsynth` and rerun the job. If, however, the synthetic backup job has been started via the console or is scheduled, ensure that the `bpsynth` and `bpsched` binaries match the installed version of NetBackup.

NetBackup Status Code: 639

Message: specified policy does not exist

Explanation: The policy specified on the `bpsynth` command does not exist in the database. The `bpsynth` command was either invoked via the command line or if invoked via `bpsched`, the policy may have been deleted after `bpsched` had started `bpsynth` and before `bpsynth` issued the database query.

Recommended Action: If `bpsynth` is invoked via the command line, please rerun the command for an existing policy. If the synthetic backup job had been scheduled or started via the NetBackup Administration console (via manual start) and the policy exists in the configuration as displayed via the `bppllist` command and the problem persists, please contact customer support and send appropriate logs. Please refer to the section on [“Logs To Accompany Problem Reports for Synthetic Backup”](#) in the chapter on [“Using Logs and Reports”](#) for a complete list of logs and configuration information to provide.

NetBackup Status Code: 640

Message: specified schedule was not found

Explanation: The schedule specified on the `bpsynth` command did not exist in the specified policy definition in the database. The `bpsynth` command was either invoked via the command line or the specified schedule may have been deleted from the policy after `bpsynth` was started by `bpsched` and before `bpsynth` issued the database query.

Recommended Action: If `bpsynth` was invoked via the command line, please rerun the command with the correct synthetic schedule label defined in the policy for which synthetic backup job is being run. If the synthetic backup job had been scheduled or started via the NetBackup Administration console, define a new schedule in the policy and retry the job. If the problem persists, please contact customer support and send appropriate logs. Please refer to the section on [“Logs To Accompany Problem Reports for Synthetic Backup”](#) in the chapter on [“Using Logs and Reports”](#) for a complete list of logs and configuration information to provide.

NetBackup Status Code: 641

Message: invalid media type specified in the storage unit

Explanation: The media type specified in the target storage unit is invalid for synthetic backup. Synthetic Backup images can only be written to disk, disk staging, and Media Manager type of storage units.

Recommended Action: Ensure that the target storage unit configured for synthetic backup is a disk, disk staging, or Media Manager type (not NDMP type). Re-run synthetic backup with the appropriate storage unit.



NetBackup Status Code: 642

Message: duplicate backup images were found

Explanation: The database query returned duplicate backup ids. This error should not occur.

Recommend Action: Please contact customer support and send appropriate logs. Please refer to the section on [“Logs To Accompany Problem Reports for Synthetic Backup”](#) in the chapter on [“Using Logs and Reports”](#) for a complete list of logs and configuration information to provide.

NetBackup Status Code: 643

Message: unexpected message received from bpcoord

Explanation: An unexpected message was received by bpsynth from bpcoord.

Recommended Action: This error can occur if you have mismatched (different versions) bpsynth and bpcoord binaries. This error should not occur with binaries from the same release. In the latter case, please contact customer support and send appropriate logs. Please refer to the section on [“Logs To Accompany Problem Reports for Synthetic Backup”](#) in the chapter on [“Using Logs and Reports”](#) for a complete list of logs and configuration information to provide.

NetBackup Status Code: 644

Message: extent directive contained an unknown media id

Explanation: This extent directive received by bpsynth from bpcoord contained an unknown media id. This error should not occur.

Recommended Action: Please contact customer support and send appropriate logs. Please refer to the section on [“Logs To Accompany Problem Reports for Synthetic Backup”](#) in the chapter on [“Using Logs and Reports”](#) for a complete list of logs and configuration information to provide.

NetBackup Status Code: 645

Message: unable to start the writer on the media server

Explanation: The bpsynth process was unable to start the bptm/bpdm process on the media server associated with the target storage unit to write the synthetic image.

Recommended Action:

- ◆ Examine the NetBackup error log for messages logged by bpsynth. For more information, refer to the debug logs for bpsynth on the master server and for bpcd and bptm/bpdm on the media server. Ensure that the bptm/bpdm binaries on the

media server are executable and are not corrupt. Try executing `bptm/bpdm` commands locally on the media server to ensure that the binary is executable and not corrupt. For instance, you can execute the following command:

```
<install_path>/netbackup/bin/bptm -count -rn 0 -rt 8
```

where robot number is 0 and robot type is 8. The robot type corresponding to the robot number can be taken from the command line logged in the debug log for `bptm`. The above command will display the counts for the up, shared, and assigned drives in the robot. In case the synthetic image is to be written to a disk storage unit, verify the `bpdm` binary by executing the following command:

```
<install_path>/netbackup/bin/bpdm
```

and it should print out “`bpdm: media manager operation not specified`”. Retry the synthetic backup job. If the problem persists, please contact customer support and send appropriate logs. Please refer to the section on “[Logs To Accompany Problem Reports for Synthetic Backup](#)” in the chapter on “[Using Logs and Reports](#)” for a complete list of logs and configuration information to provide.

NetBackup Status Code: 646

Message: unable to get the address of the local listen socket

Explanation: The `bpsynth` process was unable to obtain the address of the listen socket opened to receive incoming connections from the `bptm/bpdm` processes started to read the source images. This problem should not happen. The library call used to retrieve the address of the listen socket relies on the underlying system call to obtain the socket address. The `errno` reported by the system call is included in the error message and should help in diagnosing the problem.

Recommended Action: Rerun the synthetic backup job. If the problem persists, contact customer support and send appropriate logs. Please refer to the section on “[Logs To Accompany Problem Reports for Synthetic Backup](#)” in the chapter on “[Using Logs and Reports](#)” for a complete list of logs and configuration information to provide.

NetBackup Status Code: 647

Message: validation of synthetic image failed

Explanation: This error is returned when `bpsynth` receives an error from the database call to validate the synthetic image.

Recommended Action: This error may indicate a problem in the synthetic backup process. Examine the NetBackup error log for any messages logged by `bpsynth`, `bpcoord`, and `bptm/bpdm` processes. Look at the debug logs for all these processes for additional information. If you cannot resolve the problem, contact customer support and



send appropriate logs. Please refer to the section on [“Logs To Accompany Problem Reports for Synthetic Backup”](#) in the chapter on [“Using Logs and Reports”](#) for a complete list of logs and configuration information to provide.

NetBackup Status Code: 648

Message: unable to send extent message to `bpcoord`

Explanation: The `bpsynth` process was unable to send the extent information to `bpcoord`. This problem could have been caused by insufficient memory, file system full, or insufficient swap space on the system.

Recommended Action: This error indicates a communication problem between `bpsynth` and `bpcoord`. Check if `bpcoord` is running. If `bpcoord` has terminated, look for a core file. Examine the NetBackup error log for any errors logged by `bpsynth` and `bpcoord` processes. Examine the debug logs for `bpsynth` and `bpcoord` for additional information. Rerun the synthetic backup job. If the problem persists, contact customer support and send appropriate logs. Please refer to the section on [“Logs To Accompany Problem Reports for Synthetic Backup”](#) in the chapter on [“Using Logs and Reports”](#) for a complete list of logs and configuration information to provide.

NetBackup Status Code: 649

Message: unexpected message received from BPXM

Explanation: The `bpsynth` process received an unexpected message from `bptm/bpdm` reader or writer process.

Recommended Action: This error should not happen. Contact customer support and send appropriate logs. Please refer to the section on [“Logs To Accompany Problem Reports for Synthetic Backup”](#) in the chapter on [“Using Logs and Reports”](#) for a complete list of logs and configuration information to provide.

NetBackup Status Code: 650

Message: unable to send extent message to BPXM

Explanation: The `bpsynth` process was unable to send the extent information to the `bptm/bpdm` process started to read a specified backup image to be synthesized.

Recommended Action: This error indicates a communication problem between `bpsynth` and `bptm/bpdm` reader process on the media server. Ensure that the media server is accessible and that the `bptm/bpdm` process is running on the media server. Examine the NetBackup error log for any errors logged by `bpsynth`, `bpcoord` (on the master server) and the `bptm/bpdm` reader processes (on the media server). Examine the debug logs for `bpsynth`, `bpcoord` and `bptm/bpdm` for additional information. Rerun the synthetic backup job. If the problem persists, contact customer support and send

appropriate logs. Please refer to the section on “[Logs To Accompany Problem Reports for Synthetic Backup](#)” in the chapter on “[Using Logs and Reports](#)” for a complete list of logs and configuration information to provide.

NetBackup Status Code: 651

Message: unable to issue the database query for policy

Explanation: The `bpsynth` process was unable to send the database query for policy.

Recommended Action: This error indicates a communication problem between `bpsynth` and `bpdbm`. Ensure that `bpdbm` is running and the `bpdbm` binary matches the installed NetBackup version. Examine the NetBackup error log for any errors logged by `bpdbm` and `bpsynth`. Examine the debug logs for `bpsynth` and `bpdbm` for additional information. Restart the `bpdbm` process (on UNIX) or the NetBackup Database Manager Service (on NT) and rerun the synthetic backup job. If the problem persists, contact customer support and send appropriate logs. Please refer to the section on “[Logs To Accompany Problem Reports for Synthetic Backup](#)” in the chapter on “[Using Logs and Reports](#)” for a complete list of logs and configuration information to provide.

NetBackup Status Code: 652

Message: unable to issue the database query for policy information

Explanation: The `bpsynth` process was unable to send the database query for detailed information about the policy.

Recommended Action: This error indicates a communication problem between `bpsynth` and `bpdbm`. Ensure that `bpdbm` is running. Examine the NetBackup error log for any errors logged by `bpdbm` and `bpsynth`. Examine the debug logs for `bpsynth` and `bpdbm` for additional information. Restart the `bpdbm` process (on UNIX) or the NetBackup Database Manager Service (on NT) and rerun the synthetic backup job. If the problem persists, contact customer support and send appropriate logs. Please refer to the section on “[Logs To Accompany Problem Reports for Synthetic Backup](#)” in the chapter on “[Using Logs and Reports](#)” for a complete list of logs and configuration information to provide.

NetBackup Status Code: 653

Message: unable to send a message to `bpccord`

Explanation: The `bpsynth` process was unable to send a message to `bpccord`.

Recommended Action: This error indicates a communication problem between `bpsynth` and `bpccord`. Check if `bpccord` is running and ensure that `bpsynth` and `bpccord` binaries match the NetBackup version. Examine the NetBackup error log for any errors logged by `bpsynth` and `bpccord`. Examine the debug logs for `bpsynth` and `bpccord` for additional information. Re-run the synthetic backup job. If the problem persists,



contact customer support and send appropriate logs. Please refer to the section on [“Logs To Accompany Problem Reports for Synthetic Backup”](#) in the chapter on [“Using Logs and Reports”](#) for a complete list of logs and configuration information to provide.

NetBackup Status Code: 654

Message: internal error 654

Explanation: This error should not happen

Recommended Action: Contact customer support and send appropriate logs. Please refer to the section on [“Logs To Accompany Problem Reports for Synthetic Backup”](#) in the chapter on [“Using Logs and Reports”](#) for a complete list of logs and configuration information to provide.

NetBackup Status Code: 655

Message: no target storage unit was specified via command line

Explanation: No target storage unit was specified on the `bpsynth` command line (`-S`).

Recommended Action: Rerun `bpsynth` with the target storage unit specified via the `-S` option.

NetBackup Status Code: 656

Message: unable to send start synth message to `bpcoord`

Explanation: The `bpsynth` process was unable to send the message to `bpcoord` to start synthetic backup.

Recommended Action: This error indicates a communication problem between `bpcoord` and `bpsynth`. It is possible that `bpcoord` has terminated or some system condition like insufficient memory is preventing the message from being sent. Examine the NetBackup error log for any errors logged by `bpsynth` and `bpcoord`. Refer to the debug logs for these processes for additional information. Re-run the synthetic backup job. If the problem persists, please contact customer support and send appropriate logs. Please refer to the section on [“Logs To Accompany Problem Reports for Synthetic Backup”](#) in the chapter on [“Using Logs and Reports”](#) for a complete list of logs and configuration information to provide.

NetBackup Status Code: 657

Message: unable to accept connection from the reader

Explanation: The `bpsynth` process was unable to accept the connection from the `bptm/bpdm` reader process running on the media server.

Recommended Action: Please examine the NetBackup error log for errors logged by `bpsynth` and `bptm/bpdm` reader process. The message logged by `bpsynth` includes the error (`errno`) reported by the system call. Refer to the debug logs for `bpsynth` on the master server and `bptm/bpdm` process on the media servers for more information. Ensure that network connectivity exists between the master and media servers. If the problem persists, please contact customer support and send appropriate logs. Please refer to the section on [“Logs To Accompany Problem Reports for Synthetic Backup”](#) in the chapter on [“Using Logs and Reports”](#) for a complete list of logs and configuration information to provide.

NetBackup Status Code: 658

Message: unable to accept connection from the writer

Explanation: The `bpsynth` process was unable to accept the connection from the `bptm/bpdm` writer process running on the media server.

Recommended Action: Examine the NetBackup error log for errors logged by `bpsynth` and the `bptm/bpdm` writer process. The message logged by `bpsynth` includes the error (`errno`) reported by the system call. Also refer to the debug logs for `bpsynth` on the master server and `bptm/bpdm` process on the media server for more information. Ensure that network connectivity exists between the master and media servers. If the problem persists, please contact customer support and send appropriate logs. Please refer to the section on [“Logs To Accompany Problem Reports for Synthetic Backup”](#) in the chapter on [“Using Logs and Reports”](#) for a complete list of logs and configuration information to provide.

NetBackup Status Code: 659

Message: unable to send a message to the writer child process

Explanation: The `bpsynth` process was unable to send the message containing the hostname and port number of the `bptm/bpdm` reader, to the `bptm/bpdm` writer.

Recommended Action: Please examine the NetBackup error log for errors logged by `bpsynth` and the `bptm/bpdm` writer process. Also refer to the debug logs for `bpsynth` on the master server and `bptm/bpdm` process on the media server for more information. Ensure that network connectivity exists between the master and media servers. If the problem persists, please contact customer support and send appropriate logs. Please refer to the section on [“Logs To Accompany Problem Reports for Synthetic Backup”](#) in the chapter on [“Using Logs and Reports”](#) for a complete list of logs and configuration information to provide.

NetBackup Status Code: 660

Message: specified target storage unit was not found in the database



Explanation: The `bpsynth` process was unable to find the specified target storage unit in the database. The storage unit configured in the policy for synthetic backup has been deleted from the database.

Recommended Action: Please configure an existing storage unit for synthetic backup in the policy and retry the synthetic backup job.

NetBackup Status Code: 661

Message: unable to send exit message to the BPXM reader

Explanation: The `bpsynth` process was unable to send the exit message to indicate the end of extents messages to the `bptm/bpdm` reader process on the media server. It is possible that the network connection between the master and media server has terminated or that the `bptm/bpdm` reader process has terminated.

Recommended Action: Check the network connectivity between the master and media server. Examine the NetBackup error log for any errors logged by `bpsynth` and `bptm/bpdm` reader process. Examine the debug logs for `bpsynth` on the master server and `bptm/bpdm` reader process on the media servers for more detailed information. If the problem persists, please contact customer support and provide the appropriate logs. Please refer to the section on [“Logs To Accompany Problem Reports for Synthetic Backup”](#) in the chapter on [“Using Logs and Reports”](#) for a complete list of logs and configuration information to provide.

NetBackup Status Code: 662

Message: unknown image referenced in the synth context message from BPXM

Explanation: The `bpsynth` process received an extent message from the `bptm/bpdm` reader with a reference to a media id that was not known to `bpsynth`. This error should not occur.

Recommended Action: Please contact customer support and provide the appropriate logs. Please refer to the section on [“Logs To Accompany Problem Reports for Synthetic Backup”](#) in the chapter on [“Using Logs and Reports”](#) for a complete list of logs and configuration information to provide.

NetBackup Status Code: 663

Message: image does not have a fragment map

Explanation: The `bpsynth` process received an image without a fragment map from `bpdbm`. This error should not occur.

Recommended Action: Please contact customer support and provide the appropriate logs. Please refer to the section on [“Logs To Accompany Problem Reports for Synthetic Backup”](#) in the chapter on [“Using Logs and Reports”](#) for a complete list of logs and configuration information to provide.

NetBackup Status Code: 664

Message: zero extents in the synthetic image, cannot proceed

Explanation: The `bpsynth` process received zero extents from `bpdbm`. This error should not occur.

Recommended Action: Please contact customer support and provide the appropriate logs. Please refer to the section on [“Logs To Accompany Problem Reports for Synthetic Backup”](#) in the chapter on [“Using Logs and Reports”](#) for a complete list of logs and configuration information to provide.

NetBackup Status Code: 665

Message: termination requested by `bpcoord`

Explanation: The `bpsynth` process received the termination notice from `bpcoord`. This indicates an error condition encountered by `bpcoord`. It is possible that a `bptm/bpdm` reader process on the media server encountered an error either with the network or the media or the drive used to read the media.

Recommended Action: Examine the NetBackup error log and the debug logs for `bpcoord` and possibly the `bptm/bpdm` reader processes on the media server for information about the error condition. Correct the problem and retry the synthetic backup job. If the problem persists, please contact customer support and provide appropriate logs. Refer to [Logs To Accompany Problem Reports for Synthetic Backup](#) in the [Using Logs and Reports](#) chapter for more information on logging.

NetBackup Status Code: 667

Message: unable to open pipe between `bpsynth` and `bpcoord`

Explanation: The `bpsynth` process was unable to open a pipe to `bpcoord` process.

Recommended Action: Ensure that the `bpcoord` binary is installed in the `<install_path>/netbackup/bin` directory and is executable. Try executing it manually to ensure that the binary is not corrupt. Also ensure that the `bpsynth` and `bpcoord` binaries match the NetBackup system. Examine the NetBackup error log for the actual error message logged by `bpsynth`. The error message will contain the error code (`errno`) returned by the system call. If the problem persists, please contact customer support and provide appropriate logs. Please refer to the section on [“Logs To Accompany Problem Reports for Synthetic Backup”](#) in the chapter on [“Using Logs and Reports”](#) for a complete list of logs and configuration information to provide.



NetBackup Status Code: 668

Message: pipe fgets call from bpcoord failed

Explanation: The `bpsynth` process was unable to read the message from the pipe connected to `bpcoord`. The `bpcoord` process may have terminated or some system condition may prevent the message to be sent from `bpcoord` to `bpsynth`.

Recommended Action: Ensure that the `bpcoord` binary is installed in the `/<install_path>/netbackup/bin` directory and is executable. Try executing it manually to ensure that the binary is not corrupt. Also ensure that the `bpsynth` and `bpcoord` binaries match the NetBackup system. Examine the NetBackup error log for the error logged by `bpsynth` and `bpcoord`. The message logged by `bpsynth` contains the error code (*errno*) returned by the underlying system call. The system error code (*errno*) should help in identifying the real problem. If the problem persists, please contact customer support and provide appropriate logs. Please refer to the section on [“Logs To Accompany Problem Reports for Synthetic Backup”](#) in the chapter on [“Using Logs and Reports”](#) for a complete list of logs and configuration information to provide.

NetBackup Status Code: 669

Message: bpcoord startup validation failure

Explanation: The `bpsynth` process was unable to complete the handshake with `bpcoord` at startup.

Recommended Action: Examine the NetBackup error log and the debug logs for `bpsynth` and `bpcoord` for more information. Ensure that the `bpsynth` and `bpcoord` binaries match the installed NetBackup version. The error message in the log will contain the error code (*errno*) returned by the underlying system call. The error code will help in diagnosing the problem. If the problem persists, please call customer support and provide the appropriate logs. Please refer to the section on [“Logs To Accompany Problem Reports for Synthetic Backup”](#) in the chapter on [“Using Logs and Reports”](#) for a complete list of logs and configuration information to provide.

NetBackup Status Code: 670

Message: send buffer is full

Explanation: This error should not occur.

Recommended Action: Please contact customer support and provide the appropriate logs. Please refer to the section on [“Logs To Accompany Problem Reports for Synthetic Backup”](#) in the chapter on [“Using Logs and Reports”](#) for a complete list of logs and configuration information to provide.

Messages

This section lists the NetBackup error messages alphabetically. The status code is included in parentheses after the message. Refer to the previous list of status codes for explanations and recommended actions.

/usr/opensv/netbackup/bp.conf not found

(NetBackup Status Code 110)

a protocol error has occurred

(NetBackup Status Code 232)

access to server backup restore manager denied

(NetBackup Status Code 206)

access to the client was not allowed

(NetBackup Status Code 59)

a child process failed for an unknown reason

(NetBackup Status Code 258)

afs/dfs command failed

(NetBackup Status Code 78)

all volumes are not available to eject

(NetBackup Status Code 297)

allocation failed

(NetBackup Status Code 10)

an entry in the filelist expanded to too many characters

(NetBackup Status Code 70)

an error occurred when calling vltcore

(NetBackup Status Code 289)



an exception condition occurred

(NetBackup Status Code 600)

an extension package is needed but was not installed

(NetBackup Status Code 9)

an invalid entry was encountered

(NetBackup Status Code 223)

another NB database backup is already in progress

(NetBackup Status Code 125)

archive file removal failed

(NetBackup Status Code 4)

a session is already running for this vault

(NetBackup Status Code 275)

attempt to open a log file failed

(NetBackup Status Code 288)

authentication failed

(NetBackup Status Code 160)

Backup Exec operation failed

(NetBackup Status Code 151)

backup restore manager failed to read the file list

(NetBackup Status Code 53)

backups are not allowed to span media

(NetBackup Status Code 166)

bpcoord startup validation failure

(NetBackup Status Code 669)

bpjava-msvc: the client is not compatible with this server version (*server_version*)

(NetBackup Status Code 513)

bpstart_notify failed

(NetBackup Status Code 73)

can't connect to client

(NetBackup Status Code 58)

cannot connect on socket

(NetBackup Status Code 25)

cannot connect to read media server

(NetBackup Status Code 613)

cannot connect to server backup restore manager

(NetBackup Status Code 205)

Can not connect to the NB-Java authentication service on the configured port - *configured_port_number*

(NetBackup Status Code 505)

Can not connect to the NB-Java user service on port *port_number*

(NetBackup Status Code 506)

Can not connect to the NB-Java user service via VNETD on (host) or port (*configured_port_number*)

(NetBackup Status Code 517)

cannot create log file

(NetBackup Status Code 257)



Can not execute program

(NetBackup Status Code 509)

cannot find configuration database record for requested NB database backup

(NetBackup Status Code 120)

cannot find requested volume pool in Media Manager volume database

(NetBackup Status Code 167)

cannot find robot in vault configuration file

(NetBackup Status Code 323)

cannot find robot, vault, or profile in the vault configuration

(NetBackup Status Code 266)

cannot find the local host name

(NetBackup Status Code 267)

cannot find vault in vault configuration file

(NetBackup Status Code 322)

cannot get a bound socket

(NetBackup Status Code 146)

cannot make required directory

(NetBackup Status Code 35)

cannot overwrite media, data on it is protected

(NetBackup Status Code 168)

cannot perform specified media import operation

(NetBackup Status Code 176)

cannot position to correct image

(NetBackup Status Code 94)

cannot read backup header, media may be corrupted

(NetBackup Status Code 173)

cannot read media header, may not be NetBackup media or is corrupted

(NetBackup Status Code 172)

cannot register handler for accepting new connections

(NetBackup Status Code 603)

cannot send extents to bpsynth

(NetBackup Status Code 612)

cannot set non blocking mode on the listen socket

(NetBackup Status Code 602)

cannot start reader on the media server

(NetBackup Status Code 614)

Can not write file

(NetBackup Status Code 508)

child process killed by signal

(NetBackup Status Code 27)

client backup failed to read the file list

(NetBackup Status Code 67)

client backup failed to receive the CONTINUE BACKUP message

(NetBackup Status Code 66)



client backup was not attempted

(NetBackup Status Code 195)

client backup was not attempted because backup window closed

(NetBackup Status Code 196)

client cannot read the mount table

(NetBackup Status Code 60)

client connection refused

(NetBackup Status Code 57)

client did not start

(NetBackup Status Code 49)

client hostname could not be found

(NetBackup Status Code 48)

client is not validated to perform the requested operation

(NetBackup Status Code 135)

client is not validated to use the server

(NetBackup Status Code 131)

client name mismatch

(NetBackup Status Code 39)

client process aborted

(NetBackup Status Code 50)

client timed out reading file

(NetBackup Status Code 76)

client timed out waiting for bpend_notify to complete

(NetBackup Status Code 75)

client timed out waiting for bstart_notify to complete

(NetBackup Status Code 74)

client timed out waiting for the continue message from the media manager

(NetBackup Status Code 65)

client timed out waiting for the file list

(NetBackup Status Code 68)

client's network is unreachable

(NetBackup Status Code 56)

client/server handshaking failed

(NetBackup Status Code 26)

communication interrupted

(NetBackup Status Code 234)

connection refused by server backup restore manager

(NetBackup Status Code 204)

connection to the peer process does not exist

(NetBackup Status Code 622)

container cannot hold any media from the specified robot

(NetBackup Status Code 321)

container database close operation failed

(NetBackup Status Code 317)



container database lock operation failed

(NetBackup Status Code 318)

container database open operation failed

(NetBackup Status Code 319)

container database truncate operation failed

(NetBackup Status Code 314)

container does not exist in container database

(NetBackup Status Code 313)

container_id is not unique in container database

(NetBackup Status Code 316)

continue

(NetBackup Status Code 221)

could not deassign media due to Media Manager error

(NetBackup Status Code 177)

could not get group information

(NetBackup Status Code 38)

could not get passwd information

(NetBackup Status Code 30)

could not set group id for process

(NetBackup Status Code 32)

could not set user id for process

(NetBackup Status Code 31)

daemon fork failed

(NetBackup Status Code 148)

daemon is already running

(NetBackup Status Code 145)

data marshalling error

(NetBackup Status Code 625)

data un-marshalling error

(NetBackup Status Code 626)

Database backup failed

(NetBackup Status Code 294)

database system error

(NetBackup Status Code 220)

density is incorrect for the media id

(NetBackup Status Code 179)

disk is full

(NetBackup Status Code 155)

done

(NetBackup Status Code 222)

duplicate backup images were found

(NetBackup Status Code 642)

duplicate profile specified, use full robot/vault/profile

(NetBackup Status Code 305)



EC_badop

(NetBackup Status Code 113)

EC_end

(NetBackup Status Code 115)

EC_error

(NetBackup Status Code 114)

eject process could not obtain information about the robot

(NetBackup Status Code 295)

eject process failed to start

(NetBackup Status Code 292)

eject process has already been run for the requested vault session

(NetBackup Status Code 307)

eject process has been aborted

(NetBackup Status Code 293)

end point terminated with an error

(NetBackup Status Code 610)

error caused by invalid data in vault configuration file

(NetBackup Status Code 284)

error creating or getting message queue

(NetBackup Status Code 209)

error encountered attempting backup of catalog (multiple tape catalog backup)

(NetBackup Status Code 302)

error encountered executing Media Manager command

(NetBackup Status Code 303)

error getting information from volume database

(NetBackup Status Code 332)

error obtaining date of last backup for client

(NetBackup Status Code 207)

error occurred during initialization, check configuration file

(NetBackup Status Code 103)

error receiving information on message queue

(NetBackup Status Code 210)

error requesting media (tpreq)

(NetBackup Status Code 98)

error sending information on message queue

(NetBackup Status Code 212)

errors encountered, partial success

(NetBackup Status Code 306)

Evaluation software has expired. See www.veritas.com for ordering information

(NetBackup Status Code 161)

events out of sequence - image inconsistency

(NetBackup Status Code 229)

execution of a command in a forked process failed

(NetBackup Status Code 623)



execution of a vault notify script failed

(NetBackup Status Code 272)

execution of the specified system command returned a nonzero status

(NetBackup Status Code 77)

extent directive contained an unknown media id

(NetBackup Status Code 644)

failed accessing daemon lock file

(NetBackup Status Code 158)

failed appending to container database

(NetBackup Status Code 315)

failed attempting to copy (consolidated) report file

(NetBackup Status Code 287)

failed closing mail pipe

(NetBackup Status Code 102)

failed opening mail pipe

(NetBackup Status Code 101)

failed reading policy database information

(NetBackup Status Code 218)

failed reading global config database information

(NetBackup Status Code 215)

failed reading retention database information

(NetBackup Status Code 216)

failed reading storage unit database information

(NetBackup Status Code 217)

failed reading user directed filelist

(NetBackup Status Code 208)

failed trying to allocate memory

(NetBackup Status Code 36)

failed trying to exec a command

(NetBackup Status Code 29)

failed trying to fork a process

(NetBackup Status Code 28)

failed waiting for child process

(NetBackup Status Code 34)

failed while trying to send mail

(NetBackup Status Code 33)

fatal NB media database error

(NetBackup Status Code 91)

File already exists: *file_name*

(NetBackup Status Code 510)

file close failed

(NetBackup Status Code 15)

file does not exist

(NetBackup Status Code 142)



file open failed

(NetBackup Status Code 12)

file path specified is not absolute

(NetBackup Status Code 141)

file pathname exceeds the maximum length allowed

(NetBackup Status Code 105)

file read failed

(NetBackup Status Code 13)

file write failed

(NetBackup Status Code 14)

found no images or media matching the selection criteria

(NetBackup Status Code 190)

getservbyname failed

(NetBackup Status Code 19)

handshaking failed with server backup restore manager

(NetBackup Status Code 201)

host is unreachable

(NetBackup Status Code 47)

image does not have a fragment map

(NetBackup Status Code 663)

inadequate buffer space

(NetBackup Status Code 235)

Incorrect password

(NetBackup Status Code 504)

Incorrect server platform identifier

(NetBackup Status Code: 162)

insufficient data received

(NetBackup Status Code 628)

internal error 615

(NetBackup Status Code 615)

internal error 616

(NetBackup Status Code 616)

internal error 618

(NetBackup Status Code 618)

internal error 619

(NetBackup Status Code 619)

internal error 620

(NetBackup Status Code 620)

internal error 654

(NetBackup Status Code 654)

Internal error - a bad status packet was returned by NB-Java application server that did not contain an exit status code

(NetBackup Status Code 512)

invalid arguments specified

(NetBackup Status Code 638)



invalid command parameter

(NetBackup Status Code 20)

invalid command protocol

(NetBackup Status Code 143)

invalid command usage

(NetBackup Status Code 144)

invalid configuration for duplication to disk

(NetBackup Status Code 310)

invalid container database entry

(NetBackup Status Code 312)

invalid container description

(NetBackup Status Code 331)

invalid container id

(NetBackup Status Code 328)

invalid data found in retention map file for duplication

(NetBackup Status Code 324)

invalid date specified

(NetBackup Status Code: 109)

invalid file pathname

(NetBackup Status Code 104)

invalid file pathname found, cannot process request

(NetBackup Status Code 106)

invalid filelist specification

(NetBackup Status Code 69)

invalid jobID

(NetBackup Status Code 273)

invalid media type specified in the storage unit

(NetBackup Status Code 640)

**Invalid NBJAVA_CLIENT_PORT_WINDOW configuration option value:
(*option_value*)**

(NetBackup Status Code 519)

invalid recall status

(NetBackup Status Code 329)

invalid request

(NetBackup Status Code 133)

Invalid username

(NetBackup Status Code 503)

Invalid value for NB-Java configuration option (*option_name*): (*option_value*)

(NetBackup Status Code 520)

invalid volume database host

(NetBackup Status Code 330)

Iron Mountain report is already created for this session

(NetBackup Status Code 311)

licensed use has been exceeded

(NetBackup Status Code 159)



logic error encountered

(NetBackup Status Code 256)

main bpsched is already running

(NetBackup Status Code 244)

master server request failed

(NetBackup Status Code 149)

media block size changed prior to resume

(NetBackup Status Code 163)

media close error

(NetBackup Status Code 87)

media id is either expired or will exceed maximum mounts

(NetBackup Status Code 169)

media id is not in NetBackup volume pool

(NetBackup Status Code 178)

media id must be 6 or less characters

(NetBackup Status Code 171)

Media Manager device daemon (ltid) is not active

(NetBackup Status Code 80)

Media Manager volume daemon (vmd) is not active

(NetBackup Status Code 81)

media manager detected image that was not in tar format

(NetBackup Status Code 92)

media manager found wrong tape in drive

(NetBackup Status Code 93)

media manager killed by signal

(NetBackup Status Code 82)

media manager received no data for backup image

(NetBackup Status Code 90)

media manager - system error occurred

(NetBackup Status Code 174)

media open error

(NetBackup Status Code 83)

media position error

(NetBackup Status Code 86)

media read error

(NetBackup Status Code 85)

media write error

(NetBackup Status Code 84)

NB database backup failed, a path was not found or is inaccessible

(NetBackup Status Code 124)

NB database backup header is too large, too many paths specified

(NetBackup Status Code 126)

NB database recovery failed, a process has encountered an exceptional condition

(NetBackup Status Code 128)



NB image database contains no image fragments for requested backup id/copy number

(NetBackup Status Code 165)

NB-Java application server interface error: *Java exception*

(NetBackup Status Code 511)

NB-Java application server not accessible - maximum number of connections exceeded

(NetBackup Status Code 500)

NB-Java: bpjava-msvc is not compatible with this application version (*application_version*). You may try login to a different NetBackup host or exit the application. The remote NetBackup host will have to be configured with the same version of NetBackup as the host you started the application on.

(NetBackup Status Code 514)

NB-Java Configuration file (*file_name*) does not exist

(NetBackup Status Code 521)

NB-Java Configuration file (*file_name*) is not readable due to the following error: (*message*)

(NetBackup Status Code 522)

NDMP backup failure

(NetBackup Status Code 99)

network connection broken

(NetBackup Status Code 40)

network connection timed out

(NetBackup Status Code 41)

network read failed

(NetBackup Status Code 42)

network write failed

(NetBackup Status Code 44)

no active policies contain schedules of the requested type for this client

(NetBackup Status Code 198)

no active policies in the configuration database are of the correct client type

(NetBackup Status Code 246)

No authorization entry exists in the auth.conf file for username *username*. None of the NB-Java applications are available to you.

(NetBackup Status Code 502)

no connection to reader

(NetBackup Status Code 611)

no drives available to start the reader process

(NetBackup Status Code 617)

no drives available to start the writer process

(NetBackup Status Code 634)

no entity was found

(NetBackup Status Code 227)

no files specified in the file list

(NetBackup Status Code 112)

no images duplicated

(NetBackup Status Code 308)

no images were found to synthesize

(NetBackup Status Code 607)



no images were successfully processed

(NetBackup Status Code 191)

no media ejected for the specified vault session

(NetBackup Status Code 327)

no media is defined for the requested NB database backup

(NetBackup Status Code 121)

no message was received from bptm

(NetBackup Status Code 629)

No ports available in range (*port_number*) through (*port_number*) per the NBJAVA_CLIENT_PORT_WINDOW configuration option

(NetBackup Status Code 518)

no profile was specified

(NetBackup Status Code 274)

no robot on which the media can be read

(NetBackup Status Code 606)

no schedules of the correct type exist in this policy

(NetBackup Status Code 240)

no storage units available for use

(NetBackup Status Code 213)

no target storage unit specified for the new job

(NetBackup Status Code 604)

no target storage unit was specified via command line

(NetBackup Status Code 655)

no vault session id was found

(NetBackup Status Code 269)

none of the files in the file list exist

(NetBackup Status Code 71)

none of the requested files were backed up

(NetBackup Status Code 2)

not all requested files were restored

(NetBackup Status Code 175)

number of media has exceeded the capacity of MAP

(NetBackup Status Code 291)

one or more errors detected during consolidated eject processing

(NetBackup Status Code 290)

operation not allowed during this time period

(NetBackup Status Code 199)

operation requested by an invalid server

(NetBackup Status Code 37)

operation would cause an illegal duplication

(NetBackup Status Code 242)

permission denied by client during rcmd

(NetBackup Status Code 55)

pipe close failed

(NetBackup Status Code 18)



pipe fgets call from bpcoord failed

(NetBackup Status Code 668)

premature eof encountered

(NetBackup Status Code 233)

problems encountered during setup of shared memory

(NetBackup Status Code 89)

process called but nothing to do

(NetBackup Status Code 296)

process was killed by a signal

(NetBackup Status Code 63)

read from input socket failed

(NetBackup Status Code 636)

reader failed

(NetBackup Status Code 609)

received an error from bptm request to suspend media

(NetBackup Status Code 631)

received an error from bptm request to un-suspend media

(NetBackup Status Code 632)

received error notification for the job

(NetBackup Status Code 605)

regular bpsched is already running

(NetBackup Status Code 214)

report requested without eject being run

(NetBackup Status Code 309)

request attempted on a non reserved port

(NetBackup Status Code 45)

requested media id is in use, cannot process request

(NetBackup Status Code 97)

requested media id was not found in NB media database and/or MM volume database

(NetBackup Status Code 95)

required or specified copy was not found

(NetBackup Status Code 147)

required value not set

(NetBackup Status Code 152)

schedule windows overlap

(NetBackup Status Code 231)

scheduler child killed by signal

(NetBackup Status Code 211)

scheduler found no backups due to run

(NetBackup Status Code 200)

send buffer is full

(NetBackup Status Code 670)

server backup restore manager's network is unreachable

(NetBackup Status Code 203)



server is not the master server

(NetBackup Status Code 153)

server name not found in the bp.conf file

(NetBackup Status Code 254)

server not allowed access

(NetBackup Status Code 46)

SERVER was not specified in /usr/opensv/netbackup/bp.conf

(NetBackup Status Code 111)

Session id assignment failed

(NetBackup Status Code 263)

Session id file is empty or corrupt

(NetBackup Status Code 265)

Snapshot error encountered

(NetBackup Status Code 156)

socket close failed

(NetBackup Status Code 22)

Socket connection to the NB-Java user service has been broken. Please retry your last operation.

(NetBackup Status Code 507)

socket open failed

(NetBackup Status Code 21)

socket read failed

(NetBackup Status Code 23)

socket write failed

(NetBackup Status Code 24)

specified device path does not exist

(NetBackup Status Code 122)

specified disk path is not a directory

(NetBackup Status Code 123)

specified file contains no valid entry

(NetBackup Status Code 326)

specified media or path does not contain a valid NB database backup header

(NetBackup Status Code 127)

specified policy does not exist

(NetBackup Status Code 639)

specified profile not found

(NetBackup Status Code 304)

specified schedule was not found

(NetBackup Status Code 640)

specified target storage unit was not found in the database

(NetBackup Status Code 660)

storage unit characteristics mismatched to request

(NetBackup Status Code 154)

storage unit query failed

(NetBackup Status Code 608)



suspend requested by administrator

(NetBackup Status Code 157)

system call failed

(NetBackup Status Code 11)

system error occurred

(NetBackup Status Code 130)

system error occurred while processing user command

(NetBackup Status Code 100)

tar did not find all the files to be restored

(NetBackup Status Code 185)

tar had an unexpected error

(NetBackup Status Code 184)

tar received an invalid archive

(NetBackup Status Code 183)

tar received an invalid argument

(NetBackup Status Code 181)

tar received an invalid file name

(NetBackup Status Code 182)

tar received no data

(NetBackup Status Code 186)

tar was successful

(NetBackup Status Code 180)

termination requested by administrator

(NetBackup Status Code 150)

termination requested by bpcoord

(NetBackup Status Code 665)

text exceeded allowed length

(NetBackup Status Code 225)

the archive failed to back up the requested files

(NetBackup Status Code 7)

the backup failed to back up the requested files

(NetBackup Status Code 6)

the catalog image .f file has been archived

(NetBackup Status Code 253)

the client is not in the configuration

(NetBackup Status Code 243)

the client type is incorrect in the configuration database

(NetBackup Status Code 72)

the database contains conflicting or erroneous entries

(NetBackup Status Code 238)

the entity already exists

(NetBackup Status Code 226)

the file list is incomplete

(NetBackup Status Code 249)



the error status has been written to stderr

(NetBackup Status Code 252)

the image was not created with TIR information

(NetBackup Status Code 250)

the initiation of the vault configuration file failed

(NetBackup Status Code 271)

the library is not ready to eject volumes

(NetBackup Status Code 298)

the maximum number of jobs per client is set to 0

(NetBackup Status Code 194)

the requested operation was partially successful

(NetBackup Status Code 1)

the requested operation was successfully completed

(NetBackup Status Code 0)

the required storage unit is unavailable

(NetBackup Status Code 219)

the restore failed to recover the requested files

(NetBackup Status Code 5)

the server is not allowed to write to the client's filesystems

(NetBackup Status Code 189)

the specified container is not empty

(NetBackup Status Code 320)

the specified policy does not exist in the configuration database

(NetBackup Status Code 230)

the specified policy is not active

(NetBackup Status Code 247)

the specified policy is not of the correct client type

(NetBackup Status Code 245)

the specified client does not exist in an active policy within the configuration database

(NetBackup Status Code 236)

the specified client does not exist in the specified policy

(NetBackup Status Code 239)

the specified schedule does not exist in an active policy in the configuration database

(NetBackup Status Code 237)

the specified schedule does not exist in the specified policy

(NetBackup Status Code 197)

the specified schedule is the wrong type for this request

(NetBackup Status Code 241)

the TIR information is zero length

(NetBackup Status Code 251)

the vault session directory is either missing or inaccessible

(NetBackup Status Code 268)

there are no active policies in the configuration database

(NetBackup Status Code 248)



there is no available MAP for ejecting

(NetBackup Status Code 299)

there was a conflicting specification

(NetBackup Status Code 224)

third-party copy backup failure

(NetBackup Status Code 170)

timed out connecting to client

(NetBackup Status Code 54)

timed out connecting to server backup restore manager

(NetBackup Status Code 202)

timed out waiting for database information

(NetBackup Status Code 51)

timed out waiting for media manager to mount volume

(NetBackup Status Code 52)

timed out waiting for the client backup to start

(NetBackup Status Code 64)

tir info was pruned from the image file

(NetBackup Status Code 136)

unable to accept connection from the reader

(NetBackup Status Code 657)

unable to accept connection from the writer

(NetBackup Status Code 658)

unable to allocate new media for backup, storage unit has none available

(NetBackup Status Code 96)

unable to connect to bpcoord

(NetBackup Status Code 621)

unable to determine the status of rbak

(NetBackup Status Code 8)

unable to find policy/schedule for image using retention mapping

(NetBackup Status Code 325)

unable to get the address of the local listen socket

(NetBackup Status Code 646)

unable to issue the database query for policy

(NetBackup Status Code 651)

unable to issue the database query for policy information

(NetBackup Status Code 652)

unable to listen and register service via vnetd

(NetBackup Status Code 633)

unable to locate vault directory

(NetBackup Status Code 285)

unable to mount media because its in a DOWN drive or misplaced

(NetBackup Status Code 164)

unable to obtain process id, getpid failed

(NetBackup Status Code 270)



unable to open listen socket

(NetBackup Status Code 601)

unable to open pipe between bpsynth and bpcoord

(NetBackup Status Code 667)

unable to process request

(NetBackup Status Code 228)

unable to process request because the server resources are busy

(NetBackup Status Code 134)

unable to register handle with the reactor

(NetBackup Status Code 635)

unable to send a message to bpcoord

(NetBackup Status Code 653)

unable to send a message to the writer child process

(NetBackup Status Code 659)

unable to send a start command to a reader/writer process on media server

(NetBackup Status Code 624)

unable to send exit message to the BPXM reader

(NetBackup Status Code 661)

unable to send extent message to bpcoord

(NetBackup Status Code 648)

unable to send extent msg to BPXM

(NetBackup Status Code 650)

unable to send start synth message to bpcoord

(NetBackup Status Code 656)

unable to start the writer on the media server

(NetBackup Status Code 645)

unexpected message received

(NetBackup Status Code 43)

unexpected message received from bpcoord

(NetBackup Status Code 643)

unexpected message received from bpsynth

(NetBackup Status Code 627)

unexpected message received from BPXM

(NetBackup Status Code 649)

unexpected message was received from bptm

(NetBackup Status Code 630)

unimplemented feature

(NetBackup Status Code 16)

unknown image referenced in the SYNTH CONTEXT message from BPXM

(NetBackup Status Code 662)

unsupported image format for the requested database query

(NetBackup Status Code 79)

user id was not superuser

(NetBackup Status Code 140)



user is not validated to use the server

(NetBackup Status Code 132)

valid archive image produced, but no files deleted due to non-fatal problems

(NetBackup Status Code 3)

validation of synthetic image failed

(NetBackup Status Code 647)

vault configuration file not found

(NetBackup Status Code 259)

vault core error

(NetBackup Status Code 281)

vault core system error

(NetBackup Status Code 282)

vault core unhandled error

(NetBackup Status Code 283)

vault internal error 260

(NetBackup Status Code 260)

vault internal error 261

(NetBackup Status Code 261)

vault internal error 262

(NetBackup Status Code 262)

vault internal error 286

(NetBackup Status Code 286)

vmchange api_eject command failed

(NetBackup Status Code 301)

vmchange eject verify not responding

(NetBackup Status Code 300)

VxSS access denied

(NetBackup Status Code 117)

VxSS authentication failed

(NetBackup Status Code 116)

VxSS authorization failed

(NetBackup Status Code 118)

VxSS authentication is requested but not allowed

(NetBackup Status Code 193)

VxSS authentication is required but not available

(NetBackup Status Code 192)

write on output socket failed

(NetBackup Status Code 637)

You are not authorized to use this application

(NetBackup Status Code 501)

zero extents in the synthetic image, cannot proceed

(NetBackup Status Code 664)



Media Manager Status Codes and Messages

6

This chapter lists Media Manager status codes and messages. In each of the following subsections, the status codes are listed in numerical order, followed by an explanation and recommended action.

- ◆ [Media Manager Status Codes](#)
- ◆ [Device Configuration Status Codes](#)
- ◆ [Format Optical Status Codes](#)
- ◆ [Device Management Status Codes](#)
- ◆ [Robotic Status Codes](#)
- ◆ [Robotic Error Codes](#)
- ◆ [Device Diagnostics Status Codes](#)

At the end of this chapter is a section titled “Messages,” which lists all Media Manager messages alphabetically. Following each message is a pointer to the section in this chapter that contains detailed information about the message.

Status Codes

Note The term *media server*, as distinct from *master server* or *server*, does not apply to the NetBackup Server product. When troubleshooting a Server installation, please ignore any references to media server.

Media Manager Status Codes

These status codes appear in exit status and command output for most Media Manager commands, media and device management user interfaces, and system or debug logs.

Media Manager Status Code: 1

Message: request completed



Explanation: A requested operation was completed. The operation may have been one of several related operations for a particular task.

Recommended Action: None.

Media Manager Status Code: 2

Message: system error

Explanation: A system call failed. This status code is used for a generic system call failure that does not have its own status code.

Recommended Action:

1. Check for other error messages in the command or interface output to determine which system call failed. Enable debug logging, retry the operation, and check the debug log files for more specific error messages.
2. Check the system application log for error and warning messages.
3. Verify that the system is not running out of virtual memory. If virtual memory is the problem, shut down unused applications or increase the amount of virtual memory. To increase virtual memory on Windows:
4. Display the Control Panel.
5. Double-click System.
6. On the Performance tab, set Virtual Memory to a higher value. (On Windows 2000, select Performance Options from the Advanced tab.)
7. Verify that all product binaries are properly installed.
8. Verify that there are no unexpected Media Manager processes running by executing `vmps`. Some processes are expected to remain running, though some processes that are not going away could indicate a more serious problem, such as a hung system call.

Media Manager Status Code: 3

Message: must be root user to execute command

Explanation: The process was started by a user or process that did not have root privileges (on UNIX) or administrator privileges (on Windows).

Recommended Action: If desired, give the user or process administrator privileges (on Windows) or root privileges (on UNIX) and retry the operation.

Media Manager Status Code: 4

Message: invalid command usage

Explanation: A Media Manager command was executed with improper options or there is an incompatibility between components or versions of the product.

Recommended Action:

1. Examine command output, debug logs, and system logs for a more detailed message on the error, as follows.
 - a. If not already enabled, enable debug logging by creating the necessary directories/folders. Increase the level of verbosity by adding the VERBOSE option in the `vm.conf` file and restarting the daemons/services, or by executing the command's verbose option, if available.
 - b. Retry the operation and examine the logs.
2. Check the usage statement for expected usage and compare with the parameters being sent to start the new process.
3. Verify that all Media Manager binaries are at a compatible version level.

Media Manager Status Code: 5

Message: daemon resources are busy

Explanation: A requested operation could not be processed because resources were busy.

Recommended Action: Check the status of any resources used by the requested operation. On a robotic inventory request, verify that the inventory operation completes within the allotted time (7 minutes for robot types ACS, LMF, RSM, TLH, TLM, TS8, TSD, TSH, and 32 minutes for other robot types).

Media Manager Status Code: 6

Message: invalid protocol request

Explanation: An invalid request was sent to a Media Manager robotic process or operator request process.

Recommended Action:

1. Examine command output, debug logs, and system logs for a more detailed message on the error, as follows.
 - a. If not already enabled, enable debug logging by creating the necessary directories/folders. Increase the level of verbosity by adding the VERBOSE option in the `vm.conf` file and restarting the daemons/services, or by executing the command's verbose option, if available.
 - b. Retry the operation and examine the logs.
2. Identify the target components (for example, `vmr` and robotic processes on local or remote hosts) and verify that all Media Manager binaries are at compatible version level.

Media Manager Status Code: 7

Message: daemon terminated

Explanation: The process is inactive or is terminating (or has terminated) from an event or signal, or as a direct result of a request from an authorized user or process.

Recommended Action: If the targeted product component is needed but has terminated, restart the daemons/services on the targeted host.

Media Manager Status Code: 8

Message: invalid media ID

Explanation: A process performing a media-related operation encountered an empty or incorrectly formatted media identifier, or was passed a media ID that could not be operated on as requested.

Recommended Action:

1. Examine command output and debug logs for a more detailed message on the error, as follows.
 - a. If not already enabled, enable debug logging by creating the necessary directories/folders. Increase the level of verbosity by adding the VERBOSE option in the `vm.conf` file and restarting the daemons/services, or by executing the command's verbose option, if available.
 - b. Retry the operation and examine the logs.
2. Ensure that the media ID, where requested, is not blank.

3. Ensure that the specified media IDs contain valid characters only: alphanumeric characters, and the period (.), plus sign (+), and underscore (_). A hyphen (-) is also a valid character when not the first character in the media ID.
4. If the media is for optical disk, ensure that the media ID of the optical partner is specified and contains only valid characters.
5. If the media ID is for optical disk in a TLM robot, ensure that the format of the ID and partner are "Axxxxxx" and "Bxxxxx," respectively.
6. If media are specified to be ejected from a library, ensure that they exist in the volume database and are associated with the correct robot number.
7. Ensure that the media ID is from 1 to 6 characters in length.
8. Ensure that a valid media and seed were specified.
9. If the operation is an inventory request for an ACS robot, use the `robtest` utility to verify that the ACS interface is returning cleaning media IDs both in the query volume list and in the query cleaning volume list.

Media Manager Status Code: 9

Message: invalid media type

Explanation: A process performing a media-related operation encountered an unknown, missing, or incompatible media type specifier.

Recommended Action:

1. If running a robot inventory on a robot of type ACS, LMF, RSM, TLH, or TLM, ensure that the vendor media type returned from the robot control software is supported and recognized by the version of Media Manager that is installed.
2. If using a command line interface directly, verify that a valid media type has been passed, according to `vmadd (1m)` command line documentation, which applies to all Media Manager command line interfaces.
3. Ensure that an operation valid only for cleaning media has not been requested on a media ID that does not correspond to cleaning tape.
4. Ensure that the media type in all barcode rules is a valid media type or the ordinal zero (0), to represent the default media type.



Media Manager Status Code: 10

Message: invalid barcode

Explanation: A process performing a media-related operation encountered an unknown, missing, or incompatible barcode.

Recommended Action:

1. Examine command output (if available) and debug logs for a more detailed message on the error, as follows.
 - a. If not already enabled, enable debug logging by creating the necessary directories/folders. Increase the level of verbosity by adding the `VERBOSE` option in the `vm.conf` file and restarting the daemons/services, or by executing the command's verbose option, if available.
 - b. Retry the operation and examine the logs.
2. Ensure that the barcode, where requested, is not blank.
3. Ensure that the specified barcodes contain valid characters only: alphanumeric characters, and the period (`.`), plus sign (`+`), and underscore (`_`). A hyphen (`-`) is also a valid character when not the first character in the media ID.
4. Ensure that the number of characters in the barcode does not exceed the maximum allowed for the robot type.
5. Ensure that the barcode tag in all barcode rules is a subset of a valid, supported barcode format.

Media Manager Status Code: 11

Message: invalid description

Explanation: The volume description exceeds 25 ASCII characters in length, or contains unprintable characters.

Recommended Action: When adding or changing a volume record or barcode rule record, ensure that the description field contains only printable characters and is not longer than 25 ASCII characters.

Media Manager Status Code: 12

Message: invalid robot type

Explanation: A requested operation encountered a case where a specified robot type or a volume's robot type differed from the type of robot required to perform the operation in the current configuration.

Recommended Action:

1. Examine command output (if available) and debug logs for a more detailed message on the error, as follows.
 - a. If not already enabled, enable debug logging by creating the necessary directories/folders. Increase the level of verbosity by adding the `VERBOSE` option in the `vm.conf` file and restarting the daemons/services, or by executing the command's verbose option, if available.
 - b. Retry the operation and examine the logs.
2. Specify a robot type that supports the volume's media type.
3. Check the volume database and ensure that the specified robot type agrees with that for all volumes having the specified robot number.
4. If a robot type is required for the requested operation, ensure that a robot type has been specified.

Media Manager Status Code: 13

Message: invalid robot number

Explanation: The robot number was not specified or was not within the allowable range.

Recommended Action:

1. Specify a robot number in the range of 0 to 32767.
2. If running `vmphysinv`, the global device database may not be updated, or the specified robot number may not be configured.

Media Manager Status Code: 14

Message: invalid robot host

Explanation: A requested operation encountered a case where the robot control host was either not specified, not valid for the given robot type, not in an acceptable format, or exceeded the allowed length of a robot control host name.

Recommended Action:



1. Examine command output (if available) and debug logs for a more detailed message on the error, as follows.
 - a. If not already enabled, enable debug logging by creating the necessary directories/folders. Increase the level of verbosity by adding the `VERBOSE` option in the `vm.conf` file and restarting the daemons/services, or by executing the command's verbose option, if available.
 - b. Retry the operation and examine the logs.
2. If possible, re-attempt the requested operation using another user interface that supports the type of request.

Media Manager Status Code: 15

Message: invalid volgroup

Explanation: A requested operation encountered a case where the volume group was either not specified, not in an acceptable format, or exceeded the allowed length of a volume group.

Recommended Action:

1. Examine command output (if available) and debug logs for a more detailed message on the error, as follows.
 - a. If not already enabled, enable debug logging by creating the necessary directories/folders. Increase the level of verbosity by adding the `VERBOSE` option in the `vm.conf` file and restarting the daemons/services, or by executing the command's verbose option, if available.
 - b. Retry the operation and examine the logs.
2. Specify a volume group where one is required, ensuring that it is no longer than 25 ASCII characters in length, without containing any whitespace or unprintable characters.

Media Manager Status Code: 16

Message: invalid robot coord1

Explanation: A requested operation encountered a missing or out-of-range robot slot number, or a move by volume group residence was attempted when the volume had not originated from a valid robotic library slot.

Recommended Action:



1. Examine command output (if available) and debug logs for a more detailed message on the error, as follows.
 - a. If not already enabled, enable debug logging by creating the necessary directories/folders. Increase the level of verbosity by adding the VERBOSE option in the `vm.conf` file and restarting the daemons/services, or by executing the command's verbose option, if available.
 - b. Retry the operation and examine the logs.
2. Specify a slot number (robot coordinate 1) where required, ensuring that it is within the allowable range of slot numbers for the given robot type.

Media Manager Status Code: 17

Message: invalid robot coord2

Explanation: A requested operation encountered a missing or invalid robot coordinate 2 (used for the optical platter side), or a move by volume group residence was attempted when the volume had not been previously associated with a valid robot coordinate 2 (optical platter side).

Recommended Action:

1. Examine command output (if available) and debug logs for a more detailed message on the error, as follows.
 - a. If not already enabled, enable debug logging by creating the necessary directories/folders. Increase the level of verbosity by adding the VERBOSE option in the `vm.conf` file and restarting the daemons/services, or by executing the command's verbose option, if available.
 - b. Retry the operation and examine the logs.
2. Specify a robot coordinate 2 value of zero (0) for non-optical media, or specify either A or B to represent the platter side for optical media.

Media Manager Status Code: 18

Message: cannot allocate requested memory

Explanation: Allocation of system memory failed. This error occurs when there is insufficient system memory available. The system may have too little physical and virtual memory to handle the current load of processes.

Recommended Action: Free up memory by terminating unneeded processes that consume a lot of memory. Add more swap space or physical memory.



Media Manager Status Code: 19

Message: invalid volume database host

Explanation: A requested operation encountered a missing or invalid volume database host, or a request was sent to a host running a version of the product that does not support the requested operation.

Recommended Action:

1. Examine command output (if available) and debug logs for a more detailed message on the error, as follows.
 - a. If not already enabled, enable debug logging by creating the necessary directories/folders. Increase the level of verbosity by adding the VERBOSE option in the `vm.conf` file and restarting the daemons/services, or by executing the command's verbose option, if available.
 - b. Retry the operation and examine the logs.
2. Specify a valid volume database host on which a version of `vmc`, the volume daemon on UNIX, or NetBackup Volume Manager service on Windows, or operator request daemon/process is running that supports the requested operation.

Media Manager Status Code: 20

Message: protocol error

Explanation: Message communications (handshaking) was not correct.

Recommended Action:

1. Examine command output (if available) and debug logs for a more detailed message on the error, as follows.
 - a. If not already enabled, enable debug logging by creating the necessary directories/folders. Increase the level of verbosity by adding the VERBOSE option in the `vm.conf` file and restarting the daemons/services, or by executing the command's verbose option, if available.
 - b. Retry the operation and examine the logs.
2. Retry the operation and examine the logs. Ensure that there are no embedded whitespaces in fields that do not allow embedded whitespace.



Media Manager Status Code: 21

Message: cannot obtain daemon lockfile

Explanation: vmd (the Media Manager volume daemon on UNIX or NetBackup Volume Manager service on Windows) could not obtain an internal software lock.

Recommended Action: Check for the existence and permissions of the lock file itself and the lock file directory, which is `/usr/opensv/volmgr/misc/vmd.lock` (UNIX) or `install_path\Volmgr\misc\vmd.lock` (Windows). Create the directory/folder and adjust the permissions as needed so that vmd can obtain the lock, which is `/usr/opensv/volmgr/misc/vmd.lock` (UNIX) or `install_path\Volmgr\misc\vmd.lock` (Windows).

Media Manager Status Code: 22

Message: database initialization failed

Explanation: Initialization problems were encountered in the robotic test utility while trying to read the device databases. This is a generic return code for device database-related issues.

Recommended Action: Check the command output for detailed errors. Use the `tpconfig` interface or another device management interface to verify database access and integrity.

Media Manager Status Code: 23

Message: database close operation failed

Explanation: An error occurred when vmd attempted to close the volume database.

Recommended Action: Examine the daemon debug log for a more detailed message on the system error, as follows.

1. If not already enabled, enable debug logging by creating the necessary directories/folders. Increase the level of verbosity by adding the `VERBOSE` option in the `vm.conf` file and restarting the volume daemon (UNIX)/ NetBackup Volume Manager service (Windows), or start vmd with the verbose option.
2. Retry the operation and examine the logs.

Media Manager Status Code: 24

Message: database already open

Explanation: vmd (the Media Manager volume daemon on UNIX or NetBackup Volume Manager service on Windows) was about to open the volume database, but found that it was already open.



Recommended Action: Check to see if the volume database locking mechanism is working correctly, and send requests such as volume queries to vmd to see if it is functioning correctly. Try stopping and starting vmd to clear the unexpectedly open file descriptor.

Media Manager Status Code: 25

Message: failed making the database directory

Explanation: vmd (the Media Manager volume daemon on UNIX or NetBackup Volume Manager service on Windows) could not create the database directory/folder.

Recommended Action: Determine why the directory `/usr/opensv/volmgr/database` (UNIX) or folder `install_path\Volmgr\database` (Windows) cannot be created. On Windows, check which account the NetBackup Volume Manager service is running under and compare it against the security properties of the database folder.

Media Manager Status Code: 26

Message: database open operation failed

Explanation: A database file could not be opened.

Recommended Action: Check for the existence and permissions of the `volDB` file in the `/usr/opensv/volmgr/database` directory (UNIX) or `install_path\Volmgr\database` folder (Windows). Also check for the existence and permissions of the following files in the `/usr/opensv/share` directory (UNIX) or `install_path\NetBackup\share` folder (Windows):

- ◆ `external_robotics.txt`
- ◆ `external_densities.txt`
- ◆ `external_drivetypes.txt`
- ◆ `external_mediatypes.txt`

Media Manager Status Code: 27

Message: database read record operation failed

Explanation: vmd (the Media Manager volume daemon on UNIX or NetBackup Volume Manager service on Windows) encountered a read error while reading a volume database record.

Recommended Action:

1. Examine the daemon debug log for a more detailed message on the system error, as follows.
 - a. If not already enabled, enable debug logging by creating the necessary directories/folders. Increase the level of verbosity by adding the VERBOSE option in the `vm.conf` file and restarting the daemons/services, or by executing the command's verbose option, if available.
 - b. Retry the operation and examine the logs.
2. The volume database may be corrupted. Restore an older volume database from a saved version or from catalog backups.

Media Manager Status Code: 28

Message: database read operation read too few bytes

Explanation: vmd (the Media Manager volume daemon on UNIX or NetBackup Volume Manager service on Windows) encountered a record that was smaller than expected while reading a volume database record.

Recommended Action:

1. Examine the daemon debug log for a more detailed message on the system error, as follows.
 - a. If not already enabled, enable debug logging by creating the necessary directories/folders. Increase the level of verbosity by adding the VERBOSE option in the `vm.conf` file and restarting the daemons/services, or by executing the command's verbose option, if available.
 - b. Retry the operation and examine the logs.
2. The volume database may be corrupted. Restore an older volume database from a saved version or from catalog backups.

Media Manager Status Code: 29

Message: database lock operation failed

Explanation: vmd (the Media Manager volume daemon on UNIX) encountered a system call error while attempting to lock the volume database. This error code applies to UNIX servers only.

Recommended Action:

1. Examine the daemon debug log for a more detailed message on the system error, as follows.
 - a. If not already enabled, enable debug logging by creating the necessary directories/folders. Increase the level of verbosity by adding the VERBOSE option in the `vm.conf` file and restarting the volume daemon, or start `vmd` with the verbose option, if available.
 - b. Retry the operation and examine the logs.
2. Execute `vmops` to ensure that `vmd` and `vmdb_dump` are not both running at the same time.
3. Ensure that no other process has a lock on the database file `/usr/opensv/volmgr/database/volDB`.

Media Manager Status Code: 30

Message: database seek operation failed

Explanation: `vmd` (the Media Manager volume daemon on UNIX or NetBackup Volume Manager service on Windows) encountered a read error while seeking (positioning) within the volume database.

Recommended Action:

1. Examine the daemon debug log for a more detailed message on the system error, as follows.
 - a. If not already enabled, enable debug logging by creating the necessary directories/folders. Increase the level of verbosity by adding the VERBOSE option in the `vm.conf` file and restarting the daemons/services, or by executing the command's verbose option, if available.
 - b. Retry the operation and examine the logs.
2. The volume database may be corrupted. Restore an older volume database from a saved version or from catalog backups.

Media Manager Status Code: 31

Message: database unlock operation failed

Explanation: `vmd` (the Media Manager volume daemon on UNIX) encountered a system call error while attempting to unlock the volume database.

Recommended Action:



1. Examine the daemon debug log for a more detailed message on the system error, as follows.
 - a. If not already enabled, enable debug logging by creating the necessary directories/folders. Increase the level of verbosity by adding the VERBOSE option in the `vm.conf` file and restarting the volume daemon, or start `vmc` with the verbose option, if available.
 - b. Retry the operation and examine the logs.
2. Execute `vmops` to ensure that `vmc` and `vmdb_dump` are not both running at the same time.
3. Ensure that no other process is locking or unlocking the database file `/usr/opensv/volmgr/database/volDB`.

Media Manager Status Code: 32

Message: database write record operation failed

Explanation: `vmc` (the Media Manager volume daemon on UNIX or NetBackup Volume Manager service on Windows) encountered an error while writing a volume database record.

Recommended Action:

1. Examine the daemon debug log for a more detailed message on the system error, as follows.
 - a. If not already enabled, enable debug logging by creating the necessary directories/folders. Increase the level of verbosity by adding the VERBOSE option in the `vm.conf` file and restarting the daemons/services, or by executing the command's verbose option, if available.
 - b. Retry the operation and examine the logs.
2. Examine the permissions and available file system space for writing to the database `/usr/opensv/volmgr/database/volDB` (UNIX) or `install_path\Volmgr\database\volDB` (Windows).

Media Manager Status Code: 33

Message: database write operation wrote too few bytes



Explanation: `vmd` (the Media Manager volume daemon on UNIX or NetBackup Volume Manager service on Windows) encountered an error while writing a volume database record, where the record was only partially written.

Recommended Action:

1. Examine the daemon debug log for a more detailed message on the system error, as follows.
 - a. If not already enabled, enable debug logging by creating the necessary directories/folders. Increase the level of verbosity by adding the `VERBOSE` option in the `vm.conf` file and restarting the volume daemon/NetBackup Volume Manager service, or start `vmd` with the verbose option, if available.
 - b. Retry the operation and examine the logs.
2. Examine the available file system space for writing to the database `/usr/opensv/volmgr/database/volDB` (UNIX) or `install_path\Volmgr\database\volDB` (Windows).

Media Manager Status Code: 34

Message: media ID not unique in database

Explanation: A volume entry being added to or changed in the volume database had a media ID (or optical partner ID) specified which was a duplicate of the media ID for another volume already in the volume database. All volumes in a volume database must have a unique media ID.

Recommended Action:

1. Examine the daemon and `reqlib` debug logs for a more detailed message on the error, as follows.
 - a. If not already enabled, enable debug logging by creating the necessary directories/folders. Increase the level of verbosity by adding the `VERBOSE` option in the `vm.conf` file and restarting the volume daemon/NetBackup Volume Manager service, or start `vmd` with the verbose option, if available.
 - b. Retry the operation and examine the logs.
2. When adding volumes to the volume database, specify a media ID that is unique.
3. If running `vmphysinv`, there may be two or more media in the tape library with the same media ID.

Media Manager Status Code: 35

Message: volume does not exist in database

Explanation: A requested operation encountered a case where a volume query did not return a volume entry matching the search criteria.

Recommended Action:

1. Examine the daemon and reqlib debug logs for a more detailed message on the error, as follows.
 - a. If not already enabled, enable debug logging by creating the necessary directories/folders. Increase the level of verbosity by adding the VERBOSE option in the `vm.conf` file and restarting the volume daemon/NetBackup Volume Manager service, or start `vmc` with the verbose option, if available.
 - b. Retry the operation and examine the logs.
2. Ensure that volumes are properly configured on the volume database host that matches the volume database host configured for the robot or set of standalone drives. Use `tpconfig -d` and `tpconfig -lsavdbhost` to list the configured volume database hosts. Select the current server (the one you are administering) to be the same as the host which is the correct volume database host for a targeted device.
3. Update the volume or device configurations, specify the correct volume database host, modify volume properties, or adjust search criteria as needed so that the volume query can find a matching volume.
4. If running `vmphysinv`, none of the media satisfy the search criterion. As such, `vmphysinv` could not inventory the tape library.

Media Manager Status Code: 36

Message: barcode not unique in database

Explanation: A volume entry being added to or changed in the volume database had a barcode specified which was a duplicate of the barcode for another volume already in the volume database. All volumes in a volume database must have a unique barcode.

Recommended Action:

1. Examine command output (if available) and the daemon and reqlib debug logs for a more detailed message on the error, as follows.
 - a. If not already enabled, enable debug logging by creating the necessary directories/folders. Increase the level of verbosity by adding the VERBOSE option in the `vm.conf` file and restarting the volume daemon/NetBackup Volume Manager service, or start `vmc` with the verbose option, if available.
 - b. Retry the operation and examine the logs.
2. Query for or sort volume records by barcode to identify the existing volume entry with the same barcode as that specified for the volume entry being added or changed.

Media Manager Status Code: 37

Message: robotic volume position is already in use

Explanation: A volume entry being added to or changed in the volume database had a robotic coordinate (slot number, or slot number and platter side) which was a duplicate of the robotic coordinate for another volume already in the volume database. All volumes in a volume database must have unique robotic coordinates.

Recommended Action:

1. Examine command output (if available) and the daemon and reqlib debug logs for a more detailed message on the error, as follows.
 - a. If not already enabled, enable debug logging by creating the necessary directories/folders. Increase the level of verbosity by adding the VERBOSE option in the `vm.conf` file and restarting the volume daemon/NetBackup Volume Manager service, or start `vmc` with the verbose option, if available.
 - b. Retry the operation and examine the logs.
2. Query for or sort volume records by slot number to identify the existing volume entry with the same robotic coordinate as that specified on the volume entry being added or changed (if using optical disk, display the optical platter side).
3. Change (update or move volume) or delete the existing volume entry if it does not reflect the correct robotic coordinate corresponding to the volume's storage position in the robotic library. If a volume is currently in a drive, the volume database should still reflect the volume's home slot.

Media Manager Status Code: 38

Message: Current version does not support remote device host



Explanation: On a request to change the global device database host or the volume database host for a residence, the specified host is not the local host, and the current software is not licensed to allow remote hosts.

Recommended Action: Check product documentation for supported device configurations. Obtain an additional software license that allows remote hosts to be configured, or specify only local host names on the configuration request.

Media Manager Status Code: 39

Message: network protocol error

Explanation: An attempt to read data from a socket failed.

Recommended Action:

1. Examine command output (if available) and the daemon and reqlib debug logs for a more detailed message on the protocol error, as follows.
 - a. If not already enabled, enable debug logging by creating the necessary directories/folders. Increase the level of verbosity by adding the VERBOSE option in the `vm.conf` file and restarting the volume daemon/NetBackup Volume Manager service, or start `vmc` with the verbose option, if available.
 - b. Retry the operation and examine the logs.
2. Verify that the server being connected to is operational.

Media Manager Status Code: 40

Message: unexpected data received

Explanation: Message communications (handshaking) was not correct.

Recommended Action:

1. Verify that the correct version of software is running on all servers.
2. If not already enabled, enable debug logging by creating the necessary directories/folders. Increase the level of verbosity by adding the VERBOSE option in the `vm.conf` file and restarting the volume daemon/NetBackup Volume Manager service, or start `vmc` with the verbose option, if available.
3. Retry the operation and examine the logs.
4. Ensure that there are no embedded whitespaces in fields that do not allow embedded whitespace.



Media Manager Status Code: 41

Message: invalid media ID for naming mode

Explanation: A request to add multiple volumes with a first media ID and a media ID style failed because the media ID specified was not compatible with the media ID naming style provided.

Recommended Action: Provide a first media ID that fits the selected style. For example, if the media ID style is two characters and four digits, the least significant four characters in the first media ID must be digits in the range 0 to 9. Alternatively, select a media ID style that fits the specified first media ID.

Media Manager Status Code: 42

Message: cannot connect to robotic software daemon

Explanation: A connection to a robotic software daemon/process could not be established. This can occur when a process tries to connect to the robotic process that is not running. It can also occur if the network or server is heavily loaded and has slow response time.

Recommended Action:

1. Examine command output (if available) and the daemon and reqlib debug logs for a more detailed message on the error, as follows.
 - a. If not already enabled, enable debug logging by creating the necessary directories/folders. Increase the level of verbosity by adding the VERBOSE option in the `vm.conf` file and restarting the volume daemon/NetBackup Volume Manager service, or start `vmc` with the verbose option, if available.
 - b. Retry the operation and examine the logs.
2. Identify the robotic process by looking at the robot type, and at the robot host on the robotic request or the robot host field of the volume being operated on.
3. Verify that the robotic process used for robotic control is available (see table “[Media Manager Daemons and Programs](#)” on page 598), and start the robotic process if necessary.
4. Ensure that there is only one configured robot control host for each LMF, TL8, TLD, and TLH robot and that all volumes in the volume configuration have a robot host that matches the configured robot control host.
5. Change the volumes or reconfigure the robot in the device configuration as needed.

6. Check the system log on the robot control host to see if the robotic process is processing requests during the time when connections to it are attempted.

Media Manager Status Code: 43

Message: failed sending to robotic software daemon

Explanation: An attempt to write data to a robotic software daemon/process socket failed.

Recommended Action:

1. Examine command output (if available) and the daemon and reqlib debug logs for a more detailed message on the error, as follows.
 - a. If not already enabled, enable debug logging by creating the necessary directories/folders. Increase the level of verbosity by adding the VERBOSE option in the `vm.conf` file and restarting the daemons/services, or by executing the command's verbose option, if available.
 - b. Retry the operation and examine the logs.
2. Identify the robotic process by looking at the robot type, and at the robot host on the robotic request or the robot host field of the volume being operated on. Verify that the robotic process used for robotic control is available and handling requests (see section [“Programs and Daemons”](#) on page 598).
3. Identify the robot control host by checking the device configuration. There should be only one configured robot control host for each LMF, TL8, TLD, and TLH robot and all volumes in the volume configuration should have a robot host that matches the configured robot control host.
4. Check the system log on the robot control host to see if the robotic process is processing requests during the time when communications with it are attempted. Perform [“Resolving Network Communication Problems”](#) on page 26.

Media Manager Status Code: 44

Message: failed receiving from robotic software daemon

Explanation: An attempt to read data from a robotic software daemon/process socket failed.

Recommended Action:

1. Examine command output (if available) and the daemon and reqlib debug logs for a more detailed message on the error, as follows.
 - a. If not already enabled, enable debug logging by creating the necessary directories/folders. Increase the level of verbosity by adding the VERBOSE option in the `vm.conf` file and restarting the daemons/services, or by executing the command's verbose option, if available.
 - b. Retry the operation and examine the logs.
2. Identify the targeted robotic process by looking at the robot type, and at the robot host on the robotic request or the robot host field of the volume being operated on. Verify that the robotic process used for robotic control is available and handling requests (see section “[Programs and Daemons](#)” on page 598).
3. Identify the robot control host by checking the device configuration. There should be only one configured robot control host for each LMF, TL8, TLD, and TLH robot and all volumes in the volume configuration should have a robot host that matches the configured robot control host.
4. Check the system log on the robot control host to see if the robotic process is processing requests during the time when communications with it are attempted. Perform “[Resolving Network Communication Problems](#)” on page 26.

Media Manager Status Code: 45

Message: failed changing terminal characteristics

Explanation: A system call failed when an attempt was made to change the mode for terminal input between cooked and raw.

Recommended Action: Examine the user interface output for the system error associated with the failed system call and troubleshoot according to operating system vendor recommendations.

Media Manager Status Code: 46

Message: unexpected data from robotic software daemon

Explanation: Message communications (handshaking) between a process and a robotic software daemon/process failed.

Recommended Action:

1. Verify that the correct version of software is running on all servers.
2. If not already enabled, enable debug logging by creating the necessary directories/folders. Increase the level of verbosity by adding the VERBOSE option in the `vm.conf` file and restarting the daemons/services, or by executing the command's verbose option, if available.
3. Retry the operation and examine the logs.
4. Ensure that there are no embedded whitespaces in fields that do not allow embedded whitespace.
5. Check the system log on the robot control host for errors logged by the robotic software.

Media Manager Status Code: 47

Message: no entries changed

Explanation: A requested operation was completed, but no changes to the volume configuration or Media Manager configuration file were made. The administrator may have aborted an operation instead of continuing with proposed changes, or the configuration file may have already included the configuration entry that was being added.

Recommended Action:

1. No action is needed if the administrator aborted the change operation.
2. Examine command output (if available) and the daemon and `reqlib` debug logs for a more detailed message on the error, as follows.
 - a. If not already enabled, enable debug logging by creating the necessary directories/folders. Increase the level of verbosity by adding the VERBOSE option in the `vm.conf` file and restarting the daemons/services, or by executing the command's verbose option, if available.
 - b. Retry the operation and examine the logs.

Media Manager Status Code: 48

Message: no entries deleted

Explanation: A delete volume(s) operation completed, but no changes were made to the volume configuration.

Recommended Action:

1. No action is needed, unless volumes that were requested to be deleted were not in fact deleted.
2. Examine command output (if available) and the daemon and reqlib debug logs for a more detailed message on the error, as follows.
 - a. If not already enabled, enable debug logging by creating the necessary directories/folders. Increase the level of verbosity by adding the VERBOSE option in the `vm.conf` file and restarting the daemons/services, or by executing the command's verbose option, if available.
 - b. Retry the operation and examine the logs.

Media Manager Status Code: 49

Message: no entries inserted

Explanation: An insert volume(s) operation completed, but no volumes were added to the volume configuration.

Recommended Action:

1. No action is needed unless volumes that were requested to be inserted were not actually inserted.
2. Examine command output (if available) and the daemon and reqlib debug logs for a more detailed message on the error, as follows.
 - a. If not already enabled, enable debug logging by creating the necessary directories/folders. Increase the level of verbosity by adding the VERBOSE option in the `vm.conf` file and restarting the daemons/services, or by executing the command's verbose option, if available.
 - b. Retry the operation and examine the logs.

Media Manager Status Code: 50

Message: invalid change-entry request

Explanation: A request to change volume information was sent to vmd (the Media Manager volume daemon on UNIX or NetBackup Volume Manager service on Windows), but an older version of vmd is installed on the volume database host which does not support the type of change operation requested.

Recommended Action:



1. Examine command output (if available), debug logs, and system logs for a more detailed message on the error, as follows.
 - a. If not already enabled, enable debug logging by creating the necessary directories/folders. Increase the level of verbosity by adding the VERBOSE option in the `vm.conf` file and restarting the daemons/services, or by executing the command's verbose option, if available.
 - b. Retry the operation and examine the logs.
2. Check the usage statement for expected usage and compare with the parameters being sent to start the new process.
3. Ensure that change volume requests from a newer release version level are not sent to `vmd` on an older, incompatible version level.

Media Manager Status Code: 51

Message: cannot auto-eject this robot type

Explanation: A request to change volume residence with `media eject` was sent to `vmd` (the Media Manager volume daemon on UNIX or NetBackup Volume Manager service on Windows), but the volume's robot type does not support automated media eject.

Recommended Action:

1. Examine command output (if available), debug logs, and system logs for a more detailed message on the error, as follows.
 - a. If not already enabled, enable debug logging by creating the necessary directories/folders. Increase the level of verbosity by adding the VERBOSE option in the `vm.conf` file and restarting the daemons/services, or by executing the command's verbose option, if available.
 - b. Retry the operation and examine the logs.
2. Ensure that change volume residence requests (with `eject` for the robot type involved with a newer release version level) are not sent to `vmd` on a system running an older, incompatible software version level.

Media Manager Status Code: 52

Message: cannot auto-inject this robot type



Explanation: A request to change volume residence with media inject was sent to `vmd` (the Media Manager volume daemon on UNIX or NetBackup Volume Manager service on Windows), but the volume's robot type does not support automated media inject.

Recommended Action:

1. Examine command output (if available), debug logs, and system logs for a more detailed message on the error.
 - a. If not already enabled, enable debug logging by creating the necessary directories/folders. Increase the level of verbosity by adding the `VERBOSE` option in the `vm.conf` file and restarting the daemons/services, or by executing the command's verbose option, if available.
 - b. Retry the operation and examine the logs.
2. Ensure that change volume residence requests (with inject for the robot type involved with a newer release version level) are not sent to `vmd` on a system running an older, incompatible software version level.

Media Manager Status Code: 53

Message: invalid volume move mode

Explanation: A robotic-related request was made specifying a media movement option that is not supported by all affected software components.

Recommended Action:

1. Examine command output (if available), debug logs, and system logs for a more detailed message on the error.
 - a. If not already enabled, enable debug logging by creating the necessary directories/folders. Increase the level of verbosity by adding the `VERBOSE` option in the `vm.conf` file and restarting the daemons/services, or by executing the command's verbose option, if available.
 - b. Retry the operation and examine the logs.
2. Ensure that the robotic request is sent to a system running a release version of software that supports the particular request.

Media Manager Status Code: 54

Message: robot number and robot type mismatch

Explanation: A request was made to add or change volumes in the volume configuration. The robot number to be associated with a volume is already in use, and is associated with another volume in a robot with the same number but of another robot type.

Recommended Action:

1. Examine command output (if available), debug logs, and system logs for a more detailed message on the error.
 - a. If not already enabled, enable debug logging by creating the necessary directories/folders. Increase the level of verbosity by adding the VERBOSE option in the `vm.conf` file and restarting the daemons/services, or by executing the command's verbose option, if available.
 - b. Retry the operation and examine the logs.
2. Ensure that robot numbers are unique for each physical robot in all device configurations using the same volume database host. Delete and re-add a robot using a unique robot number if duplicate robot numbers are in use, or specify a different volume database host for one of the duplicate robot numbers. Use a media management interface to identify robot numbers currently in use for all volumes in the volume configuration. If using a command line interface, specify the correct robot type for the robot number associated with the request.

Media Manager Status Code: 55

Message: robot number and volume group mismatch

Explanation: A request was made to add or change volumes in the volume configuration, and the robot number and volume group associated with the volume configuration changes are in conflict with the requirements for volume groups. All volumes in a volume group are required to have the same residence, which includes having the same robot number.

Recommended Action:

1. Examine command output (if available), debug logs, and system logs for a more detailed message on the error.
 - a. If not already enabled, enable debug logging by creating the necessary directories/folders. Increase the level of verbosity by adding the VERBOSE option in the `vm.conf` file and restarting the daemons/services, or by executing the command's verbose option, if available.
 - b. Retry the operation and examine the logs.



2. Ensure that the specified robot number and volume group are compatible. If volumes in the volume group have a given robot number (for example, 0), then volumes with a different robot number (for example, 1) cannot be added to that volume group. Volumes cannot be moved directly from one robotic volume group to another robotic volume group since the intermediate steps (some volume entries changed, some not) would cause a conflict with robot numbers. Choose a different volume group on the request, or let the volume group be automatically selected. Volume group selection depends on the specific interface being used.

Media Manager Status Code: 56

Message: invalid database version header

Explanation: `vmᄁ` could not find a recognizable volume database version in the volume database, and cannot initialize with the database currently in place. (`vmᄁ` is the Media Manager volume daemon on UNIX and the NetBackup Volume Manager service on Windows.)

Recommended Action:

1. Examine the daemon debug log for a more detailed message on the error.
 - a. If not already enabled, enable debug logging by creating the necessary directories/folders. Increase the level of verbosity by adding the VERBOSE option in the `vm.conf` file and restarting the volume daemon, or start `vmᄁ` with the verbose option.
 - b. Retry the operation and examine the logs.
2. From catalog backups or another source if available, restore an earlier version of the database file, `/usr/opensv/volmgr/database/volDB` (UNIX) or `install_path\Volmgr\database\volDB` (Windows), and restart `vmᄁ`.

Media Manager Status Code: 57

Message: error auto-generating volume group

Explanation: A request was made to add or change volumes in the volume configuration using automatic generation of the volume group name. A unique volume group name could not be generated because the available combinations were used up.

Recommended Action: Consolidate volumes into volume groups within the targeted robot number so that a new volume group can be automatically generated, or provide a specific volume group name.

Media Manager Status Code: 58

Message: daemon cannot obtain socket

Explanation: `vmnd` could not bind to its socket. (`vmnd` is the Media Manager volume daemon on UNIX and the NetBackup Volume Manager service on Windows.) A system call failed when `vmnd` attempted to bind to its configured port number. This is usually caused by another process having acquired the port before the `vmnd` daemon or service started.

Recommended Action:

1. Examine the daemon debug log for a more detailed message on the system error.
 - a. If not already enabled, enable debug logging by creating the necessary directories/folders. Increase the level of verbosity by adding the `VERBOSE` option in the `vm.conf` file and restarting the volume daemon, or start `vmnd` with the `verbose` option.
 - b. Retry the operation and examine the logs.
2. If another process has the port, use other system commands to determine the process. Based on the result, either change the port number in your services file or `map`, or terminate the process that has acquired the port.
3. UNIX only: Another possible cause for this error is terminating `vmnd` with the `kill` command. If you have to stop `vmnd`, the recommended method is to use the **Terminate Media Manager Volume Daemon** option on the **Special Actions** menu in `vmadm` (or the equivalent command line request, `vmctrldbm -t`). Using the `kill` command to stop this process can leave it unable to bind to its assigned port the next time it is restarted. When the socket problem has occurred, the daemon debug log contains lines similar to the following:

```
unable to obtain bound socket, Address already in use (125)
```

Media Manager Status Code: 59

Message: daemon failed accepting connection

Explanation: `vmnd` could not accept a new connection due to a system call failure. (`vmnd` is the Media Manager volume daemon on UNIX and the NetBackup Volume Manager service on Windows.)

Recommended Action:

1. Examine the daemon debug log for a more detailed message on the system error.
 - a. If not already enabled, enable debug logging by creating the necessary directories/folders. Increase the level of verbosity by adding the VERBOSE option in the `vm.conf` file and restarting the volume daemon, or start `vmd` with the verbose option.
 - b. Retry the operation and examine the logs.
2. Obtain the specific system call failure from the debug log, and investigate operating system functionality related to the failure.

Media Manager Status Code: 60

Message: cannot perform operation on this host

Explanation: A requested operation is not functional on a particular host.

Recommended Action:

1. Examine command output (if available), debug logs, and system logs for a more detailed message on the error.
 - a. If not already enabled, enable debug logging by creating the necessary directories/folders. Increase the level of verbosity by adding the VERBOSE option in the `vm.conf` file and restarting the daemons/services, or by executing the command's verbose option, if available.
 - b. Retry the operation and examine the logs.
2. Device discovery must be invoked only on specific platforms where it is supported. Robot inventory update, with optical media formatting specified, must be invoked only on the host where the robotic control and optical drives are configured.

Media Manager Status Code: 61

Message: robot number and robot host mismatch

Explanation: A request was made to add or change volumes in the volume configuration, or to issue a robot inventory update request. A robot host was specified that differed from the robot host for other volumes in the same robot (defined as those volumes having the same robot number). All volumes in the volume database that have a given robot number (for instance, 0) must have the same robot host name.

Recommended Action:



1. Examine command output (if available), debug logs, and system logs for a more detailed message on the error.
 - a. If not already enabled, enable debug logging by creating the necessary directories/folders. Increase the level of verbosity by adding the VERBOSE option in the `vm.conf` file and restarting the daemons/services, or by executing the command's verbose option, if available.
 - b. Retry the operation and examine the logs.
2. Specify the robot host in the device configuration to be the same case-sensitive host name on all hosts where the robot is configured. Re-issue the request. As an alternative, use move by volume group to logically move all volumes from a robotic volume group to standalone and then back into the robot. Specify the robot host as the host name used in the robot configuration. Then re-issue the request.

Media Manager Status Code: 62

Message: failed redirecting input to pipe

Explanation: A system pipe could not be created.

Recommended Action: Check the interface output for the specific system error and investigate operating system functionality related to the failure.

Media Manager Status Code: 63

Message: child process killed by signal

Explanation: A robot inventory update process was terminated by an unexpected signal.

Recommended Action:

1. Examine interface output and debug logs for a more detailed message error.
 - a. If not already enabled, enable debug logging by creating the necessary directories/folders. Increase the level of verbosity by adding the VERBOSE option in the `vm.conf` file and restarting the daemons/services, or by executing the command's verbose option, if available.
 - b. Retry the operation and examine the logs. Ensure that the process is allowed to complete.

Media Manager Status Code: 64

Message: no child process to wait for



Explanation: A media management interface attempted to wait for a child process to complete, but unexpectedly found that there was no such child process to wait for.

Recommended Action:

Examine interface output and debug logs for a more detailed message error.

1. If not already enabled, enable debug logging by creating the necessary directories/folders. Increase the level of verbosity by adding the VERBOSE option in the `vm.conf` file and restarting the daemons/services, or by executing the command's verbose option, if available.
2. Retry the operation (or try using a different media management interface) and examine the logs.

Media Manager Status Code: 65

Message: volume group does not exist

Explanation: While processing a request, a volume group could not be found within the existing volume entries in the volume database.

Recommended Action:

1. Examine the daemon debug log for a more detailed message on the system error.
 - a. If not already enabled, enable debug logging by creating the necessary directories/folders. Increase the level of verbosity by adding the VERBOSE option in the `vm.conf` file and restarting the volume daemon, or start `vmd` with the verbose option.
 - b. Retry the operation and examine the logs.
2. Check for data integrity or consistency problems in the volume database by using a media management interface or `vmdb_dump`. Delete or move volume entries so that the volume group issues are corrected.

Media Manager Status Code: 66

Message: no cleaning tape available

Explanation: The volume database was queried for cleaning tapes by robot number. No cleaning tape in the specified robot with available cleanings remaining was found in the volume database.

Recommended Action:



Either add cleaning tapes to the robot (physically, and logically in the volume database with a media management interface), or change the number of allowed cleanings if a cleaning tape is already configured and the cleaning tape is to be used beyond its allocated use cycles. Then reissue the cleaning request, or wait for the cleaning request to be automatically submitted when a drive in the robot once again needs cleaning.

Media Manager Status Code: 67

Message: unable to send exit status

Explanation: vmd could not send the status of a requested operation to the requestor. (vmd is the Media Manager volume daemon on UNIX and the NetBackup Volume Manager service on Windows.)

Recommended Action:

1. Examine the daemon debug log for a more detailed message on the system error.
 - a. If not already enabled, enable debug logging by creating the necessary directories/folders. Increase the level of verbosity by adding the VERBOSE option in the vm.conf file and restarting the volume daemon, or start vmd with the verbose option.
 - b. Retry the operation and examine the logs.
2. Obtain the specific send or write system call failure from the debug log, and investigate operating system functionality related to the failure.
3. Check to see whether the command or application interface sending the request is aborting prematurely, as follows: enable reqlib debug logs, retry the operation, check the debug logs, and observe application interface output.

Media Manager Status Code: 68

Message: too many volumes in volume group

Explanation: A request was made to add or change volumes in the volume configuration, and the limit for the allowed number of volumes in a volume group was reached. The limit for the number of volumes in a volume group is based on the number of volumes allowed in a particular type of robot.

Recommended Action:

1. Examine command output (if available), debug logs, and system logs for a more detailed message on the error.
 - a. If not already enabled, enable debug logging by creating the necessary directories/folders. Increase the level of verbosity by adding the VERBOSE option in the `vm.conf` file and restarting the daemons/services, or by executing the command's verbose option, if available.
 - b. Retry the operation and examine the logs.
2. Check to see if volumes are defined in the volume database associated with a slot number zero that may not exist in the robot. Run a robot inventory Show contents of robot report and observe the starting slot number. If the starting slot number is one (1) and there is a volume defined in the robot at slot zero (0), delete the volume entry or move it to standalone so that the remaining available media slots can be utilized.

Media Manager Status Code: 69

Message: failed sending request to vmd

Explanation: A request could not be sent to `vmd` or to `opr`, even though the initial connection to the server process was successful. (`vmd` is the Media Manager volume daemon on UNIX or NetBackup Volume Manager service on Windows, and `opr` is the operator request daemon/process.)

Recommended Action:

1. Examine command output (if available), debug logs, and system logs for a more detailed message on the error.
 - a. If not already enabled, enable debug logging by creating the necessary directories/folders. Increase the level of verbosity by adding the VERBOSE option in the `vm.conf` file and restarting the daemons/services, or by executing the command's verbose option, if available.
 - b. Retry the operation and examine the logs.
2. Check to see whether the `vmd` or `opr` process continued to run once it received the connection from the requestor. Run `netstat -a` or an equivalent socket diagnostic utility. Look at the daemon debug log on the server-side system and the process status of `vmd/opr` to see if the server process is hung up.

Media Manager Status Code: 70

Message: cannot connect to vmd [on host *host name*]

Explanation: A process timed out while connecting to `vmᄁ` (the Media Manager volume daemon on UNIX or NetBackup Volume Manager service on Windows) or to `oprᄁ` (the operator request daemon/process). This problem can occur when a connection is attempted and the server process is not running. It can also occur if the network or server is heavily loaded and has slow response time.

Recommended Action:

1. On the host (Media Manager host, Device Host, or volume database host) where `vmᄁ` is the recipient of the connection, verify that the daemon/service is running. If the daemon/service is not running, start it. On Windows, `vmᄁ` is the NetBackup Volume Manager service.
2. If `vmᄁ` is already running, examine command output, debug logs, and system logs for a more detailed message on the error.
 - a. If not already enabled, enable debug logging by creating the necessary directories/folders. Increase the level of verbosity by adding the `VERBOSE` option in the `vm.conf` file and restarting the daemons/services, or execute the command's verbose option, if available.
 - b. Retry the operation and examine the logs.
3. Verify that the correct host names are defined in the configuration. Each robot definition contains a volume database host where volumes are configured for use in the robot. Each group of servers shares a common global device database host, which `vmᄁ` manages.
4. Check the services file. On UNIX, verify that the `/etc/services` file (and NIS services if NIS is used) has entries for the `vmᄁ` service. (Note that `oprᄁ` is always started by the `vmᄁ` service.) On Windows, verify that the `%systemroot%\system32\drivers\etc\services` file has the correct entry for `vmᄁ`. Also verify that the `vmᄁ` port number in the services file agrees with the port number configuration, which is noted in the man page for `vmᄁ(1M)`.
5. Verify that all operating system patches or service packs are installed.
6. Ensure that the Media Manager configuration is not tuned so that the load on `vmᄁ` exceeds its ability to service requests. Look for entries in the Media Manager configuration file, `vm.conf`, that increase the load. Consider placing the volume database on a higher performance server and file system if performance is an issue. Consider using inventory filtering for robot types that support it, to reduce the number of volumes in the volume configuration.



7. By checking utilities such as `ipcs -a`, ensure that shared memory is functioning properly. The `opr` process may not be responding, because it is having trouble attaching to shared memory.

Media Manager Status Code: 71

Message: failed sending to vmd

Explanation: An attempt to write data to a vmd socket failed. vmd is the Media Manager volume daemon (UNIX) or NetBackup Volume Manager service (Windows).

Recommended Action:

1. Examine command output (if available) and the daemon and reqlib debug logs for a more detailed message on the error.
 - a. If not already enabled, enable debug logging by creating the necessary directories/folders. Increase the level of verbosity by adding the VERBOSE option in the `vm.conf` file and restarting the daemons/services, or by executing the command's verbose option, if available.
 - b. Retry the operation and examine the logs.
2. Identify the system where vmd is running. This is usually termed the Media Manager host or volume database host, and defaults to the local system in some user interfaces (such as `vmadm`). Possible causes for the error are high network load, missing operating system patches or service packs, or unexpected vmd process failure.

Media Manager Status Code: 72

Message: failed receiving from vmd

Explanation: An attempt to read data from a vmd socket failed. vmd is the Media Manager volume daemon (UNIX) or NetBackup Volume Manager service (Windows).

Recommended Action:

1. Examine command output (if available) and the daemon and reqlib debug logs for a more detailed message on the error.
 - a. If not already enabled, enable debug logging by creating the necessary directories/folders. Increase the level of verbosity by adding the VERBOSE option in the `vm.conf` file and restarting the daemons/services, or by executing the command's verbose option, if available.
 - b. Retry the operation and examine the logs.

2. Identify the system where vmd is running. This is usually termed the Media Manager host or volume database host, and defaults to the local system in some user interfaces (such as vmadm). Possible causes for the error are high network load, missing operating system patches or service packs, or unexpected vmd process failure. Also, the socket read may have failed because the requested operation did not complete within a specified time period. Some requests to vmd can be affected by robotic process and vmd interactions, so check the system log for errors on the robotic control host.

Media Manager Status Code: 73

Message: invalid query type

Explanation: An invalid volume query request was attempted.

Recommended Action:

1. Examine command output (if available), debug logs, and system logs for a more detailed message on the error.
 - a. If not already enabled, enable debug logging by creating the necessary directories/folders. Increase the level of verbosity by adding the VERBOSE option in the `vm.conf` file and restarting the daemons/services, or by executing the command's verbose option, if available.
 - b. Retry the operation and examine the logs.
2. Verify that all Media Manager and user interface binaries are at a compatible version level.

Media Manager Status Code: 74

Message: invalid number of cleanings

Explanation: A request was made to change the number of cleanings remaining for one or more volumes in the volume configuration, and the value specified was not within the acceptable range. The number of cleanings value may also be invalid in the number of mounts/cleanings field of a barcode rule.

Recommended Action:

1. Examine command output (if available), debug logs, and system logs for a more detailed message on the error.
 - a. If not already enabled, enable debug logging by creating the necessary directories/folders. Increase the level of verbosity by adding the VERBOSE option in the `vm.conf` file and restarting the daemons/services, or by executing the command's verbose option, if available.
 - b. Retry the operation and examine the logs.
2. Specify a number of cleanings value within the acceptable range of 0 to 2,147,483,647.

Media Manager Status Code: 75

Message: invalid change type

Explanation: An invalid volume change request was attempted.

Recommended Action:

1. Examine command output (if available), debug logs, and system logs for a more detailed message on the error.
 - a. If not already enabled, enable debug logging by creating the necessary directories/folders. Increase the level of verbosity by adding the VERBOSE option in the `vm.conf` file and restarting the daemons/services, or by executing the command's verbose option, if available.
 - b. Retry the operation and examine the logs.
2. Verify that all Media Manager and user interface binaries are at a compatible version level.

Media Manager Status Code: 76

Message: cannot get host name

Explanation: The system call `gethostname(3C)` failed during an attempt to obtain the name of the local host.

Recommended Action:



1. Examine the command input, debug logs, and system logs for a more detailed message on the system error.
 - a. If not already enabled, enable debug logging by creating the necessary directories/folders. Increase the level of verbosity by adding the VERBOSE option in the `vm.conf` file and restarting the volume daemon, or start `vmd` with the verbose option
 - a. Retry the operation and examine the logs.
2. Obtain the specific system call failure from the debug log, and investigate operating system functionality related to the failure. Execute the `hostname` system command to see if the command is operating correctly.

Media Manager Status Code: 77**Message:** failed during `tpformat`**Explanation:** A request was made to format an optical platter, and the request failed or was aborted by the administrator.

- ◆ The optical volume format may have failed because a WORM (write-once, read many) platter cannot be reformatted.
- ◆ If the overwrite label option was not specified and the format operation is not interactive, the format optical operation will fail if the platter has already been formatted.
- ◆ If the administrator chooses to abort the format operation after it has been found that the platter has already been formatted, the format request will return with this status code.
- ◆ The format operation may have failed due to a device or media problem.

Recommended Action:

1. Examine command output (if available), debug logs, and system logs for a more detailed message on the format error.
 - a. If not already enabled, enable debug logging by creating the necessary directories/folders. Increase the level of verbosity by adding the VERBOSE option in the `vm.conf` file and restarting the daemons/services, or by executing the command's verbose option, if available.
 - b. Retry the operation and examine the logs.



2. For any of the cases listed under Explanation, choose a format operation appropriate for the current state of the platter and retry the format as needed using the `tpformat` command.

Media Manager Status Code: 78

Message: barcode does not exist in database

Explanation: A query volume by barcode request did not return a volume entry having the specified barcode, or barcode and media type.

Recommended Action:

1. Examine the daemon and reqlib debug logs for a more detailed message on the error.
 - a. If not already enabled, enable debug logging by creating the necessary directories/folders. Increase the level of verbosity by adding the VERBOSE option in the `vm.conf` file and restarting the volume daemon/NetBackup Volume Manager service, or start `vmd` with the verbose option.
 - b. Retry the operation and examine the logs.
2. Ensure that volumes are properly configured on the volume database host that matches the volume database host configured for the robot or set of standalone drives. Use `tpconfig -d` and `tpconfig -lsavdbhost` to list the configured volume database hosts. Select the current server (the one you are administering) to be the same as the host which is the correct volume database host for a targeted device. Update the volume or device configurations, target the correct volume database host, modify volume properties, or adjust search criteria as needed so that the volume query can find a matching volume. For media in their correct slot locations, execute the Rescan/update barcode request so that the barcode field in the volume configuration matches the actual barcode as interpreted by the robotic library barcode reader.

Media Manager Status Code: 79

Message: specified robot is unknown to vmd

Explanation: A request was made to query volumes by residence, and no volumes were found in the targeted volume configuration that matched the provided robot number, robot type, and robot host.

Recommended Action:



1. Examine command output (if available), debug logs, and system logs for a more detailed message on the error.
 - a. If not already enabled, enable debug logging by creating the necessary directories/folders. Increase the level of verbosity by adding the VERBOSE option in the `vm.conf` file and restarting the daemons/services, or by executing the command's verbose option, if available.
 - b. Retry the operation and examine the logs.
2. Ensure that volumes are properly configured on the volume database host that matches the volume database host configured for the robot or set of standalone drives. Use `tpconfig -d` and `tpconfig -lsavdbhost` to list the configured volume database hosts. Select the current server (the one you are administering) to be the same as the host which is the correct volume database host for a targeted device. Update the volume or device configurations, target the correct volume database host, modify volume properties, or adjust search criteria as needed so that the volume residence query can find a matching volume.

Media Manager Status Code: 80

Message: cannot update volume database due to existing errors

Explanation: `vmphyinv` is unable to update the volume database because of the existing errors. The errors could be:

- ◆ There is a Media Manager volume record belonging to a different robot with the same media ID as the media ID read from the tape header.
- ◆ The media type or media GUID or the volume pool of an assigned volume record needs to be changed.
- ◆ A barcode conflict is detected and `vmphyinv` needs to change the barcode of the existing volume record.

Recommended Action: `vmphyinv`, in such a scenario, generates a list of errors. Examine the output. You must resolve all these errors before running the utility again.

Media Manager Status Code: 81

Message: robot type and volume group mismatch

Explanation: A request was made to add volumes or change volume residences in the volume configuration, and the robot type and volume group associated with the volume configuration changes are in conflict with the requirements for volume groups. All volumes in a volume group are required to have the same residence, which includes having the same robot type. A requested operation may have tried to associate the special No Volume Group name "---" with a robotic residence.



Recommended Action:

1. Examine command output (if available), debug logs, and system logs for a more detailed message on the error.
 - a. If not already enabled, enable debug logging by creating the necessary directories/folders. Increase the level of verbosity by adding the VERBOSE option in the `vm.conf` file and restarting the daemons/services, or by executing the command's verbose option, if available.
 - b. Retry the operation and examine the logs.
2. Ensure that the specified robot residence and volume group are compatible with other volumes in the volume configuration that are in the specified volume group. Do not try to move volumes in the special No Volume Group name "----" to a robotic residence without moving them to a new or auto-generated volume group. Choose a different volume group on the request, or let the volume group be automatically selected. Volume group selection depends on the specific interface being used.

Media Manager Status Code: 82

Message: robot host and volume group mismatch

Explanation: A request was made to add volumes or change volume residences in the volume configuration, and the robot host and volume group associated with the volume configuration changes are in conflict with the requirements for volume groups. All volumes in a volume group are required to have the same residence, which includes having the same robot host, where robot host equivalence is defined as having the same case-sensitive robot host string.

Recommended Action:

1. Examine command output (if available), debug logs, and system logs for a more detailed message on the error.
 - a. If not already enabled, enable debug logging by creating the necessary directories/folders. Increase the level of verbosity by adding the VERBOSE option in the `vm.conf` file and restarting the daemons/services, or by executing the command's verbose option, if available.
 - b. Retry the operation and examine the logs.
2. Ensure that the specified robot residence and volume group are compatible with other volumes in the volume configuration that are in the specified volume group. Do not try to add volumes for a robot host using a different form of the robot host name. For example, "acme" is not the same as "acme.veritas.com." Use the same host name as

that used for other volumes in the volume group. If the robot host needs to be changed for volumes in a volume group, use a single move volume group request (available only in certain media management interfaces) to move the volume group to standalone residence. Then move the volume group back to the robotic residence, specifying the desired robot control host that will be associated with the new volume group.

Media Manager Status Code: 83

Message: device management error

Explanation: One of the device management errors occurred during the execution of `vmphyinv`.

Recommended Action:

Examine the command output and debug logs for more detailed information about the error.

- a. If not already enabled, enable debug logging by creating the necessary directories/folders. Increase the level of verbosity by adding the `VERBOSE` option in the `vm.conf` file and restarting the daemons/services, or by executing the command's verbose option, if available.
- b. Retry the operation and examine the logs.

Media Manager Status Code: 84

Message: this machine is not the volume database host

Explanation: A request was made to initiate `vmd` on a host other than the local host. `vmd` is the Media Manager volume daemon (UNIX) or NetBackup Volume Manager service (Windows).

`vmd` port numbers other than the default, or use of unsupported options, can affect which host and port is referenced in interfaces used to start `vmd`.

Recommended Action:

1. Initiate `vmd` on the local host only, by logging on to the host where `vmd` needs to be running and starting `vmd` on that host. On UNIX, execute `/usr/opensv/volmgr/bin/vmd [-v]`. On Windows NT, start the NetBackup Volume Manager service in Services of the system Control Panel. (On Windows 2000, Services is in Administrative Tools of the Control Panel.)
2. If more information is needed to explain the problem, examine command output (if available), debug logs, and system logs for a more detailed message on the error.



- a. If not already enabled, enable debug logging by creating the necessary directories/folders. Increase the level of verbosity by adding the VERBOSE option in the `vm.conf` file and restarting the daemons/services, or by executing the command's verbose option, if available.
 - b. Retry the operation and examine the logs.
3. Make sure port numbers are consistent.

Media Manager Status Code: 85

Message: volume daemon fork failed

Explanation: A Media Manager daemon or service could not create a child process due to an error received from the system. This is probably an intermittent error based on the availability of resources on the system.

Recommended Action:

1. Restart the service at a later time and investigate system problems that limit the number of processes.
2. Examine debug and system logs for a more detailed message on the error.
 - a. If not already enabled, enable debug logging by creating the necessary directories/folders. Increase the level of verbosity by adding the VERBOSE option in the `vm.conf` file and restarting the daemons/services, or by executing the command's verbose option, if available.
 - b. Retry the operation and examine the logs.

Media Manager Status Code: 86

Message: failed opening tmp output file

Explanation: The Media Manager configuration file (`vm.conf`) or temporary working file could not be opened.

Recommended Action: **On UNIX:** check for the existence and permissions of the `/usr/opensv/volmgr/misc` directory, `/tmp` directory, and `/usr/opensv/volmgr/vm.conf` file. **On Windows:** check for the existence and security properties of the `install_path\Volmgr\vm.conf` file.

Media Manager Status Code: 87

Message: failed redirecting tmp output file

Explanation: The system call `dup2 (3C)` failed during an attempt to direct interface output from a temporary file to the process's standard output.

Recommended Action: Investigate operating system functionality related to resource limits on the number of open files. Ensure that processes are not being interrupted by extraneous signals.

Media Manager Status Code: 88

Message: failed initiating child process

Explanation: A command could not be executed. This can occur because the permissions of the command do not allow it to be executed, or because system resources, such as memory and swap space, are insufficient.

Recommended Action:

1. Examine command output (if available), debug logs, and system logs for a more detailed message on the system error.
 - a. If not already enabled, enable debug logging by creating the necessary directories/folders. Increase the level of verbosity by adding the `VERBOSE` option in the `vm.conf` file and restarting the daemons/services, or by executing the command's verbose option, if available.
 - b. Retry the operation and examine the logs.
2. Check the permissions on the `vmcheckxxx`, `vmupdate`, and `oprđ` binaries, and (on Windows only) the `rđevmi` installed binary.

Media Manager Status Code: 89

Message: another daemon already exists

Explanation: `vmd` (the Media Manager volume daemon on UNIX or NetBackup Volume Manager service on Windows) was initializing and found that it was already running, according to the daemon/service lock file.

Recommended Action: Check to see if `vmd` is already running. Do not try to start another `vmd` daemon/service unless the running daemon/service is first shut down. Stop the running `vmd` with `vmctrlđbm -t`, or on Windows by using the system Services interface. If the daemon/service was unexpectedly terminated, remove the lock file, which is `/usr/openv/volmgr/misc/vmd.lock` (UNIX) or `install_path\Volmgr\misc\vmd.lock` (Windows), and try restarting `vmd`.



Media Manager Status Code: 90**Message:** invalid volume pool

Explanation: A request was made to add volumes, change the volume pool for a volume, add a barcode rule, or change a barcode rule. However, the volume pool name or number associated with the requested change is in conflict with the requirements for volume pools. These requirements are:

- ◆ Volumes in scratch pools cannot be assigned until they are first moved to another pool.
- ◆ Volume pool numbers cannot be negative.
- ◆ Volume pool names must consist of from 1 to 20 printable ASCII characters with no embedded whitespace.
- ◆ The None volume pool is the only valid pool for barcode rule entries that specify cleaning a media type.

Recommended Action:

1. Examine command output (if available), debug logs, and system logs for a more detailed message on the error.
 - a. If not already enabled, enable debug logging by creating the necessary directories/folders. Increase the level of verbosity by adding the `VERBOSE` option in the `vm.conf` file and restarting the daemons/services, or by executing the command's verbose option, if available.
 - b. Retry the operation and examine the logs.
2. Ensure that the volume pool specified does not violate the requirements noted. Use the `vmppool` command to display the pool information. Use the `vmrule` command to display the barcode rule information. Add or change volume pools and barcode rules as needed to rectify inconsistencies in cases where the databases are inconsistent or corrupted.

Media Manager Status Code: 91**Message:** cannot change volume pool for assigned volume

Explanation: A request was made to change the volume pool for a volume, and the volume is currently assigned. For optical volumes, the volume pool cannot be changed unless both sides of the optical platter are unassigned.

Recommended Action:

1. Examine command output (if available) and debug logs for a more detailed message on the error.
 - a. If not already enabled, enable debug logging by creating the necessary directories/folders. Increase the level of verbosity by adding the VERBOSE option in the `vm.conf` file and restarting the daemons/services, or by executing the command's verbose option, if available.
 - b. Retry the operation and examine the logs.
2. It is not possible to change the volume pool for assigned volumes. If no worthwhile data is on the volume, unassign the media using the appropriate application interface (which is `bpexpdate` for NetBackup) and then retry the change pool request. For optical media, if no worthwhile data is on either side of the platter, unassign both of the volumes before the change pool request is retried.

Media Manager Status Code: 92

Message: cannot delete assigned volume

Explanation: A delete request was made to a volume, and the volume is currently assigned. Optical volumes cannot be deleted unless both sides of the optical platter are unassigned.

Recommended Action:

1. Examine command output (if available) and debug logs for a more detailed message on the error.
 - a. If not already enabled, enable debug logging by creating the necessary directories/folders. Increase the level of verbosity by adding the VERBOSE option in the `vm.conf` file and restarting the daemons/services, or by executing the command's verbose option, if available.
 - b. Retry the operation and examine the logs.
2. It is not possible to delete assigned volumes. If no worthwhile data is on the volume, unassign the media using the appropriate application interface (which is `bpexpdate` for NetBackup) and then retry the delete volume request. For optical media, if no worthwhile data is on either side of the platter, unassign both of the volumes before attempting to delete them.

Media Manager Status Code: 93

Message: volume is already assigned



Explanation: A request was made to assign a volume, and the volume was already assigned, or for optical media, the volume partner was already assigned.

Recommended Action:

1. Examine command output (if available) and debug logs for a more detailed message on the error.
 - a. If not already enabled, enable debug logging by creating the necessary directories/folders. Increase the level of verbosity by adding the `VERBOSE` option in the `vm.conf` file and restarting the daemons/services, or by executing the command's verbose option, if available.
 - b. Retry the operation and examine the logs.
2. Do not try to manually assign volumes that are already assigned, because it is not valid except for one condition: you can assign volumes for NetBackup catalog backups if the volume is already assigned for NetBackup catalog backups. Check the device configuration to determine if the volume database host for the device is consistent with the volume configuration in the volume database. Applications may attempt to query multiple volume databases for volume-related requests, so ensure that duplicate media IDs are not used in volume configurations across multiple hosts. If duplicate IDs are found, either completely separate the configurations by not sharing any devices, or remove volumes with duplicate media IDs and consolidate volumes into one volume configuration. Always use barcodes that are unique with respect to the six (6) least significant characters across all media in all robots, or use media ID generation rules to ensure unique media IDs are generated when using robot inventory update.

Media Manager Status Code: 94

Message: volume is not in specified pool

Explanation: A request was made to assign a volume from a specified volume pool. The volume was either found to be in a different volume pool, or, for optical media, the volume partner was in a different volume pool.

Recommended Action:



1. Examine command output (if available) and debug logs for a more detailed message on the error.
 - a. If not already enabled, enable debug logging by creating the necessary directories/folders. Increase the level of verbosity by adding the VERBOSE option in the `vm.conf` file and restarting the daemons/services, or by executing the command's verbose option, if available.
 - b. Retry the operation and examine the logs.
2. When assigning volumes manually, specify the volume pool associated with the volume. Check the device configuration to determine if the volume database host for the device is consistent with the volume configuration in the volume database. Applications may attempt to query multiple volume databases for volume-related requests, so ensure that duplicate media IDs are not used in volume configurations across multiple hosts. If duplicate IDs are found, either completely separate the configurations by not sharing any devices, or remove volumes with duplicate media IDs and consolidate volumes into one volume configuration. Always use barcodes that are unique with respect to the six (6) least significant characters across all media in all robots, or use media ID generation rules to ensure unique media IDs are generated when using robot inventory update.

Media Manager Status Code: 95

Message: media ID is not the specified media type

Explanation: A request was made to assign or add a volume of a specified media type, but the volume or other physically similar volumes have a different media type.

Recommended Action:

1. Examine command output (if available) and debug logs for a more detailed message on the error.
 - a. If not already enabled, enable debug logging by creating the necessary directories/folders. Increase the level of verbosity by adding the VERBOSE option in the `vm.conf` file and restarting the daemons/services, or by executing the command's verbose option, if available.
 - b. Retry the operation and examine the logs.
2. When using robot inventory update to make changes to the volume configuration, ensure that all volumes of the same physical cartridge type (for example, 3590J in TLH robots) are mapped to a single media type, such as HCART. This ensures that all media in the robotic library can be mounted on drives with a compatible drive type.



3. When assigning volumes manually, specify the media type associated with the volume. Check the device configuration to determine if the volume database host for the device is consistent with the volume configuration in the volume database. Applications may attempt to query multiple volume databases for volume-related requests, so ensure that duplicate media IDs are not used in volume configurations across multiple hosts. If duplicate IDs are found, either completely separate the configurations by not sharing any devices, or remove volumes with duplicate media IDs and consolidate volumes into one volume configuration. Always use barcodes that are unique with respect to the six (6) least significant characters across all media in all robots, or use media ID generation rules to ensure unique media IDs are generated when using robot inventory update.

Media Manager Status Code: 96

Message: oprd returned abnormal status

Explanation: A request serviced by `oprd` (the operator request daemon/process) or by `rdevmi` (the remote device management interface) returned an abnormal status.

Recommended Action:

1. On Windows, when auto-configuring devices or initiating the NetBackup Device Manager service from a graphical or command line interface, ensure that the service has not been disabled in the system services configuration.
2. Examine command output (if available), debug logs, and system logs for a more detailed message on the error.
 - a. If not already enabled, enable debug logging by creating the necessary directories/folders. Increase the level of verbosity by adding the `VERBOSE` option in the `vm.conf` file and restarting the daemons/services, or by executing the command's verbose option, if available.
 - b. Retry the operation and examine the logs.
3. Operator request daemon/process and remote device management errors are generally accompanied by device management-related errors that have occurred on a particular host. Check for errors in the debug and system/application logs on the host where `oprd` or `rdevmi` was started or running, which is often a targeted device host or scan host. The kinds of requests serviced by `oprd/rdevmi` that may have failed include: down/up/reset drives, change drive comments, deny/resubmit mount requests, assign drives, start/stop `ltid`, obtain `ltid` status, display drive status, manage pending actions, set NDMP attributes, configure devices, format optical platters, clean drives, obtain host version and device configuration information, and scan shared drives.

Media Manager Status Code: 97

Message: rule does not exist in rule database

Explanation: A request was made to change or delete a barcode rule, and no barcode rule having the specified barcode tag could be found.

Recommended Action:

1. Examine command output (if available) and debug logs for a more detailed message on the error.
 - a. If not already enabled, enable debug logging by creating the necessary directories/folders. Increase the level of verbosity by adding the VERBOSE option in the `vm.conf` file and restarting the daemons/services, or by executing the command's verbose option, if available.
 - b. Retry the operation and examine the logs.
2. List the configured barcode rules on the targeted volume database host. Adjust the barcode tag specified on the change/delete request or the targeted host as appropriate so that the barcode rule is found when the request is retried.

Media Manager Status Code: 98

Message: rule database truncate operation failed

Explanation: The system call `ftruncate(3C)` failed during an attempt to rewrite the barcode rule database during a barcode rule change/delete operation.

Recommended Action:

1. Examine command output (if available) and debug logs for a more detailed message on the system error.
 - a. If not already enabled, enable debug logging by creating the necessary directories/folders. Increase the level of verbosity by adding the VERBOSE option in the `vm.conf` file and restarting the daemons/services, or by executing the command's verbose option, if available.
 - b. Retry the operation and examine the logs.
2. Investigate the integrity of the file system and barcode rule database: on UNIX, `/usr/opencv/volmgr/database/ruleDB`; on Windows, `install_path\Volmgr\database\ruleDB`.



Media Manager Status Code: 99

Message: user is not valid for this host

Explanation: A request was made to add or change a volume pool, and the specified UNIX user ID could not be found on the system that originated the request.

Recommended Action:

1. Examine command output (if available) and debug logs for a more detailed message on the error.
 - a. If not already enabled, enable debug logging by creating the necessary directories/folders. Increase the level of verbosity by adding the `VERBOSE` option in the `vm.conf` file and restarting the daemons/services, or by executing the command's verbose option, if available.
 - b. Retry the operation and examine the logs.
2. On the UNIX host where the request originated, check the system user configuration and ensure that add/change pool requests include only valid user IDs. No validation is attempted for user IDs in volume pools on Windows.

Media Manager Status Code: 100

Message: the requested slot is empty

Explanation: A request was made to validate/update the barcode for a volume, and information from the robot indicated that there was no volume in the robot that used the requested slot for its home location.

Recommended Action:

The volume configuration is not consistent with the physical contents of the robotic library that is associated with the volume. The volume configuration or media placement in the robotic library needs to be adjusted using one of the media management interfaces.

Update/validate barcode requests are made for each volume affected whenever a volume configuration is added or changed. Volume entries are still changed when the update/validate step fails, so administrative steps are required to ensure that volume entries are defined only for media slots in the library where the correct media resides. For media located in drives at the time the update/validate barcode is tried, the robotic information will relate the media with its known home slot location.

Media Manager Status Code: 101

Message: media type and volume group mismatch

Explanation: A request was made to add volumes or change volume residences in the volume configuration, and the media type and volume group associated with the volume configuration changes are in conflict with the requirements for volume groups. All volumes in a volume group are required to have the same residence, which includes having the same media type. Media types used for data and their associated cleaning media types are considered as being the same media types with regard to volume group restrictions.

Recommended Action:

1. Examine command output (if available), debug logs, and system logs for a more detailed message on the error.
 - a. If not already enabled, enable debug logging by creating the necessary directories/folders. Increase the level of verbosity by adding the VERBOSE option in the `vm.conf` file and restarting the daemons/services, or by executing the command's verbose option, if available.
 - b. Retry the operation and examine the logs.
2. Ensure that the specified media type and volume group are compatible with other volumes in the volume configuration that are in the specified volume group. Choose a different volume group on the request, or let the volume group be automatically selected. Volume group selection depends on the interface being used.

Media Manager Status Code: 102

Message: invalid pool database entry

Explanation: The volume pool database is corrupt, in that it contains records that are not compatible with the installed product binaries.

Recommended Action:

1. Examine command output (if available) and debug logs for a more detailed message on the error.
 - a. If not already enabled, enable debug logging by creating the necessary directories/folders. Increase the level of verbosity by adding the VERBOSE option in the `vm.conf` file and restarting the daemons/services, or by executing the command's verbose option, if available.
 - b. Retry the operation and examine the logs.



2. Use `vmppool` to investigate the integrity of the volume pool database. The daemon debug log file should indicate the number of fields expected and the number of fields found in the pool record. Restore a saved version of the pool database if the pool database cannot be manually corrected.

Media Manager Status Code: 103

Message: all available pool numbers are in use

Explanation: A request was made to add a volume pool in the volume pool configuration, but no unique pool numbers could be generated because the available pool numbers were used up.

Recommended Action: Consolidate volume pools so that a new pool number becomes available.

Media Manager Status Code: 104

Message: failed appending to pool database

Explanation: A request was made to add, change, or delete a volume pool in the volume pool configuration, but a pool record could not be appended to the volume pool database file.

Recommended Action:

1. Examine the daemon debug log for a more detailed message on the system error.
 - a. If not already enabled, enable debug logging by creating the necessary directories/folders. Increase the level of verbosity by adding the `VERBOSE` option in the `vm.conf` file and restarting the volume daemon/NetBackup Volume Manager service, or start `vmd` with the verbose option.
 - b. Retry the operation and examine the logs.
2. Examine the permissions and available file system space for writing to the database: on UNIX, `/usr/opensv/volmgr/database/poolDB`; on Windows, `install_path\Volmgr\database\poolDB`.

Media Manager Status Code: 105

Message: poolname is not unique in pool database

Explanation: A request was made to add a volume pool in the volume pool configuration, but the pool name specified was a duplicate of the name for an existing volume pool.

Recommended Action: On the add volume pool request, specify a volume pool name that is not already in use on the targeted volume database host.

Media Manager Status Code: 106

Message: pool database lock operation failed

Explanation: vmd (the Media Manager volume daemon on UNIX) encountered a system call error while attempting to lock the volume pool database.

Recommended Action:

1. Examine the daemon debug log for a more detailed message on the system error.
 - a. If not already enabled, enable debug logging by creating the necessary directories/folders. Increase the level of verbosity by adding the VERBOSE option in the vm.conf file and restarting the volume daemon, or start vmd with the verbose option.
 - b. Retry the operation and examine the logs.
2. Use the `vmmps` command to ensure that `vmd` and `vmdb_dump` are not both running at the same time.
3. Ensure that no other process has a lock on the volume pool database file, `/usr/opensv/volmgr/database/poolDB`.

Media Manager Status Code: 107

Message: pool database close operation failed

Explanation: An error occurred when vmd attempted to close the volume pool database.

Recommended Action:

Examine the daemon debug log for a more detailed message on the system error.

- a. If not already enabled, enable debug logging by creating the necessary directories/folders. Increase the level of verbosity by adding the VERBOSE option in the vm.conf file and restarting the volume daemon/NetBackup Volume Manager service, or start vmd with the verbose option.
- b. Retry the operation and examine the logs.

Media Manager Status Code: 108

Message: pool database open operation failed

Explanation: A requested operation was unable to open the volume pool database file.



Recommended Action: Check for the existence and permissions of the `poolDB` file in the following: on UNIX, `/usr/opensv/volmgr/database` directory; on Windows, `install_path\Volmgr\database` folder. Restore the `poolDB` file from the catalog backups or from another location, change the access permissions on the existing `poolDB`, or move/rename the current `poolDB` so that `vmd` can initialize a default pool configuration. If the move/rename method is used, modify the volume and other application configurations so that no references are made to volume pools that no longer exist.

Media Manager Status Code: 109

Message: pool does not exist in pool database

Explanation: A requested operation encountered a case where the specified volume pool was not found in the volume pool configuration on the targeted volume database host. The requests potentially returning this error code are: add/change/delete/query volume pool, add/change barcode rule, add/change volume, query scratch volumes, and robot inventory report or update.

Recommended Action:

1. Examine the daemon and `reqlib` debug logs for a more detailed message on the error.
 - a. If not already enabled, enable debug logging by creating the necessary directories/folders. Increase the level of verbosity by adding the `VERBOSE` option in the `vm.conf` file and restarting the volume daemon/NetBackup Volume Manager service, or start `vmd` with the `verbose` option.
 - b. Retry the operation and examine the logs.
2. Ensure that volumes are properly configured on the volume database host that matches the volume database host configured for the robot or set of standalone drives. Use the `tpconfig -d` and `tpconfig -lsavdbhost` commands to list the configured volume database hosts. Select the current server (the one you are administering) to be the same as the host which is the correct volume database host for a targeted device.
3. Update the volume or device configurations, specify the correct volume database host, modify volume properties, or adjust search criteria as needed so that the requested operation can find the requested volume pool. Investigate inconsistencies between the volume database and the volume pool database, and restore or correct those databases from a previous state as needed.

Media Manager Status Code: 110

Message: pool database truncate operation failed

Explanation: The system call `ftruncate(3C)` failed during an attempt to rewrite the volume pool database during a volume pool add/change/delete operation.

Recommended Action:

1. Examine command output (if available) and debug logs for a more detailed message on the system error.
 - a. If not already enabled, enable debug logging by creating the necessary directories/folders. Increase the level of verbosity by adding the `VERBOSE` option in the `vm.conf` file and restarting the daemons/services, or execute the command's verbose option, if available.
 - b. Retry the operation and examine the logs.
2. Investigate the integrity of the file system and volume pool database, `/usr/opensv/volmgr/database/poolDB` (UNIX) or `install_path\Volmgr\database\poolDB` (Windows).

Media Manager Status Code: 111

Message: the specified pool is not empty

Explanation: On a request to delete a volume pool, it was found that the pool was not empty, or it could not be determined whether or not volumes were still associated with the specified volume pool.

Recommended Action:

1. Examine command output (if available) and debug logs for a more detailed message on the error.
 - a. If not already enabled, enable debug logging by creating the necessary directories/folders. Increase the level of verbosity by adding the `VERBOSE` option in the `vm.conf` file and restarting the daemons/services, or execute the command's verbose option, if available.
 - b. Retry the operation and examine the logs.
2. Use a media management interface to query for volumes associated with the pool specified for deletion. Ensure that all volumes in a volume pool are reassigned to another pool before trying to delete the volume pool. Use change volume operations to change the volume pool for a volume. Check for possible volume database lock or seek errors (Media Manager code 29 or 30).



Media Manager Status Code: 112

Message: no pools in the pool list

Explanation: The volume pool list was unexpectedly found to be empty.

Recommended Action: The volume pool list should contain a minimum of three pools: None, NetBackup, and DataStore. Investigate the integrity of the volume pool database, `/usr/opensv/volmgr/database/poolDB` (UNIX) or `install_path\Volmgr\database\poolDB` (Windows) on the host returning the error. Restore the volume database from catalog backups. As an alternative, reinitialize the volume database to include the None, NetBackup, and DataStore volume pools. To reinitialize it, remove the volume pool database and make any request to vmd, such as can be done by pointing a media management interface at the appropriate volume database host.

Media Manager Status Code: 113

Message: invalid expiration date

Explanation: A request was made to change the media expiration for one or more volumes in the volume configuration, but the date specified was not valid.

Recommended Action:

When changing the media expiration, provide the date in the format specified by the media management interface documentation.

Media Manager Status Code: 114

Message: invalid maximum mounts

Explanation: A request was made to change the limit for the number of times a volume can be mounted with write access for one or more volumes in the volume configuration, but the value specified was not within the acceptable range. The maximum number of mounts value may also be invalid in the number of mounts/cleanings field of a barcode rule.

Recommended Action:

1. Examine command output (if available), debug logs, and system logs for a more detailed message on the error.
 - a. If not already enabled, enable debug logging by creating the necessary directories/folders. Increase the level of verbosity by adding the VERBOSE option in the vm.conf file and restarting the daemons/services, or execute the command's verbose option, if available.
 - b. Retry the operation and examine the logs.



2. Specify a maximum mounts value within the range of 0 to 2,147,483,647.

Media Manager Status Code: 115

Message: volume has passed expiration date

Explanation: A request was made to assign a volume, and the volume expiration date has expired in relation to the current system date. For optical media, the volume partner expiration date has expired.

Recommended Action:

1. Examine command output (if available) and debug logs for a more detailed message on the error.
 - a. If not already enabled, enable debug logging by creating the necessary directories/folders. Increase the level of verbosity by adding the VERBOSE option in the vm.conf file and restarting the daemons/services, or execute the command's verbose option, if available.
 - b. Retry the operation and examine the logs.
2. Change the volume expiration date to a future date in relation to the current system date/time if you want to extend the active life of the physical media. Alternatively, replace the media with other media that still has useful life remaining. Check the system date/time and reset it correctly as needed.
3. If the media expiration is already set to a future date as compared to the current system date, check the device configuration to determine if the volume database host for the device is consistent with the volume configuration in the volume database. Applications may attempt to query multiple volume databases for volume-related requests, so ensure that duplicate media IDs are not used in volume configurations across multiple hosts. If duplicate IDs are found, either completely separate the configurations by not sharing any devices, or remove volumes with duplicate media IDs and consolidate volumes into one volume configuration. Always use barcodes that are unique with respect to the six (6) least significant characters across all media in all robots, or use media ID generation rules to ensure unique media IDs are generated when using robot inventory update.

Media Manager Status Code: 116

Message: volume has exceeded maximum mounts

Explanation: A request was made to assign a volume, and the volume's number of mounts has exceeded the maximum number of mounts allowed for the volume (or the maximum number allowed for the volume partner, in the case of optical media).



Recommended Action:

1. Examine command output (if available) and debug logs for a more detailed message on the error.
 - a. If not already enabled, enable debug logging by creating the necessary directories/folders. Increase the level of verbosity by adding the VERBOSE option in the vm.conf file and restarting the daemons/services, or execute the command's verbose option, if available.
 - b. Retry the operation and examine the logs.
2. Increase the volume's maximum number of mounts, or set the maximum number of mounts to infinite if you want to extend the active life of the physical media. Alternatively, replace the media with other media that still has useful life remaining.
3. If the number of mounts was less than the maximum mounts allowed for the volume, check the device configuration to determine if the volume database host for the device is consistent with the volume configuration in the volume database. Applications may attempt to query multiple volume databases for volume-related requests, so ensure that duplicate media IDs are not used in volume configurations across multiple hosts. If duplicate IDs are found, either completely separate the configurations by not sharing any devices, or remove volumes with duplicate media IDs and consolidate volumes into one volume configuration. Always use barcodes that are unique with respect to the six (6) least significant characters across all media in all robots, or use media ID generation rules to ensure unique media IDs are generated when using robot inventory update.

Media Manager Status Code: 117

Message: operation not allowed on cleaning cartridge

Explanation: A request was made to change a volume's expiration or maximum number of mounts, but the operation is not allowed because the volume is a cleaning cartridge.

Recommended Action:

1. If the volume is a cleaning cartridge, perform a valid operation such as changing the number of cleanings remaining for the cleaning cartridge.
2. If the volume's media type cannot be determined, examine command output (if available) and debug logs for a more detailed message on the error.

- a. Enable debug logging by creating the necessary directories/folders. Increase the level of verbosity by adding the VERBOSE option in the vm.conf file and restarting the daemons/services, or execute the command's verbose option, if available.
 - b. Retry the operation and examine the logs.
3. If the targeted volume is incorrectly configured as a cleaning tape, delete the cleaning volume and update the volume configuration using options to define a new volume with the appropriate media type.

Media Manager Status Code: 118

Message: cannot delete one of the default volume pools

Explanation: An attempt was made to delete one of the special, pre-defined volume pools. The None, NetBackup, and DataStore volume pools are fixed volume pools in the volume pool configuration, and cannot be deleted.

Recommended Action: Do not attempt to delete the None, NetBackup, and DataStore volume pools.

Media Manager Status Code: 119

Message: invalid rule database entry

Explanation: The barcode rule database is corrupt: it contains records that are not compatible with the installed product binaries.

Recommended Action:

1. Examine command output and debug logs for a more detailed message on the error.
 - a. Enable debug logging by creating the necessary directories/folders. Increase the level of verbosity by adding the VERBOSE option in the vm.conf file and restarting the daemons/services, or execute the command's verbose option, if available.
 - b. Retry the operation and examine the logs.
2. Use `vmrule` to investigate integrity of the barcode rule database. The daemon debug log file should indicate the number of fields expected and the number of fields found in the barcode rule record. Restore a saved version of the barcode rule database if the barcode rule database cannot be manually corrected.



Media Manager Status Code: 120

Message: all available rule numbers are in use

Explanation: A request was made to add a barcode rule in the barcode rule configuration. No unique rule numbers could be generated because the available rule numbers were used up.

Recommended Action: Consolidate barcode rules so that a new rule number becomes available.

Media Manager Status Code: 121

Message: failed appending to rule database

Explanation: A request was made to add, change, or delete a barcode rule, and a barcode rule record could not be appended to the barcode rule database file.

Recommended Action:

1. Examine the daemon debug log for a more detailed message on the system error
 - a. If not already enabled, enable debug logging by creating the necessary directories/folders. Increase the level of verbosity by adding the VERBOSE option in the vm.conf file and restarting the volume daemon/NetBackup Volume Manager service, or start vmd with the verbose option.
 - b. Retry the operation and examine the logs.
2. Examine the permissions and available file system space for writing to the database, /usr/opensv/volmgr/database/ruleDB (UNIX) or *install_path*\Volmgr\database\ruleDB (Windows).

Media Manager Status Code: 122

Message: barcode tag is not unique in rule database

Explanation: A request was made to add a barcode rule, and the barcode tag specified was a duplicate of the tag for an existing barcode rule.

Recommended Action: On the add barcode rule request, specify a barcode tag that is not already in use on the specified volume database host.

Media Manager Status Code: 123

Message: rule database lock operation failed



Explanation: vmd (the Media Manager volume daemon on UNIX) encountered a system call error while attempting to lock the barcode rule database. This status code applies to UNIX servers only.

Recommended Action:

1. Examine the daemon debug log for a more detailed message on the system error.
 - a. If not already enabled, enable debug logging by creating the necessary directories/folders. Increase the level of verbosity by adding the VERBOSE option in the vm.conf file and restarting the volume daemon, or start vmd with the verbose option.
 - b. Retry the operation and examine the logs.
2. Ensure that no other process has a lock on the barcode rule database file `/usr/opensv/volmgr/database/ruleDB`.

Media Manager Status Code: 124

Message: rule database close operation failed

Explanation: An error occurred when vmd attempted to close the barcode rule database.

Recommended Action: Examine the daemon debug log for a more detailed message on the system error.

1. If not already enabled, enable debug logging by creating the necessary directories/folders. Increase the level of verbosity by adding the VERBOSE option in the vm.conf file and restarting the volume daemon/NetBackup Volume Manager service, or start vmd with the verbose option.
2. Retry the operation and examine the logs.

Media Manager Status Code: 125

Message: rule database open operation failed

Explanation: A requested operation encountered a situation where the barcode rule database file could not be opened.

Recommended Action: Check for the existence and permissions of the ruleDB file in the `/usr/opensv/volmgr/database` directory on UNIX or `install_path\Volmgr\database` folder on Windows. Restore the ruleDB file from the catalog backups or from another location, change the access permissions on the existing ruleDB, or move/rename the current ruleDB so that vmd can initialize an



empty barcode rule configuration. If the move/rename method is used, re-add barcode rule entries as needed so that new media moved into the robotic library are assigned to the correct media types.

Media Manager Status Code: 126

Message: not authorized to connect to vmd

Explanation: A caller requesting services from vmd is either not authenticated or not authorized, or a problem was encountered when two systems were attempting to authenticate one another.

Recommended Action:

1. See the Media Manager system administrator's guides for detailed information on vmd security. vmd security is based on NetBackup authentication/authorization, but has extensions for handling SERVER entries in the Media Manager configuration file.
2. Examine the debug log files for a more detailed message on the authentication/authorization problem.
 - a. If not already enabled, enable debug logging by creating the necessary directories/folders. Increase the level of verbosity by adding the VERBOSE option in the vm.conf file and restarting the volume daemon/NetBackup Volume Manager service, or start vmd with the verbose option.
 - b. Retry the operation and examine the logs.
3. Correct the vmd security configuration by adjusting the authentication configuration, the AUTHORIZATION_REQUIRED entry, and SERVER entries.
4. If an authentication problem (rather than a configuration issue) is suspected, do the following:
 - a. Ensure that the authentication libraries exist:

Windows:

```
install_path\NetBackup\lib\libvopie.dll  
install_path\NetBackup\lib\libvnoauth.dll
```

UNIX (except HP-UX):

```
/usr/opensv/lib/libvopie.so  
/usr/opensv/lib/libvnoauth.so
```

UNIX (HP-UX only):

```
/usr/opensv/lib/libvopie.sl
```

```
/usr/opensv/lib/libvnoauth.sl
```

- b. Check the `methods_allow.txt` files on the systems that are having problems to ensure that authentication is enabled. The files are in the following locations:

Windows: `install_path\NetBackup\var\auth`

UNIX: `/usr/opensv/var/auth`

- c. On the systems that are having the authentication problem, remove the remote host that is not being authenticated from the `methods_allow.txt` file.

For example, if Host A and Host B are having the problem, remove Host A from the file on Host B, and vice versa.

Retry the operation.

- ◆ If the problem still exists, there are connection problems not related to authentication.
 - ◆ If connections are now successful, proceed to the next step.
- d. Execute `bpauthsync -vopie` on the master server to resynchronize the key files on the systems.

On Windows:

```
install_path\NetBackup\bin\admincmd\bpauthsync -vopie
-servers
```

On UNIX:

```
/usr/opensv/netbackup/bin/admincmd/bpauthsync -vopie -servers
```

- e. Add back the names removed in [step c](#) and retry the operation.

Media Manager Status Code: 127

Message: unable to generate a unique media id

Explanation: A request was made to add volumes in the volume configuration using robot inventory update or using a media ID seed. A unique media ID was not generated because the “use seed” option was not specified, or because the available media ID combinations were used up.

Recommended Action: If using robot inventory update, ensure that all media in the robotic library have readable barcode labels, or request updates using a seed to automatically generated media IDs for non-barcoded media. If volumes are being added by specifying a seed, use a seed that allows media ID character combinations beyond those already in use. To identify the slot associated with media that may not have a readable barcode, examine the command output.



Media Manager Status Code: 128

Message: group is not valid for this host

Explanation: A request was made to add or change a volume pool, and the specified UNIX group ID could not be found on the system that originated the request.

Recommended Action:

1. Examine command output (if available) and debug logs for a more detailed message on the error.
 - a. If not already enabled, enable debug logging by creating the necessary directories/folders. Increase the level of verbosity by adding the VERBOSE option in the vm.conf file and restarting the daemons/services, or execute the command's verbose option, if available.
 - b. Retry the operation and examine the logs.
2. On the UNIX host where the request originated, check the system group configuration and ensure that add/change pool requests include only valid group IDs. No validation is attempted for group IDs in volume pools on Windows.

Media Manager Status Code: 129

Message: invalid drive name

Explanation: A request was made to register, reserve, or release a shared drive with vmd/DA (the device allocator for the Shared Storage Option), and the drive name was not correctly formatted.

Recommended Action:

1. Examine the daemon and reqlib debug logs for a more detailed message on the error.
 - a. If not already enabled, enable debug logging by creating the necessary directories/folders. Increase the level of verbosity by adding the VERBOSE option in the vm.conf file and restarting the volume daemon/NetBackup Volume Manager service, or start vmd with the verbose option.
 - b. Retry the operation and examine the logs.
2. Ensure that the drive name is from 1 to 48 ASCII characters in length. The following special characters are allowed: period (.), plus (+), minus (-), underscore (_).
3. Verify that the correct version of software is running on all servers.



Media Manager Status Code: 130

Message: requested drive is already reserved

Explanation: A request was made to reserve a shared drive with vmd/DA (the device allocator for the Shared Storage Option), and the drive was already reserved for another host.

This is a normal occurrence when drive resources are being oversubscribed for either of these reasons: independent schedulers/applications accessing the same pool of drives, or hardware or media errors causing some drives allocated to jobs to become unavailable.

Recommended Action:

1. Check the system log and application (bptm) debug log to determine if hardware or media errors have caused drives to become unavailable.
2. If more information is needed on the drive reservation problem, examine command output (if available), debug logs, and system logs for a more detailed message on the error.
 - a. If not already enabled, enable debug logging by creating the necessary directories/folders. Increase the level of verbosity by adding the VERBOSE option in the vm.conf file and restarting the daemons/services, or execute the command's verbose option, if available.
 - b. Retry the operation and examine the logs.

Media Manager Status Code: 131

Message: requested drive is not registered for host

Explanation: A request was made to reserve a shared drive with vmd/DA (the device allocator for Shared Storage Option). The drive was not registered by the requesting host, although other drives had been registered by that host.

This is an abnormal condition that could occur if two different hosts with the same host name (local host name, overridden by any SSO_HOST_NAME entries in the Media Manager configuration file `vm.conf`) have registered different drive lists with vmd/DA, and one of those hosts has requested a drive reservation.

Recommended Action: Use unique (non-duplicate) strings for host names and SSO_HOST_NAME configuration file entries.

Media Manager Status Code: 132

Message: requested drive is not currently registered



Explanation: A request was made to reserve or release a shared drive with vmd/DA (the device allocator for the Shared Storage Option). The drive was not registered by the requesting host or any other hosts.

Recommended Action: This is an abnormal condition that could occur in the following situations:

- ◆ vmd/DA was stopped and restarted. This situation will be automatically handled, because the requesting host re-registers its drives with vmd/DA when this error is encountered.

Media Manager Status Code: 133

Message: requested drive is not reserved by host

Explanation: A request was made to release a shared drive with vmd/DA (the device allocator for the Shared Storage Option). The drive was not reserved by the requesting host, although it had been reserved for another host.

This is an abnormal condition that could occur if there was a network problem or a suspended process. The following is a possible scenario:

1. Host A reserves a shared drive.
2. Host A becomes unavailable for some time, unable to communicate with other hosts.
3. Host B determines that the host having the reservation (Host A) is no longer available, and makes a request to vmd/DA denoting Host A as unavailable.
4. Some other host (such as Host A or Host C) reserves the drive.
5. The host originally owning the drive reservation tries to release the drive.

Recommended Action: Correct the network or process problem that led to the communications problem. Ensure that unique non-duplicate strings are being used for host names and for SSO_HOST_NAME configuration file entries.

Media Manager Status Code: 134

Message: requested drive is not currently reserved

Explanation: A request was made to release a shared drive with vmd/DA (the device allocator for the Shared Storage Option SSO), but the drive was not reserved by any hosts.

This is an abnormal condition that could occur if there was a network problem or a suspended process. The following is a possible scenario:

1. Host A reserves a shared drive.
2. Host A becomes unavailable for some time, unable to communicate with other hosts.
3. Host B determines that the host having the reservation (Host A) is no longer available, and makes a request to vmd/DA denoting Host A as unavailable.
4. The host originally owning the drive reservation tries to release the drive.

Recommended Action: Correct the network or process problem that led to the communications problem. Ensure that unique non-duplicate strings are being used for host names and for SSO_HOST_NAME configuration file entries.

Media Manager Status Code: 135

Message: requested host is not currently registered

Explanation: A request was made to reserve or release a shared drive or designate a host as unavailable with vmd/DA (the device allocator for the Shared Storage Option). The host reserving or releasing the drive, or being designated as unavailable, was not registered with vmd/DA.

This is an abnormal condition that could occur in the following situations.

1. vmd/DA was stopped and restarted. This situation will be automatically handled, because the requesting host re-registers its drives with vmd/DA when this error is encountered.
2. A host has been unregistered with vmd/DA, and another host was in the process of declaring the host to be unavailable.

Recommended Action: In case 2, above, determine whether the host ought to be available. Correct the underlying network problems or restart `ltid` (the device daemon on UNIX or NetBackup Device Manager service on Windows).

Media Manager Status Code: 136

Message: invalid host name

Explanation: A device host was being added to the Media Manager configuration, or a request was made to vmd/DA, the device allocator for the Shared Storage Option (SSO), and the host name exceeded the allowable length.

Recommended Action: Limit host names to 256 ASCII characters or less.

Media Manager Status Code: 137

Message: oprd request is not supported on the remote host



Explanation: An invalid request was sent to the operator request process.

Recommended Action:

1. Examine command output (if available), debug logs, and system logs for a more detailed message on the error.
 - a. If not already enabled, enable debug logging by creating the necessary directories/folders. Increase the level of verbosity by adding the VERBOSE option in the vm.conf file and restarting the daemons/services, or execute the command's verbose option, if available.
 - b. Retry the operation and examine the logs.
2. Identify the targeted host and verify that all Media Manager binaries on that host are at a compatible version level with other hosts that are part of the configuration. Update the software version as needed.

Media Manager Status Code: 138

Message: media generation rule already exists

Explanation: You, or a NetBackup media management interface have attempted to add a MEDIA_ID_BARCODE_CHARS rule that already exists. The same rule cannot be added twice.

Recommended Action: Re-examine the listing of the MEDIA_ID_BARCODE_CHARS rules. For a description of MEDIA_ID_BARCODE_CHARS rules, refer to “Media Manager Reference Topics” in the *NetBackup Media Manager System Administrator’s Guide*.

Media Manager Status Code: 139

Message: media generation rule does not exist

Explanation: You, or a NetBackup media management interface have attempted to delete a MEDIA_ID_BARCODE_CHARS rule that does not exist.

Recommended Action: Re-examine a listing of the MEDIA_ID_BARCODE_CHARS rules. For a description of MEDIA_ID_BARCODE_CHARS rules, refer to “Media Manager Reference Topics” in the *NetBackup Media Manager System Administrator’s Guide*.

Media Manager Status Code: 140

Message: invalid media generation rule

Explanation: You, or a NetBackup media management interface have attempted to add an incorrect MEDIA_ID_BARCODE_CHARS rule.



Recommended Action: Ensure that the MEDIA_ID_BARCODE_CHARS rule is composed correctly. For a description of MEDIA_ID_BARCODE_CHARS rules, refer to “Media Manager Reference Topics” in the *NetBackup Media Manager System Administrator’s Guide*.

Media Manager Status Code: 141

Message: invalid number of mounts

Explanation: A request was made to change the number of times that a volume has been mounted, and the value specified was not within the acceptable range.

Recommended Action:

1. Examine command output (if available), debug logs, and system logs for a more detailed message on the error.
 - a. If not already enabled, enable debug logging by creating the necessary directories/folders. Increase the level of verbosity by adding the VERBOSE option in the vm.conf file and restarting the daemons/services, or execute the command's verbose option, if available.
 - b. Retry the operation and examine the logs.
2. Specify a number of mounts value within the acceptable range of 0 to 2,147,483,647.

Media Manager Status Code: 142

Message: invalid offsite location

Explanation: The offsite location for a volume exceeds 25 ASCII characters in length, or contains unprintable characters.

Recommended Action: When adding or changing a volume record, ensure that the offsite location field contains only printable characters and does not exceed 25 ASCII characters in length.

Media Manager Status Code: 143

Message: invalid offsite sent date

Explanation: A request was made to change the offsite sent date for one or more volumes in the volume configuration, and the date specified was not valid.

Recommended Action: When changing the offsite sent date, provide the date in the format specified by the Media Management interface documentation.



Media Manager Status Code: 144

Message: invalid offsite return date

Explanation: A request was made to change the offsite return date for one or more volumes in the volume configuration, and the date specified was not valid.

Recommended Action: When changing the offsite return date, provide the date in the format specified by the Media Management interface documentation.

Media Manager Status Code: 145

Message: requested drive is already reserved by host

Explanation: A request was made to reserve a shared drive with vmd/DA (the device allocator for the Shared Storage Option). The drive was already reserved for the requesting host.

This is an abnormal condition that could occur if two different hosts with the same host name (local host name, overridden by any SSO_HOST_NAME entries in the Media Manager configuration file, vm.conf) have registered the same drive name with vmd/DA. In this case, one of those hosts has a drive reservation, and the other host is trying to reserve the same drive.

Recommended Action: Use unique non-duplicate strings for host names and for SSO_HOST_NAME configuration file entries.

Media Manager Status Code: 146

Message: incompatible database version

Explanation: An invalid or unknown database or communications protocol was encountered by a requesting process or by vmd. (vmd is the volume daemon on UNIX or NetBackup Volume Manager service on Windows.) Possible data stores affected by such an error are volume, volume pool, barcode rule, global device database, and shared drive information.

Recommended Action:

1. Examine command output (if available), debug logs, and system logs for a more detailed message on the error.
 - a. If not already enabled, enable debug logging by creating the necessary directories/folders. Increase the level of verbosity by adding the VERBOSE option in the vm.conf file and restarting the daemons/services, or execute the command's verbose option, if available.
 - b. Retry the operation and examine the logs.



2. Identify the target components (for example, vmd and daemons/services, or user interfaces on local or remote hosts). Verify that all Media Manager binaries are at a compatible version level. Depending on which requests encountered the invalid version, determine whether or not the database is corrupt. Use an appropriate interface to query for the type of information involved in the error condition.

Media Manager Status Code: 147

Message: invalid offsite slot

Explanation: A request was made to change the offsite slot location for a volume, and the value specified was not within the acceptable range.

Recommended Action:

1. Examine command output (if available), debug logs, and system logs for a more detailed message on the error.
 - a. If not already enabled, enable debug logging by creating the necessary directories/folders. Increase the level of verbosity by adding the VERBOSE option in the vm.conf file and restarting the daemons/services, or execute the command's verbose option, if available.
 - b. Retry the operation and examine the logs.
2. Specify an offsite slot value within the range of 0 to 2,147,483,647.

Media Manager Status Code: 148

Message: invalid offsite session id

Explanation: A request was made to change the offsite session ID for a volume, and the value specified was not within the acceptable range.

Recommended Action:

1. Examine command output (if available), debug logs, and system logs for a more detailed message on the error.
 - a. If not already enabled, enable debug logging by creating the necessary directories/folders. Increase the level of verbosity by adding the VERBOSE option in the vm.conf file and restarting the daemons/services, or execute the command's verbose option, if available.
 - b. Retry the operation and examine the logs.
2. Specify an offsite session ID within the range of 0 to 2,147,483,647.



Media Manager Status Code: 149

Message: current version does not support this configuration

Explanation: A request cannot be performed because it attempted to reference functionality that is not licensed. An example of this is attempting to add a volume with a media type that is not valid for the licensed product.

Recommended Action:

1. Examine command output (if available) and debug logs for a more detailed message on the error.
 - a. If not already enabled, enable debug logging by creating the necessary directories/folders. Increase the level of verbosity by adding the VERBOSE option in the vm.conf file and restarting the daemons/services, or execute the command's verbose option, if available.
 - b. Retry the operation and examine the logs.
2. List the license keys installed and verify that the functionality being referenced is supported with the currently installed license keys. Check to see that the databases defining externalized object types are in place and not corrupted. These database files are the following, in the /usr/opensv/share directory (UNIX) or *install_path*\NetBackup\share folder (Windows):
 - ◆ external_densities.txt
 - ◆ external_drivetypes.txt
 - ◆ external_mediatypes.txt
 - ◆ external_robotics.txt

Media Manager Status Code: 150

Message: registering this host would exceed the maximum allowed

Explanation: vmd/DA (the Shared Storage Option (SSO) device allocator) received a request to register shared drives from a host that was not currently registered, and the maximum number of hosts registering with this DA had already been reached. The current limit for the number of hosts that can register with vmd/DA is 255. vmd is the Media Manager volume daemon (UNIX) or NetBackup Volume Manager service (Windows).

Recommended Action:

1. Restrict the size of the SSO configuration to no more than 255 hosts.
2. Ensure that obsolete hosts are completely unregistered with vmd/DA. The list of registered hosts can be obtained by viewing the Device Allocation Host Summary section of the Status of Shared Drives report in the NetBackup-Java administrative interface or by using `vmdareq -hostinfo -a`. Host registrations can be cleared out using `vmdareq -unregister -H <hostname>`, or by stopping and restarting vmd/DA on the device allocation host.

Note Do not stop vmd on the device allocation host while there are any active tape mounts, cleaning jobs, or application jobs.

3. Break up the media and device management domain into multiple domains, with all domains having 255 or fewer hosts that register shared drives.

Media Manager Status Code: 151

Message: invalid global device database entry

Explanation: vmd encountered a read error while reading a global device database record, or a memory allocation error while allocating table space for global device information. vmd is the Media Manager volume daemon (UNIX) or NetBackup Volume Manager service (Windows).

Recommended Action:

1. Examine the daemon debug log for a more detailed message on the system error.
 - a. If not already enabled, enable debug logging by creating the necessary directories/folders. Increase the level of verbosity by adding the VERBOSE option in the vm.conf file and restarting the volume daemon / NetBackup Volume Manager service, or start vmd with the verbose option.
 - b. Retry the operation and examine the logs.
2. The global device database may be corrupted. Restore an older volume database from a saved version or from catalog backups.
3. Free up memory by terminating unneeded processes that consume a lot of memory. Add more swap space or physical memory.

Media Manager Status Code: 152

Message: global device database record not found



Explanation: A request was made to update a global device database record, and the record specified was not found in the global device database. This condition could occur when a device configuration change is made after the global device database host has changed.

Recommended Action: If the request to update a global device database record fails because the record does not exist, a request is made to add the missing record to the global device database. No action is required.

Media Manager Status Code: 153

Message: device entry is not unique in global device database

Explanation: A request was made to add a global device database record, and the record specified was a duplicate of an existing record. This condition could occur if two processes are simultaneously updating the device configuration on the same host.

Recommended Action:

1. Coordinate changes to the device configuration so that changes come from a single source.
2. To investigate the details surrounding the global device database changes on the server (database) side, examine the daemon debug log file.
 - a. If not already enabled, enable debug logging by creating the necessary directories/folders. Increase the level of verbosity by adding the VERBOSE option in the vm.conf file and restarting the volume daemon / NetBackup Volume Manager service, or start vmd with the verbose option.
 - b. Retry the request to change the device configuration and examine the debug log file.

Media Manager Status Code: 154

Message: global device database truncate operation failed

Explanation: When the user was trying to change the device configuration, the system call `ftruncate(3C)` failed during an attempt to rewrite the global device database

Recommended Action:



1. Examine command output (if available) and debug logs for a more detailed message on the system error.
 - a. If not already enabled, enable debug logging by creating the necessary directories/folders. Increase the level of verbosity by adding the VERBOSE option in the vm.conf file and restarting the daemons/services, or execute the command's verbose option, if available.
 - b. Retry the operation and examine the logs.
2. Investigate the integrity of the file system and global device database, /usr/opensv/volmgr/database/globDB (UNIX) or *Install_path*\Volmgr\database\globDB (Windows).

Media Manager Status Code: 155

Message: global device database append operation failed

Explanation: A request was made to change the device configuration, and a global device database record could not be written to the global device database file.

1. Examine the daemon debug log for a more detailed message on the system error.
 - a. If not already enabled, enable debug logging by creating the necessary directories/folders. Increase the level of verbosity by adding the VERBOSE option in the vm.conf file and restarting the volume daemon / NetBackup Volume Manager service, or start vmd with the verbose option.
 - b. Retry the operation and examine the logs.
2. Examine the permissions and available file system space for writing to the database, /usr/opensv/volmgr/database/globDB (UNIX) or *install_path*\Volmgr\database\globDB (Windows).

Media Manager Status Code: 156

Message: global device database lock operation failed

Explanation: vmd, the Media Manager volume daemon (UNIX), encountered a system call error while attempting to lock the global device database.

Recommended Action:



1. Examine the daemon debug log for a more detailed message on the system error.
 - a. If not already enabled, enable debug logging by creating the necessary directories/folders. Increase the level of verbosity by adding the VERBOSE option in the vm.conf file and restarting the volume daemon, or start vmd with the verbose option.
 - b. Retry the operation and examine the logs.
2. Ensure that no other process has a lock on the global device database file `/usr/opensv/volmgr/database/globDB`.

Media Manager Status Code: 157

Message: global device database open operation failed

Explanation: A requested operation encountered a situation where the global device database file could not be opened.

Recommended Action:

1. Check for the existence and permissions of the globDB file in the `/usr/opensv/volmgr/database` directory or `install_path\Volmgr\database` folder.
2. Restore the globDB file from the catalog backups or from another location, change the access permissions on the existing globDB, or (as a last resort) move/rename the current globDB to start over with an empty global device configuration.
3. If the move/rename method is used, recreate all device configurations on all hosts.

Media Manager Status Code: 158

Message: global device database close operation failed

Explanation: An error occurred when vmd attempted to close the global device database.

Recommended Action: Examine the daemon debug log for a more detailed message on the system error.

1. If not already enabled, enable debug logging by creating the necessary directories/folders. Increase the level of verbosity by adding the VERBOSE option in the vm.conf file and restarting the volume daemon / NetBackup Volume Manager service, or start vmd with the verbose option.
2. Retry the operation and examine the logs.

Media Manager Status Code: 159

Message: the volume guid is not unique in the database

Explanation: A volume entry being added to or changed in the volume database had an RSM GUID specified which was a duplicate of the RSM GUID for another volume already in the volume database. All volumes in a volume database must have an RSM GUID that is either unique or null. (RSM is the Microsoft Removable Storage Manager, and GUID is a Global Unique Identifier.)

Recommended Action:

1. Examine command output (if available) and the daemon and reqlib debug logs for a more detailed message on the error.
 - a. Enable debug logging by creating the necessary directories/folders. Increase the level of verbosity by adding the VERBOSE option in the vm.conf file and restarting the daemons/services, or execute the command's verbose option, if available.
 - b. Retry the operation and examine the logs.
2. Try the following procedure:
 - a. From the daemon debug log file, determine the offset of the volume that has an RSM GUID conflict with the volume entry being added or changed. The offset is the index of the volume in the volume database.
 - b. Dump out all volume records in the volume configuration for the targeted volume database host using the `vmdb_dump` command. Look up the volume offset indicated in the debug log file, noting the associated RSM GUID, which is the field **volume_guid**.

The condition may have occurred because the media name for a volume may have been changed in the RSM media configuration, followed by a change to the volume configuration in Media Manager that caused a new volume to be added. Since RSM media names are equivalent to media IDs, if the existing media ID is not deleted from the volume configuration, the conflict appears when the new volume is added. Do not change media names in RSM if volume entries have already been established for the media in the volume configuration.

Media Manager Status Code: 160

Message: the global device database device type is invalid

Explanation: An invalid device type appeared in a request to modify the device configuration.



Recommended Action:

1. Examine command output (if available), debug logs, and system logs for a more detailed message on the error.
 - a. If not already enabled, enable debug logging by creating the necessary directories/folders. Increase the level of verbosity by adding the VERBOSE option in the vm.conf file and restarting the daemons/services, or execute the command's verbose option, if available.
 - b. Retry the operation and examine the logs.
2. Identify the targeted host and verify that all Media Manager binaries on that host are at a compatible version level with other hosts that are part of the configuration. Update the software version as needed.

Media Manager Status Code: 161

Message: the global device database device serial number is invalid

Explanation: An invalid or missing device serial number was encountered in a request to modify the device configuration.

Recommended Action:

1. Examine command output (if available), debug logs, and system logs for a more detailed message on the error.
 - a. If not already enabled, enable debug logging by creating the necessary directories/folders. Increase the level of verbosity by adding the VERBOSE option in the vm.conf file and restarting the daemons/services, or execute the command's verbose option, if available.
 - b. Retry the operation and examine the logs.
2. Identify the targeted host and verify that all Media Manager binaries on that host are at a compatible version level with other hosts that are part of the configuration. Update the software version as needed.

Media Manager Status Code: 162

Message: the global device database device name is invalid

Explanation: An invalid or missing device name was encountered in a request to modify the device configuration.

Recommended Action:



1. Examine command output (if available), debug logs, and system logs for a more detailed message on the error.
 - a. If not already enabled, enable debug logging by creating the necessary directories/folders. Increase the level of verbosity by adding the VERBOSE option in the vm.conf file and restarting the daemons/services, or execute the command's verbose option, if available.
 - b. Retry the operation and examine the logs.
2. Identify the targeted host and verify that all Media Manager binaries on that host are at a compatible version level with other hosts that are part of the configuration. Update the software version as needed.

Media Manager Status Code: 164

Message: the robotic daemon returned an invalid volume GUID

Explanation: An invalid RSM GUID was returned from the RSM robotic control process, which probably obtained it from the RSM API. (RSM is the Microsoft Removable Storage Manager, and GUID is a Global Unique Identifier.)

Recommended Action:

1. Examine the system's application log, the Removable Storage system interface, and the daemon and reqlib debug logs for a more detailed message on the error.
 - a. If it is not already enabled, enable debug logging by creating the necessary folders. Increase the level of verbosity by adding the VERBOSE option in the vm.conf file and restarting the NetBackup Device Manager service.
 - b. Retry the operation and examine the logs. From the daemon debug log file, determine the media ID that has the invalid RSM GUID.
2. Make sure that the software components are compatible.

Media Manager Status Code: 165

Message: Evaluation period expired. Go to www.veritas.com to order this product.

Explanation: The NetBackup evaluation software has expired. See www.veritas.com for ordering information.

Recommended Action: Obtain a licensed copy of NetBackup, which includes Media Manager.



Media Manager Status Code: 166

Message: media access port not available

Explanation: A request was made to physically move a volume into or out of a robotic library, but the media access port was found to be unavailable.

Recommended Action:

1. Examine command output (if available), debug logs, and system logs for a more detailed message on the error.
 - a. If it is not already enabled, enable debug logging by creating the necessary directories/folders. Increase the level of verbosity by adding the VERBOSE option in the vm.conf file and restarting the daemons/services, or execute the command's verbose option, if available.
 - b. Retry the operation and examine the logs.
2. Ensure that the physical move volume request for the robot type was not sent to a robotic control daemon/process on a system running an older, incompatible version of the software.
3. Ensure that the targeted robotic control daemon/process is operating normally.

Media Manager Status Code: 167

Message: ADAMM GUID is not unique in the database

Explanation: A volume entry being added to or changed in the volume database had an ADAMM GUID specified which was a duplicate of the ADAMM GUID for another volume already in the volume database. All volumes in a volume database must have an ADAMM GUID that is either unique or null. (ADAMM is Advanced Device and Media Management, and a GUID is a Global Unique Identifier.)

Recommended Action:

1. Examine command output (if available) and the daemon and reqlib debug logs for a more detailed message on the error.
 - a. If not already enabled, enable debug logging by creating the necessary directories/folders. Increase the level of verbosity by adding the VERBOSE option in the vm.conf file and restarting the daemons/services, or execute the command's verbose option, if available.
 - b. Retry the operation and examine the logs.



2. From the daemon debug log file, determine the offset of the volume that has an ADAMM GUID conflict with the volume entry that is being added or changed. (The offset is the index of the volume in the volume database.) Using the `vmdb_dump` command, dump out all volume records in the volume configuration for the targeted volume database host and look up the volume offset indicated in the debug log file. Note the associated ADAMM GUID, which is the field **adamm_guid**.

Media Manager Status Code: 168

Message: ADAMM GUID does not exist in database

Explanation: The volume database was queried for a specified ADAMM (Advanced Device and Media Management) GUID, and no volumes were found matching the specified criteria. (The GUID is a Global Unique Identifier.)

Recommended Action:

Run either `vmphyinv` or `bephyinv` for the media whose ADAMM GUID does not exist in the database.

Media Manager Status Code: 171

Message: a scratch pool is already defined

Explanation: A new scratch pool cannot be defined because another scratch pool already exists.

Recommended Action:

Use the scratch pool already defined, or delete the current scratch pool and create a new scratch pool.

Media Manager Status Code: 172

Message: pool not defined as a scratch pool

Explanation: You, or a NetBackup media management interface have tried to delete (unset) a scratch pool that is not defined as a scratch pool.

Recommended Action: To delete the scratch pool by using the `vmpool` command, make sure that the name of the pool specified with the `unset_scratch` option is the correct name of the scratch pool.

Media Manager Status Code: 173

Message: invalid scratch pool name



Explanation: You, or a NetBackup media management interface have tried to specify the NetBackup, DataStore, or None pool as a scratch pool. The NetBackup, DataStore, and None pools cannot be specified as scratch pools.

Recommended Action: Create a scratch pool with a different name.

Media Manager Status Code: 174

Message: unable to link to dynamic library

Explanation: An attempt to open and link to a dynamic library failed. This may be caused by a missing or unusable dynamic library for the EMC Symmetrix API. The error may be generated at both the server and the client; the dynamic libraries are used by the `ltid`, `tldd`, and `bptm` processes.

Recommended Action: Make sure that the EMC-supplied files `/usr/symapi/shlib/libsymapi.so` and `/usr/symapi/shlib/libsymlvm.so` exist on the system that reported the error. For new copies of these files, contact EMC.

Media Manager Status Code: 177

Message: request can only be performed on the Media and Device Management Domain Server

Explanation: The host this request was performed on has been blocked from being a database host. This was done by an administrator to restrict which hosts are allowed to be (volume and global device) database hosts.

Recommended Action:

1. Verify that you have specified the correct global database, volume database, pool database, or rule database host. This is the `-h` option on the command line. If you did not specify the database host, the command line defaults to the local host, while the console will use the host you are currently administering.
2. Contact the administrator in charge of this configuration and verify that the host was intentionally blocked from being a database host. If not, remove the `NOT_DATABASE_HOST` flag in the host's `vm.conf` file. To do so without having to stop and restart the daemons, use:
`vmquery -h <hostname> -remove_not_db_host.`
To add this entry to a host without having to stop and restart the daemons, use:
`vmquery -h <hostname> -add_not_db_host.`

Media Manager Status Code: 178

Message: failed to back up Media Manager databases

Explanation: The utility or function used was unable to create backup copies of the database files on the host specified.

Recommended Action:

1. Verify that you specified the correct host and that `vmdb` is running on the host specified.
2. Verify that the files exist and are intact. Files to verify are `volDB`, `globDB`, `poolDB`, and `ruleDB`.

Media Manager Status Code: 179

Message: there is an error in the integrity of this device domain

Explanation: this indicates that the global device database host is different from the target volume database host. In order to merge volume databases, the Media and Device Management Domain must be managed from the same host. This may also mean that a device in the global database on the target machine is configured to use a volume database host 'B', whose configured global database host 'C' is different than the target global database host.

Recommended Action:

1. Decide which host you want to be the Media and Device management Domain host. Put both the global device database and the volume database on this host.
2. Use the `-noverify` option for `vmdb_merge` if you are trying to move your volume database from the current volume database host to the Media and Device Management Domain Server.

Note This option is currently not supported and should be used with great caution.

Media Manager Status Code: 180

Message: the operation was attempted on an incompatible media server version

Explanation: One of the hosts affected by this function or utility is running a previous version of NetBackup. In order to use this function, all affected hosts, including remote media servers, must be running the latest version of NetBackup.

Recommended Action: Upgrade all of the affected hosts to the latest version of NetBackup.

Media Manager Status Code: 181

Message: not authorized to connect to robotic daemon



Explanation: A caller requesting services from a robotic daemon is either not authenticated or not authorized, or a problem was encountered when two systems were attempting to authenticate one another.

Recommended Action:

1. See the *Media Manager System Administrator's Guides* for detailed information on Media Manager security. Media Manager security is based on NetBackup authentication/authorization, but has extensions for handling SERVER entries in the Media Manager configuration file.
2. Examine the debug log files for a more detailed message on the authentication/authorization problem. Examine the debug log files for occurrences of Media Manager Status Code 126 ("not authorized to connect to vmd") to determine whether authorization is failing on vmd as well.
 - a. If not already enabled, enable debug logging by creating the necessary directories/folders. Increase the level of verbosity by adding the VERBOSE option in the vm.conf file and restarting ltid (the device daemon on UNIX or NetBackup Device Manager service on Windows) and the robotic control daemon(s). Alternatively, start ltid and the robotic control daemons with the verbose option.
 - b. Retry the operation and examine the logs.
3. Correct the Media Manager security configuration by adjusting the authentication configuration, the AUTHORIZATION_REQUIRED entry, the ENABLE_ROBOT_AUTH entry, and the SERVER entries.
4. If an authentication problem (rather than a configuration issue) is suspected, do the following:

- a. Ensure that the authentication libraries exist:

Windows:

```
install_path\NetBackup\lib\libvopie.dll  
install_path\NetBackup\lib\libvnoauth.dll
```

UNIX (except HP-UX):

```
/usr/opensv/lib/libvopie.so  
/usr/opensv/lib/libvnoauth.so
```

UNIX (HP-UX only):

```
/usr/opensv/lib/libvopie.sl  
/usr/opensv/lib/libvnoauth.sl
```

- b. Check the `methods_allow.txt` files on the systems that are having problems to ensure that authentication is enabled. The files are in the following locations:

Windows: `install_path\NetBackup\var\auth`

UNIX: `/usr/opensv/var/auth`

- c. On the systems that are having the authentication problem, remove the remote host that is not being authenticated from the `methods_allow.txt` file.

For example, if Host A and Host B are having the problem, remove Host A from the file on Host B, and vice versa.

Retry the operation.

- ◆ If the problem still exists, there are connection problems not related to authentication.
 - ◆ If connections are now successful, proceed to the next step.
- d. Execute `bpauthsync -vopie` on the master server to resynchronize the key files on the systems.

On Windows:

```
install_path\NetBackup\bin\admincmd\bpauthsync -vopie
-servers
```

On UNIX:

```
/usr/opensv/netbackup/bin/admincmd/bpauthsync -vopie -servers
```

- e. Add back the names removed in [step c](#) and retry the operation.

Media Manager Status Code: 183

Message: the entered volume status does not match existing status

Explanation: You entered the wrong value for the status of the volume when attempting to use `vmquery -deassignbyid`. Media management sees that value and assumes that it is assigned to someone else and therefore will not deassign the volume.

Recommended Action: Check the volume in question with `vmquery -m <volume_id>`, looking for the `staus` field. That is the number that should be used in conjunction with the `-deassignbyid` option of `vmquery`.

Media Manager Status Code: 185

Message: the robotic library is full and may still have media in its map



Explanation: The user attempted to use the `empty_map` option while doing a robot inventory update. The MAP contained more media than the library had space for. In this case, the inventory update was successful, the `empty_map` part was only partially successful. Those media still in the MAP are not changed or added in the volume database.

Recommended Action: There is no necessary action on the user's part except to be aware that not all of the media was removed from the MAP and placed into the library.

Media Manager Status Code: 187

Message: VxSS authentication failed

Explanation: The parties on either end of a socket connection were unable to mutually authenticate each other.

Recommended Action:

1. Ensure that the VERITAS Security Services is installed and configured. For complete installation instructions please see the *VERITAS Security Services Installation Guide*.
2. Check that both parties have a valid certificate. This can be done by examining the expiry date listed from a `bpnbat -WhoAmI`. For example:

```
bpnbat -WhoAmI
Name: JDOG
Domain: MYCOMPANY
Issued by: /CN=broker/OU=root@machine1.mycompany.com/O=vx
Expiry Date: Sep 19 12:51:55 2003 GMT
Authentication method: Microsoft Windows
Operation completed successfully.
```

Shows an expiry date of September 19th, 2003. After 12:51:55 GMT this credential is no longer valid and a new credential is required.

3. If running from the NetBackup Administration console, close and reopen the console. The console automatically obtains a credential for the currently logged in identity, if possible. By default these certificates are valid for 24 hours. To set a longer default time please consult the *VERITAS Security Services Administrator's Guide*.
4. Ensure that the certificates for both sides either use the same broker, are children of the same root broker, or have trusts established between them. See the *VERITAS Security Services Administrator's Guide* for more information on broker hierarchies and establishing trust relationships between brokers.

5. Ensure that connectivity is possible between the physical systems in question. If general sockets cannot connect between the machines (such as `ping` and `telnet`), there may be issues within the network unrelated to NetBackup that are causing this problem.
6. Please ensure that the system has sufficient swap space and the following directories are not full:
 - ◆ `/home/username`
 - ◆ `/user/opensv/netbackup/logs`
 - ◆ `/tmp`

Media Manager Status Code: 188

Message: VxSS Access Denied

Explanation: The user identity used to attempt an operation does not have the permissions needed to perform the action.

Recommended Action:

1. If using the default groups, make certain that the user is attempting to perform an operation appropriate for that group. For example, a member of `NBU_Operators` is unable to modify policy information; this is a permission reserved for administrator roles.
2. Ensure that the system has sufficient swap space and the following directories are not full:
 - ◆ `/home/username`
 - ◆ `/user/opensv/netbackup/logs`
 - ◆ `/tmp`
3. If using your own defined groups and permissions, first determine the object with which the operation is associated, and then add the permissions relative to the action. For example, if a user is required to up and down drives but does not currently have permission to do so, verify that the user belongs to the correct authorization group.

If needed, verify that the group has Up and Down permissions on the Drive object within the Group Permission tab. If necessary, you can increase the verbosity level of NetBackup to locate what object and what permissions are required for the failing request. The pertinent lines in the debug logs will look similar to the following:

```
17:19:27.653 [904.872] <2> GetAzinfo: Peer Cred Info.  
Name: JMIZZLE  
Domain: MYCOMPANY
```



```
Expiry: Sep 24 21:45:32 2003 GMT
Issued by: /CN=broker/OU=root@machine1.mycompany.com/O=vx
AuthType: 1
17:19:37.077 [904.872] <2> VssAzAuthorize: vss_az.cpp.5082:
Function: VssAzAuthorize. Object
```

```
NBU_RES_Drives
17:19:37.077 [904.872] <2> VssAzAuthorize: vss_az.cpp.5083:
Function: VssAzAuthorize. Permissions Up
17:19:40.171 [904.872] <2> VssAzAuthorize: vss_az.cpp.5166:
Function: VssAzAuthorize. 20 Permission denied.
```

In the instance illustrated above the user JMIZZLE is attempting to perform an operation that requires the Up permission on the Drives object. To diagnose the problem, examine the group(s) to which the user belongs to ensure that the appropriate group includes the Up permission (Up is a member of the Operate permission set for Drives).

Device Configuration Status Codes

These status codes appear in exit status and command output for the `tpconfig` and `tpautoconf` commands, and in system or debug logs. These codes are also presented by programs that call `tpconfig` and `tpautoconf`, such as media and device management user interfaces and the `vmoprCmd` command.

Device Configuration Status Code: 0

Message: Success

Explanation: A requested operation was successfully completed.

Recommended Action: None.

Device Configuration Status Code: 1

Message: Cannot execute command, permission denied

Explanation: The process was started by a user or process that did not have root privileges (on UNIX) or administrator privileges (on Windows), or the global device database host name could not be set.

Recommended Action:

1. If desired, give the user or process administrator privileges (on Windows) or root privileges (on UNIX) and reissue the device configuration request.
2. If the volume daemon (UNIX) or NetBackup Volume Manager service (Windows) is not running, start it and retry the operation that tried to set the global device database host name, such as during an install.
3. Establish a common global device database host name as follows:
 - ◆ Run `tpautoconf -get_gdbhost` on other hosts.
 - ◆ Set the global device database host name with

```
tpautoconf -set_gdbhost host_name
```

 where *host_name* is the host name returned by `tpautoconf -get_gdbhost`.
4. During a global database merge or preview status code 1 could be returned under the following conditions:
 - ◆ Cannot communicate with one of the required servers.

ACTION: Ensure that the `bp.conf` file contains the correct SERVER entries. Ensure that `bprd` and `vmc` are running on the SERVER.



- ◆ Server is not at the appropriate NetBackup version.
ACTION: Ensure that all servers are running NetBackup 4.5 Feature Pack 1 or later.
- ◆ Merge Conflicts exist.
ACTION: Correct any merge conflicts and rerun the command.
- ◆ Unable to send change command to remote server.
ACTION: Ensure that the `bp.conf` file contains the correct SERVER entries. Ensure that `bprd` and `vmd` are running on the SERVER.

Device Configuration Status Code: 2

Message: The `device_mappings` file has invalid license info

Explanation: The problem concerns one of the following files:

- ◆ `/usr/opensv/share/device_mappings.txt` (UNIX)
 - ◆ `install_path\VERITAS\NetBackup\share\device_mappings.txt` (Windows)
1. The file does not exist.
 2. The file is for a different version of NetBackup. You can find what version it is for by reading the header in the file.
 3. The file has a corrupted licensing digest.

Recommended Action: Download the latest device mapping file from the VERITAS support website at www.veritas.com.

Device Configuration Status Code: 3

This status code is no longer used.

Device Configuration Status Code: 4

Message: The global device database version is incompatible.

Explanation: The Device Configuration wizard is trying to store the global device information on a server that is at the wrong NetBackup server level.

Recommended Action: Choose a NetBackup server on which to store the global device information that is running at the same Netbackup version as that used on the host where the device discovery process was executed.

Device Configuration Status Code: 5

Message: Cannot synchronize global device database

Explanation: There was a failed request to synchronize the global device database with the local drive (`ltidevs`) or robot (`robotic_def`) databases. This could be caused by the Media Manager volume daemon / NetBackup Volume Manager service not running on the global device database host. This could also be caused by conflicting information between the global device database and the local databases mentioned above.

Recommended Action:

1. Examine command output (if available), debug logs, and system logs for a more detailed message on the error.
 - a. If not already enabled, enable debug logging by creating the necessary directories/folders (including the `tpcommand` log). Increase the level of verbosity by adding the `VERBOSE` option in the `vm.conf` file and restarting the daemons/services, or execute the command's verbose option, if available.
 - b. Retry the operation and examine the logs.
2. Verify that `vmc` is running on the global device database host.
3. Examine the device configurations of other hosts sharing the same global device database, looking for conflicts such as duplicate robot numbers with conflicting robot types.

Device Configuration Status Code: 6

Message: Robot type is not supported on this platform

Explanation: A request was made to add a robot, but the robot type is not supported on the device host.

Recommended Action: Check `www.veritas.com` and product release documentation for supported device configurations.

Device Configuration Status Code: 7

Message: Invalid SCSI port number for the robot

Explanation: A request was made to add or change the SCSI port number for a robot, but the SCSI port number provided was not valid.

Recommended Action:

1. Examine command output (if available), debug logs, and system logs for a more detailed message on the error.
 - a. If not already enabled, enable debug logging by creating the necessary directories/folders. Increase the level of verbosity by adding the VERBOSE option in the vm.conf file and restarting the daemons/services, or execute the command's verbose option, if available.
 - b. Retry the operation and examine the logs.
2. Specify the correct SCSI port number for the robot. Perform device discovery using the Device Configuration wizard, or check the Windows registry as needed to obtain the SCSI port number.

Device Configuration Status Code: 8

Message: Invalid SCSI bus number for the robot

Explanation: A request was made to add or change the SCSI bus number for a robot, but the SCSI bus number provided was not valid.

Recommended Action: Specify the correct SCSI bus number for the robot. Perform device discovery using the Device Configuration wizard, or check the Windows registry as needed to obtain the SCSI bus number.

Device Configuration Status Code: 9

Message: Invalid SCSI target for the robot

Explanation: A request was made to add or change the SCSI target for a robot, but the SCSI target provided was not valid.

Recommended Action: Specify the correct SCSI target for the robot. Perform device discovery using the Device Configuration wizard, or check the Windows registry as needed to obtain the SCSI target.

Device Configuration Status Code: 10

Message: Invalid SCSI logical unit number for the robot

Explanation: A request was made to add or change the SCSI logical unit number for a robot, but the SCSI logical unit number provided was not valid.

Recommended Action: Specify the correct SCSI logical unit number for the robot. Perform device discovery using the Device Configuration wizard, or check the Windows registry as needed to obtain the SCSI logical unit number.

Device Configuration Status Code: 11

Message: Invalid Usage

Explanation: One of the Media Manager device configuration commands (`tpconfig` or `tpautoconf`) was executed with improper options, or there is an incompatibility between components or versions of the product.

Recommended Action:

1. Examine command output (if available), debug logs, and system logs for a more detailed message on the error.
 - a. If not already enabled, enable debug logging by creating the necessary directories/folders. Increase the level of verbosity by adding the `VERBOSE` option in the `vm.conf` file and restarting the daemons/services, or execute the command's verbose option, if available.
 - b. Retry the operation and examine the logs.
2. Check the `tpconfig` or `tpautoconf` usage statement for expected usage and compare with the parameters being sent to start the new process.
3. Verify that all Media Manager binaries are at a compatible version level.

Device Configuration Status Code: 12

Message: Failed writing drive or robot config file

Explanation: A request was made to change the device configuration, but an error was encountered while writing to the device database.

Recommended Action:

1. Examine the daemon debug log and command or interface output for a more detailed message on the error.
 - a. If not already enabled, enable debug logging by creating the necessary directories/folders. Increase the level of verbosity by adding the `VERBOSE` option in the `vm.conf` file and restarting the volume daemon / NetBackup Volume Manager service, or start `vmd` with the verbose option.
 - b. Retry the operation and examine the logs.
2. Examine the permissions and available file system space for writing to the device configuration database files (`ltidevs` and `robotic_def`), located in the directory `/usr/opensv/volmgr/database` (UNIX) or in the folder



install_path\Volmgr\database (Windows). Display the device configuration to determine whether or not the database is corrupt, and restore a saved copy of the databases from catalog backups, or delete them and recreate the device configuration as needed.

Device Configuration Status Code: 13

Message: Failed reading drive or robot config file

Explanation: A request was made to change or list the device configuration, but an error was encountered while reading from the device database.

Recommended Action:

1. Examine the daemon debug log and command or interface output for a more detailed message on the error.
 - a. If not already enabled, enable debug logging by creating the necessary directories/folders. Increase the level of verbosity by adding the VERBOSE option in the vm.conf file and restarting the volume daemon / NetBackup Volume Manager service, or start vmd with the verbose option.
 - b. Retry the operation and examine the logs.
2. Examine the permissions and check for the existence of the device configuration database files (*ltidevs* and *robotic_def*), located in the directory */usr/opensv/volmgr/database* (UNIX) or the folder *install_path\Volmgr\database* (Windows). Display the device configuration to determine whether or not the database is corrupt. Restore a saved copy of the databases from catalog backups, or delete them and recreate the device configuration as needed.

Device Configuration Status Code: 14

Message: Invalid drive index

Explanation: A request was made to add, update, or list a drive configuration entry, and the specified drive index was not associated with a configured drive.

Recommended Action:

1. Display the device configuration to obtain the list of valid drives. Avoid making device configuration changes from multiple sources simultaneously.
2. If more information is needed, examine the daemon debug log and command or interface output for a more detailed message on the error.

- a. If not already enabled, enable debug logging by creating the necessary directories/folders. Increase the level of verbosity by adding the VERBOSE option in the vm.conf file and restarting the volume daemon / NetBackup Volume Manager service, or start vmd with the verbose option.
- b. Retry the operation and examine the log files.

Device Configuration Status Code: 15

Message: Invalid robot number

Explanation: On a request to modify the device configuration, the specified robot number was not within the allowable range, or the robot number did not correspond to a currently configured robot, or the robotic database is corrupted.

Recommended Action:

1. Specify a robot number in the range of 0 to 32767.
2. Ensure that all device configuration changes or deletions are performed on devices that are currently part of the device configuration.
3. Check the integrity of the robotic database file `robotic_def` located in the directory `/usr/opensv/volmgr/database` (UNIX) or the folder `install_path\Volmgr\database` (Windows), by displaying the contents of the device configuration. Restore a saved copy of the robotic database from catalog backups, or delete it and recreate any needed robotic configuration information.

Device Configuration Status Code: 16

Message: A SCSI inquiry sent to the device has failed

Explanation: On a request to add or update a SCSI robotic library or drive, Media Manager failed to obtain the serial number and inquiry string for the device. This information is obtained by Media Manager by sending a SCSI Inquiry command to the device. Failure indicates that NetBackup was not able to communicate with the device by means of SCSI.

Recommended Action:

1. Ensure that the device is physically connected.
2. Ensure that the operating system is configured to recognize the device and that the operating system can see the device.
3. Ensure that no other process is using the device and that the device is not offline.



Device Configuration Status Code: 17

Message: This robot type does not support multiple media types

Explanation: An attempt to add or update a robotic drive has failed because there are drives configured in this robotic library with a different drive type. (Some NetBackup robotic library types do not support multiple media types.) Refer to the *NetBackup Release Notes* or to the *NetBackup Media Manager System Administrator's Guide* for more information on which NetBackup robotic library types support multimedia.

Recommended Action:

1. Configure all drives for this robotic library with the same drive type.
2. If you are using NetBackup Server and want a robotic library with multiple media types, contact VERITAS to purchase NetBackup Enterprise Server.

Device Configuration Status Code: 18

Message: Invalid robot type

Explanation: On a request to modify the device configuration, the specified robot type was invalid, or it did not match the robot type for the robot associated with the specified robot number.

Recommended Action:

1. Check the device configuration for configured robots, and specify the correct robot type applicable for the device configuration information being updated.
2. Examine command output (if available), debug logs, and system logs for a more detailed message on the error.
 - a. Enable debug logging by creating the necessary directories/folders. Increase the level of verbosity by adding the VERBOSE option in the vm.conf file and restarting the daemons/services, or execute the command's verbose option, if available.
 - b. Retry the operation and examine the logs.
3. Verify that all Media Manager binaries are at a compatible version level.

Device Configuration Status Code: 19

Message: Invalid device path name

Explanation: On a request to change the device configuration, the specified device path or device name was not valid.



Recommended Action:

1. To avoid configuring invalid device paths and device names, use the Device Configuration wizard (on supported device discovery platforms) so that device paths and device names are automatically configured.
2. On Windows hosts, check the operating system configuration or registry for device names and refer to the `tpconfig` command in NetBackup online help. On UNIX hosts, refer to the appropriate chapter in the *NetBackup Device Configuration Guide*. Always use no-rewind device files for drives attached to UNIX hosts, and check to ensure that the specified device paths exist as character-special files. Check for detailed errors from the command or user interface output.

Device Configuration Status Code: 20

Message: Duplicate device path names

Explanation: The same device path name was used for the optical drive character and volume header names.

Recommended Action: Refer to the appropriate chapter in the *NetBackup Device Configuration Guide* to determine which optical drive names should be specified.

Device Configuration Status Code: 21

Message: Robot number is already in use

Explanation: On a request to add a robot to the device configuration, the robot number was found to be already in use for a different robot.

Recommended Action: Check the device configuration on all device hosts for configured robots, and specify a robot number that is not already in use. Use `tpautoconf -get_gdbhost` to obtain the global device database host, and use the following

```
vmglob -h global_device_database_host -listall
```

to display all devices sharing a common global device database.

Device Configuration Status Code: 22

Message: Device path is already in use

Explanation: On a request to add or change robot information in the device configuration, the specified robotic device path is already in use for another configured robot.

Recommended Action:



1. To avoid configuring device paths that are already in use, use the Device Configuration wizard (on supported device discovery platforms) so that device paths and device names are automatically configured.
2. Display the device configuration using `tpconfig -d` or a device configuration interface to see the robotic information that is already configured. On Windows hosts where there are multiple ways to configure robots (changer names or port/bus/target/LUN), check the operating system configuration or registry for changer names and their associated SCSI paths. Check for detailed errors from the command or user interface output.

Device Configuration Status Code: 24

Message: Incomplete robot information

Explanation: On a request to change the device configuration, some of the required robot information was not specified.

Recommended Action: Check the command usage and reissue the request with all required robot information specified.

Device Configuration Status Code: 25

Message: Robot drive number in use for this robot

Explanation: On a request to change the device configuration, the specified drive address in the robot was found to be already in use by another drive in the device configuration.

Recommended Action: The drive address in the robot is the robot drive number for most robot types, the ACS/LSM/PANEL/DRIVE coordinates for ACS robots, or a vendor drive name for TLH and TLM robots. Two drives cannot have the same drive address in a robot in a given device configuration. If the drive addresses need to be adjusted, either delete one of the drives or make use of an unused drive address as a temporary state. For example, if a robot has two drives with robot drive numbers 1 and 2 that need to be swapped, change one drive to use robot drive number 3 temporarily, change the other drive to use robot drive number 1 or 2 as appropriate, and finally change the first drive to the open robot drive address 1 or 2.

Device Configuration Status Code: 27

Message: Invalid drive type for the robot

Explanation: On a request to configure a drive to be in a robot, it was found that the drive type was not valid for the selected robot type.

Recommended Action: In the *NetBackup Media Manager System Administrator's Guide* appendices, check the Robot Attributes tables to determine valid media types for a given robot type. Drive types directly correspond to the listed media types. Configure supported devices so that invalid combinations of drive types and robot types are not required.

Device Configuration Status Code: 28

Message: Invalid robot drive number for the robot type

Explanation: On a request to configure a drive to be in a robot, it was found that the robot drive number was not valid for the selected robot type.

Recommended Action: The robot drive number, or for ACS robots the set of ACS drive identifiers, is limited to certain ranges based on the robot type. These limits are based on a supported device list. An invalid robot drive number means that the drive number was not within the acceptable range. Make sure that the robot hardware is supported and that the required patches are installed to support the robotic library. If the robot type is TLH or TLM, do not specify a robot drive number, because the drives are addressed using a vendor drive name.

Device Configuration Status Code: 29

Message: Drive index is in use by another drive

Explanation: On a request to add a drive to the device configuration, the requested drive index was found to be in use on the targeted device host.

Recommended Action:

1. To avoid configuring a drive index that is already in use, use the Device Configuration wizard (on supported device discovery platforms) so that the drive index is automatically configured.
2. If using a device configuration interface that allows the drive index to be specified, use `tpconfig -d` to determine the drive indexes that are already in use on the targeted device host, and specify a drive index that is not already in use.

Device Configuration Status Code: 30

Message: Robot number is in use by another robot

Explanation: On a request to add or update a robotic drive in the device configuration, it was found that the robot number and robot type specified were associated with an existing robot of a different robot type.



Recommended Action: Check the device configuration on the targeted device host and identify the configured robots. On the drive configuration request, specify both the robot number and robot type that relate to the robot containing the drive.

Device Configuration Status Code: 31

Message: Robot number does not exist

Explanation: On a request to add or update a drive or robot in the device configuration, it was found that the robot number and robot type specified were not associated with any configured robots on the targeted device host.

Recommended Action: Check the device configuration on the targeted device host and identify the configured robots. Every drive that is configured as a robotic drive must already have its robot configured on that device host. For shared robotic libraries having robotic control on a remote host, there must be a logical robotic entry that refers to the remote host having robotic control. Add the robot to the device configuration first, then add the drive, defining it to be in the robot. If the robot was already configured, specify the correct robot number and robot type on the drive or robot configuration request.

Device Configuration Status Code: 33

Message: Robot type must be controlled locally

Explanation: On a request to add or update a robot in the device configuration, a remote control host was specified for a library type which does not support it.

Recommended Action:

1. Check that you are configuring the correct robot type.
2. Configure the device with local control using its local device path.

Device Configuration Status Code: 34

Message: Drive name is already in use by another drive

Explanation: On a request to add or update a drive in the device configuration, the requested drive path was found to be in use on the targeted device host.

Recommended Action:

1. To avoid configuring paths that are already in use, use the Device Configuration wizard (on supported device discovery platforms) so that the drive paths are automatically configured.
2. Before making configuration changes, check the existing drive configuration through a device configuration interface or run `tpconfig -d` to determine the drive paths that are already in use on the targeted device host, and specify a drive path that is not already in use.

Device Configuration Status Code: 35

Message: Drive name does not exist

Explanation: On a request to update or delete a drive in the device configuration, no drives having the specified drive name were found on the targeted device host.

Recommended Action: Check the device configuration on the targeted device host and identify the configured drives. When making drive configuration changes or deletions, specify the drive name as it is configured, taking care to use the proper case.

Device Configuration Status Code: 36

Message: <NONE>

Explanation: On a request to make a device configuration change, an error occurred for which a detailed message has been displayed in the command or utility interface output.

Recommended Action: Examine the daemon debug log and command or interface output for a more detailed message on the error.

1. If not already enabled, enable debug logging by creating the necessary directories/folders. Increase the level of verbosity by adding the `VERBOSE` option in the `vm.conf` file and restarting the volume daemon / NetBackup Volume Manager service, or start `vmd` with the verbose option.
2. Retry the device configuration request and examine the logs.

Device Configuration Status Code: 37

Message: Residence is not licensed for shared drive support

Explanation: On a request to add or update a drive in the device configuration, the drive was specified as shared, but there is no support for shared drives for that drive type or for the type of robot associated with the drive.

Recommended Action: Check www.veritas.com and product release documentation for supported device configurations.



Device Configuration Status Code: 38

Message: Current version does not support remote device host

Explanation: On a request to change the global device database host or the volume database host for a residence, the specified host is not the local host, and the current software is not licensed to allow remote hosts.

Recommended Action: Check product documentation for supported device configurations. Obtain an additional software license that allows remote hosts to be configured, or specify only local host names on the configuration request.

Device Configuration Status Code: 39

Message: Adding this drive would exceed the maximum allowed

Explanation: On a request to add a drive to the device configuration, the licensed limit for the maximum number of drives was reached on the targeted host.

Recommended Action: Check product documentation for supported device configurations. Obtain an additional software license that allows more drives to be configured, or limit the configuration to the number of drives allowed by the current licensing.

Device Configuration Status Code: 40

Message: Adding this device would exceed the maximum allowed

Explanation: On a request to add a robot to the device configuration, the licensed limit for the maximum number of robots was reached on the targeted host.

Recommended Action: Check product documentation for supported device configurations. Obtain an additional software license that allows more robots to be configured, or limit the configuration to the number of robots allowed by the current licensing.

Device Configuration Status Code: 41

Message: Cannot change terminal mode

Explanation: A system call failed when an attempt was made to change the mode for terminal input between cooked and raw.

Recommended Action: Examine the user interface output for the system error associated with the failed system call, and troubleshoot according to operating system vendor recommendations.

Device Configuration Status Code: 42

Message: Cannot create miscellaneous working repository

Explanation: On a device configuration request, the miscellaneous working directory/folder was missing and could not be created.

Recommended Action: Find out why `/usr/opensv/volmgr/misc` (UNIX) or `install_path\volmgr\misc` (Windows) cannot be created. On Windows, determine which accounts the NetBackup Volume Manager service and device configuration interfaces are running under, and compare them with the security properties of the database folder. On UNIX, determine whether users or device configuration interface callers are running under a user and group with permissions to create the miscellaneous directory.

Device Configuration Status Code: 43

Message: Cannot backup/restore local device database files

Explanation: There was a failed request to create a backup copy, remove a backup copy, or replace the current copy of the local device databases. These databases are `ltidevs` and `robotic_def`, located in `/usr/opensv/volmgr/database` (UNIX) or `install_path\volmgr\database` (Windows).

Recommended Action:

1. Examine the daemon debug log and command or interface output for a more detailed message on the system error, as follows.
 - a. If not already enabled, enable debug logging by creating the necessary directories/folders. Increase the level of verbosity by adding the `VERBOSE` option in the `vm.conf` file and restarting the volume daemon / NetBackup Volume Manager service, or start `vmd` with the verbose option.
 - b. Retry the operation and examine the logs.
2. Examine the permissions and check for the existence of the local device database files. Display the device configuration to determine whether or not the database is corrupt, and restore a saved copy of the databases from catalog backups, or delete them and recreate the device configuration as needed.

Device Configuration Status Code: 44

Message: Cannot discover devices. See the Troubleshooting Guide for details.



Explanation: Any of the following: device discovery was attempted on a platform where it is not supported according to the currently installed software, there was an internal consistency problem with the global device database, or device discovery could not obtain or verify its lock file.

Recommended Action:

1. Check `www.veritas.com` and product release documentation for supported platforms for device discovery. Upgrade the installed software to the latest available patch level if documentation indicates that device discovery is supported on the targeted host platform.
2. Examine the daemon debug log and command or interface output for a more detailed message on the system error, as follows.
 - a. If not already enabled, enable debug logging by creating the necessary directories/folders. Increase the level of verbosity by adding the `VERBOSE` option in the `vm.conf` file and restarting the volume daemon / NetBackup Volume Manager service, or start `vm` with the `verbose` option.
 - b. Retry the operation and examine the logs. One of the following may have occurred, as described in the following steps.
3. Lock file problems: The device discovery process sets a lockfile in the `/usr/opensv/volmgr/misc` (UNIX) or `install_path\Volmgr\misc` (Windows) directory named `tpac.lock` to ensure that only one instance of discovery is running on a particular host. It then checks the lockfile before updating the configuration.
 - ◆ Cannot obtain lockfile.

The lockfile may be held by another discovery process. In this case the following error is displayed:

```
"another tpautoconf is already running"
```

Use standard OS process tools (`ps` on UNIX or Task Manager on Windows) to determine if another `tpautoconf` process is running. If not, delete the lockfile and re-run device discovery. If another `tpautoconf` process is running, wait for it to complete before retrying.
 - ◆ Failed checking lockfile.

In the case of long device-discovery cycles, the interface may timeout or the user may cancel the process. Part of the timeout or cancelling is to remove the lockfile. This tells the device discovery process that it should not continue making modifications to the device configuration. If this happens, re-run the discovery process.

4. Global device database inconsistency: Prior to beginning the process of discovering new devices on a host, the global device database is checked for internal consistency. The following are example log messages in the `tpcommand` log directory, along with steps to determine the problem and correct it.
 - ◆ Fatal Global Database consistency error: Couldn't contact robot 1 on host mud
The global device database has found a robot entry for robot 1 on mud, but could not communicate with it. Delete that robot on host mud and re-run device discovery there.
 - ◆ Fatal Global Database consistency error: TLM/ACS control host mismatch 1 on hosts bison and mud.
The global device database has found TLM or ACS robot entries for robot 1, on hosts bison and mud, but their ACSLS Host or DAS Server did not agree. Determine which host is running the ACS library software or the DAS software. Using `tpconfig` or the administration console, update the robot entry to indicate the correct ACSLS Server name or DAS host name.
 - ◆ Fatal Global Database consistency error: remote control host mismatch 1 on hosts bison and mud.
The global device database has found remote robot entries for robot 1 on hosts bison and mud, but their robot control hosts did not agree. Determine which host should be the controlling host. Then determine which host is incorrect. Delete the remote robot entry on the host that is incorrect, and re-run device discovery.
 - ◆ Fatal Global Database consistency error: missing robot control host 1.
The global device database has found a remote robot entry for robot 1, but the corresponding controlling entry could not be found. Check each of the media servers in the configuration for a remote robot definition for robot 1. Delete that robot and re-run device discovery there.
 - ◆ Fatal Global Database consistency error: serial number 1234567 on robot 1 on host bison, and on robot 2 on host mud.
The global device database has found duplicate robot serial numbers on robot 1 on bison, and robot 2 on mud. This is probably an invalid configuration. First determine if these are unique robots, or if they are actually the same robot connected to each host. If they are unique robots, run `tpconfig -tables` on bison and mud and look for serial number 1234567 on robot 1 on bison and robot 2 on mud. If these serial numbers are the same, check with the robot vendor to see if it is possible to modify the serial number. If the serial numbers are different, delete the robot on one of the hosts and re-run device discovery there.
 - ◆ Fatal Global Database consistency error: drive SSO mismatch MyDrive0 on hosts bison and mud



The global device database has at least two entries for MyDrive0, one on bison, and one on mud. One of these two entries states that the drive is shared. Determine if MyDrive0 should be shared and look for entries that are conflicting. Run `tpconfig -d` to determine which of these hosts is incorrect. Delete the drive on the host that has the incorrect data and re-run device discovery on that host. If neither of these hosts is incorrect according to the `tpconfig -d` output, delete the drive on both hosts and re-run device discovery on both hosts.

- ◆ Fatal Global Database consistency error: serial number on drive MyDrive0 on host bison, and on drive MyDrive1 on host mud.

The global device database has found duplicate drive serial numbers on MyDrive0 on bison, and on MyDrive1 on mud. This is probably an invalid configuration. First determine if these are unique drives, or if they are actually the same drive connected to each host. If they are unique drives, run `tpconfig -tables` on bison and mud and look for the serial number for MyDrive0 and MyDrive1. If the serial numbers are the same, check with the drive vendor to see if it is possible to modify the serial number. If the serial numbers are different, delete the drive on one of the hosts and re-run device discovery there.

Device Configuration Status Code: 45

Message: No device found in RSM at the specified location

Explanation: On a request to add or change robot information in the device configuration, the specified robotic device path could not be found in the system registry. This status code applies to Windows 2000 systems only.

Recommended Action: Use the Media and Device Management interface New Robot or Change Robot display to browse for robots in the system registry, eliminating the need to manually specify device paths or device control parameters. Check the operating system registry for changer names and their associated SCSI paths when manually specifying robotic control information. Check for detailed errors from the command or user interface output.

Device Configuration Status Code: 46

Message: Unable to retrieve GUID from RSM api

Explanation: On a request to add or change robot information in the device configuration, an error was encountered while attempting to obtain the RSM GUID for the specified device path or device control parameters. (RSM is the Microsoft Removable Storage Manager and GUID is a Global Unique Identifier.) This error code applies to Windows 2000 systems only.

Recommended Action:

1. Use the Media and Device Management interface New Robot or Change Robot display to browse for robots in the system registry, eliminating the need to manually specify device paths or device control parameters.
2. Check the operating system registry for changer names and their associated SCSI paths when manually specifying robotic control information. Check for detailed errors from the command or user interface output. Ensure that the Removable Storage service is running. Ensure that the device is present and working properly according to the Removable Storage administration interface.

Device Configuration Status Code: 47

Message: Cannot backup/restore global device database files

Explanation: There was a failed request to create a backup copy, remove a backup copy, or replace the current copy of the local device databases. This database is `globDB`, located in `/usr/opensv/volmgr/database` (UNIX) or `install_path\volmgr\database` (Windows) on your global device database host.

Recommended Action:

1. Examine the daemon debug log and command or interface output for a more detailed message on the system error, as follows.
 - a. If not already enabled, enable debug logging by creating the necessary directories/folders. Increase the level of verbosity by adding the `VERBOSE` option in the `vm.conf` file and restarting the volume daemon / NetBackup Volume Manager service, or start `vmd` with the verbose option.
 - b. Retry the operation and examine the logs.
2. Examine the permissions and check for the existence of the global device database file. Display the device configuration to determine whether or not the database is corrupt, and restore a saved copy of the databases from catalog backups, or delete them and recreate the device configuration as needed.

Device Configuration Status Code: 48

Message: RSM is supported only on Microsoft Windows 2000 and later OS versions.

Explanation: On a request to make a device configuration change, the RSM (Microsoft Removable Storage Manager) robot type was specified, but the operating system version on the targeted device host does not support RSM devices.

Recommended Action: Specify RSM devices only on Windows 2000 or later Windows-based operating systems.



Device Configuration Status Code: 49

Message: The global device database host name is invalid.

Explanation: On a device configuration request, the global device database host name could not be obtained.

The global device database host name is obtained through an internal request that is sent to vmd (the volume daemon on UNIX or the NetBackup Volume Manager service on Windows). This request is likely to fail if vmd is not running on the targeted device host.

Recommended Action:

1. See the recommended actions for the following Media Manager status codes:
 - ◆ 69, failed sending request to vmd
 - ◆ 70, cannot connect to vmd
 - ◆ 71, failed sending to vmd
 - ◆ 72, failed receiving from vmd
2. Use `tpautoconf -get_gdbhost` on a device host to obtain its global device database host name. Use `tpautoconf -set_gdbhost` to set the global device database host name, as needed.

Device Configuration Status Code: 50

Message: Device Configuration was not upgraded.

Explanation: An attempt was made to make an automated device configuration change, but the device configuration from a previous release has not been upgraded.

Recommended Action: Run the device configuration upgrade as part of the upgrade installation procedure. If a device configuration from a previous release has been restored, run `tpautoconf -upgrade`. If the Media Manager database directory/folder (or its contents) has been recently lost and the directory/folder has been partially recreated with device databases from the current release, run `tpautoconf -ready_devices` and retry the automated device configuration change request.

Device Configuration Status Code: 51

Message: No device is registered at these SCSI coordinates.

Explanation: On a request to add or change robot or drive information in the device configuration, the specified SCSI coordinates did not correspond to a device in the system registry. This status code applies to Windows systems only.

Recommended Action: To avoid manually specifying SCSI coordinates (port, bus, target, and LUN), use the Device Configuration wizard so that device configuration requests are fully automated (on supported device discovery platforms), or use the Media and Device Management interface to browse for devices in the system registry. Check the operating system registry to ensure that devices are present at the specified coordinates when SCSI coordinates are manually configured.

Device Configuration Status Code: 52

Message: The device name is not valid, no device responded.

Explanation: On a request to add or change robot or drive information in the device configuration, there was no device found in the system registry with the specified device name. This error code applies to Windows systems only.

Recommended Action: To avoid manually specifying the device name, use the Device Configuration wizard so that device configuration requests are fully automated (on supported device discovery platforms), or use the Media and Device Management interface to browse for devices in the system registry. Check the operating system registry to ensure that devices are present at the specified coordinates when devices are manually configured.

Format Optical Status Codes

These status codes appear in exit status and command output for the `tpformat` command, and in system or debug logs. These codes are also presented by programs that call `tpformat`, such as media and device management user interfaces and the `vmopr cmd` command.

Format Optical Status Code: 0

Message: Success

Explanation: An optical volume format operation was successfully completed.

Recommended Action: None.

Format Optical Status Code: 1

Message: `tpformat`: Invalid usage

Explanation: The format optical disk command `tpformat` was executed with improper options or there is an incompatibility between components or versions of the product.

Recommended Action:



1. Examine command output (if available), debug logs, and system logs for a more detailed message on the error.
 - a. Enable debug logging by creating the necessary directories/folders. Increase the level of verbosity by adding the VERBOSE option in the `vm.conf` file and restarting the daemons/services, or execute the command's verbose option, if available.
 - b. Retry the operation and examine the logs.
2. Check the `tpformat` usage statement and compare with the parameters being sent to start the new process.
3. Verify that all Media Manager binaries are at a compatible version level.

Format Optical Status Code: 2

Message: `tpformat`: Cannot set volume header

Explanation: The format optical disk command `tpformat` encountered a system, device, or media error while trying to write the optical volume header.

Recommended Action:

1. Examine command output (if available), debug logs, and system logs for a more detailed message on the error.
 - a. Enable debug logging by creating the necessary directories/folders. Increase the level of verbosity by adding the VERBOSE option in the `vm.conf` file and restarting the daemons/services, or execute the command's verbose option, if available.
 - b. Retry the operation and examine the logs.
2. Verify integrity of the device and the media, and check the system device files for correctness according to the *NetBackup Device Configuration Guide*. Examples of problems that may have been encountered are:
 - a. Operating system error where exclusive access to the disk could not be set.
 - b. Operating system error while attempting to format the disk.
 - c. Cannot determine the name of the disk.
 - d. Operating system was unable to set the geometry.

- e. Could not write the volume table of contents.
- f. Cannot determine SCSI passthrough path to the device.
- g. Cannot read capacity of the optical platter.
- h. Cannot seek to write the volume header.
- i. Optical volume format is not supported on the targeted platform.

Format Optical Status Code: 3

Message: tpformat: Cannot open

Explanation: The format optical disk command `tpformat` encountered a system, device, or media error while trying to open the optical disk device.

Recommended Action:

1. Examine command output (if available), debug logs, and system logs for a more detailed message on the error.
 - a. Enable debug logging by creating the necessary directories/folders. Increase the level of verbosity by adding the `VERBOSE` option in the `vm.conf` file and restarting the daemons/services, or execute the command's verbose option, if available.
 - b. Retry the operation and examine the logs.
2. Verify integrity of the device and the media, and check the system device files for correctness according to the *NetBackup Device Configuration Guide*. Use the `tpformat -f` option if the media has not already been sector formatted.

Format Optical Status Code: 4

Message: tpformat: Cannot read

Explanation: The format optical disk command `tpformat` encountered a system, device, or media error while trying to read the optical disk.

Recommended Action:

1. Examine command output (if available), debug logs, and system logs for a more detailed message on the error.
 - a. Enable debug logging by creating the necessary directories/folders. Increase the level of verbosity by adding the VERBOSE option in the `vm.conf` file and restarting the daemons/services, or execute the command's verbose option, if available.
 - b. Retry the operation and examine the logs.
2. Verify the integrity of the device and media, and check the system device files for correctness according to the *NetBackup Device Configuration Guide*. Use the `tpformat -f` option if the media has not already been sector formatted.

Format Optical Status Code: 5

Message: `tpformat: Cannot seek`

Explanation: The format optical disk command `tpformat` encountered a system, device, or media error while trying to seek on or determine characteristics of the optical disk.

Recommended Action:

1. Examine command output (if available), debug logs, and system logs for a more detailed message on the error.
 - a. Enable debug logging by creating the necessary directories/folders. Increase the level of verbosity by adding the VERBOSE option in the `vm.conf` file and restarting the daemons/services, or execute the command's verbose option, if available.
 - b. Retry the operation and examine the logs.
2. Verify the integrity of the device and media, and check the system device files for correctness according to the *NetBackup Device Configuration Guide*.

Format Optical Status Code: 6

Message: `tpformat: Cannot write`

Explanation: The format optical disk command `tpformat` encountered a system, device, or media error while trying to write the optical disk.

Recommended Action:

1. Examine command output (if available), debug logs, and system logs for a more detailed message on the error.
 - a. Enable debug logging by creating the necessary directories/folders. Increase the level of verbosity by adding the `VERBOSE` option in the `vm.conf` file and restarting the daemons/services, or execute the command's verbose option, if available.
 - b. Retry the operation and examine the logs.
2. Verify the integrity of the device and media, and check the system device files for correctness according to the *NetBackup Device Configuration Guide*. Use the `tpformat -f` option if the media has not already been sector formatted.

Format Optical Status Code: 7

Message: `tpformat`: Existing media ID

Explanation: The format optical disk command `tpformat` could not format the optical disk because it has already been formatted.

Recommended Action:

1. Examine command output (if available), debug logs, and system logs for a more detailed message on the error.
 - a. Enable debug logging by creating the necessary directories/folders. Increase the level of verbosity by adding the `VERBOSE` option in the `vm.conf` file and restarting the daemons/services, or execute the command's verbose option, if available.
 - b. Retry the operation and examine the logs.
2. Ensure that the device files and optical drive library address are correct, since this error may occur if the device paths or drive address was incorrectly configured. Use the `tpformat -o` (overwrite) option if you want to reformat the optical platter. If the platter is `WORM` (write-once, read-many), it cannot be reformatted.

Format Optical Status Code: 8

Message: `tpformat`: Must be root

Explanation: The format optical disk command `tpformat` was run by a non-root user.

Recommended Action: Execute `tpformat` only as the root user.



Format Optical Status Code: 9

Message: tpformat: Tape request failed

Explanation: The format optical disk command `tpformat` encountered a situation where the optical volume could not be mounted.

Recommended Action:

1. Examine command output (if available), debug logs, and system logs for a more detailed message on the error.
 - a. Enable debug logging by creating the necessary directories/folders. Increase the level of verbosity by adding the `VERBOSE` option in the `vm.conf` file and restarting the daemons/services, or execute the command's verbose option, if available.
 - b. Retry the operation and examine the logs.
2. Verify the integrity of the device and media, and check the system device files for correctness according to the *NetBackup Device Configuration Guide*. Investigate robotic errors and determine whether mount requests are being canceled by the administrator.

Format Optical Status Code: 10

Message: tpformat: Invalid robot

Explanation: The format optical disk command `tpformat` could not find a valid, specified robot in the device configuration.

Recommended Action:

1. Examine command output (if available), debug logs, and system logs for a more detailed message on the error.
 - a. Enable debug logging by creating the necessary directories/folders. Increase the level of verbosity by adding the `VERBOSE` option in the `vm.conf` file and restarting the daemons/services, or execute the command's verbose option, if available.
 - b. Retry the operation and examine the logs.
2. Check the device configuration to see if a robot of type TLM (Tape Library Multimedia) or ODL (Optical Disk Library) is configured, matching the robot number passed on the `tpformat -r` option.

Format Optical Status Code: 11

Message: tpformat: Command interrupted

Explanation: The format optical disk command `tpformat` was interrupted because the optical mount request was canceled or not accomplished within the required time interval.

Recommended Action:

1. Examine command output (if available), debug logs, and system logs for a more detailed message on the error.
 - a. Enable debug logging by creating the necessary directories/folders. Increase the level of verbosity by adding the `VERBOSE` option in the `vm.conf` file and restarting the daemons/services, or execute the command's verbose option, if available.
 - b. Retry the operation and examine the logs.
2. Resubmit the request and observe the Device Monitor for standalone optical mount requests, servicing them as needed. Look for pending requests indicating reasons for the optical mount not being completed.

Format Optical Status Code: 12

Message: tpformat: Skip

Explanation: Because an optical disk format operation failed, remaining optical format operations were skipped.

Recommended Action: Look in the user interface output for the cause of the initial optical disk format failure. Resolve the situation based on the error provided, and use the `tpformat` command interface to format any remaining optical disks.

Format Optical Status Code: 13

Message: tpformat: No media present in drive or robot slot

Explanation: The format optical disk command `tpformat` was interrupted because no media was found in the drive or robotic slot.

Recommended Action:

1. Examine command output (if available), debug logs, and system logs for a more detailed message on the error.
 - a. Enable debug logging by creating the necessary directories/folders. Increase the level of verbosity by adding the `VERBOSE` option in the `vm.conf` file and restarting the daemons/services, or execute the command's verbose option, if available.
 - b. Retry the operation and examine the logs.
2. Resubmit the request and observe the Device Monitor for standalone optical mount requests, servicing them as needed, and look for pending requests indicating reasons for the optical mount not being satisfied.

Device Management Status Codes

These status codes appear in exit status and command output for the `ltid`, `tpclean`, `tpreq`, and `tpunmount` commands, and in system or debug logs. These codes are also presented by programs that call those commands, such as media and device management user interfaces and the `vmopr cmd` command.

Device Management Status Code: 1

Message: Invalid Drive Type/Density

Explanation: An invalid density was specified for the `-d` parameter on `tpreq`.

Recommended Action: Check the `tpreq` man page (command description) for the list of valid densities. Resubmit the mount request using a valid density.

Device Management Status Code: 2

Message: Drive is currently assigned

Explanation: A request was made for a specified drive, but the drive was assigned.

Recommended Action: Display drive status (using `vmopr cmd -d` or other means) to see the list of drives and their assignment status. Run the request later, or first clear the drive assignment by stopping application activity on the drive, unmounting the media with `tpunmount`, or resetting the drive. If the wrong drive was specified, resubmit the request specifying the correct drive name or index as appropriate for the interface being used.

Device Management Status Code: 3

Message: Error in Sending Operator Message

Explanation: An attempt was made to send an operational message to `ltid` (the Media Manager device daemon on UNIX and the NetBackup Device Manager service on Windows), on an already existing internal message queue used for inter-process communication. But an error was encountered in the message communications. The error probably indicates a lack of system resources for message queues.

Recommended Action:

1. Examine command output (if available), debug logs, and system logs for messages related to the error.
 - a. Enable debug logging by creating the necessary directories/folders. Increase the level of verbosity by adding the `VERBOSE` option in the `vm.conf` file and restarting the daemons/services, or execute the command's verbose option, if available.
 - b. Retry the operation and examine the logs.
2. On UNIX servers, gather output from the `ipcs -a` command to see what resources are currently in use.

Device Management Status Code: 4

Message: Error in Receiving Operator Message

Explanation: An attempt was made to receive a message from `ltid` (the Media Manager device daemon on UNIX and the NetBackup Device Manager service on Windows) on an already existing internal message queue used for inter-process communication. But an error was encountered in the message communications. The error probably indicates a lack of system resources for message queues.

Recommended Action:

1. Examine command output (if available), debug logs, and system logs for messages related to the error.
 - a. Enable debug logging by creating the necessary directories/folders. Increase the level of verbosity by adding the `VERBOSE` option in the `vm.conf` file and restarting the daemons/services, or execute the command's verbose option, if available.
 - b. Retry the operation and examine the logs.
2. On UNIX servers, gather output from the `ipcs -a` command to see what resources are currently in use. Investigate whether `ltid` is tied up in communications with devices or other components.



Device Management Status Code: 5

Message: Error in Sending Daemon Message

Explanation: An attempt was made by `ltid` (the Media Manager device daemon on UNIX and the NetBackup Device Manager service on Windows) to send an internal process communications message to a robotic daemon/process using an already existing internal message queue. An error was encountered in the message communications. The error probably indicates a lack of system resources for message queues.

Recommended Action:

1. Examine command output (if available), debug logs, and system logs for messages related to the error.
 - a. Enable debug logging by creating the necessary directories/folders. Increase the level of verbosity by adding the `VERBOSE` option in the `vm.conf` file and restarting the daemons/services, or execute the command's verbose option, if available.
 - b. Retry the operation and examine the logs.
2. On UNIX servers, gather output from the `ipcs -a` command to see what resources are currently in use. Investigate whether the robotic daemon/process on the local device host is tied up in communications with devices or other components.

Device Management Status Code: 6

Message: Error in Receiving Daemon Message

Explanation: An attempt was made by `ltid` (the Media Manager device daemon on UNIX and the NetBackup Device Manager service on Windows) to receive or process an internal process communications message to a robotic daemon/process using an already existing internal message queue, but an error was encountered in the message communications. The error probably indicates a lack of system resources for message queues, or mismatched software components.

Recommended Action:



1. Examine command output (if available), debug logs, and system logs for messages related to the error.
 - a. Enable debug logging by creating the necessary directories/folders. Increase the level of verbosity by adding the VERBOSE option in the `vm.conf` file and restarting the daemons/services, or execute the command's verbose option, if available.
 - b. Retry the operation and examine the logs.
2. On UNIX servers, gather output from the `ipcs -a` command to see what resources are currently in use. Check the installed software components and verify that they are all at a compatible release version.

Device Management Status Code: 7

Message: Error in Sending User Message

Explanation: An attempt was made to send a user message to `ltid` (the Media Manager device daemon on UNIX and the NetBackup Device Manager service on Windows) on an already existing internal message queue used for inter-process communication. But an error was encountered in the message communications. The error probably indicates a lack of system resources for message queues.

Recommended Action:

1. Examine command output (if available), debug logs, and system logs for messages related to the error.
 - a. Enable debug logging by creating the necessary directories/folders. Increase the level of verbosity by adding the VERBOSE option in the `vm.conf` file and restarting the daemons/services, or execute the command's verbose option, if available.
 - b. Retry the operation and examine the logs.
2. On UNIX servers, gather output from the `ipcs -a` command to see what resources are currently in use.

Device Management Status Code: 8

Message: Error in Receiving User Message

Explanation: An attempt was made to receive a user message from `ltid` (the Media Manager device daemon on UNIX and the NetBackup Device Manager service on Windows) on an already existing internal message queue used for inter-process



communication. But an error was encountered in the message communications. The error probably indicates a lack of system resources for message queues. On Windows, this error can also occur if an internal-system-registered event cannot be opened.

Recommended Action:

1. Examine command output (if available), debug logs, and system logs for messages related to the error.
 - a. Enable debug logging by creating the necessary directories/folders. Increase the level of verbosity by adding the VERBOSE option in the `vm.conf` file and restarting the daemons/services, or execute the command's verbose option, if available.
 - b. Retry the operation and examine the logs.
2. On UNIX servers, gather output from the `ipcs -a` command to see what resources are currently in use.

Device Management Status Code: 9

Message: Drive is currently reserved

Explanation: An attempt was made to reserve a shared drive, but the drive is already reserved. This status code is related to the internal implementation of the SSO feature, not SCSI Reserve/Release.

Recommended Action: This is an unexpected condition that will be automatically retried. If problems persist, stop and restart `ltid` (the Media Manager device daemon on UNIX or the NetBackup Device Manager service on Windows).

Device Management Status Code: 10

Message: IPC sequence error

Explanation: An internal process communications message sequencing error has occurred.

Recommended Action: Examine command output (if available), debug logs, and system logs for messages related to the error.

1. Enable debug logging by creating the necessary directories/folders. Increase the level of verbosity by adding the VERBOSE option in the `vm.conf` file and restarting the daemons/services, or execute the command's verbose option, if available.
2. Retry the operation and examine the logs.

Device Management Status Code: 11

Message: One implicit reserve already exists

Explanation: A tape mount has been requested with an unsupported option.

Recommended Action: Verify that the installed software components are all at a compatible release version.

Device Management Status Code: 12

Message: Invalid Operator

Explanation: An internal list of operators could not be obtained.

Recommended Action: This is an unexpected internal error. Stop and restart `ltid` (the Media Manager device daemon on UNIX or the NetBackup Device Manager service on Windows).

Device Management Status Code: 13

Message: Error in IPC SHMGET call

Explanation: A process was unable to get a shared memory identifier associated with a segment of shared memory that `ltid` maintains. (`ltid` is the Media Manager device daemon on UNIX or the NetBackup Device Manager service on Windows.)

Recommended Action:

1. Examine command output (if available), debug logs, and system logs for messages related to the error.
 - a. Enable debug logging by creating the necessary directories/folders. Increase the level of verbosity by adding the `VERBOSE` option in the `vm.conf` file and restarting the daemons/services, or execute the command's verbose option, if available.
 - b. Retry the operation and examine the logs.
2. On UNIX servers, gather output from the `ipcs -a` command to see what resources are currently in use.

Device Management Status Code: 14

Message: Error in IPC SHMAT call

Explanation: A process was unable to attach a shared memory segment that `ltid` maintains. (`ltid` is the Media Manager device daemon on UNIX or the NetBackup Device Manager service on Windows.)



Recommended Action:

1. Examine command output (if available), debug logs, and system logs for messages related to the error.
 - a. Enable debug logging by creating the necessary directories/folders. Increase the level of verbosity by adding the VERBOSE option in the vm.conf file and restarting the daemons/services, or execute the command's verbose option, if available.
 - b. Retry the operation and examine the logs.
2. On UNIX servers, gather the output of the `ipcs -a` command to see what resources are currently in use.

Device Management Status Code: 15

Message: The drive is DOWN

Explanation: An attempt was made to mount media on a drive or to reserve a shared drive which has since been logically configured to the DOWN state.

Recommended Action:

1. Examine command output (if available), debug logs, and system logs for messages related to the error.
 - a. Enable debug logging by creating the necessary directories/folders. Increase the level of verbosity by adding the VERBOSE option in the vm.conf file and restarting the daemons/services, or execute the command's verbose option, if available.
 - b. Retry the operation and examine the logs.
2. Check the application log files (such as the bptm log) to see why the drive may have been configured DOWN.
3. Check the integrity of the drive, drive path, and media.

Device Management Status Code: 16

Message: No mount pending for given mount index

Explanation: An attempt was made to retrieve information about a pending mount request, but no such pending mount request was found.

Recommended Action: Use a device monitor interface or consult application logs to see whether the request has been completed or canceled. Requests to retrieve information for pending mount requests are valid only when the mount request is actually pending.

Device Management Status Code: 17

Message: Drive does not support pending request density

Explanation: A drive was selected that has a drive type which is not compatible with the requested density.

Recommended Action:

1. Allow the drive selection to be determined automatically.
2. When selecting the drive manually, check the device configuration and the valid density table (available in the `tpreq` man page or command description), then specify a drive that is compatible with the requested density.

Device Management Status Code: 18

Message: Invalid volume count

Explanation: A tape mount has been requested with an unsupported option.

Recommended Action: Check the installed software components and verify that they are all at a compatible release version.

Device Management Status Code: 19

Message: Only the administrative user can perform the requested operation

Explanation: Either an attempt was made to stop `ltid` (the Media Manager device daemon on UNIX or the NetBackup Device Manager service on Windows), or the `tpclean` command was called but the user was not root (UNIX) or the administrator (Windows).

Recommended Action: If desired, give the user or process administrator privileges on Windows or root privileges on UNIX and retry the operation.

Device Management Status Code: 20

Message: Cannot stop device daemon with tapes assigned

Explanation: An attempt was made to stop `ltid` (the Media Manager device daemon on UNIX or the NetBackup Device Manager service on Windows), but media is currently mounted and assigned.



Recommended Action: Halt all jobs referencing media, unmount all media, and stop all applications from using Media Manager before trying to stop `ltid`. If unable to unmount media through the application interface, check for the existence and permissions of the `.ltisymlinks` file in the `/usr/opensv/volmgr/misc` directory or in the `install_path\Volmgr\misc` folder. Invoke `tpunmount filename` for each line in the `.ltisymlinks` file, where `filename` specifies the contents of a line in that file. For example, on UNIX, the command may look like the following:

```
tpunmount /usr/opensv/netbackup/db/media/tpreq/A00001
```

Device Management Status Code: 21

Message: The drive is not ready or inoperable

Explanation: A drive was selected for a mount request, but the drive is not ready with loaded media.

Recommended Action: Wait until the drive is ready before manually assigning a drive to a pending mount request.

Device Management Status Code: 22

Message: IPC Error: Daemon may not be running

Explanation: A request to `ltid` could not be serviced. (`ltid` is the Media Manager device daemon on UNIX or the NetBackup Device Manager service on Windows.) `ltid` is probably not running. If `ltid` is still running, its process lock file may have been removed. Also, message queues may not be functioning correctly on the system.

Recommended Action:

1. If `ltid` is not running, start `ltid` and try the operation again. On UNIX, run `/usr/opensv/volmgr/bin/ltid`, and on Windows, start the NetBackup Device Manager service.
2. If `ltid` was already running, check for the existence and permissions of the lock file itself and the lock file directory, which are `/usr/opensv/volmgr/misc/.ltipid` (UNIX) or `install_path\Volmgr\misc\.ltipid` (Windows). Terminate the `ltid` process if it is running. Create the lock directory/folder and adjust the permissions as needed so that `ltid` can obtain the above lock.
3. On UNIX, check the `msgget` man page and look for suggestions on troubleshooting the system message queues.

Device Management Status Code: 23

Message: Invalid Drive Number

Explanation: A request was made for drive, but no such drive could be found in the active configuration.

Recommended Action: Ensure that `ltid` (the Media Manager device daemon on UNIX or the NetBackup Device Manager service on Windows) was stopped and restarted after changes were last made to the device configuration. Display the device configuration (using `tpconfig -d` or other means) to see the list of valid drives. Specify the drive name or index as appropriate for the interface being used.

Device Management Status Code: 24

Message: Requested drive could not be reserved

Explanation: An attempt was made to reserve a shared drive, but the drive reservation request failed. This status code is related to the internal implementation of the SSO feature, not SCSI Reserve/Release.

Recommended Action: This is an expected condition for shared drives which will be automatically retried. If problems persist, verify that `vmd/DA` is servicing requests and is not listing drives as reserved to hosts that are not currently using the drives. (`vmd/DA` is the Media Manager device daemon device allocator on UNIX and the NetBackup Device Manager service device allocator on Windows.) Clear out extraneous reservations by (re)starting `ltid` on the host that has the drive reservation. As an alternative, use `vmdareq -release` (plus other arguments) and then retry the request.

Device Management Status Code: 25

Message: File name does not exist

Explanation: A logical tape file or help file could not be found. The `tpunmount` command was probably issued with a logical tape file specified that does not exist for this user.

Recommended Action: Check for existence of the logical tape file at the file path specified. The specified file path must match the exact, case-sensitive path used when the tape mount was requested. Resubmit the request using the correct file path. If the condition is occurring during operator display of a pending request error message, check to see if the help files are properly installed at `/usr/opensv/volmgr/help/robots/robot type/help file name` (UNIX) or at `install_path\Volmgr\Help\Robots\robot type\help file name` (Windows).

Device Management Status Code: 26

Message: Request terminated because host not validated for volume pool

Explanation: The host where the mount request was initiated has been denied access to the media due to permissions defined for the volume pool in which the media ID is contained.



Recommended Action:

1. Query the volume pool information for the requested volume pool on the host where the mount request was issued by running `vmppool -listall -b`. Obtain the name of the host from which the mount request originated by checking the system log. This host name is the one returned by the system `hostname(1)` command.
2. Change the volume pool host name security with `vmppool` or another user interface that supports volume pool host attributes, change the volume pool associated with the volume (if it is not assigned), or log in to the host that is allowed to use media in the targeted volume pool. Then, resubmit the mount request.

Device Management Status Code: 27

Message: Request terminated because media ID is expired

Explanation: A mount request has been canceled because the media was requested with write access, and the media has expired.

Recommended Action: Request read-only access to the media on the mount request if a read-only operation is needed. Replace the media or change the expiration date to a future date, based on site policy. A media management interface can be used to view and change the expiration date for the media. Check and correct the system date/time, as needed.

Device Management Status Code: 28

Message: Error in MsgGet

Explanation: An attempt was made by `ltid` (the Media Manager device daemon on UNIX or the NetBackup Device Manager service on Windows) to obtain a message queue identifier used for internal message communications, and the request failed due to a system error. The error probably indicates a lack of system resources for message queues, or mismatched software components.

Recommended Action:

1. Examine command output (if available), debug logs, and system logs for messages related to the error. Enable debug logging by creating the necessary directories/folders. Increase the level of verbosity by adding the `VERBOSE` option in the `vm.conf` file and restarting `ltid` (the device daemon on UNIX or NetBackup Device Manager service on Windows).
2. On UNIX servers, gather the output of the `ipcs -a` command to see what resources are currently in use. Check the installed software components and verify that they are all at a compatible release version.

Device Management Status Code: 29

Message: Magic Number MisMatch

Explanation: An attempt was made to read the drive database, but it was found to be of an unknown format or version. The database is corrupt or there has been a mismatch of software components.

Recommended Action: Check integrity of the drive database file `ltidevs`, located in the directory `/usr/opensv/volmgr/database` (UNIX) or in the folder `install_path\Volmgr\database` (Windows). Display the device configuration to determine whether or not the database is corrupt, and restore a saved copy of the database file from catalog backups, or delete it and recreate the device configuration as needed.

Device Management Status Code: 30

Message: Request terminated because media id will exceed maximum mount count

Explanation: A mount request has been canceled because the media being requested has reached the maximum mount count associated with the media.

Recommended Action: Replace the media or change the maximum mount count to a higher value, based on site policy. A media management interface can be used to view and change the maximum mounts allowed for the media. Check that the number of mounts for the media is set to a reasonable value given the media's usage history, and correct it as needed using `vmchange`.

Device Management Status Code: 31

Message: Requested number of drives are not configured

Explanation: A tape mount request was submitted, and there are not enough drives in the configuration that match the requested density.

Recommended Action: Ensure that `ltid` (the Media Manager device daemon on UNIX or the NetBackup Device Manager service on Windows) was stopped and restarted after changes were last made to the device configuration. Display the device configuration (using `tpconfig -d` or other means) to see the list of configured drives. Check the man page (command description) for `tpreq` to find the list of valid densities. Resubmit the mount request using a valid density that corresponds to a drive in the device configuration.

Device Management Status Code: 32

Message: Error in getting semaphore



Explanation: An attempt was made by `ltid` (the Media Manager device daemon on UNIX or the NetBackup Device Manager service on Windows) to obtain a semaphore used for arbitrating access to shared memory, and the request failed due to a system error. The error probably indicates a lack of system resources for semaphores, or mismatched software components.

Recommended Action:

1. Examine command output (if available), debug logs, and system logs for messages related to the error. Enable debug logging by creating the necessary directories/folders. Increase the level of verbosity by adding the `VERBOSE` option in the `vm.conf` file and restarting `ltid` (the device daemon on UNIX or NetBackup Device Manager service on Windows).
2. On UNIX servers, gather the output of the `ipcs -a` command to see what resources are currently in use. Check the installed software components and verify that they are all at a compatible release version.

Device Management Status Code: 33

Message: Error in SEMAPHORE operation

Explanation: A process was unable to perform a semaphore operation (such as lock or unlock) associated with resources maintained by `ltid`. (`ltid` is the Media Manager device daemon on UNIX or the NetBackup Device Manager service on Windows.)

Recommended Action:

1. Examine command output (if available), debug logs, and system logs for messages related to the error.
 - a. Enable debug logging by creating the necessary directories/folders. Increase the level of verbosity by adding the `VERBOSE` option in the `vm.conf` file and restarting the daemons/services, or execute the command's verbose option, if available.
 - b. Retry the operation and examine the logs.
2. On UNIX servers, gather the output of the `ipcs -a` command to see what resources are currently in use.

Device Management Status Code: 34

Message: Error in getting semaphore for operator

Explanation: A process was unable to perform a semaphore operation (such as lock or unlock) associated with resources maintained by `ltid` (the Media Manager device daemon on UNIX or the NetBackup Device Manager service on Windows).

Recommended Action:

1. Examine command output (if available), debug logs, and system logs for messages related to the error.
 - a. Enable debug logging by creating the necessary directories/folders. Increase the level of verbosity by adding the `VERBOSE` option in the `vm.conf` file and restarting the daemons/services, or execute the command's verbose option, if available.
 - b. Retry the operation and examine the logs.
2. On UNIX servers, gather the output of the `ipcs -a` command to see what resources are currently in use.

Device Management Status Code: 35

Message: Request terminated because media is unavailable (in DOWN drive, misplaced, write protected or unmountable)

Explanation: A mount request has been canceled because the media being requested is not available. It may be in a DOWN drive, misplaced, write protected, or unmountable.

Recommended Action: Use robotic inventory or manual means to compare the contents of media in the robotic library with the volume configuration, and update the configuration as needed. Determine the physical location of the media. Check integrity of the drive, drive path, and media if the media is found in a logically DOWN drive. Verify that the media is not a misconfigured cleaning tape. Move the media into the robotic library and update the volume configuration if the media was not present in the library. Set the cartridge tab to allow write access, or request the media with read-only access if the write protection was the cause of the error.

Device Management Status Code: 36

Message: Request terminated by `tpunmount` call from another process

Explanation: A request was made to change the limit for the number of times that a volume can be mounted with write access for one or more volumes in the volume configuration, and the value specified was not within the acceptable range. The maximum number of mounts value may also be invalid in the number of mounts/cleanings field of a barcode rule.

Recommended Action:



1. Examine command output (if available), debug logs, and system logs for a more detailed message on the error.
 - a. Enable debug logging by creating the necessary directories/folders. Increase the level of verbosity by adding the `VERBOSE` option in the `vm.conf` file and restarting the daemons/services, or execute the command's verbose option, if available.
 - b. Retry the operation and examine the logs.
2. Specify a maximum-mounts value within the range of 0 to 2,147,483,647.

Device Management Status Code: 37

Message: Drive being assigned is either not NDMP or on the wrong NDMP client

Explanation: A mount request has been canceled because of the following: the request was targeted to a drive configured as attached to an NDMP client, but the request was manually assigned to a drive other than the requested drive, and the assigned drive is either not NDMP or it is an NDMP drive configured to a different client.

Recommended Action: Display the device configuration to determine which drives are configured as being attached to specific NDMP clients. Ensure that `ltid` was stopped and restarted after the last configuration changes were made. Reissue the request and assign it to a drive attached to the requested NDMP client.

Device Management Status Code: 38

Message: Character device name for drive is not a character device

Explanation: On a tape mount request, the configured tape drive's no-rewind-on-close device file was neither a character-special device nor of a known type such as NDMP (which does not need to be a character special file). On an optical mount request, the optical disk drive character-device file was not a character-special device.

Recommended Action:

1. To avoid configuring invalid device paths and device names, use the Device Configuration wizard (on supported device discovery platforms) so that device paths and device names can be automatically configured for tape drives.
2. Refer to the appropriate chapter in the *NetBackup Device Configuration Guide*. Always use no-rewind tape device files, recommended character device files for optical devices, or recognized drive name syntax (such as for NDMP) for tape drives. Make sure that the specified device paths exist as character-special files. Check for detailed errors from the command or user interface output.

Device Management Status Code: 39

Message: Parameter is invalid

Explanation: The `tpclean` command was called with invalid arguments, or an internal function encountered a missing reference to data it requires.

Recommended Action:

1. If a cleaning operation was requested, check the `tpclean` usage statement and compare with the parameters that were specified.
2. Check the installed software components and verify that they are all at a compatible release version.

Device Management Status Code: 40

Message: File name already exists

Explanation: On a tape mount request, the file name associated with the request already existed or was already associated with another mount request.

Recommended Action: Resubmit the request using a different file name. Specify a file name that does not correspond to an existing file, or a file name that is not in use for another mount request that may be in progress.

Device Management Status Code: 41

Message: Unknown drive name

Explanation: A request was made for a specified drive, but no such drive could be found in the active configuration. This status may occur if the device files are corrupt or missing, if they cannot be opened or read, or if there are no devices configured.

Recommended Action:

1. Ensure that `ltid` (the Media Manager device daemon on UNIX or the NetBackup Device Manager service on Windows) was stopped and restarted after changes were last made to the device configuration. Display the device configuration (using `tpconfig -d` or other means) to see the list of valid drives. Specify the drive name or index as appropriate for the interface being used.
2. Check integrity of the drive database file `ltidevs`, located in the directory `/usr/opensv/volmgr/database` (UNIX) or in the folder `install_path\Volmgr\database` (Windows). Display the device configuration to determine whether or not the database is corrupt, and restore a saved copy of the database file from catalog backups, or delete it and recreate the device configuration as needed.



Device Management Status Code: 42

Message: Incorrect tpreq access mode

Explanation: On a tape mount request, the specified access mode was invalid. On Windows hosts, a user without Administrator privileges made a request for NetBackup Device Manager services.

Recommended Action: When using tpreq, specify an access mode argument of r for read, w for write, or use the default (read) access mode. When making requests that require NetBackup Device Manager services on Windows, do so under an account with Administrator privileges.

Device Management Status Code: 43

Message: Drive is not a shared drive

Explanation: A shared drive (or SSO-related) request was made for a drive, but the drive was not a shared drive.

Recommended Action: Ensure that ltid (the Media Manager device daemon on UNIX or the NetBackup Device Manager service on Windows) was stopped and restarted after changes were last made to the device configuration. Display the device configuration (using tpcnfig -d or other means) to see the drive attributes. Ensure that a license key for the Shared Storage Option is installed and has not expired.

Device Management Status Code: 44

Message: You do not have permission to create the file

Explanation: On a tape mount request, the file name associated with the request could not be created due to directory or folder permissions.

Recommended Action: Check for existence of a file at the file path specified. If a file is found, delete the file if it is not needed or resubmit the request using a different file path. If there is no file at that location, check the directory/folder permissions for read/write access for the user or application process that issued the mount request.

Device Management Status Code: 45

Message: Drive is not currently reserved for this host

Explanation: On a request to release a shared drive, the drive was found to be not reserved to the local host. This status code is related to the internal implementation of the SSO feature, not SCSI Reserve/Release.

Recommended Action: If problems are encountered as a result of the reported error, verify that there are no unexpected robotic daemons/processes running by executing `vmops`. Stop and restart `ltid` (the Media Manager device daemon on UNIX or the NetBackup Device Manager service on Windows) so that its internal tables are re-initialized.

Device Management Status Code: 46

Message: Tape needs to be write enabled

Explanation: On a tape mount request, the specified access mode was for write access, but the physical media was write-protected.

Recommended Action: Change the physical media write-protect setting to allow write access (unlocked), or resubmit the request with read-only access. To request read-only access using `tpreq`, specify an access mode argument of `r` for read or use the default (read) access mode.

Device Management Status Code: 47

Message: Unable to establish scan host for shared drive

Explanation: On a request to change a shared drive's status, an attempt to establish a connection to the drive's scan host failed.

Recommended Action:

1. Determine which host is serving as the drive's scan host. Do this by sending a `vmddareq` command to the volume database host for the drive's residence (robot or set of standalone drives on a host).
2. Ensure that `vmc` (the Media Manager volume daemon on UNIX or NetBackup Volume Manager service on Windows) is running on the scan host. On the scan host, examine debug logs and system logs for messages related to the error.
3. Enable debug logging by creating the necessary directories/folders. Increase the level of verbosity by adding the `VERBOSE` option in the `vm.conf` file and restarting `ltid` (the device daemon on UNIX or NetBackup Device Manager service on Windows). The detailed reason for the canceled request should be available in the daemon debug logs on the scan host. Correct the problem and resubmit the request if needed.

Device Management Status Code: 48

Message: Host is not the scan host for this shared drive



Explanation: On a request to assign, reserve, or scan a drive, the targeted device host determined that it was not the scan host for the drive, so the request was refused (to be retried by the caller).

Recommended Action:

1. If problems are encountered as a result of the reported error, check for communication, configuration, and system problems among the associated hosts. Display the device configurations on the affected hosts to determine the role that each host is handling for drive sharing. Identify the DA (drive allocation) host as the volume database for the residence in which the drives are configured. Identify the current scan host for the drive by sending a `vmdatareq` call to the DA host.
2. Examine command output (if available), debug logs, and system logs for messages related to the error. Enable debug logging by creating the necessary directories/folders. Increase the level of verbosity by adding the `VERBOSE` option in the `vm.conf` file and restarting `ltid` (the device daemon on UNIX or NetBackup Device Manager service on Windows). Configure scan ability priorities for assigning scan hosts by changing the Media Manager configuration, so that less network connections need to be maintained, and greater system load is placed on hosts more capable of servicing the load.

Device Management Status Code: 49

Message: Tape file path exceeds 255 character maximum

Explanation: On a tape mount request, the file name associated with the request exceeded 255 characters.

Recommended Action: When requesting a tape mount, ensure that the file name does not exceed 255 ASCII characters in length. If the mount requests are coming from an application, request an application change to use a shorter file name, or if needed, install the product in a directory/folder that will not cause the file name limit to be exceeded.

Device Management Status Code: 50

Message: No action pending for given mount index

Explanation: On a request to obtain the pending action for a mount request, there was no known pending action associated with the request.

Recommended Action: Use a device monitor interface to display requests that have pending actions. Perform requests (like assign, deny, display, or resubmit) only on requests that have pending actions.

Device Management Status Code: 51

Message: Frequency-based cleaning is not supported for this drive

Explanation: A request was made to set the cleaning frequency for a drive, and the configuration of the drive does not support frequency-based cleaning.

Recommended Action: See the Drive Cleaning section under the Media Manager Reference Topics appendix, in the *NetBackup Media Manager System Administrator's Guide*. Shared drives cannot be cleaned based on a frequency-based schedule. Cleaning for drives in ACS, LMF, RSM, and TLH robots is managed by vendor or operating system administrative interfaces for these types of robotic libraries. Drives in optical disk libraries cannot be cleaned using cleaning media.

Device Management Status Code: 52

Message: No robot is defined of this type

Explanation: On internal communications between a robotic daemon/process and `ltid` (the Media Manager device daemon on UNIX or the NetBackup Device Manager service on Windows), no robots of the expected type were found actively configured.

Recommended Action: Display the running robotic processes to see if processes from a previous configuration are still running. If any are found, terminate them. Check the installed software components and verify that they are all at a compatible release version.

Device Management Status Code: 53

Message: Request has been queued (Cancel to clear message)

Explanation: A mount request or drive-related operation was queued because drive resources were in use.

Recommended Action: Wait until the drive resources become available, or cancel pending mount requests as needed.

Device Management Status Code: 54

Message: Block device name for optical disk is not a block device

Explanation: On an optical mount request, the configured optical disk drive block device file was not a block-special device.

Recommended Action: Refer to the appropriate chapter in the *NetBackup Device Configuration Guide*, use only the recommended device files for optical devices, and check to ensure that the specified device names exist as the type of special file required.



Device Management Status Code: 55

Message: Operator denied mount request

Explanation: The operator denied a mount request.

Recommended Action: This happens when a user or application mount request has been canceled by an administrator or operator. The request may have been canceled for a number of reasons, such as missing or faulty media or the need to allow other, higher priority requests to obtain drive resources. Check with the administrator or operator for more information.

Device Management Status Code: 56

Message: Mount canceled, device daemon is terminating

Explanation: Pending mount requests were canceled because the administrator terminated `ltid` (the Media Manager device daemon on UNIX or the NetBackup Device Manager service on Windows).

Recommended Action: Wait for `ltid` to be restarted before resubmitting the request. Check with the administrator as needed to determine daemon/service availability.

Device Management Status Code: 57

Message: Cannot assign due to media ID mismatch

Explanation: An attempt was made to assign an optical disk request to a volume that contained a different recorded media ID than was requested.

Recommended Action: Refer to the `tpformat` man page to change recorded media IDs on optical platters.

Device Management Status Code: 58

Message: The device is not robotic, cannot perform cleaning

Explanation: An attempt was made to automatically clean a drive, but the drive is not in a robotic library.

Recommended Action: Clean standalone drives by inserting a cleaning tape when needed. For non-shared drives, update the cleaning statistics with `tpclean` or another user interface that supports cleaning-related operations.

Device Management Status Code: 59

Message: No cleaning tape is defined in the device's robot or 0 cleanings remaining

Explanation: An attempt was made to automatically clean a drive, but no usable cleaning media is available, or the number of cleanings remaining for the cleaning tape is zero.

Recommended Action:

1. Ensure that cleaning media has been added to the robotic library for each drive type capable of being cleaned with a separate cleaning cartridge.
2. Ensure there is a positive number of cleanings available for the cleaning media in the appropriate volume database for the robotic library. Replace the cleaning tape or increase the number of cleanings for the cleaning media before the count reaches zero.
3. Check the availability of `vmfd` (the Media Manager volume daemon on UNIX or NetBackup Volume Manager service on Windows) on the volume database host where the cleaning media is defined, by sending a request to it or using a media management interface.
4. Examine command output (if available), debug logs, and system logs for messages related to the error. Enable debug logging by creating the necessary directories/folders. Increase the level of verbosity by adding the `VERBOSE` option in the `vm.conf` file and restarting the device daemon (`ltid`) on UNIX, or the NetBackup Device Manager service on Windows.

Device Management Status Code: 60

Message: No robot daemon or robotics are unavailable

Explanation: A robot was not configured or was operationally unavailable. Specifically, an attempt may have been made to automatically clean a robotic drive, but the robot is not defined or is unavailable. Alternatively, on an attempt to initialize the shared drive lists, a drive was found to be configured as robotic, without the required robot configured.

Recommended Action: Display the device configuration and ensure that the drive and robotic configuration information are consistent. Check the operational status of the robot and robotic software by checking the system log files. If more detail on robot operational status is needed, increase the level of verbosity by adding the `VERBOSE` option in the `vm.conf` file and restarting `ltid` (the device daemon / NetBackup Device Manager service).

Device Management Status Code: 61

Message: No media found in device or robot slot, please verify

Explanation: On a request to mount media, no media was found in the targeted location before a designated time period had elapsed.

Recommended Action: Resubmit the request, and mount the media in the targeted drive before the designated time period has elapsed. Check the device configuration to ensure that the correct drive name has been configured and that `ltid`, the device daemon, was restarted after the last device configuration change was made.



Device Management Status Code: 62

Message: Drive not available in library for mount request

Explanation: A mount request has been canceled because no drive is available. All compatible drives may be DOWN, or oversubscribed due to other active mount requests.

Recommended Action: Investigate device availability and scheduling/drive utilization of applications requesting drive resources. Under some conditions, mount requests will be canceled so that they can be reissued at a later time when compatible drive resources are available.

Device Management Status Code: 63

Message: Request terminated because mount requests are disabled

Explanation: A mount request was canceled because it cannot be satisfied.

Recommended Action: Examine command output (if available), debug logs, and system logs for messages related to the error. Enable debug logging by creating the necessary directories/folders. Increase the level of verbosity by adding the VERBOSE option in the `vm.conf` file and restarting `ltid` (the device daemon on UNIX or NetBackup Device Manager service on Windows).

The detailed reason for the canceled request should be available in the system log, command output, or from a device monitor interface. Correct the problem and resubmit the request if needed.

Device Management Status Code: 64

Message: Cannot assign a robotically controlled device

Explanation: An attempt was made to manually assign a specific device to satisfy a mount request, and the chosen device was configured in a robotic library.

Recommended Action: Assign the request to a standalone drive, or allow requests for mounts in robotic drives to be automatically assigned.

Device Management Status Code: 65

Message: Invalid volume pool specified

Explanation: On a mount request, the media pool specified was not valid.

Recommended Action: Resubmit the request, specifying a volume pool name that is no more than 20 ASCII characters in length.

Device Management Status Code: 66

Message: Request terminated because of volume pool mismatch

Explanation: The volume pool specified on the `tpreq` command did not match the volume pool specified in the Media Manager configuration for the media ID.

Recommended Action: Use a media management interface to obtain the volume pool name of the media that is to be mounted, and resubmit the mount request, specifying the correct pool name.

Device Management Status Code: 67

Message: Request terminated because user not validated for volume pool

Explanation: The user is not validated to use the media ID, because of permissions defined for the volume pool in which the media ID is contained.

Recommended Action: Query the volume pool information for the requested volume pool on the host where the mount request was issued by running `vmppool -listall -b`. Check the user ID (on UNIX) by executing the `id(1M)` system command. Change the volume pool user ID security with `vmppool` or another user interface that supports volume pool user and group attributes. Change the volume pool associated with the volume (if it is not assigned), or log in as the user ID with permissions to use media in the targeted volume pool. Then, resubmit the mount request.

Device Management Status Code: 68

Message: Request terminated because user/group not validated for volume pool

Explanation: The user or group is not validated to use the media ID because of permissions defined for the volume pool in which the media ID is contained.

Recommended Action: Query the volume pool information for the requested volume pool on the host where the mount request was issued by running the command `vmppool -listall -b`. Check the user ID and group ID (on UNIX) by executing the `id(1M)` system command. Change the volume pool user and/or group ID security with `vmppool` or another user interface that supports volume pool user and group attributes. Change the volume pool associated with the volume (if it is not assigned), or log in with user/group ID permissions to use media in the targeted volume pool. Then, resubmit the mount request.

Device Management Status Code: 69

Message: Request terminated because media is unmountable

Explanation: A mount request has been canceled because the media being requested is not mountable. The same media has been found to be unmountable in at least two different drives.

Recommended Action:



1. Check integrity of the drive, drive path, and media.
2. Verify that the media is not a misconfigured cleaning tape.

Device Management Status Code: 70

Message: Request terminated because media is write protected

Explanation: A mount request has been canceled because the media being requested for write access is not write-enabled.

Recommended Action: Check the physical media cartridge to see whether write-protection has been enabled. If write access to the media is desired, disable write protection for the media. If read-only access is desired, leave the write-protection enabled and make the necessary administrative requests in the requesting application (such as suspending the media) to ensure that the media is requested only for read access.

If the media was requested through the command line interface, see the `tpreq` man page or command description for specifying the access mode of the media. The `tpreq` command is described in the *NetBackup Media Manager System Administrator's Guide*.

Device Management Status Code: 71

Message: Request terminated because media is a cleaning tape

Explanation: A mount request has been canceled because the media found in the drive is a cleaning tape.

Recommended Action: Check to make sure the Media Manager's volume database is up-to-date. If there are cleaning media in the library, assign appropriate cleaning media types to them in the Media Manager volume database.

Robotic Status Codes

These status codes are logged by robotic daemons/processes. They are also issued by programs that call the robotic operations, such as the `vmchange` command and the media and device management user interfaces.

Robotic Status Code: 200

Message: STATUS_SUCCESS

Explanation: A robotic operation was successfully completed.

Recommended Action: None.

Robotic Status Code: 201

Message: Unable to open robotic path

Explanation: The robotic library device could not be opened. The specific case could be one of the following.

- ◆ The robot device, path, or library name in the device configuration may not be valid.
- ◆ The configured robotic device may not exist.
- ◆ The robotic device may be incorrect, such as a UNIX device file that is not of a character special file format.
- ◆ The robotic daemon/process lock file could not be opened or a lock obtained.
- ◆ The open operation on the device or through the API interface (such as NDMP) failed.

Recommended Action:

1. Stop any robot test utilities that may be running, since they have the lock on the robotic device when they are active.
2. Check the configuration of the robot against the recommended configuration as indicated in the documentation for robot configuration.
3. Check the health of the robotic device by using a robot test utility, then close the test utility when finished.
4. Check for the existence and permissions of the lock file itself and the lock file directory, which is `/usr/opensv/volmgr/misc/vmd.lock` (UNIX) or `install_path\Volmgr\misc\vmd.lock` (Windows). Create the directory/folder and adjust the permissions as needed so that the robotic daemon/process can use the lock file. Stop and restart `ltid` (the device daemon on UNIX or the NetBackup Device Manager service on Windows).

Robotic Status Code: 202

Message: Unable to sense robotic device

Explanation: An element of the robotic library device could not be sensed. The cause could be any of the following.

- ◆ The SCSI commands mode sense, mode select, or read element status (of slot, drive, transport, i/e element) may have failed.
- ◆ A network API-controlled library inventory request may have failed.
- ◆ The robotic daemon/process could not initialize a robotic database file.

Recommended Action:

1. Check the configuration of the robot against the recommended configuration as indicated in the documentation for robot configuration.
2. Check the health of the robotic device by using a robot test utility, then close the test utility when finished.
3. Check for the existence and permissions of the temporary robotic database and the temporary database directory/folder, which is
/usr/opencv/volmgr/misc/robotic_db (UNIX) or
install_path\Volmgr\misc\robotic_db (Windows). Create the directory/folder and adjust the permissions as needed so that the robotic daemon/process can create it or use it. Stop and restart *ltid* (the device daemon on UNIX or the NetBackup Device Manager service on Windows).

Robotic Status Code: 203

Message: Timeout waiting for robotic command

Explanation: A robotic operation timed out: it did not return with a status before a designated time period had elapsed.

Recommended Action:

1. Stop any robot test utilities that may be running, since they have the lock on the robotic device when they are active, and can block other requests.
2. Check whether excessive hardware retries have delayed the completion of a robotic command.
3. Check to see whether the robotic device is still functioning. Use a robot test utility to send commands to the device to see whether it is responsive. Verify that there are no unexpected Media Manager processes running by executing *vmops*. Some processes are expected to remain running, but some processes that do not go away could indicate a more serious problem, such as a hung system call.

Robotic Status Code: 204

Message: Unable to initialize robot

Explanation: The robot could not be initialized. This is a generic status used for many conditions.

Recommended Action:

1. Examine command output (if available), debug logs, and system logs for messages related to the error.
 - a. Enable debug logging by creating the necessary directories/folders. Increase the level of verbosity by adding the VERBOSE option in the vm.conf file and restarting `ltid` (the device daemon on UNIX or NetBackup Device Manager service on Windows).
 - b. Retry the operation and examine the logs.
2. Resolve the situation by referring to troubleshooting methods or investigating the system log messages related to the specific error leading to the robot initialization failure.

Robotic Status Code: 205

Message: Robotic mount failure

Explanation: The robot could not mount media.

Recommended Action:

1. Examine command output (if available), debug logs, and system logs for messages related to the error.
 - a. Enable debug logging by creating the necessary directories/folders. Increase the level of verbosity by adding the VERBOSE option in the vm.conf file and restarting `ltid` (the device daemon on UNIX or NetBackup Device Manager service on Windows).
 - b. Retry the operation and examine the logs.
2. Resolve the situation by referring to troubleshooting methods or investigating the system log messages related to the specific error leading to the media mount failure.

Robotic Status Code: 206

Message: Robotic dismount failure

Explanation: The robot could not dismount media.

Recommended Action:

1. Examine command output (if available), debug logs, and system logs for messages related to the error.
 - a. Enable debug logging by creating the necessary directories/folders. Increase the level of verbosity by adding the `VERBOSE` option in the `vm.conf` file and restarting `ltid` (the device daemon on UNIX or NetBackup Device Manager service on Windows).
 - b. Retry the operation and examine the logs.
2. Resolve the situation by referring to troubleshooting methods or investigating the system log messages related to the specific error leading to the media dismount failure.

Robotic Status Code: 207

Message: Invalid command code

Explanation: A robotic operation was requested with improper options, when it was not supported, or a robotic operation encountered an incompatible device interface. There may be an incompatibility between components or versions of the product.

Recommended Action:

1. Examine command output (if available), debug logs, and system logs for a more detailed message on the error.
 - a. Enable debug logging by creating the necessary directories/folders. Increase the level of verbosity by adding the `VERBOSE` option in the `vm.conf` file and restarting the daemons/services, or execute the command's verbose option, if available.
 - b. Retry the operation and examine the logs.
2. Verify that all Media Manager binaries and user interfaces are at a compatible version level.

Robotic Status Code: 208

Message: Requested slot is empty

Explanation: No media was found in a specified slot. The volume configuration may not be consistent with the physical contents of the robotic library that is associated with the volume.

Recommended Action: Install or realign the container/holder for the media if it was missing or misaligned. Place media right-side-up in the slot if the media is upside-down. Check to see if the requested slot is reserved to the robotic library for internal use. Physically correct issues within the robotic library, or use a media management interface to correct the volume configuration.

Robotic Status Code: 209

Message: Unable to open drive

Explanation: The drive could not be opened. The drive configuration may be incorrect and the drive may be logically DOWN. Also, the drive may never have become ready after media was placed in the drive.

Recommended Action:

1. Examine command output (if available), debug logs, and system logs for messages related to the error.
 - a. Enable debug logging by creating the necessary directories/folders. Increase the level of verbosity by adding the VERBOSE option in the `vm.conf` file and restarting `ltid` (the device daemon on UNIX or NetBackup Device Manager service on Windows).
 - b. Retry the operation and examine the logs.
2. Check for improperly configured cleaning media or interference with the drive cleaning operation. Check for bad media which may have led to the drive not becoming ready after media was placed within it.
3. To avoid configuring incorrect device paths and device names, which is a common root cause of drive open problems, use the Device Configuration wizard (on supported device discovery platforms) so that device paths and device names can be automatically configured. Resolve the situation by referring to troubleshooting methods or investigating the system log messages related to the specific error leading to the open failure.

Robotic Status Code: 210

Message: Unable to SCSI unload drive

Explanation: The drive could not be unloaded. The drive configuration may be incorrect and the drive may be logically DOWN. Also, the drive may never have become ready after media was placed in the drive.

Recommended Action:

1. Examine command output (if available), debug logs, and system logs for messages related to the error.
 - a. Enable debug logging by creating the necessary directories/folders. Increase the level of verbosity by adding the VERBOSE option in the vm.conf file and restarting `ltid` (the device daemon on UNIX or NetBackup Device Manager service on Windows).
 - b. Retry the operation and examine the logs.
2. Check for improperly configured cleaning media or interference with the drive cleaning operation. Check for bad media which may have led to the drive not being able to be unloaded. To avoid configuring incorrect device paths and device names, which is a common root cause of drive unload problems, use the Device Configuration wizard (on supported device discovery platforms) so that device paths and device names can be automatically configured. Resolve the situation by referring to troubleshooting methods or investigating the system log messages related to the specific error leading to the unload failure.

Robotic Status Code: 211

Message: Process killed by signal

Explanation: A robotic operation was canceled by an unexpected signal or event.

Recommended Action:

1. Examine system and debug logs for a more detailed message error.
 - a. Enable debug logging by creating the necessary directories/folders. Increase the level of verbosity by adding the VERBOSE option in the vm.conf file and restarting the daemons/services.
 - b. Retry the operation and examine the logs. Ensure that the robotic process is allowed to fully complete.
2. Check vendor or operating system administrative interfaces and logs to see if robotic commands are being canceled.

Robotic Status Code: 212

Message: Process killed by parent

Explanation: A robotic operation was canceled because it either did not return with a status before a designated time period had elapsed, or communications/hardware errors led to the need to reinitialize the device.



Recommended Action:

1. Stop any robot test utilities that may be running, since they have the lock on the robotic device when they are active, and can block other requests.
2. Check to see whether the robotic device is still functioning.
3. Check whether excessive hardware or communication problems have delayed the completion of a robotic command.
4. Use a robot test utility to send commands to the device to see whether it is responsive. Verify that there are no unexpected Media Manager processes running by executing `vmpps`. Some processes are expected to remain running, but some processes that do not go away could indicate a more serious problem, such as a hung system call.

Robotic Status Code: 213

Message: Drive does not exist in robot

Explanation: A targeted drive was not found in the robotic library. The drive configuration may be incorrect.

Recommended Action:

1. Examine command output (if available), debug logs, and system logs for messages related to the error.
 - a. Enable debug logging by creating the necessary directories/folders. Increase the level of verbosity by adding the `VERBOSE` option in the `vm.conf` file and restarting `ltid` (the device daemon on UNIX or NetBackup Device Manager service on Windows).
 - b. Retry the operation and examine the logs.
2. Attempt to obtain the list of drives using a method that involves a robotic library query, such as that available from the robot test utility. Compare the list of drives returned against the device configuration. Ensure that `ltid` (the Media Manager device daemon on UNIX or the NetBackup Device Manager service on Windows) was stopped and restarted after changes were last made to the device configuration.

Robotic Status Code: 214

Message: Robot number does not exist

Explanation: A targeted robotic library was not found in the active device configuration.

Recommended Action:

1. Examine command output (if available), debug logs, and system logs for messages related to the error.
 - a. Enable debug logging by creating the necessary directories/folders. Increase the level of verbosity by adding the VERBOSE option in the `vm.conf` file and restarting `ltid` (the device daemon on UNIX or NetBackup Device Manager service on Windows).
 - b. Retry the operation and examine the logs.
2. Ensure that `ltid` (the Media Manager device daemon on UNIX or the NetBackup Device Manager service on Windows) was stopped and restarted after changes were last made to the device configuration. When issuing commands to robotic libraries, specify only robotic libraries that are actively part of the device configuration.

Robotic Status Code: 215

Message: Requested tape in other or non-configured drive

Explanation: The targeted media was found in a drive differing from the targeted drive.

It is normal for requested media to be temporarily unavailable. Also, media can remain unavailable until administrator or operator action is taken.

Recommended Action:

1. If the media is needed immediately, examine command output (if available), debug logs, and system logs for messages relating to the targeted media.
 - a. Enable debug logging by creating the necessary directories/folders. Increase the level of verbosity by adding the VERBOSE option in the `vm.conf` file and restarting `ltid` (the device daemon on UNIX or NetBackup Device Manager service on Windows).
 - b. Retry the operation and examine the logs.
2. Check for conflicts between multiple applications using media in the robotic library. Check integrity of the drive and drive paths, so that media is not routinely left in other drives.

Robotic Status Code: 216

Message: Door is open on cabinet

Explanation: The robotic library door was open.

Recommended Action: Close the door of the robotic library and reissue the robotic request. Check to see if the door latch mechanism is working by comparing what happens with robot test utility commands when the door is opened versus when it is closed.

Robotic Status Code: 217

Message: Requested slot already has cartridge

Explanation: The requested slot was already held or was associated with a cartridge.

Recommended Action: Ensure that the inject/eject request does not target a slot that already contains media. Check for media in drives to ensure that the media's home slot location is not being targeted for use with media to be injected.

Robotic Status Code: 218

Message: Cannot move from media access port to slot

Explanation: A robotic inject media operation returned a status indicating that an inject failure occurred.

Recommended Action:

1. Check to see whether the robotic library has a media access port. Use the robot test utility to validate this. Investigate whether the administrator or operator has canceled the inject operation. Ensure that inject for LMF robot types is done only on the LMF server.
2. Examine command output (if available), debug logs, and system logs for messages related to the error.
 - a. Enable debug logging by creating the necessary directories/folders. Increase the level of verbosity by adding the VERBOSE option in the `vm.conf` file and restarting `ltid` (the device daemon on UNIX or NetBackup Device Manager service on Windows).
 - b. Retry the operation and examine the logs.

Robotic Status Code: 219

Message: Cannot move from slot to media access port

Explanation: A robotic eject media operation returned a status indicating that an eject failure occurred.

Recommended Action:



1. Check to see whether the robotic library has a media access port. Use the robot test utility to validate this. Investigate whether the administrator or operator has canceled the eject operation. Ensure that eject for LMF robot types is done only on the LMF server. When ejecting RSM media, ensure that the device is available, and that media is available in the NetBackup media pool.
2. Examine command output (if available), debug logs, and system logs for messages related to the error.
 - a. Enable debug logging by creating the necessary directories/folders. Increase the level of verbosity by adding the `VERBOSE` option in the `vm.conf` file and restarting `ltid` (the device daemon on UNIX or NetBackup Device Manager service on Windows).
 - b. Retry the operation and examine the logs.

Robotic Status Code: 220

Message: Media access port does not contain media

Explanation: A robotic inject media operation returned a status indicating that the media access port does not contain any cartridges/media. The operator or administrator may not have placed media into the media access port for inject.

Recommended Action:

1. Enable debug logging by creating the necessary directories/folders. Increase the level of verbosity by adding the `VERBOSE` option in the `vm.conf` file and restarting `ltid` (the device daemon on UNIX or NetBackup Device Manager service on Windows). Retry the operation and examine the logs.
2. Coordinate inject/eject operations between all operators and administrators.

Robotic Status Code: 221

Message: Media access port already contains media

Explanation: A robotic eject media operation returned a status indicating that the media access port contains one or more cartridges. The operator or administrator may not have removed media from the media access port as part of the latest (or a previous) eject operation.

Recommended Action:



1. Enable debug logging by creating the necessary directories/folders. Increase the level of verbosity by adding the VERBOSE option in the `vm.conf` file and restarting `ltid` (the device daemon on UNIX or NetBackup Device Manager service on Windows). Retry the operation and examine the logs.
2. Coordinate inject/eject operations between all operators and administrators. Ensure the media access port is empty of media before starting an eject operation.

Robotic Status Code: 222

Message: Robotic arm has no addressable holder

Explanation: An element of the robot is missing a holder and cannot be used.

Recommended Action:

1. Examine command output (if available), debug logs, and system logs for messages related to the error.
 - a. Enable debug logging by creating the necessary directories/folders. Increase the level of verbosity by adding the VERBOSE option in the `vm.conf` file and restarting `ltid` (the device daemon on UNIX or NetBackup Device Manager service on Windows).
 - b. Retry the operation and examine the logs.
2. Investigate the state of the physical hardware and correct the holder status for storage, drive, and transport elements as needed. Then, resubmit the request.

Robotic Status Code: 223

Message: Robot busy, cannot perform operation

Explanation: The robot is busy performing another operation, using resources needed for the requested operation.

Recommended Action: Wait until the robot is done performing current external-based requests (including robot inventory and inject/eject media) before starting new requests. Check vendor or operating system administrative interfaces and logs to see if robotic resources are busy.

Robotic Status Code: 224

Message: Control daemon connect or protocol error

Explanation: A protocol error occurred between robotic and other components.

Recommended Action:

1. Examine command output (if available), debug logs, and system logs for messages related to the error.
 - a. Enable debug logging by creating the necessary directories/folders. Increase the level of verbosity by adding the VERBOSE option in the `vm.conf` file and restarting `ltid` (the device daemon on UNIX or NetBackup Device Manager service on Windows).
 - b. Retry the operation and examine the logs.
2. Resolve the situation by referring to troubleshooting methods or investigating the system log messages related to the specific error leading to the media mount failure. Verify that all Media Manager binaries are at a compatible version level.
3. Verify that robotic interfaces to vendor and operating system software have compatible versions.

Robotic Status Code: 225

Message: Robot hardware or communication error

Explanation: A hardware or communications error occurred between robotic and other components.

Recommended Action:

1. Examine command output (if available), debug logs, and system logs for messages related to the error.
 - a. Enable debug logging by creating the necessary directories/folders. Increase the level of verbosity by adding the VERBOSE option in the `vm.conf` file and restarting `ltid` (the device daemon on UNIX or NetBackup Device Manager service on Windows).
 - b. Retry the operation and examine the logs.
2. Resolve the situation by referring to troubleshooting methods or investigating the system log messages related to the specific error leading to the media mount failure.
3. Verify that all Media Manager binaries are at a compatible version level. Verify that robotic interfaces to vendor and operating system hardware and software have compatible versions.

Robotic Status Code: 226

Message: Requested slot contains the wrong tape



Explanation: The media in the requested slot is different from the media expected in that slot. The volume configuration is not consistent with the physical contents of the robotic library that is associated with the slot associated with the requested volume.

Recommended Action: The volume configuration or media placement in the robotic library needs to be adjusted using one of the media management interfaces. Determine whether the barcode has changed or whether the media has been changed since the last time the volume database was reconciled for the affected slot. If only the barcode has changed but not the media, issue an update barcode request for each affected volume. If the media has been changed, use a media management interface to run robot inventory update, which will update the volume database to reflect the physical location of the media.

Robotic Status Code: 228

Message: Requested slot does not exist in robot

Explanation: The slot associated with a request is not valid for the robot.

Recommended Action:

1. Examine command output (if available), debug logs, and system logs for messages related to the error.
 - a. Enable debug logging by creating the necessary directories/folders. Increase the level of verbosity by adding the VERBOSE option in the `vm.conf` file and restarting `ltid` (the device daemon on UNIX or NetBackup Device Manager service on Windows).
 - b. Retry the operation and examine the logs.
2. Issue a robot inventory Contents report to determine the valid slot range for the robot. Check the volume configuration to ensure that only valid slots are referenced in volume records, paying particular attention to the starting and ending slot numbers. Update the volume configuration as needed, or request only valid slot ranges for robotic operations.

Robotic Status Code: 229

Message: Requested operation is not supported by the robot

Explanation: A robotic operation was sent to a robotic component that did not support that operation, or options requested for the operation were not supported. There may be an incompatibility between components or versions of the product.

Recommended Action:



1. Examine command output (if available), debug logs, and system logs for a more detailed message on the error.
 - a. Enable debug logging by creating the necessary directories/folders. Increase the level of verbosity by adding the VERBOSE option in the vm.conf file and restarting the daemons/services, or execute the command's verbose option, if available.
 - b. Retry the operation and examine the logs.
2. Verify that all Media Manager binaries and user interfaces are at a compatible version level.

Robotic Status Code: 230

Message: System error occurred during robot operation

Explanation: A robotic operation encountered a system error. This status code is used for generic system call failures within robotic daemons/processes.

Recommended Action:

1. Check for other error messages in the command or interface output to indicate which system call failed. Enable debug logging, retry the operation, and check the debug log files for more specific error messages.
2. Check the system application log for error and warning messages.
3. Verify that the system is not running out of virtual memory. If virtual memory is the problem, shut down unused applications or increase the amount of virtual memory. To increase virtual memory on Windows: display the Control Panel, double-click System, and on the Performance tab, set Virtual Memory to a higher value.
4. Verify that all product binaries are properly installed.
5. Verify that there are no unexpected Media Manager processes running by executing `vmps`. Some processes are expected to remain running, but some processes that do not go away could indicate a more serious problem, such as a hung system call.

Robotic Status Code: 232

Message: Volume not found in library

Explanation: The requested media was not found in the robotic library. The media has been ejected or become inaccessible for some other reason.

Recommended Action:



1. Examine command output (if available), debug logs, and system logs for messages related to the error.
 - a. Enable debug logging by creating the necessary directories/folders. Increase the level of verbosity by adding the `VERBOSE` option in the `vm.conf` file and restarting `ltid` (the device daemon on UNIX or NetBackup Device Manager service on Windows).
 - b. Retry the operation and examine the logs.
2. Issue a robot inventory Contents report to obtain the list of media in the robotic library. Check to see whether inventory filters have been enabled in the Media Manager configuration file, since they affect the contents of the media list returned from the robotic daemon/process. Use a robot test utility or an operating system/vendor administrative interface to verify the status of media, as needed. Update the volume configuration and search for the media if it was not in the robotic library, as needed, and resubmit the request.

Robotic Status Code: 233

Message: Volume is in library, but not in drive domain

Explanation: The media was found in the robotic library, in a domain of the library that is inaccessible to the drives that are configured in the robot.

Recommended Action: Issue a robot inventory Contents report to obtain the list of media in the robotic library. Check the device configuration and ensure that the drive addresses correspond to the correct domain for the media. Correct the device configuration as needed and restart `ltid` (the device daemon on UNIX or NetBackup Device Manager service on Windows). Use a robot test utility or a vendor administrative interface to verify the status of media, as needed. Update the volume configuration and physically move the media into the robotic library, as needed, and resubmit the request.

Robotic Status Code: 234

Message: Robot denied access to the resource

Explanation: The media was found in the robotic library, but is being denied access according to an established security policy.

Recommended Action: Issue a robot inventory Contents report to obtain the list of media in the robotic library. Use a vendor administrative interface to verify the status of media, as needed. Delete the media in the volume configuration, or make the volume accessible through a vendor administrative interface, as appropriate. Update the volume configuration, as needed, and resubmit the request.



Robotic Status Code: 235

Message: barcode label is unreadable

Explanation: The media was found in the robotic library, but it has an unreadable barcode label.

Recommended Action: Use the robot test utility or a vendor administrative interface to verify the status of media. Correct the label or replace the media as appropriate. Update the volume configuration, as needed, and resubmit the request.

Robotic Status Code: 236

Message: Robot has misplaced the media

Explanation: The requested media was known according to the vendor software managing the robotic library, but the media has been misplaced.

Recommended Action: Use a robot test utility or a vendor administrative interface to verify the status of media. Search for the media inside the robotic library. Update the volume configuration and search for the media if it was not in the robotic library, as needed, and resubmit the request.

Robotic Status Code: 237

Message: Volume is in use

Explanation: The media was in use.

Recommended Action: Use the robot test utility or a vendor administrative interface to verify the status of media. Determine what applications may be using the media. Dismount the media if it is not being used by an application. Wait for the media to become available, as needed.

Robotic Status Code: 238

Message: Requested drive is in an offline domain

Explanation: The drive targeted for a mount request was in a robotic library domain that is offline.

Recommended Action: Bring the robotic library domain (ACS Library Storage Module) back online, or postpone use of drives in that domain until the domain can be brought back online.

Robotic Status Code: 239

Message: Requested volume is in an offline domain

Explanation: The volume targeted for a mount request was in a robotic library domain that is in the offline or offline pending state.

Recommended Action: Bring the robotic library domain (ACS Library Storage Module) back online, or postpone use of media in that domain until the domain can be brought back online.

Robotic Status Code: 240

Message: A memory allocation attempt failed in the robotic daemon

Explanation: An attempt by the robotic control daemon to allocate memory has failed. This may indicate serious memory problems on your media server.

Recommended Action: Stop all NetBackup Media Manager daemons. Consult the documentation for your operating system memory management tools to determine what remaining process is leaking memory, and stop that process. Restart the NetBackup Media Manager daemons. Free up memory by terminating unneeded processes that consume a lot of memory. Add more swap space or physical memory if necessary.

Robotic Status Code: 241

Message: An error occurred accessing the RSM api

Explanation: A failure occurred in a call to the Removable Storage Manager application programming interface.

Recommended Action: Use the robot test utility or the operating system administrative interface to check the status of robotic libraries and media. Resolve the problem according to troubleshooting techniques recommended by Removable Storage Manager documentation.

Robotic Status Code: 242

Message: Robot media access port does not exist

Explanation: the requested media access port was not valid for use with the targeted media.

Recommended Action: Use the robot test utility or a vendor administrative interface to verify the media access port address based on the location of the media. Choose a media access port that is valid, or let one be automatically selected, and retry the robotic operation.

Robotic Status Code: 243

Message: Cannot open/create the media access port status file



Explanation: A robotic daemon/process could not create or open a status file in the database directory/folder.

Recommended Action: Investigate why the robot status file in the directory `/usr/opencv/volmgr/database` (UNIX) or folder `install_path\Volmgr\database` (Windows) cannot be created or opened. On Windows, check which account the NetBackup Device Manager service (and thus the robotic process) is running under and compare it against the security properties of the database folder.

Robotic Status Code: 244

Message: The eject command was aborted by the user

Explanation: An administrator or operator canceled an eject media request.

Recommended Action: This happens when an eject request has been canceled by an administrator or operator. The request may have been canceled for a number of reasons, such as missing or faulty media, the need to allow the media access port to be used for other requests, or the desire to perform the operation at a later time. Check with the administrator or operator for more information.

Robotic Status Code: 245

Message: Physical drive is not available

Explanation: A robotic mount operation could not be completed because physical drive resources are not available for the request. This is probably the result of operating in an environment based on virtualized resources, such as one involving the Storagenet 6000 Storage Domain Manager (SN6000).

The SN6000 virtualizes tape drives. Some configurations of the SN6000 may involve a different number of logical drives as compared to the number of physical drives (or equivalent resources) available for satisfying the requests for drive resources. Also, the relationship between the number of logical drives and physical drives may change as hardware failures occur. NetBackup scheduling, drive allocation, and drive assignment algorithms can only determine logical drive availability; NetBackup attempts to fully utilize all configured and available logical drives. If the number of logical drives being utilized exceeds the number of physical drives available, a NetBackup job may be started when insufficient drive resources are available for the job. Instead of queueing the job in the scheduler, the job runs and does not encounter the resource issue until the time it makes an ACS tape mount request.

Recommended Action:

1. Install the Shared Storage Option (SSO) license for mount requests to requeue when physical drive resources are not available.
2. Since there is a fixed limit for the number of drives that can be in use at any one time, optionally configure backup windows so the different storage units tied to the same physical drives are active only at non-overlapping times. Also, raise (or set to infinite) the media mount timeout to avoid job failures when the job cannot get a physical drive due to the drives all being busy.

Robotic Status Code: 246

Message: Failed to find an available slot to inject to

Explanation: An attempt to inject a volume into a full library failed. This should only occur when the library is full, meaning that all storage elements either contain media or have been assigned media that is currently mounted in a drive. Note that some libraries that support multiple media types restrict which type of media can be assigned to each storage element. In this case, this error might occur even if some of the storage elements in a library were not full. Since the empty storage elements may not match the media type for the media you are trying to inject, the library is full for this media type.

Recommended Action: Clear the media access port, then re-inventory the robot by doing a volume configuration update.

Robotic Status Code: 248

Message: Cannot recover aborted eject with this type of media access port

Explanation: An eject failed from a robot with a media access port that does not allow automatic recovery of media.

Recommended Action: Manually remove any media remaining in the robot's media access port, then re-inventory the robot to ensure that NetBackup's volume database matches what is in the library. You can also use the robot's utilities or the NetBackup `robtest` utility to move the media from the robot's media access port back to robotic storage elements. In any case, re-inventory the robot to ensure that the NetBackup volume database matches what is in the robot.

Robotic Status Code: 249

Message: Volume is in home slot

Explanation: Volume is currently in its home slot and ready for eject.

Recommended Action: None.



Robotic Status Code: 250

Message: Media access port is available

Explanation: Media access port is available for inject or eject.

Recommended Action: Begin inject or eject operation.

Robotic Status Code: 251

Message: Media access port is unavailable

Explanation: Media access port is not ready for inject or eject.

Recommended Action: Manually remove any media remaining in the robot's media access port. If this status persists, check robotic console for errors.

Robotic Status Code: 252

Message: Media access port is in inject mode

Explanation: Media access port is ready to inject and is not available for eject.

Recommended Action: Complete inject operation.

Robotic Status Code: 253

Message: Media access port is in eject mode

Explanation: Media access port is ready to eject and is not available for inject.

Recommended Action: Complete eject operation.

Robotic Status Code: 254

Message: Robot busy, inventory operation in progress

Explanation: The robot is not available because it is performing an inventory, using resources needed for the requested operation.

Recommended Action: Wait until the robot is done performing the inventory operation before starting new requests. Check the vendor or operating system administrative interfaces and logs to see if robotic resources are busy.

Robotic Status Code: 255

Message: Robot busy, inject operation in progress

Explanation: The robot is not available because it is performing an inject operation, using resources needed for the requested operation.

Recommended Action: Wait until the robot is done performing the inject operation before starting new requests. check the vendor or operating system administrative interfaces and logs to see if robotic resources are busy.

Robotic Status Code: 256

Message: Robot busy, multiple eject in progress

Explanation: The robot is unavailable because a multiple eject is in progress, using resources needed for the requested operation.

Recommended Action: Wait until the robot is done performing the multiple eject operation before starting new requests. check the vendor or operating system administrative interfaces and logs to see if robotic resources are busy.

Robotic Status Code: 257

Message: Robot busy, multiple inject operation in progress

Explanation: The robot is unavailable because a multiple inject is in progress, using resources needed for the requested operation

Recommended Action: Wait until the robot is done performing the multiple inject operation before starting new requests. check the vendor or operating system administrative interfaces and logs to see if robotic resources are busy.

Robotic Error Codes

These status codes are returned if a robotic daemon/process was started from the command line and an error occurs. For example, if the administrator executes the following:

```
/usr/openv/volmgr/bin/tl8d
```

and no robots are configured, the following may be returned:

```
TL8: No robots are configured
```

These status codes are also logged to the system log.

Usually, robotic daemons/processes are not started from the command line, but are started automatically, as needed, when `ltid` starts.

Robot Error Status Code: 1

Message: You must be ROOT to start daemon

Explanation: A robotic daemon was started by a user other than root. This applies to UNIX systems only.



Recommended Action: Log on as the root user before starting robotic daemons. Allow robotic daemons to be started automatically as needed by `ltid` (the device daemon).

Robot Error Status Code: 2

Message: LTI Daemon may not be running

Explanation: On an attempt to start a robotic daemon/process, an attempt to connect to the `ltid` message queue failed, indicating that `ltid` (the device daemon / NetBackup Device Manager service), may not be running.

Recommended Action:

1. Start `ltid` so that shared memory can be initialized, allowing the robotic daemon/process to function.
2. If problems persist, examine command output (if available), debug logs, and system logs for messages related to the error.
 - a. Enable debug logging by creating the necessary directories/folders. Increase the level of verbosity by adding the `VERBOSE` option in the `vm.conf` file and restarting the daemons/services, or execute the command's verbose option, if available.
 - b. Retry the operation and examine the logs.
3. On UNIX servers, gather the output of the `ipcs -a` command to see what resources are currently in use.

Robot Error Status Code: 3

Message: Error in getting shared memory

Explanation: A robotic daemon/process was unable to get a shared memory identifier associated with a segment of shared memory that `ltid` maintains. (`ltid` is the Media Manager device daemon on UNIX or the NetBackup Device Manager service on Windows.)

Recommended Action:



1. Examine command output (if available), debug logs, and system logs for messages related to the error.
 - a. Enable debug logging by creating the necessary directories/folders. Increase the level of verbosity by adding the `VERBOSE` option in the `vm.conf` file and restarting the daemons/services, or execute the command's verbose option, if available.
 - b. Retry the operation and examine the logs.
2. On UNIX servers, gather the output of the `ipcs -a` command to see what resources are currently in use.

Robot Error Status Code: 4

Message: Error in attaching the shared memory

Explanation: A robotic daemon/process was unable to attach a shared memory segment that `ltid` maintains. (`ltid` is the Media Manager device daemon on UNIX or the NetBackup Device Manager service on Windows.)

Recommended Action:

1. Examine command output (if available), debug logs, and system logs for messages related to the error.
 - a. Enable debug logging by creating the necessary directories/folders. Increase the level of verbosity by adding the `VERBOSE` option in the `vm.conf` file and restarting `ltid`.
 - b. Retry the operation and examine the logs.
2. On UNIX servers, gather the output of the `ipcs -a` command to see what resources are currently in use.

Robot Error Status Code: 5

Message: Error in getting process Id

Explanation: A robotic daemon/process was unable to obtain its own process identifier due to a system call failure.

Recommended Action: Investigate operating system functionality regarding a process obtaining its own process identifier.



Robot Error Status Code: 6

Message: No devices are configured on the robot

Explanation: A robotic daemon/process was started, but no drives are configured for the robot.

Recommended Action: Some robotic daemons/processes will not run if there are no drives configured for them to manage. Add or reconfigure one or more drives to be in the associated robot. Then, stop and restart `ltid` (the Media Manager device daemon on UNIX or NetBackup Device Manager service on Windows).

Robot Error Status Code: 7

Message: No robots are configured

Explanation: A robotic daemon/process was started, but no robots of the associated robot type are configured.

Recommended Action: Robotic daemons/processes will not run if there are no robots configured for the associated robot type. Add or reconfigure one or more robots, then stop and restart `ltid` (the Media Manager device daemon on UNIX or NetBackup Device Manager service on Windows).

Robot Error Status Code: 8

Message: No memory available

Explanation: A robotic daemon/process was unable to allocate memory. This error occurs when there is insufficient system memory available. This could be caused by the system being overloaded with too many processes and there is not enough physical and virtual memory.

Recommended Action: Free up memory by terminating unneeded processes. Add more swap space or physical memory.

Robot Error Status Code: 9

Message: Error in SEMAPHORE operation

Explanation: A process was unable to perform a semaphore operation (such as lock or unlock) associated with resources maintained by `ltid`. (`ltid` is the Media Manager device daemon on UNIX or the NetBackup Device Manager service on Windows.)

Recommended Action:

1. Examine command output (if available), debug logs, and system logs for messages related to the error.
 - a. Enable debug logging by creating the necessary directories/folders. Increase the level of verbosity by adding the `VERBOSE` option in the `vm.conf` file and restarting the daemons/services, or execute the command's verbose option, if available.
 - b. Retry the operation and examine the logs.
2. On UNIX servers, gather the output of the `ipcs -a` command to see what resources are currently in use.

Robot Error Status Code: 10

Message: Fork failure occurred

Explanation: A robotic daemon/process could not create a child process due to a system error. This is probably an intermittent error based on the availability of resources on the system. (This applies to UNIX servers only.)

Recommended Action:

1. Restart the device daemon at a later time and investigate system problems that limit the number of processes.
2. Examine the system logs for a more detailed message on the error. Increase the level of verbosity by adding the `VERBOSE` option in the `vm.conf` file. Restart the device daemon, then retry the operation and examine the system log file.

Robot Error Status Code: 11

Message: System error occurred

Explanation: A robotic daemon/process encountered a system error.

Recommended Action: Examine the system log for a more detailed message on the error. Increase the level of verbosity by adding the `VERBOSE` option in the `vm.conf` file. Restart the device daemon `ltid` (UNIX) or NetBackup Device Manager service (Windows), then retry the operation and examine the system log file.

Robot Error Status Code: 12

Message: Usage error in creating child process

Explanation: A robotic daemon/process could not create a child process due to an incompatibility between robotic software components.



Recommended Action:

1. Examine system logs for a more detailed message on the error.
 - a. Increase the level of verbosity by adding the `VERBOSE` option in the `vm.conf` file. Restart the `ltid` device daemon (UNIX) or NetBackup Device Manager service.
 - b. Retry the operation and examine the system log file.
2. Verify that all Media Manager binaries are at a compatible version level.

Robot Error Status Code: 14

Message: You must be administrator to execute

Explanation: A robotic process was started under a user account that was lacking Administrator privileges. This applies to Windows systems only.

Recommended Action: Allow robotic daemons to be started automatically as needed by the NetBackup Device Manager service. Ensure that this service is being started from a user account with administrator privilege.

Robot Error Status Code: 16

Message: Devices located in multiple domains

Explanation: A robotic daemon/process encountered an invalid device configuration, in which drives from different domains were configured to be controlled by a single logical robot.

Recommended Action: Display the device configuration using `tpconfig -d` or a device configuration interface to see the robotic and drive information that is already configured. Ensure that the drive addresses do not span physical domains. Drives can only be configured in the same robot if they can be used with media from a single domain, where the domain includes a single physical library or multiple libraries connected by a cartridge exchange or pass-through mechanism.

Robot Error Status Code: 17

Message: Robotic daemon not licensed

Explanation: A robotic daemon/process was started without the required, current product license, or a required database file was missing or corrupt.

Recommended Action:

1. Check product documentation for supported device configurations.
2. Obtain an additional software license that allows robots of the associated robot type to be configured, or limit the configuration to robot types allowed by the current licensing. Check for the existence and permissions of the `external_robotics.txt` file in the `/usr/opencv/share` directory (UNIX) or in the `install_path\NetBackup\share` folder (Windows).

Device Diagnostics Status Codes

Device Diagnostics Status Code: 163

Message: the operation requested has failed

Explanation: The operation requested has failed for an unspecified reason.

Recommended Action: None. This error code may appear for a number of reasons, but does not indicate a complicated problem.

Device Diagnostics Status Code: 175

Message: unable to open the device test state file

Explanation: The process is not able to open the state file, mostly likely because it is locked by another process.

Recommended Action:

Try again to open the state file. If you cannot open the state file, you may have to remove the file, which would result in a loss of previous test runs.

Device Diagnostics Status Code: 176

Message: unable to find any records in the device test database

Explanation: The state file exists, but it is empty. This indicates that no previous test runs have occurred.

Recommended Action: None required.

Device Diagnostics Status Code: 182

Message: device test state file does not exist

Explanation: The state file does not exist. This may be because no tests have been run yet.

Recommended Action: If the state file is lost, any prior test runs are also lost. The recommended action is to start again.



Messages

This section lists Media Manager messages alphabetically. The status code type and number are included in parentheses after the message. Refer to the appropriate section in this chapter (such as “Media Manager Status Codes,” “Device Configuration Status Codes,” and so forth) for the status code with explanation and recommended action.

<NONE>

(Device Configuration Status Code 36)

A memory allocation attempt failed in the robotic daemon

(Robotic Status Code 240)

a scratch pool is already defined

(Media Manager Status Code 171)

A SCSI inquiry sent to the device has failed

(Device Configuration Status Code 16)

ADAMM GUID does not exist in database

(Media Manager Status Code 168)

ADAMM GUID is not unique in the database

(Media Manager Status Code 167)

Adding this device would exceed the maximum allowed

(Device Configuration Status Code 40)

Adding this drive would exceed the maximum allowed

(Device Configuration Status Code 39)

all available pool numbers are in use

(Media Manager Status Code 103)

all available rule numbers are in use

(Media Manager Status Code 120)

An error occurred accessing the RSM api

(Robotic Status Code 241)

another daemon already exists

(Media Manager Status Code 89)

barcode does not exist in database

(Media Manager Status Code 78)

barcode label is unreadable

(Robotic Status Code 235)

barcode not unique in database

(Media Manager Status Code 36)

barcode tag is not unique in rule database

(Media Manager Status Code 122)

Block device name for optical disk is not a block device

(Device Management Status Code 54)

cannot allocate requested memory

(Media Manager Status Code 18)

Cannot assign a robotically controlled device

(Device Management Status Code 64)

Cannot assign due to media ID mismatch

(Device Management Status Code 57)



cannot auto-eject this robot type

(Media Manager Status Code 51)

cannot auto-inject this robot type

(Media Manager Status Code 52)

Cannot backup/restore global device database files

(Device Configuration Status Code 47)

Cannot backup/restore local device database files

(Device Configuration Status Code 43)

Cannot change terminal mode

(Device Configuration Status Code 41)

cannot change volume pool for assigned volume

(Media Manager Status Code 91)

cannot connect to robotic software daemon

(Media Manager Status Code 42)

cannot connect to vmd [on host *host name*]

(Media Manager Status Code 70)

Cannot create miscellaneous working repository

(Device Configuration Status Code 42)

cannot delete assigned volume

(Media Manager Status Code 92)

cannot delete one of the default volume pools

(Media Manager Status Code 118)

Cannot discover devices. See the Troubleshooting Guide for details.

(Device Configuration Status Code 44)

Cannot execute command, permission denied

(Device Configuration Status Code 1)

cannot get host name

(Media Manager Status Code 76)

Cannot move from media access port to slot

(Robotic Status Code 218)

Cannot move from slot to media access port

(Robotic Status Code 219)

cannot obtain daemon lockfile

(Media Manager Status Code 21)

Cannot open/create the media access port status file

(Robotic Status Code 243)

cannot perform operation on this host

(Media Manager Status Code 60)

Cannot recover aborted eject with this type of media access port

(Robotic Status Code 248)

Cannot stop device daemon with tapes assigned

(Device Management Status Code 20)

Cannot synchronize global device database

(Device Configuration Status Code 5)



cannot update volume database due to existing errors

(Media Manager Status Code 80)

Character device name for optical disk is not a character device

(Device Management Status Code 38)

child process killed by signal

(Media Manager Status Code 63)

Control daemon connect or protocol error

(Robotic Status Code 224)

Current version does not support remote device host

(Device Configuration Status Code 38 and Media Manager Status Code 38)

current version does not support this configuration

(Media Manager Status Code 149)

daemon cannot obtain socket

(Media Manager Status Code 58)

daemon failed accepting connection

(Media Manager Status Code 59)

daemon resources are busy

(Media Manager Status Code 5)

daemon terminated

(Media Manager Status Code 7)

database already open

(Media Manager Status Code 24)

database close operation failed

(Media Manager Status Code 23)

database initialization failed

(Media Manager Status Code 22)

database lock operation failed

(Media Manager Status Code 29)

database open operation failed

(Media Manager Status Code 26)

database read operation read too few bytes

(Media Manager Status Code 28)

database read record operation failed

(Media Manager Status Code 27)

database seek operation failed

(Media Manager Status Code 30)

database unlock operation failed

(Media Manager Status Code 31)

database write operation wrote too few bytes

(Media Manager Status Code 33)

database write record operation failed

(Media Manager Status Code 32)

Device Configuration was not upgraded

(Device Configuration Status Code 50)



device entry is not unique in global device database

(Media Manager Status Code 153)

device management error

(Media Manager Status Code 83)

Device path is already in use

(Device Configuration Status Code 22)

device test state file does not exist

(Device Diagnostics Status Code 182)

Devices located in multiple domains

(Robot Error Status Code 16)

Door is open on cabinet

(Robotic Status Code 216)

Drive being assigned is either not NDMP or on the wrong NDMP client

(Device Management Status Code 37)

Drive does not exist in robot

(Robotic Status Code 213)

Drive does not support pending request density

(Device Management Status Code 17)

Drive index is in use by another drive

(Device Configuration Status Code 29)

Drive is currently assigned

(Device Management Status Code 2)

Drive is currently reserved

(Device Management Status Code 9)

Drive is not a shared drive

(Device Management Status Code 43)

Drive is not currently reserved for this host

(Device Management Status Code 45)

Drive name does not exist

(Device Configuration Status Code 35)

Drive name is already in use by another drive

(Device Configuration Status Code 34)

Drive not available in library for mount request

(Device Management Status Code 62)

Duplicate device path names

(Device Configuration Status Code 20)

error auto-generating volume group

(Media Manager Status Code 57)

Error in attaching the shared memory

(Robot Error Status Code 4)

Error in getting process Id

(Robot Error Status Code 5)

Error in getting semaphore for operator

(Device Management Status Code 34)



Error in getting semaphore

(Device Management Status Code 32)

Error in getting shared memory

(Robot Error Status Code 3)

Error in IPC SHMAT call

(Device Management Status Code 14)

Error in IPC SHMGET call

(Device Management Status Code 13)

Error in MsgGet

(Device Management Status Code 28)

Error in Receiving Daemon Message

(Device Management Status Code 6)

Error in Receiving Operator Message

(Device Management Status Code 4)

Error in Receiving User Message

(Device Management Status Code 8)

Error in SEMAPHORE operation

(Device Management Status Code 33)

Error in SEMAPHORE operation

(Robotic Error Status Code 9)

Error in Sending Daemon Message

(Device Management Status Code 5)

Error in Sending Operator Message

(Device Management Status Code 3)

Error in Sending User Message

(Device Management Status Code 7)

Evaluation period expired. Go to www.veritas.com to order this product.

(Media Manager Status Code 165)

failed appending to pool database

(Media Manager Status Code 104)

failed appending to rule database

(Media Manager Status Code 121)

failed changing terminal characteristics

(Media Manager Status Code 45)

failed during tpformat

(Media Manager Status Code 77)

failed initiating child process

(Media Manager Status Code 88)

failed making the database directory

(Media Manager Status Code 25)

failed opening tmp output file

(Media Manager Status Code 86)

Failed reading drive or robot config file

(Device Configuration Status Code 13)



failed receiving from robotic software daemon

(Media Manager Status Code 44)

failed receiving from vmd

(Media Manager Status Code 72)

failed redirecting input to pipe

(Media Manager Status Code 62)

failed redirecting tmp output file

(Media Manager Status Code 87)

failed sending request to vmd

(Media Manager Status Code 69)

failed sending to robotic software daemon

(Media Manager Status Code 43)

failed sending to vmd

(Media Manager Status Code 71)

failed to back up Media Manager databases

(Media Manager Status Code 178)

Failed to find an available slot to inject to

(Robotic Status Code 246)

Failed writing drive or robot config file

(Device Configuration Status Code 12)

File name already exists

(Device Management Status Code 40)

File name does not exist

(Device Management Status Code 25)

Fork failure occurred

(Robot Error Status Code 10)

Frequency-based cleaning is not supported for this drive

(Device Management Status Code 51)

global device database append operation failed

(Media Manager Status Code 155)

global device database close operation failed

(Media Manager Status Code 158)

global device database lock operation failed

(Media Manager Status Code 156)

global device database open operation failed

(Media Manager Status Code 157)

global device database record not found

(Media Manager Status Code 152)

global device database truncate operation failed

(Media Manager Status Code 154)

group is not valid for this host

(Media Manager Status Code 128)

Host is not the scan host for this shared drive

(Device Management Status Code 48)



incompatible database version

(Media Manager Status Code 146)

Incomplete robot information

(Device Configuration Status Code 24)

Incorrect tpreq access mode

(Device Management Status Code 42)

invalid barcode

(Media Manager Status Code 10)

invalid change type

(Media Manager Status Code 75)

invalid change-entry request

(Media Manager Status Code 50)

Invalid command code

(Robotic Status Code 207)

invalid command usage

(Media Manager Status Code 4)

invalid database version header

(Media Manager Status Code 56)

invalid description

(Media Manager Status Code 11)

Invalid device path name

(Device Configuration Status Code 19)

Invalid drive index

(Device Configuration Status Code 14)

invalid drive name

(Media Manager Status Code 129)

Invalid Drive Number

(Device Management Status Code 23)

Invalid drive type for the robot

(Device Configuration Status Code 27)

Invalid Drive Type/Density

(Device Management Status Code 1)

invalid expiration date

(Media Manager Status Code 113)

invalid global device database entry

(Media Manager Status Code 151)

invalid host name

(Media Manager Status Code 136)

invalid maximum mounts

(Media Manager Status Code 114)

invalid media generation rule

(Media Manager Status Code 140)

invalid media ID for naming mode

(Media Manager Status Code 41)



invalid media ID

(Media Manager Status Code 8)

invalid media type

(Media Manager Status Code 9)

invalid number of cleanings

(Media Manager Status Code 74)

invalid number of mounts

(Media Manager Status Code 141)

invalid offsite location

(Media Manager Status Code 142)

invalid offsite return date

(Media Manager Status Code 144)

invalid offsite sent date

(Media Manager Status Code 143)

invalid offsite session id

(Media Manager Status Code 148)

invalid offsite slot

(Media Manager Status Code 147)

Invalid Operator

(Device Management Status Code 12)

invalid pool database entry

(Media Manager Status Code 102)

invalid protocol request

(Media Manager Status Code 6)

invalid query type

(Media Manager Status Code 73)

invalid robot coord1

(Media Manager Status Code 16)

invalid robot coord2

(Media Manager Status Code 17)

Invalid robot drive number for the robot type

(Device Configuration Status Code 28)

invalid robot host

(Media Manager Status Code 14)

Invalid robot number

(Device Configuration Status Code 15)

invalid robot number

(Media Manager Status Code 13)

Invalid robot type

(Device Configuration Status Code 18)

invalid robot type

(Media Manager Status Code 12)

invalid rule database entry

(Media Manager Status Code 119)



invalid scratch pool name

(Media Manager Status Code 173)

Invalid SCSI bus number for the robot

(Device Configuration Status Code 8)

Invalid SCSI logical unit number for the robot

(Device Configuration Status Code 10)

Invalid SCSI port number for the robot

(Device Configuration Status Code 7)

Invalid SCSI target for the robot

(Device Configuration Status Code 9)

Invalid Usage

(Device Configuration Status Code 11)

invalid volgroup

(Media Manager Status Code 15)

Invalid volume count

(Device Management Status Code 18)

invalid volume database host

(Media Manager Status Code 19)

invalid volume move mode

(Media Manager Status Code 53)

Invalid volume pool specified

(Device Management Status Code 65)

invalid volume pool

(Media Manager Status Code 90)

IPC Error: Daemon may not be running

(Device Management Status Code 22)

IPC sequence error

(Device Management Status Code 10)

LTI Daemon may not be running

(Robot Error Status Code 2)

Magic Number MisMatch

(Device Management Status Code 29)

Media access port already contains media

(Robotic Status Code 221)

Media access port does not contain media

(Robotic Status Code 220)

Media access port is available

(Robotic Status Code 250)

Media access port is in eject mode

(Robotic Status Code 253)

Media access port is in inject mode

(Robotic Status Code 252)

Media access port is unavailable

(Robotic Status Code 251)



media access port not available

(Media Manager Status Code 166)

media generation rule already exists

(Media Manager Status Code 138)

media generation rule does not exist

(Media Manager Status Code 139)

media ID is not the specified media type

(Media Manager Status Code 95)

media ID not unique in database

(Media Manager Status Code 34)

media type and volume group mismatch

(Media Manager Status Code 101)

Mount canceled, device daemon is terminating

(Device Management Status Code 56)

must be root user to execute command

(Media Manager Status Code 3)

network protocol error

(Media Manager Status Code 39)

No action pending for given mount index

(Device Management Status Code 50)

no child process to wait for

(Media Manager Status Code 64)

no cleaning tape available

(Media Manager Status Code 66)

No cleaning tape is defined in the device's robot or 0 cleanings remaining

(Device Management Status Code 59)

No device found in RSM at the specified location

(Device Configuration Status Code 45)

No device is registered at these SCSI coordinates

(Device Configuration Status Code 51)

No devices are configured on the robot

(Robot Error Status Code 6)

no entries changed

(Media Manager Status Code 47)

no entries deleted

(Media Manager Status Code 48)

no entries inserted

(Media Manager Status Code 49)

No media found in device or robot slot, please verify

(Device Management Status Code 61)

No memory available

(Robot Error Status Code 8)

No mount pending for given mount index

(Device Management Status Code 16)



no pools in the pool list

(Media Manager Status Code 112)

No robot daemon or robotics are unavailable

(Device Management Status Code 60)

No robot is defined of this type

(Device Management Status Code 52)

No robots are configured

(Robot Error Status Code 7)

<NONE>

(Device Configuration Status Code 36)

not authorized to connect to vmd

(Media Manager Status Code 126)

One implicit reserve already exists

(Device Management Status Code 11)

Only the administrative user can perform the requested operation

(Device Management Status Code 19)

operation not allowed on cleaning cartridge

(Media Manager Status Code 117)

Operator denied mount request

(Device Management Status Code 55)

oprdr request is not supported on the remote host

(Media Manager Status Code 137)

oprdr returned abnormal status

(Media Manager Status Code 96)

Parameter is invalid

(Device Management Status Code 39)

Physical drive is not available

(Robotic Status Code 245)

pool database close operation failed

(Media Manager Status Code 107)

pool database lock operation failed

(Media Manager Status Code 106)

pool database open operation failed

(Media Manager Status Code 108)

pool database truncate operation failed

(Media Manager Status Code 110)

pool does not exist in pool database

(Media Manager Status Code 109)

pool not defined as a scratch pool

(Media Manager Status Code 172)

poolname is not unique in pool database

(Media Manager Status Code 105)

Process killed by parent

(Robotic Status Code 212)



Process killed by signal

(Robotic Status Code 211)

protocol error

(Media Manager Status Code 20)

registering this host would exceed the maximum allowed

(Media Manager Status Code 150)

request can only be performed on the Media and Device Management Domain Server

(Media Manager Status Code 177)

request completed

(Media Manager Status Code 1)

Request has been queued (Cancel to clear message

(Device Management Status Code 53)

Request terminated because host not validated for volume pool

(Device Management Status Code 26)

Request terminated because media id is expired

(Device Management Status Code 27)

Request terminated because *media id* will exceed maximum mount count

(Device Management Status Code 30)

Request terminated because media is a cleaning tape

(Device Management Status Code: 71)

Request terminated because media is unavailable (in DOWN drive, misplaced, write protected or unmountable

(Device Management Status Code 35)

Request terminated because media is unmountable

(Device Management Status Code 69)

Request terminated because media is write protected

(Device Management Status Code 70)

Request terminated because mount requests are disabled

(Device Management Status Code 63)

Request terminated because of volume pool mismatch

(Device Management Status Code 66)

Request terminated because user not validated for volume pool

(Device Management Status Code 67)

Request terminated because user/group not validated for volume pool

(Device Management Status Code 68)

Request terminated by tpunmount call from another process

(Device Management Status Code 36)

Requested drive could not be reserved

(Device Management Status Code 24)

requested drive is already reserved by host

(Media Manager Status Code 145)

requested drive is already reserved

(Media Manager Status Code 130)

Requested drive is in an offline domain

(Robotic Status Code 238)



requested drive is not currently registered

(Media Manager Status Code 132)

requested drive is not currently reserved

(Media Manager Status Code 134)

requested drive is not registered for host

(Media Manager Status Code 131)

requested drive is not reserved by host

(Media Manager Status Code 133)

requested host is not currently registered

(Media Manager Status Code 135)

Requested number of drives are not configured

(Device Management Status Code 31)

Requested operation is not supported by the robot

(Robotic Status Code 229)

Requested slot already has cartridge

(Robotic Status Code 217)

Requested slot contains the wrong tape

(Robotic Status Code 226)

Requested slot does not exist in robot

(Robotic Status Code 228)

Requested slot is empty

(Robotic Status Code 208)

Requested tape in other or non-configured drive

(Robotic Status Code 215)

Requested volume is in an offline domain

(Robotic Status Code 239)

Residence is not licensed for multihosted drive support

(Device Configuration Status Code 37)

Robot busy, cannot perform operation

(Robotic Status Code 223)

Robot busy, inject operation in progress

(Robotic Status Code 255)

Robot busy, inventory operation in progress

(Robotic Status Code 254)

Robot busy, multiple eject operation in progress

(Robotic Status Code 256)

Robot busy, multiple inject operation in progress

(Robotic Status Code 257)

Robot denied access to the resource

(Robotic Status Code 234)

Robot drive number in use for this robot

(Device Configuration Status Code 25)

Robot hardware or communication error

(Robotic Status Code 225)



Robot has misplaced the media

(Robotic Status Code 236)

robot host and volume group mismatch

(Media Manager Status Code 82)

Robot media access port does not exist

(Robotic Status Code 242)

robot number and robot host mismatch

(Media Manager Status Code 61)

robot number and robot type mismatch

(Media Manager Status Code 54)

robot number and volume group mismatch

(Media Manager Status Code 55)

Robot number does not exist

(Device Configuration Status Code 31)

Robot number does not exist

(Robotic Status Code 214)

Robot number is already in use

(Device Configuration Status Code 21)

Robot number is in use by another robot

(Device Configuration Status Code 30)

robot type and volume group mismatch

(Media Manager Status Code 81)

Robot type is not supported on this platform

(Device Configuration Status Code 6)

Robot type must be controlled locally

(Device Configuration Status Code 33)

Robotic arm has no addressable holder

(Robotic Status Code 222)

Robotic daemon not licensed

(Robot Error Status Code 17)

Robotic dismount failure

(Robotic Status Code 206)

Robotic mount failure

(Robotic Status Code 205)

robotic volume position is already in use

(Media Manager Status Code 37)

RSM is supported only on Microsoft Windows 2000 and later OS versions

(Device Configuration Status Code 48)

rule database close operation failed

(Media Manager Status Code 124)

rule database lock operation failed

(Media Manager Status Code 123)

rule database open operation failed

(Media Manager Status Code 125)



rule database truncate operation failed

(Media Manager Status Code 98)

rule does not exist in rule database

(Media Manager Status Code 97)

specified robot is unknown to vmd

(Media Manager Status Code 79)

STATUS_SUCCESS

(Robotic Status Code 200)

Success

(Device Configuration Status Code 0)

Success

(Format Optical Status Code 0)

System error occurred during robot operation

(Robotic Status Code 230)

System error occurred

(Robot Error Status Code 11)

system error

(Media Manager Status Code 2)

Tape file path exceeds 255 character maximum

(Device Management Status Code 49)

Tape needs to be write enabled

(Device Management Status Code 46)

The device is not robotic, cannot perform cleaning

(Device Management Status Code 58)

The device name is not valid, no device responded

(Device Configuration Status Code 52)

The drive is DOWN

(Device Management Status Code 15)

The drive is not ready or inoperable

(Device Management Status Code 21)

The eject command was aborted by the user

(Robotic Status Code 244)

The device_mappings file has invalid license info

(Device Configuration Status Code 2)

the entered volume status does not match existing status

(Media Manager Status Code 183)

the global device database device name is invalid

(Media Manager Status Code 162)

the global device database device serial number is invalid

(Media Manager Status Code 161)

the global device database device type is invalid

(Media Manager Status Code 160)

The global device database hostname is invalid

(Device Configuration Status Code 49)



The global device database version is incompatible

(Device Configuration Status Code 4)

the operation requested has failed

(Device Diagnostics Status Code 163)

the operation was attempted on an incompatible media server version

(Media Manager Status Code 180)

the requested slot is empty

(Media Manager Status Code 100)

the robotic daemon returned an invalid volume GUID

(Media Manager Status Code 164)

the robotic library is full and may still have media in its map

(Media Manager Status Code 185)

the specified pool is not empty

(Media Manager Status Code 111)

the volume guid is not unique in the database

(Media Manager Status Code 159)

there is an error in the integrity of this device domain

(Media Manager Status Code 179)

this machine is not the volume database host

(Media Manager Status Code 84)

This robot type does not support multiple media types

(Device Configuration Status Code 17)

Timeout waiting for robotic command

(Robotic Status Code 203)

too many volumes in volume group

(Media Manager Status Code 68)

tpformat: Cannot open

(Format Optical Status Code 3)

tpformat: Cannot read

(Format Optical Status Code 4)

tpformat: Cannot seek

(Format Optical Status Code 5)

tpformat: Cannot set volume header

(Format Optical Status Code 2)

tpformat: Cannot write

(Format Optical Status Code 6)

tpformat: Command interrupted

(Format Optical Status Code 11)

tpformat: Existing media ID

(Format Optical Status Code 7)

tpformat: Invalid robot

(Format Optical Status Code 10)

tpformat: Invalid usage

(Format Optical Status Code 1)



tpformat: Must be root

(Format Optical Status Code 8)

tpformat: No media present in drive or robot slot

(Format Optical Status Code 13)

tpformat: Skip

(Format Optical Status Code 12)

tpformat: Tape request failed

(Format Optical Status Code 9)

unable to find any records in the device test database

(Device Diagnostics Status Code 176)

unable to generate a unique media id

(Media Manager Status Code 127)

Unable to initialize robot

(Robotic Status Code 204)

unable to link to dynamic library

(Media Manager Status Code 174)

Unable to open drive

(Robotic Status Code 209)

Unable to open robotic path

(Robotic Status Code 201)

unable to open the device test state file

(Device Diagnostics Status Code 175)

Unable to retrieve GUID from RSM api

(Device Configuration Status Code 46)

Unable to SCSI unload drive

(Robotic Status Code 210)

unable to send exit status

(Media Manager Status Code 67)

Unable to sense robotic device

(Robotic Status Code 202)

unexpected data from robotic software daemon

(Media Manager Status Code 46)

unexpected data received

(Media Manager Status Code 40)

Unknown drive name

(Device Management Status Code 41)

Usage error in creating child process

(Robot Error Status Code 12)

user is not valid for this host

(Media Manager Status Code 99)

volume daemon fork failed

(Media Manager Status Code 85)

volume does not exist in database

(Media Manager Status Code 35)



volume group does not exist

(Media Manager Status Code 65)

volume has exceeded maximum mounts

(Media Manager Status Code 116)

volume has passed expiration date

(Media Manager Status Code 115)

volume is already assigned

(Media Manager Status Code 93)

Volume is in home slot

(Robotic Status Code 249)

Volume is in library, but not in drive domain

(Robotic Status Code 233)

Volume is in use

(Robotic Status Code 237)

volume is not in specified pool

(Media Manager Status Code 94)

Volume not found in library

(Robotic Status Code 232)

VxSS Access Denied

(Media Manager Status Code 188)

VxSS authentication failed

(Media Manager Status Code 187)

You do not have permission to create the file

(Device Management Status Code 44)

You must be administrator to execute

(Robot Error Status Code 14)

You must be ROOT to start daemon

(Robot Error Status Code 1)



Caution Effective disaster recovery procedures are specific to an environment and provide detailed information about everything that should be accomplished to prepare for disaster and to recover after disaster occurs. VERITAS provides general disaster recovery information that is intended as a model only; you must evaluate the information and then develop your own disaster recovery plans and procedures.

This chapter provides information about installing NetBackup and recovering NetBackup catalogs after a system disk failure. Specific procedures for replacing a failed disk, building partitions and logical volumes, and installing the operating system can be complicated and time consuming; such procedures are beyond the scope of this manual.

Note VERITAS recommends that you partition a replacement disk identically to the failed disk and reinstall NetBackup on the partition on which it was installed originally. Procedures in this chapter assume that you are recovering to the original system disk or to one configured exactly like the original. If you install NetBackup on a system disk that is partitioned differently or to a different partition and then recover the catalogs, NetBackup may not function properly because the recovered catalog information is for a different configuration.

For information and procedures, see the following:

- ◆ [“Recommended Backup Practices”](#)
- ◆ [“Master Server Disk Recovery for UNIX”](#)
- ◆ [“Media Server Disk Recovery for UNIX”](#)
- ◆ [“Client System Disk Recovery for UNIX”](#)
- ◆ [“Recovering the NetBackup Catalogs for UNIX”](#)
- ◆ [“Master Server Disk Recovery for Windows”](#)
- ◆ [“Media Server Disk Recovery for Windows”](#)
- ◆ [“Client System Disk Recovery for Windows”](#)
- ◆ [“Recovering the NetBackup Catalogs for Windows”](#)



Recommended Backup Practices

In addition to backing up files on a regular basis, it is important to select the correct files to back up. The first concern is to include all files with records that are critical to users and the organization. It is equally important to back up system and application files, so you can quickly and accurately restore a system to normal operation if a disaster occurs.

Include all Windows system files in your backups. In addition to the other system software, the Windows system directories include the registry, without which it is impossible to restore the client to its original configuration. If you are using a NetBackup exclude list for a client, do not specify any Windows system files in that list.

It is not a good idea to omit executable and other files for applications such as NetBackup. It is tempting to save tape by excluding these easy to reinstall files. However, backing up the entire application, ensures that you can restore it to its exact configuration. For example, if you have applied software updates or patches, restoring from a backup eliminates the need to reapply them, thus reducing recovery time.

Master Server Disk Recovery for UNIX

The procedures in this section explain how to recover your data if the system disk fails on a UNIX master server. Two general cases are considered:

- ◆ Root file system is intact. The operating system, NetBackup software, and some (if not all) other files are assumed to be lost.
- ◆ Root file system is lost along with everything else on the disk. This is a total recovery.

In both cases, you restore the server to the state it was in at the time of the most recent backup of the NetBackup catalogs. If the recovery is successful, reconfiguration is unnecessary.

Recovering Master Server When Root is Intact

The general steps are to first restore the operating system, then restore NetBackup, and finally to restore all other files.

Recover Master Server - Root Intact (overview)

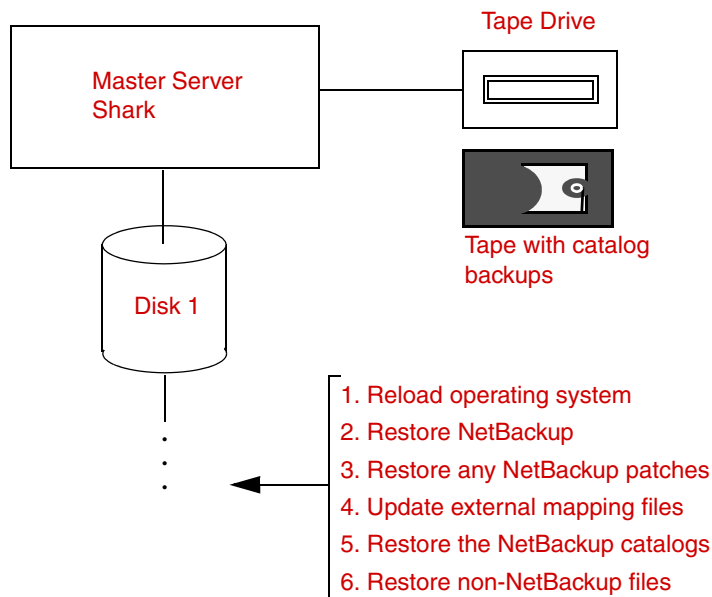

▼ **To recover the Master server with the root intact**

1. Verify that the operating system is working. If it isn't, take the appropriate corrective actions.
2. Reinstall NetBackup software. Do not configure NetBackup policies or devices.
See the *NetBackup Installation Guide for UNIX* for instructions.
3. Reinstall any NetBackup patches that had been previously installed.
See the documentation that was included with the patch software.
4. Update external mapping files.
See the *NetBackup Media Manager System Administrator's Guide*.
5. Recover the NetBackup catalogs by using the `bprecover` command on the master server.
Choose one of the procedures under "[Recovering the NetBackup Catalogs for UNIX](#)" on page 524.

Caution In [step 6](#), do not restore files to the `/usr/opensv/netbackup/db`, `/usr/opensv/volmgr/database`, or `/usr/opensv/var` directories. These directories were recovered in [step 5](#) and overwriting them with regular backups will leave the catalogs in an inconsistent state.

6. Start the NetBackup client-user interface and restore other files to the server as desired.

Recovering Master Server When Root is Lost

This procedure assumes that the root file system has been lost along with all other files on the system disk.

The recovery method described here reloads the operating system on an alternate boot disk and boots from this disk during the recovery. This lets you recover the root partition without risking a crash due to overwriting files that are being used by the operating system during the restore.

Recover Master Server When Root is Lost (overview)

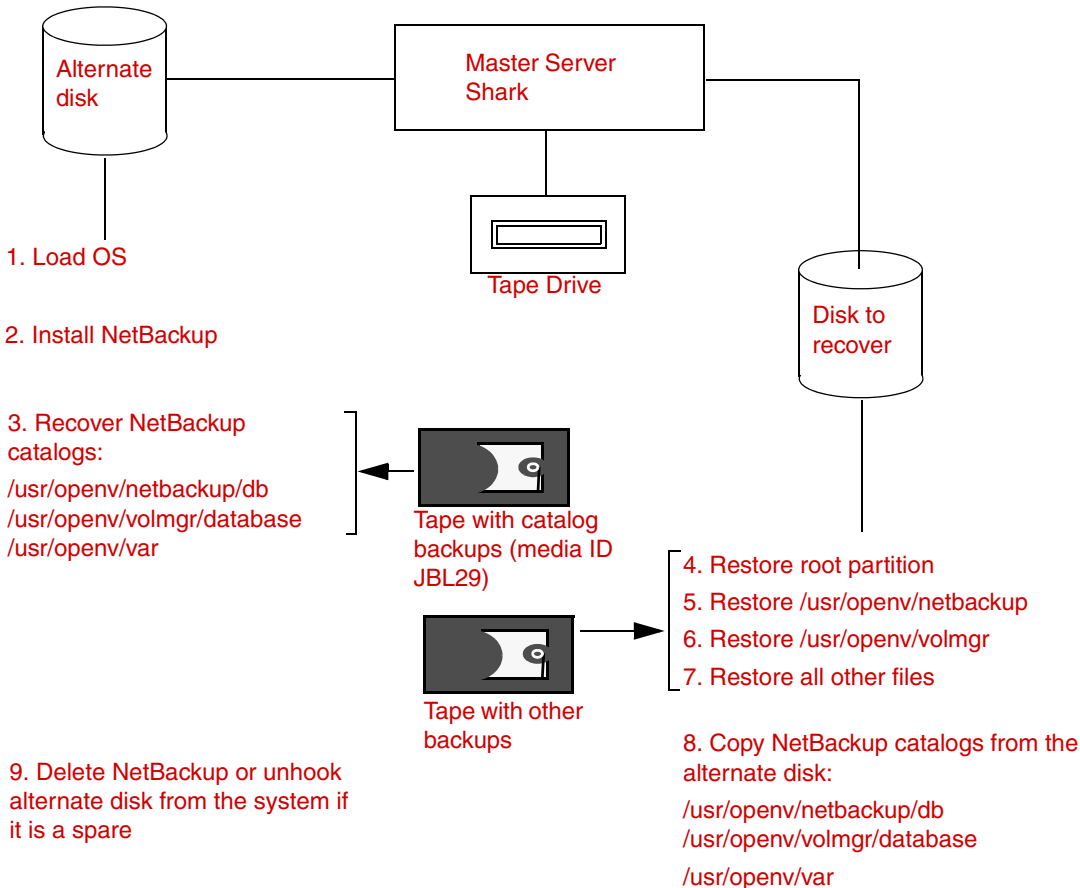

▼ To recover the Master server when the root is lost

1. Load the operating system on the alternate boot disk, using the same procedure as you normally would for the server.
2. Create, on the alternate disk, the partition and directory where NetBackup and its catalogs resided on the original disk. By default, they reside under /usr.
3. Install NetBackup on the alternate disk. See the *NetBackup Installation Guide for UNIX* for instructions on installing NetBackup software.

Note Do not reconfigure NetBackup policies. If reconfiguration is necessary, you will be given the necessary instructions later in this procedure.



Install only the robotic software for the devices that are required to read backups of the NetBackup catalogs and the regular backups of the disk being restored. If a nonrobotic drive can read these backups, then you do not need a robot. The example in the illustration requires only a nonrobotic tape drive.

4. Recover the NetBackup catalogs to the alternate disk by using the `bprecover` command on the master server.

The NetBackup catalogs can be recovered only to the same location from which they were backed up (alternate path recovery is not allowed).

Choose one of the procedures under “[Recovering the NetBackup Catalogs for UNIX](#)” on page 524.

5. Restore the root partition to the disk you are recovering.
6. Start the NetBackup client user interface and restore the latest backed up version of all files to the disk you are recovering.

It is not necessary to restore the NetBackup catalogs because you will be doing this in [step 7](#). But you must restore all other NetBackup files.

7. Copy the NetBackup catalogs from the alternate disk to the disk that you are recovering. These are the catalogs recovered in [step 4](#).
8. Stop all NetBackup processes that you started from NetBackup on the alternate disk.
9. Start and test the copy of NetBackup on the disk that you have recovered.
Try the NetBackup Administration utilities. Also, try some backups and restores.
10. When you are satisfied that the recovery is complete, delete the NetBackup files from the alternate disk. Or, unhook that disk, if it is a spare.
11. Make the recovered disk the boot disk again.

Media Server Disk Recovery for UNIX

Note A separate computer that functions as a NetBackup media server is available only on NetBackup Enterprise Server. For NetBackup Server installations, the master server and the media server are installed on the same system and have the same host name. Therefore, recovering the master server disk also recovers the media server.

The procedure for recovering a media server on which the system disk has failed is the same as for a master server, except that you use the following paths when running `bprecover`:

```
media_server_name:/usr/opensv/netbackup/db/media
```

```
media_server_name:/usr/opensv/volmgr/database
```

```
media_server_name:/usr/opensv/var
```

In the above paths, substitute the host name of the media server for `media_server_name` (for example, `elk`).

You can execute `bprecover` from either the master or media server by specifying the correct destination host with the `bprecover -dhost` option.

Client System Disk Recovery for UNIX

The procedure for recovering the system disk on a client workstation is as follows:

▼ To recover the client's system disk

1. Reload the operating system the way you normally would for a client workstation of that type.

Note If the root file system is lost, the best approach may be to reload the operating system on an alternate boot disk and boot from this disk. After you restore NetBackup, you can restore root to its original partition. This lets you recover the root partition without risking a crash due to overwriting files being used by the operating system during the restore. The procedure is similar to that for the master server, except you do not have to install Media Manager or recover the NetBackup catalogs. (See [“Recovering Master Server When Root is Lost”](#) on page 520).

2. Reinstall NetBackup client software.
3. Use the client-user interface to select and restore files.

Client System Disk Recovery for Windows Clients

Refer to the Windows section, [“Client System Disk Recovery for Windows”](#) on page 542.



Recovering the NetBackup Catalogs for UNIX

The NetBackup catalogs contain critical information and must be recovered before any other backups.

Master servers have the following NetBackup catalog files:

```
/usr/opensv/netbackup/db
/usr/opensv/volmgr/database
/usr/opensv/var
```

Media servers have the following NetBackup catalog files:

- ◆ UNIX NetBackup media server:

```
/usr/opensv/netbackup/db/media
/usr/opensv/volmgr/database
/usr/opensv/volmgr/var
```

- ◆ Windows NetBackup media server:

```
install_path\netbackup\db\media
install_path\netbackup\var
install_path\volmgr\database
```

For *install_path*, substitute the directory where NetBackup and Media Manager are installed (C:\Program Files\VERITAS by default).

Because of their importance, the catalogs are backed up separately from other files as described in the *NetBackup System Administrator's Guide, Volume I*. To recover the catalogs, use the `bprecover` command:

```
/usr/opensv/netbackup/bin/admincmd/bprecover
```

The topics in this section explain how to use `bprecover` to recover NetBackup catalog backups. Also, see the description of the `bprecover` command in the *NetBackup Commands for UNIX* manual.

Note The following discussions assume that NetBackup has been reinstalled, if required. (See "[Master Server Disk Recovery for UNIX](#)" on page 519.)

Identifying the Most Recent Catalog Backup

Caution Before you can recover the NetBackup catalogs, you must know which media ID has their latest backups. Without this media ID, you cannot accurately recover your catalogs and your only option is to use the NetBackup import feature to import all lost backup records into your NetBackup catalogs (see the *NetBackup System Administrator's Guide, Volume I*).

As mentioned in the *NetBackup System Administrator's Guide, Volume I*, the best way to track media IDs for catalog backups is to configure email notifications with the **E-mail Address** global attribute. This attribute causes NetBackup to specify the status and media ID in an email to the administrator each time a catalog backup occurs. You can then check the email to determine the last media ID used.

If you know the media IDs that were used but are not sure which of them has the most recent backup, use the `-l` option of `bprecover` to list the backups on each media ID. This information includes the date and time that the media was written.

Example 1: List by Using a Raw Device

Assume the catalog backup was to tape but the Media Manager part of the catalogs was lost so Media Manager cannot control the drive.

Note If the `/dev` file for the device you will use for listing the catalog information is lost in the failure, you must create the special device file path for that device before using `bprecover`. See the *Media Manager Device Configuration Guide* for information on creating this path.

In this case, insert the media in an appropriate drive (assume the raw-device path is `/dev/rmt/hc2d4`). Then, execute the following command on the NetBackup server that has the drive.

```
bprecover -l -tpath /dev/rmt/hc2d4
Database Backup Information from /dev/rmt/hc2d4
Created:      03/30/93 11:31:34
Server:      bphost
Block size:  32768
             Path
             ----
IMAGE1 /usr/opensv/netbackup/db
IMAGE2 /usr/opensv/volmgr/database
IMAGE3 /usr/opensv/var
```



Example 2: List by Using a Media Manager Controlled Drive

Assume the Media Manager part of the catalogs is intact and the backup was done to an 8 mm tape with media ID JBL29. Insert the tape into an appropriate drive. Then, execute the following `bprecover` command on the NetBackup server that has the drive (the Media Manager device daemon, `ltid`, must be active).

```
bprecover -l -ev JBL29 -d 8mm
Database Backup Information from JBL29
Created:      04/02/93 05:50:51
Server:      bphost
Block size:  32768
             Path
             ----
IMAGE1 /usr/opensv/netbackup/db
IMAGE2 /usr/opensv/volmgr/database
IMAGE3 /usr/opensv/var
```

Example 3: List Disk Path

Assume the catalog backup was done to disk path `/disk1/bpbackup` and this disk has not failed. Assuming NetBackup is installed and operating, execute the following `bprecover` command to list the backup information.

```
bprecover -l -dpath /disk1/bpbackup
Database Backup Information from /disk1/bpbackup
Created:      03/30/93 11:31:34
Server:      bphost
             Path
             ----
IMAGE1 /usr/opensv/netbackup/db
IMAGE2 /usr/opensv/netbackup/var
IMAGE3 /usr/opensv/volmgr/database
```

Example 4: Media Server

Assume the master server is a UNIX system with no tape drives and the media server is a supported Windows system with a 4 mm tape drive. The catalog backup was written to the 4 mm tape drive on the Windows media server.

Here, we mount the media in the appropriate drive (assume the raw device path is `\\.\Tape0`) and execute the following `bprecover` command on the media server.

```
bprecover -l -tpath \\.\Tape0
Database Backup Information from \\.\Tape0

Created:      03/31/97 11:31:34
```

```
Server:      nbmedia
Block Size:  32768
```

```
      Path
      ----
IMAGE1 nbmaster:/usr/opensv/netbackup/db
IMAGE2 nbmaster:/usr/opensv/volmgr/database
IMAGE3 nbmaster:/usr/opensv/var
IMAGE4 nbmedia:C:\VERITAS\NetBackup\db\media
IMAGE5 nbmedia:C:\VERITAS\NetBackup\var
IMAGE6 nbmedia:C:\VERITAS\Volmgr\database
```

Procedures for Recovering NetBackup Catalogs

This section explains how to recover the NetBackup catalogs when all or part of them are lost. You perform this recovery with the `bprecover` command.

The method required to recover the catalogs depends on:

- ◆ The type of media that contains the backup of the NetBackup catalogs (tape, optical, or magnetic disk).

and

- ◆ Whether the Media Manager part of those catalogs is still intact. The Media Manager catalog files are normally in the `/usr/opensv/volmgr/database` directory.

Note The Media Manager device catalogs are binary files and you cannot restore them to a different type of platform.

Before Starting

- ◆ Reinstall the NetBackup software (if necessary) as explained in “[Master Server Disk Recovery for UNIX](#)” on page 519 or “[Media Server Disk Recovery for Windows](#)” on page 541.
- ◆ If you had created symbolic links to the catalog locations, be sure to manually recreate those links before starting the recovery.
- ◆ Find the tape that has the latest catalog backups.
- ◆ Ensure that the disk where you are restoring the catalogs contains the directory where the catalogs resided.

This is required because the `bprecover` command always restores the NetBackup catalogs to the path from which they were backed up (alternate-path restores are not allowed).



Recover Catalog From Tape or Optical - Media Manager Catalog Lost

If the latest NetBackup catalog backup is on tape or optical disk and the Media Manager catalog files are lost, specify a raw-device path on the `bprecover` command. This method involves mounting the backup media in a drive and using the `-tpath` or `-opath` parameter.

Note If the `/dev` file was lost for the device you are using to recover the catalogs, create the special device file path for that device before using `bprecover`. See the *Media Manager Device Configuration Guide* for information on creating this path.

▼ To recover the NetBackup catalog when the Media Manager catalog is lost

1. Insert the catalog backup media into an appropriate drive.

The example below shows a nonrobotic tape drive connected to a NetBackup master server.

Recover Catalogs to Same Disk for UNIX

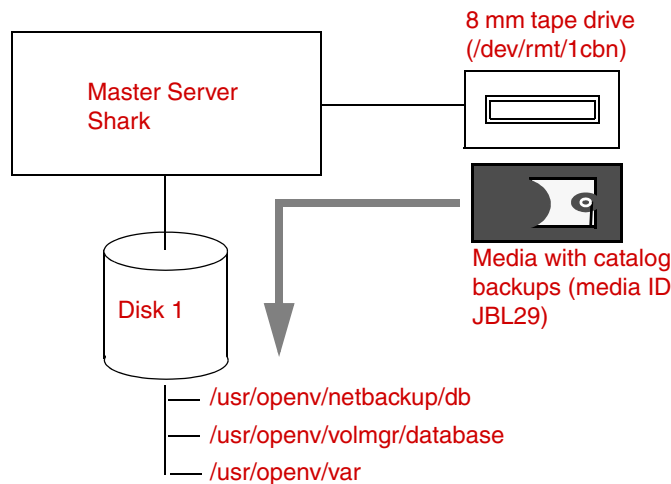

2. Stop the NetBackup request daemon (`bprd`) and NetBackup database manager daemon (`bpdbm`).
 - ◆ Stop `bprd` by using the Terminate Request Daemon command on the `bpadm` **Special Actions** menu.
 - ◆ Stop `bpdbm` by executing:

```
/usr/opensv/netbackup/bin/bpdbm -terminate
```

3. Stop the Media Manager device daemon (`ltid`) and Media Manager volume daemon (`vmd`).
 - ◆ Stop `ltid` with the following command:

```
/usr/opensv/volmgr/bin/stopltd
```
 - ◆ Stop `vmd` by executing `/usr/opensv/volmgr/bin/vmctrldbm -t`
4. On the NetBackup server where the drive attaches, execute the `bprecover` command to recover the required files and directories. Specify the raw-device path for the drive where you inserted the media in step 1.

Example 1

The following command interactively restores images to disk 1 by using raw device path `/dev/rmt/1cbn`:

```
bprecover -r -tpath /dev/rmt/1cbn
Recover shark:/usr/opensv/netbackup/db y/n (n)? y
Recovering shark:/usr/opensv/netbackup/db
Recover shark:/usr/opensv/volmgr/database y/n (n)? y
Recovering shark:/usr/opensv/volmgr/database
Recover shark:/usr/opensv/var y/n (n)? y
Recovering shark:/usr/opensv/var
```

Example 2

If the catalogs were backed up from another disk, `bprecover` restores them to that disk:

```
bprecover -r -tpath /dev/rmt/1cbn
Recover shark:/sfs2/netbackup/db y/n (n)? y
Recovering shark:/sfs2/netbackup/db
Recover shark:/sfs2/volmgr/database y/n (n)? y
Recovering shark:/sfs2/volmgr/database
Recover shark:/sfs2/var y/n (n)? y
Recovering shark:/sfs2/var
```

The figure below shows links from the NetBackup catalog directories on disk 1 to the actual catalog location on disk 2. You must manually recreate these links if they are lost.

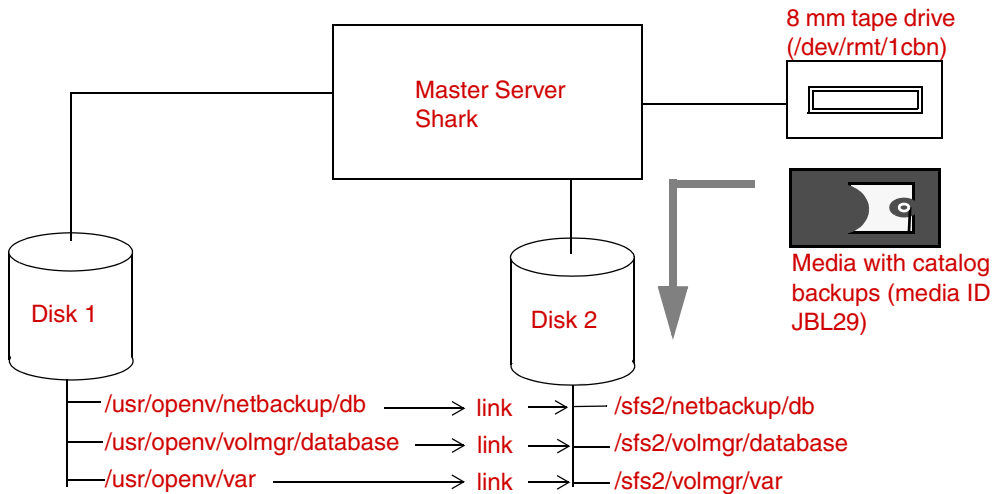

Recover Catalogs to Another Disk

**Example 3**

If you have media servers, `bprecover` includes their catalog paths in the prompts and you select the catalogs you want to recover.

The following example recovers only the catalogs for a UNIX media server named `eel`. Here, you execute `bprecover` on the UNIX master server `shark` and use the `-dhost` option to specify `eel` as the destination host:

```
bprecover -r -tpath /dev/rmt/1cbn -dhost eel
Recover shark:/usr/opensv/netbackup/db y/n (n)? n
Recover shark:/usr/opensv/volmgr/database y/n (n)? n
Recover eel:/usr/opensv/netbackup/db/media y/n (n)? y
Recovering eel:/usr/opensv/netbackup/db/media
Recover eel:/usr/opensv/volmgr/database y/n (n)? y
Recovering eel:/usr/opensv/volmgr/database
Recover eel:/usr/opensv/var y/n (n)? y
Recovering eel:/usr/opensv/var
```

You can also use the `-dhost` option to restore from a media server to the master (for example, if the master does not have a drive).

Recover Media Server Catalogs

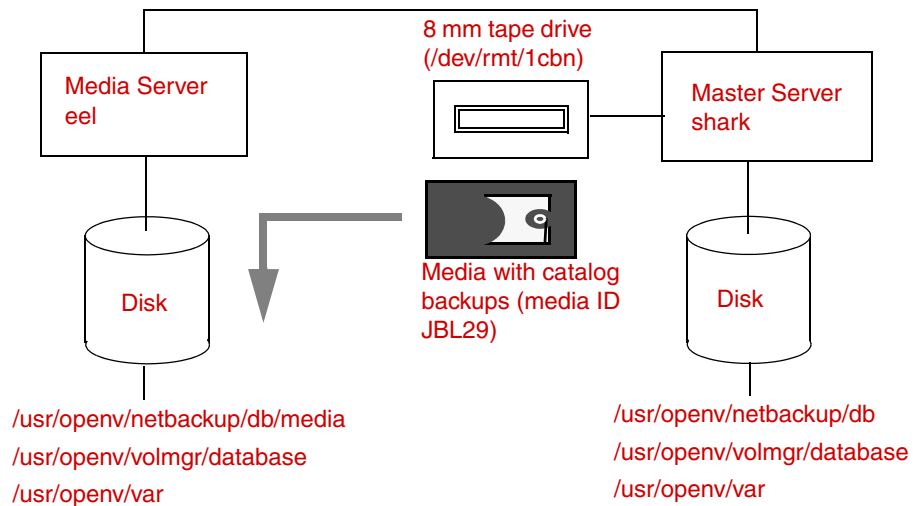

5. After recovering catalogs for the master and all media servers, start the following:

- ◆ `bprd` (NetBackup request daemon)
- ◆ `bpdbm` (NetBackup database manager daemon)
- ◆ `ltid` (Media Manager device daemon)
- ◆ `vmd` (Media Manager volume daemon)

Use the following commands:

```
/usr/opensv/netbackup/bin/initbprd
/usr/opensv/volmgr/bin/ltid
```

(Note that `initbprd` starts `bpdbm` and `ltid` starts `vmd`.)

Recover Catalog from Tape or Optical: Media Manager Catalog Intact

If the NetBackup catalog backup is on tape or optical disk and the Media Manager catalog files are intact, you can recover the catalogs by using a drive configured under Media Manager control as follows:



▼ To recover the NetBackup catalog with the Media Manager catalog intact

1. Stop the NetBackup request daemon (`bprcd`) and NetBackup database manager daemon (`bpdbm`):
 - ◆ Stop `bprcd` by using the Terminate Request Daemon command on the `bpadm` **Special Actions** menu.
 - ◆ Stop `bpdbm` by executing:

```
/usr/opensv/netbackup/bin/bpdbm -terminate
```

2. Insert the tape with the catalog backup into an appropriate drive.

If the tape is not in the drive, the Device Monitor shows a mount request when you start the recovery.

3. On the NetBackup server where the drive attaches, execute the `bprecover` command.

Example 1

Assume the drive is attached to the NetBackup server you are recovering and the backup is on an 8 mm tape that has media ID JBL29. To recover the NetBackup part of the catalogs from image 1 on the tape:

```
bprecover -r 1 -ev JBL29 -d 8mm  
Recovering shark:/usr/opensv/netbackup/db
```

Example 2

If the drive attaches to another NetBackup server, execute `bprecover` on the server where the drive attaches and specify the destination server with the `-dhost` option.

```
bprecover -r 1 -ev JBL29 -d 8mm -dhost shark  
Recovering shark:/usr/opensv/netbackup/db
```

4. Start the NetBackup request daemon (`bprcd`) and NetBackup database manager daemon (`bpdbm`) by executing.

```
/usr/opensv/netbackup/bin/initbprcd
```

(Note that `bprcd` starts `bpdbm`)

5. Stop and restart both the device and volume daemons so they can read the recovered configuration.

- a. Stop `ltid` with the following command:

```
/usr/opensv/volmgr/bin/stopltid
```

b. Stop `vmd` by executing `/usr/opensv/volmgr/bin/vmctrldbm -t`

c. Restart `ltid` by executing:

```
/usr/opensv/volmgr/bin/ltid
```

This automatically starts `vmd`.

Restore Catalog From Disk

If you backed up the NetBackup catalogs to a disk that is intact, you can recover the catalogs as explained in the following procedure.

Note If this disk has failed, you must resort to backups of this disk that have gone to another server. If you have not backed up the NetBackup catalogs to another server, you must use the NetBackup Import Images feature to import the image information into the catalogs. See the *NetBackup System Administrator's Guide, Volume I* for instructions.

▼ To restore the NetBackup catalog from disk

1. Stop the NetBackup request daemon (`bprd`) and NetBackup database manager daemon (`bpdbm`):

- ◆ Stop `bprd` by using the Terminate Request Daemon command on the `bpadm` **Special Actions** menu.

- ◆ Stop `bpdbm` by executing:

```
/usr/opensv/netbackup/bin/bpdbm -terminate
```

2. Stop the Media Manager device daemon (`ltid`) and Media Manager volume daemon (`vmd`).

- ◆ Stop `ltid` by executing:

```
/usr/opensv/volmgr/bin/stopltd
```

d. Stop `vmd` by executing `/usr/opensv/volmgr/bin/vmctrldbm -t`

3. Execute the `bprecover` command to recover the catalogs.

The following commands recover the `/usr/opensv/netbackup/db` catalogs from disk path `/nb/dbbackup`.

```
bprecover -r 1 -dpath /nb/dbbackup
Recovering shark:/usr/opensv/netbackup/db
```



Restore Catalogs From Disk

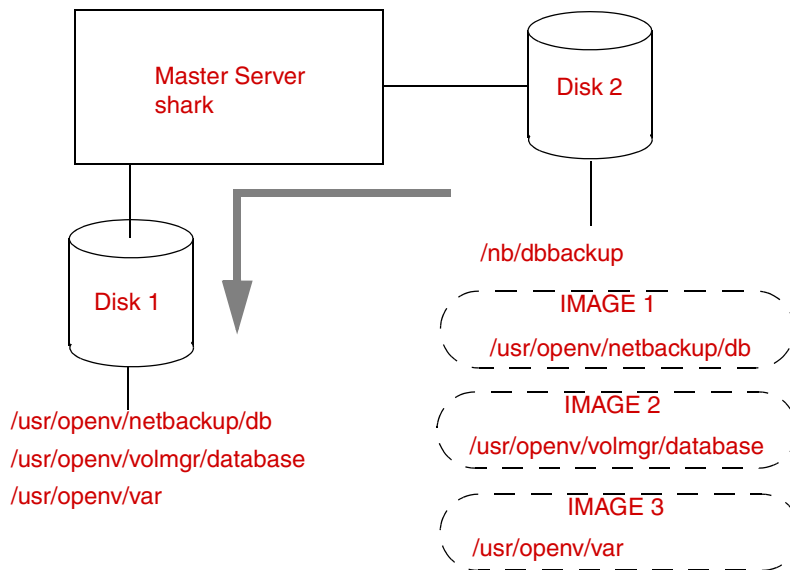

4. After recovering the catalogs, start the following:

- ◆ `bprd` (NetBackup request daemon)
- ◆ `bpdbm` (NetBackup database manager daemon)
- ◆ `ltid` (Media Manager device daemon)
- ◆ `vmd` (Media Manager volume daemon)

Use the following commands:

```
/usr/openssl/netbackup/bin/initbprd  
/usr/openssl/volmgr/bin/ltid
```

(Note that `initbprd` starts `bpdbm` and `ltid` starts `vmd`.)

Master Server Disk Recovery for Windows

The procedures in this section explain how to recover your data if one or more disk partitions are lost on a NetBackup master server. Two general cases are considered:

- ◆ Windows is intact. The system still boots Windows, but all or some of the other partitions are lost. NetBackup is also assumed to be lost.
- ◆ All disk partitions are lost. This is a total recovery.

In both cases, you restore the server to the state it was in at the time of the most recent backup of the NetBackup catalogs. Reconfiguration is unnecessary.

Recovery When Windows is Intact

This procedure assumes that Windows will boot and is not corrupt. The figure below illustrates the procedure to restore NetBackup, then all other files.

Recover Master Server - Windows Intact (overview)

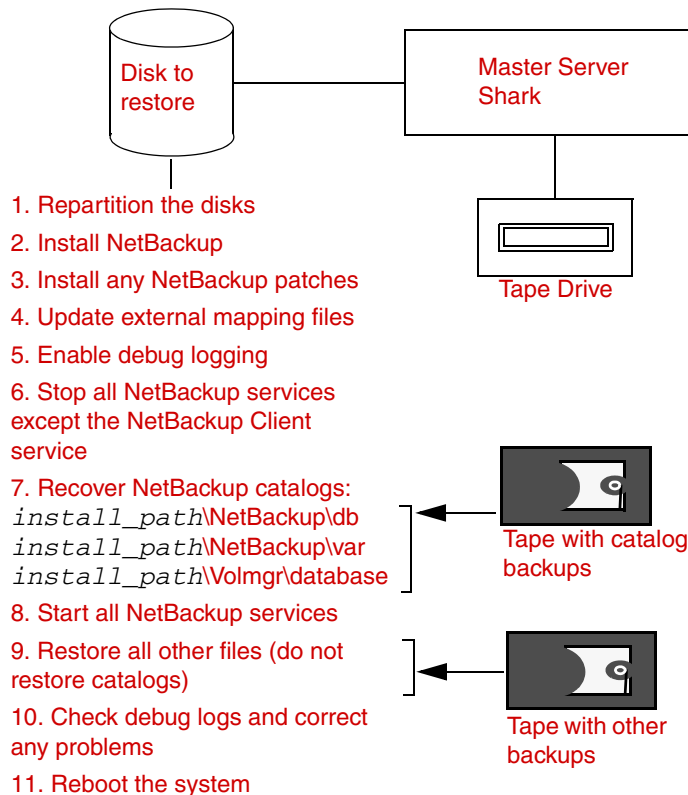

Before Starting

Verify that you have:

- ◆ NetBackup server software for Windows
- ◆ The latest NetBackup catalog backup on tape or disk

Determine the *install_path* in which NetBackup is installed. By default, NetBackup is installed in `C:\Program Files\VERITAS`.

Recovering the Master Server (Windows intact)

▼ To recover the Master server with the operating system intact

1. Partition the disks as they were before the failure.
2. Install NetBackup server software. However, do not configure any NetBackup policies or devices.
3. Install any NetBackup patches that had previously been installed.
4. Update the external mapping files.
5. Enable debug logging by creating the following directories:
`install_path\NetBackup\logs\tar`
`install_path\NetBackup\logs\bpineted`
6. Start the NetBackup Client service and stop all other NetBackup services.
Use the NetBackup Activity Monitor, or the Services application in the Windows Control Panel.
7. Use the `bprecover` command to recover the NetBackup catalogs:
Choose one of the procedures under [“Recovering the NetBackup Catalogs for Windows”](#) on page 544.
8. When catalog recovery is complete, start the NetBackup services that are not already running.
Use the Activity Monitor, or the Services application in the Windows Control Panel.

Caution In [step 9](#), do not restore files to the *install_path\NetBackup\db*, *install_path\NetBackup\var*, or *install_path\Volmgr\database* directories. These directories were recovered in [step 7](#) and overwriting them with regular backups will leave the catalogs in an inconsistent state.

9. Restore all other files:
 - a. Start the NetBackup Administration interface on the master server.
 - b. Start the Backup, Archive, and Restore utility.
 - c. Browse for restores and select the partitions that were lost.
 - d. Deselect the *install_path\NetBackup\db*, *install_path\NetBackup\var*, and *install_path\Volmgr\database* directories (see the caution above).
 - e. Start the restore.
10. When all partitions are restored, check the debug logs in the directories created in [step 5](#). If there are any ERR or WRN messages, resolve the problems before proceeding.
11. Reboot the system.

This replaces any files that were busy during the restore. When the boot process is complete, the system is restored to the state it was in at the time of the last backup.



Total Recovery

The following procedure explains how to perform a total recovery of a NetBackup master server and assumes that Windows must be reinstalled. The figure illustrates the procedure.

Master Server Total Recovery (overview)

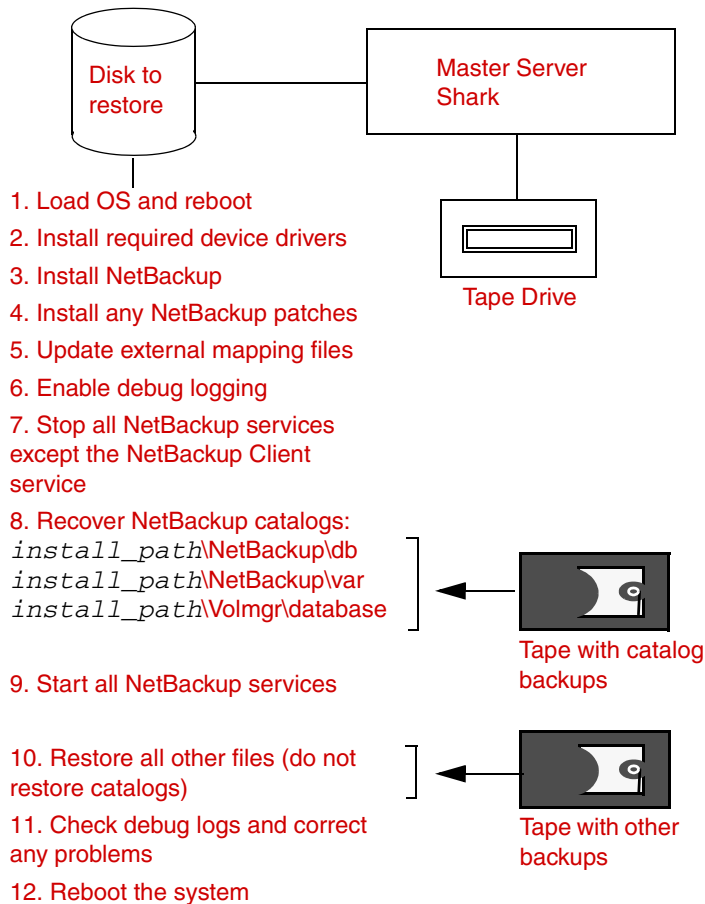

Assumptions

- ◆ The NetBackup master server was running a supported Microsoft Windows operating system.
- ◆ The latest NetBackup catalog backup is available on tape or disk.

- ◆ The regular backups included the system directory (typically, C:\Winnt). This is the directory where the Windows operating system and therefore the registry reside.
If the regular backups excluded any files that resided in the system directory, it is possible that you will not be able to restore the system so it completely matches its previous configuration.
- ◆ Defective hardware has been replaced.

Before Starting

Verify that you have:

- ◆ Windows software to reinstall on the NetBackup server that is being restored.
Reinstall the same type and version of software that was used previously. For example, do not install Windows NT Server 4.0 software if, before the failure, the system was a Windows NT 4.0 workstation.
- ◆ NetBackup server software for Windows.
- ◆ Special drivers or other software required to get the hardware operational (for example, a special driver for the disk drive).
- ◆ IP address and host name of the NetBackup master server.
- ◆ Partitioning and formatting scheme that was used on the system you are restoring. You must duplicate that scheme during Windows installation.
- ◆ Latest NetBackup catalog backup on tape or disk.

Recovering the Master Server (Total Recovery)

▼ To recover the master server including the operating system

1. Install a minimal Windows operating system (perform the Express install).

Be certain to:

- ◆ Partition the disk as it was before the failure (if partitioning is necessary). Then, reformat each partition as it was before the failure.
- ◆ Install Windows in the same partition that was used before the failure.
- ◆ Specify the default workgroup. Do not restore to the domain.
- ◆ Follow any hardware manufacturers instructions that apply, such as loading SSD on a Compaq system.
- ◆ Reboot the system when the install is complete.



2. Install SCSI or other drivers needed to communicate with the tape drives on the system.
3. Install NetBackup server software. However, do not configure any NetBackup policies or devices.
4. Install any NetBackup patches that had previously been installed.
5. Update the external mapping files.
6. Enable debug logging by creating the following directories:

```
install_path\NetBackup\logs\tar
```

```
install_path\NetBackup\logs\bpinetc
```
7. Start the NetBackup Client service and stop all other NetBackup services.
Use the NetBackup Activity Monitor or the Services application in the Windows Control Panel.
8. Use the `bprecover` command to recover the NetBackup catalogs.
Choose one of the procedures under [“Recovering the NetBackup Catalogs for Windows”](#) on page 544.
9. When catalog recovery is complete, start the NetBackup services that are not already running.
Use the Activity Monitor, or the Services application in the Windows Control Panel.

Caution In [step 10](#), do not restore files to the `install_path\NetBackup\db`, `install_path\NetBackup\var`, or `install_path\Volmgr\database` directories. These directories were recovered in [step 8](#) and overwriting them with regular backups will leave the catalogs in an inconsistent state.

10. Restore all other files:
 - a. Start the NetBackup Administration interface on the master server.
 - b. Start the Backup, Archive, and Restore utility.
 - c. Browse for restores and select all partitions.
It is especially important to select the system directory (typically `C:\Winnt`). This ensures that all registry files are restored.

- d. Deselect the *install_path\NetBackup\db*, *install_path\NetBackup\var*, or *install_path\Volmgr\database* directories (see the caution above).
 - e. Select the **Overwrite existing files** option.
This ensures that existing files are replaced with the backups.
 - f. Start the restore.
11. Check the debug logs in the directories created in [step 6](#). If there are any ERR or WRN messages, resolve the problems before proceeding.
 12. Reboot the system.
This replaces any files that were busy during the restore. When the boot process is complete, the system is restored to the state it was in at the time of the last backup.

Media Server Disk Recovery for Windows

Note A separate computer that functions as a NetBackup media server is available only on NetBackup Enterprise Server. For NetBackup Server installations, the master server and the media server are installed on the same system and have the same host name. Therefore, recovering the master server disk also recovers the media server.

The procedure for recovering a media server where the system disk has failed is the same as for a master server, except that you use the following paths when running `bprecover`:

If the media server is a Windows system:

```
media_server_name:install_path\NetBackup\db\media
```

```
media_server_name:install_path\NetBackup\var
```

```
media_server_name:install_path\Volmgr\database
```

In the above paths, substitute the host name of the media server for *media_server_name* (for example, elk). For *install_path*, substitute the directory in which NetBackup is installed.

You can execute `bprecover` from either the master or media server by specifying the correct destination host with the `bprecover -dhost` option.



Client System Disk Recovery for Windows

The following procedure explains how to perform a total recovery of a Windows NetBackup client in the event of a system disk failure.

Note If you installed and configured NetBackup Intelligent Disaster Recovery on the client system, refer to the *NetBackup System Administrator's Guide, Volume II* for recovery procedures instead of the instructions below.

This procedure assumes that the Windows operating system and NetBackup must be reinstalled in order to boot the system and perform a restore.

Assumptions

- ◆ The NetBackup client was running a supported Microsoft Windows version.
- ◆ The NetBackup client was backed up with version 34 or later NetBackup client and server software.
- ◆ The NetBackup master server to which the client sent its backups is operational. This is the server from which you will be requesting the restore.
- ◆ The backups included the directory where the operating system and therefore the registry resided (for example, typically C:\winnt40 on Windows NT).

If the backups excluded any files that resided in the above directory, you may not be able to restore the system so it exactly matches its previous configuration.

- ◆ Defective hardware has been replaced.

Before Starting

Verify that you have the following:

- ◆ Windows system software to reinstall on the NetBackup client that is being restored. Reinstall the same type and version of software that was previously used. For example, do not install Windows NT Server 4.0 software if, before the failure, the system was a Windows NT 4.0 workstation.
- ◆ NetBackup client software to install on the client that is being restored.
- ◆ Special drivers or other software required to get the hardware operational (for example, a special driver for the disk drive).
- ◆ IP address and host name of the NetBackup client.
- ◆ IP address and host name of the NetBackup master server.

- ◆ Partitioning and formatting scheme that was used on the system that you are restoring. You must duplicate that scheme during Windows installation.

Recovering a Windows Client Disk

▼ To recover a Windows client disk

1. Install a minimal Windows operating system (perform the Express install).

During the installation, be certain to:

- ◆ Partition the disk as it was before the failure (if partitioning is necessary). Then, reformat each partition as it was before the failure.
- ◆ Install the operating system in the same partition that was used before the failure.
- ◆ Specify the default workgroup. Do not restore to the domain.
- ◆ Follow any hardware manufacturers instructions that apply, such as loading SSD on a Compaq system.

2. Reboot the system when the installation is complete.

3. Configure the NetBackup client system to re-establish network connectivity to the NetBackup master server.

For example, if your network uses DNS, the configuration on the client must use the same IP address as before the failure and must specify the same name server (or another name server that recognizes both the NetBackup client and master server). On the client, configure DNS in the Network dialog box that you access from the Control Panel.

4. Install NetBackup client software.

Refer to the *NetBackup Installation Guide for Windows* for instructions. Ensure that you specify the correct names for the client and master server. To specify the client name, start the user interface on the client and click **Configure** on the **Actions** menu. Enter the client name on the **General** tab of the NetBackup Client Properties dialog. To specify the server name, click **Specify NetBackup Machines** on the **Actions** menu and make the entry on the **Servers** tab.

5. Install any NetBackup patches that had previously been installed.

6. Enable debug logging by creating the following debug log directories on the client:

```
install_path\NetBackup\Logs\tar
```

```
install_path\NetBackup\Logs\bpinstd
```



NetBackup creates logs in these directories.

7. Stop and restart the NetBackup Client service.

This enables NetBackup to start logging to the `bpineted` debug log.

8. Use the NetBackup client user interface to restore the system and user files to the client system.

For example, if all files are on the C: drive, restoring that drive restores the entire system.

To restore files, you do not have to be the administrator, but you must have restore privileges. Refer to the online help or *NetBackup User's Guide for Microsoft Windows* for instructions on how to restore files.

Note NetBackup restores the registry when it restores the Windows system files. For example, if the system files are in the `C:\Winnt40` directory, NetBackup restores the registry when it restores that directory and all its subordinate subdirectories and files.

9. Check for ERR or WRN messages in the log files that are in the directories you created in [step 6](#).

If the logs indicate problems with the restore of Windows system files, resolve those problems before proceeding.

10. Reboot the NetBackup client system.

When the boot process is complete, the system is restored to the state it was in at the time of the last backup.

Recovering the NetBackup Catalogs for Windows

The NetBackup catalogs contain critical information and must be recovered before any other backups.

Master servers have the following NetBackup catalog files:

```
install_path\NetBackup\db
install_path\NetBackup\var
install_path\Volmgr\database
```

Media servers have the following NetBackup catalog files:

- ◆ Windows NetBackup media server:

```
install_path\netbackup\db\media
```

```
install_path\netbackup\var
```

```
install_path\volmgr\database
```

For *install_path*, substitute the directory where NetBackup and Media Manager are installed (C:\Program Files\VERITAS by default).

Because of their importance, the catalogs are backed up separately from other files as described in the *NetBackup System Administrator's Guide, Volume I*. To recover the catalogs, use the `bprecover` command:

```
install_path\NetBackup\bin\admincmd\bprecover
```

The topics in this section explain how to use `bprecover` to recover NetBackup catalog backups. Also, see the description of `bprecover` in the *NetBackup Commands for Windows* manual.

Note The following discussions assume that NetBackup has been reinstalled, if required (see [“Master Server Disk Recovery for Windows”](#) on page 535).

Identifying the Most Recent Catalog Backup

Caution Before you can recover the NetBackup catalogs, you must know which media ID has their latest backups. Without this media ID, you cannot accurately recover your catalogs and your only option is to use the NetBackup import feature to import all lost backup records into your NetBackup catalog (see the *NetBackup System Administrator's Guide, Volume I*).

As mentioned in the *NetBackup System Administrator's Guide, Volume I*, the best way to track media IDs for catalog backups is to configure email notifications with the **E-mail Address** global attribute. This attribute causes NetBackup to specify the status and media ID in an email to the administrator each time a catalog backup occurs. You can then check the email to determine the last media ID used.

If you know the media IDs that were used but are not sure which of them has the most recent backup, use the `-l` option of `bprecover` to list the backups on each media ID. This information includes the date and time that the media was written.

Example 1: List by Using a Raw Device

Assume the catalog backup was to tape but the Media Manager part of the catalogs was lost so Media Manager cannot control the drive.



In this case, insert the media in an appropriate drive (assume the raw-device path is `\\.\Tape1`). Then, execute the following `bprecover` command on the NetBackup server that has the drive.

```
bprecover -l -tpath \\.\Tape1
Database Backup Information from \\.\Tape1

Created:      03/31/97 11:31:34
Server:      bphost
Block Size:  32768

          Path
          ----
IMAGE1 D:\apps\VERITAS\NetBackup\db
IMAGE2 D:\apps\VERITAS\Volmgr\database
```

Example 2: List by Using a Media Manager Controlled Drive

Assume the Media Manager part of the catalogs is intact and the backup was to a dlt tape with media ID 000001. Insert the tape into an appropriate drive. Then, execute the following `bprecover` command on the NetBackup server that has the drive (the NetBackup Device Manager Service must be active).

```
bprecover -l -ev 000001 -d dlt
Database Backup Information from 000001

Created:      03/31/97 05:50:51
Server:      bphost
Block size:   32768

          Path
          ----
IMAGE1 D:\apps\VERITAS\Netbackup\db
IMAGE2 D:\apps\VERITAS\Volmgr\database
IMAGE3 D:\apps\VERITAS\NetBackup\var
```

Example 3: List Disk Path

Assume the catalog backup was done to disk path `D:\apps\dbbackup` and this disk has not failed. Execute the following `bprecover` command to list the backup information.

```
bprecover -l -dpath D:\apps\dbbackup
Database Backup Information from D:\apps\dbbackup

Created:      03/31/97 11:31:34
```



```
Server:      bphost
Block size: 32768
```

```
          Path
          ----
IMAGE1 D:\apps\VERITAS\NetBackup\db
IMAGE2 D:\apps\VERITAS\NetBackup\var
IMAGE3 D:\apps\VERITAS\Volmgr\database
```

Procedures for Recovering NetBackup Catalogs

This section explains how to recover the NetBackup catalogs when all or part of them are lost. You perform this recovery with the `bprecover` command.

The method required to recover the catalogs depends on:

- ◆ The type of media that contains the backup of the NetBackup catalogs (tape or magnetic disk).
- and
- ◆ Whether the Media Manager part of those catalogs is still intact. The Media Manager catalog files are normally in the `install_path\Volmgr\database` directory.

Note The Media Manager device catalogs are binary files and you cannot restore them to a different type of platform.

Before Starting

- ◆ Reinstall the NetBackup software (if necessary) as explained in “[Master Server Disk Recovery for UNIX](#)” on page 519 or “[Media Server Disk Recovery for Windows](#)” on page 541.
- ◆ Find the tape that has the latest catalog backups.
- ◆ Ensure that the disk where you are restoring the catalogs contains the directory where the catalogs resided.

This is required because the `bprecover` command always restores the NetBackup catalogs to the path from which they were backed up (alternate-path restores are not allowed).



Recovering Catalogs From Tape when Media Manager Catalogs Lost

If the NetBackup catalog backup is on tape and the Media Manager catalogs are lost, specify a raw-device path on the `bprecover` command. This method involves mounting the backup tape in a drive and using the `-tpath` parameter.

Note If the configuration was lost for the device that you plan to use for the recovery, reinstall the device as explained in the Windows system documentation.

▼ To recover the NetBackup catalog from tape when Media Manager catalogs lost

1. Insert the catalog backup tape into an appropriate drive.

The example below shows a nonrobotic tape drive connected to a NetBackup master server.

Recover Catalogs From Tape

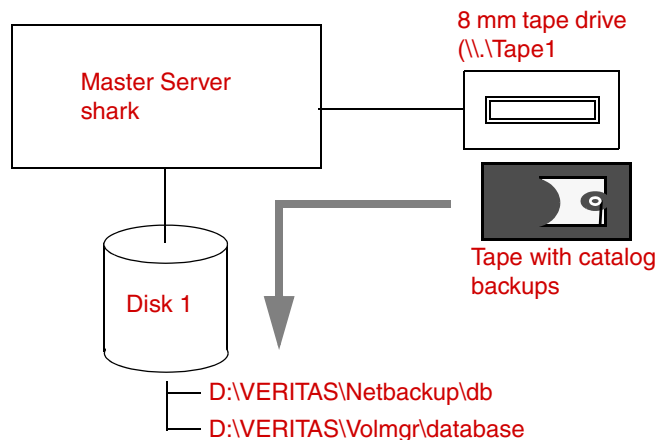

2. Use the NetBackup Activity Monitor or the Services application in the Windows Control Panel to stop the following services, if they are running.
 - ◆ NetBackup Request Manager service
 - ◆ NetBackup Database Manager service
 - ◆ NetBackup Device Manager service
 - ◆ NetBackup Volume Manager service
3. Use the Activity Monitor or the Services application in the Windows Control Panel to verify that the NetBackup Client service is running. Start it if necessary.

4. On the NetBackup server where the drive attaches, execute the `bprecover` command. Specify the raw-device path for the drive where you inserted the tape in [step 1](#).

Example 1

This example interactively restores images to disk 1 by using raw-device path `\\.\Tape1`:

```
bprecover -r -tpath \\.\Tape1
Recover shark:D:\VERITAS\NetBackup\db y/n (n)? y
Recover shark:D:\VERITAS\Volmgr\database y/n (n)? y
Recovering shark:D:\VERITAS\NetBackup\db
Recovering shark:D:\VERITAS\Volmgr\database
```

Example 2

If you have media servers, `bprecover` includes their catalog paths in the prompts and you select the catalogs you want to recover.

The following example recovers only the catalogs for a media server named `eel`. Here, you execute `bprecover` on the master server `shark` and use the `-dhost` option to specify `eel` as the destination host:

```
bprecover -r -tpath \\.\Tape1 -dhost eel
Recover shark:install_path\NetBackup\db y/n (n)? n
Recover shark:install_path\NetBackup\var y/n (n)? n
Recover shark:install_path\Volmgr\database y/n (n)? n
Recover eel:install_path\NetBackup\db\media y/n (n)? y
Recovering eel:install_path\NetBackup\db\media
Recover eel:install_path\NetBackup\var y/n (n)? y
Recovering eel:install_path\NetBackup\var
Recover eel:install_path\Volmgr\database y/n (n)? y
Recovering eel:install_path\Volmgr\database
```

You can also use the `-dhost` option to restore from a media server to the master (for example, if the master does not have a drive).



Recover Media Server Catalogs

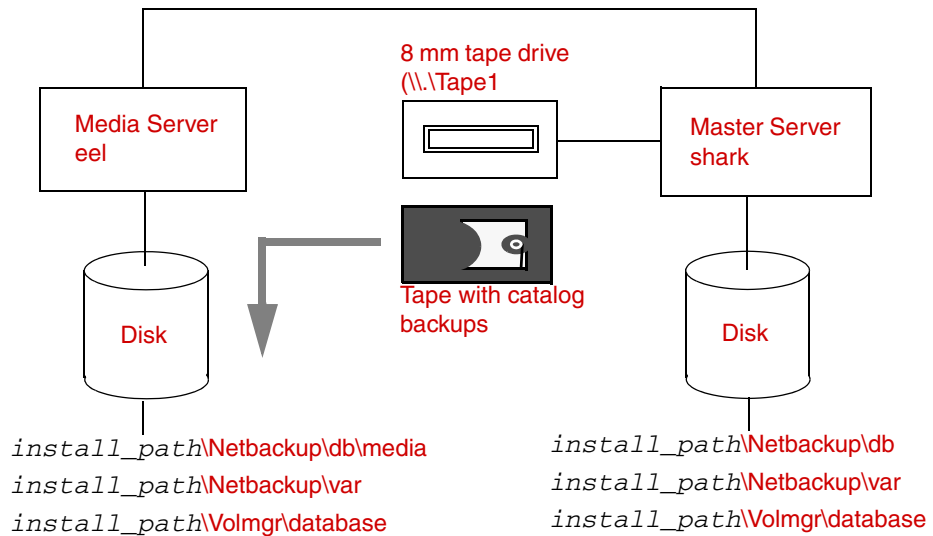

5. After recovering catalogs for the master and all media servers, use the NetBackup Activity Monitor, or the Services application in the Windows Control Panel, to start the following services:
 - ◆ NetBackup Request Manager Service
 - ◆ NetBackup Database Manager Service
 - ◆ NetBackup Device Manager Service
 - ◆ NetBackup Volume Manager service

Recovering Catalogs from Tape with Media Manager Catalogs Intact

When the Media Manager catalogs are intact, you can recover the catalog backups by using a drive configured under Media Manager control as follows:

▼ To recover NetBackup catalog from tape with Media Manager catalog intact

1. Use the NetBackup Activity Monitor or the Services application in the Windows Control Panel to stop the following services if they are running:
 - ◆ NetBackup Request Manager service
 - ◆ NetBackup Database Manager service
2. Insert the tape with the catalog backup into an appropriate drive.

If the tape is not in the drive, the Device Monitor shows a mount request when you start the recovery. If this occurs, insert the tape and use the Device Monitor to assign the drive to the request.

3. On the NetBackup server where the drive attaches, execute the `bprecover` command.

Example 1

Assume you are restoring the catalogs to disk 1 and the 8mm tape has media ID JBL29. To recover the NetBackup part of the catalogs from image 1 on the tape, execute the following command on shark:

```
bprecover -r 1 -ev JBL29 -d 8mm  
Recovering shark:D:\VERITAS\NetBackup\db
```

Example 2

If the drive attaches to another NetBackup server, execute `bprecover` on the server where the drive attaches and specify `shark` with the `-dhost` option.

```
bprecover -r 1 -ev JBL29 -d 8mm -dhost shark  
Recovering shark:D:\VERITAS\NetBackup\db
```

4. Use the NetBackup Activity Monitor or the Services application in the Windows Control Panel, to:
 - a. Start the following services:
 - ◆ NetBackup Request Manager service
 - ◆ NetBackup Database Manager service
 - b. Stop and restart the following services so they can read the recovered configuration:
 - ◆ NetBackup Device Manager service
 - ◆ NetBackup Volume Manager service

Recovering Catalogs From Disk

If you backed up the NetBackup catalogs to a disk and that disk is intact, you can recover the catalogs as follows:



Note If this disk has failed, you must resort to backups of this disk that were backed up to another server. If you have not backed up the NetBackup catalogs to another server, you must use the NetBackup Import Images feature to re-add the image information to the catalogs. See the *NetBackup System Administrator's Guide, Volume I* for instructions.

▼ **To recover the NetBackup catalog from disk**

1. Use the NetBackup Activity Monitor or the Services application in the Windows Control Panel to stop the following services:
 - ◆ NetBackup Request Manager service
 - ◆ NetBackup Database Manager service
 - ◆ NetBackup Device Manager service
 - ◆ NetBackup Volume Manager service

2. Execute the `bprecover` command to recover the catalogs.

For example, the following command recovers the `D:\VERITAS\NetBackup\db` catalogs from disk path `D:\apps\dbbackup`.

```
bprecover -r 1 -dpath D:\apps\dbbackup
Recovering shark:D:\VERITAS\NetBackup\db
```

Recover Catalogs From Disk

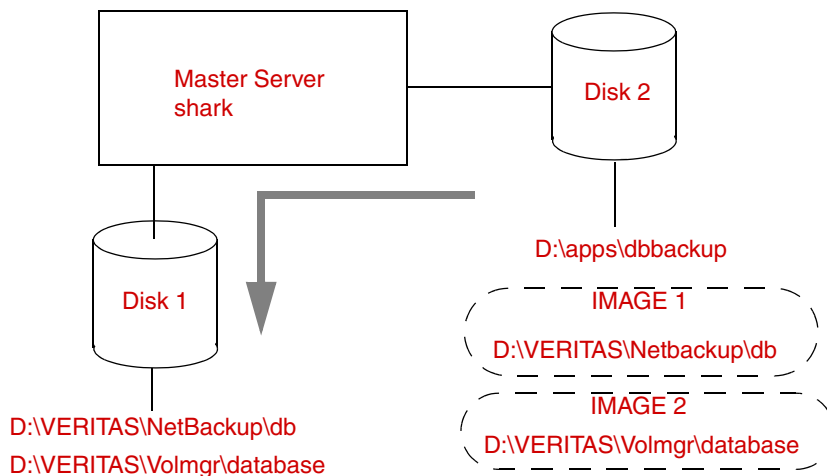

3. After recovering the catalogs, use the NetBackup Activity Monitor or the Services application in the Windows Control Panel to start the following services:
 - ◆ NetBackup Request Manager Service
 - ◆ NetBackup Database Manager Service
 - ◆ NetBackup Device Manager Service
 - ◆ NetBackup Volume Manager service

Recovering Catalogs From an NDMP-Attached Tape Drive

If the latest NetBackup catalog backup is on a tape that is directly attached to a Network Data Management Protocol (NDMP) host and the NetBackup catalog files are lost, you must recover the catalog from the tape drive attached to the NDMP host. This requires using the `set_ndmp_attr` command to give NetBackup access to the NDMP host.

The example in the following figure shows a nonrobotic tape drive connected to an NDMP host.

Recover Catalog from NDMP-Attached Tape

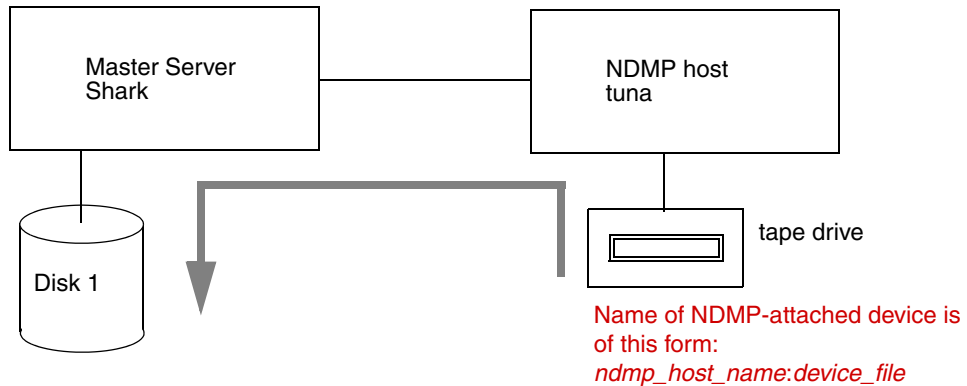

▼ To recover the NetBackup catalog from an NDMP-attached tape drive

1. Use the NetBackup Activity Monitor or the Services application in the Windows Control Panel to stop the following services, if they are running.
 - ◆ NetBackup Request Manager service
 - ◆ NetBackup Database Manager service



- ◆ NetBackup Device Manager service
 - ◆ NetBackup Volume Manager service
2. Use the Activity Monitor or the Services application in the Windows Control Panel to verify that the NetBackup Client service is running. Start it if necessary.
 3. On the master server, reinstall NetBackup software (if not already installed) and NetBackup for NDMP software.
 4. To authorize access to the NDMP host, enter the following command.

```
install_path\Volmgr\bin\set_ndmp_attr -auth ndmp_host username
```

For more information on using the `set_ndmp_attr` command to authorize access to the NDMP host, refer to the *NetBackup for NDMP System Administrator's Guide*.

5. If the robot (in which the tape resides) is controlled by the NDMP host, enter the following:

```
set_ndmp_attr -robot ndmp_host robot_device scsi_controller scsi_id scsi_lun
```

For more information on using the `set_ndmp_attr` command to configure a robot attached to the NDMP host, refer to the *NetBackup for NDMP System Administrator's Guide*.

6. Configure the tape drive as a standalone drive, whether or not it resides in a robot.
7. Use the appropriate `robtest` command (`acstest`, `tldtest`, `tsdtest`, or `tl8test`) to mount the catalog tape into the NDMP-attached drive.
8. Enter the `bprecover` command (in *install_path*\netbackup\bin\admincmd).

```
bprecover -r all -tpath ndmp_host:tape_device_name
```

For examples of tape device names for particular NAS vendors, refer to the VERITAS document on NAS appliance information. For instructions on accessing this document, refer to "NDMP Information on the Web" in the *NetBackup for NDMP System Administrator's Guide*.

9. After recovering catalogs for the master and media servers, use the Activity Monitor or the Services application in the Windows Control Panel, to start these services:
 - ◆ NetBackup Request Manager Service
 - ◆ NetBackup Database Manager Service
 - ◆ NetBackup Device Manager Service
 - ◆ NetBackup Volume Manager service

This appendix provides a functional overview of NetBackup for both UNIX and Windows. The discussions include descriptions of important services or daemons and programs, and the sequence in which they execute during typical operations. The databases and the directory structure of the installed software are also described.

We assume that you are already familiar with the overviews in the first chapter of the *NetBackup System Administrator's Guide* and the *Media Manager System Administrator's Guide*.

There are two main sections in this appendix:

- ◆ [Backup and Restore Functional Description](#)
- ◆ [Media Manager Functional Description](#)

The Media Manager section contains a description of the Shared Storage Option (SSO).

Note that this appendix does not pertain to the NetBackup products for backing up relational databases (such as NetBackup for ORACLE). The installation guides for those products have information regarding their operation.

Backup and Restore Functional Description

This section explains the operation of NetBackup during backup and restores and contains the following discussions:

- ◆ [Startup Process](#)
- ◆ [Backup and Archive Processes](#)
- ◆ [Restore Processes](#)
- ◆ [NetBackup Directories and Files](#)
- ◆ [NetBackup Databases](#)



Startup Process

Before NetBackup can perform scheduled operations or respond to user-directed requests, the NetBackup request daemon `bprd` must be started on the master server, and the Media Manager device daemon `ltid` must be started on the master server and all media servers. These two daemons, in turn, automatically start other daemons and programs as necessary (see the figure “[Starting NetBackup](#)”).

On a media server, it is not necessary to start `bprd` because it is not used. NetBackup automatically starts other required NetBackup programs when it accesses the media server.

Another daemon that executes on all server and clients is the NetBackup client daemon, `bpcd`. On UNIX clients, `inetd` starts `bpcd` automatically so no special actions are required. On Windows NT clients, `bpinetd` performs the same functions as `inetd`. Other PC clients do not use `inetd` or `bpinetd` but are usually configured to start `bpcd` automatically (see their user’s guides for instructions).

There are no other daemons or programs that you must explicitly start. The necessary programs are started automatically during the backup or restore operation.

The figure “[Starting NetBackup](#)” shows the programs that must be running and how they are started. The Media Manager functional description, later in this appendix, has details on the actions started by `ltid`.

Starting NetBackup

Master Server

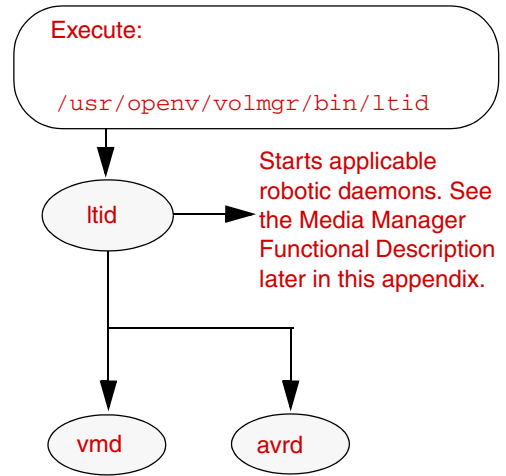
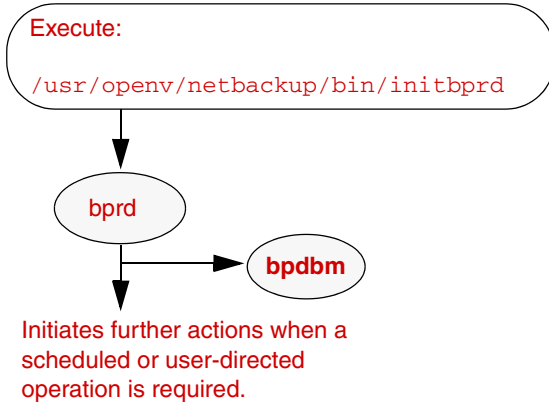

Media Server

The Media Manager device components of NetBackup must be started as shown to the right.

The master server starts other NetBackup programs as necessary to use storage units that attach to the media server.

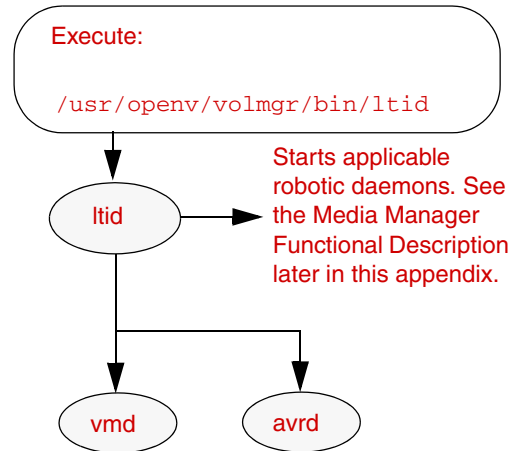

Client

On UNIX clients, bpcd must be in a listening state. On Windows and NetWare clients, bpcd must be running. Except for bpcd, required programs are started as necessary during the backup or restore. Windows clients must only be turned on and ready.



Backup and Archive Processes

The backup and archive processes vary depending on the type of client. The following explains the basic variations, and describes the synthetic backup process. There is also a description of how NetBackup operates when backing up its databases.

Backups and Archives - UNIX Clients

For UNIX clients, NetBackup supports scheduled, immediate manual, and user-directed backups of both files and raw partitions. User-directed archives of files is also supported (you cannot archive raw partitions). Once started, these operations are all similar to the extent that the same daemons and programs execute on the server (see the figure below, "[Backup or Archive to Tape or Optical](#)"). Each type, however, is started differently.

- ◆ Scheduled backup operations begin when the NetBackup request daemon, `bprd`, activates the scheduler, `bpsched`. This occurs at intervals determined by the `WakeUpInterval` global attribute. Once activated, the scheduler checks the policy configurations for scheduled client backups that are due.
- ◆ Immediate manual backups begin if the administrator chooses the manual backup option in the NetBackup administrator interface. This causes `bprd` to start `bpsched`, which then processes the policy, client, and schedule selected by the administrator.
- ◆ User-directed backups or archives begin when a user on a client starts a backup or archive through user interface on the client (or the `bpbackup` or `bparchive` commands). This invokes the client's `bpbackup` or `bparchive` program, which sends a request to the request daemon `bprd` on the master server. When `bprd` receives the user request, it starts `bpsched`, which checks the policy configurations for schedules and by default chooses the first user-directed schedule that it finds in a policy that includes the requesting client. It is also possible to specify a policy and schedule by using the NetBackup configuration options, `BPBACKUP_POLICY` and `BPBACKUP_SCHED`, on the client.

Backup or Archive to Tape or Optical

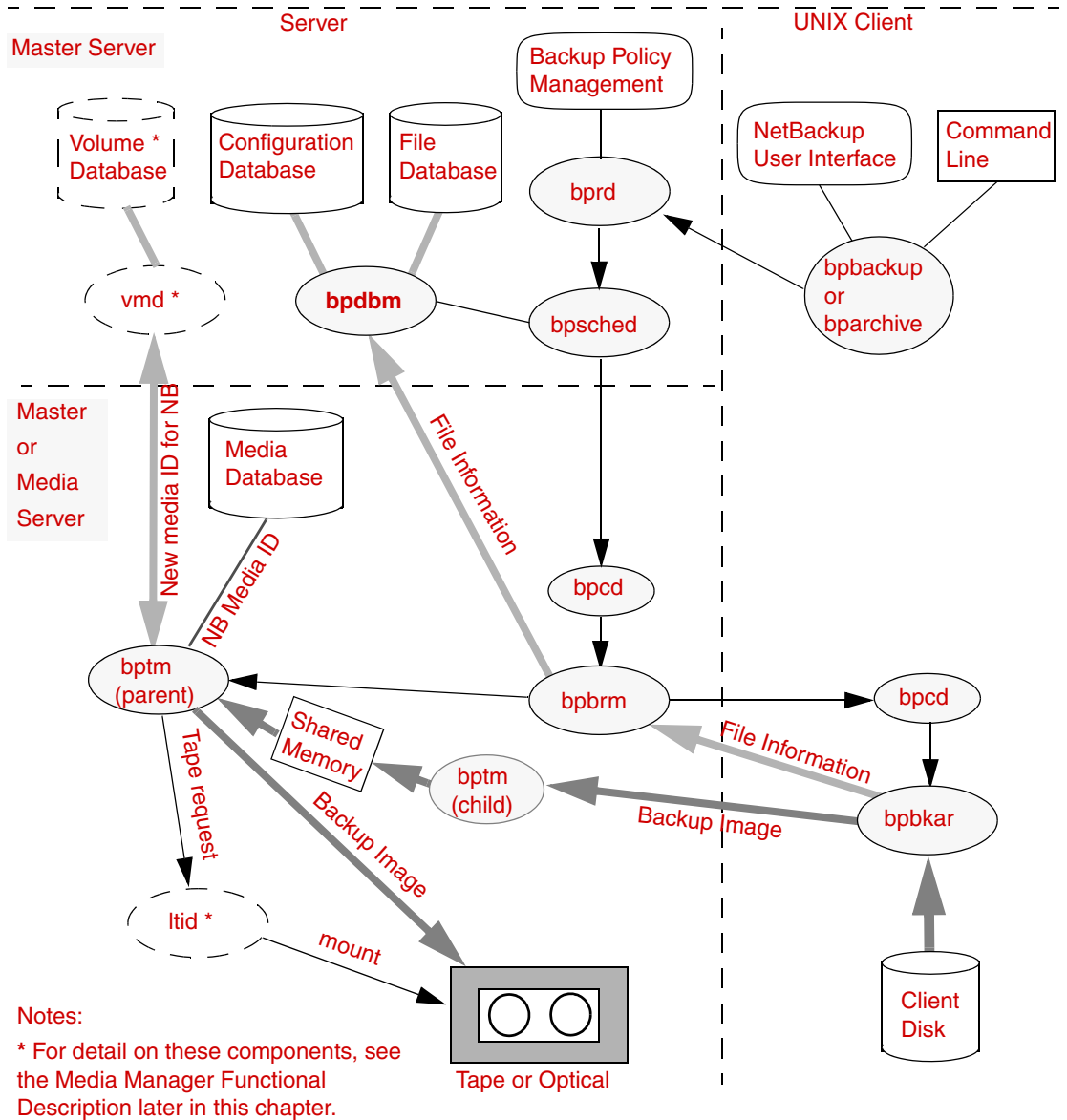

Backup or Archive to Disk

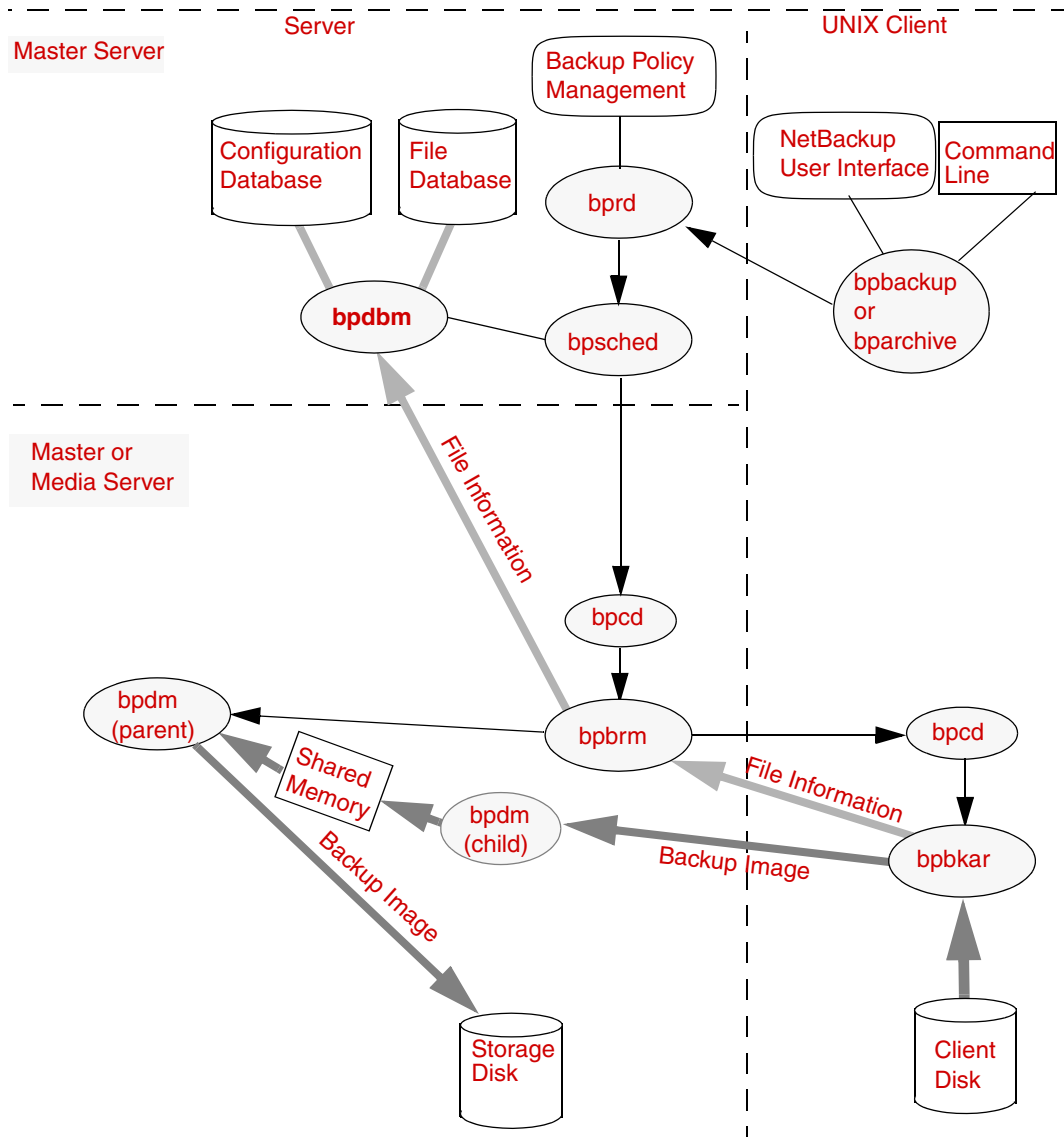

For all three types of backup and archive operations, `bpsched` uses the client daemon (`bpcd`) to start the backup/restore manager (`bpbrm`). The Scheduler (`bpsched`) starts the backup/restore manager on the media server, which may or may not be the same system as the master server.

The backup/restore manager starts the appropriate media manager process (`bptm` for tape or optical and `bpdm` for disk) and also starts the actual backup (or archive) by using the client daemon (`bpcd`) to start the backup and archive program (`bpbkar`) on the client.

The `bpbkar` program:

- ◆ Sends information about files within the image to the backup/restore manager, which directs the file information to the NetBackup file database.
- ◆ Transmits the backup image to the media manager process, `bptm` or `bpdm`. The `bptm` or `bpdm` process forks a second process, which receives the image and stores it block by block in shared memory. The original process then takes the image from shared memory and directs it to the storage media.
 - ◆ If the storage is tape or optical, `bptm` checks the NetBackup media database for a suitable media ID (for example, the correct density and retention level). If it can't find one, it obtains a new media ID from the Media Manager volume daemon, `vmd`. The `bptm` program includes the media ID in a tape request to the Media Manager device daemon, `ltid`, which finds the physical media and causes it to be mounted on an appropriate device. `bptm` also controls the spanning of backups across multiple tapes, if required.
 - ◆ If the storage media is disk, `bpdm` writes the images to the path configured in the disk storage unit. The system disk manager controls the actual writing of data.

In the case of an archive, NetBackup deletes the files from the client disk after the files have been successfully backed up.

For multiplexed backups, the process is essentially the same except that a separate `bpbrm` and `bptm` process is created for each backup image being multiplexed onto the media. NetBackup also allocates a separate set of shared memory blocks for each image. The figure below, "[Multiplexed Backups Example \(two streams\)](#)" shows an example of multiplexing images from two clients. The other client and server processes are the same as on the "[Backup or Archive to Tape or Optical](#)" graphic.



Multiplexed Backups Example (two streams)

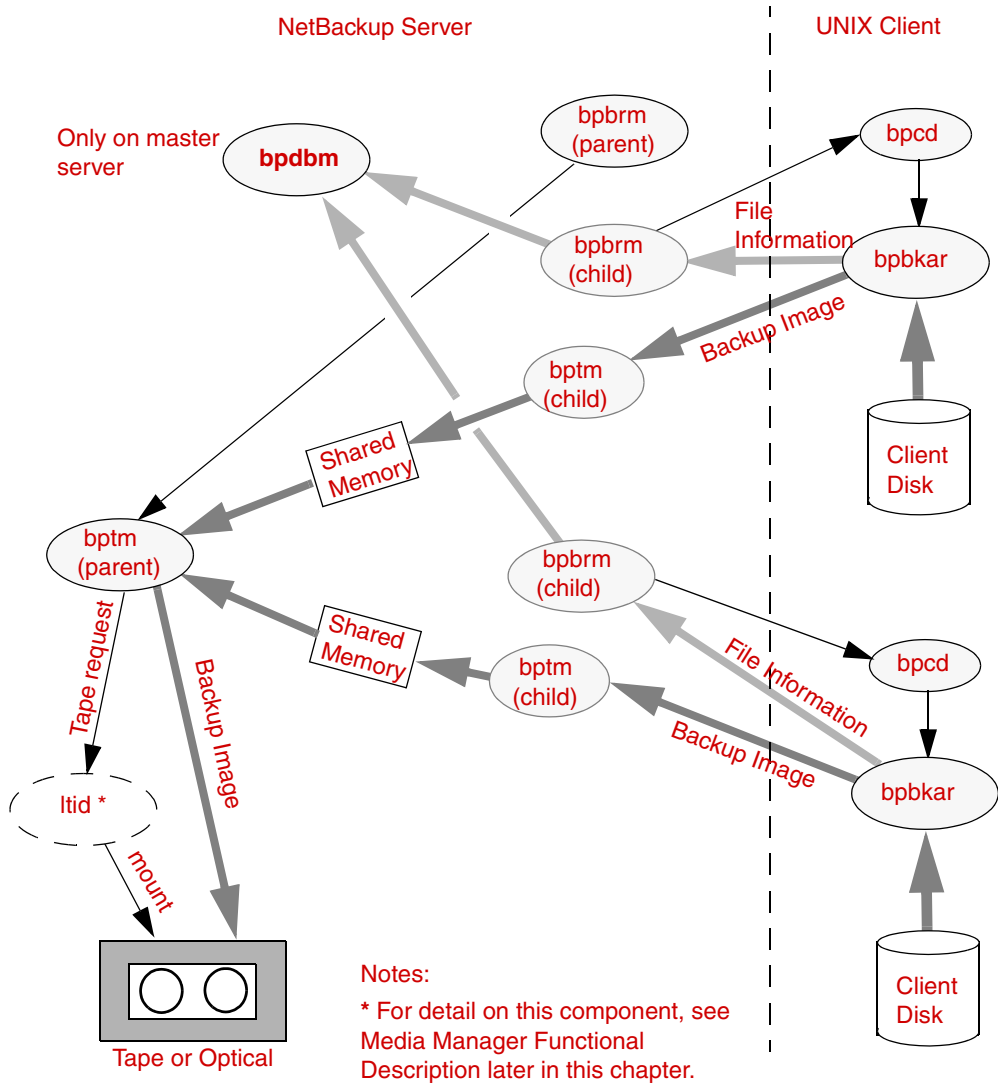

Backups and Archives - Windows NT/2000, XP, Windows Server 2003 Clients

NetBackup supports the same types of operations on Windows NT/2000, XP, and Windows Server 2003 clients as it does for UNIX clients.

The next figure shows the Windows NT/2000, XP, and Windows Server 2003 client processes. On this figure:

- ◆ NBWIN is the user interface program on the client. The `bpbbackup`, `bparchive`, and `bplist` functions are merged into NBWIN.
- ◆ BPINETD serves the same purpose as `inetd` on UNIX clients.
- ◆ The NetBackup client daemon is called BPCD.
- ◆ BPBKAR32 serves the same purpose as `bpbkar` on UNIX clients.

The server processes are the same as described for UNIX.

Backup and Archive -- Windows Clients

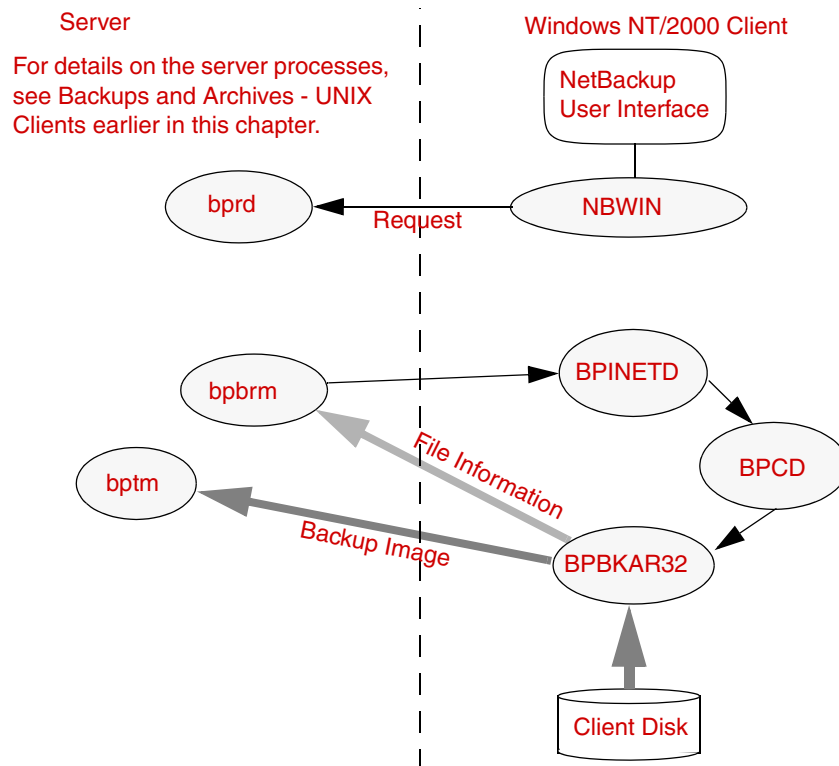

Backups and Archives - NetWare Clients

NetBackup supports the same types of operations on NetWare clients as it does on UNIX clients, with the following exceptions:

- ◆ Raw partition backups are not supported.
- ◆ NetBackup for NetWare does not support archiving.

The next figure shows the NetWare client processes. On this figure:

- ◆ For NetWare nontarget, the user interface program is called NBNWNT. For NetWare target, the user interface program is called BP on the Netware console. The bpbbackup, bpbarchive, and bplist functions are merged into the user interface programs on the clients.
- ◆ The NetBackup NetWare client daemon is called BPCD. The bpbkar functions are merged into BPCD.

The server processes are the same as described for UNIX.

Backup and Archive -- NetWare Clients

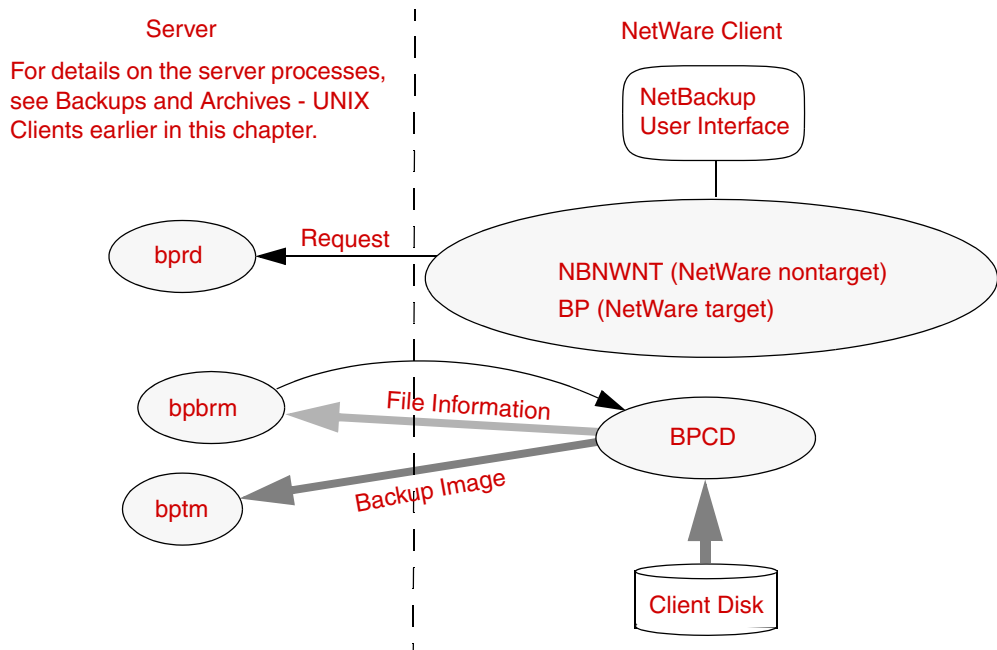

Synthetic Backups

Note There is no such thing as a synthetic archive.

We use the term “traditional backup” to describe the familiar NetBackup process which accesses the client to create an backup. A synthetic backup is a backup image created without using the client. Instead, a synthetic backup process creates a full or a cumulative incremental image using only previously created backup images, called component images.

For example, an existing full image and subsequent differential incremental images may be synthesized to create a new full image. The previous full image and the incrementals are the component images. The new synthetic full image behaves like a backup created through the traditional process. The new synthetic full image is a backup of the client that is as current as the last incremental. The synthetic image is created by copying the most current version of each file from the most recent component image containing the file. A synthetic backup must be created in a policy with the True Image Restore with Move Detection option selected. This option enables the synthetic backup to exclude files that have been deleted from the client file system from appearing in the synthetic backup.

Like a traditional backup, a synthetic backup is typically initiated by the scheduler, `bpsched`. `Bpsched` starts `bpsynth`, and `bpsynth` starts `bpcoord`. `Bpsynth` controls the creation of the synthetic backup image, and `bpcoord` controls the reading of the files needed from the component images. `Bpsynth` and `bpcoord` execute on the master server. If directories named `bpsynth` and `bpcoord` exist in the debug log directory, additional debug log messages will be written to log files in those directories.

Synthetic Backup -- Preparation Phase

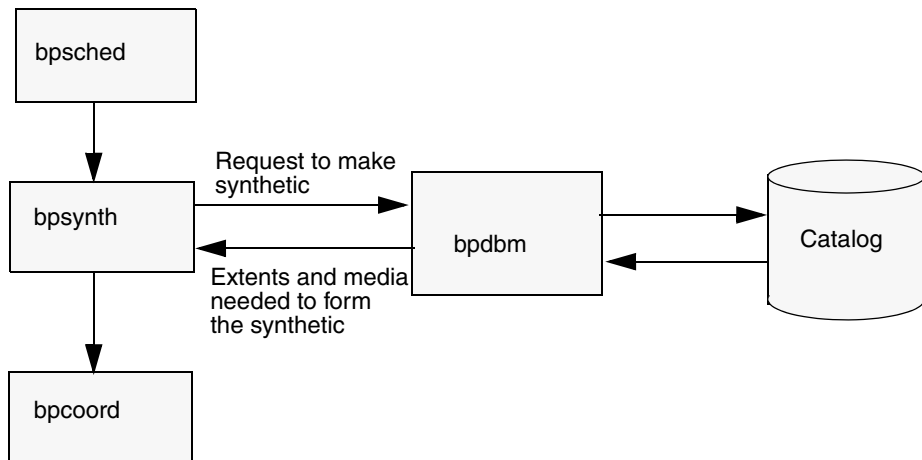

`bpsynth` makes a synthetic image in three phases: (1) preparation, (2) data copy, and (3) validation. In phase 1 `bpsynth` makes a synthetic backup request to the database manager, `bpdbm`. `bpdbm` uses the entries and the TIR information from the catalogs of the earlier component images to build the catalog for the new synthetic image and the extents to be copied from the component images to the synthetic image. `bpdbm` returns the list of extents to `bpsynth`. (An extent is the starting block number and the number of contiguous blocks within a specific component image.) There will usually be a set of extents that need to be copied from each component image onto the new synthetic image.

`bpsynth` also “suspends” tape volumes containing the component images so that they will not be chosen for the output image. (Input volumes are not suspended if they are already frozen or suspended.) The tape volumes suspended in this step will be un-suspended after the data copy phase completes.

In the data copy phase (2), `bpsynth` starts `bpcoord`. `bpsynth` starts the writer `bptm` (for tape) or `bpdm` (for disk) on the media server to write the new synthetic image. The required extents for each component image are sent to `bpcoord`. `bpcoord` starts a reader `bptm` (for tape) or `bpdm` (for disk) process for each component image on the media server where the component image was written. The reader process will read all extents for the component image.

Synthetic Backup -- Data Copy Phase

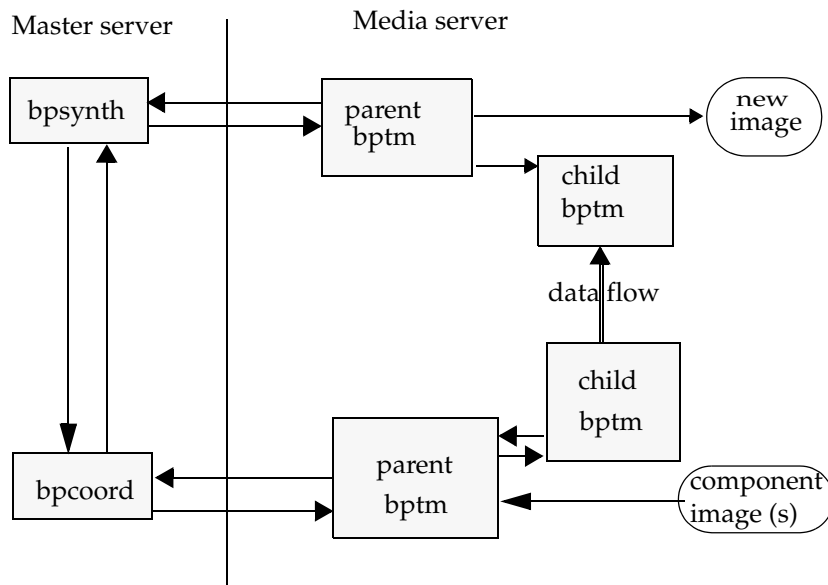

`bpcoord` will start `bptm` on the media server only if a tape drive is available in the storage unit to be used to read the image. The storage unit used is the one on which the component image was written. For instance, if there are three component images to read

and only one drive is available in the storage unit, then the first `bptm` reader process will be started. The second reader process will be started after the first one completes and the third reader process will be started after the second one completes. However, if three drives are available in the storage unit, then all three reader processes will be started simultaneously. Note that if the component images reside on disk, then all `bpdm` readers will be started immediately since disk is not a manageable resource.

Note that `bpsynth/bpcoord` only start the parent `bptm/bpdm` reader/writer process on the media server. The parent in turn starts a child process. The parent and child communicate via buffers in shared memory.

The `bpsynth` process sends the extents (starting block and count) for each component image to the corresponding child `bptm/bpdm` reader process.

The parent `bptm/bpdm` reader process reads the data from the appropriate media into the shared buffers. The child `bptm/bpdm` reader process sends the data in the shared buffers to the child `bptm/bpdm` writer process over a socket. The child `bptm/bpdm` writer process writes the data into the shared buffers. The parent `bptm/bpdm` writer process copies the data from the shared buffers to the media.

The parent `bptm/bpdm` writer process notifies `bpsynth` when the synthetic image is complete. The `bpsynth` process then validates the image. The new image is now visible to NetBackup and can be used like any other full or cumulative incremental backup.

Synthetic backup requires:

- ◆ That True Image Restore (TIR) with move detection be selected for each component image.
- ◆ That the component images are made with NBU 5.0 or later clients, or that they are synthetic images.
- ◆ That the component images use the binary catalog format, not the ASCII catalog format.

NetBackup Database Backups

The administrator can use an option in the administrator interface to start a manual backup of the NetBackup databases or configure NetBackup to automatically back up its databases (see figure “[NetBackup Database Backup](#)”).

It is possible to configure automatic database backups to occur either:

- ◆ After each scheduled backup session that results in the creation of at least one backup image.
- Or
- ◆ After scheduled, user-directed, or manual backup or archive sessions that result in the creation of at least one backup or archive image.



For automatic database backups, NetBackup uses the scheduler, `bpsched`, to determine if any backups are required. The scheduler is activated by the request daemon, `bprd`, at intervals determined by the `Wakeup Interval` global attribute. If a backup is needed, `bpsched` uses the client daemon, `bpcd`, to start the database backup program, `bpbackupdb`.

For a manual database backup, NetBackup invokes `bpbackupdb` directly, without going through `bprd` or the scheduler. Once started, `bpbackupdb`:

1. Queries `bpdbm` for the database paths to back up and the media ID to use for the backup.
2. Starts the tape and optical manager, `bptm`, and sends it the media ID in a special mount request.

The tape and optical manager, `bptm`, recognizes the request as being for a database backup and checks the database to ensure that the media ID is not one used for regular backups. The `bptm` program then includes the media ID in a request to the Media Manager device daemon, `ltid`. The device daemon finds the media and causes it to be mounted on an appropriate device.

NetBackup Database Backup

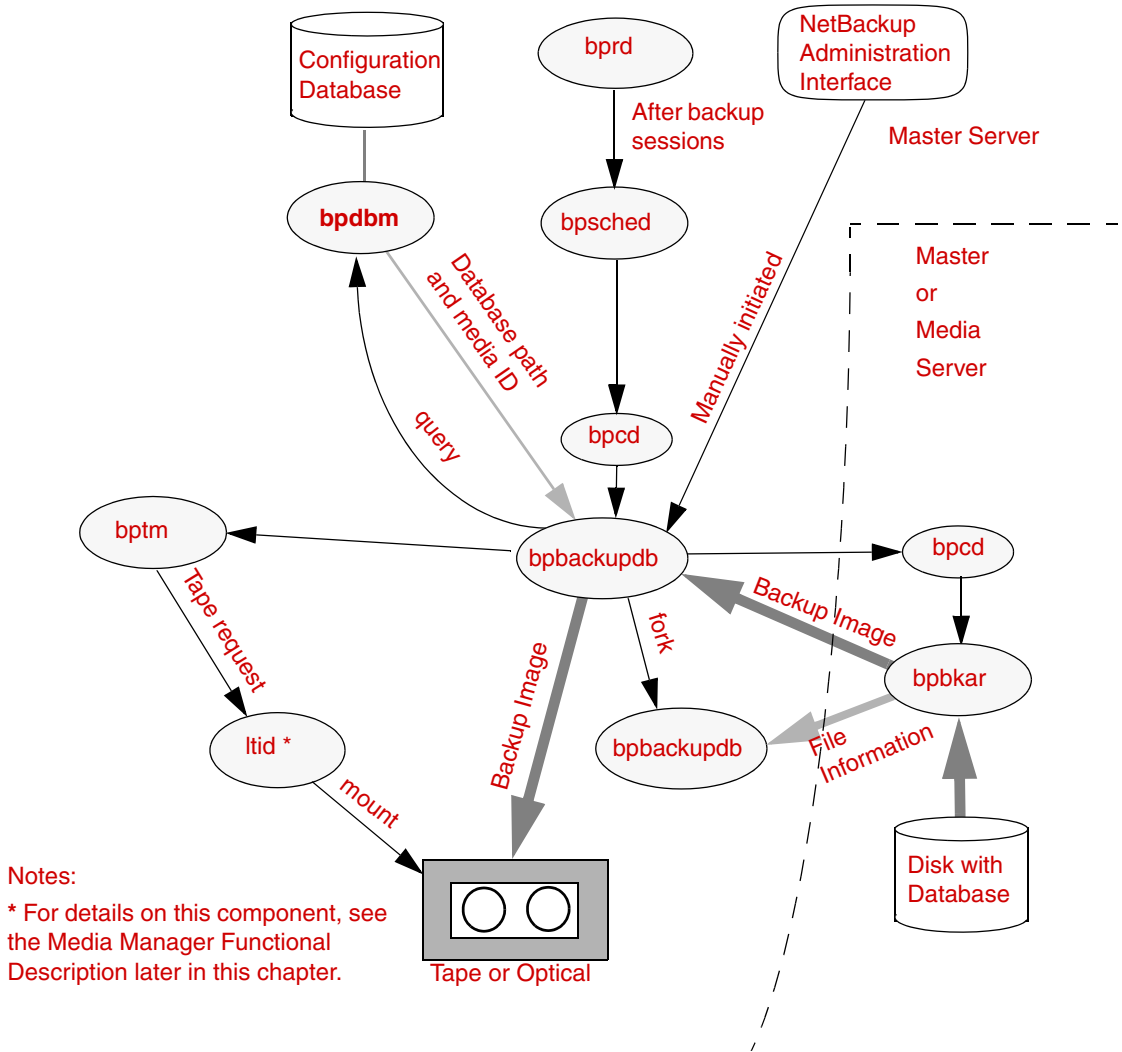

3. Starts the actual backup by using `bpacd` to start the backup program, `bpbkar`.

If the database is on the master server, `bpbackupdb` starts the backup and archive program on the master server. If the database is on a media server, `bpbackupdb` starts the backup and archive program on the media server.

The `bpbkar` program transmits file information and the backup image to separate `bpbackupdb` processes as shown in the figure “[NetBackup Database Backup](#)”.



- ◆ The original `bpbackupdb` process receives the backup image and sends it to the backup device.
- ◆ A second `bpbackupdb` process checks the file information to ensure that the proper files are being backed up.

The entire database backup must fit on a single tape. The `bpbackupdb` process is unable to span tapes and there is no mechanism for specifying multiple tapes for an NetBackup database backup.

If any part of the database backup fails, then NetBackup discards the entire backup. This is done because you must have a backup of *all* the databases to be certain that you have a consistent database.

Restore Processes

NetBackup restore operations, like backups, can vary according to client type. The following explains the basic variations.

Restores - UNIX Clients

Before starting a restore operation, a user will usually browse the file database and list the files available in the backup images. The desired files can then be selected from the list.

The browsing is done through the `bplist` program on the client. The `bplist` program can be started directly from the command line and is used by the NetBackup user interface programs.

`bplist` obtains the file list by sending a query to the request daemon, `bprd`, on the master server (see the graphic below, "[List Operation - UNIX Client](#)"). The request daemon, in turn, queries `bpdbm` for the information and transmits it to `bplist` on the client.

List Operation - UNIX Client

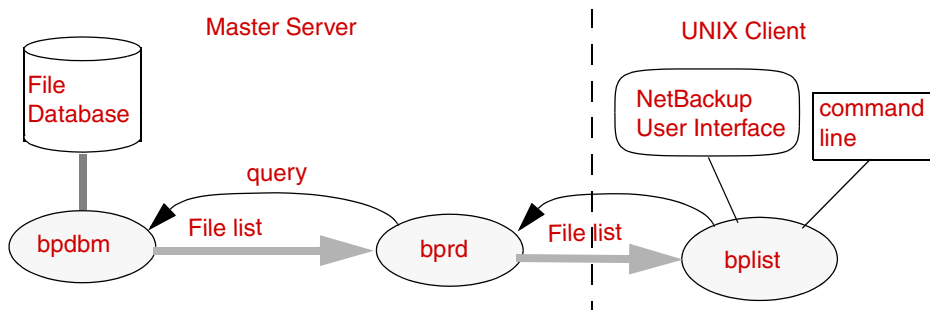

When the user starts a restore, NetBackup invokes the client's `bprestore` program which sends a request to the request daemon, `bprd` (see the graphic "[Restore Operation from Tape or Optical](#)"). This request identifies the files and client. The request daemon then uses `bpcd` (client daemon) to start the backup/restore manager (`bpbrm`).

Note To restore Backup Exec images, `bpbrm` will invoke `mtfrd` instead of `tar` on the clients. The server processes are the same as those used for NetBackup restores.

If the storage unit on which the files reside attaches to the master server, then `bprd` starts the backup/restore manager on the master server. If the storage unit connects to a media server, `bprd` starts the backup/restore manager on the media server.

The backup/restore manager starts the appropriate media manager process (`bptm` for tape or optical or `bpdm` for disk) and uses the client daemon (`bpcd`) to establish a connection between the NetBackup `tar` program on the client and `bptm` or `bpdm` on the server.

The `bptm` (for tape or optical) or `bpdm` (for disk) process obtains the location of the data (media ID or file path) and then starts retrieving data. During retrieval, the original `bptm` or `bpdm` process stores the image block by block in shared memory. A second `bptm` or `bpdm` process transmits the image to the client.

- ◆ If the storage medium is tape or optical, `bptm` includes the media ID in a `tpreq` command to the Media Manager device daemon, `ltid`. The device daemon finds the physical media and causes it to be mounted on an appropriate device. The `bptm` program reads the image and directs it to the client, where the NetBackup `tar` program writes it on the client disk.
- ◆ If the storage medium is disk, `bpdm` uses the file path in a read request to the system disk manager. The image is then read from disk and transmitted to the client, where the NetBackup `tar` program writes it on the client disk. Only the part of the image that is required to satisfy the restore request is sent to the client, not necessarily the entire backup image.



Restore Operation from Tape or Optical

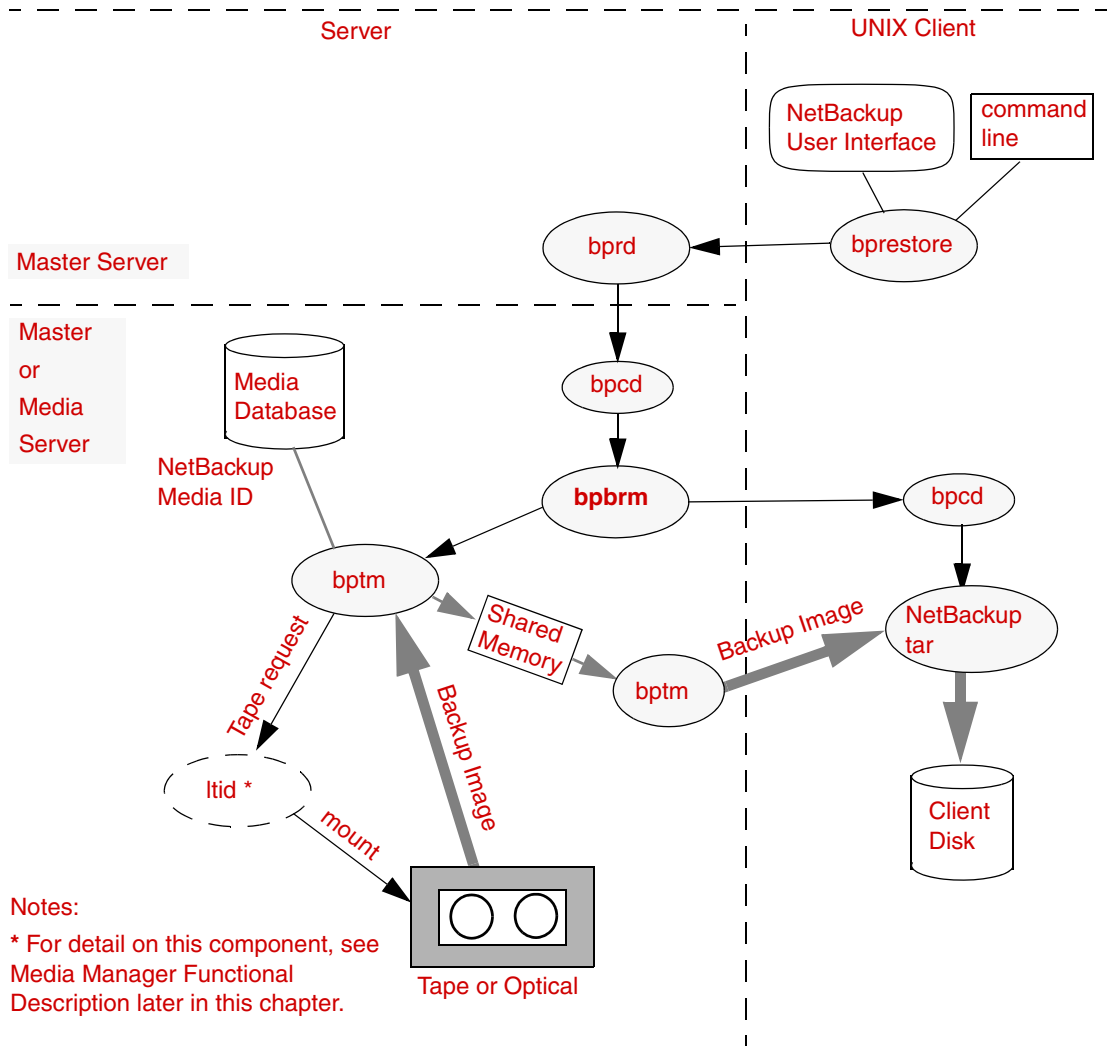

Restore Operation from Disk

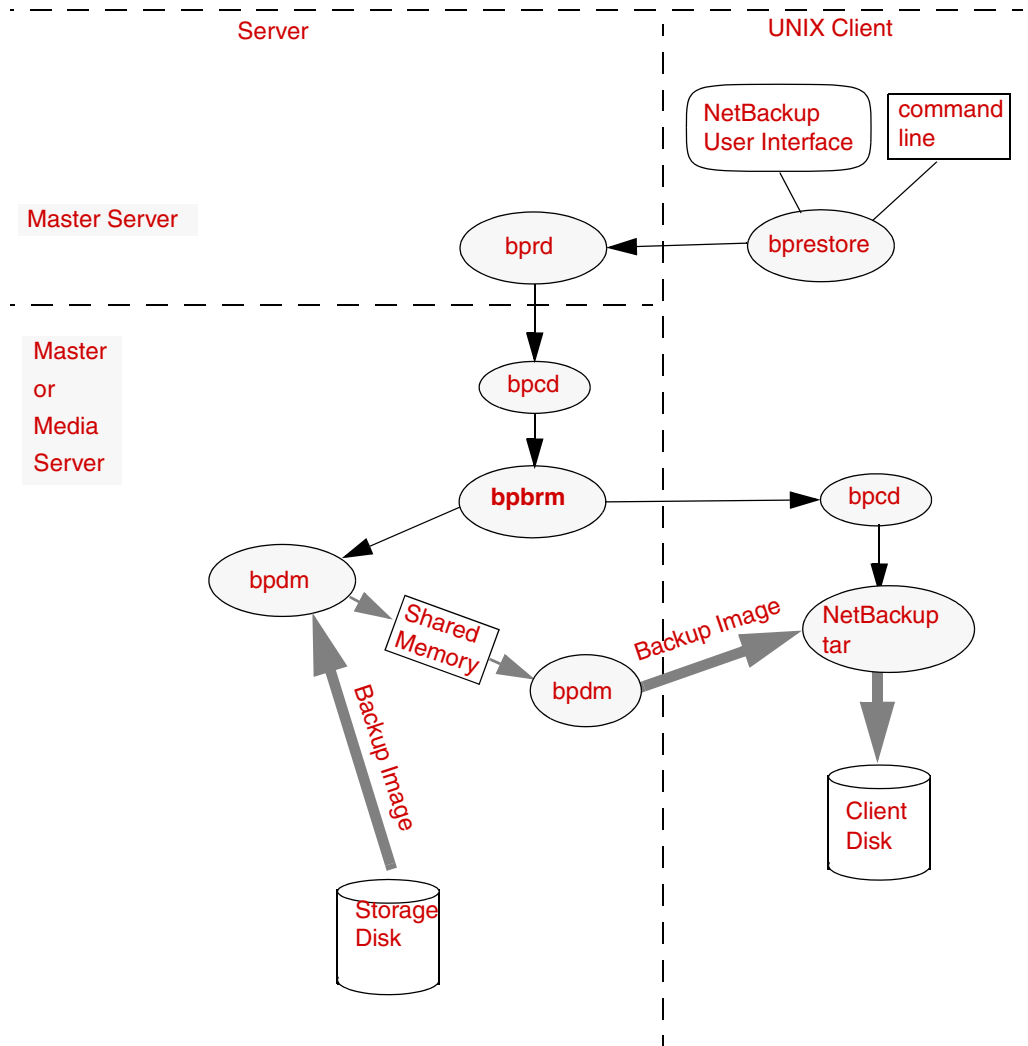

Restores - Windows NT/2000, XP and Windows Server 2003 Clients

NetBackup supports the same types of operations on Windows NT/2000, XP and Windows Server 2003 clients as it does for UNIX clients. The next figure shows the client processes involved in these operations.

- ◆ The user interface program on Windows NT/2000, XP and Windows Server 2003 is called NBWIN.
- ◆ BPINETD is part of NetBackup for Windows NT/2000, XP and Windows Server 2003 and serves the same purpose as `inetd` on UNIX.
- ◆ The NetBackup client daemon is called BPCD.
- ◆ TAR32 is part of NetBackup for Windows NT/2000, XP and Windows Server 2003 and serves the same purpose as NetBackup `tar` on UNIX.

Note To restore Backup Exec images, `bpbrm` will invoke `mtfrd.exe` instead of `tar32.exe` on the clients. The server processes are the same as those used for NetBackup restores.

The server processes are the same as described for UNIX.

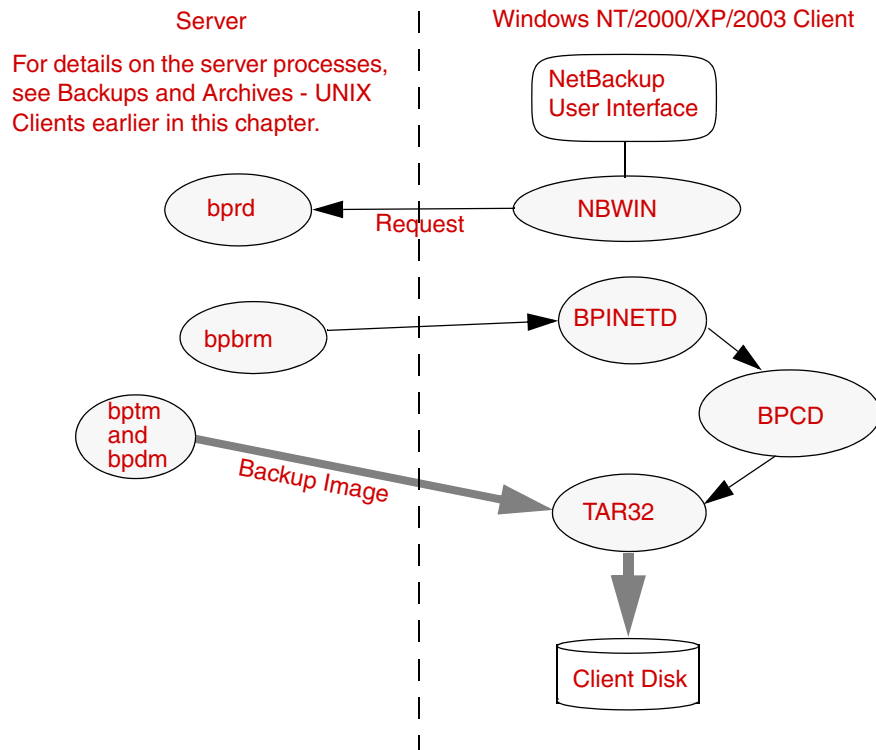

Restores - NetWare Clients

NetBackup supports the same types of restore operations on NetWare clients as it does on UNIX clients. The next figure shows the client processes involved in these operations. On this figure:

- ◆ The NetWare nontarget user interface program is called `NBNWNT`. The NetWare target user interface program is `BP` on the Netware console. The `bprestore` and `bplist` functions are merged into the user interface programs on the clients.
- ◆ The NetBackup NetWare client daemon is called `BPCD`. The NetBackup `tar` functions are merged into `BPCD`.
- ◆ `mt frd` functionality (used to restore Backup Exec images) has been merged into `BPCD`. The server processes involved in import and restore operations for Backup Exec images are the same as those involved for NetBackup restores.

The server processes are the same as described for UNIX.

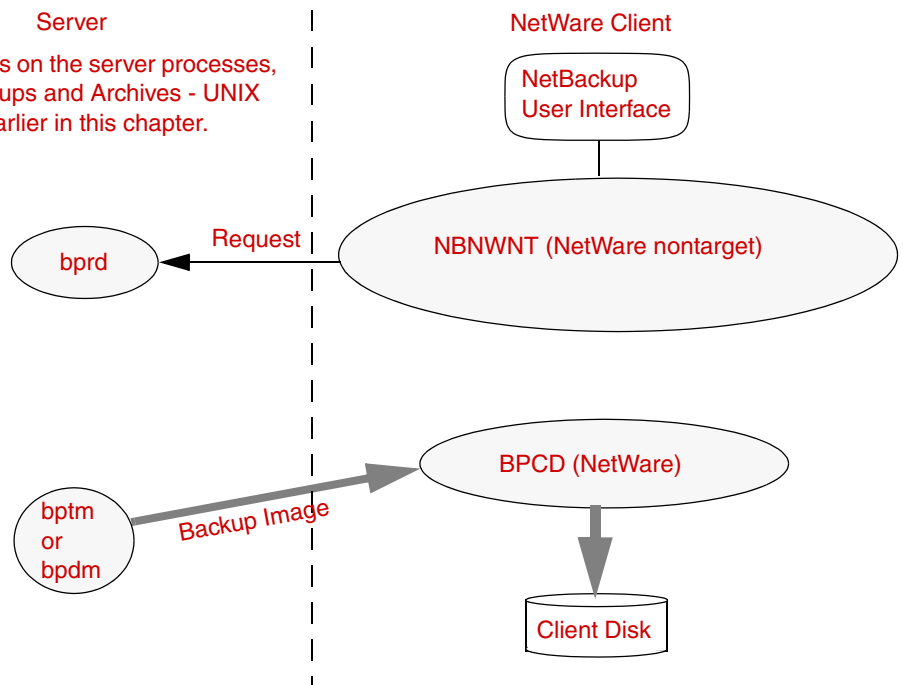

NetBackup Directories and Files

The figure below, “[NetBackup Directories and Files - UNIX Servers and Clients](#)” shows the NetBackup file and directory structure on UNIX servers and clients. If a host is only a client and not a server, then only the files in the lower part of the graphic “[NetBackup Directories and Files - UNIX Servers and Clients](#)” are present. If a host is both a client and a server, the client component shares files as necessary from those in the upper part of the graphic “[NetBackup Directories and Files - UNIX Servers and Clients](#)”.

A Windows NetBackup server has equivalent files and directories that are located in the directory where NetBackup is installed (C:\Program Files\VERITAS by default).

The table “[NetBackup Directories and Files - Servers and UNIX Clients](#)” describes the files and directories that are of special interest.

NetBackup Directory Structure -- UNIX

NetBackup Directories and Files - UNIX Servers and Clients

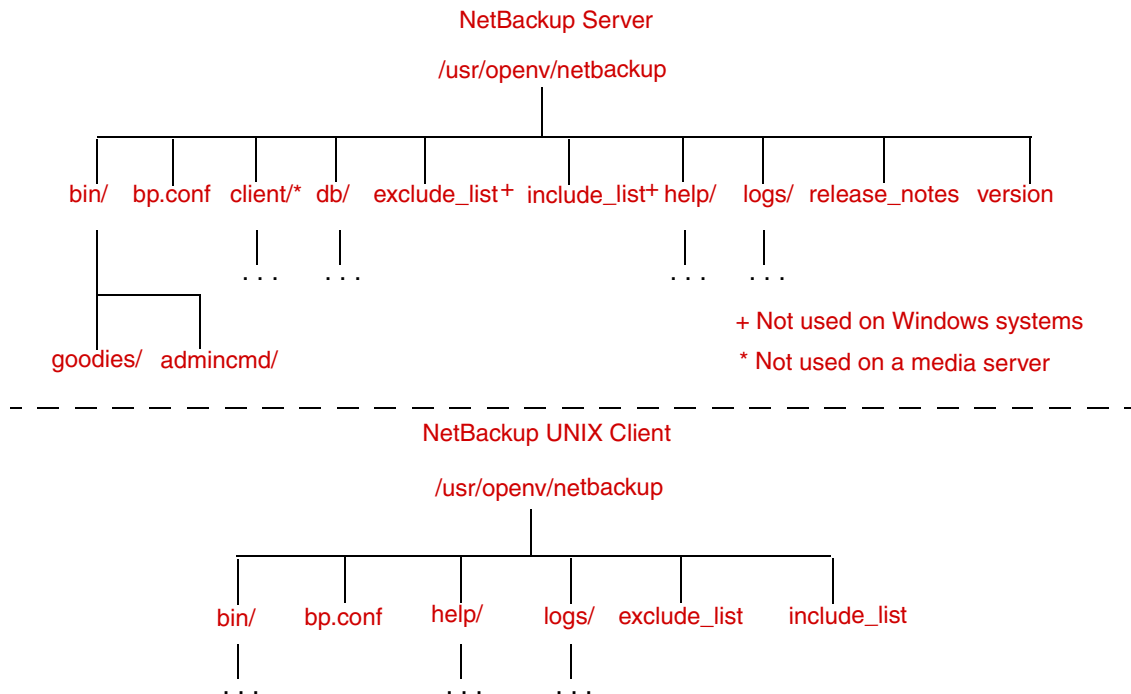

NetBackup Directories and Files - Servers and UNIX Clients

File or Directory	Contents
bin	<p>Commands, scripts, programs, daemons, and files required for NetBackup operation and administration. On a server, there are two subdirectories under bin.</p> <p>admincmd: Contains various commands used internally by NetBackup. Use these commands <i>ONLY</i> if they are documented. Most of these commands are not documented and should not be used directly.</p> <p>goodies (UNIX only): Contains scripts and information that may be useful to the administrator.</p> <p>These subdirectories are not present on clients.</p>
bp.conf	<p>Configuration file where you can specify various options for NetBackup operation. The <i>NetBackup System Administrator's Guide</i> has a detailed explanation of each option and how to set it. On a Windows server, these options are set in the interface.</p>
client	<p>NetBackup client software that is installed on the clients during the installation process. Do not install this directory on a media server.</p>
db	<p>NetBackup databases as described in the table "NetBackup Databases".</p>
exclude_list	<p>On UNIX clients, this file contains a list of files and directories to exclude from scheduled backups. The <i>NetBackup System Administrator's Guide</i> explains how to use this file.</p>
help	<p>Help files used by NetBackup programs. These files are in ASCII format.</p>
include_list	<p>On UNIX clients, this file contains a list where you can specify a subset of the exclude list to add back into scheduled backups. The <i>NetBackup System Administrator's Guide</i> explains how to use this file.</p>
logs	<p>Detailed debug logs for NetBackup processes. You must create the necessary subdirectories in order for these log files to be written (see the chapter "Using Logs and Reports"). See the table "NetBackup Daemons and Programs" for an explanation of the processes that produce the logs.</p>



NetBackup Directories and Files - Servers and UNIX Clients (continued)

File or Directory	Contents
release_notes	NetBackup release notes in ASCII format, so you can conveniently view or print them.
version	Version and release date of the software.

NetBackup Programs and Daemons

The table below, “[NetBackup Daemons and Programs](#)”, describes the programs and daemons that provide most of the control for backup, archive, and restore operations. The explanations include what starts and stops the program or daemon, and the debug log subdirectory (if any) where it records its activities. (You must create the subdirectory manually; see “logs” in the previous table, and chapter 4, “[Using Logs and Reports](#)”.)

NetBackup Daemons and Programs

Program/ Daemon	Description
bp	<p>On UNIX clients, this menu-driven, character-based interface program has options for starting user-directed backups, restores, and archives.</p> <p>Started By: <code>/usr/openv/netbackup/bin/bp</code> command on the client.</p> <p>Stopped By: Exiting the interface program.</p> <p>Debug Log: <code>/usr/openv/netbackup/logs/bp</code> on the client. The debug logs for <code>bpbackup</code>, <code>bparchive</code>, <code>bprestore</code>, and <code>bpulist</code> also have information about <code>bp</code> activities.</p>
BP.NLM	<p>On NetWare target clients, this is the NetWare Loadable Module that starts the client-user interface.</p> <p>Started By: <code>LOAD BP</code> command.</p> <p>Stopped By: Choosing Quit Utility from the main menu.</p> <p>Debug Log: <code>SYS:\OPENV\NETBACK\LOGS\BP\mmdyy.log</code> file on the client.</p>

NetBackup Daemons and Programs (continued)

Program/ Daemon	Description
bpadm	<p>On a UNIX master server, this administrator utility has a menu-driven, character-based, interface with options for configuring and managing NetBackup.</p> <p>Started By: <code>/usr/opensv/netbackup/bin/bpadm</code> command on the master server.</p> <p>Stopped By: Quit option from within <code>bpadm</code>.</p> <p>Debug Log: <code>admin.log</code> on the server.</p>
bparchive	<p>On UNIX clients, this program communicates with <code>bprd</code> on the master server when a user starts an archive.</p> <p>Started By: Starting an archive by using the client-user interface or executing the <code>/usr/opensv/netbackup/bin/bparchive</code> command on the client.</p> <p>Stopped By: Completion of operation.</p> <p>Debug Log: <code>bparchive.log</code> on the client.</p>
bpbackup	<p>On UNIX clients, this program communicates with <code>bprd</code> on the master server when a user starts a backup.</p> <p>Started By: Starting a backup by using the client-user interface or executing the <code>/usr/opensv/netbackup/bin/bpbackup</code> command on the client.</p> <p>Stopped By: Completion of operation</p> <p>Debug Log: <code>bpbackup.log</code> on the client.</p>
bpbrm	<p>On master and media servers, the Backup/Restore Manager manages the client and media manager processes and uses error status from both to determine the final status of backup or restore operations.</p> <p>Started By: For each backup or restore, <code>bpsched</code> starts an instance of <code>bpbrm</code> on the server with the appropriate storage unit.</p> <p>Stopped By: Completion of operation.</p> <p>Debug Log: <code>bpbrm.log</code> on the server.</p>
bpbkar	<p>On UNIX clients the Backup/Archive Manager generates the backup images.</p> <p>Started By: <code>bpbrm</code> on the server with the storage unit.</p> <p>Stopped By: Completion of operation.</p> <p>Debug Log: <code>bpbkar.log</code> on the client.</p>



NetBackup Daemons and Programs (continued)

Program/ Daemon	Description
BPBKAR32	<p>On Windows clients, the Backup/Archive Manager generates the backup images.</p> <p>Started By: BPCDW32 on the client.</p> <p>Stopped By: Completion of operation.</p> <p>Debug Log: BPBKAR.LOG file in the NetBackup logs directory on the client.</p>
bpcd	<p>On UNIX clients, bpcd is the NetBackup client daemon and lets NetBackup start programs on remote hosts (can be UNIX clients or other servers). For example, the server can connect to UNIX clients without requiring / . rhosts entries on the remote host. The program is used when bpsched starts bpbrm and when bpbrm communicates with the client.</p> <p>(For a description of the NetBackup client daemon on PC clients, see BPCDW32 . EXE, BPCD . NLM, and NetBackupBPCD later in this table.)</p> <p>Started By: inetd.</p> <p>Stopped By: Completion of operation.</p> <p>Debug Log: bpcd . log on both client and server.</p>
BPCD . NLM	<p>On NetWare clients, this is the executable file that starts the NetBackup client daemon.</p> <p>Started By: When you start the Novell NetWare system if you add load bpcd to the AUTOEXEC . NCF file. Otherwise, with the LOAD BPCD command.</p> <p>Stopped By: UNLOAD BP command</p> <p>Debug Log: BPCD . LOG file in the NetBackup logs directory on the client.</p>
BPCDW32 . EXE	<p>On Windows 95 and NT/2000, XP and Windows Server 2003 clients, this is the executable file that starts the NetBackup client daemon.</p> <p>Started By: When Windows starts if the daemon is in the Startup group. Otherwise, by double clicking on its icon.</p> <p>Stopped By: On Windows NT/2000, XP and 2003, you can stop it through the Services application in the Control Panel. On Windows 95, you can stop it by clicking on its icon and choosing Close.</p> <p>Debug Log: BPCD . LOG file in the NetBackup logs directory on the client.</p>

NetBackup Daemons and Programs (continued)

Program/ Daemon	Description
bpdjobs	<p>On UNIX master servers, this program is used to clean up the NetBackup jobs database.</p> <p>Started By: /usr/opensv/netbackup/bin/admincmd/bpdjobs. When bprd starts, it runs this command automatically. The administrator can also execute it manually or with a cron job.</p> <p>Stopped By: There is no terminate option for this command outside of using kill.</p> <p>Debug Log: bpdjobs.log on the server.</p>
bpdm	<p>On master servers, the NetBackup database manager program that manages the configuration, error, and file databases.</p> <p>Started By: bprd (also by /usr/opensv/netbackup/bin/initbpdm on UNIX)</p> <p>Stopped By: /usr/opensv/netbackup/bin/bpdm -terminate command on UNIX and by stopping the NetBackup Database Manager service on Windows.</p> <p>Debug Log: bpdm.log on the server.</p>
bpdm	<p>On master and media servers, bpdm is the disk-media manager and is used when the storage unit type is a disk. This program manages the transfer of images between the client and the operating-system disk manager on the server to which the disk attaches.</p> <p>Started By: For each backup or restore, bpbm starts an instance of bpdm, on the server with the storage unit.</p> <p>Stopped By: Completion of operation.</p> <p>Debug Log: bpdm.log on the server.</p>
bphdb	<p>On UNIX database-extension clients, bphdb starts the NetBackup hot-database-backup program (see the applicable NetBackup installation guide for more information).</p> <p>Started By: Client-user interface when the user starts a database backup or restore operation.</p> <p>Stopped By: Completion of operation.</p> <p>Debug Log: bphdb.log on the client. With NetBackup for Oracle, bphdb also writes to /usr/opensv/netbackup/logs/obackup_tape.</p>



NetBackup Daemons and Programs (continued)

Program/ Daemon	Description
bpjava-msvc	<p>NetBackup-Java master server application program. This program runs on all NetBackup UNIX systems and authenticates users that start the NetBackup-Java interface programs.</p> <p>Started By: <code>inetd</code> during startup of the NetBackup Java interfaces.</p> <p>Stopped By: When authentication is complete.</p> <p>Debug Log: <code>/usr/opensv/netbackup/logs/bpjava-msvc</code></p>
bpjava-usvc	<p>NetBackup-Java user server application program. This program services all requests from the NetBackup-Java user and administration interfaces.</p> <p>Started By: <code>bpjava-msvc</code> upon successful login through the Login dialog box that is presented when a NetBackup-Java interface is started.</p> <p>Stopped By: When the interface program is terminated.</p> <p>Debug Log: <code>/usr/opensv/netbackup/logs/bpjava-usvc</code></p>
bprd	<p>On master servers, the request daemon responds to client and administrative requests for the following:</p> <ul style="list-style-type: none">◆ Restores◆ Backups (scheduled and user-directed)◆ Archives◆ List backed up or archived files◆ Manual immediate backups (started through the NetBackup administration interface manual backup option) <p>Started By: Initiate Request Daemon option on the Special Actions menu in <code>bpadm</code> (also the <code>/usr/opensv/netbackup/bin/initbprd</code> command).</p> <p>Stopped By: Terminate Request Daemon option on the Special Actions menu in <code>bpadm</code>.</p> <p>Debug Log: <code>bprd.log</code> on the server.</p>

NetBackup Daemons and Programs (continued)

Program/ Daemon	Description
bplist	<p>On UNIX clients, this program communicates with bprd on the master server when a user browses the database during a restore operation.</p> <p>Started By: Starting a search of the image database by using the client-user interface or executing the <code>/usr/opensv/netbackup/bin/bplist</code> command on the client.</p> <p>Stopped By: Completion of operation</p> <p>Debug Log: <code>bplist.log</code> on the client.</p>
bprestore	<p>On UNIX clients, this program communicates with bprd on the master server when a user starts a restore.</p> <p>Started By: Starting restore by using the client-user interface (or by executing the <code>/usr/opensv/netbackup/bin/bprestore</code> command on the client).</p> <p>Stopped By: Completion of operation</p> <p>Debug Log: <code>bprestore.log</code> on the client.</p>
bpsched	<p>On master servers, the Scheduler uses policy information from the NetBackup configuration databases to determine:</p> <ul style="list-style-type: none"> ◆ Clients to start and when to start them. ◆ Storage units to use for backups and archives. <p>Started By: bprd for the following operations:</p> <ul style="list-style-type: none"> ◆ User-directed backups and archives ◆ Immediate manual backups (started through the option that is available in the NetBackup administrator interface) ◆ Scheduled automatic incremental or full backups. In this case, bprd starts the scheduler at intervals determined by the <code>wakeup interval</code> global attribute. <p>Stopped By: Completion of all backups that are due.</p> <p>Debug Log: <code>bpsched.log</code> on the server.</p>



NetBackup Daemons and Programs (continued)

Program/ Daemon	Description
bptm	<p>On master and media servers, <code>bptm</code> is the tape-media manager and is used when the storage unit type is Media Manager. This program manages transfer of images between the client and the storage device. It also handles communication between the backup and Media Manager software. In addition, <code>bptm</code> manages the NetBackup media database and provides information for the media list report screen.</p> <p>Started By: For each backup or restore, <code>bpbrm</code> starts an instance of <code>bptm</code> on the server that has the storage unit.</p> <p>Stopped By: Completion of operation.</p> <p>Debug Log: <code>bptm.log</code> on the server.</p>
BPSRV.EXE	<p>On NetWare nontarget clients, this is the program that allows the system that has the client-user interface to communicate with the Netware server that is the NetBackup client.</p> <p>Started By: Starting NetBackup for NetWare.</p> <p>Stopped By: Exiting the client-user interface.</p> <p>Debug Log: <code>BPSRV.LOG</code> file in the NetBackup LOGS directory on the client.</p>
BPSYS.EXE	<p>On Windows NT/2000, XP and Windows Server 2003 clients, this is the NetBackup System Registry Replacement utility.</p> <p>Started By: NetBackup as required.</p> <p>Stopped By: Completion of operation.</p> <p>Debug Log: <code>BPSYS.LOG</code> file in the NetBackup LOGS directory on the client.</p>
jbpsa	<p>A Java-based program for performing backups, archives and restores of UNIX clients.</p> <p>Started By: On UNIX, the <code>/usr/openssl/netbackup/bin/jbpsa</code> command.</p> <p>Debug Log: None, although the log for the <code>bpbackup</code>, <code>bparchive</code>, <code>bplist</code>, and <code>bprestore</code> commands on the client can be useful. Also, the logs for <code>bpjava-msvc</code> and <code>bpjava-usvc</code> can be helpful.</p>

NetBackup Daemons and Programs (continued)

Program/ Daemon	Description
jnbSA	<p>A Java-based administration utility for managing NetBackup and Media Manager on UNIX. In addition, administration of supported UNIX systems can be performed by using the NetBackup-Java Windows Display Console on a Windows system.</p> <p>Started By: On UNIX, the <code>/usr/opensv/netbackup/bin/jnbSA</code> command. On a NetBackup-Java Windows Display console, the NetBackup - Java on <i>host</i> menu item on the Programs/NetBackup menu.</p> <p>Stopped By: Exit option in jnbSA.</p> <p>Debug Log: None, although the logs for <code>bpjava-msvc</code> and <code>bpjava-usvc</code> can be helpful.</p>
ndmpmoveragent	<p>On the NetBackup media server (UNIX), this daemon acts as an NDMP server in a type of three-way backup called Remote NDMP.</p> <p>Started By: Executing <code>/usr/opensv/volmgr/bin/ndmpmoveragent.start</code>.</p> <p>Stopped By: Executing <code>/usr/opensv/volmgr/bin/ndmpmoveragent.stop</code>.</p> <p>Debug Log: <code>/usr/opensv/netbackup/logs/ndmpmoveragent</code></p>
NDMP Mover Agent	<p>On the NetBackup media server (Windows), this service acts as an NDMP server in a type of three-way backup called Remote NDMP.</p> <p>Started By: Executing <code>install_path/netbackup/bin/InstallNdpMoverAgent path_of_NetBackup_binaries</code></p> <p>Stopped By: Executing <code>install_path/netbackup/bin/InstallNdpMoverAgent -r</code>.</p> <p>Debug Log: <code>install_path/netbackup/logs/ndmpmoveragent</code></p>
NBWIN.EXE	<p>For Windows clients, this is the executable file that starts the client-user interface on Windows systems.</p> <p>Started By: From the Windows Start menu, under Programs/NetBackup.</p> <p>Stopped By: Exiting the client-user interface.</p> <p>Debug Log: <code>mmdyy.log</code> file in the NBWIN directory on the client.</p>



NetBackup Daemons and Programs (continued)

Program/ Daemon	Description
NBNWNT . EXE	<p>For NetWare nontarget clients, this is the executable file that starts the client-user interface on Windows systems.</p> <p>Started By: From the Windows Start menu, under Programs/NetBackup.</p> <p>Stopped By: Exiting the client-user interface.</p> <p>Debug Log: none.</p>
NBNW95 . EXE	<p>For NetWare nontarget clients, this is the executable file that starts the client-user interface on Windows 98/95 systems.</p> <p>Started By: From the Windows Start menu, under Programs/NetBackup.</p> <p>Stopped By: Exiting the client-user interface.</p> <p>Debug Log: none.</p>
tar	<p>On UNIX clients, the Tape ARchive program is a special version of tar provided with NetBackup and used to restore images.</p> <p>Started By: For each restore, bpbm starts an instance of tar on the client.</p> <p>Stopped By: Completion of restore operation.</p> <p>Debug Log: tar . log on the client.</p>
TAR32	<p>On Windows clients, the TAR32 program is a special version of tar provided with NetBackup and used to restore images.</p> <p>Started By: For each restore, NetBackup starts an instance of TAR32 on the client.</p> <p>Stopped By: Completion of restore operation.</p> <p>Debug Log: TAR . LOG in the NetBackup logs directory on the client.</p>
xbp	<p>Graphical display based client-user interface, on UNIX clients, with options for starting user-directed backups, restores, and archives. Functionally, it is very similar to the menu version, bp.</p> <p>Started By: /usr/openv/netbackup/bin/xbp command on the client.</p> <p>Stopped By: Quit option in xbp.</p> <p>Debug Log: None, although the log for the bpbackup, bparchive, bplist, and bprestore commands on the client may also be useful for debugging problems with xbp.</p>

NetBackup Databases

The table below, “[NetBackup Databases](#)”, describes the NetBackup databases. These databases contain information that is used internally by NetBackup and reside in the `/usr/opensv/netbackup/db` directory on UNIX servers and in the `install_path\NetBackup\db` directory on Windows NetBackup servers.

NetBackup Databases

Database	Contents
config	<p>Configuration information. This database resides on the master server and has three parts:</p> <ul style="list-style-type: none"> <code>policy</code>: Contains information about each NetBackup policy. <code>config</code>: Contains information about global attributes, storage units, and database backups. <code>altnames</code>: Contains information about client names for restores.
error	<p>Error and status information about NetBackup operations. This database resides on the master server and has two parts:</p> <ul style="list-style-type: none"> <code>error</code>: Contains information recorded during backup operations and used in the NetBackup reports. <code>failure_history</code>: Contains daily history of backup errors.
images	<p>Information about the backup images and resides only on the master server. One of the files in the <code>images</code> directory is the <code>file</code> database. The <code>file</code> database is the one that NetBackup accesses when a user browses for files to restore.</p>
jobs	<p>Job information that is used by the NetBackup job monitor (UNIX NetBackup server) and activity monitor (Windows NetBackup server). The Jobs database is on the master server</p>
media	<p>Media related information used by <code>bptm</code>. Each master or media server has a media database with media information for the images stored on that server’s storage units.</p> <p>The media database also has an errors file that contains error history information for media and devices.</p>



Media Manager Functional Description

This section explains the operation of Media Manager software and contains the following discussions:

- ◆ [“Startup Process”](#)
- ◆ [“Media and Device Management Process”](#)
- ◆ [“Shared Storage Option Management Process”](#)
- ◆ [“Barcode Operations”](#)
- ◆ [“Media Manager Components”](#)

Note In this section, the term Media Manager refers to the media and device management software that is part of NetBackup on either a UNIX or Windows NetBackup server.

Startup Process

Media Manager is part of NetBackup but, on UNIX, can also be run independently and used by other applications, such as Storage Migrator. The easiest way to start Media Manager is to initiate all the necessary processes during system startup on all servers that have devices under control of Media Manager.

`ltid` automatically starts other daemons and programs as necessary. The graphic [“Starting Media Manager”](#) shows the Media Manager daemons that should be running after initial startup. In the case of robotic daemons, such as `ts8d` and `rsmd`, the associated robot must also be configured for the daemon to run. See the [“Media Manager Daemons and Programs”](#) table for other ways to start and stop these daemons.

As shown in the figure [“Starting Media Manager”](#), the LMF, TL8, TLH, and TLD, require two types of daemons: robotic and robotic control.

- ◆ Each host with a robotic drive attached must have a robotic daemon. These daemons provide the interface between `ltid` and the robot or, if different drives within a robot can attach to different hosts, the robotic daemon communicates with a robotic-control daemon (see below).
- ◆ Robotic-control daemons centralize the control of robots when drives within a robot can connect to different hosts. A robotic-control daemon receives mount and unmount requests from the robotic daemon on the host to which the drive is attached and then communicates these requests to the robot.

You must know the hosts involved in order to start all the daemons for a robot.

Starting Media Manager

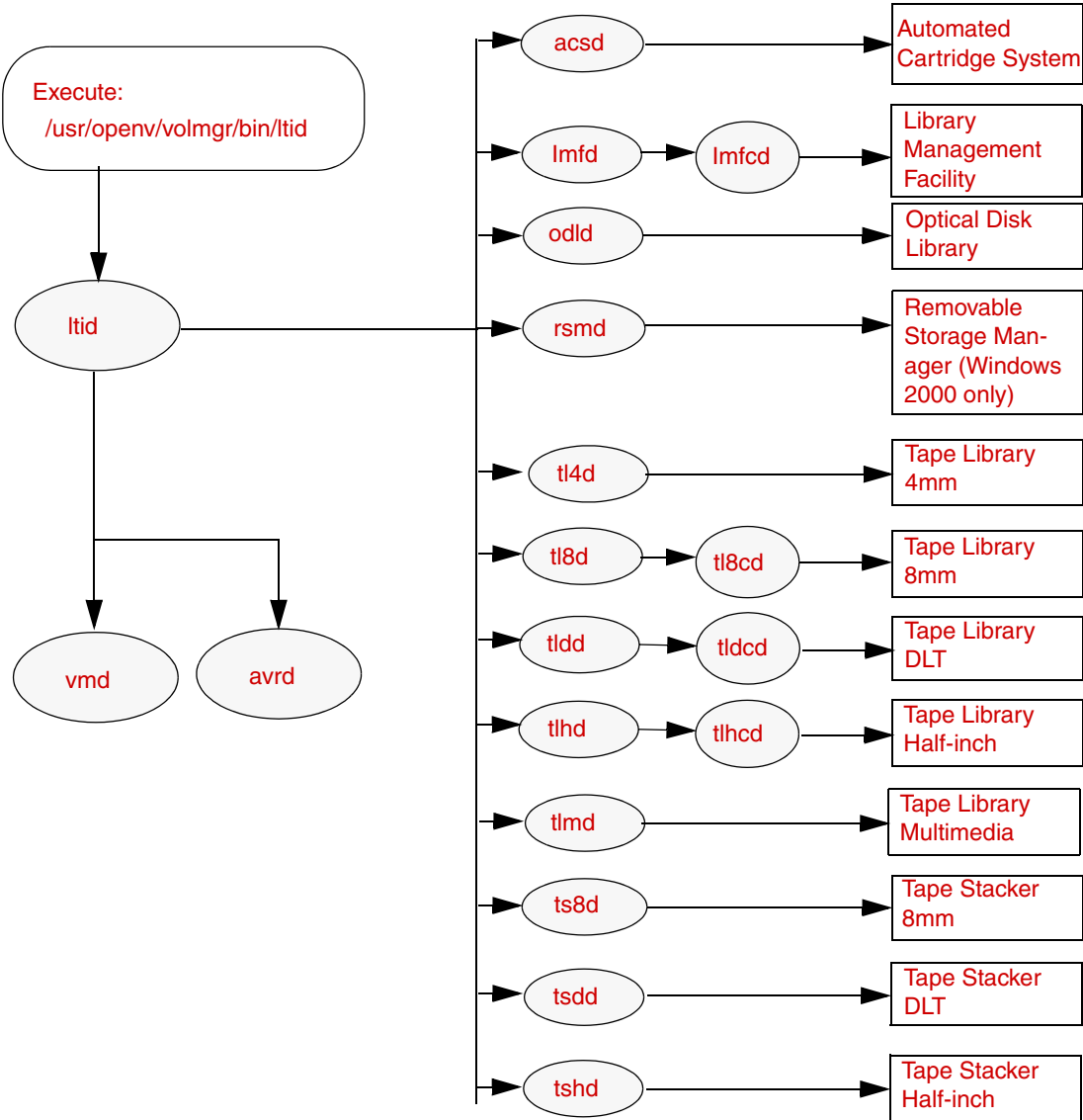

Media and Device Management Process

When the Media Manager daemons are running, NetBackup, Storage Migrator (UNIX only), Storage Migrator for Microsoft Exchange (Windows only), or other users can initiate data storage or retrieval by sending a request for the required media ID to the Media Manager device daemon, `ltid` (see the figure, “[Media and Device Management Example Process](#)”). `ltid` determines the location of the requested media ID by sending a query to the Media Manager volume daemon, `vmid`. The volume daemon then returns the information it has about the media, including: robot number, robot type, host, slot, and barcode.

If the media is in a robot, `ltid` sends a mount request to the robotic daemon that manages the drives in the robot that are configured on the local host. The robotic daemon then chooses an available drive, mounts the media, and sets a drive busy status in memory shared by itself and `ltid`. If it receives another mount request, `ltid` checks that status to determine which (if any) drives are available. Drive busy status also appears in the Device Monitor.

Assuming that the media is physically in the robot, the media is mounted and the operation proceeds. If not a NetBackup backup job and the media is not in the robot, `ltid` sends a mount request, which appears as a pending request in the Device Monitor. An operator must then insert the media in the robot and use the appropriate Device Monitor command to resubmit the request so the mount request can occur. For a NetBackup job, if the media is not in the robot, `ltid` sends a mount request which is then canceled once the media is determined to be missing and another volume is selected to be mounted.

A mount request is also issued if the media is for a nonrobotic (standalone) drive and the drive does not contain media that meets the criteria in the request. If the request is from NetBackup and the drive does contain appropriate media, then that media is automatically assigned and the operation proceeds. See the *NetBackup System Administrator's Guide* for more information on NetBackup media selection for nonrobotic drives.

Note On UNIX systems, when a tape is being mounted, the `drive_mount_notify` script is called. This script is in the `/usr/opensv/volmgr/bin` directory. Information on the script can be found within the script itself. A similar script is called for the unmount process (`drive_unmount_notify`, in the same directory).

When a robotic volume is added or removed through the media access port, the media management utility communicates with the appropriate robotic daemon to verify the volume location and/or barcode. The media management utility (through a library or command-line interface) also calls the robotic daemon for robot inventory operations.

Media and Device Management Example Process

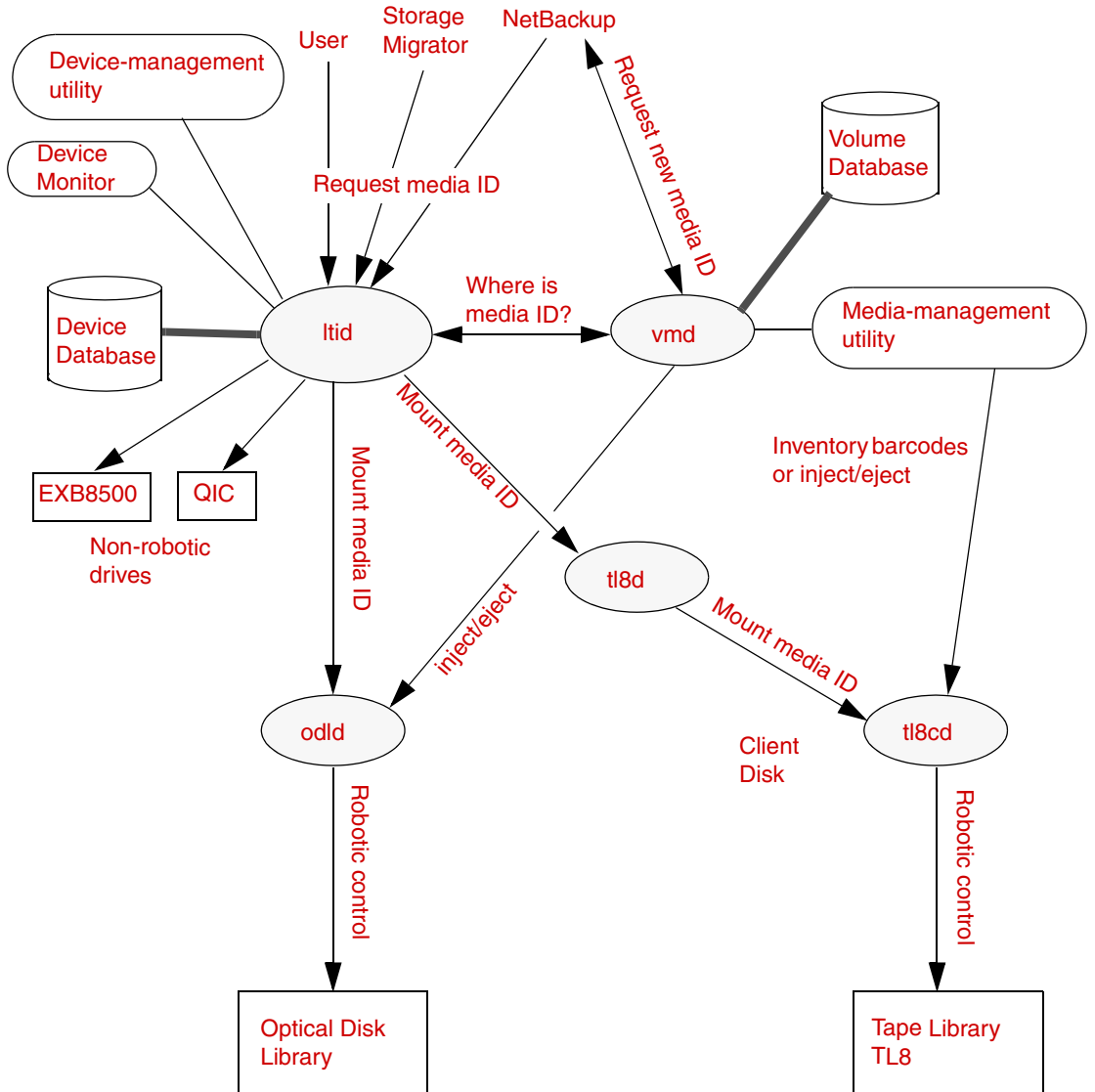

Shared Storage Option Management Process

Shared Storage Option (SSO) is an extension to tape drive allocation and configuration for Media Manager. SSO allows individual tape drives (stand-alone or in a robotic library) to be dynamically shared between multiple NetBackup media servers or SAN media servers. For more information, see the *NetBackup Shared Storage Option System Administrator's Guide*.

Refer to the following figure for a process flow diagram. The diagram includes the case where the robot also has a robotic control daemon, and the example focuses on writes (or backup operations) to media in a robot.

1. NetBackup, Storage Migrator, or other users can initiate backups by sending a request for the required media ID to `ltid`. `ltid` determines the location of the requested media ID by sending a query to `vmd` (`vmd/DA`). `vmd` returns the information it has about the media.
2. For media in robots, `ltid` sends a mount request to the robotic daemon that manages the drives in the robot.
3. The robotic daemon, tracking drives for the local host, sends a request to `ltid`. This request attempts to reserve a targeted shared drive.
4. `ltid` checks its internal tables. If the drive appears to be available, `ltid` sends a reservation request to `vmd/DA`.
5. `vmd/DA` maintains shared drive reservations among all hosts sharing the drive. `vmd/DA` processes the request based on its internal tables.
6. An acknowledgement or an error (as is appropriate) is sent back to the robotic daemon.
7. The mount media operation is initiated.
8. `bptm` performs the following tasks to help protect the integrity of the write operation:
 - SCSI reserve/release is used.
 - Position checks are done on the drive to ensure that the drive has not been rewound by another application.

`bptm` also does the actual write to the tape.

Media and Device Management Process Flow Showing SSO Components

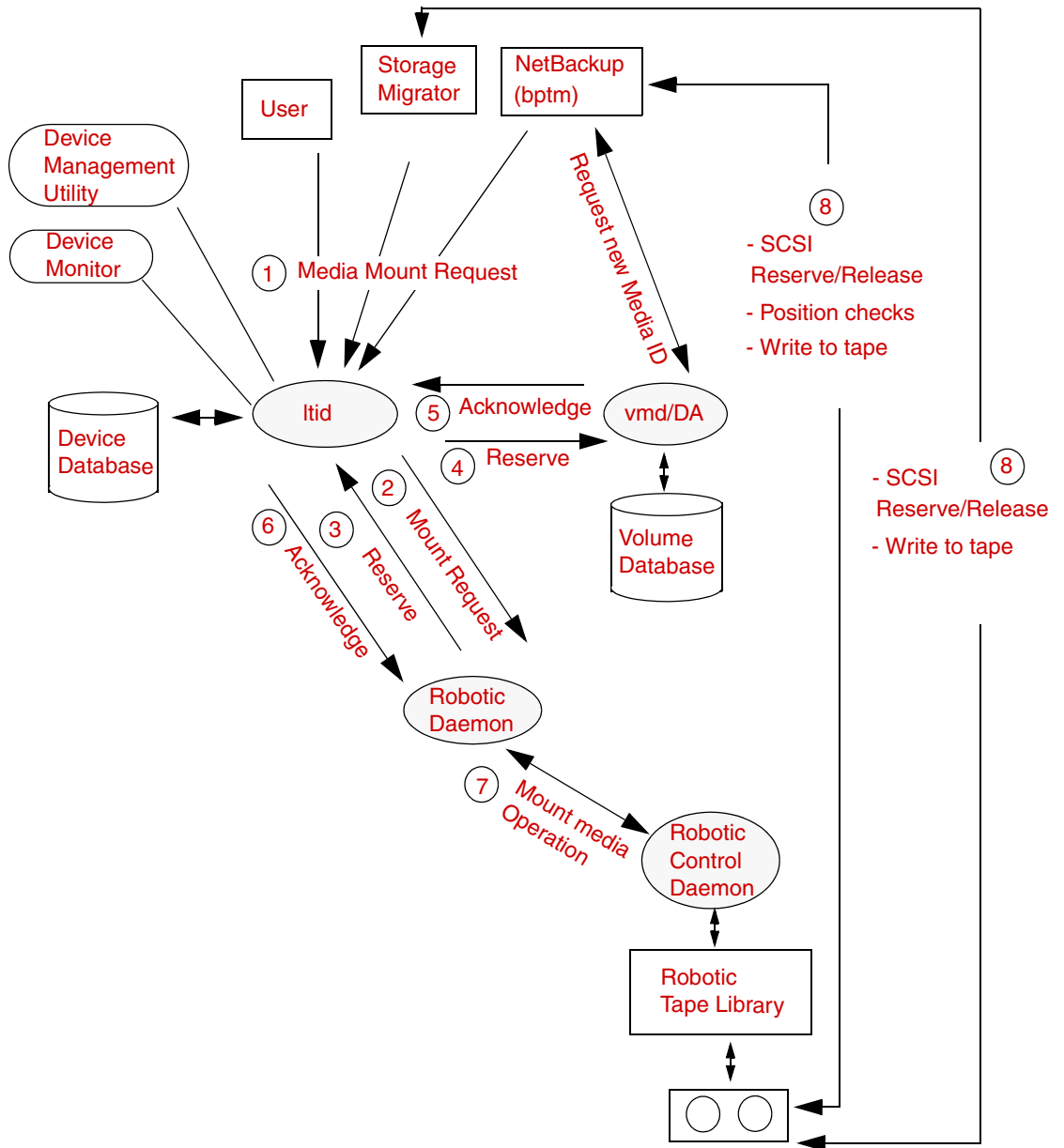

Barcode Operations

Barcode reading is mainly a function of the robot hardware rather than Media Manager. When a robot has a barcode reader, it scans any barcode that may be on a tape and stores the code in its internal memory. This associates the slot number and the barcode of the tape in that slot. Media Manager determines that association for its own use by interrogating the robot.

If a robot supports barcodes, Media Manager automatically compares a tape's barcode to what is in the volume database as an extra measure of verification before mounting the tape.

Media Requests Involving Barcodes

A request for media that is in a robot that can read barcodes begins in the same manner as other requests (see the [“Barcode Request”](#) figure). The Media Manager device daemon, `ltid`, determines the location of the requested media ID by querying the Media Manager volume daemon, `vmid`. The volume daemon then returns the information it has about the media, including: robot number, robot type, host, slot, and barcode.

`ltid` includes the media ID and location information in a mount request to the robotic daemon for the robot that has the media ID. This request causes the robotic daemon to query the robotic-control daemon or the robot for the barcode of the tape in the designated slot. (This is a preliminary check to see if the correct media is in the slot). The robot returns the barcode value it has in memory. The robotic daemon compares this barcode with the value it received from `ltid` and takes one of the following actions.

- ◆ If the barcodes don't match, and the mount request is not for a NetBackup backup job, the robotic daemon informs `ltid` and a pending action request (Misplaced Tape) appears in the Device Monitor. An operator must then insert the correct tape in the slot.
- ◆ If the barcodes don't match and the mount request is for a NetBackup backup job, the robotic daemon informs `ltid` and the mount request is canceled. NetBackup (`bptm`) then selects another volume to mount.
- ◆ If the barcodes match, the robotic daemon requests the robot to move the tape to a drive. The robot then mounts the tape. At the start of the operation, the application (for example, NetBackup) checks the media ID and if it also matches what should be in this slot, the operation proceeds. For NetBackup, a wrong media ID results in a “media manager found wrong tape in drive” error (NetBackup status code 93).

Barcode Request

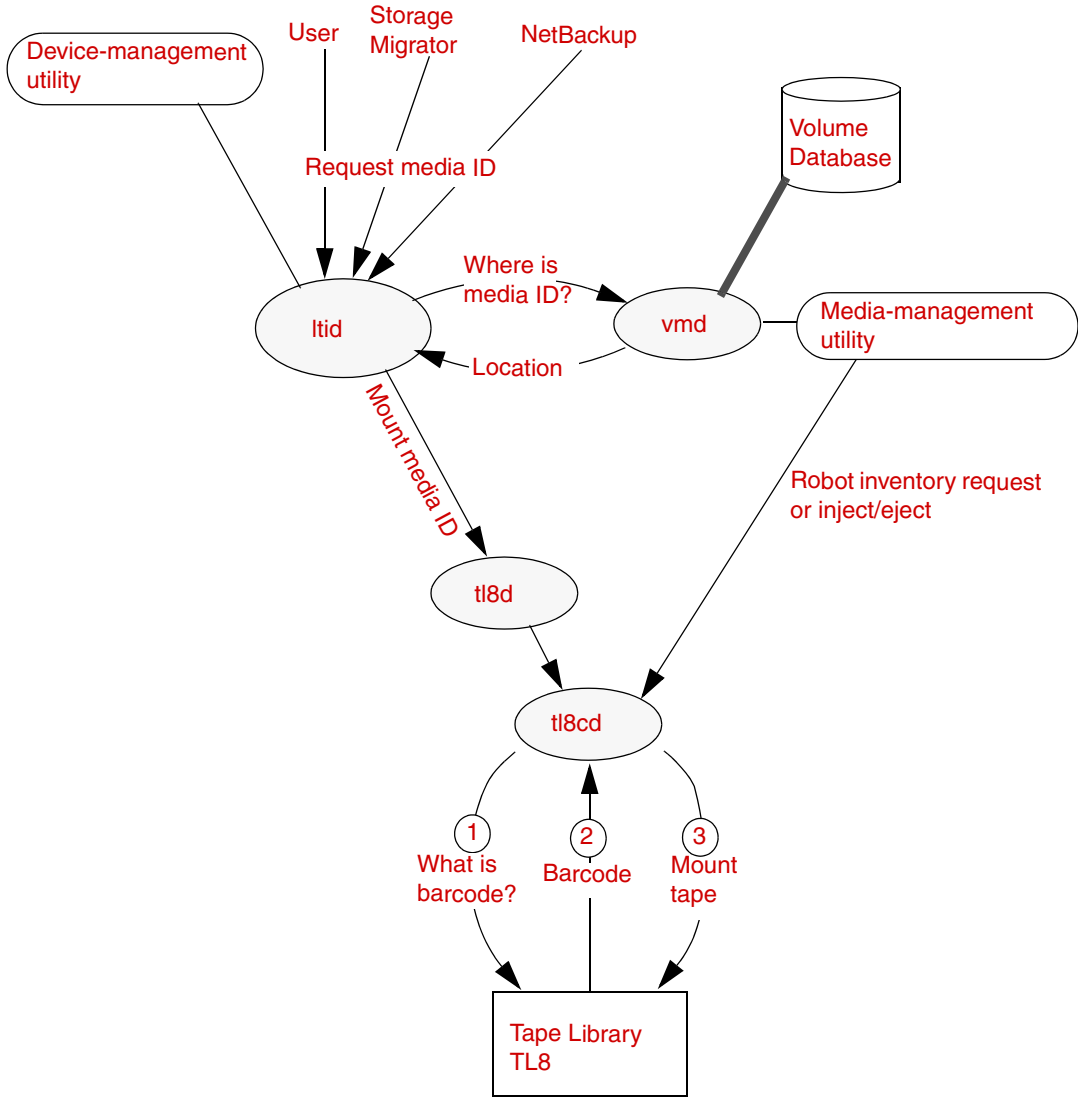

Media Manager Components

Media Manager Directories and Files

The “[Media Manager Directories and Files](#)” figure shows the file and directory structure for Media Manager on a UNIX server. A Windows NetBackup server has equivalent files and directories that are located in the directory where NetBackup is installed (C:\Program Files\VERITAS by default).

The “[Media Manager Directories and Files](#)” table describes the directories and files that are of special interest.

Media Manager Directories and Files

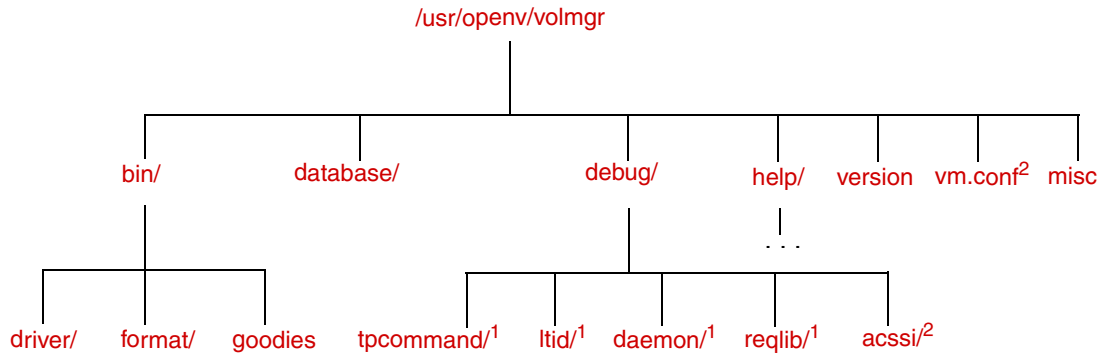

1 Created by administrator to enable debug logging.

2 Created by administrator or automatically by media management utilities.



Caution *DO NOT* under any circumstances attempt to modify the Media Manager databases. These files are for internal program use only and changing them will result in program failure and possible loss of data. It is also recommended that they not be moved to another host.

Media Manager Directories and Files

File or Directory	Contents
bin	<p>Commands, scripts, programs, daemons, and files required for Media Manager operation and administration. There are three subdirectories under bin.</p> <p>driver: Contains SCSI drivers used on various platforms to control robotics.</p> <p>format: Disk format information for optical platters on Solaris platforms.</p> <p>goodies: Contains vmconf script and scan utility.</p>
database	<p>Media Manager databases contain information about the drives, robots, and media that are under Media Manager control.</p> <p>The volume database that usually resides on the master server contains volume information for multiple media servers.</p>
debug	<p>Debug logs for the Media Manager volume daemon, vmd, and all requesters of vmd, ltid, and device configuration. The administrator must create these directories for debug logging to occur.</p>
help	<p>Help files used by Media Manager programs. These files are in ASCII format.</p>
version	<p>Version and release date of the software.</p>
vm.conf	<p>Media manager configuration options.</p>
misc	<p>Lock files and temporary files required by various components of Media Manager.</p>



Programs and Daemons

The “[Media Manager Daemons and Programs](#)” table describes the Media Manager programs and daemons. The explanations include what starts and stops the program or daemon, and the log (if any) where it records its activities. On UNIX, all of the components discussed in this table reside under `/usr/opensv/volmgr/bin`. On Windows, they reside under `install_path\volmgr\bin`.

Note The following table contains references to the system log. This log is managed by `syslog` on UNIX (the facility is `daemon`). On Windows the Event Viewer manages the system log (the log type is `Application`).

Media Manager Daemons and Programs

Program/ Daemon	Description
<code>acsd</code>	<p>The Automated Cartridge System daemon interfaces with the Automated Cartridge System and communicates with the server that controls the ACS robotics through the <code>acsssi</code> process (UNIX) or the STK Libattach Service (Windows). Also, for UNIX see the <code>acsssi</code> and <code>acsse1</code> programs.</p> <p>Started By: Starting <code>ltid</code> (or on UNIX, independently by using the <code>/usr/opensv/volmgr/bin/acsd</code> command).</p> <p>Stopped By: Stopping <code>ltid</code> (or on UNIX, independently by finding the PID (process id) and then using the <code>kill</code> command).</p> <p>Debug Log: All errors are logged in the system log. Debug information is included by adding <code>VERBOSE</code> to the Media Manager configuration file, <code>vm.conf</code>. On UNIX, debug information is also included by starting the daemon with the <code>-v</code> option (either by itself or through <code>ltid</code>) or by putting <code>VERBOSE</code> in the <code>vm.conf</code> file.</p>
<code>acsse1</code>	Available only on UNIX. See the <i>Media Manager System Administrator's Guide</i> (UNIX or Windows) for details.
<code>acsssi</code>	Available only on UNIX. See the <i>Media Manager System Administrator's Guide</i> (UNIX or Windows) for details.

Media Manager Daemons and Programs (continued)

Program/ Daemon	Description
avrd	<p>The automatic-volume-recognition daemon controls automatic volume assignment and label scanning. This lets Media Manager read labeled tape and optical disk volumes and to automatically assign the associated removable media to requesting processes.</p> <p>Started By: Starting <code>ltid</code> (or on UNIX, independently by using the <code>/usr/opensv/volmgr/bin/avrd</code> command).</p> <p>Stopped By: Stopping <code>ltid</code>, (or on UNIX, independently by finding the PID (process id) and then using the <code>kill</code> command).</p> <p>Debug Log: All errors are logged in the system log. Debug information is included by adding <code>VERBOSE</code> to the Media Manager configuration file, <code>vm.conf</code>. On UNIX, debug information is also included by aborting <code>avrd</code> and starting the daemon with the <code>-v</code> option.</p>
lmfd	<p>The Library Management Facility daemon works in conjunction with <code>lmfcd</code> to handle requests to robots controlled by a Fujitsu Library Management Facility (LMF). <code>lmfd</code> provides the interface between the local <code>ltid</code> and the robotic control (<code>lmfcd</code>) in the same manner as explained later for <code>tl8d</code>. This robot is only available on Solaris.</p> <p>Started By: Starting <code>ltid</code> (or independently by using the <code>/usr/opensv/volmgr/bin/lmfd</code> command).</p> <p>Stopped By: Stopping <code>ltid</code> or independently by finding the PID (process id) and then using the <code>kill</code> command).</p> <p>Debug Log: All errors are logged in the system log. Debug information is included if the daemon is started with the <code>-v</code> option (either by itself or through <code>ltid</code>) or by adding <code>VERBOSE</code> to the <code>vm.conf</code> file.</p>
ltid	<p>The device demon (UNIX) or NetBackup Device Manager service (Windows) controls the reservation and assignment of tapes and optical disks.</p> <p>Started By: <code>/usr/opensv/volmgr/bin/ltid</code> command on UNIX or Stop/Restart Device Manager Service command in Media and Device Management window on Windows.</p> <p>Stopped By: <code>/usr/opensv/volmgr/bin/stopltid</code> command on UNIX or Stop/Restart Device Manager Service command in the Media and Device Management window on Windows.</p> <p>Debug Log: All errors are logged in the system log. Debug information is included if the daemon is started with the <code>-v</code> option (available only on UNIX) or adding <code>VERBOSE</code> to the <code>vm.conf</code> file.</p>



Media Manager Daemons and Programs (continued)

Program/ Daemon	Description
odld	<p>The Optical Disk Library daemon interfaces with the Optical Disk Library, communicating with the robotics through a SCSI interface. This library is not supported on Windows.</p> <p>Started By: Starting <code>ltid</code> or independently by using the <code>/usr/opensv/volmgr/bin/odld</code> command.</p> <p>Stopped By: Stopping <code>ltid</code> or independently by finding the PID (process id) and then using the <code>kill</code> command.</p> <p>Debug Log: All errors are logged in the system log. Debug information is included if the daemon is started with the <code>-v</code> option (either by itself or through <code>ltid</code>) or adding <code>VERBOSE</code> to the <code>vm.conf</code> file.</p>
rsmd	<p>The Removable Storage Manager daemon is the interface between <code>ltid</code> and the Microsoft Windows 2000 Removable Storage Manager (RSM) interface. The <code>rsmd</code> daemon runs only on Windows 2000 systems; note that the system must have drives configured in RSM robots configured in the Media Manager interface.</p> <p>Started By: Starting <code>ltid</code> on Windows 2000 only.</p> <p>Stopped By: Stopping <code>ltid</code> on Windows 2000 only.</p> <p>Debug Log: All errors are logged in the system log. Debug information is included in the system log as notifications.</p>
tl4d	<p>The Tape Library 4MM daemon is the interface between <code>ltid</code> and the Tape Library 4MM and communicates with the robotics through a SCSI interface.</p> <p>Started By: Starting <code>ltid</code> (or on UNIX, independently by using the <code>/usr/opensv/volmgr/bin/tl4d</code> command).</p> <p>Stopped By: Stopping <code>ltid</code> (or on UNIX, independently by finding the PID (process id) and then using the <code>kill</code> command).</p> <p>Debug Log: All errors are logged in the system log. Debug information is included by adding <code>VERBOSE</code> to the Media Manager configuration file, <code>vm.conf</code>. On UNIX, debug information is also included by starting the daemon with the <code>-v</code> option (either by itself or through <code>ltid</code>).</p>

Media Manager Daemons and Programs (continued)

Program/ Daemon	Description
t18d	<p>The Tape Library 8MM daemon drives in the same TL8 robot may be attached to different hosts than the robotic control. t18d is the interface between the local ltid and the robotic control. If a host has a device path for a drive in a TL8 robot, then mount or unmount requests for that drive go first to the local ltid and then to the local t18d (all on the same host). t18d then forwards the request to t18cd on the host that is controlling the robot (could be on another host).</p> <p>Started By: Starting ltid (or on UNIX, independently by using the /usr/opensv/volmgr/bin/t18d command).</p> <p>Stopped By: Stopping ltid (or on UNIX, independently by finding the PID (process id) and then using the kill command).</p> <p>Debug Log: All errors are logged in the system log. Debug information is included by adding VERBOSE to the Media Manager configuration file, vm.conf. On UNIX, debug information is also included by starting the daemon with the -v option (either by itself or through ltid).</p>
t18cd	<p>The Tape Library 8MM Control daemon provides the robotic control for a TL8 robot and communicates with the robotics through a SCSI interface. t18cd receives mount and unmount requests from t18d on the host to which the drive is attached and then communicates these requests to the robot.</p> <p>Started By: Starting ltid (or on UNIX, independently by using the /usr/opensv/volmgr/bin/t18cd command).</p> <p>Stopped By: Stopping ltid or by using the t18cd -t command.</p> <p>Debug Log: All errors are logged in the system log. Debug information is included by adding VERBOSE to the Media Manager configuration file, vm.conf. On UNIX, debug information is also included by starting the daemon with the -v option (either by itself or through ltid).</p>
t1dd	<p>The Tape Library DLT daemon works in conjunction with t1dcd to handle requests to TLD robots. t1dd provides the interface between the local ltid and the robotic control (t1dcd) in the same manner as explained previously for t18d.</p> <p>Started By: Starting ltid (or on UNIX, independently by using the /usr/opensv/volmgr/bin/t1dd command).</p> <p>Stopped By: Stopping ltid (or on UNIX, independently by finding the PID (process id) and then using the kill command).</p> <p>Debug Log: All errors are logged in the system log. Debug information is included by adding VERBOSE to the Media Manager configuration file, vm.conf. On UNIX, debug information is also included by starting the daemon with the -v option (either by itself or through ltid).</p>



Media Manager Daemons and Programs (continued)

Program/ Daemon	Description
<code>tlcdc</code>	<p>The Tape Library DLT Control daemon provides robotic control for a TLD robot in the same manner as explained previously for <code>tl8cd</code>.</p> <p>Started By: Starting <code>ltid</code> (or on UNIX, independently by using the <code>/usr/opensv/volmgr/bin/tlcdc</code> command).</p> <p>Stopped By: Using the <code>tlcdc -t</code> command. Stopping <code>ltid</code> or by using the <code>tlcdc -t</code> command.</p> <p>Debug Log: All errors are logged in the system log. Debug information is included by adding <code>VERBOSE</code> to the Media Manager configuration file, <code>vm.conf</code>. On UNIX, debug information is also included by starting the daemon with the <code>-v</code> option (either by itself or through <code>ltid</code>).</p>
<code>tlhd</code>	<p>The Tape Library Half-inch daemon works in conjunction with <code>tlhcd</code> to handle requests to TLH robots that are in an IBM Automated Tape Library (ATL). <code>tlhd</code> provides the interface between the local <code>ltid</code> and the robotic control (<code>tlhcd</code>) in the same manner as explained previously for <code>tl8d</code>.</p> <p>Started By: Starting <code>ltid</code> (or on UNIX, independently by using the <code>/usr/opensv/volmgr/bin/tlhd</code> command).</p> <p>Stopped By: Stopping <code>ltid</code> (or on UNIX, independently by finding the PID (process id) and then using the <code>kill</code> command).</p> <p>Debug Log: All errors are logged in the system log. Debug information is included by adding <code>VERBOSE</code> to the Media Manager configuration file, <code>vm.conf</code>. On UNIX, debug information is also included by starting the daemon with the <code>-v</code> option (either by itself or through <code>ltid</code>).</p>
<code>tlhcd</code>	<p>The Tape Library Half-inch Control daemon provides robotic control for a TLH robot that is in an IBM Automated Tape Library (ATL) in a similar manner to that which was explained previously for <code>tl8cd</code>.</p> <p>Started By: Starting <code>ltid</code> (or on UNIX, independently by using the <code>/usr/opensv/volmgr/bin/tlhcd</code> command).</p> <p>Stopped By: Stopping <code>ltid</code> or by using the <code>tlhcd -t</code> command.</p> <p>Debug Log: All errors are logged in the system log. Debug information is included if the daemon is started with the <code>-v</code> option (either by itself or through <code>ltid</code>). The <code>-v</code> option is available only on UNIX. Also, add the <code>VERBOSE</code> option to the <code>vm.conf</code> file.</p>

Media Manager Daemons and Programs (continued)

Program/ Daemon	Description
tlmd	<p>The Tape Library Multimedia daemon is the interface between <code>ltid</code> and a TLM robot that is in an ADIC Distributed AML Server (DAS). This daemon communicates with the TLM robotics through a network API interface.</p> <p>Started By: Starting <code>ltid</code> or independently by using the <code>/usr/opensv/volmgr/bin/tlmd</code> command.</p> <p>Stopped By: Stopping <code>ltid</code> or independently by finding the PID (process id) and then using the <code>kill</code> command.</p> <p>Debug Log: All errors are logged in the system log. Debug information is included if the daemon is started with the <code>-v</code> option (either by itself or through <code>ltid</code>). The <code>-v</code> option is available only on UNIX. Also, add the <code>VERBOSE</code> option to the <code>vm.conf</code> file.</p>
tpconfig	<p><code>tpconfig</code> is a command line interface or interactive administrator utility for configuring devices under Media Manager. The graphical user interfaces provide equivalent functionality.</p> <p>Started By: <code>tpconfig</code> command.</p> <p>Stopped By: Quit option from within the utility on UNIX. On Windows, <code>tpconfig</code> is only a command-line interface that runs to completion (no quit option).</p> <p>Debug Log: None</p>
tsdd	<p>The Tape Stacker DLT daemon is the interface between <code>ltid</code> and the DLT tape stacker and communicates with the robotics through a SCSI interface.</p> <p>Started By: Starting <code>ltid</code> (or on UNIX, independently by using the <code>/usr/opensv/volmgr/bin/tsdd</code> command).</p> <p>Stopped By: Stopping <code>ltid</code> (or on UNIX, independently by finding the PID (process id) and then using the <code>kill</code> command).</p> <p>Debug Log: All errors are logged in the system log. Debug information is included by adding <code>VERBOSE</code> to the Media Manager configuration file, <code>vm.conf</code>. On UNIX, debug information is also included by starting the daemon with the <code>-v</code> option (either by itself or through <code>ltid</code>).</p>



Media Manager Daemons and Programs (continued)

Program/ Daemon	Description
tshd	<p>The Tape Stacker Half-inch daemon is the interface between <code>ltid</code> and the half-inch-cartridge stacker and communicates with the robotics through a SCSI interface. This robot is not supported on Windows.</p> <p>Started By: Starting <code>ltid</code> (or on UNIX, independently by using the <code>/usr/opensv/volmgr/bin/tshd</code> command).</p> <p>Stopped By: Stopping <code>ltid</code> (or on UNIX, independently by finding the PID (process id) and then using the <code>kill</code> command).</p> <p>Debug Log: All errors are logged in the system log. Debug information is included by adding <code>VERBOSE</code> to the Media Manager configuration file, <code>vm.conf</code>. On UNIX, debug information is also included by starting the daemon with the <code>-v</code> option (either by itself or through <code>ltid</code>).</p>
ts8d	<p>The Tape Stacker 8MM daemon is the interface between <code>ltid</code> and the 8-mm Tape Stacker and communicates with the robotics through a SCSI interface.</p> <p>Started By: Starting <code>ltid</code> (or on UNIX, independently by using the <code>/usr/opensv/volmgr/bin/ts8d</code> command).</p> <p>Stopped By: Stopping <code>ltid</code> (or on UNIX, independently by finding the PID (process id) and then using the <code>kill</code> command).</p> <p>Debug Log: All errors are logged in the system log. Debug information is included by adding <code>VERBOSE</code> to the Media Manager configuration file, <code>vm.conf</code>. On UNIX, debug information is also included by starting the daemon with the <code>-v</code> option (either by itself or through <code>ltid</code>).</p>
vmd	<p>The Media Manager volume daemon (NetBackup Volume Manager service on Windows) manages the volume database, provides <code>ltid</code> with the location of requested volumes, keeps track of the number of mounts and last mount time for each volume, and allows remote administration and control of Media Manager.</p> <p>Started By: Starting <code>ltid</code> (or on UNIX, independently by using the Initiate Media Manager Volume daemon option in <code>vmadm</code>)</p> <p>Stopped By: Terminate Media Manager Volume Daemon option in <code>vmadm</code>).</p> <p>Debug Log: System log and also a debug log if the daemon or <code>reqlib</code> debug directories exist (see “Debug Logs” on page 66).</p>

Media Manager Daemons and Programs (continued)

Program/ Daemon	Description
vmadm	<p data-bbox="444 317 1206 435">Available only on UNIX. An administrator utility with options for configuring and managing volumes under control of Media Manager. It has a menu-driven, character-based interface that can be used from workstations that do not have graphical display capabilities.</p> <p data-bbox="444 440 1076 470">Started By: <code>/usr/opensv/volmgr/bin/vmadm</code> command</p> <p data-bbox="444 477 958 506">Stopped By: Quit option from within the utility.</p> <p data-bbox="444 513 1012 543">Debug Log: <code>/usr/opensv/volmgr/debug/reqlib</code></p>



Networks and Hostnames

B

In a configuration with multiple networks and clients with more than one hostname, the NetBackup administrator must configure the policy entries carefully, at all times considering the network configuration (physical, hostnames and aliases, NIS/DNS, routing tables, and so on). This is especially true if the desire is to direct backup and restore data across specific network paths.

For a backup, NetBackup connects to the host name as configured in the policy. The operating system's network code resolves this name and sends the connection across the network path defined by the system's routing tables. The `bp.conf` file is not a factor in determining this.

For restores from the client, the client connects to the master server. For example, on a UNIX system, the master server is the first one named in the `/usr/opensv/netbackup/bp.conf` file. On a Windows system, the master server is specified on the **Servers** tab of the Specify NetBackup Machines and Policy Type dialog box (to open this dialog, start the NetBackup client user interface and click **Specify NetBackup Machines and Policy Type** on the **File** menu). The network path to the server is determined by the client's network code that maps the server name to an IP address.

Upon receipt of the connection, the server determines the client's configured name from the *peername* of its connection to the server.

The peername is derived from the IP address of the connection. This means that the address must translate into a host name (using the `gethostbyaddr()` network routine). This name is visible in the `bprd` debug log when a connection is made as in the line:

```
Connection from host peername ipaddress ...
```

The client's configured name is then derived from the *peername* by querying the `bpdbm` process on UNIX systems, or the NetBackup Database Manager service on Windows systems.

The `bpdbm` process compares the peername to a list of client names generated from:

1. All clients for which a backup has been attempted
and
2. All clients in all policies



The comparison is first a simple string comparison which, if successful, is verified by comparing hostnames and aliases retrieved by using the network function `gethostbyname()`.

If none of the comparisons succeed, a more brute force method is used, which compares all names and aliases using `gethostbyname()`.

The configured name is the first comparison that succeeds. Note that other comparisons might also have succeeded if aliases or other “network names” are configured.

If the comparison fails, the client’s hostname as returned by the `gethostname()` function on the client is used as the configured name. One example of why the comparison could fail is the case where the client had changed its hostname but its new hostname is not reflected in any policies yet.

These comparisons are logged in the `bpdbm` debug log if `VERBOSE` is set. You can determine a client’s configured name by using the `bpclntcmd` command on the client. For example:

```
# /usr/opencv/netbackup/bin/bpclntcmd -pn (UNIX)
# install_path\NetBackup\bin\bpclntcmd -pn (Windows)

expecting response from server wind.abc.me.com
danr.abc.me.com danr 194.133.172.3 4823
```

Where the first output line identifies the server to which the request is directed and the second output line is the server’s response in the following order:

- ◆ Peername of the connection to the server
- ◆ Configured name of the client
- ◆ IP address of the connection to the server
- ◆ Port number used in the connection

When the client connects to the server, it sends three names to the server:

- ◆ *browse client*
- ◆ *requesting client*
- ◆ *destination client*

The *browse client* name is used to identify the client files to list or restore from. The user on the client can modify this name to restore files from another client. For example, on a Windows client, the user can change the client name by using the client user interface (see the user’s guide for instructions). For this to work, however, the administrator must also have made a corresponding change on the server. For more information, refer to the *NetBackup System Administrator’s Guide*.

The *requesting client* is the value from the `gethostname()` function on the client.

The *destination client* name is a factor only if an administrator is pushing a restore to a client from a server. For a user restore, *destination client* and *requesting client* are the same. For an administrator restore, the administrator can specify a different name for the destination client.

By the time these names appear in the `bprd` debug log, the requesting client name has been translated into the client's configured name.

Depending on the particulars of the restore request (for example, from root on a server, from a client, to a different client, and so on), the name used to connect back to the client to complete the restore is either the client's peername or its configured name.

When modifying client names in NetBackup policies to accommodate specific network paths, the administrator needs to consider:

- ◆ The client name as configured on the client. For example, on UNIX this is `CLIENT_NAME` in the client's `bp.conf` file. On a Windows client, it is on the **General** tab of the NetBackup Client Properties dialog box. To open this dialog box, select **NetBackup Client Properties** from the **File** menu in the Backup, Archive, and Restore interface.
- ◆ The client as currently named in the policy configuration.
- ◆ Existing client backup and archive images as recorded in the `images` directory on the master server. On a UNIX server, this is the `/usr/opensv/netbackup/db/images` directory. On a Windows NetBackup server this is the `install_path\NetBackup\db\images` directory.

All of the above can require manual modification by the administrator if a client has multiple network connections to the server and restores from the client fail due to a connection-related problem.

On UNIX, the public domain program `traceroute` (not included with NetBackup) often can provide valuable information about a network's configuration. Some system vendors include this program with their systems.

If Domain Name Services are used and the (possibly unqualified) name that the NetBackup client obtains through its `gethostname()` library (UNIX) or `gethostbyname()` network (Windows) function is unknown to the Domain Name Service (DNS) on the master server, the master server can be unable to reply to client requests. Whether this situation exists, depends on how the client and the server are configured. If `gethostname()` or `gethostbyname()` on the client returns host names that are not qualified to the extent that DNS on the master server can resolve them, then you will encounter problems.

Although a possible solution is to reconfigure the client or the master server DNS hosts file, this is not always desirable. For this reason, NetBackup provides a special file on the master server. This file is:

```
/usr/opensv/netbackup/db/altnames/host.xlate (UNIX)
```



install_path\NetBackup\db\altnames\host.xlate (Windows)

You can create and edit this file to force the desired translation of NetBackup client host names.

Each line in the *host.xlate* file has three elements: a numeric key and two hostnames. Each line is left-justified, and each element of the line is separated by a space character.

key hostname_from_client client_as_known_by_server

Where

- ◆ *key* is a numeric value used by NetBackup to specify the cases where the translation is to be done. Currently this value must always be 0, indicating a configured name translation.
- ◆ *hostname_from_client* is the value to translate. This must correspond to the name that is obtained by the client's `gethostname()` function and sent to the server in the request.
- ◆ *client_as_known_by_server* is the name to substitute for *hostname_from_client* when responding to requests. This name must be the name configured in the NetBackup configuration on the master server and must also be known to the master server's network services.

For example, the line

```
0 danr danr.eng.aaa.com
```

specifies that when the master server receives a request for a configured client name (numeric key 0), the name *danr* is always replaced by the name *danr.eng.aaa.com*. This resolves the problem mentioned above, assuming that:

- ◆ The client's `gethostname()` function returned *danr*.
- ◆ The master server's network services `gethostbyname()` function did not recognize the name *danr*.
- ◆ The client was configured and named in the NetBackup configuration as *danr.eng.aaa.com* and this name is also known to network services on the master server.

Robotic Test Utilities



Each of the robotic software packages includes a robotic test utility for communicating directly with robotic peripherals. The tests are for diagnostic purposes and the only documentation is the online help that you can view by entering a question mark (?) after starting the utility. Specify `-h` to display the usage message.

Note Do not use the robotic test utilities when backups or restores are active. The tests lock the robotic control path and prevent the corresponding robotic software from performing actions, such as loading and unloading media. If a mount is requested, the corresponding robotic process times out and goes to the DOWN state. This usually results in a media mount timeout. Also, be certain to quit the utility when your testing is complete.

Robotic Tests on UNIX

If the robot has been configured (that is, added to the Media Manager device database), start the robotic test utility by using the `robtest` command. This saves time, since robotic and drive device paths are passed to the test utility automatically. The procedure is as follows:

▼ **To use the `robtest` command**

1. Execute the following command:

```
/usr/openv/volmgr/bin/robtest
```

The test utility menu appears.

2. Select a robot and press Enter.

The test starts.

If the robot is not configured, you cannot use `robtest` and must execute the command that applies to the robot you are testing.

ACS



```
/usr/opensv/volmgr/bin/acstest -r ACSL_HOST
```

LMF

```
/usr/opensv/volmgr/bin/lmftest -r robotic_library_name
```

ODL

```
/usr/opensv/volmgr/bin/odltest -r roboticpath
```

TL4

```
/usr/opensv/volmgr/bin/tl4test -r roboticpath
```

TL8

```
/usr/opensv/volmgr/bin/tl8test -r roboticpath
```

TLD

```
/usr/opensv/volmgr/bin/tldtest -r roboticpath
```

TLH

```
/usr/opensv/volmgr/bin/tlhstest -r robotic_library_path
```

TLM

```
/usr/opensv/volmgr/bin/tlmtest -r DAS_Hostname
```

TS8

```
/usr/opensv/volmgr/bin/ts8test -r roboticpath
```

TSD

```
/usr/opensv/volmgr/bin/tsdtest -r roboticpath
```

TSH

```
/usr/opensv/volmgr/bin/tshtest -r roboticpath
```

Note For more information on ACS, TLH, LMF, and TLM robotic control, see the appendixes in the *NetBackup Media Manager System Administrator's Guide for UNIX*.

In the above commands, *roboticpath* is the full path to the device file for the robotic control (SCSI). Refer to the *Media Manager Device Configuration Guide* and review the chapter for your platform to find the appropriate value for *roboticpath*.

There is also an optional parameter that specifies the device file path for the drive(s) so that SCSI unloading of the drive(s) can be done with this utility.

Robotic Tests on Windows

If the robot has been configured (that is, added to the Media Manager device database), start the robotic test utility by using the `robtest` command. This saves time, since robotic and drive device paths are passed to the test utility automatically. The procedure is as follows:

▼ To use the `robtest` command

1. Execute the following command:

```
install_path\Volmgr\bin\robtest.exe
```

The test utility menu appears.

2. Select a robot and press Enter.

The test starts.

Note If the robot is not configured, you cannot use `robtest` and must execute the command that applies to the robot you are testing (see below). However, in the case of an RSM robot, the robot *must* be configured under NetBackup before a test can be run. When the RSM robot has been configured, use the `robtest` command as described above.

ACS

```
install_path\Volmgr\bin\acstest -r ACSLS_HOST
```

RSM

```
install_path\Volmgr\bin\rsmtest -r robotnumber roboticpath
```

TL4

```
install_path\Volmgr\bin\tl4test -r roboticpath
```

TL8

```
install_path\Volmgr\bin\tl8test -r roboticpath
```

TLD

```
install_path\Volmgr\bin\tldtest -r roboticpath
```

TLH

```
install_path\Volmgr\bin\tlhstest -r robotic_library_name
```

TLM

```
install_path\Volmgr\bin\tlmtest -r DAS_Hostname
```



TS8

```
install_path\Volmgr\bin\ts8test -r roboticpath
```

TSD

```
install_path\Volmgr\bin\tsdtest -r roboticpath
```

Note For more information on ACS, TLH, LMF, and TLM robotic control, see the appendixes in the *NetBackup Media Manager System Administrator's Guide for Windows*.

For more information on RSM robotic control, refer to the *Microsoft Removable Storage Manager (RSM)* appendix in the *NetBackup Media Manager System Administrator's Guide for Windows*.

In the above commands, *roboticpath* is the full path to the device file for the robotic control (SCSI). Refer to the *Media Manager Device Configuration Guide* and review the chapter for your platform to find the appropriate value for *roboticpath*.

There is also an optional parameter that specifies the device file path for the drive(s) so that SCSI unloading of the drive(s) can be done with this utility.

Usage is:

```
install_path <-p port -b bus -t target -l lan | -r roboticpath>
```

where: *roboticpath* is the changer name (e.g., Changer0)

Index

Numerics

3pc.conf file 184

A

accessibility features xii

acssel, description 598

acssi 78

acsssi, description 598

acstest 611, 613

activity logs. *see* debug logs

admin log 67

admincmd, directory 577

administration interface

activity logging 83

errors 81

Advanced Client

pathname length 92

All Log Entries report 65

Allow multiple data streams 114

Alternate client restores

host.xlate file 609

Alternate Read Server 159

altnames file 587

application server status codes (Java interface) 82

asc value 185

ascd, description 598

ascq value 185

associate.bat file 84

audience for manual ix

auto-configuration problems 16

avrd, description 599

B

backup process

files 558

multiplexing 561

NetBackup databases 567

NetWare clients 564

UNIX clients 558

Windows NT/2000 clients 563

Backup Status report 65

backupdbtrace 88

backuptrace 87

base NetBackup license key 119

bin

Media Manager 597

UNIX client 577

BP 575

bp

description 578

log 73

UNIX client log 71

bp log 73

bp.conf file

UNIX client/server 577

BP.NLM 578

bpadm

description 579

bparchive

description 579

log 71, 74

bparchive log 74

bpbackup

description 579

log 71, 74

bpbackup log 74

bpbkar

description 579

log 71, 74

bpbkar and VxFS_Checkpoint 102

bpbkar log 74

BPBKAR32 563, 580

bpbrm

description 579

bpbrm log 67

BPCD 564, 574, 575



- bpcd
 - description 580
 - server log 67
 - UNIX client log 72, 74
- BPCD.NLM 580
- BPCDW32.EXE 580
- bpcntcmd utility 37
- bpdjobs
 - description 581
- bpdjobs log 67
- bpdbm
 - description 581
- bpdbm log 67
- bpdm
 - description 581
- bpdm log 67
- bperror command 91
- bpgetdebuglog 88
- bphdb
 - description 581
 - log 72
- BPINETD 563, 574
- bpinetd log 73
- bpinetd.log 73
- bpjava-msvc 582
- bpjava-msvc log 67, 84
- bpjava-usvc log 84
- bplist
 - description 583
 - log 72, 75
- bplist log 75
- bpmount
 - log 72
- bpmount log 75
- bporaexp log 72
- bporaexp64 log 72
- bporaimp log 72
- bporaimp64 log 72
- bppfi log on client 105
- bprd
 - description 582
- bprd log 67
- bprecover 169, 520, 522, 523, 524, 525, 527, 528, 529, 532, 533, 536, 540, 541, 545, 547, 548, 549, 551, 552
- bprestore
 - description 583
 - log 72, 75
- bprestore log 75

- bpsched
 - description 583
- bpsched log 68
- bpsrv
 - log 75
- bpsrv log 75
- BPSRV.EXE 584
- BPSYS.EXE 584
- bptm
 - description 584
- bptm log 68

C

- cache
 - partition 113
- catalog recovery
 - identify media 545
 - procedure 547
- checkpoint, removing 102
- class database file 587
- Client Backups report 65
- client, NetBackup
 - configured name 607
 - debug logs
 - UNIX clients 71
 - Windows and NetWare clients 73
 - installation problems 14
 - multiple hostnames 607
 - NT disk recovery 542
 - peername 607
 - software location
 - UNIX clients 577
 - testing configuration 21, 24
 - UNIX disk recovery 523
- clone (mirror, removing) 103
- communications problems
 - PC clients 31
 - UNIX clients 27
- compression device 20
- config file 587
- configuration database 587
- configuration device file does not exist 19
- configuration problems 14

D

- daemons
 - Media Manager 598
 - NetBackup 578
 - robotic 588
 - robotic control 588



database directory, Media Manager 597
database extension 555
database recovery
 identify media 525
 procedure 527
databases
 Media Manager
 device 597
 volume 597
 NetBackup
 backup process 567
 description 587
DAYS_TO_KEEP_LOGS 78, 79
db directory, NetBackup 577
debug level 76, 84
debug logs 66, 83
 analysis utilities 85
 NetBackup 597
 vmd 77, 597
debug.properties file 84
define the problem 1
device configuration problems 16
device database 597
directory structure
 Media Manager 596
 NetBackup
 UNIX client/server 576
disk recovery
 master when NT intact 535
 media server 523, 541
 NT client 542
 NT master server 535
 root on master 520
 total on master 538
 UNIX client 523
 UNIX master server 519
DLL patch for VxFS 173
DNS (see Domain Name Service)
Domain Name Service
 hostnames 609
drive
 drive limit exceeded 18
 type not determined 19
drive_mount_notify script 590
drive_unmount_notify script 590
driver directory 597
drives, too many 17
duplicatetrace 89
Duration to Retain Logs 68

E
error codes (see Status codes)
error database 587
evaluation license key 119
Event viewer logging option 79
exception errors in Java admin interface 81
exclude_list
 UNIX client 577
expired license key 119
external mapping files 520, 536, 540

F
failure_history file 587
file database 587
file list
 symbolic link 100
file pathname (max length) 92
files
 archive process 558
 backup process 558
 host.xlate 609
 restore process 570
format directory 597
frozen image
 source
 for symbolic link 100
fsckptadm command 102
functional overview
 introduction 555
 Media Manager
 device management 590
 directories and files 596
 programs and daemons 598
 startup 588
 volume management 590
 NetBackup
 backup and archive 558
 directories and files 576
 programs and daemons 578
 restores 570
 startup 556

G
gethostbyname 222
getpid 223
Global Logging Level 69
Glossary. *See* NetBackup Help.
goodies directory 597
goodies, directory 577



H

- help files
 - Media Manager 597
 - UNIX client 577
- host name entries, checking 34
- host.xlate file 36, 609

I

- IDR 542
- images database 587
- images on Media report 65
- importtrace 89
- include_list
 - UNIX client 577
- inetd 13
- installation
 - Linux 13
- installation problems 13
- Intelligent Disaster Recovery (IDR) 542
- introduction to troubleshooting 1

J

- Java interface
 - debug logging 83
 - troubleshooting background 81
- jbpSA, overview 584, 585
- jobs database 587

K

- Keep Logs for 68
- key value 185

L

- libsfr.so file 97
- license key 119
- license problems 17, 19
- links (in file list) 100
- Linux 13
- lmfs description 599
- lmftest 612
- log (bppfi) 105
- log analysis utilities
 - debug logs 85
 - how to run 87
 - installation 86
 - limitations 87
 - output format 86
- Log level
 - Windows and NetWare clients 76
- Logs
 - debug, enabling detailed 83

- reports, NetBackup 65
- setting retention period 68, 78, 79
- setting verbose level 69

logs

- overview 63
- activity. See debug
- debug, introduction 66
- event viewer logging option 79
- media management 77

PC client activity

- bp 73
- bparchive 74
- bpbackup 74
- bpbkar 74
- bpcd 74
- bpinstd 73
- bplist 75
- bpmount 75
- bprestore 75
- bpsrv 75
- nbwin 75
- tar 75
- user_ops 76

server activity

- admin 67
- bpbrm 67
- bpcd 67
- bpdbjobs 67
- bpdbm 67
- bpdm 67
- bprd 67
- bpsched 68
- bptm 68

setting retention period 68

system 66

UNIX client activity

- bp 71
- bparchive 71
- bpbackup 71
- bpbkar 71
- bpcd 72
- bphdb 72
- bpjava-msvc 67
- bplist 72
- bpmount 72
- bprestore 72
- obackup_tape 72
- tar 73
- user_ops 73



- user progress 66
- logs directory
 - UNIX client/server 577
- ltid 77
- ltid, description 599

M

- mapping files (external) 520, 536, 540
- master server, test procedure 21, 24
- maximum pathname length 92
- Media Contents report 65
- media database 587
- Media List report 65
- Media Log Entries report 65
- Media Manager
 - functional description 588
 - logs 77
- media server, test procedure 24
- Media Summary report 65
- Media Written report 65
- message
 - finding message text from status code 91
- messages, NetBackup 273, 480
- mirror (VxVM snapshot) 100, 101
- mirror snapshot (removing) 103
- misc file 597
- mover.conf file 184
- multiple data streams option 114
- multiplexed backups 561
- multiplexing 112

N

- NBNW95 564
- NBNW95.EXE 586
- NBNWNT 564, 575
- NBNWNT.EXE 586
- NBWIN 563, 574
- nbwin
 - log 75
- nbwin log 75
- NBWIN.EXE 585
- NCVU 85, 90
- ndmpmoveragent, overview 585
- NetBackup Administration Console
 - debug logging 83
 - errors 81
- NetBackup Client service
 - start and stop 12
- NetBackup Configuration Validation Utility 90

- NetBackup Configuration Validation Utility (NCVU) 85
- NetBackup Database Manager service
 - start and stop 12
- NetBackup Device Manager service
 - start and stop 12
- NetBackup Request Manager service
 - start and stop 12
- NetBackup Volume Manager service
 - start and stop 12
- network connections, multiple 607
- network daemon (vnetd) 68
- network problems
 - PC clients 31
 - UNIX clients 27
- Novell
 - values affecting restore 116, 117

O

- obackup_tape log 72
- odld, description 600
- odltest 612
- operating system errors 82
- output, redirect to a file 84

P

- pass-thru not supported 19
- patch for VxFS 173
- patch, troubleshooting 97
- patches (installing during recovery) 520, 536, 540, 543
- pathname length 92
- preliminary troubleshooting procedure 10
- problems report 65
- procedures
 - recovery
 - master when NT intact 535
 - media server disk 523, 541
 - NetBackup catalogs 544
 - NetBackup databases 524
 - NT client disk 542
 - NT master server disk 535
 - root on master 520
 - total on master 538
 - UNIX client disk 523
 - UNIX master server disk 519
- troubleshooting
 - communications problems 26
 - host names and services 34
 - installation and configuration 13



- introduction 9
- master server and clients 21
- media server and clients 24
- preliminary 10
- processes (see functional overview)
- programs
 - Media Manager 598
 - NetBackup 578
- progress logs, user 66

R

- raw partitions
 - backup process 558
 - restore process 570
- recording information 2
- recovery procedures
 - importing media 525, 545
 - master when NT intact 535
 - NetBackup catalogs 544
 - NetBackup databases 524
 - NT client disk 542
 - NT master server disk 535
 - root on master 520
 - server disk 523, 541
 - total on master 538
 - UNIX client disk 523
 - UNIX master server disk 519
- RedHat 13
- redirect output to a file 84
- related manuals xi
- release notes, online copy 578
- removing a snapshot checkpoint 102
- removing a snapshot clone 103
- reports, NetBackup 65
- reqlib 77
- restore
 - problem with sparse file 126
- restore process 570
 - NetWare client 575
 - Windows NT/2000 client 574
- restoretrace 88
- robot
 - drive number unknown 18
 - robot limit exceeded 19
 - type not determined 18
 - unknown 18
- robot drive selection 590
- robotic control daemons 588
- robotic daemons 588

- Robotic test utility
 - RSM robot 613
- robotic test utility 611
 - acstest 611, 613
 - odltest 612
 - tl4test 612, 613
 - tl8test 612, 613
 - tldtest 612, 613
 - tlhstest 613
 - ts8test 612, 614
 - tsdtest 612, 614
 - tshtest 612
- robotic test utilitylmftest 612
- robtest 611, 613
- RSM robot 613
- rsmid, description 600

S

- scheduler, bpsched 68
- serialization problems 16
- server
 - disk recovery 523, 541
 - installation problems 13
 - NetBackup debug logs 66
 - NT disk recovery 535
 - recover master, NT intact 535
 - recovering root on master 520
 - test procedure for master 21, 24
 - test procedure for media server 24
 - total recovery of master 538
 - UNIX disk recovery 519
- services entries, checking 34
- slots, too many 17
- snaplist command 101
- snapoff command 102
- snapshot
 - cache partition 113
 - mirror (VxVM) 100, 101
 - stale 101
- snapshot (removing) 103
- software version, determining
 - Macintosh clients 114
 - Media Manager 597
 - NetWare nontarget clients 114
 - NetWare target clients 114
 - UNIX client/server 578
 - UNIX servers 114
 - Windows clients 114
 - Windows NT servers 114



- sparse files (restore problem) 126
- stale snapshots 101
- startup
 - Media Manager process 588
 - NetBackup 556
- status code
 - finding message from 91
- status codes, NetBackup
 - sorted by code 92
 - sorted by message 273, 480
- stderr 81
- stdout 81
- SuSE 13
- symbolic links 100
- syslogd 66, 77
- system logs 66

T

- tar
 - log 75
- tar log 75
- tar, NetBackup 586
- TAR32 574
- test utility, robotic 611
- third-party copy 184
 - and multiplexing 112
- tl4d, description 600
- tl4test 612, 613
- tl8cd, description 601
- tl8d, description 601
- tl8test 612, 613
- tldd, description 601
- tlctest 612, 613
- tlhcd, description 602
- tlhd, description 602
- tlhtest 613
- tlldcd, description 602
- tlmd, description 603
- tpautoconf 77, 420
- tpcommand 77, 403
- tpconfig 77
- tpconfig, overview 603
- traceroute 609
- troubleshooting procedure
 - communication problems
 - PC clients 31
 - UNIX clients 27
 - general
 - introduction 20

- master server and clients 21, 24
- media server and clients 24
- host name and services entries 34
- installation 13
- preliminary 10
- ts8d, description 604
- ts8test 612, 614
- tsdd, description 603
- tsdtest 612, 614
- tshd, description 604
- tshtest 612

U

- user_ops log 68, 73, 76
- utility, robotic test 611

V

- vault 93
- verbose option 69
- verifytrace 89
- VERITAS NetBackup ix
- VERITAS Volume Manager 100, 101
- version, software (see software version, determining)
- vlteject 222
- vltoffsitemedia 222
- vltopmenu 222, 223
- vltrun 220, 222
- vm.conf file 597
- vmadm, overview 605
- vmd
 - debug logging 77
 - overview 604
- vnetd log 68
- volume database 597
- vxassist command 100, 101, 105
- VxFS file system
 - patch for library routines 173
- VxFS_Checkpoint snapshot 102
- vxprint command 104
- vxvm frozen image method 100, 101
- vxvol command 100, 101

W

- Windows Display Console 84

X

- xbp, overview 586
- xinetd 13
- XML 72

