

IOLAN+, IOLAN+ Rack & IOLAN+ 102/104

User guide

*Part number: 5500054-16
Date: 7 October 2002*

Navigating around this manual



Using this on-line manual. See page 5.



Fast Contents. See page 7.



Contents. See page 8.



The menu interface. See page 125.



Index. See page 224.

Copyright statement

This document must not be reproduced in any way whatsoever, either printed or electronically, without the consent of:

Perle Systems Europe Limited,
3, Wintersells Road,
Byfleet,
Surrey
KT14 7LF,
UK

Perle reserves the right to make changes without further notice, to any products to improve reliability, function or design.

Specialix, the Specialix logo, IOLAN+, IOLAN+ Rack, IOLAN+ 102/104, JETSTREAM, JETSTREAM4000, JETSTREAM8500 and LANSTREAM2000 are trademarks of Perle Systems Limited.

Microsoft, Windows 95, Windows 98, Windows NT, Windows 2000 and Internet Explorer are trademarks of Microsoft Corporation.

Netscape is a trademark of Netscape Communications Corporation.

Solaris is a registered trademark of Sun Microsystems, Inc. in the USA and other countries.

Perle Systems Limited, 7 October 2002.

FCC Note

The products described in this manual have been found to comply with the limits for a Class A digital device, pursuant to Part 15 of the FCC rules. These limits are designed to provide reasonable protection against harmful interference when the equipment is operated in a commercial environment. This equipment generates, uses and can radiate radio frequency energy and, if not installed and used in accordance with the instructions in this Guide, may cause harmful interference to radio communications. Operation of this equipment in a residential area is likely to cause harmful interference, in which case the user will be required to correct the interference at his/her own expense.

EN 55022: 1998, Class A Note

Warning: This is a Class A product. In a domestic environment this product may cause radio interference in which case the user may be required to take adequate measures.



Caution: The products described in this manual are approved for commercial use only.

About this manual

Purpose of this manual

This manual tells you how to install, configure and use the Perle IOLAN+ communications servers.

Who this manual is for

This manual is aimed at users who want to connect serial devices directly to LANs and WANs. This manual requires a working knowledge of using personal computers and associated operating systems, as well as experience in installing host cards and peripherals.

Using this on-line manual

The following is a brief guide to using this manual on-line.

Document navigation

This manual features document navigation hypertext buttons in the header area as shown in the next picture;

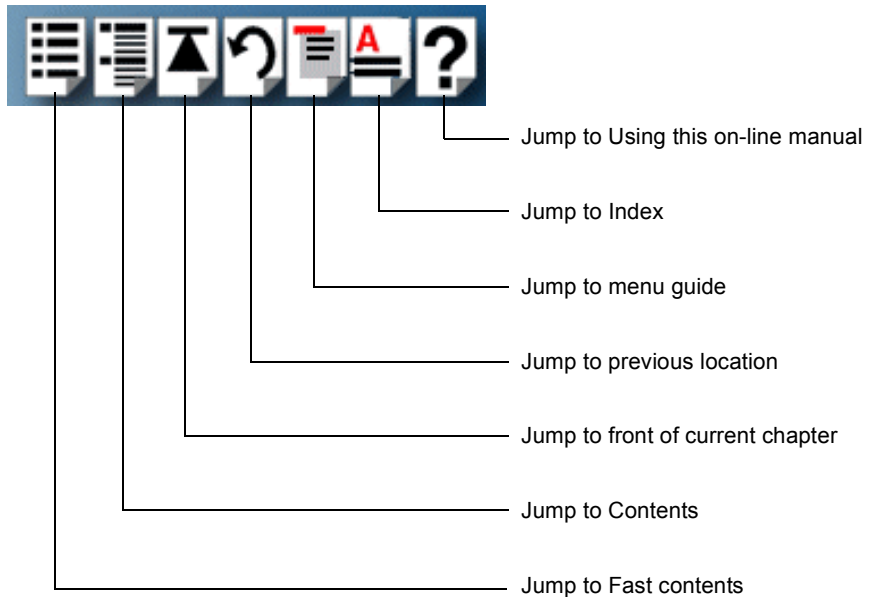

Hypertext jumps

You can also navigate around this manual by clicking on any cross reference or text in blue for example, [Hypertext jumps](#).

Note

The **Fast Contents**, **Contents** and **Index** entries are all hypertext jumps into this manual.

Revision history

Date	Part number	Description
July 2001	5500054-10	Initial re-branded release of manual.
October 2001	5500054-11	Minor update for Vmodem.
April 2002	5500054-12	Update for 10/100 Ethernet support.
June 2002	5500054-13	Updated RS422 pinout information.
August 2002	5500054-14	Removed reset switch in manual content and changed reset procedures.
September 2002	5500054-15	Minor changes to software and diagnostics sections from "T" release software.
October 2002	5500054-16	Added note regarding legacy reset procedures.

Fast Contents

<i>ABOUT THIS MANUAL</i>	<i>4</i>
<i>REVISION HISTORY</i>	<i>6</i>
<i>FAST CONTENTS</i>	<i>7</i>
<i>CONTENTS</i>	<i>8</i>
<i>CHAPTER 1 INTRODUCTION</i>	<i>26</i>
<i>CHAPTER 2 INSTALLATION</i>	<i>36</i>
<i>CHAPTER 3 TERMINALS ON MUTLI-USER SYSTEMS</i>	<i>54</i>
<i>CHAPTER 4 SETTING UP DIAL-IN MODEM PORTS</i>	<i>62</i>
<i>CHAPTER 5 MODEM AUTHENTICATION AND LOGGING</i>	<i>70</i>
<i>CHAPTER 6 DIALOUT MODEM PORTS SETUP</i>	<i>79</i>
<i>CHAPTER 7 VMODEM (VIRTUAL MODEM)</i>	<i>89</i>
<i>CHAPTER 8 PRINTING</i>	<i>98</i>
<i>CHAPTER 9 OTHER DEVICES SETUP</i>	<i>114</i>
<i>CHAPTER 10 THE MENU INTERFACE</i>	<i>125</i>
<i>APPENDIX A COMMAND LINE INTERFACE</i>	<i>160</i>
<i>APPENDIX B RS-422 IOLAN+</i>	<i>173</i>
<i>APPENDIX C 48V DC IOLAN+ RACK</i>	<i>178</i>
<i>APPENDIX D TROUBLESHOOTING</i>	<i>185</i>
<i>APPENDIX E CABLING</i>	<i>204</i>
<i>APPENDIX F CONTACTING PERLE</i>	<i>217</i>
<i>INDEX</i>	<i>224</i>

Contents

ABOUT THIS MANUAL	4
<i>Purpose of this manual</i>	<i>4</i>
<i>Who this manual is for</i>	<i>4</i>
<i>Using this on-line manual</i>	<i>5</i>
<i>Document navigation</i>	<i>5</i>
<i>Hypertext jumps</i>	<i>5</i>
REVISION HISTORY	6
FAST CONTENTS	7
CONTENTS	8

CHAPTER 1 INTRODUCTION

26

About the IOLAN+	27
IOLAN+ Features	29
Hardware	29
Software	30
Security	31
Hardware Overview	32
Hardware description for IOLAN+	32
Hardware description for IOLAN+ Rack	33
Hardware description for IOLAN+ 102/104	34
RS-232/RS-422	35
Software description	35

CHAPTER 2 INSTALLATION

36

Connecting to your Network	37
10BASE-T (twisted pair)	37
10BASE2 (Thin Ethernet)	37
AUI port.....	37
10/100BASE-T.....	37
Switching on IOLAN+	38
Communicating via ARP	39
Communicating via a Terminal or PC	40
The Menu System	41
Connections Menu	43
Administration Menu	44
Server Configuration Menu	46
Port Setup Menu and Beyond.....	48
Tips	50
Copy Command.....	50
Connecting via BOOTP (for Unix systems only)	50
Saving and downloading configurations	52
Domain Name Server (DNS)	53
Reassigning IOLAN+ to a New Network.....	53
Updating IOLAN+ Firmware.....	53

CHAPTER 3 TERMINALS ON MUTLI-USER SYSTEMS

54

Introduction	55
Terminal Port Configuration	56
Host Table Setup	58
Making a Connection	59
Tips	61
Connecting via 'fixed ttys'	61
Multisessions on terminals/PCs	61
Gateway Tables	61

CHAPTER 4 SETTING UP DIAL-IN MODEM PORTS

62

Introduction	63
Dial-in Port	64
The host	66
The modem	67
Client login	68
Tips	69
<i>Domain Name Server (DNS)</i>	69
<i>WINS Server</i>	69
<i>MOTD</i>	69
<i>Gateway notes</i>	69

CHAPTER 5 MODEM AUTHENTICATION AND LOGGING 70

Introduction 71

User authentication/logging 72

The host 75

Basic authentication 75

User services authentication 75

Logging 77

Tips 78

CHAPTER 6 DIALOUT MODEM PORTS SETUP	79
Introduction	80
Configuration	81
The host	82
<i>For dial-out connections on Unix</i>	82
<i>For dial-out connections on Windows ® systems</i>	82
Routing	83
Remote Access Systems	84
<i>Dial-out PAP Authentication</i>	86
Remote site devices	87
Tips	88

CHAPTER 7 VMODEM (VIRTUAL MODEM)	89
About Vmodem (Virtual modem)	90
Configuring ports to use Vmodem	91
<i>Configuring ports to use Vmodem in Normal Mode</i>	91
<i>Making a Call using Vmodem in Normal Mode</i>	93
<i>Disconnecting a Call in Vmodem Normal Mode</i>	93
<i>Configuring Vmodem to use Dial on DTR mode</i>	94
<i>Making a Call using Vmodem in Dial on DTR Mode</i>	95
<i>Disconnecting a Call in Vmodem Dial on DTR Mode</i>	95
Setting/Modifying up Vmodem responses	96
Vmodem AT Commands	97

CHAPTER 8 PRINTING

98

Introduction	99
Using ioland	100
Configuration.....	101
The Host	102
Using LPD	103
Configuration.....	103
Accessing the Printer	105
LPD printing from DOS/Windows ®.....	106
LPD Printing from BSD Unix and Linux	107
LPD Printing from SYS V Unix.....	108
LPD printing from AIX	108
LPD printing from HP/UX.....	108
Using RCP	109
Configuration.....	109
The Host	110
Using RCP with Unix System V line printer spoolers.....	111
RCP printing on a spooler system based on BSD Unix	112
Setting up RCP printing on AIX.....	113

CHAPTER 9 OTHER DEVICES SETUP	114
Introduction	115
Reverse Telnet Port Configuration	116
<i>The Host</i>	117
Perle IOLAND Utility	118
<i>Mandatory arguments</i>	119
<i>Optional arguments</i>	120
<i>Example daemon configuration file</i>	123
Tips	124

CHAPTER 10 THE MENU INTERFACE

125

Introduction to menu commands	126
Toggle fields	126
Fast keys	127
Connections menu	128
Port setup menu	130
Hardware	131
User	132
Flow control	133
IP address	134
Options	135
Keys	136
Access	137
Administration menu	139
Extra statistics screens	140
Access menu	141
Remote access sites	142
Remote site devices	144
Authentication/Logging	146
Change password options	148
Gateway menu	149
Host Address menu	150
Kill command	150
Lines menu	151
Access	152
Flow control	152
Hardware	152
Network connections	153
Options	153
Terminal	154
Port menu	154
Quit command	154
Reboot command	154
Server configuration menu	155
Statistics screens	158
Trap function	159

APPENDIX A COMMAND LINE INTERFACE 160

Introduction	161
Using the CLI	162
System administration	163
Basic configuration	164
Command descriptions	165
arp	165
clear	165
connect	165
copy	166
dial	166
disconnect	166
exit	166
facreset	166
gateway.....	166
help	167
host	167
kill.....	167
lock.....	167
logout	167
prov.....	167
reboot.....	168
resume	168
rlogin	168
save	168
set	169
set admin	169
set menu	169
set modem	169
set term	169
set port.....	170
set port [number]	170
set port [number] [access, flow, hardware, options, tcp, user]	170
set server	170
set slip [IP address]	170
set ppp [IP address]	170
set password [admin] or [login]	170
show	171

<i>show ports</i>	171
<i>show lines</i>	171
<i>show statistics</i>	171
<i>SU</i>	171
<i>telnet</i>	171
<i>test</i>	172

APPENDIX B RS-422 IOLAN+

173

Introduction	174
Hardware Changes	174
Connectors and Indicators	174
RS-422 Serial Port Connections	175
Software changes	176
LED Error Codes	177
Known Limitations	177

APPENDIX C 48V DC IOLAN+ RACK

178

Introduction	179
Installing the IOLAN+ Rack 48V DC	180
Installation	180
Electrical Supply Details	180
Safety Earth	181
Fusing	181
Electrical Safety Guidelines	182
Connecting up your IOLAN+ Rack	183
Disconnecting your IOLAN+ Rack	184

APPENDIX D TROUBLESHOOTING

185

Introduction	186
Terminals/PC Problems	187
Printer Problems	189
Modem problems	191
IOLAN+ Still Does Not Communicate	192
Resetting Your IOLAN+	193
Using the IOLAN+ Statistics screens	194
<i>ETH/TTY/GATEWAY</i>	194
<i>IP/ICMP/UDP</i>	195
<i>TCP</i>	195
<i>Users</i>	195
<i>Framed Link Status</i>	196
<i>Netstat</i>	197
<i>Gateway</i>	197
<i>SLIP</i>	197
<i>Clear counters</i>	197
<i>Restore counters</i>	198
<i>Port Status</i>	198
<i>Line status</i>	198
<i>LPD Status</i>	199
<i>PPP Status</i>	199
Using SNMP	199
Diagnostics	200
<i>Entering the Diagnostic Menu</i>	200
<i>Self-test</i>	200
<i>Monitor</i>	200
<i>Download</i>	201
<i>Ethernet Interface</i>	201
<i>Reset</i>	202
<i>Reset all settings</i>	202
<i>Reset password</i>	202
<i>Reset IP address</i>	202
<i>Reset product name</i>	202
<i>Reset Ethernet address</i>	202
<i>Quit</i>	202

APPENDIX E CABLING

204

Introduction	205
Serial port connectors on the IOLAN+ unit	206
Serial port connector guide	206
RS232 DB25 female DTE	206
RS232 RJ45 DTE socket	207
RS422 RJ45 DTE socket	208
Standard modem cables	209
IOLAN+ DB25 DTE to Modem DB25 DCE	209
Cable diagram	209
Connector pinout table	209
IOLAN+ Rack and IOLAN+ 102/104 RS232 RJ45 DTE to Modem DB25 DCE	
210	210
Cable diagram	210
Connector pinout table	210
Standard Terminal/PC cables	211
IOLAN+ DB25 DTE to Terminal DB25 DTE	211
Cable diagram	211
Connector pinout table	211
IOLAN+ DB25 DTE to PC DB9 DTE	212
Cable diagram	212
Connector pinout table	212
IOLAN+ Rack and IOLAN+ 102/104 RJ45 DTE to Terminal DB25 DTE	213
Cable diagram	213
Connector pinout table	213
IOLAN+ Rack and IOLAN+ 102/104 RJ45 DTE to PC DB9 DTE	214
Cable diagram	214
Connector pinout table	214
Printer cables with hardware flow control	215
IOLAN+ DB25 DTE to Printer DB25 DTE	215
Cable diagram	215
Connector pinout table	215
IOLAN+ Rack and IOLAN+ 102/104 RJ45 male to printer DB25 DTE	216
Cable diagram	216
Connector pinout table	216

APPENDIX F CONTACTING PERLE	217
<i>Making a technical support query</i>	218
<i>Who to contact</i>	218
<i>Information needed when making a query</i>	219
<i>Making a support query via the Perle web page</i>	220
<i>Repair procedure</i>	221
<i>Website RMA (Return Material Authorisation) Form</i>	221
<i>Feedback about this manual</i>	222
<i>Contacting Perle technical support</i>	223
INDEX	224

Chapter 1 Introduction

You need to read this chapter if you want to...

You need to read this chapter if you want an overview of the IOLAN+ product.

This chapter provides introductory information about the Perle IOLAN+, its associated components, software and configuration utilities.

This chapter includes the following sections;

- [About the IOLAN+](#) on page [27](#)
- [IOLAN+ Features](#) on page [29](#)
- [Hardware Overview](#) on page [32](#)
- [Hardware description for IOLAN+](#) on page [32](#)
- [Hardware description for IOLAN+ Rack](#) on page [33](#)
- [Hardware description for IOLAN+ 102/104](#) on page [34](#)
- [RS-232/RS-422](#) on page [35](#)

About the IOLAN+

The IOLAN+ is a unique Ethernet TCP/IP communications / terminal server allowing serial devices to be connected directly to LANs and WANs. The 2, 4, 8 or 16 serial ports enable IOLAN+ to connect to a wide range of devices including:

- Modems for remote access and Internet access
- ISDN adapters for branch remote access and Internet access
- Terminals for multi-user Unix systems
- PCs using terminal emulation or SLIP/PPP
- All types of serial printers
- Data acquisition equipment (manufacturing, laboratory, etc.)
- Retail point-of-sale equipment (bar coding, registers, etc.)

The performance and flexibility of IOLAN+ allows you to use a wide range of high speed devices in complex application environments. These operating systems include:

- Windows ® 95/98
- Windows NT ®
- Citrix Winframe
- SCO Unix & Gemini
- IBM AIX
- Sunsoft Solaris
- Hewlett Packard HP-UX
- Data General DG/UX
- All other variants of Unix (BSD, Linux, IRIX, etc.)

This configuration diagram shows many of the features available on the IOLAN+ communications server:

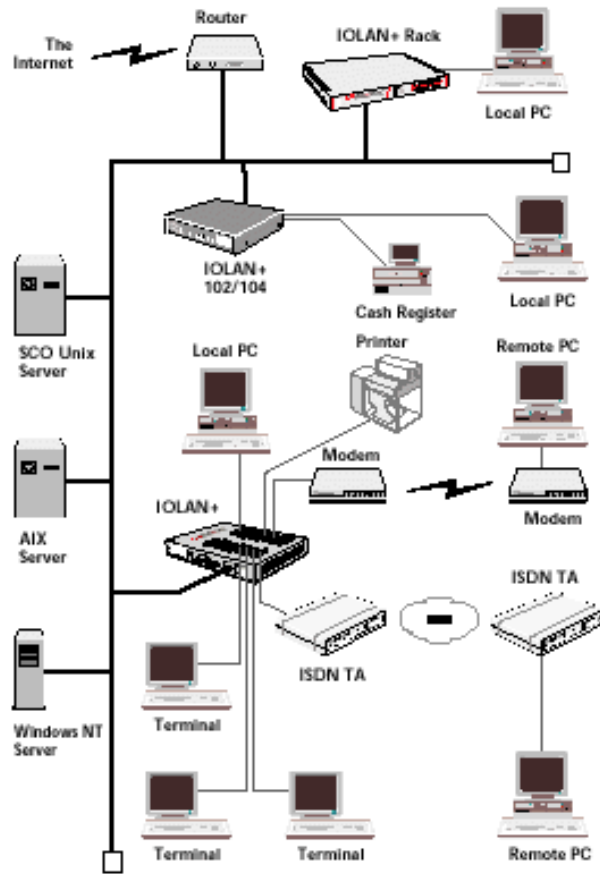

IOLAN+ Features

IOLAN+ is a TCP/IP communications server with 2, 4, 8 or 16, RS-232 or RS-422 ports for making serial network connections. It attaches to your TCP/IP network and allows serial devices such as modems, terminals and printers to access the network.

Hardware

The IOLAN+ hardware features include:

- 2, 4, 8 or 16 serial lines, fully configurable with port speeds up to 115.2 kbps.
- RJ45 connectors on IOLAN+ and IOLAN+ 102/104 or DB25 connectors on IOLAN+.
- Full modem control using DTR, DSR, CTS, RTS and DCD.
- FLASH memory for downloading firmware releases.
- IOLAN+ 102/104 has 10BASE-T or 10/100BASE-T interfaces.
- IOLAN+ and IOLAN+ Rack have either autosensing 10BASE-T / 10BASE2 / AUI or 10/100BASE-T interfaces.
- Auto sensing power supply; 110-250V AC (48-60V DC option available on IOLAN+).
- LEDs for diagnostic testing.
- Self-test on power-up.
- Rack mount or tabletop design.

Software

The IOLAN+ software features include:

- Support for TCP/IP protocols including telnet and rlogin.
- Remote access support including PPP, SLIP and CSLIP.
- Printer support via lpd, rcp, and Perle utilities.
- Modem support via PPP and Perle utilities.
- Perle utilities provide 'fixed tty' support for Unix systems.
- A window oriented menu interface with pop-up menus and on screen help (command line also available).
- ARP or BOOTP for network based setup.
- Dynamic statistics displays and line status reporting for fast problem diagnosis.
- Multi screens on terminals.
- Full support of SNMP MIBs, allowing remote configuration via SNMP as well as statistics gathering.
- Interoperability with IP routing through gateway tables.
- Domain Name Server support.
- WINS support for Windows ® environments.
- Port configuration copy and save functions.

Security

The IOLAN+ security features include:

- Supervisory and port password.
- Port locking.
- Authentication with PAP support.
- Per user access level assignment.
- Service logging.
- Logging facility for audit and billing.
- Modem auto reset.

Hardware Overview

The following table and diagrams describe the units:

Model	Type	No. Ports	Connector	Interface
IOLAN+ 102/104	Table Top	2,4	RJ45	RS-232, RS-422
IOLAN+	Table Top	8,16	DB25	RS232
IOLAN+ Rack	Rack Mount	4, 8, 16	RJ45	RS-232, RS-422

Hardware description for IOLAN+

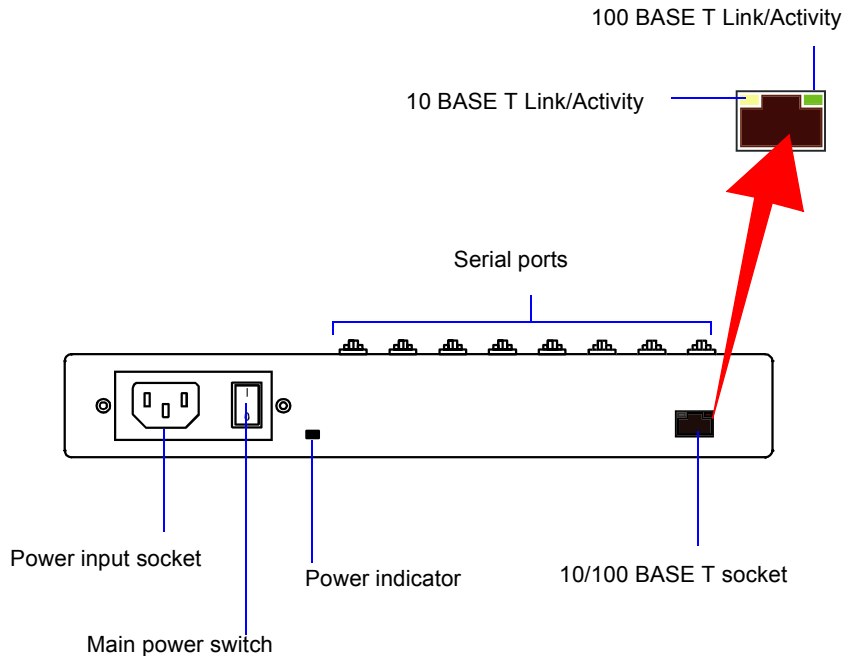

Hardware description for IOLAN+ Rack

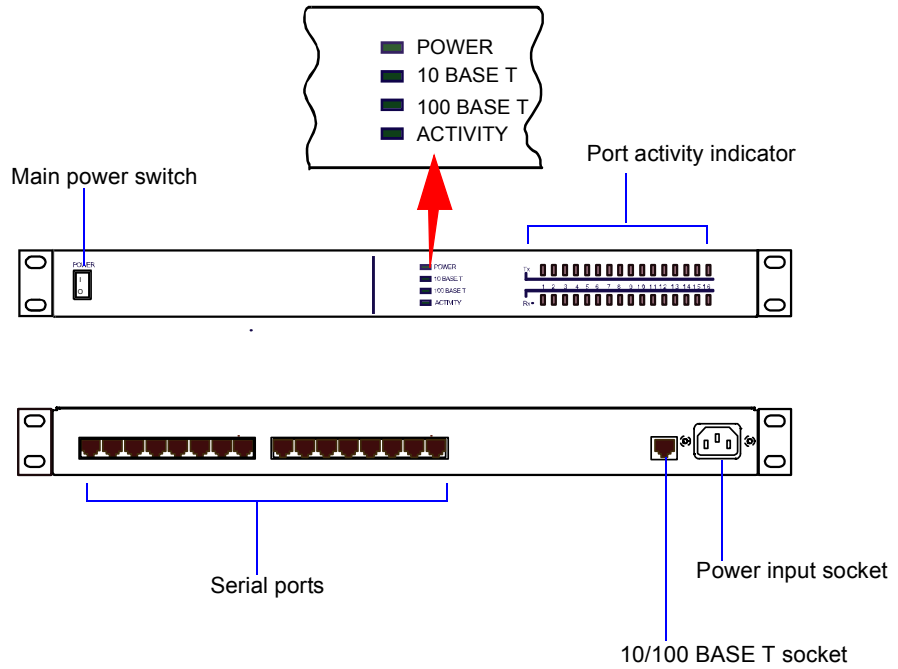

Hardware description for IOLAN+ 102/104

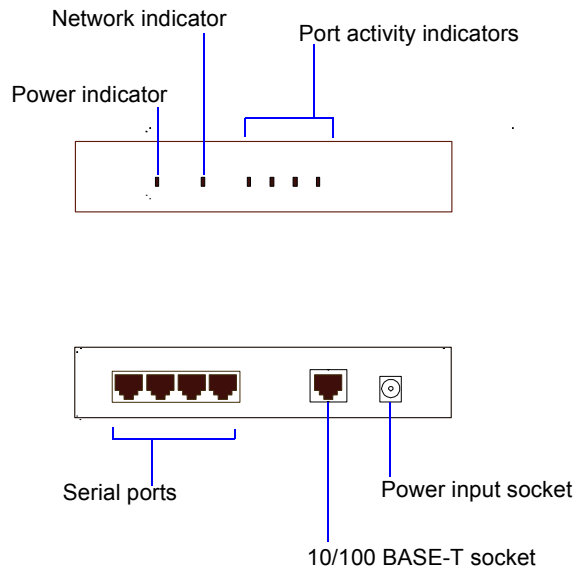

RS-232/RS-422

Functionally, the difference between RS-232 and RS-422 versions is the absence of support for hardware flow control lines (RTS and CTS) and modem control lines (DSR, DTR and DCD) in the RS-422 version. The performance and support for 115.2k baud are unaffected by the different serial ports. RS-422 uses differential signalling and is capable of handling longer distance due to superior noise immunity when installed with suitable cabling.

Software description

The IOLAN+ comes with the Perle CD. This CD contains the latest 'released' firmware and the redirector software for Unix systems called ioland. The firmware is a backup copy and generally not used. The ioland software is used for setting up printers and dial-out modems on Unix. The IOLAN+ uses TFTP for downloading new firmware. tftpd is included with Unix systems such as SCO, AIX and HP-UX but disabled by default. Consult your Unix manual on this subject. On Windows®, tftpd is not provided at this time (see our web site for a shareware tftpd program www.perle.com).

Chapter 2 Installation

You need to read this chapter if you want to...

You need to read this chapter if you want information about installing your IOLAN+ product.

This chapter provides information about installing the Perle IOLAN+ including connecting to your network, configuring communications as well as information on the menu system and general tips.

This chapter includes the following sections;

- [Connecting to your Network](#) on page [37](#)
- [Switching on IOLAN+](#) on page [38](#)
- [Communicating via ARP](#) on page [39](#)
- [Communicating via a Terminal or PC](#) on page [40](#)
- [The Menu System](#) on page [41](#)
- [Tips](#) on page [50](#).

Connecting to your Network

First connect IOLAN+ to a network then begin configuring the unit for your application. Additional information on configuring modems and printers follows.

IOLAN+ and IOLAN+ Rack connect to your ethernet network via one of the following (depending on your hardware model):

- Auto-sensing 10BASE-T (twisted pair)
- Auto-sensing 10BASE2 (thin)
- Auto-sensing AUI
- 10/100BASE-T

IOLAN+ 102/104 connect using either:

- 10BASE-T (twisted pair)
- 10/100BASE-T

10BASE-T (twisted pair)

Attach the RJ connector from a hub directly to IOLAN+ twisted pair port.

10BASE2 (Thin Ethernet)

Attach a BNC T connector directly to IOLAN+. If your IOLAN+ is the termination point for the cable you need to add a terminator. Always ensure that each segment of the thin Ethernet cable is at least 0.5m in length. The maximum length for a thin Ethernet cable is 185 metres.

AUI port

The AUI connector allows an external transceiver to be connected. This allows a number of different interfaces to connect including 10BASE5 (or thick) and fibre optic transceivers.

Attach the RJ45 connector from a hub directly to the IOLAN+ port.

10/100BASE-T

Attach the RJ connector from a hub directly to the IOLAN+ 10/100BASE-T port.

Switching on IOLAN+

The IOLAN+ power supply accepts input voltages in the range 110 to 240V AC, allowing it to be used world-wide. The IOLAN+ 102/104 has an external power supply unit.

After you connect your LAN interface, you can power up the unit. The green power indicator at the side (or front for rack and 102/104 units) should be lit. If the unit fails to power up with the green power indicator lit, disconnect the unit and contact your dealer for help.

The IOLAN+ firmware may be compressed, and this takes a short time to decompress before running.

During this phase the network LEDs will light alternately to indicate that decompression is in progress.

The green Ethernet indicators show the active connections. It remains lit and blinks when LAN traffic is active.

Note:

To change your Ethernet media, you will need to reboot the unit to activate the connector.

If your unit has 10BASE-T, 10BASE2 and AUI connectors, then the green ethernet indicators show the active connection. The indicators remain lit and blink when LAN traffic is active.

If you have an IOLAN+ Rack unit with 10/100BASE-T, then the Ethernet indicators will light green to indicate either 10Mbit or 100Mbit link, and the Activity light flickers to indicate LAN traffic.

If you have an IOLAN+ or IOLAN+102/104 with 10/100BASE-T, then the Ethernet will light green to indicate a 100Mbit link, and orange to indicate a 10Mbit link. The LED will flicker to show LAN traffic.

You are now ready to begin communicating with your IOLAN+. You can connect to IOLAN+ in different ways: via a terminal or PC on port 1, or using ARP or BOOTP. Using ARP is the preferred method for both Windows® and Unix, however a terminal or PC attached to port 1 is often used.

BOOTP setup is for Unix users only. Choose the appropriate method for your application. Third party BOOTP packages are available for Windows®

Communicating via ARP

IOLAN+ supports the 'Address Resolution Protocol' (ARP). It allows you to temporarily connect to your IOLAN+ to assign a permanent IP address. If you prefer to use a terminal or PC attached to IOLAN+, skip to the next section.

To do this proceed as follows;

1. From a local Unix host, type the following:

```
arp -s a.b.c.d aa:bb:cc:dd:ee:ff
```

(where a.b.c.d is the IP address you want for IOLAN+, and aa:bb:cc:dd:ee:ff is the Ethernet address of IOLAN+, found on the bottom of the unit itself).

2. On a Windows ® NT/98 system, the arp command is slightly different (using dashes instead of colons):

```
arp -s a.b.c.d aa-bb-cc-dd-ee-ff
```

3. Whether you use Unix or Windows ® to run arp, you are now ready to telnet to IOLAN+. Here is the sequence to use:

```
arp -s 192.168.209.8 00:80:d4:00:33:4e  
telnet 192.168.209.8  
password>  
local>
```

4. At the password prompt, press the **Enter** key since this is not set yet. The IP address still needs to be configured on the unit (ARP has only allowed you to connect to the unit so far).

Note

If there are any errors, recheck both the IP and Ethernet addresses you keyed in (this is the most common error here). See [Appendix D Troubleshooting](#) for more information on problems.

You can now skip the next section and go straight to [The Menu System](#) on page [41](#)

Communicating via a Terminal or PC

You can connect to IOLAN+ using a terminal or PC (with a terminal emulation package such as Hyperterm).

1. Connect a terminal or your PC to port 1. The IOLAN+ serial ports are DTE type RS-232 ports. When connecting a terminal/ PC directly (without modems), the RS-232 signals need to be crossed over ('null modem' cable). See [Appendix E Cabling](#) for pinout information.
2. For a terminal/PC to communicate with a server, set it to the following: 9.6 kbps, eight data bits, one stop bit, software flow control, no parity.

After powering up IOLAN+, you are prompted to enter a 'Local login:>':

3. You can just hit any character and at this point (the character is required).

The next prompt displayed is local>, which is the Command Line Interface (CLI) prompt.

Note

If there are any problems, check the cable you are using (this is the most common error). Port 1 is configured to provide error messages should any problems occur. See [Appendix D Troubleshooting](#) for more information on problems.

You can now move to The Menu System. See [The Menu System](#) on page [41](#).

The Menu System

You should now be at the Command Line Interface (CLI) of the IOLAN+ as designated by the `local>` prompt. If you would like to continue in CLI mode refer to [Appendix A Command Line Interface](#), but we recommend the menu system.

1. Set the terminal emulation type and begin using the menus.

The following are the terminal options:

ansi, dumb, vt100, wyse50, wyse60, tvi925, ibm3151, vt320, falco50, hp700

2. The default setting is 'dumb'. To set the menu interface to your emulation simply type `set term` with your option.

Example:

```
local> set term ansi
```

Note

For Falco50 type `local> set term falco`

3. To switch from the command line interface to the menu interface, at the `local>` prompt enter:

set menu

The Connections Menu should now be displayed.

This menu displays the current state of the four possible connections. There are no active connections.

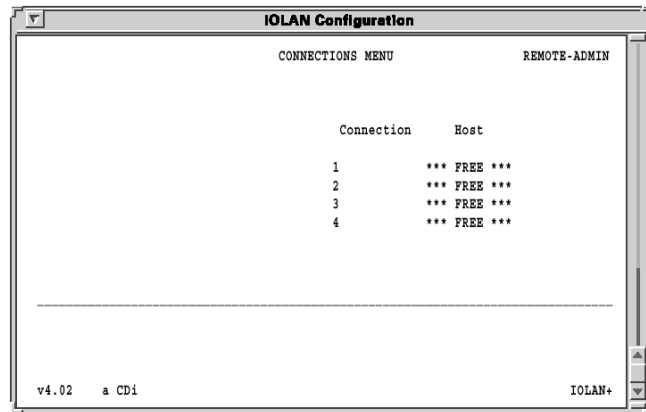

The firmware version of IOLAN+ is located on the lower left hand portion. The wording 'REMOTE-ADMIN' in the upper right signifies you are remotely telneted into IOLAN+ (and will read 'Terminal: 1' if you are using a terminal/PC into port 1.)

The keys used to move about in the menus depend on the terminal emulation you are using. The arrow keys should all work. The TAB key is very important for moving between fields.

Backspace and DEL should work, but depend on the emulation.

ESC (the escape key) will move you back one menu.

Note

If there is a problem with your emulation, you can try a different emulation mode. See [Appendix D Troubleshooting](#) for more information.

An accelerator key can be used to jump to an option within a menu and is the first letter of the option.

Connections Menu

Select connection '1' on the Connections Menu and press the **Enter** key. The Commands pop-up menu is displayed. There are a number of options available from this menu.

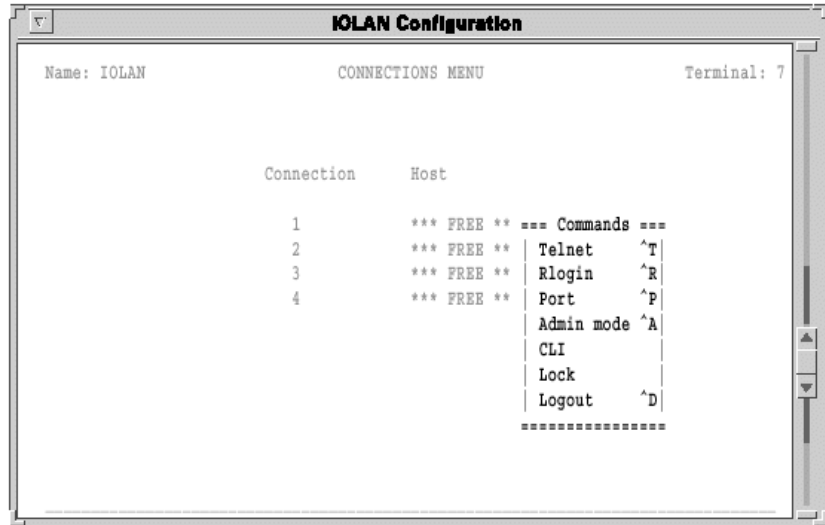

Before communication across the network can be established the IOLAN+ must be assigned a network IP address. This is accessed through the Administration Menu.

Select the Admin mode field and press the Enter key.

Note

If you are telneted into IOLAN+, the telnet, rlogin and port options do not appear on the Commands pop-up menu.

Administration Menu

The top level Administration Menu appears as follows:

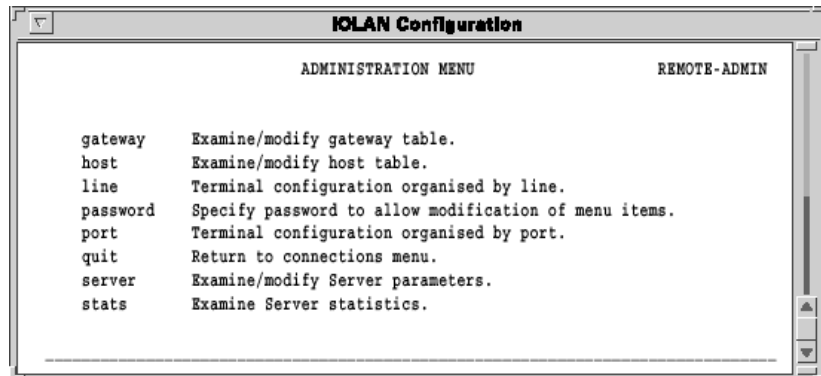

1. Select the Password field and press the **Enter** key. Use the factory default password here: this is iolan (no caps).

Note:

This password level will time-out in four minutes if there is no activity. This is for security reasons and will take you back to Administration Menu (view level).

The Administration Menu is redisplayed, it now has some extra fields (access, change, kill, reboot, trap).

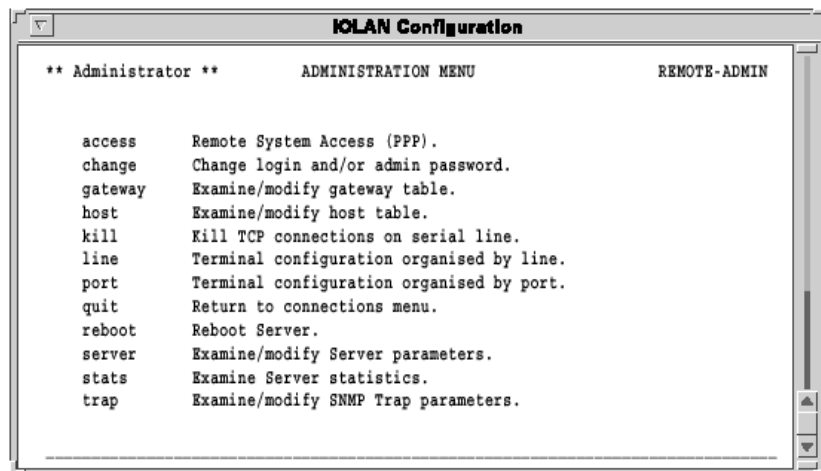

2. Select the server entry and press the **Enter** key. This takes you into the Server Configuration Menu.

Server Configuration Menu

There are a number of fields in the Server Configuration menu which are explained in [Chapter 10 The menu interface](#). At this point proceed as follows;

1. Give the IOLAN+ an IP address and a name.

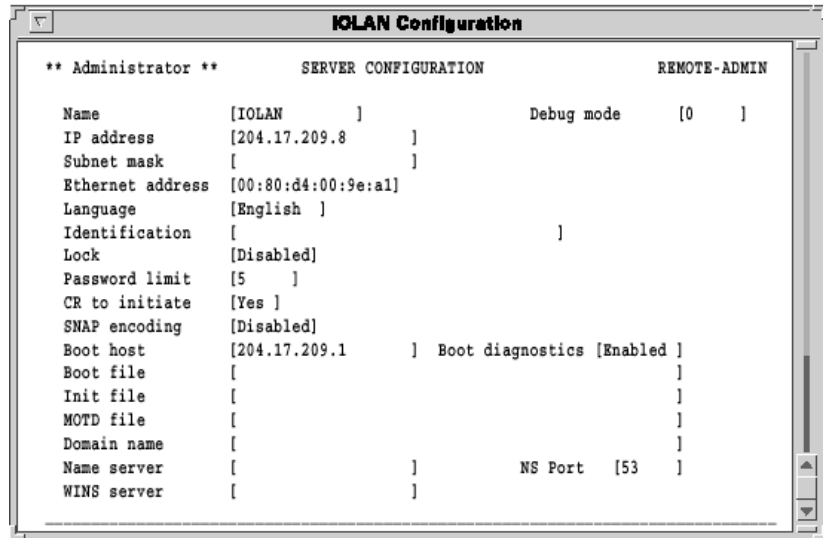

2. The important fields that you need to fill in are as follows:

Name: In the example above the communications server name has been set to IOLAN. It is a good idea for the IOLAN+ name entered here to match the name entered in the host machine's domain name server.

Note

For more information about domain name servers, consult your operating system manuals.

IP Address: This address must be set to a value that is consistent with the network the IOLAN+ is on.

3. Having filled in the fields press the **Enter** key. This brings the Commands pop-up menu as shown in the next picture.

Note

The Ethernet address is factory set. This address is uniquely assigned to the IOLAN+ and **MUST NOT** be changed.

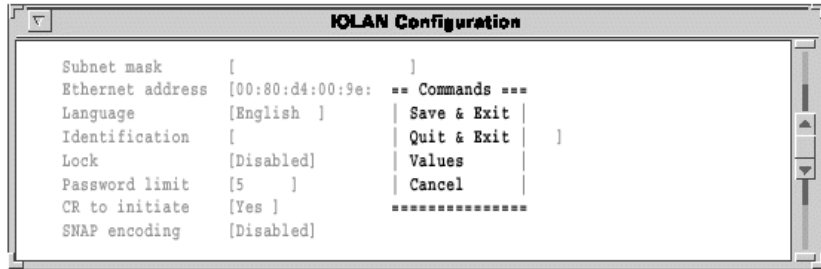

4. Select the Save & Exit field and press the **Enter** key. Other options are Quit & Exit, which does not save the changes before exiting this menu, Values, which will display the optional values for this field if available, and Cancel, which will take you back to this screen for more editing.
5. You have now set up the unit with a new IP address. This should be confirmed with the message:

IP CHANGED—PLEASE REBOOT

6. Reboot the communications server to activate the new IP address using the reboot command. The IP address and/or subnet mask are the only parameters that when changed necessitate rebooting.

Port Setup Menu and Beyond

Your communications server is now ready to configure for terminals on multi-user systems or modems, printers and other devices. The next sections deal with each of these.

If you've got a good feel for the menu system, you should proceed to the section appropriate for your application.

If you'd like a full review of the menu system refer to section 9, The Menu Interface later in this guide. For more information about the Command Line mode, consult [Appendix A Command Line Interface](#).

All of the procedures are based around the Port Setup Menu. This is accessed through the Administration Menu (password level). Remember, that if you are not in the password level, you can only view the information, not change it.

Here is the Port Setup Menu:

```

IOLAN Configuration
** Administrator **
Hardware          PORT SETUP MENU          REMOTE-ADMIN
Speed             [9600 ]          Flow ctrl          Keys
Parity            [None]          Flow ctrl [XON/XOFF] Hot [^]  Intr [^C]
Bit               [8]           Input Flow [Enabled] Quit [^@] Kill [^U]
Stop              [1 ]           Output Flow [Enabled] Del [^@] Sess [^@]
Break            [Disabled]          Echo [^@]
Monitor DSR       [No ]          IP Addresses
Monitor DCD       [No ]          Src [          ] Mask [          ]
                                   Dst [          ]

User
Name [          ]          Options
Terminal type [ansi ]      Rlogin/Telnet [Telnet] Access
TERM [          ]          Debug options [No ]      Authentication [None ]
Video pages [0]           Map CR to CR LF [No ]   Mode [Telnet]
CLI/Menu [Menu]          Hex data [No ]          Connection [Initiated]
Reset Term [No ]          Secure [No ]            Host [204.17.209.1 ]
                                   MOTD [No ]             Remote Port [23 ]
                                   Local Port [10006]
    
```

This menu allows the user to set up all the parameters associated with a port. The administrator can alter the set-up of any port on the communications server while a user can only alter the set-up for their own port.

This menu is divided into the following sections:

Menu option	Description
Hardware	Defines port type and is used for setting up the hardware configuration of the modem, terminal, printer or PC session. This section is always used.
User	Defines various user parameters such as name and terminal type. Most fields are used in this section.
Flow Control	Defines the various flow control options used by IOLAN+. This section is always used.
IP Addresses	Deals with remote access via PPP/SLIP sessions.
Options	Deals mainly with the telnet options. This section is the least used.
Keys	Defines the various accelerator keys that IOLAN+ responds to and can be used for convenience.
Access	Controls the type of the connection made from this port. This is the most important section in defining a port.

If you're ready to install terminals, printers and modems, proceed to the appropriate section. For a good review, go to [Chapter 10 The menu interface](#).

Tips

Copy Command

IOLAN+ has a copy command that allows you to copy the setup of one port to another. You will need to get to the CLI (from the Connection menu) and use the following syntax.

Note:

To get back to the menu system once in the CLI, type `set menu` at the command line.

```
local> su
password>
ADMIN:local> copy 1 2 3 4 5
ADMIN:local> set menu
```

The commands above would copy the configuration of port number 1 to ports 2, 3, 4 and 5 (and return you to the menu system).

Connecting via BOOTP (for Unix systems only)

IOLAN+ supports BOOTP which allows the communications server to dynamically configure itself on startup. Upon startup IOLAN+ sends four BOOTP broadcast requests if it has no IP address. This broadcast request packet contains the Ethernet address of your unit.

The request is received by all hosts on the network and is checked against a file to find a match. This data base file will normally be `/etc/bootptab` and will be of the following format:

```
# bootptab description

iolan:ht=ethernet:ha=0080d400024e:\

:hd=/tftp:\

:bf=iolan.DL:\

:ip=192.168.209.8:
```

Where:

ht is the type of network

ha is the Ethernet address on back of IOLAN+

hd is the home directory for specifying IOLAN+ firmware (optional)

bf is the name of IOLAN+ firmware (optional)

ip is the IP address you want to use

Note

This BOOTP implementation is a subset and not a full implementation of the RFC.

Note

The most common error is bad information in the /etc/bootptab file (recheck it).
See [Appendix D Troubleshooting](#) for more information.

You can now move back to The Menu System in this chapter.

Saving and downloading configurations

It is possible to save the configuration of your IOLAN+. This is convenient for loading multiple communications servers with the same setup. It is also advisable as a backup method.

If the boot file name has the extension “.cfg” (eg iolan.cfg), it will be loaded as a configuration file rather than a boot file.

This allows the administrator to configure one IOLAN+, save its configuration and automatically configure subsequent units via bootp.

Should the configuration of your IOLAN+ ever be corrupted because of user error or damage, it is an advantage to have the configuration stored somewhere for easy re-installation.

This can be achieved by uploading the configuration of the unit to a host on the network. To do this, enter the Communications Server Menu from the Administration Menu. Select the Init file entry of this menu.

Set this to the full pathname of the file in which you wish to store the configuration. Set Boot host to the host machine you wish the file to reside within and save these entries.

Boot host: rockvegas (or ip address)

Init file: /tftp/term_serv.cfg

Log onto the host machine in the normal manner and create the file you have specified in the IOLAN+ menu, this could be as shown in the next picture:

touch term_serv.cfg

Note

This file must exist with the correct read/write permissions before you can write to it. This can be accomplished by pressing the **Enter** key and selecting the CLI option in the pop up menu. At the iolan> prompt, use the CLI as the administrator by typing:

su

and enter the password and type:

save config

This uploads the communications server port configurations to the host in a format that can be downloaded at a later date.

Note

This does not save any of the settings configured in the Server Configuration Menu, including the IP address, language, name, subnet mask, etc.

IOLAN+ will now automatically download this configuration on reboot. Remember that whenever you change a setting on the unit, it will be overwritten the next time the unit is rebooted unless the new configuration is saved.

Domain Name Server (DNS)

IOLAN+ can be configured to take advantage of your network's Domain Name Server (DNS). This is done from the server in the Administration Menu by keying in the IP address of your DNS in the Name server field. Fill in the Domain name field as well.

Reassigning IOLAN+ to a New Network

If you need to attach IOLAN+ to a different network with a new IP address, it is possible to reset it to factory default condition using the following procedure:

1. Connect your IOLAN+ unit to the new network.
2. Power on the unit, and connect to a CLI using a serial terminal.
3. At the command prompt, type the following:

```
Local> su
Password>
ADMIN:Local> facreset
```

```
Do you really want to do this (y/n) [n] ? y
```

```
Performing factory reset ...
```

The IOLAN+ unit will now reboot and begin sending BOOTP request packet on the new network.

This procedure is useful for factory defaulting units which cannot be reached via TCP/IP. This includes reassigning a programmed unit to a network to which the previously assigned IP address does not belong.

Updating IOLAN+ Firmware

Firmware can be downloaded across the network using tftp protocol if the host machine and file name are set in the boot host and boot file entries of the server menu. These entries are checked at start up and if they have been configured, the relevant file will be downloaded.

Note:

tftp must be enabled on the relevant host as it is disabled by default

Chapter 3 Terminals on mutli-user systems

You need to read this chapter if you want to...

You need to read this chapter if you want information on setting up a terminal for use with your IOLAN+ product.

This chapter provides information on how to setup a terminal, and other tips such as the concept of 'fixed ttys', multiscreens, the copy command, TERM features, etc.

This chapter includes the following sections;

- [Introduction](#) on page [55](#)
- [Terminal Port Configuration](#) on page [56](#)
- [Host Table Setup](#) on page [58](#)
- [Making a Connection](#) on page [59](#)
- [Tips](#) on page [61](#)

Introduction

IOLAN+ is used extensively for connecting terminals, printers and modems on multi-user Unix systems, especially in retail applications. These Unix systems include SCO Unix, IBM AIX, HP-UX, Data General's DG/UX, etc. This chapter deals with terminals and/or PCs using emulation packages (such as Hyperterm).

In many applications, the users need to be 'direct connected' to a specific Unix host so that they see the login prompt automatically. This is helpful in securing your system, or in environments where the users need to be in one application only.

This chapter will show how to setup a terminal, and other tips such as the concept of 'fixed ttys', multi screens, the copy command, TERM features, etc. Consult [Appendix E Cabling](#), for information on wiring your terminal.

Remember to use the TAB key to bounce between fields, and if you get the Commands exit menu by mistake, use Cancel to return to editing this menu.

Terminal Port Configuration

This is the setup for making a terminal connect to a designated Unix host login prompt automatically.

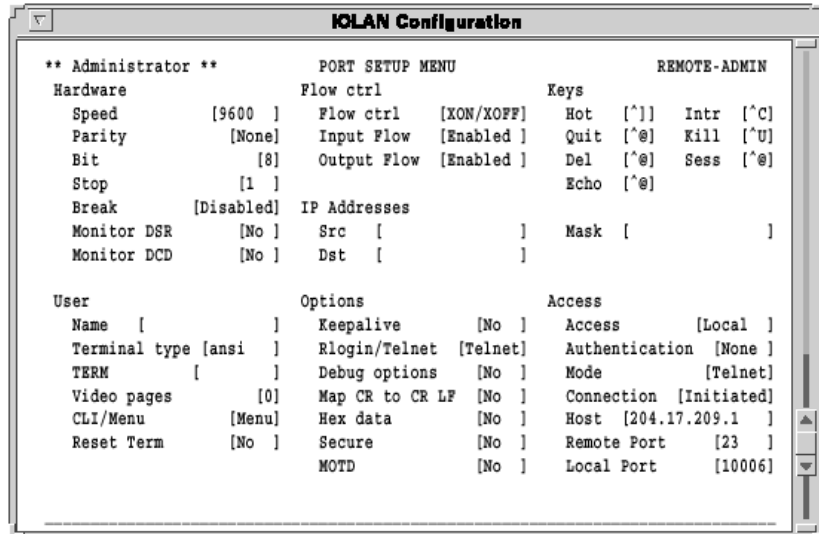

```

IOLAN Configuration

** Administrator **
Hardware          PORT SETUP MENU          REMOTE-ADMIN
Speed            [9600 ]          Flow ctrl          [XON/XOFF]          Hot  [^]          Intr  [^C]
Parity           [None]          Input Flow        [Enabled]          Quit [^@]          Kill [^U]
Bit              [8]          Output Flow      [Enabled]          Del  [^@]          Sess [^@]
Stop            [1 ]          Echo             [^@]
Break           [Disabled]
Monitor DSR      [No ]          IP Addresses
Monitor DCD     [No ]          Src  [           ]          Mask [           ]
                Dst  [           ]

User              Options
Name [           ]          Keepalive [No ]          Access [Local ]
Terminal type [ansi ]          Rlogin/Telnet [Telnet]          Authentication [None ]
TERM [           ]          Debug options [No ]          Mode [Telnet]
Video pages     [0]          Map CR to CR LF [No ]          Connection [Initiated]
CLI/Menu        [Menu]          Hex data [No ]          Host [204.17.209.1 ]
Reset Term      [No ]          Secure [No ]          Remote Port [23 ]
                MOTD [No ]          Local Port [10006]
    
```

The following fields are important:

Menu option	Description
Access	Set this field to Local. This tells the terminal server port to listen for data on the RS-232 side.
Mode	With this field set to telnet, the port will operate in telnet mode (or raw for rlogin). Most systems will use telnet.
Connection	Set this field to Initiated and the port will establish a TCP/IP connection to a specified host only after receiving a <CR> on the RS-232 port. If you set this field to none, then the user of this port will see the menu system when the terminal is powered on.
Host	Use this field to define which host computer you want the port to automatically connect to when using Initiated connections. Use the host's IP address or if you setup the Host Address Menu, you can use a name.

Menu option	Description
Remote Port	This corresponds to Telnet service on the remote host and must be set to the standard 23 (or 513 for rlogin).
Monitor DSR	You can set this field to Yes if you wire the terminal's DTR signal pin 20 (DB25) to the IOLAN+'s DSR signal pin 3 on the RJ45 connector (see Appendix E Cabling for DB25 pin assignments). When you turn the terminal off, it will reset the IOLAN+ port, which tells the Unix host to kill the user's processes.

Host Table Setup

In order for IOLAN+ to connect easily to machines on the network it must know the IP addresses of the other computers. IOLAN+ can have its own internal table of IP addresses set up in the host table. This is a 'local' naming system only. IOLAN+ can also use the name server utility of your Unix system (consult your Unix system manual and [Tips](#) on page 61).

The Host Address Menu is accessed from the Administration Menu by selecting the host entry. The host table can contain up to 10 addresses. Each entry consists of a host name and its corresponding IP address.

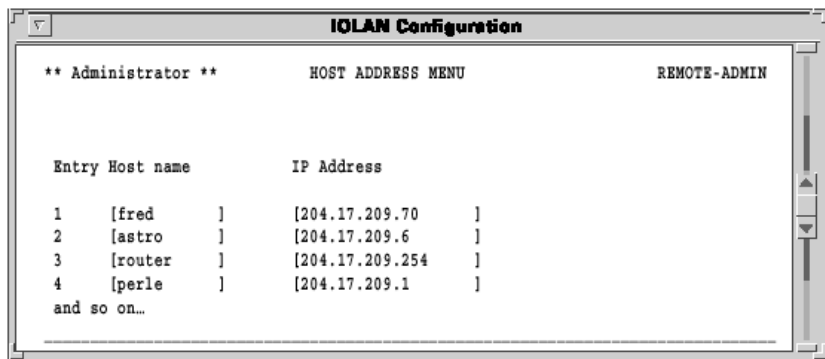

You can fill in an entry (both the name and the IP Address) for your host machines and then save the values by pressing the Enter key.

Making a Connection

If you are using initiated connections, you will not see the IOLAN+ menus. Instead, you see the login prompt of the host you assigned in the host field of the Port Setup Menu.

However, if your connection field is set to None, the Connections Menu appears. You are now ready to make connections. From the Connections Menu press the Enter key on a ***** FREE ***** session to display the Commands menu. Select the Telnet field and press the Enter key.

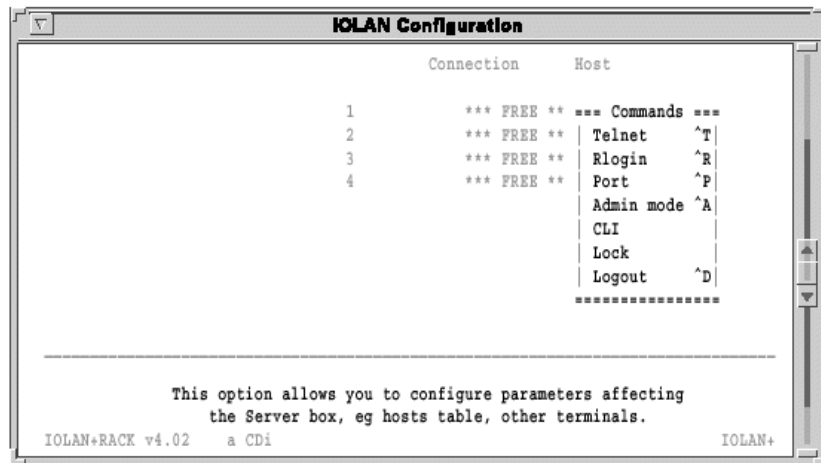

This produces a pop-up menu allowing the choice of the host machines that are configured in the host table. To select a host, move the cursor down to the required name then press the Enter key. At this point the unit attempts to make a connection across the network to the indicated host using the telnet protocol.

If it succeeds, the host machine's login prompt is displayed. There may be an error in the configuration if the connection cannot be established.

Note

At this point, check the host table again for correct entries, then check the network connection and host machine you're connecting to.

While in session to the host machine, you can return to the communications server by using a hot key. This is user-defined, but defaults to ^]. Press this key and the Connections Menu is displayed. To resume your connection select the host session you were on (notice that the

name of the host is now displayed where *** FREE *** was). Press the Enter key to bring up the Connection pop-up menu, then select the Resume Connection option.

Note

If the ^] did not work, you might have a conflict with that character sequence and should check the Keys section of this port.

When logging out of your session the connection is automatically closed.

Tips

Connecting via 'fixed ttys'

IOLAN+ has the ability to create a 'fixed tty' under Unix. This is helpful for older or secure Unix applications that require a fixed location for each terminal. Consult [Chapter 9 Other devices setup](#).

Multisessions on terminals/PCs

IOLAN+ is capable of supporting multiple sessions. This allows the user to connect to all four *** FREE *** sessions with different hosts and move between them using the ^] hot key. You can also key through the screens by setting the session key (that is, if set to ^A you would bounce through the screens with a ^A1, ^A2, ^A3, ^A4.). If you are using a terminal that supports video pages such as the Wyse 60, the screens will be refreshed if you set the video pages field on the Port Menu to the number of pages supported by your terminal (for Wyse 60 = 3).

The TERM field The TERM field in the Port Setup Menu can be used to pass the terminal type information to the host. The terminal type field is local to the IOLAN+ but will be passed to the host.

The TERM field can override the information being sent to the host about the type of terminal. This allows you to customise information being passed to the host. For example, a user could encode the physical location into this field (that is, tty16) and then extract that at the host end to determine which port the user has logged in on (that is, port 16).

Gateway Tables

When the host and IOLAN+ are connected via a gateway router, a connection is not possible until the gateway table has been updated with the IP address of the local gateway machine. See [Gateway Menu](#) on page 149 in [Chapter 10 The menu interface](#).

Chapter 4 Setting up dial-in modem ports

You need to read this chapter if you want to...

You need to read this chapter if you want information on creating dial-in connections with your IOLAN+ product.

This chapter provides information on the configuration necessary to create dial-in connections. It includes the most simple connection such as a dial-in Unix connection, The setting up PPP ports which is how Windows ® systems dial-in (as well as Unix).

This chapter includes the following sections;

- [Introduction](#) on page [63](#)
- [Dial-in Port](#) on page [64](#)
- [The host](#) on page [66](#)
- [The modem](#) on page [67](#)
- [Client login](#) on page [68](#)
- [Tips](#) on page [69](#).

Introduction

This chapter will review the configuration necessary to create dial-in connections. It will start with the most simple connection such as a dial-in Unix connection. The chapter then moves into setting up PPP ports which is how Windows® systems dial-in (as well as Unix). This is very important if you are an Internet Service Provider (ISP) or a corporate site providing remote access or Internet/Intranet access.

IOLAN+ can make a very good dial-in solution for ISPs and corporate users alike by using its remote access facilities.

This chapter goes hand-in-hand with [Chapter 5 Modem authentication and logging](#).

Note

In many of the modem examples, we are using PPP. You can use SLIP and CSLIP in those applications requiring these legacy modes.

Dial-in Port

The following is the port configuration for a dial-in connection, including PPP.

```

IOLAN Configuration
** Administrator **
Hardware          PORT SETUP MENU          REMOTE-ADMIN
Speed             [9600 ] Flow ctrl [XON/XOFF] Keys
Parity            [None] Input Flow [Enabled] Hot [^] Intr [^C]
Bit               [8] Output Flow [Enabled] Del [^@] Kill [^U]
Stop              [1 ] Echo [^@] Sess [^@]
Break             [Disabled] IP Addresses
Monitor DSR       [No ] Src [ ] Mask [ ]
Monitor DCD       [No ] Dst [ ]

User              Options          Access
Name [ ] Keepalive [No ] Access [Local ]
Terminal type [ansi ] Rlogin/Telnet [Telnet] Authentication [None ]
TERM [ ] Debug options [No ] Mode [Telnet]
Video pages [0] Map CR to CR LF [No ] Connection [Initiated]
CLI/Menu [Menu] Hex data [No ] Host [204.17.209.1 ]
Reset Term [No ] Secure [No ] Remote Port [23 ]
MOTD [No ] Local Port [10006]
    
```

The following fields are important:

Option	Description
Monitor DCD	With this flag set to Yes, IOLAN+ will monitor Data Carrier Detect (DCD) - pin 8 - from the modem. As soon as your modem answers a call and establishes a carrier signal, the modem raises DCD. The terminal server will then establish a telnet/rlogin connection to a specified host. When the modem hangs up, DCD goes low and the terminal server port resets. This will also drop the connection to the host.
TERM	This field is the TERM environment variable. Whatever you type in here will be passed to the host as the TERM variable when a telnet connection is established and the user logs in.
Flow Ctrl	The modem and terminal server port should be configured to use Hardware (RTS/CTS) flow control. This will be especially important if you are using SLIP.

Option	Description
Dst:	This field contains the IP address the dial-in user will borrow for the PPP session. If you are using a straight forward dial-in connection for Unix, this is not required.
Mask	If using PPP, SLIP or CSLIP, this is the subnet mask that controls the range of IP addresses accessible from the port and must correspond with your network. (If used for terminals, this is not needed.)
Secure	This field is set to Yes to force the call-in user to use the Dst IP address. (su is not available in this mode.) If the Secure flag is set, the dial-in user will not be able to obtain administrative privileges. This also applies to local terminals.
Access	Set this field to Dynamic. This sets the port of the terminal server to listen for data on both the RS-232 side and the network side. If only used for dial-in, set to Local and it will only listen on the RS-232 side.
Connection	With the connection set to Dedicated, the port will automatically connect to a specified host when not doing PPP (DCD goes high on the modem).
Host	When not doing PPP, this field defines which host computer you want the port to automatically connect to. Use the host's IP address. You can also define the host in the terminal server's Host Table and just use the name.
Remote port	This corresponds to the Login (for example, rlogin) service on the remote host and must be 513 (or 23 for Telnet).
Local port	The inetd process running on the terminal server for this port is listening for TCP/IP connections on TCP port 10006.

The host

Make sure you have setup a valid user account for authentication on the designated authentication host. See [Chapter 5 Modem authentication and logging](#).

The modem

You will need to configure the modem using a configuration string. To do this, go to the Remote Site Devices screen (via the Access section of the Administrative Menu). Select the UNUSED ENTRY that corresponds to the port with the modem attached (that is, third one down is port 3, etc.). You can set the type (for example, name) and the Modem Config to the required configuration string (for example, ate0s0=1&w). All other fields are default.

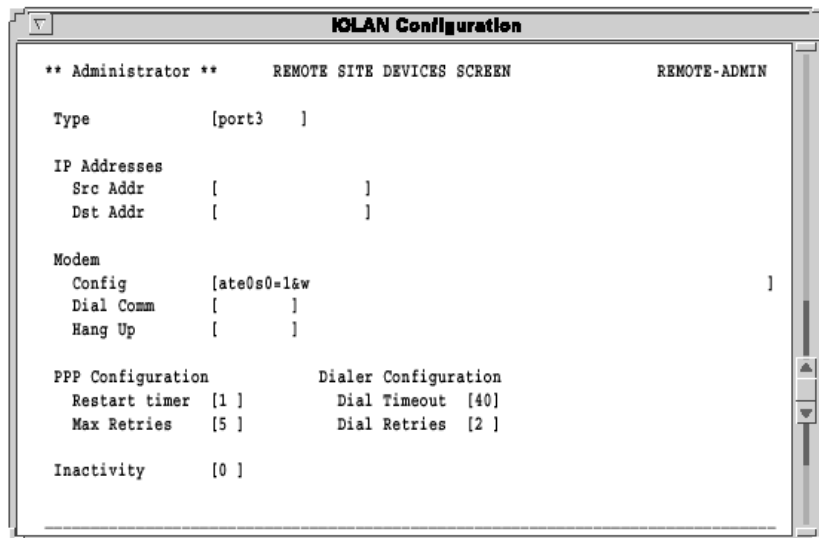

```

IOLAN Configuration
** Administrator **      REMOTE SITE DEVICES SCREEN      REMOTE-ADMIN

Type          [port3  ]

IP Addresses
Src Addr     [          ]
Dst Addr     [          ]

Modem
Config       [ate0s0=1&w          ]
Dial Comm    [          ]
Hang Up      [          ]

PPP Configuration      Dialer Configuration
Restart timer [1 ]      Dial Timeout [40]
Max Retries   [5 ]      Dial Retries [2 ]

Inactivity     [0 ]
  
```

You will now need to kill this port (from the Administration Menu or CLI) to activate the changes and configure the modem.

The configuration string will be sent to the modem after each call, keeping the modem in sync with IOLAN+.

Client login

When the caller connects, you may want to send out a welcome message of some sort. After the user gets this message, you want him/her to enter a login and password then connect to the Host for a shell account.

Or, if it is a PPP user, they will simply start sending PPP packets at the login prompt (for example, Windows © 95/98) and use PAP for authentication. Optionally, the dial-in user can place a P, S or C (all caps) in front of the user name at the Login prompt (this starts the corresponding protocol after successful authentication).

```
Welcome to the Internet site
login: Cflint
password:
Host authentication succeeded.
My IP Address is : 204.17.209.7
Your IP Address is : 204.17.209.210
The Subnet Mask is : 255.255.255.0
```

With this example, IOLAN+ is now in CSLIP mode, so put your PC into CSLIP mode as well. Your dialer script will have to parse out the My/Your addresses from the above message.

'Your IP Address' will be the address of the PC that is calling in, and 'My IP Address' can be the PC's default gateway. The above procedure works for SLIP and PPP as well. However, PPP will not display the 'My IP... ' message because the IP addresses are negotiated automatically in the IPCP layer.

With the Connection field on the Port Setup Menu set to Dedicated, if you do not specify a P, S or C in front of the user name, you will be authenticated and then connected to the host. This will leave you at a shell prompt on the Authentication host. A caller will never see IOLAN+. If Connection is set to None, you will be left at the CLI prompt (for example, IOLAN>).

Tips

Domain Name Server (DNS)

IOLAN+ can be configured to take advantage of your network's Domain Name Server (DNS). This is important for ISPs. From the Administration Menu select server and key in the IP address of your DNS in the Name server field. You could fill in the Domain name field as well.

WINS Server

If you have a local NT server running WINS and you want dial-in clients to take advantage of that, put the IP address of the NT server in the WINS server field of the Server Configuration screen.

Note

The Windows ® 95/98 client obtains the WINS address by setting 'Use DHCP for WINS resolution'.

MOTD

A Message of the Day (MOTD) can be displayed before login. This is setup from the Server Configuration menu using MOTD and Boot host fields.

Gateway notes

If you have a router on your local network, make sure you enter this into the IOLAN+ Gateway Menu.

Chapter 5 Modem authentication and logging

You need to read this chapter if you want to...

You need to read this chapter if you want information on modem authentication and logging for your IOLAN+ unit.

This chapter contains information providing authentication support to validate users connecting to the serial port, and updating a host log file on connection states.

This chapter includes the following sections;

- [Introduction](#) on page [71](#)
- [User authentication/logging](#) on page [72](#)
- [The host](#) on page [75](#)
- [Logging](#) on page [77](#)
- [Tips](#) on page [78](#)

Introduction

IOLAN+ provides authentication support to validate users connecting to the serial port, and can update a host log file on connection states. Authentication and logging is achieved by using a designated authentication host to validate users and keep connection information. This unique facility takes the burden away from the unit and more importantly allows the administrator to configure one host, rather than configuring multiple terminal servers.

Option	Description
Authentication	When the IOLAN+ port has authentication set to host or both, the user is required to enter a user name followed by a password when dialled in. The user ID and password are forwarded to the authentication host for validation. By setting the authentication hosts network port to 23 or 513, this allows the user ID to be checked against the standard Unix login system (see Tips on page 78). This feature also allows proprietary user validation code to be written on any TCP/IP platform by choosing another network port number.
Logging	During the IOLAN+ start up, a telnet session is established to the authentication host, with the pre-defined Log Username and Logger password. Serial events like users logging in and out are recorded in the defined Log File.

Note

RADIUS is often associated, but not required, for dial-in services. RADIUS offers three major functions: authentication, logging and user services. IOLAN+ can be configured to offer all of these features but without using RADIUS. This section explains how.

The Host Authentication And Logging menu may be accessed via the administrator from the access option in the Administration Menu.

User authentication/logging

To improve access security, IOLAN+ has a mechanism for authenticating users before allowing them access. This is accomplished by prompting the user for a Login ID and a password. IOLAN+ will then attempt to login to a specified host using that ID and password. If successful, the user is authenticated and allowed access. Otherwise, the call is dropped. IOLAN+ will also log events such as logins, logouts, connections and disconnections, and power ups.

This feature is enabled when you set the Authentication field to host in the Port Setup Menu.

The following is the host authentication setup (via the Access section of the Administration Menu):

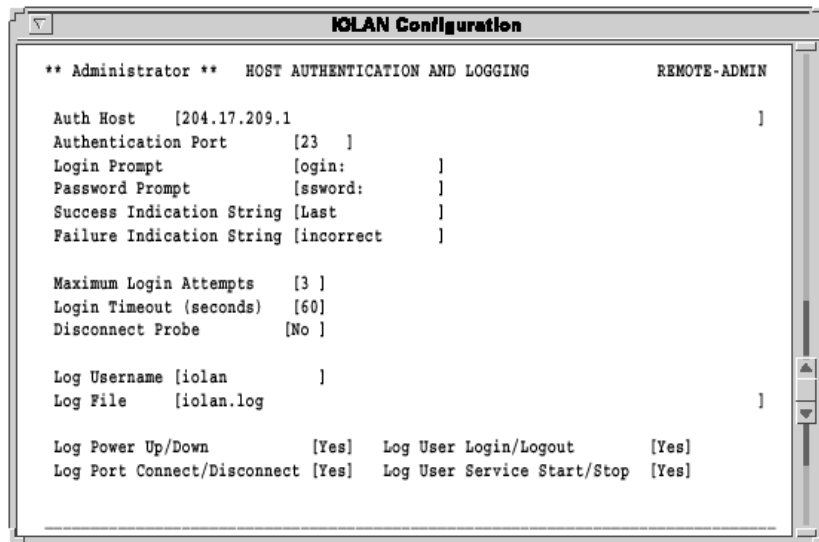

The following fields are important:

Option	Description
Auth Host	The IP Address/Name of the host that IOLAN+ attempts to login to for authenticating users.
Authentication Port	The TCP service to be used for authenticating users. Normally this is set to 23 for Telnet.
Login Prompt	The string used by IOLAN+ to know when to send the login ID. Set this field to ogin:. Leave out the first letter as some systems use a 'L' and others use a 'l' as the first letter.
Password Prompt	The string used by IOLAN+ to know when to send the users password. Use 'ssword' as depicted above.
Success Indication String	The string used by IOLAN+ to determine if the login ID and Password were valid and the login process was successful. Normally you will see the string 'Last' after successfully logging in.
Failure Indication String	The string IOLAN+ will look for to determine that the Login ID or Password were invalid. You will normally see the word 'invalid' or 'incorrect' as part of the failure message from the host.
Maximum Login Attempts	The number of login attempts IOLAN+ will allow the user to make before dropping the call.
Login Timeout	This defines the amount of time in seconds IOLAN+ will wait for the user to provide a login ID and password before dropping the line.
Disconnect Probe	This option determines whether authentication probe logins will be terminated on completion of authentication.
Log Username	The User ID IOLAN+ will use to log in to the authentication host and log messages. This user needs to be at a shell prompt to 'cat' messages to the log file. The password for the log user is set up under the IOLAN+ Administration Menu -Change option. Then choose the Logger option and enter the log user's password as defined on the host. You will have to enter this password twice. (See Tips on page 78.)
Log File	The filename the log user will send its messages to. Normally this will go to the log user's home directory.
Log Power Up/Down	IOLAN+ will log when it is powered up and rebooted.
Log User Login/Logout	IOLAN+ will log when a user logs in and out of a port on IOLAN+.

Option	Description
Log Port Connect/ Disconnect	IOLAN+ will log when someone connects to and disconnects from a port on IOLAN+.
Log User Service Start/ Stop	IOLAN+ will log a PPP, SLIP or CSLIP service when started on the port.

The host

Basic authentication

IOLAN+ will need to login to the authentication host with the log user name defined on the Host Authentication And Logging screen. Therefore, you need to create an account to be used by IOLAN+ (avoid csh shell). Make sure the user can log in successfully. Also, make sure the user is not prompted for any input and ends up at a shell prompt.

User services authentication

This is used to provide services based upon the dial-in user's name.

For example, user Mark always telnets to a specific IP address or user Alan needs to dial-in and establish a PPP connection using a static IP address. This is accomplished by using a PERL script which parses a RADIUS database. The PERL script (RADparse) is on the Perle CD or our website.

RADIUS is the TCP/IP protocol used for authenticating remote dial-in users. Although IOLAN+ does not use RADIUS, a Perl based utility capable of using standard RADIUS databases is available.

Otherwise, you can execute our PERL script during the user's login. Under Unix, this script is started from the etc/profile.

For Windows NT ® see the relevant section of the Perle website for the latest information. See [Appendix F Contacting Perle](#).

You then need to create a user database file. This is a sample file.

```
# Example of a PPP user with static address
alan Password
Framed-Protocol = PPP
Framed-Address = 204.17.209.1

# Example of a user with access to IOLAN+
CLI/Menu
techman Password
User-Service-Type = Shell-Use

# Example of a telnet user
mark Password
User-Service-Type = Login-User
```

```
Login-Host = 208.24.183.1  
Login-Service = Telnet
```

```
# Everybody else gets PPP with a dynamic address  
DEFAULT Password  
Framed-Protocol = PPP
```

Note

When using advanced authentication, make sure the Success Indication String in the Host Authentication And Logging menu is set to userdefined.

Logging

A log file can be updated on the authentication host to record when an IOLAN+ is powered up, rebooted, and users and ports are connected and disconnected. This information is of particular importance to administrators who need to record users logging in and out. In addition, when the logger is enabled IOLAN+ completes a time stamp every 5 minutes to record that an IOLAN+ is still active. This allows an administrator to gain an accurate record of events.

See [User authentication/logging](#) on page 72 (via the Access section of the Administration Menu).

When the IOLAN+ is powered up a Telnet connection is established to the authentication host with the Logger user name. The IOLAN+ records users logging in and out of the log file access.log. The logger only connects at IOLAN+ start-up time and the connection stays open until the unit is reset. The IOLAN+ checks the log TCP connection every 60 seconds. The logger may be restarted via the kill command by adding two to the number of ports on your server (for example, use four for an IOLAN+2, six for an IOLAN+4, ten for an IOLAN+8, eighteen for an IOLAN+16). If the host authentication succeeds, but logger fails to log events, then the port connection is dropped.

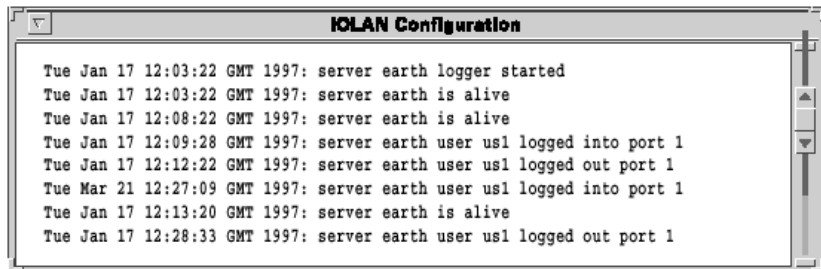

```
IOLAN Configuration
Tue Jan 17 12:03:22 GMT 1997: server earth logger started
Tue Jan 17 12:03:22 GMT 1997: server earth is alive
Tue Jan 17 12:08:22 GMT 1997: server earth is alive
Tue Jan 17 12:09:28 GMT 1997: server earth user us1 logged into port 1
Tue Jan 17 12:12:22 GMT 1997: server earth user us1 logged out port 1
Tue Mar 21 12:27:09 GMT 1997: server earth user us1 logged into port 1
Tue Jan 17 12:13:20 GMT 1997: server earth is alive
Tue Jan 17 12:28:33 GMT 1997: server earth user us1 logged out port 1
```

Tips

Windows ® notes Authentication of Windows NT ® requires a telnet daemon. Check the Windows ® section of our the perle website for the latest Windows ® telnetd software. You will need to set up your users on Windows NT ® through this software.

Logging on Windows NT ® also requires a utility called log_it.exe. If the Windows NT ® login user id is 'logger', enter it into IOLAN+ as Nlogger so that IOLAN+ will know to use the log_it.exe utility.

Also, on the Host Authentication And Logging menu, change the IOLAN+ Success Indication String to read, Microsoft instead of Last.)

Unix notes For LINUX users, edit the file /etc/motd and put the word 'Last' in it. This will agree with the standard setup of the Host Authentication And Logging menu's Success Indication String.

Chapter 6 Dialout modem ports setup

You need to read this chapter if you want to...

You need to read this chapter if you want information on setting up modem ports for your IOLAN+ product.

This chapter provides on setting up modem ports for your IOLAN+ product. Dial-out ports can be just a simple Unix outbound cu call or IOLAN+ can act as a dial-out router to facilitate Internet PPP requests.

This chapter includes the following sections;

- [Introduction](#) on page [80](#)
- [Configuration](#) on page [81](#)
- [The host](#) on page [82](#)
- [Routing](#) on page [83](#)
- [Remote Access Systems](#) on page [84](#)
- [Remote site devices](#) on page [87](#)
- [Tips](#) on page [88](#).

Introduction

Dial-out ports can be just a simple Unix outbound cu call or IOLAN+ can act as a dial-out router to facilitate Internet PPP requests.

As a dial-out router IOLAN+ automatically establishes a PPP/SLIP/CSLIP link to that site. Then drops the call after a preset period of inactivity. This dial-on-demand feature is automatic. IOLAN+ will place the call when local TCP/IP traffic needs to be routed to a configured remote site.

If not using dial-out routing, you will need a COMPORT redirector such as ioland. The Perle CD has the ioland utility if you are using Unix. Please load the appropriate binary onto your system. If you can not find the correct binary, please compile the ioland.c source code for your system (see your Unix manual).

Configuration

The Port Setup Menu should be set up as follows for both simple dial-in connections and PPP/SLIP connections.

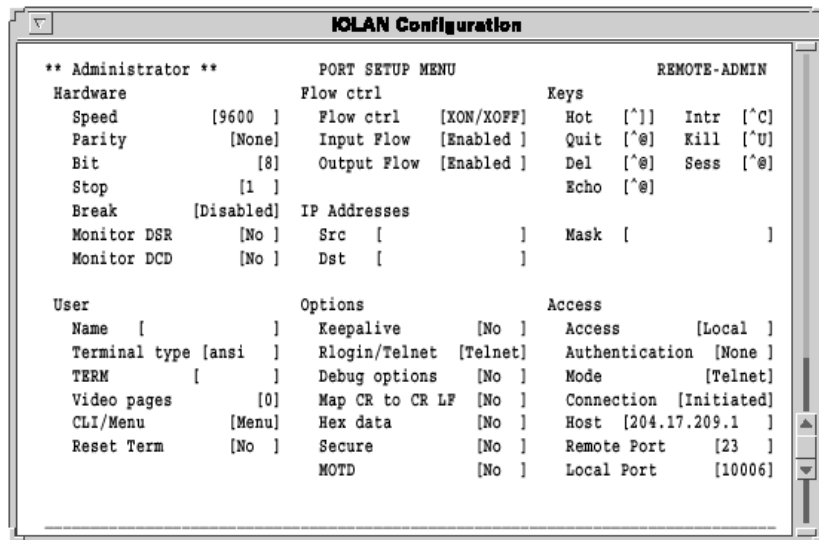

```

IOLAN Configuration

** Administrator **

Hardware          PORT SETUP MENU          REMOTE-ADMIN
Speed            [9600 ]      Flow ctrl  [XON/XOFF]      Keys
Parity           [None]      Input Flow [Enabled ]      Hot  [^]  Intr  [^C]
Bit              [8]      Output Flow [Enabled ]      Quit [^@] Kill [^U]
Stop             [1 ]      Echo      [^@]
Break           [Disabled]
Monitor DSR      [No ]      IP Addresses
Monitor DCD      [No ]      Src  [          ]      Mask [          ]
                                   Dst  [          ]

User              Options              Access
Name [          ]      Keepalive [No ]      Access [Local ]
Terminal type [ansi ]      Rlogin/Telnet [Telnet] Authentication [None ]
TERM [          ]      Debug options [No ]      Mode [Telnet]
Video pages      [0]      Map CR to CR LF [No ]      Connection [Initiated]
CLI/Menu         [Menu]      Hex data [No ]      Host [204.17.209.1 ]
Reset Term       [No ]      Secure [No ]      Remote Port [23 ]
                                   MOTD [No ]      Local Port [10006]
    
```

The following fields are important:

Field	Description
Access	Set the Access field to Dynamic (dial-in or out) or Remote (dial-out only).
Monitor DCD	With this flag set to Yes, the terminal server will monitor the modem signal Data Carrier Detect (DCD) - pin 8. When the modem hangs up, pin DCD from the modem goes low and the terminal server port will reset.
Flow Ctrl	The modem and terminal server port should be configured to use Hardware (RTS/CTS) flow control. This will be especially important if you are transferring binary files.
Mode	Set this field to raw.

The host

For dial-out connections on Unix

If you have not already loaded ioland onto your system, do so now (see Perle CD). For more information on ioland see [Chapter 9 Other devices setup](#). In it's simplest form, at the superuser prompt you would run the following command in Unix:

```
ioland -h <server-name> 10006 <device-name>
```

This will start the ioland process and allow you to specify a device-name in /dev that is linked to a pseudo tty. This pseudo tty works just like a regular tty with the following exception: you cannot set physical attributes such as baud rate, parity and flow control as these are handled by the terminal server. If you plan to use communication software on the Unix host such as cu or uucp you should refer to your Unix manual for additional help.

For dial-out connections on Windows ® systems

Check our website for the latest information on dial-out connections (under the Windows ® support directory). See [Appendix F Contacting Perle](#).

Routing

For dial-out routing, you must have the proper routing entry on all hosts in your local network that will communicate with the remote site. In the case of a Unix system, you must make an entry similar to the following (please check your Unix manual for the proper syntax of the route command):

For a single host at the remote site:

```
route add <remote-ip-addr> <IOLAN-ip-addr> 2
```

For multiple hosts at the remote site:

```
route add net <remote-net-addr> <IOLAN-ip-addr> 2
```

IOLAN+ will dial into another piece of hardware, log into that hardware and start a PPP session. Then the local IOLAN+ will act as a router and forward all IP traffic destined outside its local network. In other words, IOLAN+ will 'auto-dial' the Internet and act as the router. In this example, the local network is: 206.131.227.0, the ISP's network is: 206.189.134.0, the ISP's equipment that you are dialing into is another IOLAN+ (206.189.134.7) and the local IOLAN+ is: 206.131.227.5. The IOLAN+ gateway entries look like this:

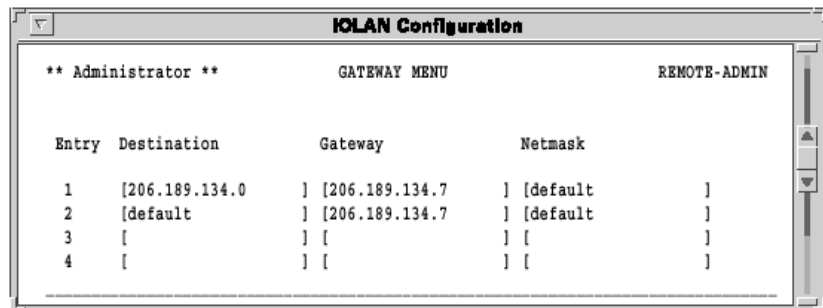

IOLAN Configuration				
** Administrator **		GATEWAY MENU		REMOTE-ADMIN
Entry	Destination	Gateway	Netmask	
1	[206.189.134.0] [206.189.134.7] [default]
2	[default] [206.189.134.7] [default]
3	[] [] []
4	[] [] []

Remote Access Systems

This screen is used to define a remote system (up to 16 entries per IOLAN+), a phone number, login script, etc. There are a lot of similarities between this screen and the UUCP systems file under Unix.

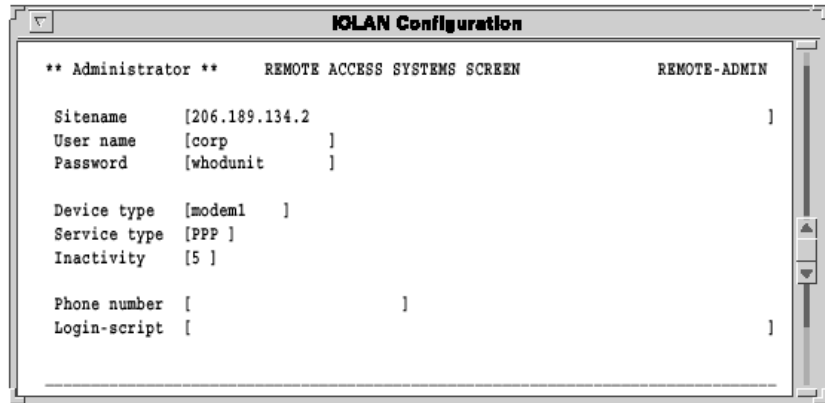

```

IOLAN Configuration
** Administrator **      REMOTE ACCESS SYSTEMS SCREEN      REMOTE-ADMIN
Sitename [206.189.134.2 ]
User name [corp ]
Password [whodunit ]
Device type [modem1 ]
Service type [PPP ]
Inactivity [5 ]
Phone number [ ]
Login-script [ ]
  
```

The following fields are important:

Field	Description
Sitename	The IP name or IP address of the remote site IOLAN+ will be calling.
User name	The user name required by the remote system for logging in. You may use the \u in your login script in lieu of the full name.
Password	The above user name's password as required by the remote system. You may use the \p in your login script in lieu of the full password.
Device type	The name of the modem device as defined in the Remote Access Systems Screen. You may have several ports setup with the same device type, and the dialer will use the first available. If a device for dialling out is not available, IOLAN+ will return an ICMP 'host unreachable' message (ICMP type 3 code 1).
Service type:	This specifies which protocol will be used when the link is established to the remote site. Choices are PPP, SLIP and CSLIP.
Inactivity	The period (in minutes) of inactivity on the SLIP/ PPP link before the port drops the call automatically. Setting this field to 0 turns the timeout feature off.
Phone number	The phone number of the remote system. Note that the \^ may be used as a delay. For example, a phone system that requires a 9 followed by a four-second delay before getting an outside line would require an entry like 9\4-2145551234.
The following characters are ignored '(', ')', '-', ' '	when included as part of the number.
Login-script	<p>The chat script that will be used to login to the remote system. It takes the form of the usual Send/Expect chat script you may already be familiar with. If no script is defined, this step is skipped (for example, hardwired connections). There are a few special characters used by IOLAN+ as described below:</p> <ul style="list-style-type: none"> "" expect nothing (for example, IOLAN+ starts the chat script) \r send a carriage return \n send new-line \u user name (sends the username from the User name field). \p password (sends the password from the password field). \1-\9 delay for number of seconds. \s space (Substitute this instead of a <space> value). \t phone# (sends the telephone number field). \d send the modem's dial command \\ escapes to '\' \b send a break.

Dial-out PAP Authentication

If a dial-out script is not used but a username and password are defined, IOLAN+ will send a PAP packet after establishing a PPP link and use the username and password defined for the remote site.

Remote site devices

This screen is used to define/setup the modem device. There are a lot of similarities between this screen and the UUCP devices file under Unix. It is possible to assign several ports the same device name, and the dialer daemon will automatically use the first available port. It is also possible to have these ports do 'double-duty' and serve as regular dial-in ports for dumb terminal access, SLIP or PPP in addition to the dial-out capability.

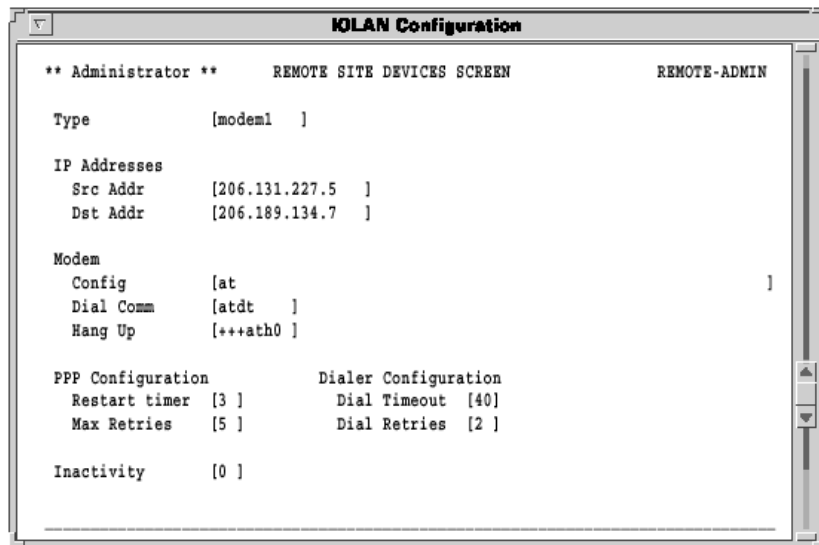

```

IOLAN Configuration
** Administrator **      REMOTE SITE DEVICES SCREEN      REMOTE-ADMIN

Type          [modem1  ]

IP Addresses
Src Addr     [206.131.227.5  ]
Dst Addr     [206.189.134.7  ]

Modem
Config       [at          ]
Dial Comm    [atdt       ]
Hang Up      [+++ath0    ]

PPP Configuration      Dialer Configuration
Restart timer [3 ]      Dial Timeout [40]
Max Retries   [5 ]      Dial Retries [2 ]

Inactivity     [0 ]
    
```

The following fields are important:

Field	Description
Type	The name of the modem assigned to a specific port. It is referenced from the Remote Access Systems Screen in the Device type field.
Dst Address	The address of the remote system IOLAN+ is calling into.
Config	The modem's configuration string. There are a few examples at the end of this document. Note: Leave this field blank for directly connected devices.
Restart timer	Amount of time in seconds before IOLAN+ retransmits PPP options.
Max Retries	Number of option retries before dropping the line.

Field	Description
Dial Timeout	Number of seconds to wait for the modem to establish link and respond.
Dial Retries	Number of times to attempt a connection to the remote site before giving up.

Tips

Hunt groups

You can setup several modems and use the same name for each group under Remote Site Devices. IOLAN+ will use the first available modem defined in Remote Site Devices, which if busy will default to the next available.

Chapter 7 Vmodem (Virtual modem)

You need to read this chapter if you want to...

You need to read this chapter if you want an overview of the IOLAN+ products Virtual modem feature.

This chapter provides information about the Vmodem feature of the IOLAN, which provides “modem like” communication between two IOLAN units on a network. This feature behaves like two modems connected across a telephone line.

This chapter includes the following sections;

- [About Vmodem \(Virtual modem\)](#) on page **90**
- [Configuring ports to use Vmodem](#) on page **91**
- [Setting/Modifying up Vmodem responses](#) on page **96**
- [Vmodem AT Commands](#) on page **97**.

About Vmodem (Virtual modem)

Vmodem is a feature of the IOLAN, which provides “modem like” communication between two IOLAN units on a network. This feature behaves like two modems connected across a telephone line.

Typically, you use the Vmodem feature when you have multiple devices communicating with a central site.

Vmodem allows you to achieve this using a single IOLAN unit at each end of the network without having to use multiple modems.

You use Vmodem because you want to avoid having to use multiple modems with the associated costs of calls and connections.

You use this feature by logging into the IOLAN via a terminal or telnet. You then enable and configure the Vmodem feature on the ports you want to use. You then connect your remote devices to the Vmodem ports on the IOLAN units.

Configuring ports to use Vmodem

The Vmodem feature has two modes, Normal and Dial on DTR.

- In normal mode, the Vmodem ports behave like a modem using basic AT commands to connect and disconnect.
- In Dial on DTR mode, the unit will automatically connect to a pre-configured destination.

Configuring ports to use Vmodem in Normal Mode

Carry out the following on all the participating IOLAN units;

1. Login to your IOLAN unit using either serial link or telnet as required.
2. Within the CONNECTIONS MENU now displayed, select a FREE connection and press the Enter key.
3. Select Commands > Admin mode and press the Enter key.
4. Select ADMINISTRATION MENU > Password and press the Enter key.
5. When prompted, enter the password and press the Enter key.

The ADMINISTRATION MENU is now updated to show additional features available in administration mode only.

6. In the updated ADMINISTRATION MENU; Select Port and press the Enter key.
At the Port prompt now displayed, type in the port to be configured for Vmodem and then press the Enter key.
7. In the PORT SETUP MENU; Highlight the Access field and press the Enter key.
8. Select Access >Values and press Enter key.
9. Select Access > VModem and press the Enter key.
You are now returned to the PORT SETUP MENU.

- 10.If the AT command +++ATH is required to hang up a connection;

- a. In the PORT SETUP MENU now displayed;
- b. Set the Mode field in the Access area to Telnet.
- c. Otherwise, set the Mode field to RAW.

11. Within the Hardware area, set the Monitor DSR field to No. Leave all other fields at their default settings.

12. In the PORT SETUP MENU screen; Press the Enter key.

When prompted, select Save and exit.

The ADMINISTRATION MENU is now displayed.

13. Press the Escape key to go back to the CONNECTIONS MENU.
14. In the CONNECTIONS MENU;
 - a. Select a FREE connection and press the Enter key.
 - b. Select Commands > CLI.
15. Connect the devices required to the Vmodem port on the IOLAN using the appropriate cable.
16. Repeat this procedure for all ports you want to configure to use Vmodem.

Making a Call using Vmodem in Normal Mode

Using Vmodem, telephone numbers are replaced by the IP address and TCP port of the Vmodem port you are calling.

1. To place a call using the device attached to a Vmodem port, the ATD sequence would be:
ATD<IP address><Port>

Where:

IP address is the IP address of the IOLAN unit that you are calling. where each number is represented by three digits (padded using zeros where necessary) with no separating dots.

Port is the local TCP port of the Vmodem port on the IOLAN unit you are calling, (By default the TCP port is 10000 plus the number of the serial port using Vmodem. For example, Port 12 would become 10012).

For example, to connect to a host IOLAN with an IP address of 196.65.144.236 and serial port 4 configured as Vmodem normal mode, the ATD sequence would be;

ATD19606514423610004 (This is not echoed by the port)

The Vmodem now returns a numerical or text string to indicate either a successful or failed connection.

2. You can configure how this indication is displayed see the appropriate section within this note.

Disconnecting a Call in Vmodem Normal Mode

To disconnect a call, the sequence +++ATH is sent to the Vmodem port.

Configuring Vmodem to use Dial on DTR mode

You use Dial on DTR mode because you want your device to dial a preconfigured number automatically when DTR is raised by the device.

To configure your port, proceed as follows;

1. Login to your IOLAN unit using either serial link or telnet.
2. Within the CONNECTIONS MENU now displayed, select a FREE connection and press the Enter key.
3. Select Commands > Admin mode and press the Enter key.
4. Select ADMINISTRATION MENU > Password and press the Enter key.
5. When prompted, enter the password and press the Enter key.

The ADMINISTRATION MENU is now updated to show additional features available in administration mode only.

6. In the updated ADMINISTRATION MENU;
7. Select Port and press the Enter key.
8. At the Port prompt now displayed, type in the port to be configured for Vmodem and then press the Enter key.
9. In the PORT SETUP MENU;
 - a. Highlight the Access field and press the Enter key.
 - b. Select Access >Values and press Enter key.
 - c. Select Access > VModem and press the Enter key.

You are now returned to the PORT SETUP MENU.

- 10.If the AT command +++ATH is required to hang up a connection;
- 11.In the PORT SETUP MENU now displayed;
- 12.Set the Mode field in the Access area to Telnet. Otherwise, set the Mode field to RAW.
- 13.Within the Hardware area, set the Monitor DSR field to Yes to enable Dial On Dtr mode.
- 14.At the Host field enter the HOST IOLAN IP address of the IOLAN to be auto-dialled.
- 15.In the Remote port field enter the TCP port of the serial port on the IOLAN to be auto-dialled.

(Note: this value is the Local port setting on the IOLAN to be auto-dialled which by default will be 10000 plus the serial port number of the Vmodem port to dial.)

- 16.Leave all other fields at their default settings.
- 17.In the PORT SETUP MENU screen;
 - a. Press the Enter key.
 - b. When prompted, select Save and exit.The ADMINISTRATION MENU is now displayed.

- c. Press the Escape key to go back to the CONNECTIONS MENU.
18. In the CONNECTIONS MENU;
 - a. Select a FREE connection and press the Enter key.
 - b. Select Commands > CLI.
 19. Connect the devices required to the Vmodem port on the IOLAN using the appropriate cable.
 20. Repeat this procedure for all ports you want to configure to use Vmodem.

Making a Call using Vmodem in Dial on DTR Mode

Using Vmodem in Dial on DTR mode will cause the host IP address and remote TCP port number to be called automatically on detection of the DTR signal being high.

1. Raising DTR (connected to DSR on the IOLAN Vmodem port) will make a connection to the pre-configured remote IOLAN unit.

Disconnecting a Call in Vmodem Dial on DTR Mode

1. Dropping DTR (connected to DSR on the IOLAN Vmodem port) will cause disconnection, typing +++ATH will produce the same result.

Setting/Modifying up Vmodem responses

The default responses for failure/success of a connection, may be customized. To configure the Vmodem responses, proceed as follows;

1. Login to your IOLAN unit using either serial link or telnet as required.
2. Within the CONNECTIONS MENU now displayed press the Enter key and select;
Commands > Admin mode and press the Enter key.
ADMINISTRATION MENU > Password and press the Enter key.

3. When prompted, enter the password and press the Enter key.

The ADMINISTRATION MENU is now updated to show additional features available in administration mode only.

4. In the updated ADMINISTRATION MENU, select:
Access and press the Enter key.
Access > Vmodem and press the Enter key.
5. In the VMODEM SETUP screen now displayed, set the following fields if required;

Success Indication String: Sent to the device when a connection succeeds.

If no string is entered, then the string "CONNECT" will be displayed with the connecting speed, for instance "CONNECT 9600".

Failure Indication String: Sent to the device when a connection fails.

If no string is entered, then the string "NO CARRIER" will be displayed.

Suppress Result Codes (Yes/No): If set to no, connection success/failure indication strings are sent to the connected device, otherwise these indications are suppressed.

Result Code Style (Verbose/Numeric):

If set to Verbose, then string result codes are sent to the connected device.

If set to Numeric, then the following characters are sent to the connected device:

'1' Successfully Connected

'2' Failed to Connect

'4' Error

Vmodem AT Commands

Ports configured for Vmodem operation interpret the following AT command codes.

Code	Description
+++ATH	Disconnect and hang-up a connection.
ATQ0	Enable connection responses for the duration of the session.
ATQ1	Suppress connection responses for the duration of the session.
ATV0	Selects numeric results codes for the duration of the session.
ATV1	Selects verbose results codes for the duration of the session.

All other AT sequences are accepted, but ignored by the Vmodem port.

Chapter 8 Printing

You need to read this chapter if you want to...

You need to read this chapter if you want information on printing from your IOLAN+ product.

This chapter provides information about the three methods of printing from your IOLAN+: ioland, LPD, or RCP. ioland is the recommended method, however this will depend on your application and operating system.

This chapter includes the following sections;

- [Introduction](#) on page [99](#)
- [Using ioland](#) on page [100](#)
- [Using LPD](#) on page [103](#)
- [Using RCP](#) on page [109](#).

Introduction

There are three methods of printing from your IOLAN+: ioland, LPD, or RCP. ioland is the recommended method, however this will depend on your application and operating system.

Method	Description
ioland	ioland provides a pseudo TTY interface to Unix print spoolers (not available for Windows®). This software and the binaries associated with it are available from the Perle CD provided with the unit or from the Perle website.
LPD	LPD is the 'line printer daemon' protocol supported by most operating systems including Windows® and Unix (for example, SCO, AIX, DG/UX, HP-UX, Linux, Solaris, etc.) for an LPD spooler for Windows® 95/98 see our website.
RCP	RCP is 'remote copy printing' and available on Unix systems. It requires a special interface script also found on the Perle CD.

Using ioland

We suggest you use the Perle ioland utility on the CD provided. The ioland utility can be used for Unix printing only. Ioland is a Unix tty port redirector. For non-UNIX applications use LPD, see [Using LPD](#) on page [103](#).

Configuration

```

IOLAN Configuration
** Administrator **
Hardware
Speed      [9600 ]
Parity     [None]
Bit        [8]
Stop       [1 ]
Break      [Disabled]
Monitor DSR [No ]
Monitor DCD [No ]

PORT SETUP MENU
Flow ctrl
Flow ctrl [XON/XOFF]
Input Flow [Enabled]
Output Flow [Enabled]

Keys
Hot  [^]
Quit [^@]
Del  [^@]
Echo [^@]

REMOTE-ADMIN
Intr  [^C]
Kill  [^U]
Sess  [^@]

IP Addresses
Src [ ]
Dst [ ]
Mask [ ]

User
Name [ ]
Terminal type [ansi]
TERM [ ]
Video pages [0]
CLI/Menu [Menu]
Reset Term [No]

Options
Keepalive [No]
Rlogin/Telnet [Telnet]
Debug options [No]
Map CR to CR LF [No]
Hex data [No]
Secure [No]
MOTD [No]

Access
Access [Local]
Authentication [None]
Mode [Telnet]
Connection [Initiated]
Host [204.17.209.1]
Remote Port [23]
Local Port [10006]
  
```

The following fields are important:

Field	Description
Flow ctrl	Set your IOLAN+ port flow control to Hardware. Then set your printer to use 'DTR Pacing' or 'Hardware' or 'Ready/Busy' flow control. Use the RS-232 printer cable pinout shown in Appendix E Cabling .
Access	Set this field to Remote. This sets the port of the terminal server to listen for connections coming from the network. There will be an INETD process running on the terminal server that does the listening. You can check on the status of this process by looking at the Netstat screen of the terminal server's Statistics menu (or show net from the CLI prompt).
Mode	Set this field to Telnet. This puts the port of the terminal server in Telnet mode, which will ensure that EOF is properly negotiated before closing down the TCP/IP connection, otherwise the tail end of a print job could be lost.
Local port	The INETD process running on the terminal server for this port is listening for TCP/IP connections on TCP port 10006.

The Host

If you are already familiar with ioland, all you have to do for the above configuration is:

```
ioland -T <server name> 10006 <device name>
```

This will start ioland process and create a device in /dev. If you are not familiar with the ioland program, [Chapter 9 Other devices setup](#).

Hint

Hunt groups are supported on IOLAN+ for printing. To use this, use the same number in the Port Setup local port field (for example, 1006).

Using LPD

IOLAN+ can be setup for receiving print jobs via LPD and this is a very simple method. It works for both Windows ® and Unix systems.

Configuration

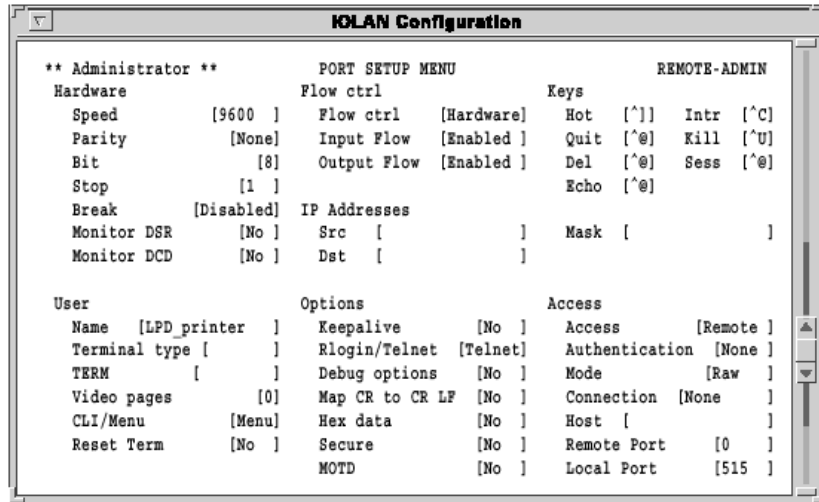

```

IOLAN Configuration
** Administrator **
Hardware          PORT SETUP MENU          Keys          REMOTE-ADMIN
Speed            [9600 ]          Flow ctrl    [Hardware]    Hot    [^]    Intr  [^C]
Parity           [None]          Input Flow   [Enabled ]    Quit   [^@]    Kill  [^U]
Bit              [8]            Output Flow  [Enabled ]    Del    [^@]    Sess  [^@]
Stop             [1 ]
Break            [Disabled]
Monitor DSR      [No ]          IP Addresses
Monitor DCD      [No ]          Src  [          ]    Mask  [          ]
Dst  [          ]

User              Options                    Access
Name  [LPD_printer ]    Keepalive [No ]          Access [Remote ]
Terminal type [          ]    Rlogin/Telnet [Telnet]    Authentication [None ]
TERM  [          ]        Debug options [No ]        Mode [Raw ]
Video pages [0]          Map CR to CR LF [No ]    Connection [None ]
CLI/Menu [Menu]          Hex data [No ]          Host [          ]
Reset Term [No ]        Secure [No ]          Remote Port [0 ]
MOTD [No ]              Local Port [515 ]
  
```

The following fields are important:

Field	Description
Flow control	Set your IOLAN+ port flow control to Hardware. Then set your printer to use 'DTR Pacing' or 'Hardware' or 'Ready/ Busy' flow control. Use the RS-232 printer cable pinout shown in the Cabling Guide (Appendix C), as this will save a print job if the printer is turned off or the cable becomes detached.
Name	The LPD client, as a reference to the printer, will use what you assign here. This is the printer queue name on IOLAN+.
Access	Set this field to Remote. This sets the port of the terminal server to listen for connections coming from the network. There will be an INETD process running on the terminal server that does the listening. You can check on the status of this process by looking at the NETSTAT screen of the terminal server's STATS menu (or show net).
Mode	The port of the terminal server will operate in a raw TCP/IP mode.
Local port	The INETD process running on the terminal server for this port is listening for TCP/IP connections on TCP port 515 (this is the LPD service number).

Accessing the Printer

The client is the machine that contains the file to be printed and may be running one of a range of operating systems and applications. The client must support LPD, Unix systems normally include a version of LPD and there are a number of TCP/IP applications for DOS/Windows ® that also support LPD.

When printing via LPD the client refers to the printer by IP address (or the name associated with this address from the host table) and printer name or queue name. This may take one of the following forms:

- The name of the terminal server and no queue name or port number. This will cause the print job to be printed on the first available LPD port on the terminal server of this name. The Name field in the Port Setup Menu does not need to be set.
- The name of the terminal server followed by a port number. For example if the queue name is server_name9 (or server_name09) then serial port 9 will receive the print job. Please note that in this example, the Name field in the Port Setup Menu need not be set.
- The printer name as set in the Name field of the Port Setup Menu. More than one serial port may have the same name allowing the server to create a hunt group of printers. The first available port to match that queue name will receive the print job.

A special feature of LPD with terminal servers is the ability to do carriage-return and line feed mapping at the server. This is accomplished by having a + appended to the client queue name and is valid for all of the above methods of access. Alternatively, you may enable the CR to CR LF mappingoption for the port.

Note

There is a maximum limit of 30 LPD connections per server, which may be distributed to all of the available LPD ports as required. If the maximum is exceeded then the request is rejected and the connection is closed.

LPD printing from DOS/Windows ®

At present it is possible to print from Windows ® or DOS although this will normally be accomplished via a separate application program like PC/TCP or Netmanage Chameleon. The new versions of Windows ® type operating systems either have or intended to have TCP/IP built into the operating system. Windows NT ® has a built-in LPD utility, and there are shareware packages on the Internet for Windows ® 95/98 (check our website see [Appendix F Contacting Perle](#)).

The documentation for each application or operating system should allow users to configure and use it with IOLAN+. The obvious advantage of using LPD to print is that the server can be used to connect a printer that will be shared between both DOS/Windows ® and Unix machines.

Under Windows ® the printer will be available from within other applications via the File option of the Windows ® menu bar.

The actual printer will be referenced by the Name of the terminal server serial port or, by the terminal server and port number in the same way that Unix uses the Name.

The server IP address should be included in the Host table before trying to setup the actual printer port.

LPD Printing from BSD Unix and Linux

This section should give you some idea of how to set-up printing via LPD on a Unix host. However, this will not be universally true as different versions of Unix have different configuration requirements. You may also wish to consult your Operating System documentation before attempting to add LPD.

The Unix host should have a printer database, for BSD and Linux type systems this will be the file `/etc/printcap` and there should be an entry within this file for the server's LPD port that looks something like the following:

```
#term_serv LPD Printer on serial port 16
Laser1|IOLAN LPD printer 16:\

:rp=LPD_printer:rm=term_serv:lp=:sf:\
:sd=/usr/spool/LPD/LPD_printer:\
:lf=/usr/spool/LPD/term_serv16/log:
```

Printing could then be accomplished using the following command:

```
lpr -PLaser1 <file>
```

A limitation of printing with LPD on the terminal server is that no formatting of text (apart from the + operation) can be carried out by the terminal server firmware. This is due to the lack of a spooler utility in the terminal server and the data being forwarded directly to the serial port.

To overcome this the local host must perform all of the necessary changes and then send these to the terminal server. Defining a printer queue as in the previous examples can do this.

If filtering or formatting is required then a local linking print queue needs to be created. This would be something like the following:

```
# Lcl q to link to term_serv LPD Printer on port 16
link-Laser1| IOLAN LPD Printer 16:\
:lp=/dev/null:sf:sd=/usr/spool/LPD/Laser1:\
:lf=/usr/spool/LPD/LPD_printer/log:\
:of=/etc/IOLAN/link-Laser1:
```

The shell script output file `link-Laser1` has the contents:

```
#!/bin/sh
lpr -PLaser1
```

This would be sufficient to print a header page and perform form feeds. If a specialised filter program is required for something like a plotter then the script may look something like the following:

```
#!/bin/sh
/usr/local/filter ` $@ ` | lpr -PLaser1
```

LPD Printing from SYS V Unix

Here is an example for setting up the System V spooling system (for example, Linux, Solaris, etc.) to print to IOLAN+ LPD daemon. This assumes that you will print to a port configured like the example above on an IOLAN+ called term_serv.

lpsystem -t bsd term_serv lpadmin -p Laser1 -s term_serv If the terminal server is not defined in the /etc/hosts file you may not get an error message from either the lpsystem or lpadmin commands, but the printer will not print.

If the lpsystem command is not performed, the lpadmin command will return an error indicating that the system named in the -s parameter does not exist even though the system is listed in the /etc/hosts file.

Note

Although it is possible to create a printer spool on the IOLAN+, UNIX lpd queues only print one job at a time. The host will wait for one job to complete before spooling the second so all jobs will go to the same queue and print from the same IOLAN+ port.

LPD printing from AIX

Use SMIT to configure remote printer.

LPD printing from HP/UX

Use SAM to configure remote printer.

Hint

Hunt groups are supported on IOLAN+ for printing. To use this, use the same queue name in the IOLAN+ Port Setup name field.

Using RCP

RCP is used as an alternative option (where LPD and ioland are not available). It is a Unix only command set. A script is provided on the Perle CD for RCP.

Configuration

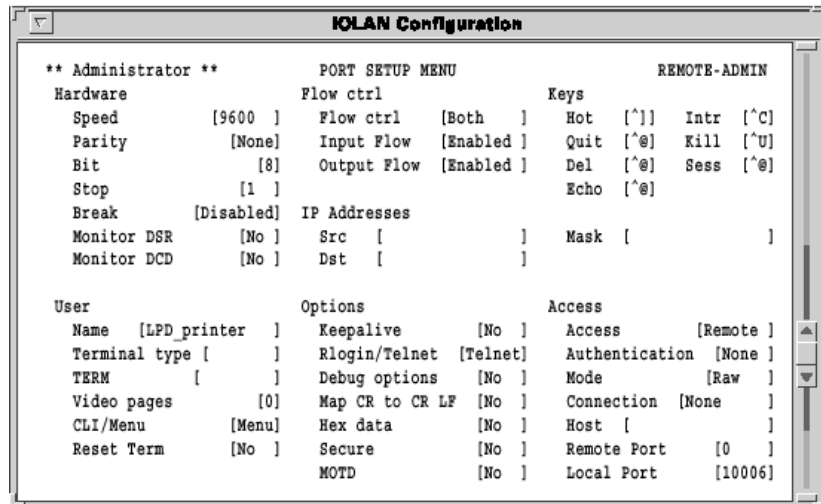

```

IOLAN Configuration

** Administrator **

Hardware          Flow ctrl          Keys          REMOTE-ADMIN
Speed             [9600 ]           Flow ctrl    [Both ]       Hot    [^]         Intr  [^C]
Parity            [None]            Input Flow   [Enabled ]    Quit  [^@]        Kill  [^U]
Bit               [8]              Output Flow  [Enabled ]    Del   [^@]        Sess  [^@]
Stop              [1 ]              Echo         [^@]
Break             [Disabled]
Monitor DSR       [No ]            IP Addresses
Monitor DCD       [No ]            Src  [          ]   Mask  [          ]
                  Dst  [          ]

User              Options            Access
Name [LPD_printer ]  Keepalive         [No ]           Access  [Remote ]
Terminal type [    ]           Rlogin/Telnet     [Telnet]        Authentication [None ]
TERM [            ]  Debug options     [No ]           Mode     [Raw ]
Video pages      [0]              Map CR to CR LF  [No ]           Connection [None ]
CLI/Menu         [Menu]           Hex data         [No ]           Host     [          ]
Reset Term       [No ]           Secure          [No ]           Remote Port [0 ]
                  MOTD            [No ]           Local Port [10006]
    
```

The following fields are important:

Field	Description
Flow ctrl	Set your IOLAN+ port flow control to Both. This will invoke both Hardware (RTS/CTS) and XON/XOFF flow control on IOLAN+. Then set your printer to use XON/XOFF. Use the RS-232 cable pinout described in Appendix E Cabling , as this will stop a print job if the printer is turned off or the cable becomes detached.
Access	Set this field to Remote. This sets the port of the terminal server to listen for connections coming from the network. There will be an INETD process running on the terminal server that does the listening. You can check on the status of this process by looking at the NETSTAT screen of the terminal server's Statistics Menu (or show net from CLI).

Field	Description
Mode	The port of the terminal server will operate in a raw TCP/IP mode.
Local port	The INETD process running on the terminal server for this port is listening for TCP/IP connections on TCP port 514 (this is the RCP service number).

The Host

On systems where LPD or a binary for ioland is not available, or is found to be unreliable due to limitations in the OS, RCP provides a useful, if limited, alternative method for printing. The port/group of ports must be configured to listen to the RCP port, which is port 514. Users can then copy files to the server using the following command syntax:

```
rcp <file> <server>:tty [port #]
```

It is worth noting that the RCP will fail if the port (or all the ports in the hunt group) is in use when the RCP command is attempted. If you wish to use RCP as part of a System V print spooler script, it is essential that the script checks the return status of the RCP command.

Using RCP with Unix System V line printer spoolers.

1. Log in as root and create a print queue for the printer with `/dev/null` as the device port. For example, create an HP LaserJet printer queue via the command:

```
/usr/lib/lpadmin -hpjet -v/dev/null -mHPLaserJet
```

Do not accept or enable the printer at this stage.

2. Go into the directory containing the interface scripts for all printers. This is normally found in:

```
/usr/spool/lp/admins/lp/interfaces (Rel 3 Unix).  
/etc/lp/interfaces (Rel 4 Unix).  
/usr/spool/lp/interfaces (XENIX).
```

3. Find the interface shell script for this printer and copy it to a file with the suffix `.orig`. using the example: `cp hpjet hpjet.orig`
4. Copy the Server RCP shell script from the TSSD support disk to the interface script, e.g: `cp /etc/perle/src/perle.rcp hpjet`
5. Having created the `hpjet` file set the permissions to allow execution of the script, e.g: `chmod a+x hpjet`
6. Edit the interface script and insert the desired server name and port number. For example, if the name is 'iceland' and the printer is attached to port 8 (numbering from 1 to 16). Then the line:

```
rcp $TMP <server name>:tty<port number>
```

becomes:

```
rcp $TMP iceland:tty8
```

Some Unix systems may require the full pathname of the 'RCP' command. For example:

```
/usr/ucb/rcp $TMP iceland:tty8
```

7. Activate the printer for use, e.g:

```
/usr/lib/accept hpjet enable hpjet
```
8. Set up the IOLAN+ port for RCP printing by changing the Local Port field in the Access section of the Port Setup Menu to 514.

RCP printing on a spooler system based on BSD Unix

Currently, the RCP printing utility will not work if the of filter is used in conjunction with any other filter.

1. Log in as root and create a print queue for the printer with /dev/null as the device port. For example, create a printer queue by placing this record in /etc/printcap:

```
rcp Printer to IOLAN port 8
IOLAN8|IOLAN rcp Printer:\
:lp=/dev/null:\
:sf:\
:sd=/usr/spool/LPD/IOLAN8:\
:lf=/usr/spool/LPD/IOLAN8/log:\
:if=/etc/perle/hpif:
```

2. Go into the directory containing the desired text filter program intended for the if field. If there is no filter required for this queue then create a dummy filter program which calls the cat command with no arguments.

3. Link the generic filter program to a file with the suffix '.orig'. This generic filter program may be in use by other printer queues and so is left untouched. Using the example:

```
ln -s <filter-name> /etc/perle/hpif.orig
```

4. Copy the Perle RCP shell script to the Perle directory /etc/perle. That is:

```
cp perle.rcp /etc/perle/hpif
```

5. Edit the interface script and insert the desired IOLAN+ name and port number. For example, if the IOLAN+ name is 'iceland' and the printer is attached to port 8 (numbering from 1 to 16).

Then the line:

```
rcp $TMP <IOLAN name>:tty<port number>
```

becomes:

```
rcp $TMP iceland:tty8
```

Some Unix systems may require the full pathname of the 'RCP' command. For example, SunOS Unix and may require the line to become:

```
/usr/ucb/rcp $TMP iceland:tty8
```

6. Activate the printer for use. That is:

```
lpc start IOLAN8
lpc enable IOLAN8
```

7. Set up the IOLAN+ port for RCP printing. See the relevant section in the guide or call Technical Support for an example fax. See [Appendix F Contacting Perle](#).

Setting up RCP printing on AIX

See the Perle website for latest information [Appendix F Contacting Perle](#).

Tips Hunt groups: There is no hunt group method using RCP.

Chapter 9 Other devices setup

You need to read this chapter if you want to...

You need to read this chapter if you want information on setting up printers and data acquisition type equipment.

This chapter provides information on setting up printers and data acquisition type equipment, including retail point-of-sale equipment.

This chapter includes the following sections;

- [Introduction](#) on page [115](#)
- [Reverse Telnet Port Configuration](#) on page [116](#)
- [Perle IOLAND Utility](#) on page [118](#)
- [Tips](#) on page [124](#).

Introduction

IOLAN+ is a very versatile product and can handle a lot of creative applications. This section deals with setting up printers and data acquisition type equipment, including retail point-of-sale equipment. Many types of RS-232 equipment can be attached including:

- Retail point-of-sale (POS) equipment
- Maintenance ports on network equipment (for monitoring)
- Making terminals with 'fixed ttys'
- Manufacturing equipment

IOLAN+ accomplishes this by using a reverse telnet connection. On Unix you utilise the ioland software supplied on the Perle CD. For Windows ® , consult the support section of the web sites for the latest support software for dial-out applications.

Reverse Telnet Port Configuration

This setup is used when you need to access a serial port from the network. For example you might want to collect data from a serial device such as a barcode scanner, POS terminal, etc. Or you can tie a login to a specific Unix tty device (using ioland). For Unix you use the Perle utility ioland. For Windows © system consult the Perle website.

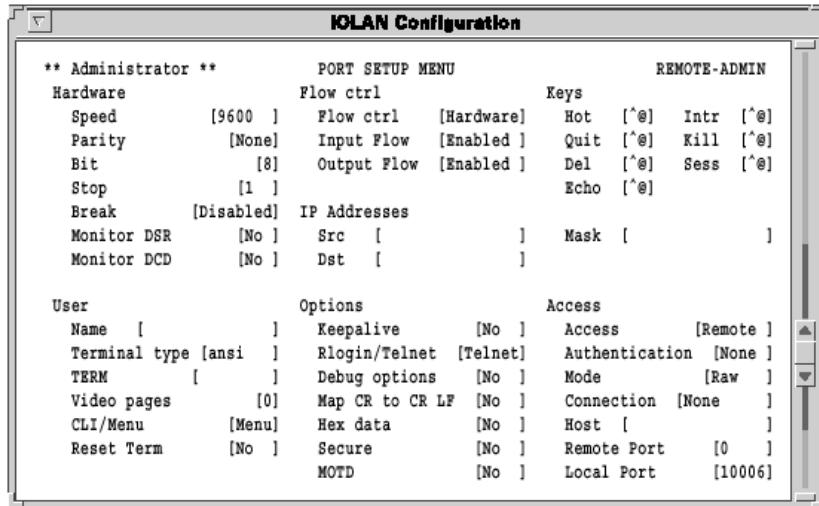

The following fields are important:

Fields	Description
Keys	Set all your Keys to ^@.
Access	Set this field to Remote. This sets the port of the terminal server to listen for connections coming from the network. There will be an INETD process running on the terminal server that does the listening. You can check on the status of this process by looking at the Netstat screen of the terminal server's Stats menu.
Mode	Set this field to Raw.
Local Port	The INETD process running on the terminal server for this port is listening for TCP/IP connections on TCP port 10006 (for port 6).

The Host

If you are already familiar with ioland, all you have to do for the above configuration on Unix is:

```
ioland -p <server name> 10006 <device name>
```

This will start the ioland process in permanent mode and create a device in /dev. If you are not familiar with the ioland program, read the following section.

If you are using Windows ® check the web page for the latest information on dial-out connectivity.

Perle IOLAND Utility

IOLAN+ peripheral daemon provides a client process with a full-duplex and transparent interface to a server port of its choice, via a pseudo-tty device. This presents a tty-like interface to the application in much the same way as a serial port.

The daemon is primarily intended as an interface between the client process and a printer, modem or some data acquisition device. In the case of printers, it is recommended that the LPD protocol is first assessed as a suitable printing solution before the IOLAN+ daemon.

By default, the daemon will fork into two processes during the start of a data transfer. The parent process will transfer data from the client to the server while the child process will transfer data from the server to the client. The parent also handles all the control aspects of the client-server link. The child process is normally terminated when the client process closes the slave pseudo-tty unless the `-p` option is used. In this case, the child is created at startup time and remains.

If the daemon is started without any arguments it will try and open the configuration file `/etc/ioland.cf` which contains instructions on which daemons to start, for which peripherals, plus any optional arguments.

Alternatively, a single daemon can be started from the shell with various arguments specified.

Mandatory arguments

There are three mandatory arguments the daemon requires to mediate between the client and server port:

Argument	Description
Server	The host name of IOLAN+ that has the attached printer or terminal.
Port	The TCP port on which the IOLAN+ port is listening for connection requests.
Link	A mnemonic filename in /dev which shall be linked to the slave pseudo-ty selected by the daemon. This should be used as the interface device for client processes since the pseudo-ty may change during the daemon lifetime.

Optional arguments

The other optional arguments modify the behaviour of the daemon in the way it controls connections, and processes data to and from the peripheral. They are defined as follows:

Argument	Description
-T	Enable Telnet protocol processing. This is useful to ensure that the last data block of a print job has reached IOLAN+ before closing the TCP connection. If the end of print jobs are still being lost despite using this option then it is advised to set the stty option 'noflsh' on the slave pseudo-tty if it is supported. This may require the -m or -a options. Alternatively, most line printer spoolers employ a delay before closing the printer port to ensure no pending output is accidentally flushed. It may be possible to increase this delay if the above solutions are not enough. Make sure the port is set to telnet mode in the Port Setup Menu.
-p	The daemon maintains a continuous TCP connection to the IOLAN+ port. This is useful for applications that require exclusive and uninterrupted access to a device. Note that no other daemon will be able to access such a port if any daemon is running to that port with this option.
-h	Hangs up the pseudo-tty if the TCP connection is lost. This mimics the situation in which a real serial port loses a signal such as DCD. In the same manner as the serial port, a SIGHUP signal will be sent to all processes that have the slave pseudo-tty as their controlling tty. See the -w option.
-n	Converts all carriage-returns read from the client process to carriage-return and line-feed. This is useful if using ioland for printing and the print job is off the right margin (for example, 'stair stepping').
-m	Push the STREAMS tty modules onto the slave pseudo-tty. This is useful for applications that expect to modify tty parameters as if a hardware device was attached. The modules pushed are the line discipline (normally called ldisc) and the hardware emulation (if supported). This option requires that the pseudo-tty architecture is based on the STREAMS I/O mechanism. The recommended Unix variants for using this option are those based on System V Release 3. Variants based on System V Release 4 should first try the -a option.
-a	Use the autopush facility to push STREAMS modules onto the slave pseudo-tty. This facility is supported on Unix System V Release 4 variants.
-u	Discard all data received from the peripheral. This is useful in cases where the peripheral is sending unwanted data to the host, which is not being read by the client and therefore may cause blockage problems on the pseudo-tty.
-w	Used with the -h and -p options. By default, on a hang-up, the daemon will open a new pseudo-tty before it has reconnected to the IOLAN+ port. This option does the opposite and tries to re-establish the TCP connection first.

Argument	Description
-o	Used with the -p option. This option prevents the slave pseudo-tty from closing so as to prevent any flushing of data that may occur. With this option set, the daemon will not close the TCP connection so its use is not advised for modems, as line hang-ups may not be initiated. It is useful for slow printers that may lose data on pseudo-tty close.
-f<file>	Specify a different configuration file. If the pathname is relative, the current working directory will be used.
-F	This option causes ioland to use the same pseudotty each and every time (fixed tty). The syntax for using this option is: ioland -F <other options> <iolan> <master device> <slave device> e.g: ioland -F bronto ptyp3 ttyp3
-k<n>	This option checks if the TCP connection is still alive every n seconds. If the test fails, the child daemon process dies and signals the parent daemon that the connection is lost.
-K	This invokes 'silent keepalives'. Normal keepalives set by the -k flag send ASCII text messages which can go through iolan and ioland and become visible to users and applications. The -K flag prevents this.
-s<desired character transfer rate>	This option causes ioland to 'meter' characters sent to the iolan.
-x<n>	Set the daemon debug/diagnostic level to n. On startup, a log file called /etc/ioland.lg is created (if not already there). All daemons on the host will write their debug and diagnostic messages to this file with a timestamp, daemon process id and arguments attached to the actual diagnostic. The debug and diagnostics levels are: 0 Lets the world know we're alive — but nothing else. 1 Reports startup options. 2 Reports connection and disconnection events. 4 Reports numbers of characters being sent/received. 8 Displays data written to the client process. 16 Displays data written to IOLAN+. 32 Reports telnet negotiations. 64 Displays data read from IOLAN+. 128 Displays data read from the client process. Adding the desired level numbers together can combine these levels. Care should be taken when a high debug level is set because the log file could grow too large.

Argument	Description
-s<string>	Used to transmit breaks to modems. If the daemon reads in the specified string from the client it will send a Telnet 'Do Break' command to IOLAN+. The maximum length of the string is 15 characters though, for the sake of efficiency, a minimal length should be used so long as the string is not accidentally duplicated by the real data. This option requires you to also use the -T option.
-c<n>	Network connection timeout option. The daemon will try for n seconds to establish a TCP connection after which time it will abort and discard any pending data. The default is to try forever.

Example daemon configuration file

An example of a daemon configuration file is:

```
-x3 -T IOLAN1 10011 IOLAN1.11
```

```
-x35 -T -a -h -s xxx -c60 IOLAN1 10013 IOLAN1.13
```

```
-x39 -p -T -h -a -k60 IOLAN2 10009 IOLAN2.9
```

Each line represents a daemon to be started with the arguments on that line.

The first is a simple printer configuration, the second is a complex modem configuration while the third is a configuration more suited to a daemon with a terminal attached and a getty running as the client process. Normally, the debug level is set to a minimal level such as three.

Tips

Unix Notes On Unix variants based on System V Release 3, clients that are interactive shell processes may not be able to handle the interrupt, quit and break keys properly. This is a deficiency in the pseudo-tty drivers and not the daemon.

On some System V Release 4 variants, if the daemon writes to a non-existent client, the pseudo-tty may irretrievably hang up. In general, make sure there is always a client process running if there is the possibility of data being received for it.

On some systems such as SunOS, XENIX and AIX a break received from the peripheral is not passed to the client properly. If the client wishes to make the break act like an interrupt key (for example, when the stty options - ignbrk and brkintr are set) then this can be achieved by setting the Break field on the IOLAN+ Port Setup Menu to 'Brkintr'.

On SunOS, if a getty is the client process running to a terminal then the login prompt may be corrupted on the screen but this goes when the user name is typed in. The UUCP command uucico may not work with ioland on Solaris 2.1 (Intel).

Some systems may not properly propagate the SIGHUP signal associated with the -h option.

Chapter 10 The menu interface

You need to read this chapter if you want to...

You need to read this chapter if you want an overview of the IOLAN+ menu interface.

This chapter describes the menu system and the fields within them. All of the menus are covered and referenced in this section.

This chapter includes the following sections;

- [Introduction to menu commands](#) on page [126](#)
- [Connections menu](#) on page [128](#)
- [Port setup menu](#) on page [130](#)
- [Administration menu](#) on page [139](#)
- [Access menu](#) on page [141](#)
- [Change password options](#) on page [148](#)
- [Gateway menu](#) on page [149](#)
- [Host Address menu](#) on page [150](#)
- [Kill command](#) on page [150](#)
- [Lines menu](#) on page [151](#)
- [Port menu](#) on page [154](#)
- [Quit command](#) on page [154](#)
- [Reboot command](#) on page [154](#)
- [Server configuration menu](#) on page [155](#)
- [Statistics screens](#) on page [158](#)
- [Trap function](#) on page [159](#).

Introduction to menu commands

This chapter describes the menu system and the fields within them. You move around the menus with the arrow keys or by using the first letter of the associated command. When you are in an editable menu, the arrow key is used to move around the various fields. Pressing the **Enter** key will usually bring up the following exit menu.

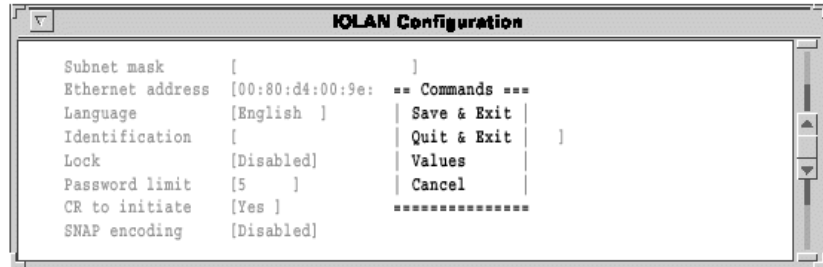

Command Descriptions

Menu option	Description
Save and Exit	All changes to the menu screen are saved and the user is returned to the next higher level screen.
Quit and Exit	The user is returned to the higher level screen and any changes are ignored (that is, nothing is saved).
Values	Certain data fields take only a fixed range of values (for example, bps rates, number of stop bits, etc.). When this command is selected, it displays those values.
Cancel	Cancels the Command Options window and returns to current menu for additional editing.

Pressing Esc cancels the Command Options window (works the same as Cancel). Other than mastering the difference between the arrow key and the Enter key, there are several other special fields and keys.

Toggle fields

Some data fields have a set of acceptable values. An example of this is the bps rate setting. To alter the value displayed in these fields press the space bar. The Values option on the commands pop-up menu can also be used.

Fast keys

A fast key allows the user to jump from one menu to another avoiding the normal path. Most of the commonly used options available from the Connections Menu can be accessed via fast keys. These are listed in the following:

Menu option	Fast key sequence	Description
Telnet	CRTL T	Make a Telnet connection
Rlogin	CRTL R	Make an Rlogin connection
Port	CRTL P	Enter the Port Setup Menu
Admin	CRTL A	Enter the Administration menus
Logout	CRTL D	Log out of the Server
Stats	CRTL X WCRTL T	Enters the statistics screens

Connections menu

This is the top level menu, normally the first thing a user sees when they power up their terminal. The main focus of this screen is the list of connection states, showing which host each of the four sessions is connected to (or if it is FREE).

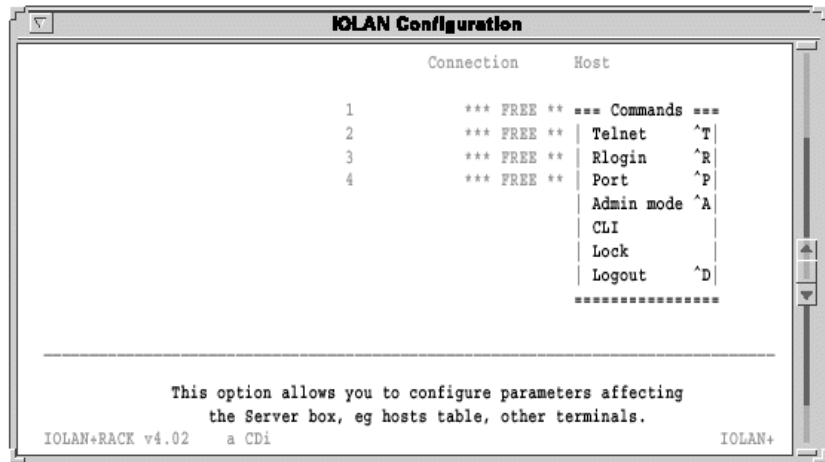

Figure 31: Connections Menu - Commands pop-up menu.

Pressing Enter at any of the four FREE fields presents the Commands pop-up menu. If it was not free, the Telnet and Rlogin fields would have been replaced by Close connection and Resume connection signifying there is a session present.

The *** FREE *** message would be replaced by the name or IP address of the connected host.

The following describes the options that can appear in the above menu:

Option	Description
Telnet	This option allows you to make a connection to a specified host on the network using telnet. When this command is selected, another pop-up menu appears, giving you the host table list. In addition, there is a specify host/IP address option you can use for other IP addresses and host names.
Rlogin	This performs the same function as the Telnet open command, but uses the Rlogin protocol. While Telnet is the most commonly used protocol, Rlogin can also be used (especially over WAN connections because Rlogin packets are smaller).
Resume Connection	This option only appears if there is a current connection open. It allows you to carry on working on a host.
Close Connection	This option also appears only if the current connection is open and will close the session on a host machine. It is recommended to logout before closing the connection.
Port	This allows users to change the characteristics of their serial port. See Port setup menu on page 130.
Admin mode	This takes the user into the Administration Menu(s) (also covered in this chapter).
CLI	Selecting this function changes the port back into command line or CLI mode. To get back to the menus use set menu from the CLI prompt.
Lock	<p>This function allows the user to lock the port they are on for security purposes. When this function is selected the user is prompted for a password then asked to verify it again. Once locked a port can only be unlocked by the successful entry of the password.</p> <p>Note: If a user accidentally locks their port the Administrator can use the kill command on the Administration Menu to free the port.</p>
Logout	This function logs the user completely out of the IOLAN+. From the Connections Menu pressing CTRL D also logs the user out of the system.

Port setup menu

This menu allows the user to set up all of the parameters associated with a port. The administrator can alter the set-up of any port on the IOLAN+ while a user can only alter the set-up for their own port.

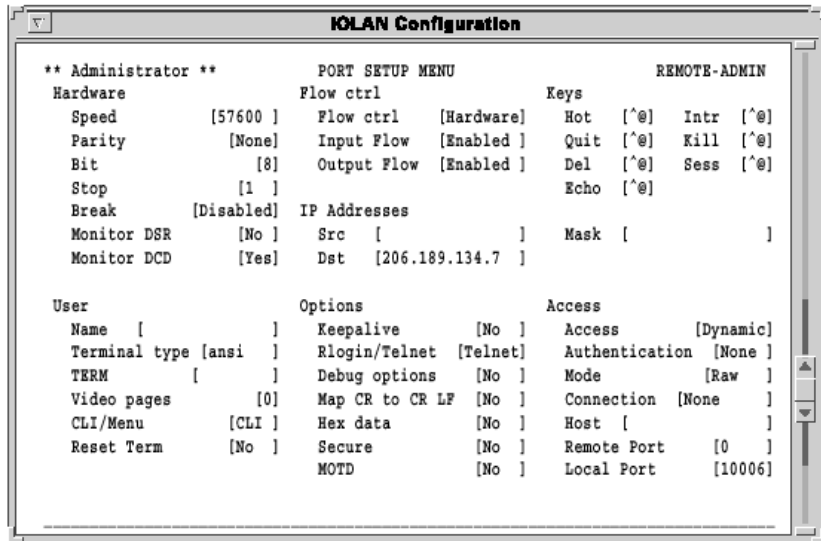

This menu is divided into several separate sections, each of which can be accessed independently by the administrator. To simplify the sequence, these are described separately.

Hardware

The hardware section defines port type and is used for setting up the hardware configuration of the modem, terminal, printer or PC session. This section is always used. The parameters are as follows:

Option	Description
Speed	This field sets the baud rate of the port and can be set to the following values: 50, 75, 110, 150, 300, 600, 1200, 1800, 2400, 4800, 9600, 19200, 38400, 57600, 115200. The default setting is 9600.
Parity	This field sets the parity of the port to even, odd, mark, space or none. The default parity is <i>None</i> .
Bit	This sets the number of data bits that are used by the port from 5-8. The default is 8.
Stop	This defines how many stop bits the port uses to either 1, 1.5, 2. The default is 1.
Break	This field determines how the IOLAN+ reacts to the break key being pressed on the terminal. There are four possible settings: Disabled The IOLAN+ ignores the break key completely and it is not passed through to the host. This is the default setting. Local The IOLAN+ deals with the break locally. If the user is in a session the break key has the same effect as a hot key (that is, it returns the user to the Connections Menu.) Remote When a break key is pressed the IOLAN+ translates this into a telnet break signal which it sends to the host machine. Brkintr This mode operates in the same manner as the remote setting except that instead of generating a break signal the IOLAN+ generates an interrupt signal and sends it to the host.
Monitor DSR	This field specifies whether the RS-232 signal DSR (data set ready) should be monitored. This is used with modems. Default is No.
Monitor DCD	This field specifies whether the RS-232 signal DCD (data carrier detect) should be monitored. This is used with modems. Default is No.

User

The User section defines various user parameters such as name and terminal type. Most fields are used in this section.

A full description is given below:

Option	Description
Name	This field defines the user name of this port on IOLAN+. Any string of up to 14 characters can be entered. This name is displayed on the top left hand corner of the menu screens. It is also listed in the statistics screens so that the administrator can see who is using each port. If this field is left blank then a user is prompted for their user name before being given access to the communications server menus. This field is also passed to the host when using telnet or rlogin. Default is blank.
Terminal type	This field defines the type of terminal that is attached to this port. The possible values are undef (undefined), ansi, dumb, vt100, vt320, wyse50, wyse60, tvi925, ibm3151, vt320, falco, hp700. Press the space bar to toggle through these values. If none of these are applicable then the CLI mode can be used. When an rlogin connection is made, the unit passes this terminal type to the host machine. Default is blank.
TERM	This field can contain up to 8 characters. If this field is filled in, IOLAN+ sends this string as the terminal type, instead of the field above. This allows the user to pass through IOLAN+ an unsupported terminal type or addition identity information for security. Default is blank.
Video pages	This field defines how many video pages the terminal in question has. If this value is set greater than zero IOLAN+ uses the video pages on the terminal to allow it to refresh screens between session switching. Not all terminals support video pages (mainly Wyse 60's). Default is 0.
CLI/Menu	This field defines whether IOLAN+ is using the CLI or the menu interface. If the terminal is configured for menu interface but the terminal type is undefined or dumb, then the unit remains in the CLI. Default will be Menu.
Reset Term	This field defines whether the terminal type should be reset when a user logs out. This is a very useful feature when the port is connected to a modem. When a user logs out of IOLAN+ it resets the terminal type to dumb, so the next person starts off in CLI mode and is able to set the terminal type correctly. Default is No.

Flow control

This section defines the various flow control options used by IOLAN+. This section is always used. The parameters are:

Option	Description
Flow Ctrl	This field defines which method of flow control to be used by this port, either XON/XOFF, HARDWARE, BOTH, none or WANG. To use HARDWARE flow control the correct cable must be used (see Appendix E Cabling). WANG is a special option designed for WANG terminal flow control applications. The default is to use XON/XOFF.
Input Flow	This field allows you to define if the input flow control is to be used. Default is Enabled.
Output Flow	This field allows you to define if the output flow control is to be used. Default is Enabled.

IP address

This section of the menu deals with remote access and modem sessions only. The parameters are as follows:

Option	Description
Src	This is the source IP address of the port for PPP/SLIP connections. If blank, the IOLAN+ IP address is used.
Dst	This is the destination IP address of the PPP/SLIP connections. If blank, the remote host must supply the IP address. If filled in, you designate an assigned IP address to loan the remote host. If the secure field on the Port Menu is No, this can be overridden by the incoming host.
Mask	This is the subnet mask which controls the range of IP addresses accessible from the port (when using remote access).

Options

This section of the menu deals mainly with the telnet options and is the least used. Most of these options default to No.

Option	Description
Keepalive	This option specifies whether IOLAN+ should send keepalive messages to the host machines it is connected to. Default is No.
Rlogin/Telnet	This field specifies which of the two options should be listed first in the Commands menu. Default is telnet.
Debug options	This field defines whether the telnet options processing should be displayed and is used for troubleshooting. Default is No.
Map CR to CR LF	This field defines whether the IOLAN+ will add a line feed to every carriage return on data going out to the serial port. Default is No.
Hex data	When this field is set to Yes, IOLAN+ displays all of the data it receives on this port in hex format as well as in ASCII. This is used for troubleshooting. Default is No.
Secure	Specifies the level of security to be applied to the port in question. There are four selectable values. Default is No.
No	Access to the administration mode is enabled from this port. Port will accept IP addresses.
Yes	Access to administration mode is disabled for this port. Port will reject IP addresses.
LAN	Access to administration mode is disabled and dial-in access via PPP/SLIP is disabled. Local network access commands telnet, rlogin and connect are enabled.
WAN	Access to administration is disabled and local network access commands, telnet, rlogin and connect are disabled. Dial-in access via PPP/SLIP is enabled.
MOTD	This yes/no option specifies whether a message of the day is to be displayed to the user before logging on to the port. The actual text of the message is a file on the boot host (see Server configuration menu on page 155).

Keys

This section defines the various accelerator keys that IOLAN+ responds to. This section is optionally used. The parameters are as follows:

Option	Description
Hot	This is the key used to escape from a host connection back to the IOLAN+ Connection Menu. For instance, if you are in a login shell on a host machine, pressing the hot-key takes you back to IOLAN+. The default is ^].
Intr	This is a user-definable interrupt key. When selected IOLAN+ generates a telnet 'interrupt process' signal to the remote host. The default is ^C.
Quit	This field defines the character that generates a telnet BREAK across the network. Default is ^@.
Del	This field defines the character that generates a telnet erase character signal across the network. In addition, this key can be used to 'reprogram' the interpretation of the <left-arrow> key when operating in the menu mode. If the users terminal generates the same key sequence for <Left-Arrow> and <Backspace>, then setting this key to Ctrl-H (^H), causes the <Left-arrow> and <Backspace> keys to be treated as 'delete the last character typed in'. Default is ^@.
Kill	This field defines the character that generates a telnet erase line signal across the network. Default is ^U.
Sess	This key allows users to switch directly from one session to another without going back through the server menus. This key should be followed immediately by the session number the user wishes to go to. For example, if this key is set to Ctrl-F and you want to switch to session 2, press Ctrl-F2. The default value is ^@.
Echo	If this key is given a value then any active telnet session on that port can toggle between local and remote character echoing done by IOLAN+ or by the remote host. Default is ^@.

Note

Each of the keys can be set as a single character, or as a control character. To set the key as a control character the symbol '^' should be used followed by the relevant key. Alphabetic characters should be specified in upper case. To disable a particular key the user should enter ^@ in the field.

Access

This section controls the type of the connection made from this port. This is the most important section in defining a port. The parameters are as follows:

Option	Description
Access	This field defines the type of service that is operating on this port. Default is Local.
Local	This is the normal setting for terminals/PCs.
Remote	This setting indIOLAN+ should be listening on the ethernet for connections from a remote host. The TCP port for the communications server to listen on, must be entered in the Local Port field. This setting should be used for printers, dial-out modems and reverse telnet connections.
Dynamic	This setting should be used for dial-in/dial-out modems. This setting is a combination of the local and remote settings. The communications server listens both on the serial port for incoming characters and on the network for incoming connections. When it gets either, it behaves as the appropriate type of connection until that session is terminated, whereupon it goes back to listening again.
SLIP	This will set the port into SLIP mode.
PPP	This setting puts the port into a dedicated PPP line.
Listen	This setting is similar to Remote, however, DTR/RTS will only be raised once a network connection is establish.
None	Sets port to disabled.
CSLIP	This setting puts the port into dedicated CSLIP status.
Vmodem	This setting causes the IOLAN port to behave as if it were a modem to the attached device. See the Chapter 7 Vmodem (Virtual modem) for details.
Authentication	This field defines how a user logs in. Default is none. None This sets authentication off. Local This forces the incoming user to enter the IOLAN+ login authentication password (same password for all ports). Host This is full authentication requiring a user ID and password that will be checked against a designated authentication host. Both This provides two levels of security with Local authentication first, then Host.

Option	Description
Mode	This field defines whether the connection is raw or telnet. A raw connection is a straight TCP connection. Setting the mode to telnet causes it to do the telnet negotiations with a network connection. This should be set to raw for RCP and LPD printing & modem connections, and be set to telnet for reverse telnet connections.
Connection	This field defines whether the user has access to multiple connections or only a single connection, and the level of control the user has over these connections.
None	IOLAN+ does not try to initiate any connections. The user has full control and, access to all 4 sessions. This is the default.
Preferred	IOLAN+ makes an immediate connection to the indicated host machine and port number. The Host, Remote and Mode fields must be filled in. Although the user is connected to a designated host, the user can hot key ^] back from this connection to the unit. This allows a user to configure the system so that they always log into one machine, but still have the option of connecting to others.
Dedicated	IOLAN+ makes an immediate connection to the indicated host and port number. The user is limited to only a single connection to the indicated host, and can not hot key back to the IOLAN+ menus. The Host, Remote and Mode fields must be set properly.
Initiated	This setting is similar to the Dedicated connection, but requires the user to enter the return key before initiating a connection. It is widely used for terminal/PC connections.
Host	This field defines the remote host to be connected to. Either a host name or an IP address may be used. If a name is entered it must be in the host table. Default is blank.
Remote Port	This field defines the remote TCP port number for IOLAN+ to connect to. Use port number 23 for telnet and 513 for rlogin. Default is 0.
Local Port	This field defines the local TCP port for IOLAN+ to listen on. The port default to 10000 plus the number of the port.

Administration menu

The Administration Menu allows the user access to the main configuration functions. All of the options can be accessed by a normal user (unless the secure field is set to Yes). None of the configuration details may be altered unless the user has entered the administrator's password.

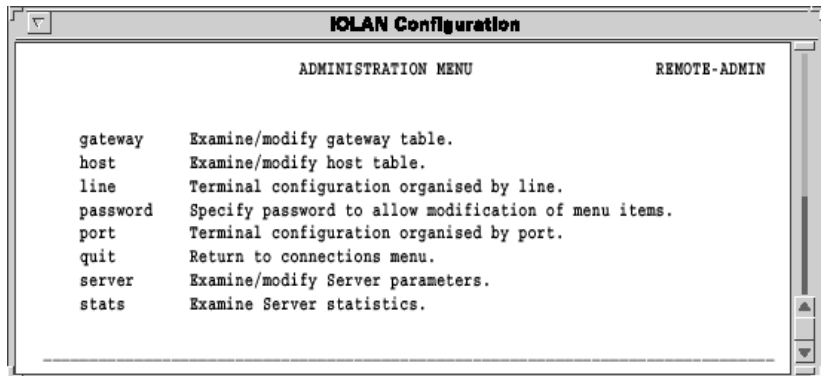

The parameters are as follows:

Option	Description
gateway	Selecting this field allows the user to view the Gateway Menu used for routing.
host	Selecting this field allows the user to view the Host Address Menu used for local naming.
line	Selecting this field takes the user to the Lines pop-up menu used for viewing port configurations.
password	Selecting this field allows the user to enter the administrator's level where changes can be made. Default password is iolan.
port	Selecting this field allows the user to view the Port Setup Menu as previously described. The user is prompted for the port number to be configured.
quit	Selecting this field takes the user back into the Connections Menu.
server	Selecting this field allows the user to view the IOLAN+ Configuration Menu.
stats	Selecting this field allows the user to view the IOLAN+ Statistics screens.

Extra statistics screens

Once the user has entered administration mode the display changes slightly to indicate this.

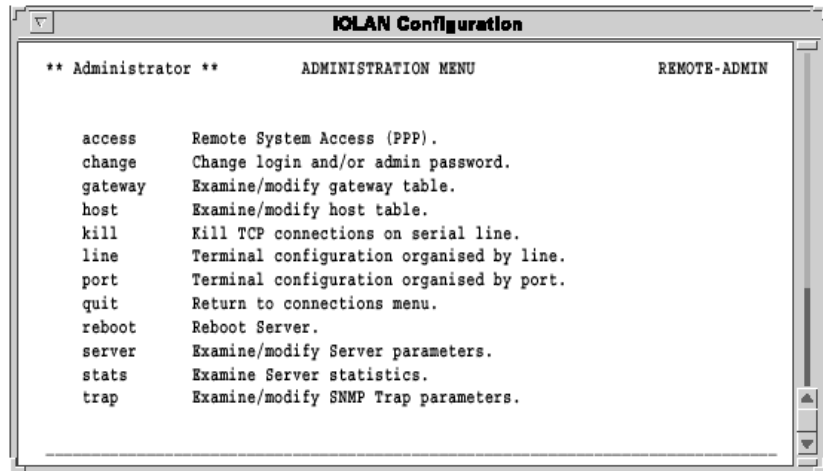

This allows the user access to some extra features as follows:

Option	Description
access	Selecting this option takes the user into the remote access section of IOLAN+ bringing up a menu for designating remote sites, devices and authentication/logging parameters.
change	Selecting this field takes the user into the Password pop-up menu. The user has the option of altering the admin, login or logger passwords.
kill	Selecting this field allows the administrator to reset any serial port. The administrator is prompted to enter the port number and press the Enter key.
reboot	Selecting this field allows the user to reboot IOLAN+.
trap	Selecting this field will take the user into the SNMP trap function menu.

Access menu

The Access section deals with remote access sites, devices and the authentication and logging parameters. The initial pop-up window is as follows:

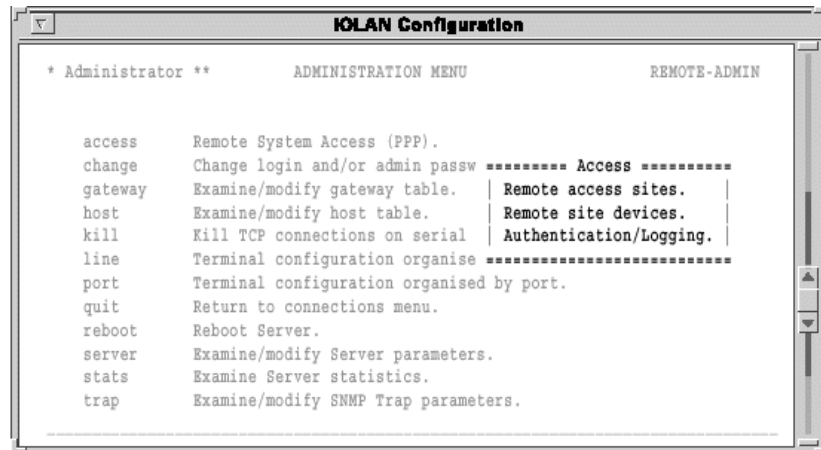

Remote access sites

This first brings up a pop up menu with 16 possible UNUSED ENTRYs. These will represent the available dial-out sites for IOLAN+. Selecting any of these will bring up the following menu:

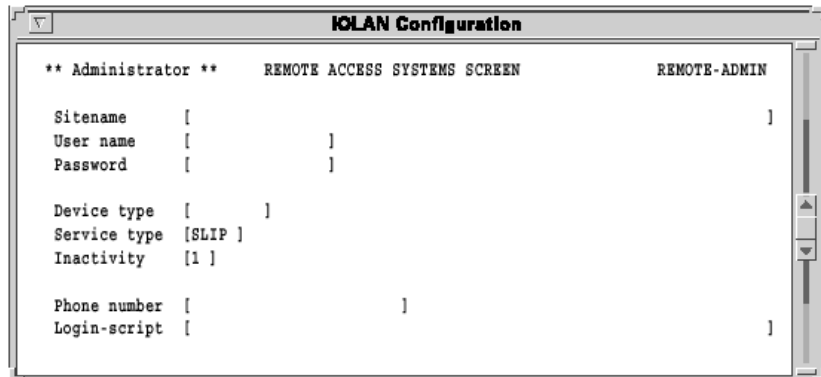

The parameters are as follows:

Parameter	Description
Sitename	This is the IP name or IP address of the remote site IOLAN+ will be calling.
User name	This is the user name required by the remote system for logging in. You may use the \u in your login script in lieu of the full name.
Password	This is the above user name's password as required by the remote system. You may use the \p in your login script in lieu of the full password.
Device type	This is the name of the modem device as defined in the Remote Site Devices screen. You may have several ports setup with the same device type, and the dialer daemon will use the first available. If a device for dialling out is not available, IOLAN+ will return an ICMP 'host unreachable' message (ICMP type 3 code 1).
Service type	This specifies which protocol will be used when the link is established to the remote site. Choices are SLIP, CSLIP or PPP.
Inactivity	This is the period of inactivity on the SLIP/PPP link before the port will drop the call automatically. Setting this field to 0 turns the timeout feature off.

Parameter	Description
Phone number	This is the phone number of the remote system. The '\ ' may be used as a delay. For example, a phone system that requires a 9 followed by a four-second delay before getting an outside line would require an entry like 9\4-2145551234.
Login-script	This is the chat script that will be used to login to the remote system. It takes the form of the usual Send/Expect chat script you may already be familiar with. If no script is defined, this step is skipped (for example, hardwired connections).

Remote site devices

This first brings up a pop-up menu with 16 possible UNUSED ENTRYs each corresponding to a port.

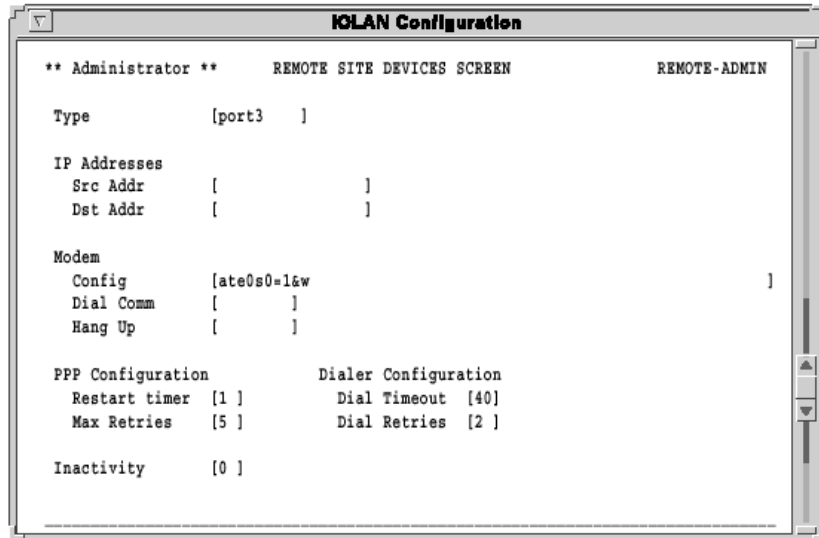

```

IOLAN Configuration
** Administrator **      REMOTE SITE DEVICES SCREEN      REMOTE-ADMIN

Type      [port3  ]

IP Addresses
Src Addr  [          ]
Dst Addr  [          ]

Modem
Config    [ate0s0=1&w          ]
Dial Comm [          ]
Hang Up   [          ]

PPP Configuration      Dialer Configuration
Restart timer [1 ]      Dial Timeout [40]
Max Retries   [5 ]      Dial Retries [2 ]

Inactivity      [0 ]
    
```

The parameters are as follows:

Parameter	Description
Type	This is the name of the modem assigned to a specific port. It is referenced from the Remote Access Systems Screen in the Device type field.
Src Addr	This is the source IP address of the port for remote access/modem configuration. If blank, the IOLAN+ IP address is used.
Dst Addr	This is the destination IP address of the port for remote access/modem configuration. If blank, the remote host must supply the IP address. If filled in, you designate an assigned IP address to loan the remote host. If the secure field on the Port Menu is No, this can be overridden by the incoming host.
Config	This is the modem's setup string. There are a few examples at the end of this document. Note: Leave this field blank for directly connected devices.
Dial Comm	This is the modem's dial command.
Hang Up	This is the modem's hang up command.

Parameter	Description
Restart timer	Amount of time in seconds before IOLAN+ retransmits PPP options.
Max Retries	Number of option retries before dropping the line.
Dial timeout	Number of seconds to wait for the modem to establish link and respond.
Dial retries	Number of times to attempt a connection to the remote site before giving up.
Inactivity	Number of minutes of inactivity before a PPP/ SLIP connection is broken.

Authentication/Logging

This section outlines the authentication and logging parameters of IOLAN+.

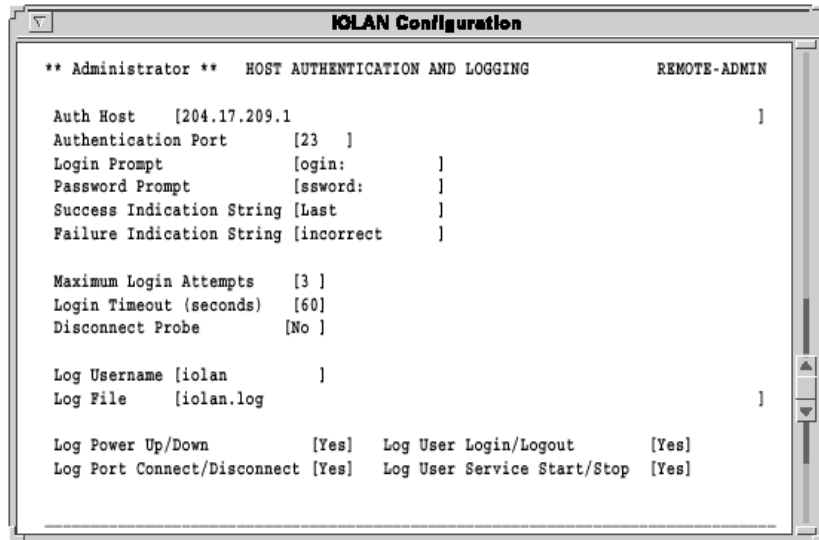

The parameters are as follows:

Parameter	Description
Auth Host	The IP name or address of the authentication host to validate incoming users.
Authentication Port	The TCP port number of the authentication host, usually 23 (telnet) or 513 (Rlogin). A proprietary network number may be chosen to provide a personal user validation scheme. Default is 23 (telnet).
Login Prompt	The user authentication prompt expected from the host by IOLAN+. Default is ogin:
Password Prompt	The password prompt expected from the host by IOLAN+ during the authentication connection. Default is ssword:
Success Indication String	The string returned by the authentication host on successfully logging in. Default is Last
Failure Indication String	The string returned by the authentication host on a failed login attempt. Default is ogin incorrect.

Parameter	Description
Maximum Login Attempts	The maximum number of login attempts a user is allowed before the line is reset. For modem users the control line DTR is toggled, the port is disabled for 3 seconds. Default is 3.
Login Timeout	This time defines the maximum time in seconds for the user to enter authentication information, once login time-out is exceeded the line is reset. Default is 0.
Disconnect Probe	An option to keep the per port authentication connection up during the clients' session. Default is Yes. This allows a user connect time to be measured by a simple 'do nothing' telnet session.
Log Username	The logger's user name for gaining access to the log file on the host. Log File The pathname of the activity log file.
Log Power Up/Down	Logs port connection status to the log file (for example, for Dial-in users). Default is No.
Log User Login/Logout	Logs a message to inform the host when IOLAN+ is powered up and when rebooted from software. This logs an 'I am alive' message every five minutes. Default is No.
Log Port Connect/ Disconnect	Record users logging into authentication host on the log file. Also records failed login attempts. Default is No.
Log User Service Start/ Stop	Logs starts and stops of PPP or SLIP. Default is No.

Change password options

This option allows the administrator to change the admin, login or logger passwords. It is recommended to change the password from the default iolan. The following selections can be called from the Administration Menu, **password** option:

Password option	Description
Admin Password	The user is required to enter the new administrator's password twice.
Login Password	The user is required to enter the IOLAN+ login password twice.
Logger Password	This field allows the user to change the log user password.

Gateway menu

The Gateway Menu allows the IOLAN+ to make use of a gateway (I P router) on the network. This allows flexible internet working.

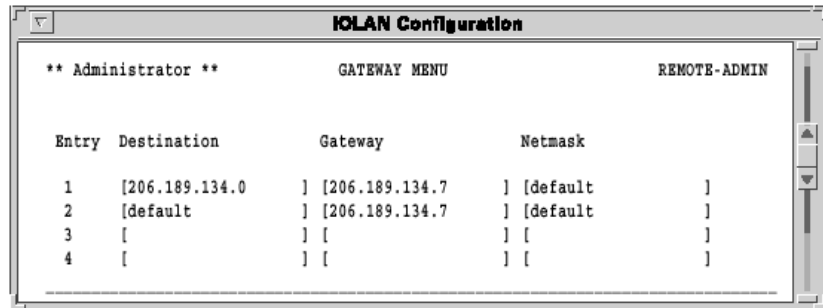

The parameters are as follows:

Parameter	Description
Destination	This field specifies either the destination network or host address.
Gateway	This field defines the gateway (IP router) host address. The gateway host must be attached to the same network as IOLAN+.
Netmask	This field allows the administrator to define a mask that IOLAN+ will use to mask out packets from other networks using the same Ethernet. The valid Netmask fields are: class a Only class a addresses are allowed across the gateway. class b Only class b addresses are allowed across the gateway. class c Only class c addresses are allowed across the gateway.
host	The Destination field is a host IP address and only packets for that host are allowed across the gateway.
default	Any IP address allowed across the gateway
<dot notation value>	Only addresses fitting the numerical mask are allowed across the gateway.

Host Address menu

IOLAN+ uses the information entered on the Host Address Menu to form an internal host table. The user can then use the host name in any of the IOLAN+ functions or menus.

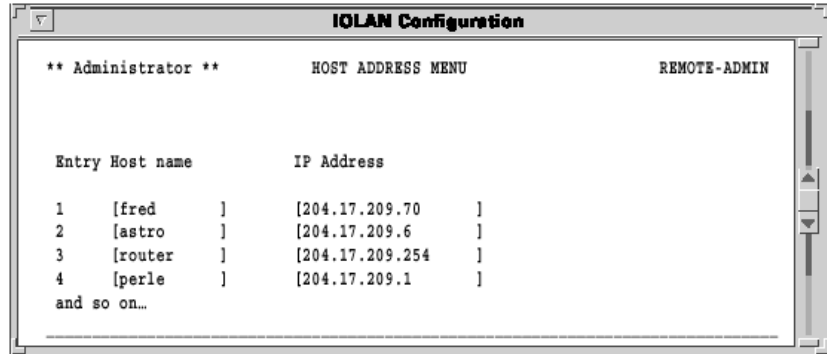

The parameters are as follows:

Parameter	Description
Host name	This field specifies local name you want to give a particular host on the network.
IP Address	This field defines the IP address of the host designated above.

Kill command

The kill command resets the port but keeps the previously defined configuration. This is used when you change certain parameters or for when ports get stuck.

Lines menu

This option allows the administrator to configure all of the parameters for any of the ports. The parameters accessible are exactly the same as those in the Port Setup Menu, but from these menus you can configure a set of parameters for all of the ports. Selecting this option brings up the Lines pop-up menu as shown below.

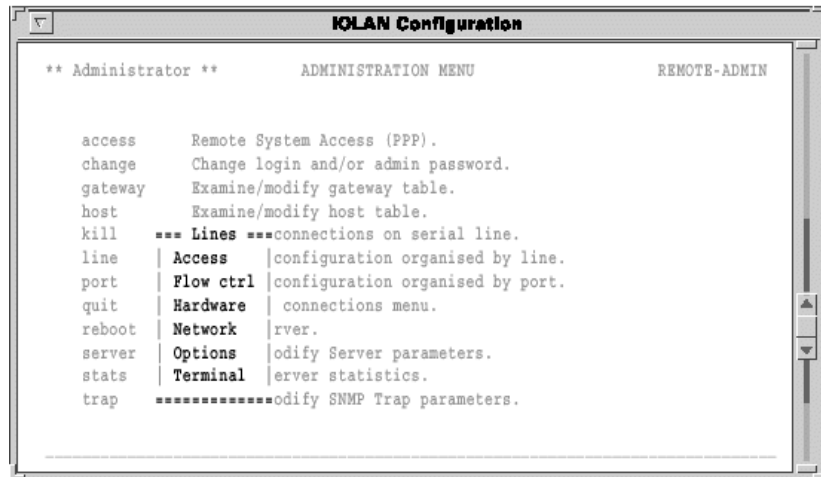

Each of the options displayed in the pop-up menu brings up another menu. These are detailed in the following sections.

Access

The Access section shows and allows changes to the name, access, authentication and mode fields. These fields are described in [Port setup menu](#) on page 130.

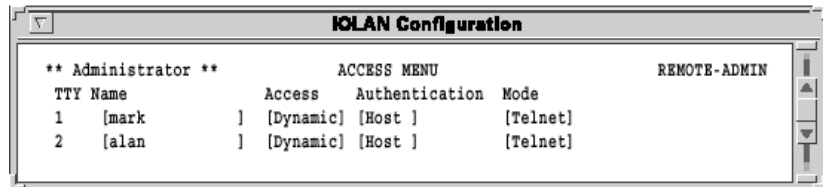

IOLAN Configuration					
** Administrator **		ACCESS MENU			REMOTE-ADMIN
TTY Name	Access	Authentication	Mode		
1 [mark]	[Dynamic]	[Host]	[Telnet]		
2 [alan]	[Dynamic]	[Host]	[Telnet]		

Flow control

The Flow Control section shows and allows changes to the flow control fields as described in [Port setup menu](#) on page 130.

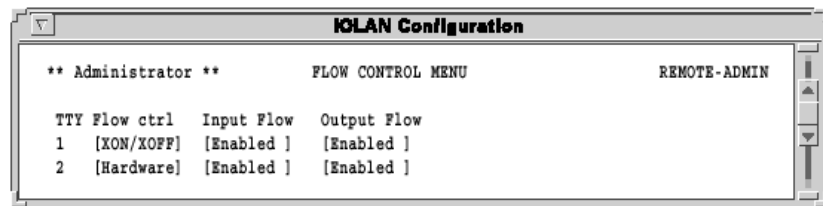

IOLAN Configuration					
** Administrator **		FLOW CONTROL MENU			REMOTE-ADMIN
TTY Flow ctrl	Input Flow	Output Flow			
1 [XON/XOFF]	[Enabled]	[Enabled]			
2 [Hardware]	[Enabled]	[Enabled]			

Hardware

The Hardware section shows and allows changes to the hardware control fields as described in [Port setup menu](#) on page 130.

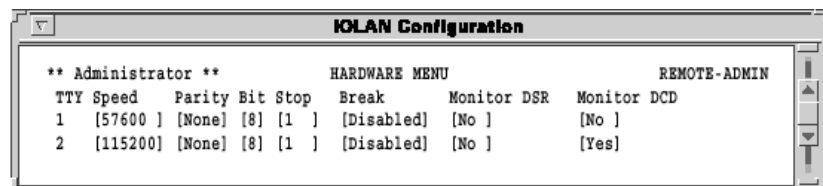

IOLAN Configuration						
** Administrator **		HARDWARE MENU				REMOTE-ADMIN
TTY Speed	Parity	Bit Stop	Break	Monitor DSR	Monitor DCD	
1 [57600]	[None]	[8] [1]	[Disabled]	[No]	[No]	
2 [115200]	[None]	[8] [1]	[Disabled]	[No]	[Yes]	

Network connections

The Network Connections section shows and allows changes to some of the Access fields as described in [Port setup menu](#) on page 130.

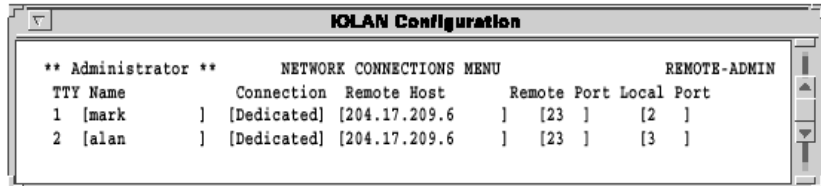

IOLAN Configuration					
** Administrator **					
NETWORK CONNECTIONS MENU					REMOTE-ADMIN
TTY Name	Connection	Remote Host	Remote Port	Local Port	
1 [mark]	[Dedicated]	[204.17.209.6]	[23]	[2]	
2 [alan]	[Dedicated]	[204.17.209.6]	[23]	[3]	

Options

The Options section shows and allows changes to the Options fields as described in [Port setup menu](#) on page 130.

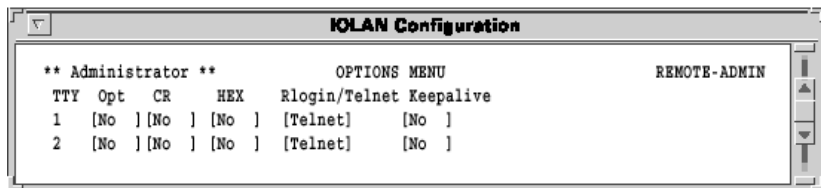

IOLAN Configuration					
** Administrator **					
OPTIONS MENU					REMOTE-ADMIN
TTY	Opt	CR	HEX	Rlogin/Telnet	Keepalive
1	[No]	[No]	[No]	[Telnet]	[No]
2	[No]	[No]	[No]	[Telnet]	[No]

Terminal

The Terminal section shows and allows changes to some of the User fields as described in [Port setup menu](#) on page 130.

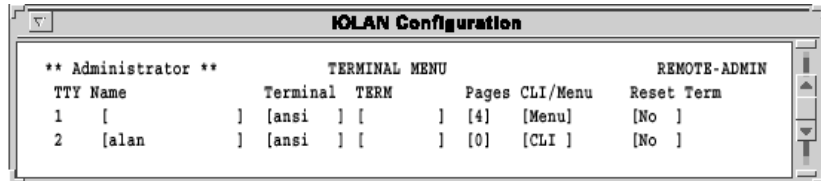

IOLAN Configuration						
** Administrator **		TERMINAL MENU			REMOTE-ADMIN	
TTY Name	Terminal	TERM	Pages	CLI/Menu	Reset	Term
1 []	[ansi]	[[4]	[Menu] [No]
2 [alan]	[ansi]	[[0]	[CLI] [No]

Port menu

This section is covered under [Port setup menu](#) on page 130 of this chapter.

Quit command

This command simply quits out of the password level up to the view-only administration level (the ESC key works as well.)

Reboot command

This option initiates a reboot of the unit and should only be used for changing the IP address or netmask options. It also can be used for troubleshooting. The user will be given a last option to quit before rebooting.

Server configuration menu

This menu allows the user to define all of the main IOLAN+ system parameters.

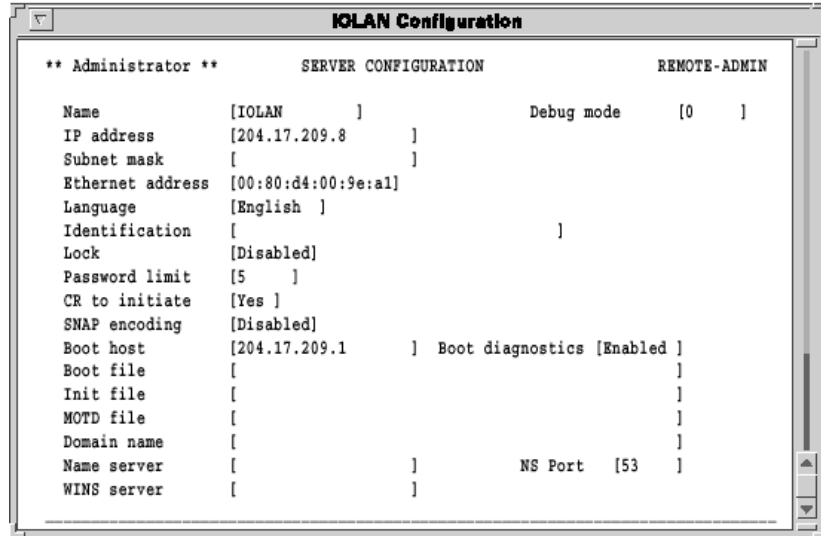

```

IOLAN Configuration
** Administrator **      SERVER CONFIGURATION      REMOTE-ADMIN
Name                    [IOLAN          ]      Debug mode    [0    ]
IP address              [204.17.209.8   ]
Subnet mask             [                ]
Ethernet address       [00:80:d4:00:9e:a1]
Language                [English        ]
Identification         [                ]
Lock                   [Disabled]
Password limit         [5              ]
CR to initiate         [Yes           ]
SNAP encoding          [Disabled]
Boot host              [204.17.209.1   ]      Boot diagnostics [Enabled ]
Boot file              [                ]
Init file              [                ]
MOTD file              [                ]
Domain name           [                ]
Name server            [                ]      NS Port       [53    ]
WINS server            [                ]
    
```

The menu as displayed can be divided into four logical sections: identification fields, general admin, downloading and domain naming.

Identification fields

Field	Description
Name	This field determines the name of IOLAN+ and is displayed in the bottom right hand corner of the menus.
IP address	This field holds the IP address of IOLAN+. If the IP address of IOLAN+ is altered then the unit must be rebooted to permanently save changes.
Subnet mask	This field allows the administrator to define a mask that IOLAN+ uses to mask out packets from other networks using the same ethernet.
Ethernet address	This field defines the globally unique ethernet address of IOLAN+. This address can not be altered and matches the address provided on the physical back of the unit. In the unlikely event of this field being corrupted please contact your supplier.
Ethernet interface	This field defines which Ethernet media will be used. The LAN connectors are autosensing but you can change this to a specific interface.

Field	Description
Language	This field determines the language that IOLAN+m is using such as English, French, German, etc.
Identification	This field allows the administrator to enter an identification string into the unit and is displayed at the bottom of the IOLAN+ menus.
Debug mode	This field is for Technical Support use only.

General administration

Field	Description
Lock	This field determines whether the Lock feature is available to all users. If this field is set to disabled then nobody can use the Lock feature.
Password limit	This field defines the number of attempts a user is allowed to enter the correct password for a port. If the user exceeds this limit IOLAN+ disables the port for 5 minutes. The Administrator can restart the port, bypassing the timeout, by issuing a kill on that port.
CR to initiate	This is the 'carriage return to initiate' field which designates that when terminals are setup for initiated connections, the user must hit Enter to establish a connection. Otherwise, any input will startup the connection (even noise on the cable).
SNAP encoding	This is an alternate Ethernet encoding (SubNet Access Protocol).

Downloading

Field	Description
Boot host	This field should only be filled in if the Administrator wishes to download a new firmware version. It contains the host name or IP address of the host machine that has the IOLAN+ download image on it.
Boot file	This field contains the full path and file name of the IOLAN+ download image (including path name). Boot host required.
Boot diagnostics	This port (if enabled) allows the TFTP download state to be displayed on port 1 and is used for troubleshooting. Boot host required.

Field	Description
Init file	This field contains the file name of the IOLAN+ configuration image. If this field is present, the unit reads its configuration from this file whenever it is rebooted. Boot host required.
MOTD file	This field should be filled in with the pathname of a file on the boot host containing the message of the day text to be displayed on any selected ports. A filename or relative pathname entry assumes the top level directory is /ftpboot. Boot host required.

Domain naming

Field	Description
Domain name	This field should contain the domain name for the name server.
Name server	This field should contain the host name or the IP address of the host machine being used as a Domain Name Server.
WINS server	This defines the Windows ® name server on the network and allows dial-in users full access to the network.
NS Port	This field contains the TCP port number of the Name Server service on the host machine. The default value is 53.

Statistics screens

The statistics screens are used for troubleshooting only. This main screen shows the sub-menus that can be addressed. For more information on the statistics menu, see [Appendix D Troubleshooting](#)).

```

IOLAN Configuration

** Administrator **          SERVER STATISTICS          REMOTE-ADMIN
      === ETHERNET ===
Tx: Pkts:      395  Errors:    0  Collisions:  ===== Statistics =====
   Retries :    0  Resets:    0  Busy:      | ETH/TTY/GATEWAY
Rx: Pkts:      866  Bufs: 170/300  No Bufs:   | IP/ICMP/UDP
   Prot:      101  Miss:    0  Busy:      | TCP
                                           | Users
                                           | Framed Link Status
      === SERIAL LINES ===
Tx: chars:      6,561  psec:    2  Netstat
Rx: chars:      2,752  psec:    1  Gateway
   Malformed:    0  Lost:    0  OverRuns: | Slip
   Buffer failures: 0  Clear counters
                                           | Restore counters
      === ROUTING STATISTICS ===
bad redirects:    0  dynamic:    0  ne | Port Status
unreachable:      0  wild card:    0  | Line Status
                                           | LPD Status
                                           | PPP Status
Uptime:  0 days 00:41:49 hours  Memory free:182768  =====
  
```

Trap function

This is the SNMP trap setup which allows SNMP trap messages to be sent to up to four hosts. Trap messages are sent at system startup and detection of security violations.

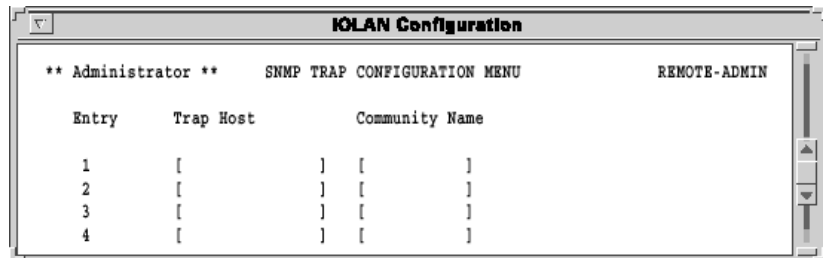

The screenshot shows the 'IOLAN Configuration' window with the 'SNMP TRAP CONFIGURATION MENU' selected. The menu is titled '** Administrator **' and 'REMOTE-ADMIN'. It displays a table with the following structure:

Entry	Trap Host	Community Name
1	[]	[]
2	[]	[]
3	[]	[]
4	[]	[]

Field	Description
Trap Host	This field is the IP address of the trap host.
Community Name	This is the community (password) of trap host.

Appendix A Command Line Interface

You need to read this chapter if you want to...

You need to read this chapter if you want an overview the IOLAN+ command Line Interface.

This appendix describes the IOLAN+ Command Line Interface including information on using the CLI as well as listing the command syntax.

This chapter includes the following sections;

- [Introduction](#) on page **161**
- [Using the CLI](#) on page **162**
- [System administration](#) on page **163**
- [Basic configuration](#) on page **164**
- [Command descriptions](#) on page **165**

Introduction

This chapter outlines the use of the command line interface as opposed to the menu system. The IOLAN+ supports the use of menus for a number of terminal types. It also supports a command line interface (CLI) for use on other terminal types and Telnet/Rlogin sessions.

If possible the menu interface should be used as it is far simpler to use. However, the CLI does offer the same level of functionality.

Using the CLI

The IOLAN+ command line consists of a prompt as shown below.

```
local>
```

The IOLAN+ accepts commands in both lower and upper case, and shortened versions of commands can be used as long as they only have an unambiguous meaning. For example 'tel' could be used in place of 'telnet'.

The IOLAN+ offers an extensive help facility. To enter the help function type,

```
local> help
```

The IOLAN+ responds as follows,

```
Help is available for the following commands:
```

```
CONNECT CLEAR COPY DISCONNECT
EXIT GATEWAY HELP HOST
KILL LOCK LOGOUT RESUME
REBOOT RLOGIN SAVE SET
SHOW SU TELNET TEST
ARP PROV DIAL FACRESET
Topic?
```

The user may now type in any of the indicated topics and press the Enter key. This gives more information on the indicated subject in the form of syntax and synopsis. In some cases, a further choice for more information (stating 'additional help is available for' and another list).

System administration

To gain access to all of the configuration functions of the IOLAN+ a user must log in as the administrator. To do this type:

```
local> su  
Password>
```

The user must enter the administration password. The default password is `iolan` (lower case), but it is suggested that this be changed to prevent unauthorised access. If you are logged in as the administrator then the prompt is as follows:

```
ADMIN:local>
```

Once logged in the administrator can alter the parameters on another port, reboot the IOLAN+ or change any of the system parameters.

Basic configuration

To setup your communications via the command use the following instructions:

1. Enter administrative mode, password level:

```
local> su
Password>
```

2. Enter set server. This will lead you to:

```
ADMIN:local> set server
Type '?' at prompt to see list of valid options;
<Esc> to abort changes.
Name : ronald
Debug mode : 0
IP address : 204.17.209.18
Subnet mask : 255.255.255.0
```

and so on...

3. Enter reboot .

```
ADMIN:local> reboot
```

Command descriptions

There are a large number of commands available for the IOLAN+, these are detailed below:

arp

Syntax: arp [flush]

Description: This command by itself will show the IOLANs arp table (IP address, Ethernet address, flags). In the admin mode, using arp flush will clear all the entries in the arp table. This is used to clear arp entries when you want to change the Ethernet address of a device.

clear

Syntax: clear

Description: This command clears the screen.

connect

Syntax: connect [host] [port]

Description: This makes a telnet or rlogin connection to the indicated host or IP address. If the user omits the host/IP address then the IOLAN+ asks for it as shown below. The command will use telnet or rlogin depending on what is set in the Options section of the Port Menu.

Example:

```
local> connect
Host/IP Address> microart
TCP Port> 23
```

Note

If the user presses the return at the port prompt, the unit defaults to port 23 which is the standard telnet port (or 513, the standard rlogin port). This option is not available when using remote administration or if the port secure mode is WAN.

copy

Syntax: copy <source port> <destination> [destination]...

Description: This command copies one port setup to another allowing easy setup if the ports are the same configuration. Administrative level is required to change. Note that multiple destination ports can be specified separated by spaces.

dial

Syntax: dial

Description: This command shows the status of the dial-out interface and would be used for monitoring dial-out connections.

disconnect

Syntax: disconnect <session-number>

Description: This command allows a user to disconnect (close) one or all of their existing TCP connections.

exit

Syntax: exit

Description: This function causes the user to exit the IOLAN+, closing down any sessions and resetting the port. Some configuration parameters only come into effect after the user has exited and re-entered IOLAN+ (e.g. the name field).

facreset

Syntax: facreset

Description: This function will reset all parameters back to factory defaults. This option requires confirmation.

gateway

Syntax: gateway <[add dest gate net][delete dest]>

Description: This function allows the administrator to alter the gateway routing table. New gateways can be defined by using the add function, and gateways removed using the delete function. When adding, admin level required to change.

help

Syntax: help

Description: This function provides syntax descriptions and partial descriptions of the available commands.

host

Syntax: host <[add name address][delete name]>

Description: This function allows the administrator to add and remove names from the host table. The name can be anything up to 18 characters long, and the address field is the IP address of that host. There can be a maximum of 10 entries in the host table. Admin level required to change.

kill

Syntax: kill <port number>

Description: This function allows the user to reset their own port, or the administrator to kill any other ports. When kill is issued any existing sessions are terminated and the port set back to its starting state. Admin level required.

lock

Syntax: lock

Description: This function allows the user to lock his terminal using a specific password. IOLAN+ prompts the user for a password and a confirmation. This function can not be used unless the Lock enable flag is set (via set port command).

logout

Syntax: logout

Description: This function causes the user to exit IOLAN+. The unit closes down any sessions and resets the port. Same as exit.

prov

Syntax: prov

Description: This function displays the network status of each IP provider and is used for troubleshooting.

reboot

Syntax: reboot

Description: This function reboots the terminal server. Admin level is required.

resume

Syntax: resume <session number>

Description: This allows user to resume an established connection if there are multiple sessions going.

rlogin

Syntax: rlogin [host] [port]

Description: This function allows the user to make an rlogin connection to the specified host machine. If the port number is not specified then it defaults to 513.

save

Syntax: save config

Description: This function allows the user to save the IOLAN+ configuration to a specified host machine and file. The configuration is saved to the specified Boot Host and put into the file name described in the Init File parameter (see [set server](#) on page 170). IOLAN+ uses the TFTP protocol to save and load the file.

Because of a restriction in most TFTP implementations the file must exist before it can be written. Admin level is required.

Example: To create the file under Unix type:

```
touch filename
chmod 666 filename
```

set

Syntax: set <parameter> [value], etc.

Description: The set command allows the administrator to configure any of the IOLAN+ parameters. It also allows the user to alter their own set-ups and change terminal type. Admin level is required on most functions.

set admin

Syntax: set admin

Description: This function allows the user to become the administrator or admin level. The command su can also be used.

set menu

Syntax: set menu

Description: This function sets the user's port into menu mode, assuming that the term type has been set.

set modem

Syntax: set modem

Description: This function transmits a series of modem initialisation commands to the attached modems. A sequence of port numbers from 1 upward can be given or all to indicate all serial ports. The modem commands are taken from the Modem Config field of the Remote site devices menu.

set term

Syntax: set term

Description: This function allows a user to alter their terminal type. If the term field is left blank the IOLAN+ displays a list of all the currently supported terminals (ansi, dumb, vt100, wyse50, wyse60, tvi925, ibm3151, vt320, falco, hp700).

set port

Syntax: set port

Description: This function allows a user to set the parameters for their port, or the administrator to set the parameters for any port. The user will be prompted for each parameter in this section (e.g: speed, parity, etc.).

set port [number]

This allows the administrator to set all of the port parameters for the indicated port. The user will be prompted for each parameter in this section.

set port [number] [access, flow, hardware, options, tcp, user]

This allows the administrator to set all of the port parameters for the indicated port in the indicated section. E.g. set port 1 access would prompt through the access section of the port screen 1. If no number is given, it gives your current port parameters.

set server

This function allows the administrator to alter the IOLAN+ set-up including initial IP address and name.

set slip [IP address]

This function causes the port to go into SLIP mode provided secure is not set to LAN. You can specify an IP address to used by the remote host.

set ppp [IP address]

This function causes the port to go into PPP mode provided secure is not set to LAN. You can specify an IP address to used by the remote host.

set password [admin] or [login]

This function allows you to change the admin or login passwords of the IOLAN+.

Note

The remote access functions of IOLAN+ are not configurable from CLI (for example, the Access section of the Administrative Menu).

show

Syntax: show <parameter>

Description: This function allows the user to see most of the IOLAN+ configuration parameters, but not change them. The set command is used to configure the ports. The show command works with gateway, hosts, netstat, server, sessions, slip, extra, users, version.

show ports

The show ports command requires the port number.

Example: show port 1 would show all the port settings for port 1.

show lines

The show lines command requires which fields you wish to view on all ports (access, flow, hardware, options, tcp, user).

Example: show lines access would show the access settings of the port menu.

show statistics

The show statistics command is used to display any of the IOLAN+ statistics for troubleshooting only (tcp, ip, udp, icmp, tty, eth, gateway).

Example: show statistics tcp would show the TCP parameters screen. You can add a delay option which updates the screen every n seconds such as: show stats tcp 3 (use ESC to quit).

su

Syntax: su

Description: This function allows the user to become the administrator. When this command is entered the IOLAN+ prompts the user for the admin password which is iolan by default (please change for better security).

telnet

Syntax: telnet [host] [port]

Description: This function allows the user to make a telnet connection to the specified host and port number. If the user does not specify the port IOLAN+ defaults to port 23 which is the defined Unix telnet port. If the host name is not defined then the unit prompts the user for the host and port.

test

Syntax: test [port port_number] [count <n none>]

Description: This function causes IOLAN+ to run a simple output test on the port. IOLAN+ outputs a continuous stream of data in a preset pattern.

To stop the test press any key.

Appendix B RS-422 IOLAN+

You need to read this chapter if you want to...

You need to read this appendix if you want information about the RS422 variant of the IOLAN+.

This appendix describes the IOLAN+ RS422 variant.

This chapter includes the following sections;

- [Introduction](#) on page [174](#)
- [Hardware Changes](#) on page [174](#)
- [Software changes](#) on page [176](#)
- [LED Error Codes](#) on page [177](#)
- [Known Limitations](#) on page [177](#).

Introduction

This release note for the IOLAN+ contains important product information which is to be read in conjunction with the rest of this manual.

This Release Note details the functional differences between the standard RS-232 and this RS-422 unit.

Hardware Changes

Connectors and Indicators

The unit has 8 or 16 RS-422 serial ports (8 port version shown:)

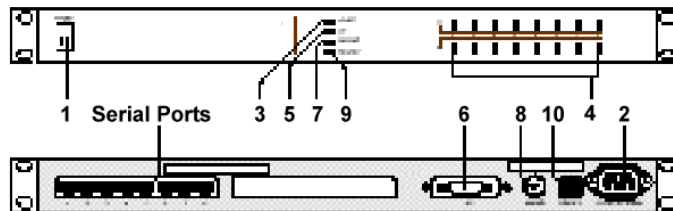

1. Main power switch
2. Power input socket
3. Power indicator
4. Port activity indicators
5. AUI indicator
6. AUI connector
7. 10BASE2 indicator
8. 10BASE2 connector
9. 10BASE-T indicator
10. 10BASE-T connector

RS-422 Serial Port Connections

Pin	Signal	Direction	Description
1	Not used		No connection
2	S/GND		Signal ground
3	RXA -	In	Receive Data A
4	TXA -	Out	Transmit Data A
5	TXB +	Out	Transmit Data B
6	RXB +	In	Receive Data B
7	Not used		No connection
8	S/GND		Signal ground

Functionally, the difference between the RS-232 and the RS-422 versions is the absence of support for hardware flow control lines (RTS and CTS) and modem control lines (DSR and DCD). The performance and support for 115.2k baud are unaffected by the different serial ports.

Software changes

The main differences between the RS-232 and the RS-422 implementation are:

- Input signals (DSR/CTS/DCD) not monitored on RS-422.
- No hardware flow control on RS-422
- User stats screen does not show control signal states on RS-422
- 'Monitor DCD' and 'Monitor DSR' options not available on RS-422.

These features would be selected on Port setup screen.

LED Error Codes

If a hardware fault should occur in the unit then it is possible (if the fault is not too serious) that the LEDs will indicate the type of fault. Below is a description of the codes, should any of these error codes be shown return the unit for repair with a short description of the problem.

LED Legend

AUI	10BASE2	10BASE-T	Fault
LEDs flash on and off together			RAM fault
LED On	LED Off	LED On	I/F fault
LED Off			Serial device UART #1 fault
LED On	LED Off		Serial device UART #2 fault

Please note that when the unit is first switched on (or rebooted) it will flash all three LEDs in sequence (once) very quickly, soon after this all three will remain on for a few seconds.

During normal operation only one of the network LEDs should be lit and the power LED should remain on.

Known Limitations

Under certain situations if you manually kill a port while it is either opening or closing a TCP connection there is a possibility that the unit may crash.

Appendix C 48V DC IOLAN+ Rack

You need to read this chapter if you want to...

You need to read this appendix if you want information on the IOLAN+ Rack for 48V DC supply.

This appendix describes the 48V DC version of IOLAN+ Rack which has been designed specifically to operate on a telecoms compatible 48V DC supply. Please read these instructions carefully before commencing installation.

This chapter includes the following sections;

- [Introduction](#) on page **179**
- [Installing the IOLAN+ Rack 48V DC](#) on page **180**
- [Electrical Safety Guidelines](#) on page **182**
- [Connecting up your IOLAN+ Rack](#) on page **183**
- [Disconnecting your IOLAN+ Rack](#) on page **184**.

Introduction

This version of the IOLAN+ Rack has been designed specifically to operate on a telecoms compatible 48V DC supply. Please read these instructions carefully before commencing installation.

The 48-60VDC supply range marked on the equipment is the nominal voltage associated with the battery circuit of a centralised DC supply system. Higher voltages are only to be associated with "float" voltages for the charging function.

Installing the IOLAN+ Rack 48V DC

Installation

The IOLAN+ Rack 48V DC is designed for professional installation in a restricted access area. The installation should comply with current local or national standards applicable to the territory where the IOLAN+ Rack is installed.

Warning

The IOLAN+ Rack 48V DC shall be installed in a closed rack system with a power distribution unit. A listed branch circuit over-current protective devices rated at 3 amps DC shall be provided either in the power distribution unit or between the power distribution unit and the IOLAN+ Rack.

Electrical Supply Details

The IOLAN+ Rack is supplied with an Input Power cable (802-0061). This should be connected to your 48V DC supply system which should have adequate over-current protection within the closed rack system and comply with current local or national standards applicable to the territory.

Warning

This equipment must be earthed for safety and to ensure ESD protection for correct operation and protection of the internal circuitry.

Connect the input power cable to your over-current protected power distribution unit as follows:

Red Positive

Black Negative

White Ground/earth

Safety Earth

Safety earth point
M3x6 pozi screw

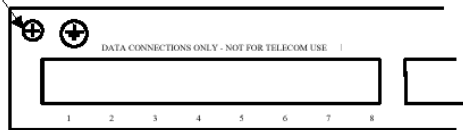

Warning

This apparatus must be earthed.

A safety earth point is provided on the rear on the unit. A suitable earth cable of at least 20awg should be attached using the M3 pozi head screw and shakeproof washer to the safety earth point on the rear of the unit.

Fusing

CAUTION: for continued protection against risk of fire, replace only with same type of and rating of fuse.

The IOLAN+ Rack 48V is fitted with a 1 Amp time delay DC rated fuse (6.3 x 32 mm). In the event of a fuse failure, it must be replaced with an equivalent type.

Recommended fitment is Bussmann MDA1.

Electrical Safety Guidelines

Warning

Electrical current from power, telephone and communications cables may be hazardous. Connect and disconnect cables in the order detailed below when installing, moving or opening the covers of this product or attached devices.

During periods of lightening activity, do not connect or disconnect any cables or perform installation, maintenance or configuration.

Connecting up your IOLAN+ Rack

Making connections to your IOLAN+ Rack should be performed in the following sequence:

1. Switch off the power source.
2. Connect attached devices
3. Connect the supply end of the DC supply cable observing the correct polarity.
4. Connect the supply cable to the IOLAN+ Rack and tighten the securing collar.
5. Switch on the supply.
6. Switch on the IOLAN+ Rack.

Disconnecting your IOLAN+ Rack

1. Switch off the IOLAN+ Rack
2. Switch off the power source.
3. Loosen the securing collar and disconnect the supply cable to the IOLAN+ Rack.
4. Disconnect the supply end of the DC supply cable (if moving the unit).
5. Disconnect attached devices.

Your IOLAN+ Rack is now ready to be moved.

Appendix D Troubleshooting

You need to read this chapter if you want to...

You need to read this appendix if you want to troubleshoot problems with your IOLAN+ product.

This chapter provides information on troubleshooting your IOLAN+. If you require further assistance, please contact technical support. See [Appendix F Contacting Perle](#).

This appendix includes the following sections;

- [Introduction](#) on page [186](#)
- [Terminals/PC Problems](#) on page [187](#)
- [Printer Problems](#) on page [189](#)
- [Modem problems](#) on page [191](#)
- [IOLAN+ Still Does Not Communicate](#) on page [192](#)
- [Resetting Your IOLAN+](#) on page [193](#)
- [Using the IOLAN+ Statistics screens](#) on page [194](#)
- [Using SNMP](#) on page [199](#).
- [Diagnostics](#) on page [200](#)

Introduction

If you encounter problems when installing or using your IOLAN+, try the suggestions given in this chapter. Hopefully, the problems can be solved quickly, otherwise contact your distributor or Perle support. See the following sections for further details:

- [Terminals/PC Problems](#) on page [187](#)
- [Printer Problems](#) on page [189](#)
- [Modem problems](#) on page [191](#)
- [IOLAN+ Still Does Not Communicate](#) on page [192](#)
- [Resetting Your IOLAN+](#) on page [193](#)
- [Using the IOLAN+ Statistics screens](#) on page [194](#)
- [Using SNMP](#) on page [199](#).

Terminals/PC Problems

If your terminal or PC connection is not working properly, symptoms are usually no output at all, 'garbage' on the screen, loss of characters or ports locking. Here is the common solution checklist to these problems:

Problem	Action required
Cable error	Replace the cable with a known good one or test the cable ends. Check the wiring against Appendix C, Cabling Guide. This is the number one problem. It is helpful to have a null modem cable and a RS-232 mini-tester.
Port settings incorrect	Check the set-ups of IOLAN+ and the terminal ensuring that they are the same at both ends. Check parity, bps rate, flow control, data bits and stop bits.
No flow control	Set flow control to be the same at both ends and ensure that the cable installed is capable of supporting it.
Port flow controlled	It is possible that an XOFF character has been received by mistakenly typing or other condition. Power the terminal off and on and type.
Wrong flow control	If the XON and XOFF characters are configurable on the terminal check that they are set to (0x11) and (0x13). If the application you are using is transferring binary data then software flow control cannot be used as some of the binary data may be interpreted as flow control characters.
Faulty terminal	Try a known working terminal on the IOLAN+ port.
Wrong port on terminal	Many terminals have more than one port (i.e. AUX). Check that the cable has been connected to the correct port.
Faulty Server port	Try a known working terminal on the suspect port. If possible, attach a serial line monitor. If the area you are working in is prone to electrical storms, it is possible that a high voltage surge has been induced in the cable and damaged the driver/receiver chips within the IOLAN+.
Cable too long	The RS-232 specification states a maximum length of cable proportional to the bps rate. A good rule of thumb is that a 19200 bps connection should not be used on cable lengths in excess of 15m (50 ft). Also a 9600 bps signal operates reliably up to a distance of approximately 30m (100 ft). Cables of greater lengths may seem to work correctly but the connection will be less reliable.

Problem	Action required
Electrical noise	If your equipment (especially cables) is near any high voltage equipment it may be picking up electrical noise which is corrupting the data signals. Check the stats screen of IOLAN+ (check Line Stats for malformed characters). Ensure all cables are correctly screened and attempt to keep them away from high voltage equipment.
Software application error	If there are problems whenever a certain application is used then the fault may lie with the software. Check the manuals to ensure the application is configured correctly. Note that many fax packages will not work properly with remote ports.

Printer Problems

You can check some of the same problem notes in the terminal section because most are applicable to printers. The main problem is with cabling.

Problem	Action required
Testing the port	<p>If you experience printer problems, it's a good idea to temporarily connect a terminal in place of the printer so you can ensure some of the basic functions are working correctly. Simply telnet into the communications server port:</p> <pre>telnet elroy 10006 (port 6 on IOLAN elroy)</pre> <p>If the Telnet session will not connect, check the network and if you are using any of the RS-232 flow control signals, ensure they are connected correctly. If the telnet session still refuses to operate, re-configure the port for normal terminal operation and trouble-shoot again from this level.</p> <p>Another method is the use the test command from the CLI. This sends a continuous test pattern out to the printer. Example for port 6 (press to halt): local> test port 6 count 0</p> <p>If there is no printout, check the cable or the printer.</p>
Flow control problems	<p>If characters disappear from the printout it may be due to a flow control problem, therefore check that the flow control is set to be the same at both ends of the cable and re-try. Alternatively, the host software may be incorrectly configured. If you are using ioland, set the debug level to a high value so that the log file will contain as much information as possible.</p>
Configuration wrong	<p>The first method to test this is to check the IOLAN+ Statistics - Users Status screen. This screen should show next to the port number, the printer name (if the administrator has added it) and then the diagnostic 'Waiting for incoming connection'. If the diagnostic is something else, such as 'Connections Menu' then the IOLAN+ port is not correctly set up and needs rechecking. Be sure to kill the port after changing its configuration.</p>

Problem	Action required
Spooler problems	<p>Test the printer without relying on your spooler by sending data direct to the port you created and named when you ran the ioland daemon. Do this by typing:</p> <pre>cat data_file > /dev/laser1</pre> <p>If this command returns, then the Unix system believes it has sent the data and there is a good chance it has been printed successfully. This would indicate that your print spooler has not been configured properly.</p>
ioland daemon problems	<p>Check to see if the daemon is running. On Unix this would be:</p> <pre>ps -ef grep ioland</pre> <p>This should show an ioland daemon in the table for each printer. If it isn't listed by this command, invoke it now. If it is not listed, it is probably incorrectly configured. Kill it using the Unix kill command, then run the ioland command again.</p>

Modem problems

Check some of the same problem notes in the terminal section because most are applicable to modems. The main problem here is also cable problems and port setup.

Problem	Action required
Testing the port	The first thing to ascertain is that you can talk to the modem. Check this by telnetting to the port and attempting to obtain a response from the modem. The command sequence is: telnet elroy 10006 (port 6 on IOLAN elroy) If the modem is Hayes compatible, type the AT command and press the return key. The modem should respond with OK if the echo settings are correct at the modem. If you are unable to telnet to the port ensure that the port is set up correctly and has been killed to save the changes in configuration. Pay particular attention to flow control, monitor DSR, monitor DCD, and access field.
Modem problems	Once you have a response from the modem, dial-out to a known site and check that the correct responses are returned. Remember that modems can change their bps rate dynamically having made a connection but the IOLAN+ is unable to do this. Make sure you've configured the AT string in the Remote Site Devices - Modem Configuration field. Then kill the port.

IOLAN+ Still Does Not Communicate

A situation may occur which causes the IOLAN+ to completely not function. Here are possible problems

:

Problem	Action required
Port locked	Try killing the port as it may be locked due to some situation that is no longer obvious. Also, killing the port ensures that any changes in the configuration will be acted upon.
Power cycling	Power cycle the device connected (if this is possible) as it may be that it has locked, or the set-up within the device is in error. Also try power cycling the IOLAN+ itself.
Network errors	Try 'pinging' the IOLAN+ to establish connection.
Network cable problems	Check the network cable again. Does it work on another node correctly. Is the BNC (or AUI) connector fitted correctly?
Configuration problems	Check the IP address again on the Server Menu.
Power problems	Is the green LED power light on? Check the power itself with the plug, wall socket, fuses, etc. Is the green LED power light dim? Call your supplier or Perle support.
Hardware problems	If all three network LEDs are flashing continuously on/off at approx 4Hz. this may point to a memory fail test. Call your supplier or Perle support.

Resetting Your IOLAN+

At times, a support problem may require you to reset or diagnose your IOLAN+. It is best to discuss this matter with your supplier or Perle technical support.

You can perform a factory reset using either of the following methods

Using "facreset" command

1. Power on the unit and type the following from a CLI session:

```
Local> su
```

```
Password> iolan
```

```
ADMIN:Local> facreset
```

```
Do you really want to do this (y/n) [n] ? y
```

```
Performing factory reset ...
```

Using Diagnostic menu reset

1. Connect a serial terminal (configured for 9600,n,8,1) to port 1 of the server.
2. Power on the server and press "<cntrl> B" on the terminal five times in succession while the unit LEDs are flashing (the firmware decompression phase).

The diagnostic menu is now displayed on the terminal.

Note

If you have an older unit with a reset button, to display the Diagnostic Menu proceed as follows;

- a. Press and hold down the reset button.
- b. Power on your IOLAN+ server unit.
The Diagnostic menu now appears.
- c. Release the reset button.

3. Within the diagnostic menu, select the following options:

5. Reset

1. Reset all settings to factory defaults

q. Quit and boot server firmware

After this is done, the unit should start sending BOOTP request packets. This procedure is useful for factory defaulting units which cannot be reached by TCP/IP. This includes reassigning a programmed unit to a network to which the previously assigned IP address does not belong.

Using the IOLAN+ Statistics screens

The IOLAN+ maintains a large number of statistics and these are available on several statistics screens. The various screens and the meanings of the statistics are described in this section. These screens are used along with technical support in troubleshooting. Only the most significant entries will be reviewed in this section.

Initial entry to all IOLAN+ statistics screens is achieved from the ETH/TTY/Routing - Gateway - Statistics screen, which is reached by selecting stats from the Administration Menu (the CLI mode can also be used with the show command).

Once this screen has been displayed the Gateway - Statistics pop-up menu is obtained by pressing the Enter key.

```

IOLAN Configuration
** Administrator **          SERVER STATISTICS          REMOTE-ADMIN
      === ETHERNET ===
Tx: Pkts:      395  Errors:    0  Collisions:  ===== Statistics =====
    Retries :    0  Resets:    0  Busy:      | ETH/TTY/GATEWAY |
Rx: Pkts:      866  Bufs: 170/300  No Bufs:   | IP/ICMP/UDP   |
    Prot:      101  Miss:    0  Busy:      | TCP           |
                                     | Users        |
      === SERIAL LINES ===
Tx: chars:     6,561  psec:    2  Netstat
Rx: chars:     2,752  psec:    1  Gateway
    Malformed:    0  Lost:    0  OverRuns: Slip
    Buffer failures: 0
                                     | Clear counters |
                                     | Restore counters |
                                     | Port Status    |
      === ROUTING STATISTICS ===
bad redirects:    0  dynamic:    0  ne  Line Status
unreachable:     0  wild card:  0  LPD Status
Uptime:  0 days 00:41:49 hours  Memory free:182768  =====
  
```

All of the IOLAN+ statistics screens are now accessible through this Statistics pop-up menu. Pressing in any of the IOLAN+ statistics screens displays the same pop-up menu.

A summary of each is provided and then the most important screens are briefly described:

ETH/TTY/GATEWAY

This is a general overview of Ethernet activity, serial activity and gateway stats. It shows characters passed and uptime.

IP/ICMP/UDP

This is a comprehensive screen of networking protocol stats for IP, ICMP and UDP. You can identify bad IP packets coming in from your network.

TCP

This is a comprehensive screen of TCP protocol stats. You can identify bad TCP packets coming in from your network.

Users

This is a good menu for showing port and control signal status. You can identify status on each ports control signals.

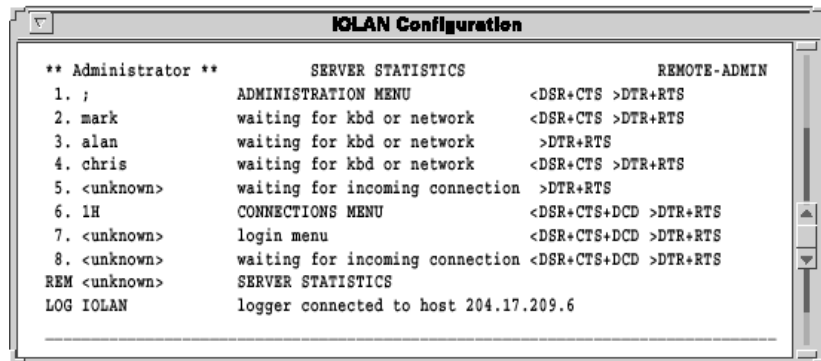

```

IOLAN Configuration
** Administrator **      SERVER STATISTICS      REMOTE-ADMIN
1. ;                    ADMINISTRATION MENU    <DSR+CTS >DTR+RTS
2. mark                waiting for kbd or network <DSR+CTS >DTR+RTS
3. alan                waiting for kbd or network >DTR+RTS
4. chris                waiting for kbd or network <DSR+CTS >DTR+RTS
5. <unknown>           waiting for incoming connection >DTR+RTS
6. 1H                  CONNECTIONS MENU        <DSR+CTS+DCD >DTR+RTS
7. <unknown>           login menu              <DSR+CTS+DCD >DTR+RTS
8. <unknown>           waiting for incoming connection <DSR+CTS+DCD >DTR+RTS
REM <unknown>          SERVER STATISTICS
LOG IOLAN              logger connected to host 204.17.209.6
  
```

Framed Link Status

This is a good menu for Internet Service Providers especially. It shows who is logged on, current port status, which hosts are connected, and how long the port has been in its current state and its idle time.

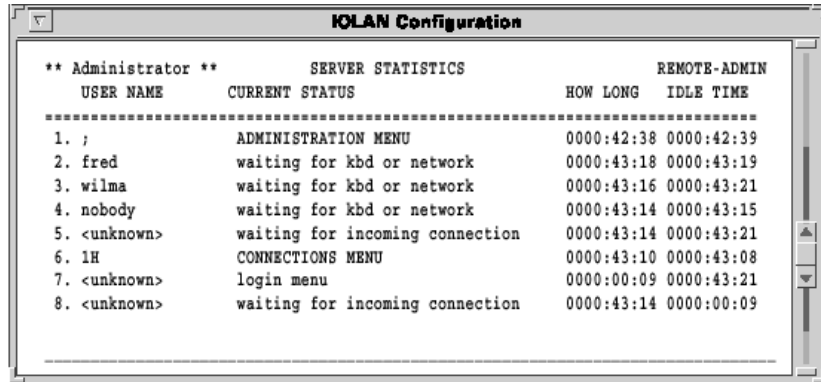

IOLAN Configuration			
** Administrator **			
SERVER STATISTICS		REMOTE-ADMIN	
USER NAME	CURRENT STATUS	HOW LONG	IDLE TIME

1. ;	ADMINISTRATION MENU	0000:42:38	0000:42:39
2. fred	waiting for kbd or network	0000:43:18	0000:43:19
3. wilma	waiting for kbd or network	0000:43:16	0000:43:21
4. nobody	waiting for kbd or network	0000:43:14	0000:43:15
5. <unknown>	waiting for incoming connection	0000:43:14	0000:43:21
6. 1H	CONNECTIONS MENU	0000:43:10	0000:43:08
7. <unknown>	login menu	0000:00:09	0000:43:21
8. <unknown>	waiting for incoming connection	0000:43:14	0000:00:09

Netstat

This is a good menu for determining TCP connection status and the port access status.

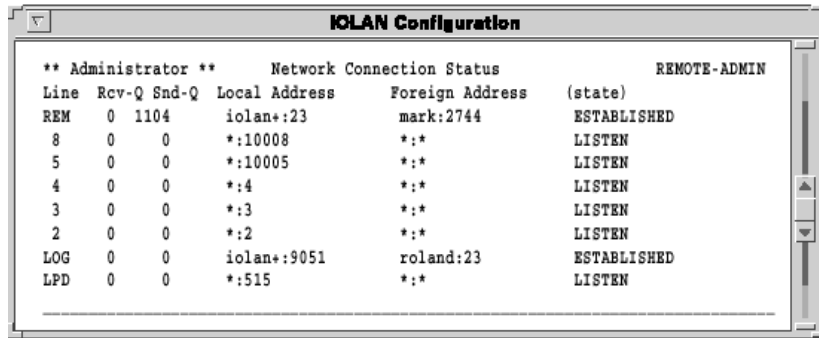

IOLAN Configuration					
** Administrator **					
Network Connection Status					
Line	Rcv-Q	Snd-Q	Local Address	Foreign Address	REMOTE-ADMIN (state)
REM	0	1104	iolan+:23	mark:2744	ESTABLISHED
8	0	0	*:10008	*:*	LISTEN
5	0	0	*:10005	*:*	LISTEN
4	0	0	*:4	*:*	LISTEN
3	0	0	*:3	*:*	LISTEN
2	0	0	*:2	*:*	LISTEN
LOG	0	0	iolan+:9051	roland:23	ESTABLISHED
LPD	0	0	*:515	*:*	LISTEN

Gateway

This is an often used screen for determining routing problems.

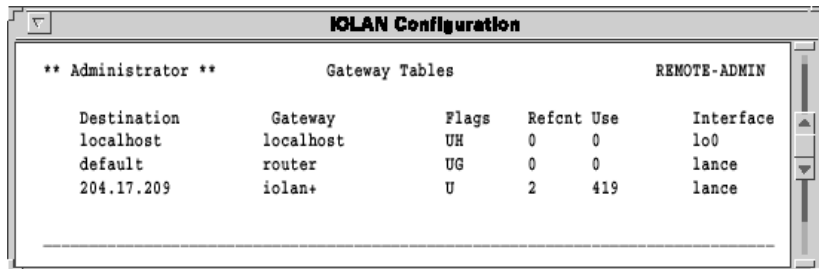

IOLAN Configuration					
** Administrator **					
Gateway Tables					
REMOTE-ADMIN					
Destination	Gateway	Flags	Refcnt	Use	Interface
localhost	localhost	UH	0	0	lo0
default	router	UG	0	0	lance
204.17.209	iolan+	U	2	419	lance

SLIP

This is a comprehensive SLIP stat and streams buffer screen.

Clear counters

This function sets all of the displayed counters to zero.

Restore counters

The counter totals are redisplayed.

Port Status

This is a good screen for viewing individual port activity.

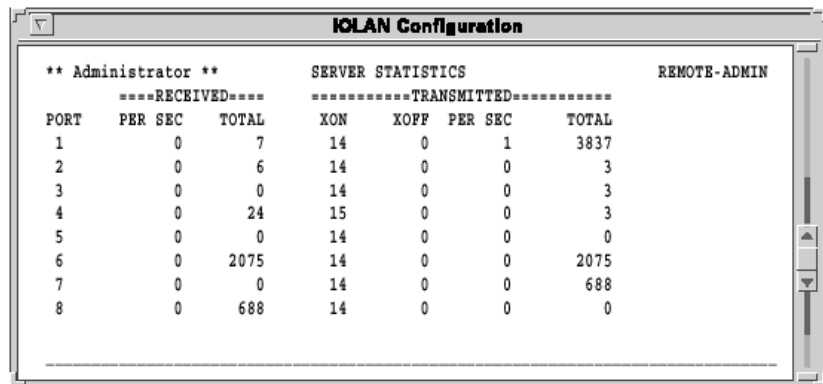

IOLAN Configuration							
** Administrator **			SERVER STATISTICS				REMOTE-ADMIN
===RECEIVED===			=====TRANSMITTED=====				
PORT	PER SEC	TOTAL	XON	XOFF	PER SEC	TOTAL	
1	0	7	14	0	1	3837	
2	0	6	14	0	0	3	
3	0	0	14	0	0	3	
4	0	24	15	0	0	3	
5	0	0	14	0	0	0	
6	0	2075	14	0	0	2075	
7	0	0	14	0	0	688	
8	0	688	14	0	0	0	

Line status

This is a good screen for spotting baud rate and parity errors which if malformed is rapidly incrementing.

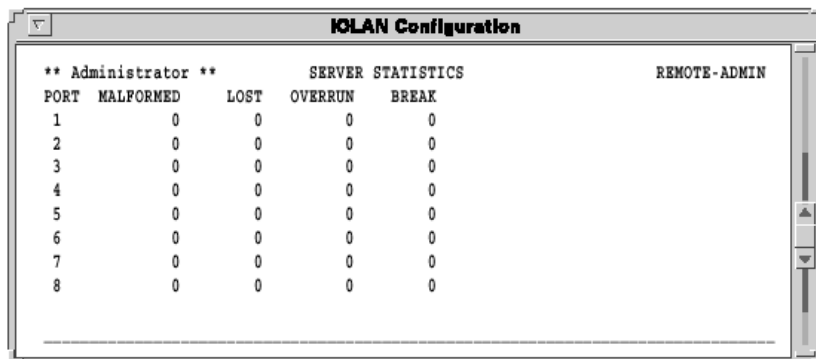

IOLAN Configuration						
** Administrator **			SERVER STATISTICS			REMOTE-ADMIN
PORT	MALFORMED	LOST	OVERRUN	BREAK		
1	0	0	0	0		
2	0	0	0	0		
3	0	0	0	0		
4	0	0	0	0		
5	0	0	0	0		
6	0	0	0	0		
7	0	0	0	0		
8	0	0	0	0		

LPD Status

This screen allows you to check the status of your LPD connections and print queues.

PPP Status

This shows the PPP negotiation progress status and established PPP connections.

Using SNMP

SNMP stands for Simple Network Management Protocol. A full description of SNMP is beyond the scope of this manual. However, if you're familiar with SNMP, you can use this as a troubleshooting tool. As the name suggests SNMP is a protocol designed to allow control of a whole network. The IOLAN+ provides an SNMP agent, this means that it responds to SNMP requests. It does not have the facility to generate SNMP requests to monitor another system.

A host machine running the client SNMP package can request any of the defined variables. It can also set a limited number of the communications server variables thus allowing configuration of the unit to be done remotely. The list of supported variables from MIBI & MIBII can be found on the Perle web site. The SNMP trap function is set up using the Trap function screen. This is accessed from the Administration Menu.

Diagnostics

Entering the Diagnostic Menu

1. Connect a serial terminal (configured for 9600,n,8,1) to port 1 of the server.
2. Power on the server and press "<cntrl> B" on the terminal five times in succession while the unit LEDs are flashing (the firmware decompression phase).

Note

If you have an older unit with a reset button, to display the Diagnostic Menu proceed as follows;

- a. Press and hold down the reset button.
- b. Power on your IOLAN+ server unit.
The Diagnostic menu now appears.
- c. Release the reset button.

This causes the following menu to be displayed on the terminal:

1. Self-test.
2. Diagnostics.
3. Monitor.
4. Download.
5. Reset.
- q Quit and boot server firmware.

Self-test

This is an option intended for use at the factory and by repair centres, all of the functionality provided by this test is available by selecting the Diagnostics option. It is recommended that you do not select the Self-test option.

Monitor

This option allows a number of settings to be made and allows read and write operations directly into specified memory locations. Again it is not intended for use outside of the factory or repair centres.

Download

It is possible that when trying to download a new version of firmware over the network that when the FLASH is being programmed it can become corrupt. In the unlikely event of FLASH corruption it is possible to download new firmware via the FLASH bootstrap code.

Ethernet Interface

You will be prompted to accept or change the following parameters:

Server Ethernet address.

Server IP address.

Host IP address (from which the download file will come).

Full path and file name of the down-loadable firmware file.

When the settings have been correctly entered the type of Ethernet interface required can be set, this needs to be selected manually and will not be configured automatically.

Also note that this feature is a backup and normally firmware should be downloaded using the options included in the firmware itself, allowing updates etc. to be downloaded from anywhere on the network.

Ensure the server and host are on the same physical network. The bootstrap code does not support routing.

Reset

This allows the user to reset a number or all of the settings stored in FLASH which constitute the server's configuration.

The following settings may be reset:

1. Reset all settings to factory defaults.
 2. Reset password.
 3. Reset IP address.
 4. Reset product name.
 5. Reset Ethernet address.
- q Quit.

Reset all settings

This clears the entire permanent database in FLASH. When the server runs the firmware it will report a permanent database error and set all of the configurations to their default settings.

Reset password

This is useful if the password is lost or forgotten, it will set the password back to iolan.

Reset IP address

This will reset the IP address of the communications server.

Reset product name

This option changes the name displayed in the bottom left corner of the menu screen, it is not intended for use outside the factory.

Reset Ethernet address

Do not attempt to enter the Ethernet address unless the unit's configuration has become completely corrupt. The Ethernet address is recorded on the base of the unit and should never be changed.

Quit

This will exit the bootstrap menu and cause the firmware stored in FLASH to be booted.

Appendix E Cabling

You need to read this chapter if you want to...

You need to read this appendix if you want cabling information for your IOLAN+ product.

This appendix provides cabling and connector information about the Perle IOLAN+ including serial ports and cables for various applications.

This chapter includes the following sections;

- [Introduction](#) on page [205](#)
- [Serial port connectors on the IOLAN+ unit](#) on page [206](#)
- [Standard modem cables](#) on page [209](#)
- [Standard Terminal/PC cables](#) on page [211](#)
- [Printer cables with hardware flow control](#) on page [215](#)

Introduction

The following guide describes pinouts and cables for the IOLAN+ (DB25), IOLAN+ Rack(RJ45) and IOLAN+ 102/104 (RJ45) units. Both versions equipped with RJ45 connectors are also available as RS-422 units.

Any cable you use should be shielded to comply with FCC requirements. Be careful not to run data cables near fluorescent lights, electric motors or other sources of electrical noise. Maximum cable lengths for RS-232 are specified at 60m (200 feet) but are proportional to baud rates - the higher the baud, the smaller the cable should be. A good rule of thumb is that a 19200 bps connection should not be used on cable lengths in excess of 15m (50 feet). Also, a 9600 bps signal operates reliably up to a distance of approximately 30m (100 feet). Cables of greater lengths may seem to work correctly but the connection will be less reliable. For reliable RS-422 operation, signal ground must be connected at both ends of the cable. Maximum cable length is 1.2 km but at 115.2 kbs it is reduced to 1 km.

Serial port connectors on the IOLAN+ unit

Serial port connector guide

Product	Serial port connector type	For details see...
IOLAN+	DB25 female	RS232 DB25 female DTE on page 206.
IOLAN+ Rack RS232	RJ45 female	RS232 RJ45 DTE socket on page 207.
IOLAN+ Rack RS422	RJ45 female	RS422 RJ45 DTE socket on page 208.
IOLAN+ 102/104 RS232	RJ45 female	RS232 RJ45 DTE socket on page 207.
IOLAN+ 102/104 RS422	RJ45 female	RS422 RJ45 DTE socket on page 208.

RS232 DB25 female DTE

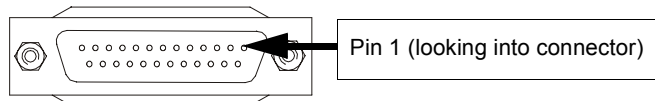

Pin	Signal	Direction	Description
1	GND		Protective ground
2	TXD	Out	Transmit Data
3	RXD	In	Receive Data
4	RTS	Out	Request To Send
5	CTS	In	Clear To Send
6	DSR	In	Data Set Ready
7	S/GND		Signal ground
8	DCD	In	Data Carrier Detect
20	DTR	Out	Data Terminal Ready

RS232 RJ45 DTE socket

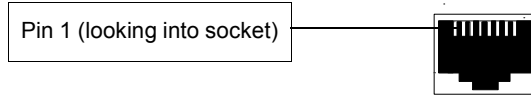

Pin	Signal	Direction	Description
1	DCD	In	Data Carrier Detect
2	RTS	Out	Request To Send
3	DSR	In	Data Set Ready
4	TXD	Out	Transmit Data
5	RXD	In	Receive Data
6	S/GND		Signal ground
7	CTS	In	Clear To Send
8	DTR	Out	Data Terminal Ready

RS422 RJ45 DTE socket

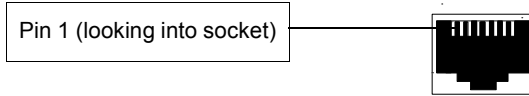

Pin	Signal	Direction	Description
1	Not used		No connection
2	S/GND		Signal ground
3	RXA -	In	Receive Data A
4	TXA -	Out	Transmit Data A
5	TXB +	Out	Transmit Data B
6	RXB +	In	Receive Data B
7	Not used		No connection
8	S/GND		Signal ground

Standard modem cables

IOLAN+ DB25 DTE to Modem DB25 DCE

Typical uses This type of cable is used to connect to DCE devices such as Modems.

Cable diagram

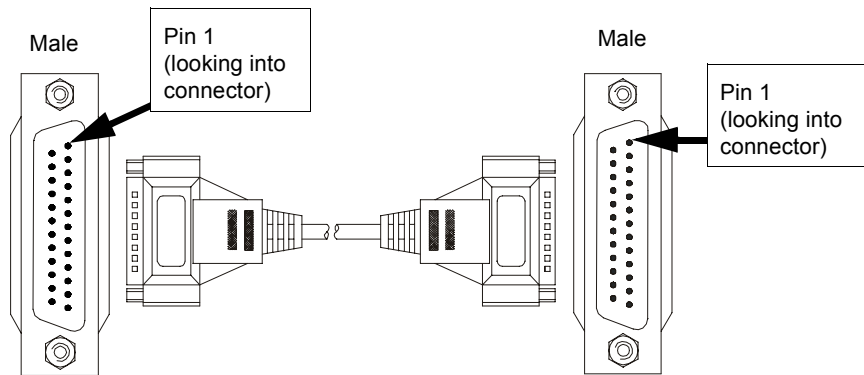

Connector pinout table

DB25 (IOLAN+)				DB25 (MODEM)		
Pin	Signal	Direction	Description	Pin	Signal	Description
1	Chassis		Chassis ground	1	Chassis	Chassis ground
2	TXD	Out	Transmit Data	2	TXD	Transmit Data
3	RXD	In	Receive Data	3	RXD	Receive Data
4	RTS	Out	Request To Send	4	RTS	Request To Send
5	CTS	In	Clear To Send	5	CTS	Clear To Send
6	DSR	In	Data Set Ready	6	DSR	Data Set Ready
7	GND		Ground	7	GND	Ground
8	DCD	In	Data Carrier Detect	8	DCD	Data Carrier Detect
20	DTR	Out	Data Terminal Ready	20	DTR	Data Terminal Ready

IOLAN+ Rack and IOLAN+ 102/104 RS232 RJ45 DTE to Modem DB25 DCE

Typical uses This type of cable is used to connect to DCE devices such as Modems.

Cable diagram

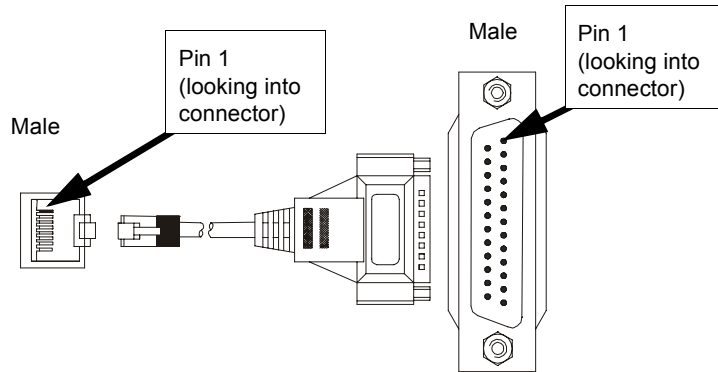

Connector pinout table

RJ45 (IOLAN+)				DB25(MODEM)		
Pin	Signal	Direction	Description	Pin	Signal	Description
1	DCD	In	Data Carrier Detect	8	DCD	Data Carrier Detect
2	RTS	Out	Request To Send	4	RTS	Request To Send
3	DSR	In	Data Set Ready	6	DSR	Data Set Ready
4	TXD	Out	Transmit Data	2	TXD	Transmit Data
5	RXD	In	Receive Data	3	RXD	Receive Data
6	S/GND		Signal ground	7	S/GND	Signal ground
7	CTS	In	Clear To Send	5	CTS	Clear To Send
8	DTR	Out	Data Terminal Ready	20	DTR	Data Terminal Ready

Standard Terminal/PC cables

IOLAN+ DB25 DTE to Terminal DB25 DTE

Typical uses This type of cable is used to connect to DTE devices such as Terminals/PCs.

Cable diagram

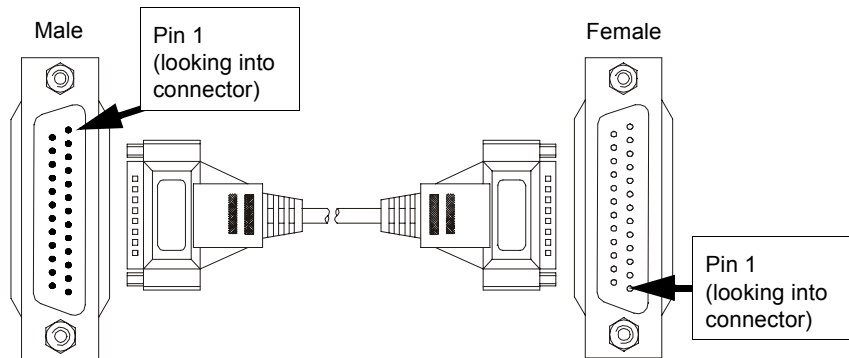

Connector pinout table

DB25 (IOLAN+)				DB25 (Terminal)		
Pin	Signal	Direction	Description	Pin	Signal	Description
2	TXD	Out	Transmit Data	3	RXD	Receive Data
3	RXD	In	Receive Data	2	TXD	Transmit Data
7	GND		Ground	7	GND	Ground

IOLAN+ DB25 DTE to PC DB9 DTE

Typical uses This type of cable is used to connect to DTE devices such as Terminals/PCs.

Cable diagram

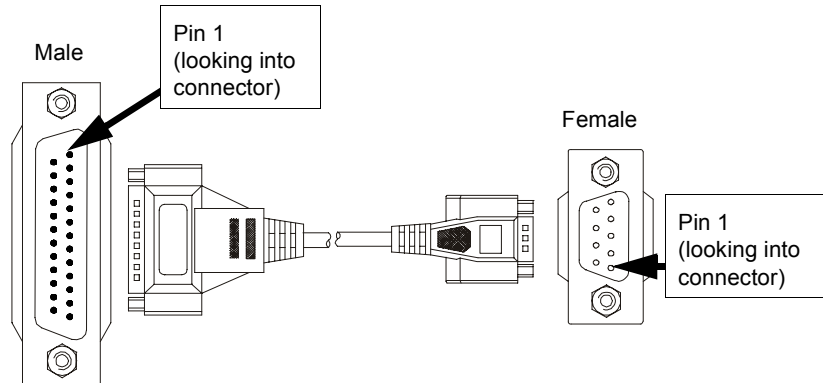

Connector pinout table

DB25 (IOLAN+)				DB9 (Terminal)		
Pin	Signal	Direction	Description	Pin	Signal	Description
2	TXD	Out	Transmit Data	2	RXD	Receive Data
3	RXD	In	Receive Data	3	TXD	Transmit Data
7	GND		Ground	5	GND	Ground

IOLAN+ Rack and IOLAN+ 102/104 RJ45 DTE to Terminal DB25 DTE

Typical uses This type of cable is used to connect to DTE devices such as Terminals/PCs.

Cable diagram

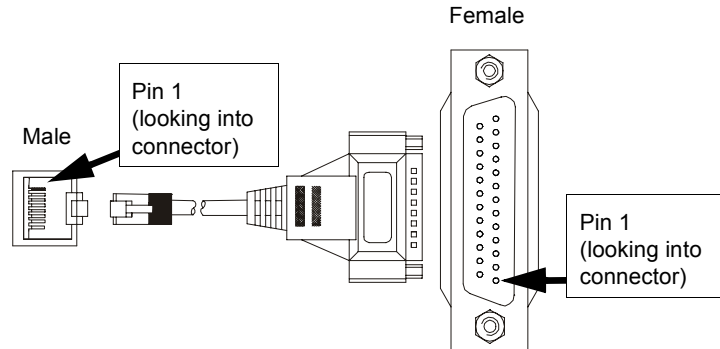

Connector pinout table

RJ45 (IOLAN+)				DB25 (Terminal)		
Pin	Signal	Direction	Description	Pin	Signal	Description
4	TXD	Out	Transmit Data	2	RXD	Receive Data
5	RXD	In	Receive Data	3	TXD	Transmit Data
6	GND		Ground	7	GND	Ground

IOLAN+ Rack and IOLAN+ 102/104 RJ45 DTE to PC DB9 DTE

Typical uses This type of cable is used to connect to DTE devices such as PCs.

Cable diagram

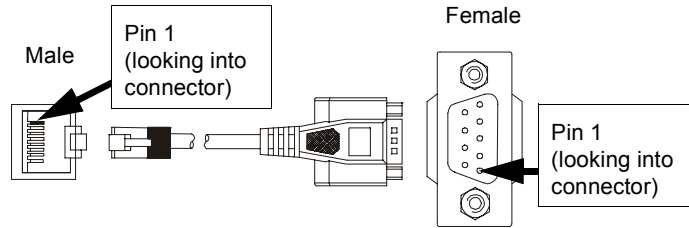

Connector pinout table

RJ45 (IOLAN+)				DB9 (PC)		
Pin	Signal	Direction	Description	Pin	Signal	Description
4	TXD	Out	Transmit Data	2	RXD	Receive Data
5	RXD	In	Receive Data	3	TXD	Transmit Data
6	GND		Ground	5	GND	Ground

Printer cables with hardware flow control

IOLAN+ DB25 DTE to Printer DB25 DTE

Typical uses This type of cable is used to connect to DTE devices such as PCs.

Cable diagram

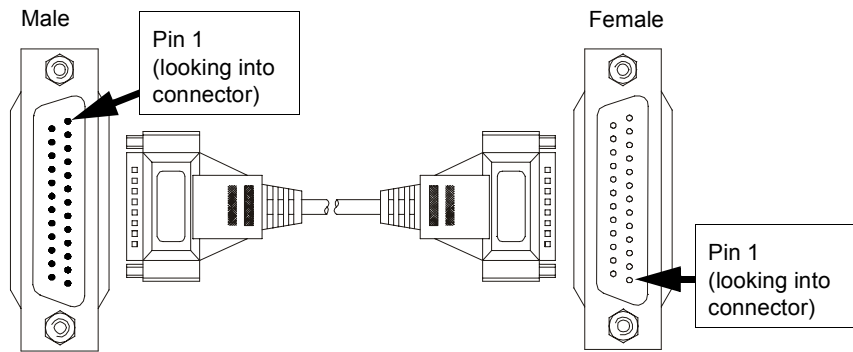

Connector pinout table

DB25 (IOLAN+)				DB25 (Printer)		
Pin	Signal	Direction	Description	Pin	Signal	Description
2	TXD	Out	Transmit Data	3	RXD	Receive Data
3	RXD	In	Receive Data	2	TXD	Transmit Data
5	CTS	In	Clear To Send	20	DTR	Data Terminal Ready
7	GND		Ground	7	GND	Ground

IOLAN+ Rack and IOLAN+ 102/104 RJ45 male to printer DB25 DTE

Typical uses This type of cable is used to connect to DTE devices such as PCs.

Cable diagram

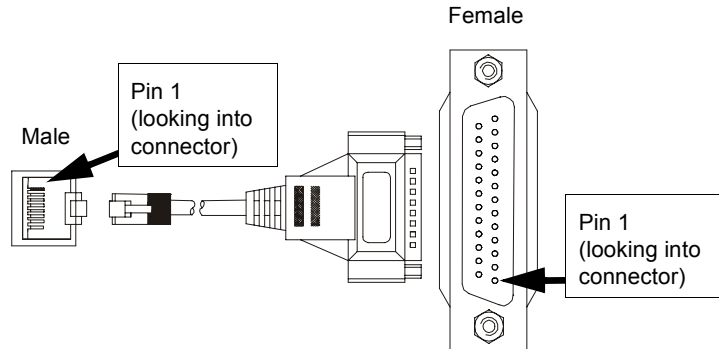

Connector pinout table

RJ45 (IOLAN+)				DB25 (Printer)		
Pin	Signal	Direction	Description	Pin	Signal	Description
4	TXD	Out	Transmit Data	2	RXD	Receive Data
5	RXD	In	Receive Data	3	TXD	Transmit Data
6	GND		Ground	7	GND	Ground
7	CTS	In	Clear To Send	20	DTR	Data Terminal Ready

Appendix F Contacting Perle

You need to read this appendix if you want to... You need to read this appendix if you want to contact Perle for technical support or any other queries about this product.

This appendix includes the following sections;

- [Making a technical support query](#) on page **218**
- [Repair procedure](#) on page **221**
- [Feedback about this manual](#) on page **222**
- [Contacting Perle technical support](#) on page **223**

Internet access

[Click here to access the our website at the following URL:](#)
<http://www.perle.com>

Email

[Click here to email](#) Perle at the following address;
Email: ptac@perle.com

Making a technical support query

This section contains the following information about making a query;

- [Who to contact](#) on page [218](#)
- [Information needed when making a query](#) on page [219](#)
- [Making a support query via the Perle web page](#) on page [220](#)

Who to contact

If you bought your product from a registered Perle supplier, you must contact their Technical Support department; they are qualified to deal with your problem.

If you are a registered Perle supplier, and bought your product from Perle, contact Perle Technical Support using the details given in [Contacting Perle technical support](#) on page [223](#).

Information needed when making a query

When you make a technical support enquiry please have the following information ready;

Hint

Print out this page and fill in the table provided with the basic information you need.

Item	Write details here
Product name and version	
Problem description	
Operating system version	
Driver version	
Details of any other cards installed in your system	
Your name	
Company Name	
Country	
Phone number	
Fax number	
Email address (if available)	

Making a support query via the Perle web page

If you have an internet connection, please send details of your problem to Technical Support using the email links provided on the Perle web site in the 'Support' area.

See also [Contacting Perle technical support](#) on page 223 for email links and other contact details for the Perle technical support centres.

[Click here to access our website at the following URL:
http://www.perle.com](http://www.perle.com)

Repair procedure

Before sending a unit for repair, you must contact your Perle supplier. If, however, you bought your product directly from Perle you can contact directly. See [Contacting Perle technical support](#) on page 223 for contact information.

Customers who are in Europe, Africa or Middle East can submit repair details via a website form shown in the next picture. This form is on the Perle website, www.perle.com, in the **Support** area.

Click here to access our web site at the following URL:
http://www.perle.com/support/rma_form.html

In the USA and Asia contact the office shown in the Technical Support section.

Website RMA (Return Material Authorisation) Form

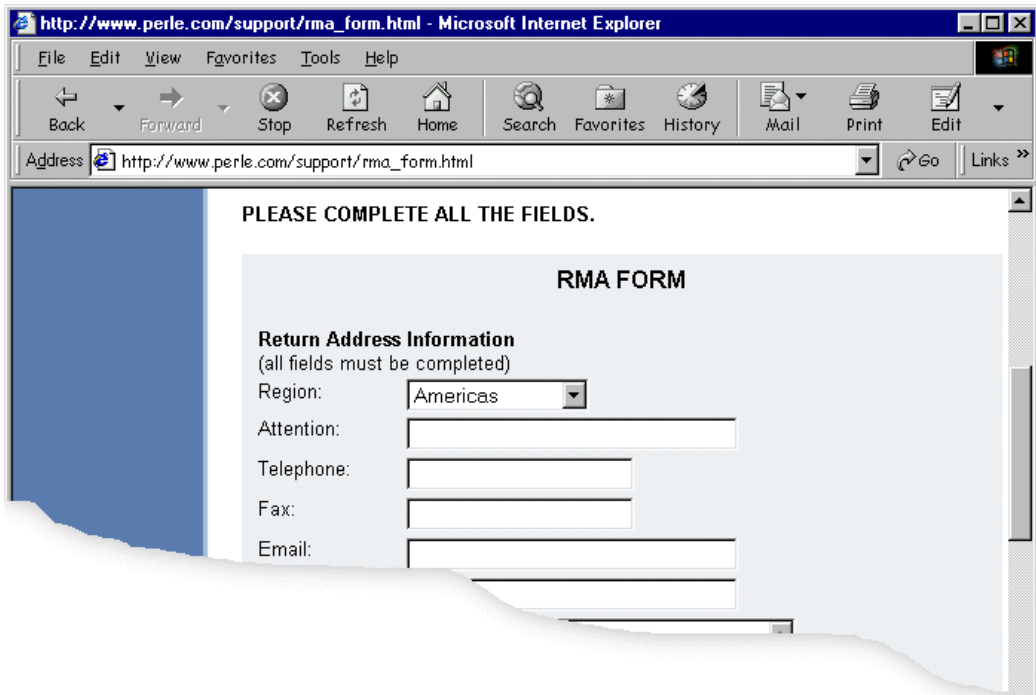

The screenshot shows a Microsoft Internet Explorer browser window displaying the RMA Form at http://www.perle.com/support/rma_form.html. The browser's address bar shows the URL. The page content includes a blue sidebar on the left and a main content area with the following text:

PLEASE COMPLETE ALL THE FIELDS.

RMA FORM

Return Address Information
(all fields must be completed)

Region:

Attention:

Telephone:

Fax:

Email:

Feedback about this manual

If you have any comments or suggestions for improving this manual please email Perle using the following address;

Email: ptac@perle.com

Please include the **title**, **part number** and **date** of the manual (you can find these on the title page at the front of this manual).

Contacting Perle technical support

Note

Perle offers free technical support to Perle Authorised Distributors and Registered Perle Resellers.

To access technical support please visit the Perle website at www.perle.com/support.

If you are unable to find the information you require, please feel free to contact our technical support teams by email using the addresses shown in the next table.

Region	Address	Email
North America	Perle Systems Ltd. 60 Renfrew Drive Markham Ontario Canada L3R OE1	Email: ptac@perle.com
Europe	Perle Systems Europe Ltd. 3 Wintersells Road Byfleet Surrey KT14 7LF UK	Email: ptac@perle.com
Asia	Perle Asia Pacific (Pte) Ltd. 190 Middle Road #19-05 Fortune Centre Singapore 188979	Email: ptac@perle.com
Worldwide	Perle Systems Ltd. 60 Renfrew Drive Markham Ontario Canada L3R OE1	Email: ptac@perle.com

Index

Numerics

48V DC, IOLAN+ variant [178](#)

A

about this manual [4](#)
access menu [141](#)
Address Resolution Protocol [39](#)
administration menu [139](#)
ARP
 communicating with [39](#)
arp [165](#)
 command [165](#)
authentication
 of host [75](#)
 of logging [77](#)

C

cables [204](#)
 modems [209](#)
 pc [211](#)
 printer [215](#)
 terminal [211](#)
cabling [204](#)
clear command [165](#)
CLI [160](#)
 using [162](#)
client login [68](#)
command line interface [160](#)
 using [162](#)
commands [160](#)
 arp [165](#)
 clear [165](#)
 connect [165](#)
 copy [166](#)
 descriptions of [165](#)
 dial [166](#)

disconnect [166](#)
exit [166](#)
facreset [166](#)
gateway [166](#)
help [167](#)
host [167](#)
kill [167](#)
lock [167](#)
logout [167](#)
prov [167](#)
reboot [168](#)
resume [168](#)
rlogin [168](#)
save [168](#)
set [169](#)
show [171](#)
su [171](#)
telnet [171](#)
test [172](#)

communicating
 via pc [40](#)
 via terminal [40](#)
connect command [165](#)
connections
 making on multi-user systems [59](#)
connections menu [128](#)
connector pinouts [204](#)
contacting Perle Systems [217](#)
 email [217](#)
 for technical support [218](#)
 internet [217](#)
copy [166](#)
copy command [166](#)

D

dial command [166](#)
dial-in modem ports, setting up [62](#)
dial-in port [64](#)

A B C D E F G H I J K L M N O P Q R S T U V W X Y Z

dialout modem ports
configuration [81](#)
host [82](#)
remote access systems [84](#)
remote site devices [87](#)
routing [83](#)
setup [79](#)
disconnect [166](#)
disconnect command [166](#)

E

email [217](#)
exit command [166](#)

F

facreset [166](#)
facreset command [166](#)
factory defaults
restoring [166](#)

G

gateway
command [166](#)
menu [149](#)

H

help command [167](#)
host [66](#)
address menu [150](#)
authentication [75](#)
command [167](#)
table
setting up [58](#)

I

installation [36](#)
installing
IOLAN+ [36](#)
IOLAN+
48V DC variant [178](#)
connecting to network [37](#)
installing [36](#)

introduction to [26](#)
menu system [41](#)
menus [125](#)
RS422 variant [173](#)
switching on [38](#)

ioland [118](#)
printing with [100](#)

K

kill command [167](#)

L

lines menu [151](#)
lock commands [167](#)
logging
authentication [77](#)
logout command [167](#)
LPD printing [103](#)

M

menus [41](#), [125](#)
access [141](#)
administration [139](#)
connections [128](#)
gateway [149](#)
host address [150](#)
introduction to [126](#)
lines [151](#)
password options [148](#)
port [154](#)
port setup [130](#)
quit command [154](#)
reboot command [154](#)
server configuration [155](#)
statistics screens [158](#)
trap function [159](#)

modem [67](#)
authentication and logging
host [75](#)
logging [77](#)
user authentication [72](#)
cables [209](#)
dialout ports

A B C D E F G H I J K L M N O P Q R S T U V W X Y Z

- configuration of [81](#)
- host [82](#)
- remote access systems [84](#)
- remote site devices [87](#)
- routing [83](#)
- setup [79](#)
- virtual [89](#), [91](#), [97](#)
- modem, authentication and logging [70](#)
- multi-user systems
 - connecting [59](#)
 - connecting to [55](#)
 - host table [58](#)
 - setting up [54](#)

N

- network, connecting to [37](#)

O

- on-line manual
 - guide to using [5](#)
 - hypertext jumps [5](#)
 - navigation [5](#)

P

- password options, changing [148](#)
- pc
 - cables [211](#)
 - communicating with [40](#)
- port configuration
 - for terminals [56](#)
- port menu [154](#)
- port setup menu [130](#)
- printer cables [215](#)
- printing [98](#)
 - using iolant [100](#)
 - using LPD [103](#)
 - using RCP [109](#)
- product repair form [221](#)
- prov command [167](#)

Q

- quit command [154](#)

R

- RCP printing [109](#)
- reboot command [154](#), [168](#)
- repair procedure [221](#)
 - product repair form [221](#)
 - RMA form [221](#)
- reset
 - button, on legacy units [193](#)
 - procedure for [193](#)
 - procedure for legacy units [193](#)
- resume command [168](#)
- reverse telnet [116](#)
- rlogin command [168](#)
- RMA form [221](#)
- routing dialout [83](#)
- RS422, IOLAN+ variant [173](#)

S

- save command [168](#)
- serial ports, connectors [206](#)
- server configuration menu [155](#)
- set commands [169](#)
- show command [171](#)
- statistics screens [158](#)
- su command [171](#)
- switching on [38](#)

T

- technical support [218](#)
 - centres worldwide [223](#)
 - queries, information needed for [219](#)
 - via the internet [220](#)
 - who to contact [218](#)
- telnet command [171](#)
- terminal
 - communicating with [40](#)
- terminal cables [211](#)
- terminal port configuration [56](#)
- terminals
 - on multi-user systems [54](#)
- test command [172](#)
- trap function [159](#)
- troubleshooting [185](#)

A B C D E F G H I J K L M N O P Q R S T U V W X Y Z

V

- virtual modem [89](#)
 - AT commands [97](#)
 - configuring ports for [91](#)
- vmodem [89](#)
 - AT commands [97](#)
 - configuring ports for [91](#)
 - responses [96](#)

#A B C D E F G H I J K L M N O P Q R S T U V W X Y Z

#A B C D E F G H I J K L M N O P Q R S T U V W X Y Z

#A B C D E F G H I J K L M N O P Q R S T U V W X Y Z